

MARINE BIOLOGICAL LABORATORY.

Received September 30, 1933.....

Accession No. 42591

Given by Dr. Robt. N. Wolcott

Place, University of Nebraska

* * No book or pamphlet is to be removed from the Laboratory without the permission of the Trustees.



McGRAW-HILL PUBLICATIONS IN THE
ZOÖLOGICAL SCIENCES
A. FRANKLIN SHULL, CONSULTING EDITOR

ANIMAL BIOLOGY

**McGRAW-HILL PUBLICATIONS IN THE
ZÖOLOGICAL SCIENCES**

A. FRANKLIN SHULL, CONSULTING EDITOR

- Chapman*—Animal Ecology
- Fernald*—Applied Entomology
- Graham*—Principles of Forest Entomology
- Haupt*—Fundamentals of Biology
- Haupt*—Laboratory Directions for General Biology
- Metcalf and Flint*—Destructive and Useful Insects
- Metcalf and Flint*—Fundamentals of Insect Life
- Mitchell*—General Physiology
- Noble*—The Biology of the Amphibia
- Pearse*—Animal Ecology
- Reed and Young*—Laboratory Studies in Zoology
- Riley and Christenson*—Guide to the Study of Animal Parasites
- Riley and Johannsen*—Medical Entomology
- Rogers*—Textbook of Comparative Physiology
- Rogers*—Laboratory Outlines in Comparative Physiology
- Shull*—Hereditry
- Shull, LaRue and Ruthven*—Principles of Animal Biology
- Shull, LaRue and Ruthven*—Laboratory Directions in Principles of Animal Biology
- Snodgrass*—Anatomy and Physiology of the Honeybee
- Van Cleave*—Invertebrate Zoology
- Wieman*—General Zoölogy
- Wieman*—An Introduction to Vertebrate Embryology
- Wieman and Weichert*—A Laboratory Manual for Vertebrate Embryology
- Wolcott*—Animal Biology

There is also a series of McGraw-Hill Publications in the Agricultural and Botanical Sciences, of which Edmund W. Sinnott is Consulting Editor.

ANIMAL BIOLOGY

BY

ROBERT H. WOLCOTT

Professor of Zoology, University of Nebraska

FIRST EDITION

McGRAW-HILL BOOK COMPANY, Inc.

NEW YORK AND LONDON

1933

COPYRIGHT, 1913, 1919, 1928, 1933, BY THE
MCGRAW-HILL BOOK COMPANY, INC.

PRINTED IN THE UNITED STATES OF AMERICA

*All rights reserved. This book, or
parts thereof, may not be reproduced
in any form without permission of
the publishers.*

THE MAPLE PRESS COMPANY, YORK, PA.

PREFACE

The fundamental propositions behind this text—the platform, so to speak, upon which it has been written—are as follows:

1. Life has a chemico-physical basis.
2. Life phenomena are the outgrowth of organization.
3. The central fact in life is metabolism.
4. Animals may be arranged in a progressive series with reference to organization.
5. The most complex animals are the most effective and also the most efficient from a metabolic standpoint.
6. Man, as the highest of animals, can learn by the study of animal life the principles of the most effective living.
7. He can also understand more fully his place in nature and can more justly judge the actions of his fellows; this in turn may contribute to his intellectual and spiritual development.
8. Every problem concerned with living is essentially a biological problem and capable of analysis and solution by the application of biological principles.

The book has been prepared for use as a class textbook, not as a work of reference, and contains an amount of material which experience has shown can be covered in three recitation periods a week for one year. Since it will generally be used in beginning classes in which the majority of the students are freshmen and sophomores, an effort has been made to present the material in such a manner that it can be easily handled by such students with normal preparation. In other words the idea is to give the student an amount of material which he can cover in a way he can understand. Also since the majority of the individuals in such classes do not intend to specialize in the field of zoology, technicalities have been minimized and emphasis placed upon the broader aspects of the science and the general significance of the data presented, leaving to subsequent courses the filling in of details for students majoring in the subject.

Feeling that the place to acquire a knowledge of the structure of animals is in the laboratory and not in the classroom, the author has reduced the amount of morphological material. In the case of those types handled in both class and laboratory, the facts given here are intended to tie the two together or to summarize the knowledge gained in the laboratory. In the University of Nebraska the "types method"

is followed in the laboratory work and two courses are offered, one carrying a credit of ten semester hours and the other six, and differing in the number of types covered. In the longer course, three recitation periods a week are required; in the shorter, two.

It is suggested that in the selection of material for a shorter course the lightening of the load be done by taking in the classroom only a brief survey of Chaps. XV to XVII, XXV to XXXIX, and XLI to LX, inclusive, picking out sections here and there for the particular attention of the students and letting the rest be merely read for the general impression gained. The numbering of the sections makes possible the assignment of certain ones for more intensive study and of others for consideration in connection with the laboratory work.

In the topics handled in Part V, three aims have been in view: (1) To give a general survey of the field of zoology with a fairly even emphasis upon the various aspects; (2) to review many of the facts presented in previous parts, putting them in a different setting, and developing on the part of the student a broader view and a greater ability to apply these facts; and (3) to establish points of attachment to which advanced courses in the department may be articulated. It is felt by the author that these chapters afford a means for more ready correlation between the general subject and such special courses. Cross references facilitate the development of the habit of thoughtful reviewing and the perception of analogies and homologies, resemblances and differences, that form a part of the basis for true scholarship.

Since correct spelling and exact pronunciation are among the clearest indications of careful training, the pronunciations of phylum and class names are given in the body of the text and the pronunciations of words in the Glossary are given. That the student may be led to observe the derivations of technical terms those of the phylum and class names are given and many common Greek and Latin roots are included in the Glossary. Italics are used in the text to indicate emphasis and also to call the attention of the student to words the definitions of which are to be learned.

In the preparation of the book the author has made free use of other texts and of works of reference, particularly of Parker and Haswell's "Text-book of Zoology," a copy of which should be available to every teacher, and of the volumes of the Cambridge Natural History Series. In connection with illustrations borrowed from other books acknowledgment is made of their sources and of the courtesy of the different publishers in granting permission. Of the figures, seventy-two are from borrowed engravings or were reproduced photographically by F. H. Shoemaker. Two of the original drawings (Figs. 108 and 115) were made by S. Fred Prince. With these exceptions all of the illustrations, either redrawn or original, are from drawings by the author's son, Robert A. Wolcott.

The author desires to acknowledge the help of many colleagues who have generously responded to requests for information and assistance, and, particularly, the advice and suggestions received from those associated with him in the zoological department at the University of Nebraska—D. D. Whitney, I. H. Blake, H. W. Manter, Otis Wade, E. F. Powell, H. E. Low, and G. E. Hudson. In the preparation of the manuscript he has profited by the intelligent cooperation of his assistant, Elmer Palmatier.

THE AUTHOR.

LINCOLN, NEBRASKA,
August, 1933.

CONTENTS

	PAGE
PREFACE	v
 PART I FUNDAMENTAL PRINCIPLES 	
CHAPTER I	
THE FIELD OF ZOOLOGY	3
Appeal of zoology—Number of animals—Variety of animals—Distribution of animals—Relations of animals—Definition of zoology—Divisions of the subject—Scope of general zoology—Animal biology.	
CHAPTER II	
MATTER	7
Definitions—Constitution of matter—Elements and compounds—Acids, bases, and salts—States of matter—Surface films—Mixtures—Ionization—Colloids—Colloidal emulsions—Reactions.	
CHAPTER III	
ENERGY	14
Forms of energy—Chemical energy—Laws of thermodynamics.	
CHAPTER IV	
LIVING AND NONLIVING MATTER	16
Contrast between living and nonliving matter—Tests of life.	
CHAPTER V	
PROTOPLASM	18
Historical facts—Chemical character of protoplasm—Physical characteristics of protoplasm—Microscopical structure of protoplasm—Appropriateness of protoplasm as living substance—Life is a consequence or concomitant of organization.	
CHAPTER VI	
LIFE	24
Definition—Vital force—Vitalism and mechanism—Origin of life—Possibility of creating life.	
CHAPTER VII	
CELLS	28
Definition—Sizes and shapes of cells—Numbers of cells—Structure of cells—General physiology of the cell—Development of knowledge of the cell—Cell theory and cell doctrine.	

CHAPTER VIII

METABOLISM 32
 Definition—Food—Steps in metabolism—Ingestion—Digestion—Absorption—Circulation—Inspiration—Assimilation—Dissimilation—Secretion—Excretion—Expiration—Elimination—Egestion—Respiration—Anabolism and katabolism—Vitamins—Energy changes in metabolism—Uses of different foods—Storage—Metabolism the central fact in life.

CHAPTER IX

PLANTS AND ANIMALS 40
 Comparison between plants and animals—Biology—Differences between plants and animals.

CHAPTER X

GROWTH AND REPRODUCTION 43
 Growth cycles—Limit of size—Reproduction.

CHAPTER XI

MITOSIS 46
 Normal cell division—Significance of mitosis—Amitosis—Continuity of cell life and chromatin—Growth of the cell.

CHAPTER XII

FORMS OF ANIMALS 51
 Asymmetry—Spherical, or universal, symmetry—Radial symmetry—Bilateral symmetry—Metamerism—Appendages—Homology and analogy.

CHAPTER XIII

BEHAVIOR 54
 Stimuli—Direct response—Conductivity—Part played by the nervous system—Physiological state.

CHAPTER XIV

CLASSIFICATION AND NOMENCLATURE 57
 Definition—Arrangement of groups of animals—Nomenclature.

PART II

PROTOZOA

CHAPTER XV

AMEBA 63
 Occurrence and appearance—Structure—Metabolism—Locomotion—Behavior—Reproduction.

CHAPTER XVI

PARAMECIUM 69
 Occurrence—Structure—Metabolism—Locomotion—Behavior—Reproduction—Conjugation—Endomixis.

CHAPTER XVII

PROTOZOA IN GENERAL	78
Classification—Mastigophora—Sarcodina—Sporozoa—Infusoria—General facts—Sexual reproduction in protozoa.	

CHAPTER XVIII

PROTOZOA AND DISEASE	87
Pathogenic protozoa—Malarial parasite.	

PART III

METAZOA IN GENERAL

CHAPTER XIX

METAZOA	93
Differentiation—Division of labor—Somatic and germ cells.	

CHAPTER XX

TISSUES	96
Definition—Epithelia—Supporting and connective tissues—Muscular tissues—Nervous tissues.	

CHAPTER XXI

ORGANS AND SYSTEMS	102
Definitions—Systems—Organs belonging to different systems—Other parts of the body.	

CHAPTER XXII

REPRODUCTION IN THE METAZOA	105
Methods of reproduction in metazoa—Sexual reproduction—Uniparental reproduction—Types of fertilization—Oviparity and viviparity—Metagenesis.	

CHAPTER XXIII

ORIGIN OF THE SEX CELLS	107
Gametogenesis—Spermatogenesis—Oogenesis—Comparison and contrast between spermatogenesis and oogenesis—Division of labor between the germ cells—Variations in gametogenesis.	

CHAPTER XXIV

FERTILIZATION	112
Steps in fertilization—Chromosome reduction—Significance of synapsis.	

CHAPTER XXV

EMBRYOGENY	116
Types of egg cells—Forms of cleavage—Steps in embryogeny—Variations in embryogeny—Germ layers—Coelom.	

PART IV

METAZOAN PHyla

CHAPTER XXVI

SPONGES	127
Relationship of sponges—Classification—Structure—Canal systems—Skele-	

ton—Histology—Metabolism—Behavior—Reproduction—Uses of sponges—Cultivation of sponges—Relations to other animals.

CHAPTER XXVII

HYDRA	134
External features—Internal structure—Nematocysts—Neuromuscular mechanism—Metabolism—Behavior—Reproduction—Symbiosis—Regeneration.	

CHAPTER XXVIII

COELENTERATES IN GENERAL	142
Polyps and Medusae—Classification—Hydrozoa—Scyphozoa—Anthozoa—Color—Polymorphism—Metabolism—Behavior—Reproduction—Metagenesis—Corals—Distribution and economic importance.	

CHAPTER XXIX

PHYLUM CTENOPHORA	154
Structure—Advances in body plan—Activities.	

CHAPTER XXX

FRESH-WATER PLANARIAN	157
Structure—Internal structure—Metabolism—Reproduction—Behavior—Regeneration.	

CHAPTER XXXI

PHYLUM PLATYHELMINTHES	164
Classification—Turbellaria—Trematoda—Cestoda—Metabolism—Reproduction—Occurrence and economic importance.	

CHAPTER XXXII

PARASITISM	170
Structure of parasites—Sheep liver fluke—Life history of the sheep liver fluke—Life history of a tapeworm—Behavior of parasites—Practical aspects.	

CHAPTER XXXIII

PHYLUM NEMATHELMINTHES	175
Structure of an ascaris—Characteristics and advances—Classification—Free-living nematodes—Metabolism—Reproduction—Life history of the pig ascaris—American hookworm—Trichinella—Filaria—Hairworms—Spiny-headed worms—Economic importance.	

CHAPTER XXXIV

OTHER UNSEGMENTED WORMS	183
Phylum Nemertinea—Phylum Chaetognatha—Phylum Rotifera—Phylum Bryozoa—Phylum Brachiopoda.	

CHAPTER XXXV

STARFISH	191
External appearance—Skeleton and musculature—Water-vascular system—Internal organs—Feeding and metabolism—Nervous system and behavior—Reproduction—Regeneration and autotomy—Economic importance.	

CHAPTER XXXVI

PHYLUM ECHINODERMATA	200
Retrogression—Specializations—Classification—Asteroidea—Ophiuroidea— Echinoidea—Holothurioidea—Crinoidea—Reproduction—Behavior—Color —Occurrence and economic importance.	

CHAPTER XXXVII

FRESH-WATER MUSSEL	208
External appearance—Shell—Internal anatomy—Body mass and foot— Mantle—Gills—Digestive system and metabolism—Circulatory system— Excretory system—Musculature—Nervous system—Behavior—Reproduction —Other fresh-water mussels.	

CHAPTER XXXVIII

MOLLUSKS IN GENERAL	217
Classification—Amphineura—Gastropoda—Scaphopoda—Pelecypoda— Cephalopoda—Metabolism—Behavior—Reproduction and regeneration— Economic importance.	

CHAPTER XXXIX

EARTHWORM	229
External characteristics—Internal structure—Alimentary canal and metabo- lism—Circulatory system—Excretory system—Musculature and locomotion —Nervous system—Behavior—Reproductive system and reproduction— Regeneration—Economic importance.	

CHAPTER XL

REFLEX ACTION	238
Nervous functions—Reflex acts—Anterior ganglia.	

CHAPTER XLI

ANNELIDS IN GENERAL	241
Classification—Archannelida—Chaetopoda—Hirudinea—Gephyrea— Metabolism—Behavior—Reproduction—Occurrence and economic impor- tance.	

CHAPTER XLII

CRAYFISH	250
External characteristics—Internal structure—Eyes and vision—Statoecyst— Feeding habits—Behavior—Reproduction—Regeneration and autotomy— Economic importance.	

CHAPTER XLIII

CRUSTACEA	260
Malacostraca—Entomostraca—Behavior—Reproduction—Economic impor- tance—Biogenesis.	

CHAPTER XLIV

ONYCHOPHORA AND MYRIAPODA	268
Onychophora—Myriapoda—Centipedes—Millipedes—Reproduction in myriapods.	

CHAPTER XLV

CLASS INSECTA	271
External characteristics—Internal structures—Senses of insects—Reproduction—Autotomy—Benefits from insects—Injurious types—Combating injurious insects—Beneficial insects—Social insects.	

CHAPTER XLVI

CLASS ARACHNIDA	296
External structure of spiders—Internal structures—Metabolism—Reproduction—Spinning activities—Behavior—Economic importance—Scorpions—Mites—Other arachnids.	

CHAPTER XLVII

ARTHROPODS IN GENERAL	304
Characteristics and advances—Classification—Behavior.	

CHAPTER XLVIII

PHYLUM CHORDATA	306
Characteristics—Advances shown by the chordates—Classification.	

CHAPTER XLIX

LOWER CHORDATES	309
Hemichordata—Urochordata—Cephalochordata—Economic value.	

CHAPTER L

SUBPHYLUM VERTEBRATA	316
Distinguishing characteristics—Body plan—Skin—Skeleton—Muscular system—Digestive system—Respiratory system—Circulatory system—Excretory system—Nervous system—Sense organs—Ear—Eye—Reproductive system—Advances shown by vertebrates—Classification.	

CHAPTER LI

CLASS CYCLOSTOMATA	335
Classification—Myxinoids—Lampreys—Relationship of the cyclostomes—Economic importance.	

CHAPTER LII

CLASS ELASMOBRANCHII	338
Dogfish sharks—Other sharks—Skates and rays—Extinct elasmobranchs—Economic facts.	

CHAPTER LIII

CLASS PISCES	344
Classification—Crossopterygii—Chondrostei—Holostei—Teleostei—Dipnoi—Body form—Scales—Fins—Locomotion—Air bladder—Forms of tails—Colors of fishes—Internal anatomy—Food of fishes—Respiration—Senses of fish—Behavior—Reproduction—Ages of fish—Deep-sea fishes—Remarkable fishes—Economic relations.	

CHAPTER LIV

TERRESTRIAL VERTEBRATES	359
Changes incident to the acquirement of a terrestrial mode of life—Origin of terrestrial adaptations.	

CHAPTER LV

CLASS AMPHIBIA	364
Classification—Urodela—Salientia—Apoda—Food—Color changes in amphibia—Nervous system and sense organs—Behavior—Reproduction and development—Neoteny and pedogenesis—Regeneration—Hibernation —Economic importance.	

CHAPTER LVI

REPTILES AND BIRDS	375
Structural characteristics—Embryonic modifications—Egg—Amnion— Allantois—Body coverings.	

CHAPTER LVII

CLASS REPTILIA	379
Classification—Internal structure—Squamata—Chameleons—Lizards— Snakes—Venomous snakes—Rhychocephalia—Crocodilia—Testudinata— Economic importance.	

CHAPTER LVIII

CLASS AVES	390
External characteristics—Feathers—Internal structure—Classification— Origin of birds and of flight—Flight—The bird as a flying animal—Modifica- tions of birds—Plumage—Songs—Migration of birds—Reproduction— Economic importance.	

CHAPTER LIX

CLASS MAMMALIA	406
External characteristics—Hair—Internal structure—Classification—Origin of mammals—Monotremes—Marsupials—Unguiculata—Primates— Ungulata—Cetacea—Hibernation—Reproduction—Economic importance.	

CHAPTER LX

ANTHROPOID APES AND MAN	422
Manlike apes—Erect position—Evidences in man of former arboreal life— Intermediate forms—Fossil men—Present-day man.	

PART V

GENERAL CONSIDERATIONS

CHAPTER LXI

ANIMAL ORGANISMS	429
The organism—Definition—Income and outgo—Differentiation—Integra- tion—Centralization—Chemical control—Individuality—Life cycle in birds and mammals—Other life cycles—Practical considerations—Organismal concept.	

CHAPTER LXII

STRUCTURE OF ORGANISMS	435
Grades of organization—Germ layers and tissues—Relationship of cells in metazoans—Organs and systems—Tegumentary system—Skeletal system— Digestive system—Glands—Respiratory system—Circulatory system—	

Excretory system—Reproductive system—Muscular system—Nervous system—Convergence and divergence.

CHAPTER LXIII

DEVELOPMENT OF THE ORGANISM	447
Germ cells—Origin of germ cells—Maturation of the germ cells—Egg—Fertilization—Cleavage—Blastula—Gastrulation—Mesoderm formation—Tissue formation and organogeny—Postembryonic development—Potential immortality of germ cells.	

CHAPTER LXIV

ENERGY CHANGES IN ORGANISMS	452
Chemical changes in the body—Organism compared to a fire—Organism compared to an engine—Organism more than a machine—Individuality—Rhythmicity—Uses of foods—Planes of metabolism—Body heat—Heat regulation—Warm-blooded and cold-blooded animals—Temperature of the human body.	

CHAPTER LXV

FUNCTIONS OF ANIMAL ORGANISMS	458
Chemical cycles—Water—Digestion and absorption—Circulation—Respiration—Secretion—Internal secretions—Excretion and elimination—Motor functions—Nervous activities.	

CHAPTER LXVI

BEHAVIOR OF ANIMAL ORGANISMS	469
Memory—Types of animal behavior—Direct response—Simple reflexes—Instincts—Habits—Learning—Intelligence—Reasoning—Combinations of modes of behavior—Behavior of lower and of higher animals—Mind and consciousness.	

CHAPTER LXVII

ANIMAL ORGANISMS IN RELATION TO THEIR ENVIRONMENT	477
Facts of ecology—Relations of animals to plants—Physiological life histories—Habitat—Ecological factors—Reactions of the animal—Communities—Succession—Rhythms—Marine faunas—Fresh-water animals—Terrestrial faunas—Mimicry and protective resemblance.	

CHAPTER LXVIII

ANIMAL ORGANISMS IN HEALTH AND DISEASE	487
Definitions—Health in a protozoan—Comparison of protozoan and metazoan cells—Conditions of health—Causes of disease—Effect of individuality—Self-regulatory tendency in the body—Toxins and antitoxins—How the body fights disease—Immunity—Anaphylaxis and allergy—Maintenance of health in human beings.	

CHAPTER LXIX

RELATIONS BETWEEN ANIMAL ORGANISMS	493
Solitary life—Associations of animals of the same species—Mating—Families—Colonies—Societies—Associations of animals of different species—Gregariousness—Epizoid associations—Commensalism—Mutualism—Symbiosis—Parasitism—Predatism.	

CHAPTER LXX

DISTRIBUTION OF ANIMALS	499
Present distribution—Past distribution—Place of origin—Dispersal of animals—Factors hindering dispersal—Modification of types—Periodic migration—Altitude—Oceanic distribution—Island faunas—Faunal divisions of the earth—North American life zones.	

CHAPTER LXXI

PAST DISTRIBUTION OF ANIMALS	510
Fossils—Stages in fossilization—Geological ages—Geological time scale—Metamorphism—Animals of the past.	

CHAPTER LXXII

EVOLUTION OF ANIMALS	516
History of evolution—Evidences of evolution—Causes of evolution—Methods of evolution—Evolutionary series.	

CHAPTER LXXIII

INHERITANCE IN ORGANISMS	527
Organisms from the genetic viewpoint—Determiners or genes—Behavior of chromosomes in maturation and fertilization—Effect of chromosome reduction—Allelomorphs—Mendel—Mendelism—Hybrids—Distribution of characteristics in hybrids—Checkerboard diagrams—Multiple hybrids—Actual cases—Breeding the test for characters—Variations in inheritance—Breeding for certain characteristics—Inbreeding and crossbreeding—Inheritance of acquired characters—Inheritance of disease and abnormalities—Sex determination—Twins—Determination of sex in parthenogenesis—Sex-linked characters—Linkage and crossing over—Eugenics.	

CHAPTER LXXIV

CLASSIFICATION OF ANIMALS	541
History—Species—Polymorphism—Basis of classification—Basis of nomenclature—Rules of nomenclature—Phyla—Phylogenetic tree.	

CHAPTER LXXV

HISTORY OF ZOOLOGY	549
Greeks—Dark ages—Vesalius—Harvey—Microscopists—Comparative anatomy—Physiology—Cell theory—Embryology—Taxonomy—Evolution and genetics—Pasteur—Recent advances.	

GLOSSARY	557
--------------------	-----

INDEX	587
-----------------	-----

PART I
FUNDAMENTAL PRINCIPLES

CHAPTER I

THE FIELD OF ZOOLOGY

A wealth of animal life about us challenges our attention. Birds travel the highways of the air. Vegetation of all kinds swarms with animals. The surface of the earth is alive with crawling things, and under every object lying on the ground an animal community is hidden. The ground itself teems with life. And not only are fresh waters abundantly populated, but the sea, which has been supposed to mother all life, is occupied by a host of forms, greater in variety than those of any other environment.

1. Appeal of Zoology.—Among this vast assemblage are creatures which appeal to us because of their beauty or oddity of appearance; others to which we are attracted by their remarkable and interesting activities; still others whose varied and complex relationships to one another excite our wonder and suggest a multitude of questions; and, finally, many whose relations to ourselves, either beneficial or injurious, demand our serious consideration.

2. Number of Animals.—The number of individuals which at any given time is living in this world surpasses calculation and is beyond the power of the imagination to conceive. That large number, subject to the modifying influences of changing seasons and affected from time to time by an altering of the balance between animals of different kinds, is constantly maintained. Naturally great differences exist between different regions of the earth's surface, which, in very different degrees, offer the conditions favorable for animal life.

3. Variety of Animals.—The number of kinds of animals is not yet determined and probably never will be precisely known. Those living which have been previously described and named have been estimated at approximately 600,000; and there is no doubt that if all still unknown were added, the total would far exceed a million. The exact number, however, is subject to constant change, since some kinds of animals are continually becoming extinct and new ones are as continually being developed. This enumeration also takes no account of the millions of species which have lived in the past and have perished, some without leaving any trace, others represented more or less completely by fossils. Then, too, opinions differ greatly as to what constitutes the difference between two kinds or, in other words, what constitutes a species. The words type and form are frequently used in the same sense as species, or kind.

4. Distribution of Animals.—Animals are found everywhere on the earth's surface, except perhaps on the glaciated tops of the highest mountains and at the poles. On these mountains creeping and flying forms pass the margins of the snow fields, and the areas of ice and snow at the poles are constantly invaded by such forms as are able to venture into them. Animal life is found throughout the waters of the sea and even penetrates to the deepest parts of the oceans. Animals burrow below the surface of the ground to considerable depths and also follow fissures still deeper to reach the farthest recesses of the most extensive caverns. Finally, myriads of living creatures live within the bodies of other living things, both plant and animal.

5. Relations of Animals.—Animals are related in various ways to other animals, to plants, and to their physical environment. Between parents and offspring the relation is that of descent. Between other animals the relation may be nutritive, one living upon the other; reproductive, where two join in the production of young; locomotor, where one attaches itself to another for the purpose of being transported from one place to another; or any one of many other relations which might also be named. Plants serve as food for animals, afford them concealment, and are useful to them in other ways. A solitary existence, in which one animal lives without any relationship to any other, is possible but rarely occurs in nature. Animals possessing sex associate together for a longer or shorter time as mates. Many of the same kind live together, forming a colony or, as in the case of ants, bees, and wasps, are organized into a society. The relations of animals to their physical environments are manifold. Some are confined to the land, others to the water, and still others may be at home in both. Aquatic forms may be restricted to fresh waters, others may be only marine, while there are also those that pass from one to the other environment. Animals exist that spend all of their lives in the soil, and others that enjoy the power of flight pass much of their active existence in the air.

6. Definition of Zoology.—A study of animals from every aspect constitutes the science of *zoology*. This broad field is capable of being divided into many of less extent depending on the various aspects from which animals may be viewed, whether considered in whole or in part, as to structure or function, in relation to the inorganic environment or to other animals and the plants about them, or from the standpoint of the principles and laws which underlie and determine the phenomena exhibited by animal life.

7. Divisions of the Subject.—Zoology may be divided, in accordance with the manner in which animals are studied, into two great sub-sciences; these are *morphology*, which deals with animals as to form and structure, and *physiology*, which deals with them as to their functions.

Under the head of morphology are included *anatomy*, which is concerned with structure as made out by dissection; *histology*, which treats of structure as determined by the microscope; *taxonomy*, which is the study of the laws and principles of classification and which is based upon structure; geographical distribution, or *zoogeography*, the study of the geographic distribution of animals; and *paleozoology*, which deals with the fossil remains of animals. The reason for the placing of zoogeography under morphology is that in this field animals are treated as species or groups, a morphological basis.

Physiology includes *physiology* in the narrow sense, which deals with the functions of the different parts of which the body is composed; *ecology*, which deals with the functional relations of animals to their environment; *psychology*, which is the study of the mental life of animals; and *sociology*, which is the study of animal societies.

Three other fields belong to both morphology and physiology—*embryology*, which deals with the development of animals; *pathology*, which relates to the diseases that affect them; and *parasitology*, which is concerned with animals that live at the expense of their fellows. No effort has been made up to the present time, however, to separate the structural and the functional aspects in any of these three fields.

Not only may zoology be divided into the two broad subsciences first named and their various divisions, based upon the manner of approach and method of investigation, but it also may be separated into many restricted sciences, each of which deals with a particular group. Among these are *protozoology*, which deals with the lowest, one-celled animals; *helminthology*, which is concerned with the worms; *entomology*, which is the study of insects; *conchology*, the study of mollusks; *ichthyology*, the study of fishes; *herpetology*, the study of reptiles and amphibians; *ornithology*, the study of birds; and *mammalogy*, the study of mammals. Many other sciences, which concern less extensive groups and are less familiar, might be added to this list, but only one need be spoken of and that is *anthropology*, which is the study of man as to his physical nature.

Other divisions of zoology are *evolution*, which seeks to explain the origin and modification of the different species, and *genetics*, which deals with the laws that underlie inheritance.

It is evident from what has been said that the divisions of the subject cross one another. Anatomy, taxonomy, geographical distribution, ecology, and all of the other fields mentioned as differing in the point of approach or method will, for example, deal more or less with birds. Ornithology, on the other hand, may be considered from a morphological, physiological, taxonomic, distributional, or ecological aspect. The same is true of any other group of animals.

In addition to the fields which have been mentioned, a long list of practical applications might be added which would greatly increase

the list of the divisions of zoology. Among such applications are *animal husbandry*, which deals with the cultivation of the domesticated higher animals, *apiculture*, with that of bees, and *aquiculture*, with that of fish and other aquatic forms; *medicine*, which is concerned with disease and the methods used in its treatment; and *hygiene*, which presents the principles involved in the maintenance of health. All of these involve the study of animal life and should really be included in zoology in its widest extent.

8. Scope of General Zoology.—Within the scope of a beginning course in zoology, it is impossible to handle more than the most general principles of the subject and the broader phenomena of animal life. None of the fields enumerated above can be more than barely introduced to the student; their further cultivation must be left for special courses.

9. Animal Biology.—To many persons the word zoology is associated with the structure and classification of animals, while the word biology conveys the implication of life and activity. This is an unwarranted connotation; but because in this text the emphasis is on the latter aspect of the subject rather than on the former, it has been entitled “Animal Biology.” Properly speaking, the term *biology* is applied to the combined sciences of botany and zoology.

CHAPTER II

MATTER

Proficiency in all of the different divisions of zoology cannot be attained without considerable knowledge of physics and chemistry, though the different fields differ greatly in the demands they make upon such knowledge. An adequate grasp of even the most general and most fundamental zoological principles, however, requires a familiarity with the broad conceptions which underlie those sciences; and since many approach this subject lacking such acquaintance, it is necessary to review briefly these conceptions. Logically, the first subject to be considered is the nature of living matter. To understand this it becomes necessary to define what is meant by matter in general and to state some facts in regard to it.

10. Definitions.—For our purpose *matter* may be defined as all in this universe, of the *existence* of which we may be made aware through our senses, either directly, or indirectly by means of any kind of apparatus. This will include all that is revealed by the microscope, telescope, spectroscope, or any other type of instrument. We commonly refer to all of our experiences as either material or spiritual. Those which are material presume the existence of matter; those which we term spiritual have no essential relation to it.

11. Constitution of Matter.—Matter differs in kind, exists in various forms, and exhibits a great variety of phenomena. The study of matter with respect to kind is in the field of chemistry; that of matter without regard to kind, including the phenomena of matter in general, belongs to physics.

Most matter with which we are familiar does not consist simply of one kind of matter but is of the nature of a *compound*, consisting of two or more different kinds. A piece of any ordinary compound substance, as, for instance, a piece of chalk, is termed a *mass* and may by being broken into two parts be divided into two masses. These may be again broken, and the process may be continued, resulting in masses of smaller and smaller size, each still remaining chalk. This division may be carried beyond the limit of visibility by the unaided eye and even far beyond that by the microscope. The masses become smaller and smaller but each bit remains a mass. Finally a fragment may be conceived that can no longer be broken and the portions be alike. This smallest particle of any compound substance is termed a *molecule*. When molecules are

separated into smaller fragments these are unlike and are definite in number for every substance. These fragments are termed *atoms*. A molecule of chalk is divisible into five atoms—one of carbon, one of calcium, and three of oxygen. It has been found that an atom may be further subdivided into much smaller particles, one or more of which lie at the center and are termed *protons*, while the others, either associated with the protons in a nucleus or distributed at distances about it, are known as *electrons*. When, however, atoms are divided into these finer particles, they are found to be all of the same nature, and so all matter in this finely divided state becomes alike. Atoms of different kinds differ only in the arrangement of these component particles with respect to each other.

12. Elements and Compounds.—This division of matter into molecules, atoms, protons, and electrons belongs to physics. Chemistry, strictly speaking, deals only with atoms classified according to their kind and with molecules considered with respect to the kind and arrangement of the atoms of which they are composed. Each kind of atom is known as an *element*. Compounds are classified with respect to their composition in terms of elements and also with respect to the manner in which they react, or change, when brought in contact with other compounds or with elements. Chemists now recognize about 90 different elements, some of the most common of which are carbon, hydrogen, oxygen, nitrogen, iron, calcium, phosphorus, sodium, and potassium. To economize time and space in referring to these elements they are designated by symbols, which may be the initial letter of the name of the element, either in its English or in its Latin form, or two letters when it is necessary to distinguish between elements having the same initial. Thus, C represents carbon; Ca, calcium; H, hydrogen; N, nitrogen; and Fe (from the Latin *ferrum*), iron.

13. Acids, Bases, and Salts.—The elements are divided into two categories. *Metals*, which number more than three-fourths of the total, include gold (Au), silver (Ag), lead (Pb), copper (Cu), and iron (Fe), and also calcium (Ca), magnesium (Mg), potassium (K), and sodium (Na). The *nonmetals* include oxygen (O), nitrogen (N), carbon (C), sulphur (S), silicon (Si), phosphorus (P), chlorine (Cl), and iodine (I). Hydrogen (H) is not a metal but in chemical combinations acts like one. Metals combine with oxygen to form *bases* which, in solution in water, color litmus more or less strongly blue—that is, they are alkaline. Nonmetals, when combined with oxygen, yield *acids* which, in aqueous solutions, are sour to the taste and color litmus red. All acids contain hydrogen. A substance resulting from the union of a base and an acid is called a *salt*. Examples are table salt, or sodium chloride (NaCl); lime, or calcium carbonate (CaCO₃); and blue vitriol, or copper sulphate (CuSO₄). In all chemical combinations the number of atoms of each element in a

molecule of the compound is indicated by a figure written as a subscript.

14. States of Matter.—All molecules, and also smaller particles, are believed to be in continual motion, but this motion is restrained by the attraction which molecules or other particles exert upon each other. This attraction is proportional to the sizes of the particles and inversely proportional to the squares of the distances between them. Thus it follows that particles at a great distance exert an attraction which is practically negligible, but as they approach each other the attraction increases at a constantly accelerated rate.

The relation between the molecules in a mass determines the character of the mass which they form, and thus we get the different states of matter. If the molecules are sufficiently close together that the attraction between them holds them in the same relative position with respect to each other, the mass preserves constantly the same form and is termed a *solid*. If, however, the attraction is insufficient to preserve this form and the mass tends to change its shape, it is called a *fluid*. If the molecules of a fluid tend to remain together but there is so nearly a balance between the force of motion and the force of attraction that the mass easily changes shape, it is called a *liquid*. Under the influence of gravity the molecules in a liquid seek the lowest level and the upper surface of the mass becomes a plane surface. Finally, if the molecules of a fluid are so far apart that the attraction of one for another fails to keep them together and they tend to move in all directions, the mass expands and fills all available space and is termed a *gas*. Thus both liquids and gases are included under the term fluid. Some gases are heavy and expand, or diffuse, slowly; others are light and diffuse rapidly.

Since there may be any degree of attraction, depending upon the sizes of molecules and the distances between them, these states of matter are not sharply defined but pass into one another through an indefinite number of gradations. A mass which is not a perfect solid but which may be made to change its shape gradually is termed *viscous*. Under the influence of varying degrees of heat and pressure, substances may be made to assume any desired degree of viscosity or to pass from one state to another. Tar may be heated until it flows readily, and a syrup cooled until it hardly flows at all. Under the influence of heat, liquids may be made to change to gases; and under the influence of increased pressure, gases may be liquefied. Under ordinary conditions, some liquids readily evaporate and change into gases, while some solids seem to pass directly into the gaseous state without appearing at any time as liquids. In a dry climate, snow may evaporate without wetting the surface on which it lies. It might be argued that a substance must pass through the liquid state in passing from the solid to the gaseous but there is difficulty in proving this.

15. Surface Films.—In a liquid mass, as has just been said, the particles are free to move; but if the mass is at rest, they do not do so, being equally attracted by other particles all about them and in a state of balance. This being true they are easily pushed aside by an object which passes through the liquid. The surface of the mass, however, is formed of a layer of molecules which are not in balance but which attract one another and are attracted to those below them to a degree which makes the penetration of this layer a matter of overcoming a certain amount of resistance (Fig. 1). This layer of molecules is called a *surface film*.

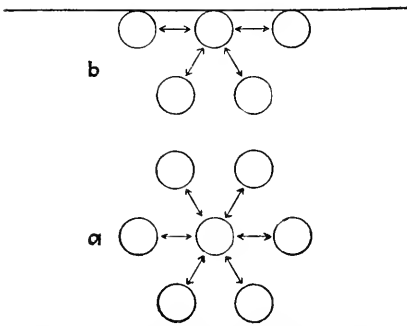

FIG. 1.—Diagram illustrating the balanced attraction exerted upon a molecule in a mass of liquid (*a*), and the unbalanced attraction upon a molecule at the surface (*b*). The two-pointed arrows (\leftrightarrow) indicate mutual attraction between two molecules.

It is the presence of this film and the resistance it offers to penetration which makes it possible, with sufficient care, to lay a dry needle upon the surface of a liquid and for it to remain there. The resistance which this film offers to the penetration of any object is also responsible for the dimpling of such a surface when a dry object is pressed down upon it. If the object is pressed with a constantly increasing force the dimple becomes gradually deeper until finally, when the force becomes sufficient to rupture the film, the object enters the liquid and is wet by it.

Then the liquid, as a result of adhesion between the particles of the object and those of the liquid, rises on the surface of the object in a characteristic way which is familiar to everyone—that is, unless the liquid is a very heavy one, like mercury, in which case the surface film does not rise but is depressed next to the surface of the object, to which, in other words, the liquid does not adhere. Some animals, like the water striders, move freely about on water supported by the surface film, while others, like snails, cling to this film from below and move about hanging to it. The surface film thus serves as a highway which may be traveled on both its upper and its under surfaces. The strength of the surface film of a thick liquid causes a drop of it to stand up on a dry surface and assume the form of a flattened sphere, whereas the weakness of that of a thin liquid results in its spreading out over a considerable area in a thin sheet.

16. Mixtures.—Masses of different kinds may be associated in what may be termed, in general, mixtures. Two solids reduced to a state of fine division may be mixed; liquids also may be mixed, and gases as well; and any two of the three, or all three, may be mixed.

If a solid is mixed with a liquid and remains in masses of greater size than molecules, the liquid is more or less turbid and the mixture is termed

a *suspension*. If, however, the solid is reduced to particles of the size of molecules or of atoms, the mixture will become as clear as the liquid itself and such a mixture is termed a *solution*. The liquid is called the *solvent* and the dissolved solid the *solute*. In the same way one liquid may be mixed with another liquid and form a suspension or a solution, depending on the size of the particles. A suspension of one liquid in another is termed an *emulsion*. Gases, too, go into solution and also form suspensions, but such suspensions do not persist. A gas and a liquid may be shaken up together and a suspension created, the gas being distributed through the liquid in the form of bubbles, but the gas quickly escapes from the mixture except for what becomes dissolved. Gases also escape from solution unless there is just as much gas over the liquid as there is in an equal volume within it. This passage of gas either into solution or out of it, depending on whether the gas pressure is greater without or within, explains why animals take in oxygen and pass out carbon dioxide. This exchange, which is called respiration, takes place through extremely thin membranes which separate the air from the liquids in the body and which allow the gases to pass through freely. Differences in gas pressure also account for the constant entrance of oxygen into water to replace what aquatic animals have taken from it in respiration, and the constant escape into the water and then into the air of the carbon dioxide which they have produced.

17. Ionization.—Whenever acids, bases, or salts go into solution in water, there is a tendency for the molecules to separate into the component atoms or into radicals, which are groups of atoms. The atoms or radicals then exist free in the solution. These solutions conduct electricity and are known as *electrolytes*. Free atoms or radicals in such a solution are found to carry minute electrical charges and are called *ions*. Those ions which are metallic in nature carry positive charges, and those which are nonmetallic carry negative charges; they are termed, therefore, positive or negative ions. Table salt (NaCl) in solution separates into sodium (Na) and chlorine (Cl) ions; sodium sulphate (Na_2SO_4), into Na and SO_4 ions, SO_4 being a radical. Na is a positive ion; Cl and SO_4 are negative. When, by evaporation of the solution or by precipitation, the substance which is in solution is made to reappear again in solid form, the ions combine, and the charges neutralize one another and disappear. This separation of ions in solution is known as *electrolysis*, or *dissociation*; different substances show great differences in the degree to which this occurs. Sugar and other substances which are non-conductors do not show much dissociation. Acids by dissociation produce H ions; bases, OH ions.

18. Colloids.—Many thin membranes occur in the bodies of animals in which openings exist of very minute size; similar membranes can be artificially produced. Whenever two different liquids are in contact

with the two sides of such a membrane, the liquids tend to mingle by the passage of molecules or atoms through the openings. When one or both of these two liquids contain solids, other liquids, or gases in solution, the particles of these substances also may pass through the same openings. By the use of these membranes we can distinguish two categories of substances. Those substances which when they are in solution are capable of passing through such a membrane are said to be crystalloidal and if they normally exhibit this character are often called *crystalloids*, while those which will not pass through are termed colloidal and called *colloids*. But many crystalloids may be made to assume a colloidal condition. Of course it is a matter of relative size of particles and openings, but in general it is true that crystalloids are substances which exist in molecules of very small size or as atoms in a solution, while colloids are substances which exist as particles of larger size, are dispersed in liquids in the form of suspensions, and do not form true solutions. These colloidal suspensions are thicker or more like glue than are crystalloidal solutions. From crystalloidal solutions the substances are easily obtained in crystalline form, but this is not true of colloidal suspensions. Oils and fats and proteins, such as the albumen which forms the white of eggs, are colloidal. This separation of colloidal from crystalloidal substances is known as *dialysis* and the membranes which effect the separation, as dialyzing membranes, or *dialyzers*.

Other membranes are found in the body which under similar conditions permit some liquids or gases to pass through them and prevent others from so doing, but the passage takes place as a result of solution in the membrane and not through openings in it. Such a membrane is termed a *semipermeable membrane*. This process is known as *osmosis*. In this case the force behind the movement is called *osmotic pressure*. Osmotic pressure is subject to the same laws as is the pressure of a gas on the walls of the container in which it is and against which it exerts pressure because of its tendency to expand.

Whenever two liquids of different densities are in contact and do not mix, the plane of separation, which is in effect a surface film, acts like a semipermeable membrane; some substances will pass through it, others will not.

19. Colloidal Emulsions.—In case the suspended droplets in an emulsion are colloidal, the mixture is termed a *colloidal emulsion*. The liquid in suspension is dispersed and is called the *disperse phase*, while the other liquid is called the *dispersion medium*, or the *continuous phase*.

A colloidal emulsion is more or less jelly-like. It may at one time become thinner and assume the condition of a *sol* or at another time become thicker and assume the condition of a *gel*. This may be due to the transfer of liquid from the disperse phase into the dispersion medium, or *vice versa*, without the addition of more liquid from without. The

two phases, in other words, tend to change places, one being at one time dispersed in the other, at another time the other in the one. When the colloidal droplets are scattered in the watery dispersion medium, it is a thin jelly; but when they swell, press upon each other, and the dispersion medium is restricted to the crevices between them, the whole becomes thick and tends to set or become firm (Fig. 2). The ability to change from one state to another and back again, over and over, causes a colloidal emulsion to be called *reversible*. A gelatin suspension in water forms such an emulsion.

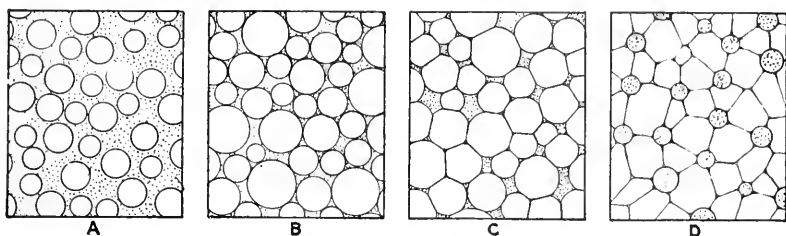

FIG. 2.—Diagrams to illustrate the change of a colloidal emulsion from sol to gel. In *A* the droplets of the disperse phase (not stippled) are shown scattered through the dispersion medium (stippled) and the emulsion is a sol; in *B* the droplets are shown taking up liquid and swelling; in *C* this is continued until they press upon one another; in *D* the droplets are so crowded as to become continuous and to have become in fact the dispersion medium, while that which was the dispersion medium is now in droplets and has become the disperse phase. The emulsion has become a gel.

20. Reactions.—Whenever two substances are brought together and a change occurs which involves a recombination of the atoms in a manner different from that which previously existed, this change is termed a *reaction*. Reactions vary in speed and in the results attendant upon them with the character of the substances reacting. Some substances have the power to cause a reaction without themselves entering into it or being affected by it. Such substances are known as *catalyzers*, *catalytic agents*, *ferments*, or *enzymes*; the effect is called *catalysis*, *ferment action*, or *fermentation*. A small amount of a digestive ferment is capable, if given time, of causing the digestion of any amount of the substance on which it acts and would itself be found undiminished in quantity and unchanged in character at the end of that time. Each ferment acts on a particular substance or on similar substances and is most active at a certain temperature or in a medium of a certain degree of acidity or alkalinity.

CHAPTER III

ENERGY

Energy is usually defined in physics as the capacity to do work. It may be more simply expressed as that which is behind all action in this universe. Every change in the state of matter, in the form or position of a mass of matter, or in the chemical composition of matter involves a change in energy.

21. Forms of Energy.—Energy appears in two forms: potential, or fixed; and kinetic, or free. *Potential energy* is energy of position. Every particle of matter in this world possesses an amount of potential energy varying with its size and with its distance from the center of gravity of the earth. Gravitational attraction, if all restraint were removed, would cause it to fall to that center; in measure as it approached the center its potential energy would be changed to kinetic, and if it could be conceived as having arrived at that center it would possess no potential energy at all with respect to this terrestrial system. However, it would still have potential energy as a part of a larger system, the solar system, of which this terrestrial system is a part. It would also have potential energy as a part of the largest system, which is the universe. A molecule is an energy system, as is also an atom. In the free movement of a bit of matter its potential energy is changed into *kinetic energy*, or energy of motion. Any mass possesses potential energy because of the relation of its particles to one another. Energy of motion is manifested not only when masses change position but also when changes occur within them. It is also manifested when the atoms or molecules of which matter is composed cause by their movement certain characteristic phenomena such as heat, light, and the passage of an electric current. These are all forms of kinetic energy.

22. Chemical Energy.—In many cases, when elements are made to combine to form a compound, the application of kinetic energy is necessary to bring them into the proper relationship to each other. Part of this energy, at least, is represented by the potential energy which these particles possess by virtue of this relation. This form of potential energy is known as the energy of chemical union or simply as *chemical energy*. Every substance has an amount of chemical energy proportionate to the complexity of its structure—that is, to the number and variety of atoms which make it up. A very simple substance has a small amount of such energy; a very complex one may have a great deal. In general,

inorganic compounds have relatively small amounts of chemical energy, while organic compounds, on the other hand, usually have large amounts. When a compound is resolved into its component atoms, the chemical energy reappears as kinetic energy. This is the source of the charges carried by the ions in an ionized solution. Because of their greater complexity, a greater amount of kinetic energy can be produced in an animal body by the disintegration of organic compounds than by that of inorganic compounds. This kinetic energy may appear in various forms, as movement, light, heat, and electricity.

23. Laws of Thermodynamics.—Thermodynamics is a part of physics which deals with energy transformations. Two laws have long been considered fundamental in this field: One is that of the *conservation of energy*, which states that the sum total of energy in this universe is the same at all times, being neither created nor destroyed but simply changed from one form to another. The other is the law of *entropy*, which states that energy tends to accumulate in potential form, or, in simpler language, that everything tends to run down. Associated with these is the law of *conservation of mass*, which states that matter in this universe is neither created nor destroyed but is simply transferred from one place to another or changed in character.

CHAPTER IV

LIVING AND NONLIVING MATTER

Living matter or matter which has been arranged under the influence of life is termed *organic*; other matter is *inorganic*. Any living thing may be called an *organism*. No element is found in living matter which is not found also in nonliving, but only a small part of those which are found in nonliving matter occur in living. As will be seen later, no more than about a dozen of the 92 elements known can be looked upon as normal constituents of living matter. Moreover, so far as is known, no forces operate in living matter differing from those operating in nonliving matter, but all of the phenomena of living matter involving energy may be explained in terms of the same physical forces which operate in all inorganic matter throughout the universe.

24. Contrast between Living and Nonliving Matter.—Many points of contrast have been enumerated between living and nonliving matter, some of which are more significant and others less so. None of them is capable of being applied in every case successfully and in such a manner as to yield an immediate result. It is frequently stated that both definiteness of size and definiteness of form distinguish living things, but this distinction is only a very general one. Some crystals conform very closely to a certain size and approach with great mathematical exactness a typical form, but, generally speaking, masses of inorganic matter vary much more in size and shape than do masses of living matter. Conformity to type form is one of the most effective means of distinguishing the species of living organisms. The more important contrasts between the two kinds of matter are the following:

1. *Chemical Composition.*—Living matter, while varying in its precise chemical structure, approaches very closely, both in the number of elements contained and in the proportions between them, a certain definite composition. So close is this agreement that living matter is recognized as made up of a particular substance to which is given the name *protoplasm*. This does not occur in nonliving matter.

2. *Organization.*—Protoplasm possesses an internal organization, evidenced not only by its appearance under the microscope but also by certain chemical relationships, the presence of which is necessary in order that it may carry on the phenomena and exhibit the reactions which are associated with life.

3. *Metabolism and Growth.*—Protoplasm also possesses the power of waste and repair and of growth. The carrying on of life activities

involves the breaking down of living matter with the formation of wastes, such as urea, water, and carbon dioxide, and the liberation of kinetic energy, mainly evident as heat and movement. Living matter possesses the power to rid itself of this waste and also to take in new matter and, by adding it to its mass, to repair the loss which it has suffered. All these changes together constitute *metabolism*. If the material taken in and added to the mass is greater than the amount lost by waste, the result is an increase in the size of the living mass which is called *growth*. At the same time, mere increase in bulk does not necessarily imply growth. The taking up of water and the swelling that living matter undergoes under certain conditions is not growth. This word is properly applied only when new matter is added to the substance of protoplasm itself. This addition occurs in living matter in a manner different from that in which it occurs in inorganic. The latter usually increases in bulk by additions to the surface, or growth is by *accretion*; while in the former growth occurs by the introduction of new particles among those already present, which is growth by *intussusception*.

4. *Reproduction*.—Living things have the power to reproduce themselves by the formation of other masses similar in every respect to the parent mass. Sometimes this similarity is perfect from the first. At other times a fragment from the parent mass gradually assumes the size and form of the parent. Nonliving things do not possess this power.

5. *Irritability*.—Living things, generally speaking, have the power of responding to changes in their environment, such changes acting as stimuli. This quality is termed *irritability*, or *reactiveness*. The response evidences itself in the movements of animals and results in the various ways in which animals adjust themselves to the conditions of their existence. The organism is not itself modified in any essential respect by the reaction and may, under proper conditions, reassume precisely the character it possessed before the reaction occurred. Nonliving things may also be affected by changes in the environment, but the modification is not in the nature of adjustment, is destructive in its effect, and the thing cannot of itself regain its former character.

25. *Tests of Life*.—Living matter, however, is not always to be recognized by any characteristics which it possesses. A living seed may appear as inert as any bit of inorganic matter, and some animals may exist dried up and apparently without any of the attributes which belong ordinarily to living things. The test which may be applied in such cases to determine whether or not life is present, or is possible, is to place the object under such conditions of warmth and moisture as experience has shown tend to develop life activities and observe if under these conditions the distinctive phenomena of life are manifested. If they are, the inference is that the object was alive or that the drying up occurred in such a way as not to destroy the organization that is behind all life phenomena.

CHAPTER V

PROTOPLASM

Protoplasm is invariably associated with life, and so far as is now known life can exist in no other substance. When protoplasm ceases to be living, it quickly undergoes destructive chemical changes which reduce it to other and simpler compounds.

26. Historical Facts.—Protoplasm was first determined to be a particular substance, with characters of its own, in 1835, when it was described as existing in animals, by a Frenchman, Dujardin, who called it *sarcode*. The protoplasm of plants was first described in 1846 by a German, Von Mohl, who attached to it the name of *protoplasm*. This name had been used six years before by Purkinje but in a very restricted sense. That sarcode and protoplasm were one and the same substance was most thoroughly demonstrated by Max Schultze in 1861, and to this living substance, common to both plants and animals, is now applied the name given by Von Mohl.

27. Chemical Character of Protoplasm.—Protoplasm eludes exact chemical analysis. The chemical composition of an animal body may be determined, but this includes the skeleton, stored food, and other materials which are nonliving. To secure a mass of perfectly pure protoplasm is difficult, and the exact analysis impossible. Nevertheless, certain general statements can be safely made.

1. It is almost entirely composed of 12 *elements*, including the following:

Element	Symbol	Approximate percentage
Oxygen.....	O	65
Carbon.....	C	20
Hydrogen.....	H	10
Nitrogen.....	N	3
Sulphur.....	S	
Iron.....	Fe	
Calcium.....	Ca	
Magnesium.....	Mg	
Sodium.....	Na	2
Potassium.....	K	
Phosphorus.....	P	
Chlorine.....	Cl	

There are very minute quantities of several other elements in the bodies of higher animals, including fluorine in the enamel of the teeth and also silicon and iodine, but these are found only in certain tissues and are not considered normal constituents of protoplasm. Minute amounts of copper, manganese, zinc, and bromine have been found in marine invertebrates. The first five elements named in the table above are always present and a certain number of the last group are also, but some of them may be lacking.

Though some elements are present in small amount, this small amount is none the less vital to the performance of the functions of living matter. Certain of these elements are especially abundant in particular forms of protoplasm, such as iron in the protoplasm of red blood corpuscles and phosphorus in the protoplasm of the nerve and reproductive cells.

2. These elements are in combination in a variety of *compounds* which may be classified as follows:

Organic Compounds	Inorganic Compounds
Proteins	Salts
Fats	Water
Carbohydrates	

Proteins are, so to speak, foundation substances; about them is built up the complex aggregate called protoplasm. They contain four elements—carbon, oxygen, hydrogen, and nitrogen—together with sulphur and in some cases phosphorus, and have certain peculiar properties. They are colloidal and have a tendency to coagulate on heating. The protein molecule is very large and is built up of many amino acids, which are acids containing the amino group NH_2 . The number of different proteins in different forms of protoplasm is very great; different species of animals have different types of protein, and particular tissues in one animal contain proteins which are not found in the other tissues of the same animal.

Fats are also colloids and consist of carbon, hydrogen, and oxygen, the oxygen being very small in amount as compared with the carbon and hydrogen. This fact makes them susceptible of a great amount of oxidation, with the consequent production of a large amount of heat. There are three different types of fats: (1) true fats, which include compounds of glycerin and fatty acids, mostly oleic, palmitic, and stearic; (2) lipoids, including the phosphorus-containing fats, an example of which is lecithin, and the sugar-containing fats, or cerebrosides, found in nervous tissue; and (3) sterols, including cholesterol, which seems to occur in every animal cell.

Carbohydrates, which include sugars and starches, may also be in a colloidal condition, although neither they nor fats show any tendency to coagulate with heat. They also consist of carbon, hydrogen, and oxygen, but there is relatively a much greater amount of oxygen than

in fats, the proportion of hydrogen and oxygen being the same as in water, or two to one. Only two kinds can be shown to exist as such in the tissues of the body, dextrose and glycogen.

The *water* present in protoplasm maintains many substances in solution. Water, however, is important as a constituent of protoplasm, not only as a very effective solvent but also because of its high specific heat, because of its comparatively high surface tension, and because of the fact that its presence gives to protoplasm the necessary consistency and enables it to vary this consistency. The high specific heat of water makes necessary the application of a large amount of heat to raise its temperature and allows it to give off a correspondingly large amount of heat in cooling, thus enabling it to exert a protective effect against sudden and extreme temperature changes in the living body.

Salts are present in considerable number and are to a large degree ionized, though the degree varies with different salts. They aid in the maintenance of certain other substances in solution and take part in some of the reactions which are characteristic of living matter. Some of these salts are the chlorides, phosphates, and carbonates.

3. The substances enumerated above are associated together in a chemical aggregate which contains several thousands of atoms. Thus protoplasm is not so simple as other familiar substances but represents a complex of substances all associated together in a certain definite fashion.

This definite arrangement of substances in protoplasm may be termed its *chemical organization* and is one of the most striking of its characters. What this organization means may be illustrated in the following way: One might go to a jewelry store and ask the jeweler to give him every part which enters into the formation of a watch. The jeweler could heap in his hand the necessary number and kind of wheels, screws, pinions, and jewels as well as the hands, dial, case, and so on, so that within his hand he would hold everything necessary to make a complete watch. He would not, however, have a watch. This assemblage of parts does not become a watch capable of performing the service expected of it until these parts have all been arranged in a certain very definite relation of one to the other. So it is with the chemical substances which make up protoplasm. Without the necessary organization the assemblage of parts named above is not a watch, and in the absence of the chemical organization which is a property of protoplasm that substance cannot be said to exist. This organization is made possible by the fact that protoplasm is a colloidal emulsion and the various constituents may be distributed among the droplets of the disperse phase and through the continuous phase.

4. Protoplasm is very *unstable*. It alters in composition in response to every change in the environment about it and when active remains for no two consecutive moments the same.

5. Protoplasm is also exceedingly *variable*. There is a difference chemically between the protoplasm of one species of animal or plant and that of another. Moreover, there is also a difference between the forms of protoplasm contained in the various structures found in the body of each animal and plant. With all the individuality that exists in living things it is conceivable that no two bits of living matter are ever precisely alike. This characteristic is back of all the adjustments of living matter to its environment.

6. Protoplasm also undergoes an orderly sequence of chemical reactions which we call *metabolism*, and as long as life is being manifested the cycle of such reactions is being repeated over and over.

28. Physical Characteristics of Protoplasm.—Protoplasm has the following physical characteristics:

1. It is viscid and gelatinous in *consistency*, differing in viscosity in various forms of life, in the various structures of the body, and under various conditions.

2. Its *texture*, generally speaking, is more or less granular.

3. It is *colorless* in pure form. All colors which it seems to possess are due to the presence of colored bodies within the living substance.

4. It is more or less *translucent*, being never perfectly transparent, and this translucency gives to it in mass a grayish appearance.

5. It is of the nature of an *emulsoid*, or *colloidal emulsion*, the various substances of which it is composed being distributed through the dispersion medium and in the droplets of the disperse phase. Being colloidal in character and being reversible, it is possible for water and substances in solution to enter protoplasm from without, causing it to become more fluid, or to pass out from it, resulting in its becoming firmer in consistency. To the same fact and to the fact that the internal surface films in such an emulsion may act like semipermeable membranes is due the possibility of water and substances in solution passing in both directions through the walls of the droplets, causing them to swell or to shrink. As they swell and crowd together the whole tends to become a gel, and as they shrink and move with greater ease in the more fluid dispersion medium it tends to become a sol. This transfer of water may be the consequence of chemical changes taking place in either the substance of one phase or that of the other.

This ability of protoplasm to change from sol to gel and back to sol over and over again is behind many vital activities, including all movement. The entrance of water and substances in solution into the mass at certain times and the giving up of water and other substances in solution at other times make possible the taking in of food and the giving out of waste. The passage of materials through the internal films, which are the walls of the droplets of the disperse phase, possibly plays a part in

the orderly sequence of reactions which takes place in living matter and makes possible growth by intussusception.

6. The salts in protoplasm are to a very great degree ionized, and the state of *ionization* contributes to the speed of chemical reactions within the mass.

29. Microscopical Structure of Protoplasm.—The droplets of the disperse phase in protoplasm are mostly too small to be within the range of microscopic vision, and those which are not too small are hardly visible. The structure of protoplasm as exhibited under the microscope, however, reveals the presence of firm granules of different sizes; of fibers, which may form a network, or reticulum; and of droplets, or alveoli. None of these is evidence of the emulsoid nature of protoplasm but all may have a bearing on the function of the cell. Emphasis upon one or another of these different elements has formed the basis for three theories of the normal

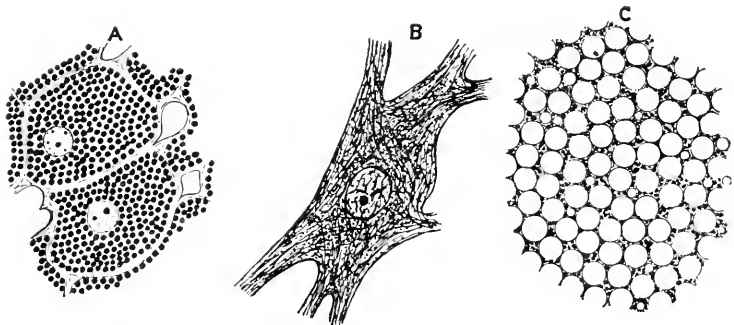

FIG. 3.—Semidiagrammatic sketches illustrating the different appearances exhibited by protoplasm. A, the granular type; represents cells from the liver of the mouse. B, the fibro-reticular type; represents a nerve cell with its fibers cut away. C, the alveolar type; represents a portion of alveolar protoplasm. (Figs. A and C modified from Wilson, *The Cell*, A, after Altmann, by the courtesy of The Macmillan Company.)

structure of protoplasm, which has been thought to be (1) *granular*, (2) *fibrillar* or *reticular*, or (3) *alveolar*. Though most protoplasm now seems to be alveolar in character, a granular appearance is often exhibited in gland cells, and fibers are prominent in nerve cells, muscle cells, and some epithelial cells (Fig. 3).

30. Appropriateness of Protoplasm as Living Substance.—It is evident from what has been said as to the chemical and physical characteristics of protoplasm that among these are many which contribute directly to the carrying out of life activities, and all are necessary in a substance in which life can manifest itself. Its physical characteristics, its chemical nature, its organization, its proneness to change, its ability to assume an almost infinite variety of forms, and its capacity constantly to carry on metabolism all make protoplasm the only appropriate living substance. Its exceedingly great complexity offers the possibility of almost infinite internal change and adjustment, while at the same time

the total chemical composition and the general character remain practically the same. Life itself is ceaseless change. When this protoplasmic organization becomes fixed and no longer capable of change, it has suffered that which we call *death*. Very soon after death reanimation under any conditions becomes impossible because changes supervene which destroy the very organization itself.

It is true that seeds and even some animals may be dried under proper conditions and exist for a long time in a dormant state. That the organization remains intact and its capacity to undergo the changes which accompany life is unimpaired is shown by the fact that when placed under suitable conditions life activities are soon resumed.

31. Life Is a Consequence or Concomitant of Organization.—Living matter, then, is not living because it contains certain elements, for none of these elements is characteristic of life. All the chemical substances which enter into protoplasm might be collected theoretically in proper proportions, but the mixture would not be protoplasm. Life is possible only when the organization which has been referred to above is effected; and when that organization is brought about, the other chemical and physical characteristics of protoplasm also become added to it. Protoplasm has been termed the “physical basis of life” and it is such in the sense that it furnishes the physical organization and the attendant conditions that make life possible.

CHAPTER VI

LIFE

As indicated in the preceding topic, life is always associated with a certain type of organization of matter. It can be defined neither in terms of the chemical elements which enter into it, none of which is peculiar to it, nor in terms of the forces which act through it, since those forces are the same as those which also act through nonliving matter, the results being different only because of the organization.

32. Definition.—Life might be defined as the possession of a certain type of organization or as embracing certain phenomena. It might be conceived of as energy manifested in a manner made possible by its organization. A precise definition is difficult to give in a form with which all would agree, but the following is suggested: *Life* is a continual series of reactions in a complexly organized substance known as protoplasm, by means of which the organization tends to adjust itself to a constantly varying environment. According to this definition a dormant mass of protoplasm, such as that in a seed, might possess the capacity to exhibit life but would demonstrate this only under certain favorable conditions.

33. Vital Force.—The theory has been held in the past that a mysterious vital force acts through living matter and is responsible for the characteristic phenomena of life, but every attempt to demonstrate the existence of such a force has ended in failure. As knowledge of life phenomena has increased, it has constantly become more evident that all such phenomena can be explained by reference to the same forces which also operate in nonliving matter and, as far as is known, throughout the universe.

34. Vitalism and Mechanism.—Those who have believed in this vital force have been termed vitalists, and their view *vitalism*. Over against this is the conception that the body is like a machine, played upon by forces in its environment, and that life phenomena are mechanical responses to these forces. Those who have contended for this view have been termed mechanists, and their view *mechanism*. While vitalism is not a tenable conception today, the most extreme form of mechanism also does not appeal to the greater number of biologists, who observe phenomena which are distinguished as vital. The view of the majority might be stated as a modified form of mechanism. It is true that there is nothing peculiar in the chemical elements or the physical forces in living matter as distinguished from nonliving matter, but that does not mean

that the chemical changes in protoplasm are precisely the same as those occurring in nonliving matter, nor does it mean that none of the phenomena associated with life is peculiar to living things. The differences, however, are the outgrowth of the organization and are not due to any supernatural force which animates living bodies.

35. Origin of Life.—The question of the origin of life on this planet has been a source of speculation from early Greek times, if not before. Empedocles, a Greek, about 500 B.C. presented a theory of the origin of life which was that owing to attractive forces elements were combined into the parts of which plants were composed, and then under the influence of the same forces these parts were assembled in such a manner as to form whole plants. Animals were supposed to have originated in the same way as did plants, parts being formed first which later came together to form the animals. This theory, fantastic as it now seems, is the first definite theory of the origin of life and has earned for its author the title of father of evolution. Aristotle, another Greek who lived in the fourth century before Christ, had a theory more in harmony with present-day conceptions. He believed that living matter originated as a jelly formed at the shore of the sea and that out of this evolved first plants and then animals. The simplest forms developed first, followed in order by others of gradually increasing complexity up to man.

The Mosaic, or *special-creation*, theory of the origin of life appears in the first chapter of Genesis and was the legendary explanation accepted by the Jews. According to this theory each kind of animal was created in the beginning with the same character it has today, or, in other words, each was the result of a special creative act. Because it is in the Bible this theory has been thought of as necessarily involving the idea of a divine providence and for that reason different from any other theory. As a matter of fact, however, the conception of a deity need not be associated with any one of the theories of the origin of life to the exclusion of its association with others. One who believes in a creative and ruling spirit or force in the universe will attribute to it the creation of life no matter what his theory may be as to how creation actually occurred, while one who does not believe in such a force will leave it out of whatever scheme of creation he holds.

Spontaneous generation implies the repeated creation of life whenever favorable conditions occur. A theory of spontaneous generation was held by the Greeks, who believed that various living forms found in fresh water died off each fall and were recreated each spring. The observations of Aristotle and others showed this belief to be incorrect in the case of many familiar forms. Gradually the number of animals thought to be spontaneously generated was reduced, until, in 1680, Redi, an Italian, effectively disproved the spontaneous-generation theory held at that time when he showed that fly maggots were not spontaneously generated in

decaying meat. This theory was again revived, however, when the microscope revealed the minute forms of plant and animal life which exist and which were immediately conceived by many to be spontaneously generated when the right conditions occur. The work of Pasteur in France and Tyndall in England during the latter part of the last century, however, disproved the possibility of spontaneous generation of even these minute forms. There are those today who entertain a belief in the possibility of the spontaneous generation of life, but there is no existing evidence to support their views.

Another theory of the origin of life held by the physicists, Kelvin and Helmholtz, who also lived in the last century, explains the presence of life on the earth by stating that it was brought here on meteorites through the interstellar spaces from some other world. This *meteoritic theory* is frequently coupled with the conception that life has always existed in this universe and is simply passed from one world to another from time to time. This is unsatisfactory to biologists, because it puts the whole problem beyond the possibility of human explanation, and because the conditions which would have to be withstood by life coming to this planet in that way are apparently beyond the limits of endurance of living matter. For this reason the theory has been believed in by only a few, and these not biologists.

Another theory of the origin of life, formulated by a German, Pflüger, in the latter part of the last century, has been known as the *cyanogen theory*. According to this theory the earth was once exceedingly hot and the elements were in a free state. As it cooled a temperature and other conditions were reached which caused the union of carbon and nitrogen into a substance known as cyanogen, the formula for which is CN . As the earth cooled still more, water was formed by the union of hydrogen and oxygen; and then by the combination of cyanogen and water, cyanic acid ($HCNO$) was produced. The characteristics of cyanic acid resemble in many ways those of protoplasm: (1) It is a liquid which is transparent at low temperatures, but it tends to coagulate and become opaque at high temperatures. (2) It can increase in bulk by a process essentially like that of growth by intussusception. (3) Its molecules can be rearranged to form urea and it can be decomposed into carbon dioxide and ammonia. By the addition of sulphur and other elements to cyanic acid, proteins might have been formed and thus life might have developed.

Another, known as the *bacterial theory*, is that of Osborn, who places the origin of life at a time when there was no soil on the surface of the earth, when all the water was fresh, and the air contained more carbon dioxide than at present. At that time the earth was shrouded in a dense cloud through which the sun never penetrated. This cloud was maintained by constant evaporation from the heated surface of the earth. The air was warm and saturated with moisture. Lightning played

constantly through the clouds and rain descended in torrents. Under these conditions nitrates are conceived to have been produced in rain-water pools due to the discharges of electricity in the water-saturated atmosphere, and ammonia also appeared in volcanic waters. Such conditions favor the growth of bacteria, and Osborn has suggested that the first life may have developed in the form of these minute organisms. Able to make use of inorganic food, very resistant to destructive agencies, and capable of exceedingly rapid multiplication, they were able to maintain existence and gradually evolved into higher but still simple forms from which both plants and animals have come. This theory suggests, the conditions under which life may have arisen and the nature of the earliest organisms but does not successfully solve the problem of the *origin* of life.

Numerous other theories have been proposed, one involving the development first of ferments and then, under the influence of these ferments, the organization of living matter. Another theory is that an inherent tendency exists for simple compounds, under proper conditions, to unite themselves together and form more complex compounds and that as a consequence of this tendency, and in a favorable environment, protoplasm was gradually built up or synthesized out of the various compounds which it contains.

None of these theories has proved satisfactory to biologists generally, and it must be confessed that at this time it is not possible to explain how life on this earth originated. That life must have appeared at a time when conditions were favorable goes without saying, but most biologists believe that at only one time in the history of the earth has there been such a fortunate concomitance of favorable conditions as to bring about this creation. From the life created at that time all living things which have ever existed on this earth have descended.

36. Possibility of Creating Life.—The creation of life by human agency has been the dream of men in the past, and the idea will surely continue to be entertained in ages still to come. In the present state of human knowledge, however, a realization of the dream seems to be out of the question. It appears hardly probable that the conditions which existed on the surface of the earth at the time when life first originated will ever be repeated in the laboratory. Theoretically it would be possible to assemble in the proper proportions those substances which exist in protoplasm, but the crucial thing—the bringing about of the organization which exists in living matter—seems beyond human power when the limitations under which men work are considered. Yet the idea is conceivable and efforts to bring it to fulfillment will probably never cease so long as the human race continues to exist.

CHAPTER VII

CELLS

Living protoplasm always exists in the form of minute masses known as cells, which possess a characteristic structure. Organisms may consist of but one cell or of many, but in either case the cell may be considered the unit of structure, or the morphological unit.

37. Definition.—A *cell* may be defined as a mass of protoplasm in which can be distinguished a portion called the nucleus. A distinction may be drawn between the substance of the nucleus, which is termed *nucleoplasm*, and the protoplasm of the rest of the cell, which is called *cytoplasm*.

38. Sizes and Shapes of Cells.—Cells vary greatly in size. The most minute animal cells are one-celled blood parasites which are invisible, or only barely visible, to the highest powers of the microscope. Most cells cannot be seen by the unaided eye. There are cells, however, which are relatively gigantic. A one-celled organism, parasitic in the alimentary canal of the lobster, reaches a length of two-thirds of an inch; and egg cells, with the yolk which they contain, may even exceed this in diameter and contain a much greater amount of substance. Some nerve cells, the main cell body of which is not proportionately very large, possess fibers, which are parts of the cells, that may even reach a length of several feet.

Cells also vary greatly in shape. The typical form, unaffected by environment or unmodified for the production of any particular function, is spherical, but the pressure of adjacent cells or from other structures may crowd these cells into a variety of shapes, such as polygonal, cubical, columnar, or flat and platelike. Other cells, particularly muscle cells, become greatly elongated and assume the form of fibers, while still others become very complexly branched (Fig. 4).

39. Numbers of Cells.—As has been previously stated, an organism may consist of but one cell; however, most organisms are made up of more, the numbers in the largest organisms running into the trillions.

40. Structure of Cells.—A cell (Fig. 5) consists of a mass of jelly-like cytoplasm inclosing a nucleus. The surface of this cytoplasm is covered by a *plasma membrane*, or cell membrane, which is living and semipermeable. Outside it may be a *cell wall* composed of material which is not protoplasmic and is nonliving, being a secretion formed by the cell. In animal cells this wall is often absent.

The *nucleus*, which is set off from the cytoplasm by a *nuclear membrane*, shows a fine network of fibers known as *linin* fibers; and scattered throughout the nucleus, adhering to these linin fibers, are masses of another substance known as *chromatin*. This name was given to this substance because it takes dyes or stains to a very high degree and when

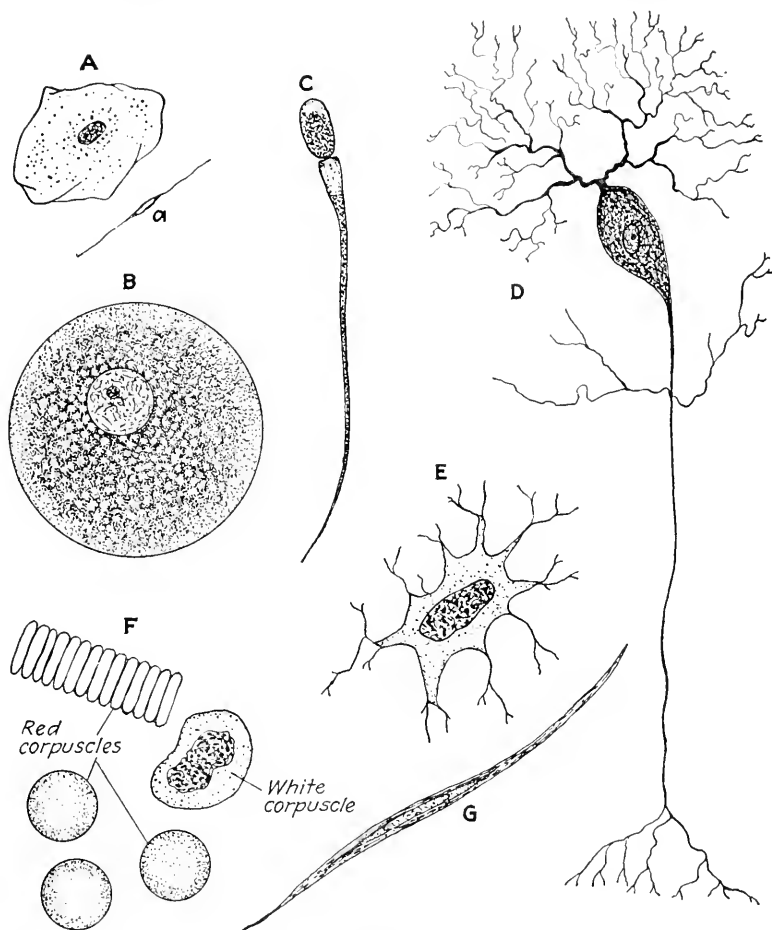

FIG. 4.— Various types of cells. *A*, epithelial cell shed from the lining of the human mouth; *a* is a side view of the cell. $\times 300$. *B*, human ovum, nearly mature. $\times 200$. *C*, human sperm cell. $\times 1300$. *D*, diagram of a nerve cell. *E*, a bone cell; somewhat diagrammatic. $\times 700$. *F*, human blood corpuscles. $\times 1,000$. *G*, nonstriated muscle cell from mammalian intestine. $\times 640$.

the cell is subjected to these, the chromatin stands out as scattered, deeply stained particles. A body which shows plainly in the nucleus is known as a *nucleolus*. Nucleoli, however, are of various kinds. Some are called *plasmosomes* or true nucleoli. Sometimes such a body is made up of granules of the chromatin massed together and is called a *karyosome*

or chromatin nucleolus. The more fluid portion of the nucleoplasm between these structures which have been enumerated is often called *nuclear sap*.

In the cytoplasm appear several characteristic structures. A body appears, under certain conditions, near the nucleus, known as the *central body*, or *centrosome*, containing one or two granules called *centrioles*. More or less solid particles in the cell include living portions of the protoplasm which have some particular function to perform, such as the chlorophyll bodies which give the green color to plants. These have been given the general term *plastids*. Included in plastids are *mitochondria*, or chondriosomes, which are fiber-like and more compact structures, the

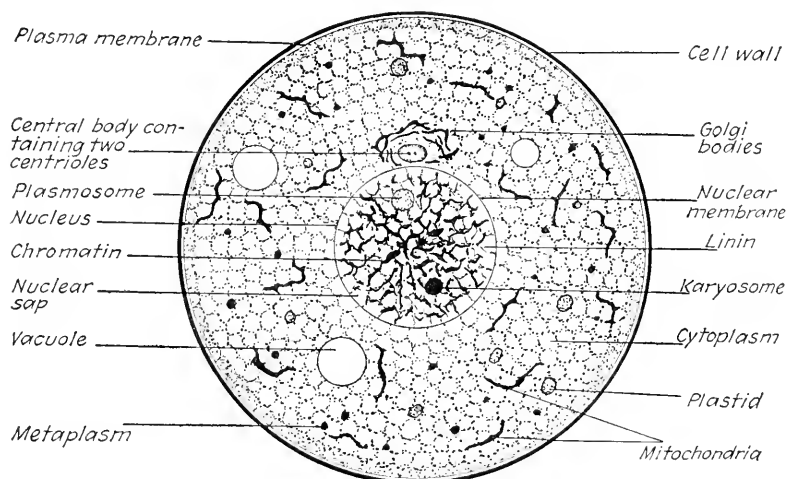

FIG. 5.—Composite diagram of a cell having the form of a typical cell and containing all of the structures generally recognized as normal in cells not modified for any particular function.

nature of which is in question; and *Golgi bodies*, which may be scattered through the cell or collected around the central body. Bits of food or waste particles which have collectively been called *metaplasm* may be present in the cytoplasm. *Vacuoles* are transparent droplets seen regularly in certain cells or at certain times in other cells.

41. General Physiology of the Cell.—There is a division of labor in the cell among the structures which have been named. The nucleus is, in a sense, the vital center. Cytoplasm alone is unable to carry on its activities and its life is brief after it is separated from the nucleus. Probably under the influence of substances formed by the nucleus and passed out into the cytoplasm the latter does most of the ordinary work of the cell, including the taking in of food, the carrying on of many of the chemical and physical changes associated with life, the passing out of waste, the reception of all stimuli, and the movements which occur in response to them. The chromatin is the medium by which hereditary characters are

transmitted, and therefore it determines the character of the cell. The central body with its centriole, or centrioles, is active in cell division. Plastids are living structures with active functions and are more numerous in plant than in animal cells; the chlorophyll bodies, which are one form of plastids, utilizing the energy of the sun's rays, build up carbohydrates from carbon dioxide and water. As indicated in the preceding topic some of the other structures play only a passive rôle, while the functions of others are not definitely known.

42. Development of Knowledge of the Cell.—The history of this development may be briefly summarized as follows: Hooke, an English microscopist, discovered in 1665 that cork was divided into little compartments which, because they reminded him of the cells in a monastery, he called cells. In 1833, or 168 years later, Brown, also an Englishman, discovered the nucleus, and it was then supposed that the cell consisted of a living wall inclosing a nonliving, watery substance in which floated the nucleus, also living. It was not until 1835 that Dujardin, a Frenchman, as has already been stated (Sec. 26), discovered that this watery content of the cell was a substance of peculiar character and that it, too, was living. From this time the cell was believed to contain these three elements, which were found to be common to both plants and animals. It was discovered after a time, however, that cells existed which did not possess a cell wall. Thus the wall, which was at first supposed to be the essential part of the cell, was finally eliminated as a part of it and the word cell became really a misnomer. The most important contribution to the modern conception of the cell was that of Max Schultze, who, in 1861, showed that the substance of all cells, plant and animal, was similar, and who defined a cell as a "small mass of protoplasm endowed with the attributes of life."

43. Cell Theory and Cell Doctrine.—The cell theory was due to the work of Schleiden, a botanist (1838), and of Schwann, a zoologist (1839). Each of these men had found cells in all living matter which he had studied, and they presented, each in a publication in his own field, a hypothesis which has been known as the *cell theory*, to the effect that living matter always exists in the form of cells. It was to them a theory, but in the time that has elapsed since the dates mentioned it has been found to hold good for all living substance which has been studied. Thus today we no longer consider it a theory but rather a fact, and so it has come to be known as the *cell doctrine*. This conception when first presented had a most profound effect upon biological thought, and its influence has been equaled only by that exerted by Darwin's theory of evolution.

CHAPTER VIII

METABOLISM

Reference has been made previously to the fact that one of the characteristics of living matter is its ability to carry on metabolism—that is, its ability to take material into the body and work it over in such a way as to make it a part of the living organization and from it to secure the energy with which to carry on the processes of life.

44. Definition.—All living things, in the performance of their various activities, exhibit physical and chemical changes. A result of the former

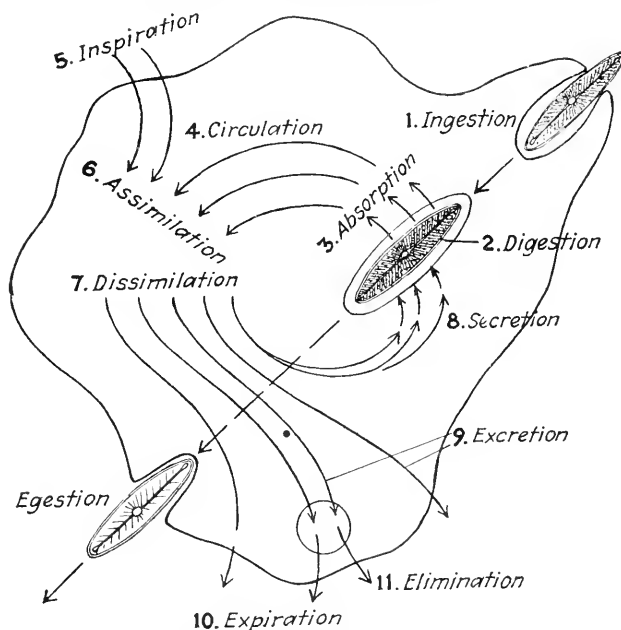

FIG. 6.—Diagram showing the steps in metabolism as they occur in an amoeba.

is the liberation of the needed kinetic energy, and of the latter the formation of waste materials which are thrown away. To replace the material so used and to provide a source for more kinetic energy, food must be taken into the body and incorporated in the organization. The sum total of all the chemical and physical processes involved is termed *metabolism*. The discussion which follows applies particularly to animal organisms, but plants carry on metabolism by a series of steps which, considering the difference in structure, parallel those in animals.

45. Food.—The *food* of the organism, in the broadest sense, must include all of the compounds which enter into the chemical organization of protoplasm—that is, proteins, fats, carbohydrates, salts, and water. It must also include certain substances termed vitamins which seem to play a necessary part in the carrying on of metabolic activities. It is also essential that this food shall supply energy in such a form as to be available to the organism.

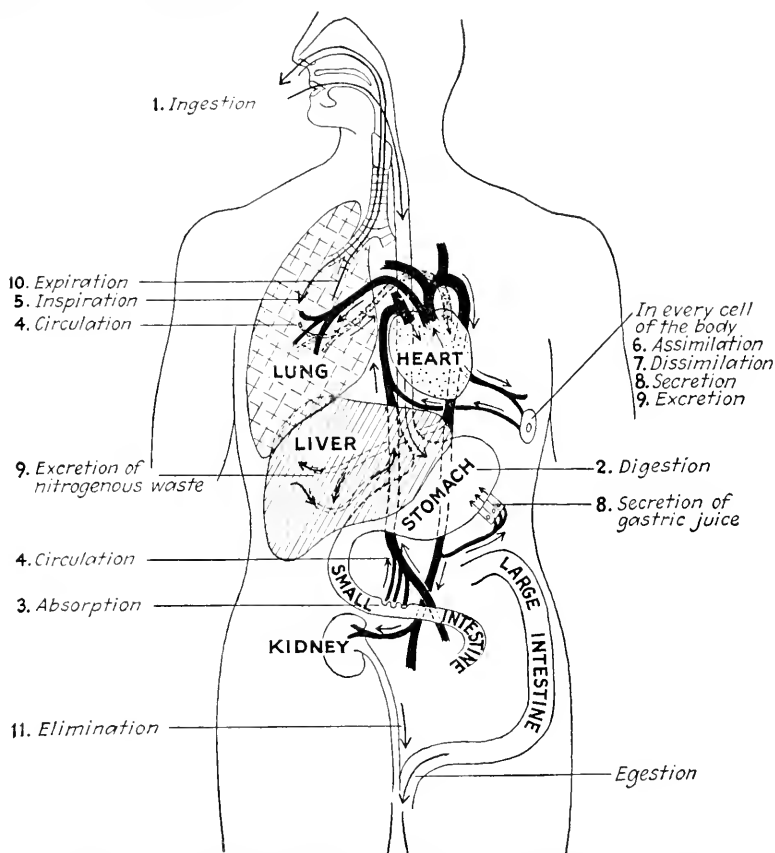

FIG. 7.—Diagram to suggest the steps in metabolism as they occur in the human body. For comparison with Fig. 6.

46. Steps in Metabolism.—Metabolism takes place in the body by a series of very definite steps (Figs. 6 and 7), all of which are necessary in the metabolism of the higher animals, but certain ones of which are simplified or dispensed with in the case of the very simple animals. These steps are referred to in terms that are more or less in popular use with very loose and uncertain meanings. The words excretion, secretion, elimination, and assimilation are frequently met but are usually used with an uncertain significance. It will be necessary, therefore, for the student

to learn these words in this connection as scientific terms, each with a very precise meaning, and to keep this meaning separate from that which he may have hitherto attached to the word.

47. Ingestion.—The first step in metabolism is the taking in of food—*ingestion*. This may occur in one-celled animals through any point on the surface of the body. While the same may be true to a certain degree in the case of higher animals, most of them, and some of the one-celled ones, take food through a particular opening on the surface of the body, called the mouth. Under the head of ingestion also occurs all mechanical processes such as chewing and swallowing which precede any chemical change.

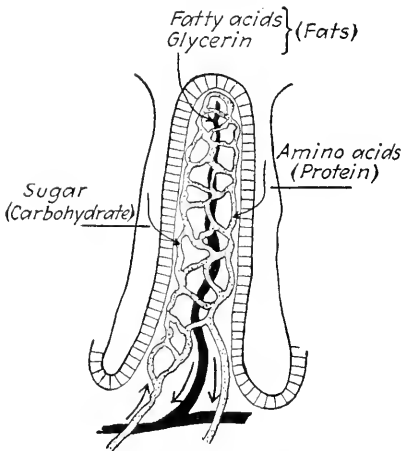

FIG. 8.—Diagram of a villus, one of the finger-like projections in the small intestine of a mammal, to show how the absorption of organic foods takes place. The lymph vessels are in solid black, the blood vessels stippled.

digested, the other foods being capable of absorption without undergoing this process.

49. Absorption.—The passage of the digested food from the food vacuole into the protoplasm of one-celled animals is termed *absorption*. In higher animals the same process takes place by the food entering the cells forming the lining of the alimentary canal and being then passed into the blood or lymph contained in blood vessels or lymphatics which lie behind these cells (Fig. 8). In vertebrates absorption occurs mostly in the small intestine. The digested food is not further changed during this process, though it may suffer a change as soon as the process is complete. In the process of digestion fats, for example, are broken down into fatty acids and glycerin but are changed back to fat in the cells into which they are absorbed.

50. Circulation.—Whether the animal is one- or many-celled, the food cannot be all utilized at the point of absorption but must be circulated throughout the living body for use in various parts. This *circulation* may take place within the cell, by osmosis from cell to cell,

48. Digestion.—As soon as the food is in position to be acted upon by digestive fluids, these are secreted into the cavity which contains it. By their action a series of chemical and physical changes is initiated, which results in reducing the solid food to liquid form and changing part of it chemically so as to render it capable of being absorbed. This process is called *digestion*. In the higher animals digestion may begin in the mouth and be continued in the stomach and intestine. Only organic foods need to be

or by means of a circulatory system, generally the blood circulatory system.

51. Inspiration.—Oxygen, as well as food, is constantly needed by the body. Its entrance into the body is termed *inspiration*. This may occur through all points on the surface of the body or may occur only through certain particular organs set aside for the purpose, such as lungs or gills. Upon entrance into the body oxygen is circulated in the same manner as food and taken up by the tissues as needed. This passage of oxygen into the tissues is termed *internal inspiration*; its entrance into the body, *external inspiration* (Fig. 9).

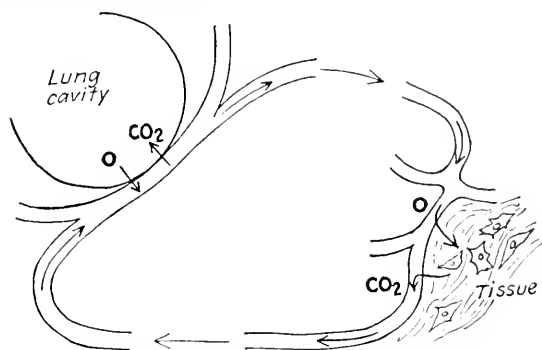

FIG. 9.—Diagram to illustrate external and internal respiration.

52. Assimilation.—The food, having been brought to the point in the body where it is to be used, is taken up by the protoplasm and more or less intimately incorporated into the living mass, becoming, at least for the time, a part of the organization. This process of addition of new material to the existing material of the body is termed *assimilation*. This material, no longer food but a part of the protoplasm, may be soon used or it may remain for a greater or less length of time as a part of the cell before actually becoming involved in chemical changes.

53. Dissimilation.—Sooner or later chemical changes occur which collectively are called *dissimilation*, as a result of which protoplasm and the more complex food substances associated with it are broken down into simpler substances. Associated with these chemical changes is a transformation of part of the potential energy represented by these substances into kinetic energy, which appears mostly in the form of heat or movement.

54. Secretion.—If the substances produced in dissimilation can be utilized in any way by the body as a whole, they are termed secretions, and the process involved in their passing out of the cell which produces them is termed *secretion*. These may be passed out upon the surface of the body, into any cavity in the body, or into the blood and body fluids. Examples of such substances are the tears, which when poured

out upon the surface of the eyeball serve to keep it moist; other fluids, which also serve to moisten or lubricate internal surfaces; the digestive secretions, which when passed into the alimentary canal assist in the digestion of food; and also substances known as internal secretions. These internal secretions are carried over the body and perform various functions in connection with the carrying on of life activities, such as the regulation of metabolism and the control of growth processes.

55. Excretion.—Some products of dissimilation, such as urea, water, and carbon dioxide, seem to be of no use to the body and are termed excretions. The process by which they are passed out of the cell which forms them is termed *excretion*. In many cases the excretions are poured out directly upon the surface and are immediately disposed of; in other cases, however, they are formed in the body at some distance from the external surface and have to be transported to some particular part of the body before they can be passed out. Here again the *circulation* comes into play, it being as necessary for the carrying of waste matters to the point where they are passed out of the body as for the transportation of food and oxygen to the cells.

56. Expiration.—The carbon dioxide formed in dissimilation is carried by the circulation to some particular part of the body where it is passed out. This part may be in the lower animals the general body surface or some particular structure within the body; in the higher animals it is the gills or lungs. This process is *expiration*. Here also a distinction may be made between *internal expiration*, which is the passage of carbon dioxide out of the tissues into the blood, and *external expiration*, which is its passage from the body (Fig. 9). Expiration relieves the body of its gaseous waste.

57. Elimination.—Liquid waste may be eliminated from any point on the body surface, or it may be passed out by some particular structure. In the higher animals the kidneys and skin are the principal organs of *elimination*, though some elimination may occur through the walls of the alimentary canal toward its posterior end. In this last case elimination should not be confused with egestion. As an example of the difference between excretion and elimination may be mentioned the fact that urea is produced in the body in the liver, where excretion proper takes place, but it is very largely eliminated by the kidneys.

58. Egestion.—*Egestion* is the passing from the body of indigestible materials contained in the food, which are known collectively as *feces*. Feces might be referred to as solid waste, but they have not, properly speaking, been involved in the process of metabolism as have the substances which are expired or eliminated. The material egested has been passed through the body but has at no time been a part of it. Egestion, again, may take place from any point on the surface of some of the one-

celled animals or may take place through the posterior opening of the alimentary canal in higher forms.

59. Respiration.—The processes of inspiration and expiration taken together constitute *respiration*, which includes all gaseous interchanges in the body.

60. Anabolism and Katabolism.—The processes beginning with ingestion and ending with assimilation are collectively termed anabolism. *Anabolism* may be defined as the sum of all processes involved in the building up of the body. The processes beginning with dissimilation and ending with expiration and elimination are collectively termed katabolism. *Katabolism* may be defined as the sum of all processes having to do with the breaking down of the body and the getting rid of the waste matter resulting from it. Egestion, for reasons given in a preceding paragraph (Sec. 58), does not belong under either anabolism or katabolism.

61. Vitamins.—It has been found recently that providing the body with the necessary kinds and amounts of proteins, fats, and carbohydrates or of salts and water is not sufficient. Something else is needed to enable it to assimilate the organic foods, and that is the presence of *vitamins*. These are organic substances of unknown composition that occur in certain natural foods. Vitamin A (fat-soluble) is present in many animal fats, milk, butter, and yolk of eggs but is deficient in vegetable substitutes such as oleomargarine. It promotes growth and perhaps protects the body against rickets. Vitamin B (water-soluble) is found in fruit juices, meat, milk, yolk of eggs, the coverings of grains and other seeds, yeast, and thin-leafed vegetables. It also promotes growth and guards the body from certain inflammatory conditions in nerves. Vitamin C (water-soluble) is contained in citrus fruits, raspberries, apples, beans, cabbages, carrots, turnips, and tomatoes and in liver. It prevents scurvy. Vitamin D (water-soluble and fat-soluble) occurs especially in cod-liver oil. It also prevents rickets, and a deficiency of it leads to an inability to form a properly calcified skeleton.

62. Energy Changes in Metabolism.—The food taken into the body represents a supply of potential energy. One object of dissimilation is to change part of this into kinetic form in order that the body can make use of it. This kinetic energy appears mostly as heat and as the mechanical energy exhibited in movement; a small part appears as electrical energy; and in some cases, in very small part, as light, shown in the luminescence of some organisms. Some of this kinetic energy is necessarily used in the securing of additional food, but some is also used in growth, in reproduction, and in carrying on other activities. Among the lower animals the portion of energy used in the securing of additional food is much larger than in the higher animals. The development of efficiency among the latter is, to a considerable degree, connected with

the possession of more effective food-securing devices, which leaves a proportionately larger part of the total energy of the body to be used in other ways. Man has solved this problem far more successfully than any animal below him, and the advance he has made to a dominating position in the animal kingdom may to a considerable degree be attributed to this fact.

63. Uses of Different Foods.—The different foods serve different purposes in the body. The protein food is in part used to replace the protein of living tissue when that is used up. Carbohydrates furnish the mechanical energy expended in muscular movements. Fats are used chiefly as a source of heat. All dissimilative changes in the body liberate heat, but from fats, owing to the fact that they contain a very small amount of oxygen and are therefore susceptible of a great deal of oxidation, may be produced more heat than from any other food. Water must be maintained in large amount in the body, both because it is needed to give the required consistency to the protoplasm and because it serves as a vehicle for other substances in solution. Salts are essential constituents of protoplasm, also participating in the metabolic changes and exerting a regulatory effect upon them. Oxidation processes take place in all of the cells of the body, the extent of such processes in any given cell determining the amount of activity carried on by the cell. They do not occur in the blood except in the blood corpuscles, which are cells.

64. Storage.—The body does not in all cases make immediate use of the food absorbed, in which case it may be stored against future need. Fats are thus accumulated in the form of fat. Since carbohydrates are the chief sources of muscular energy and since the body must at all times have not only a ready supply but also a large volume in storage to be used as needed, there is in the liver an abundant supply of stored carbohydrate ready to be given out to the blood and circulated to all parts. An excess of carbohydrates may be changed to fats and stored as such. In the chemical changes in the body, carbohydrates may be derived from substances resulting from protein decomposition, and fats may in some cases be changed to sugar, but neither of them can be converted into proteins, since these contain nitrogen, which is lacking in carbohydrates and true fats. Proteins are not stored, but any excess is immediately broken down and the waste products eliminated. Storage should not be confused with growth, since the stored food is not a part of the protoplasmic organization.

65. Metabolism the Central Fact in Life.—All life activities result from metabolism in the living organism, and therefore life might be defined as the orderly series of metabolic changes which occur in matter possessing the necessary protoplasmic organization. In last analysis all of the functions of the living body may be described in terms of metabo-

lism. The animal organism may be conceived as an energy system, and it has also been likened to a chemical machine the product of which is kinetic energy. The plant organism, likewise, may be conceived as an energy system and as a chemical machine, but its product is largely the complex organic compounds which form the basis of the food of animals.

CHAPTER IX

PLANTS AND ANIMALS

Two great groups of living things exist, plants and animals. The higher forms of the two are readily recognized, but the simpler ones lack the characteristics which serve to distinguish the higher types. Many simple living things cannot be satisfactorily assigned to either category. A German named Haeckel suggested as a way out of this difficulty that an intermediate group, which he termed Protista, be recognized. This suggestion, however, has not been followed, because it would simply double the difficulty—instead of having to draw one line of demarcation which is very uncertain, it would be necessary to draw two lines, both as uncertain.

66. Comparison between Plants and Animals.—In many respects plants and animals agree. The protoplasm of which both are composed is, as far as can be seen, essentially the same. Although plant and animal cells have certain features which aid in their discrimination, those features are not essential characteristics of the protoplasm of which they are composed, and as far as present knowledge goes, the protoplasm of the two is indistinguishable. Indeed, it is generally assumed that there was but one creation of life on this earth and that from that first created life both plants and animals have sprung. This makes quite intelligible the difficulty in distinguishing between the simpler forms of the two. Metabolism is carried on essentially in the same manner in plants as in animals. Plants and animals have many activities in common and those in which they differ are developed gradually in passing from lower to higher forms. The lower plants are termed protophytes and the higher metaphytes, while the lower animals are called protozoans and the higher metazoans. The unit of plant structure is the cell, as is also the unit of animal structure, and plant cells present the same phenomena in connection with their multiplication as do animal cells. They are affected in a similar manner by various external forces. The higher forms of both possess sex. The mechanism of inheritance is the same and the phenomena connected with inheritance are also quite comparable in plants and animals.

67. Biology.—Because of the fact that there are many things in common between plants and animals, the subjects of botany and zoology are frequently considered as parts of one larger subject termed *biology*. It has to do with all that concerns living things in general and may be conceived of as divided into the two fields botany and zoology. In the further division of these two fields each can be divided into a series of

subsciences which in general correspond. Thus one can speak of plant morphology and animal morphology, of plant ecology and animal ecology, of plant physiology and animal physiology, and the same is true of taxonomy, pathology, embryology, and so on.

68. Differences between Plants and Animals.—The higher plants and higher animals, as has already been stated, present distinctions which are sufficient in all cases to enable us to assign a living thing to either one category or the other. Among these distinctions are the following:

1. *Movement.*—Broadly speaking, the higher plants lack the power of movement and in all cases are without the power of locomotion. On the other hand, almost without exception, animals are possessed of both.

2. *Manner of Growth.*—In a general way it may be said that the plant grows by the addition of parts externally, such as the addition of leaves and twigs. There is also evidence of internal growth, as is seen in the gradually expanding trunk and constantly thickening branches, the new wood being added just underneath the bark. In animals, on the other hand, few parts are seen to be added externally, though some animals show at times a gradual increase in size of wings, horns, and other visible parts; growth is mostly internal and the body simply increases in size.

3. *Cells.*—Plant cells usually possess a distinct cell wall, composed of cellulose, which gives to the cell rigidity of form and to which is due the immobility of the plant body. Animal cells, on the contrary, often possess no wall of any kind, and the walls, when they are present, are generally thin and permit the cell to change shape. This fact contributes to the power of movement and of locomotion possessed by animals.

4. *Food Securing and Metabolism.*—There are minor differences between plants and animals connected with the metabolism of the two, but the steps are essentially the same (Fig. 10). However, the oxidation changes in the cells which are included in this text under the term dissimilation are by botanists termed respiration. Plants, in addition to carrying on the same type of metabolism as has been described for animals, have the power of manufacturing their own complex foods. By virtue of their possession of plastids and of their ability to utilize the energy of the sun's rays they can take simple substances from the earth and air and out of them synthesize complex substances such as proteins, fats, and carbohydrates. These processes are known as *photosynthesis*. After producing these substances plants make use of them in the same fashion as do animals, but animals being incapable of manufacturing such foods have to get them from plants or by eating other animals.

Since plants take these simple substances in gaseous or liquid form there is no solid waste left as a result of plant metabolism, and consequently egestion does not occur. Also, since plants build up proteins, which they add to their substance, and make immediate use of any nitrogenous matter liberated in protoplasmic activity, they do not

produce urea, a characteristic excretion of animals. In photosynthesis plants use up the available carbon dioxide and give off an excess of oxygen, while animals always utilize all the oxygen they can get and give off carbon dioxide as waste.

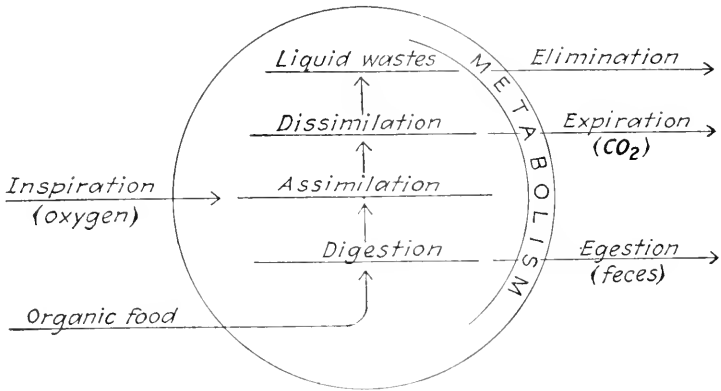

a. Animal

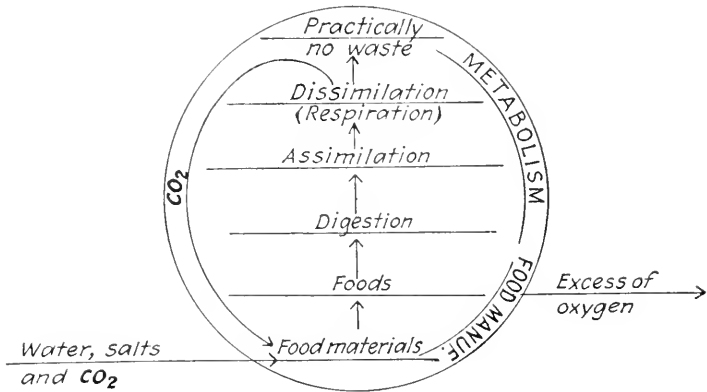

b. Plant

FIG. 10.—Diagrams contrasting the metabolic and food-manufacturing processes in plants with the metabolic processes in animals.

Because of the difference in metabolism of plants and animals plants have often been referred to as predominantly anabolic in their activities, while animals are characteristically katabolic. Also, since in the presence of light the processes concerned with photosynthesis outweigh those concerned in the metabolism of protoplasm, during the day plants use more carbon dioxide than they produce and produce more oxygen than they use. At night when photosynthesis is arrested they are, from a metabolic standpoint, on the same plane as animals.

CHAPTER X

GROWTH AND REPRODUCTION

Whenever during the lifetime of an animal assimilation exceeds dissimilation, there results an increase in the actual amount of protoplasm in the body; this increase is termed *growth*. When the reverse is true and dissimilation exceeds assimilation, the body shrinks in size; this process is known as *emaciation*. Many animals continue to grow throughout their lifetimes, although growth is more rapid at the beginning and slows up more and more with advancing age. This is true of many cold-blooded vertebrates, in the case of which size is a fairly clear index of age, other conditions being equal. Of course, in this case care must be taken to judge of the amount of available food, for in an environment in

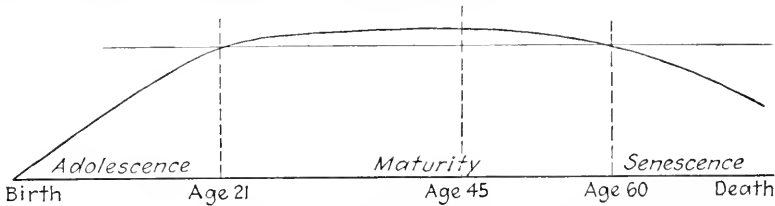

FIG. 11.—Diagram illustrating the growth cycle in man. This is intended to be typical, but individual growth cycles vary greatly, both as to the span of the whole and the proportionate lengths of different periods.

which food is limited a limit is also set to the size of the animal, and no matter how old it may grow it will never equal in size an animal living under more advantageous conditions.

69. Growth Cycles.—The life cycle of an animal comprises the whole series of phenomena from the time development begins to the death of the organism. Among the various aspects in which this can be studied is that which involves the growth cycle. This varies greatly with different animals. As has just been stated, some animals never cease to grow; others grow only during the early parts of their lives. The latter is true of insects, none of which ever grows at all after the adult condition is reached. The higher vertebrates, however, including man, have a regular growth cycle involving youth, maturity, and old age (Fig. 11). Growth is most rapid in this case at the beginning of life and remains still rapid until the end of the period of youth, when the individual has practically attained full stature. A very gradual growth still continues,

becoming constantly less rapid, until the maximum size is attained, which is usually somewhat beyond middle life. There is then a slow decrease in weight. Throughout the rest of the period of maturity this decrease continues, becoming gradually more pronounced; after the individual passes into old age, however, there is a more rapid emaciation, which ends with death. The youthful condition is termed *adolescence*; that accompanying old age, *senescence*.

70. Limit of Size.—No matter what the character of the life cycle may be or when growth takes place or for how long, there is in the case of all animals a size limit which is not surpassed. While in one-celled animals this varies somewhat in different lines of descent, in any one line it is rather closely approximated. In such forms there seem to be some metabolic relations in the cells, which, as this limit is approached, give rise to changes which automatically result in the division of the cell and the production of smaller organisms. The same thing is true of the individual cells which compose the bodies of higher animals, but the result is to produce a larger body and not new individuals. In some higher forms the process of cell multiplication practically ceases as the individual becomes adult; in other forms it stops in certain parts of the body but goes on in other parts. The organs of the central nervous system reach full size early in life. Bones and muscles continue to grow until the animal becomes adult. The skin, however, from the outer layer of which dead cells are continually shed, grows throughout life by the multiplication of living cells in the deeper layers. The size of many-celled animals is also limited by various factors such as inheritance, the available food, and the activity of glands the secretions of which favor or hinder growth.

71. Reproduction.—Multiplication by cell division, which is the most common way among one-celled animals, is not possible to those which are many-celled, since the different cells which make up the latter become varied in form and structure and also become limited to the performance of one or a few functions out of the many that are possessed by the body as a whole. Consequently such cells cannot reproduce the complete animal. Under these conditions certain cells are set aside for the purpose of reproduction and are relieved from the performance of any other duty. They serve as cells from which the development of another individual may be initiated, transmitting to that individual the characters of the parents in the bodies of which they have been produced. Such cells are termed *sex cells* or *gametes*. Of these there are two types which in the higher animals are known as egg cells and sperm cells, or sperms. The animal which produces egg cells is called *female* and the one which produces sperm cells, *male*. Generally speaking, *egg cells* are relatively large in size and *sperm cells* relatively very small, so that the former may be termed *macrogametes* and the latter, *microgametes*. These

terms are common to both botany and zoology, the same being true of another term, *zygote*, which is applied to the cell resulting from the union of a sperm cell and an egg cell in fertilization. This union of two sex cells is also known as *syngamy*. This *sexual* type of reproduction is characteristic of higher animals, while *asexual* reproduction, which is any type not involving these sex cells, occurs chiefly in lower ones.

CHAPTER XI

MITOSIS

The necessity of ultimate cell division in the cases of cells which continue to grow has been explained in the previous chapter (Sec. 70). If the cell thus dividing is itself a one-celled animal, then cell division and reproduction occur at the same time. If, however, the cell is only one of the cells in a many-celled animal, then division does not in most cases result in reproduction, which is the formation of a new individual, but simply in an increase in size of the individual of which the cell is a part. It makes no difference, however, as to the precise manner in which the division is carried out except that in one-celled animals it is a relatively simple process and in many-celled animals it is more complex.

72. Normal Cell Division.—The ordinary way in which a cell divides is by a series of steps (Fig. 12) which do not occur in every case in precisely the same order, but all of which are passed through before the division is complete. These steps may be outlined as follows: First, the central body, if it has not before been visible, comes into view beside the nucleus and both it and its centriole divide into two. These two central bodies begin to separate, and as they do so fibers appear between them which form a spindle-shaped figure. At the same time the chromatin granules in the nucleus, which have been scattered irregularly upon the linin network, begin to collect together into a slender and very much tangled thread, or *spireme*, and the linin network as such begins to disappear. This thread shows itself early to be a double thread. Radiating rays, termed *astral rays*, appear about each central body, forming star-shaped figures known as *asters*. As the central bodies gradually separate each with an aster about it, the spindle fibers between them seem to press against the nuclear membrane. The chromatin thread shortens and thickens, forming a much less involved tangle, while the linin completely disappears. This shortened, double chromatin thread breaks crosswise, producing a number of pieces which are known as *chromosomes* and which, because the spireme was double, are in pairs. During these changes, while the central bodies still continue to separate, the nuclear membrane disappears and the *spindle* swings into the area occupied hitherto by the nucleus. The central bodies come to lie on opposite sides of what was the nuclear area and the spindle stretches across this area from one central body to the other. The chromosomes arrange themselves in a double row across the center of the spindle, forming in

some cases what is known as an *equatorial plate*. End views at this time show that the chromosomes may form a ring about the equator of the spindle but that more often they are distributed through it. The asters reach a maximum development, extending sometimes to the periphery of the cell. At this time the mitotic figure is called the *amphiaster*, and the stage the *amphiaster stage*. The chromosomes are in pairs and the two of a pair are similar. Now the two of each pair of chromosomes

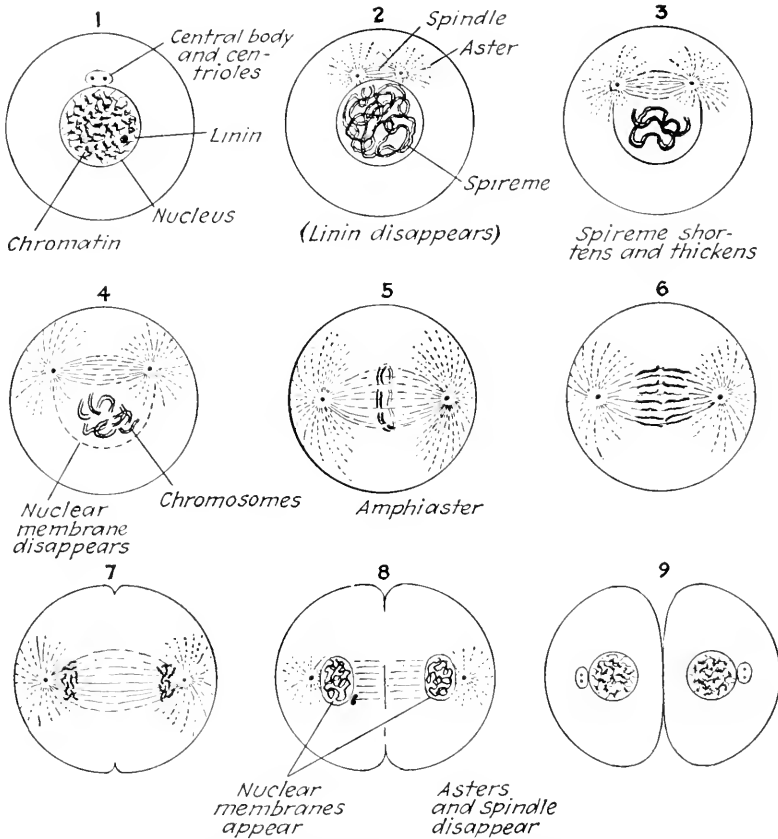

FIG. 12.—Diagrams representing the steps in a typical mitosis. The steps numbered 1 to 4 represent the prophase, 1 being a resting cell; 5, the metaphase; 6, the anaphase; and 7 to 9, the telophase, 9 showing the two daughter resting cells.

begin to separate, one moving along the rays of the spindle toward one central body and the second moving toward the other central body. As the two separating groups of chromosomes approach the central bodies these chromosomes become scattered about the respective ends of the spindle in an irregular fashion. Then a series of steps occur which in a general way are the reverse of the steps occurring at the beginning of the process. The separate chromosomes become irregular in shape and fuse,

forming a meshwork, from which finally are produced granules of chromatin scattered over a new network of linin, all formed out of the chromatin. A new nuclear membrane appears about each group and thus two nuclei take form; this membrane is also formed from the chromatin, though the cytoplasm may assist in its formation. The spindle fibers gradually disappear, as do the astral rays. A constriction appears in the cytoplasm of the cell in the same plane as the equatorial plate, frequently as early as the stage in which the two groups of chromosomes begin to separate. This constriction grows deeper and deeper while the two new nuclei, or daughter nuclei, are being formed. Finally, as the spindle fibers disappear, the constriction cuts clear through the cell, which thus forms two new cells, each with a nucleus, and each half the size of the parent cell.

The whole process of cell division which has been outlined is divided into four phases. All of the steps from the beginning to the time when the chromosomes line up in the equator of the spindle are termed collectively the *prophase*. The steps involving the arrangement of the daughter chromosomes in pairs in the equatorial plane are termed the *metaphase*. The process of division may be arrested for a time at this point. The period of migration of the daughter chromosomes from the equator of the spindle to the poles is termed the *anaphase*, and the series of steps involved in the division of the cytoplasm of the cell and the construction of two separate nuclei is termed the *telophase*.

These steps do not always occur in the same order and any general outline such as has been given will have to be modified in a great variety of ways to suit different cases. There may be two centrioles in the resting cell before mitosis begins. Variations occur in the time of the splitting of the chromatin thread and its division into chromosomes. In some cases the spireme is single and breaks transversely into chromosomes during the prophase. These line up on the equator of the spindle and split longitudinally in the metaphase. The two of a pair so formed are similar to the parent chromosome, and it is assumed that each pair of chromosomes formed from the double thread is derived from a parent chromosome, to which they are similar. Sometimes the linin seems to disappear; at other times it seems to assist in the production of the spindle; and in still other cases it seems to contribute to the formation of the chromosomes. In some cases, especially when the chromosomes form a ring around the spindle, a distinction may be drawn between the chromosomal or traction fibers which connect the chromosomes with the poles of the spindle, and which are also called mantle fibers because they are on the outside of the spindle, and the continuous fibers that run from one pole to the other. This mode of cell division has been called *karyokinesis*, meaning nuclear movement, or, more commonly, *mitosis*, from the Greek word for thread, referring to the chromatin thread.

The whole process may be conceived as a play in four acts in which there are no pauses between the acts. In the first act, the prophase, the characters are introduced and several scenes are presented which lead up to the second act, the metaphase. This is a grand tableau which shows the stage fully set and the characters in formal array. In the third act, the anaphase, a parade of the chromosomes results in their separation and the division of all the characters into two groups at the opposite sides of the stage. In the fourth act, the telophase, the characters in each group adjust themselves to the changed conditions and find their proper places in the new order.

73. Significance of Mitosis.—The universality of this process in the division of both animal and plant cells, and the regularity with which in every case the various steps occur suggest that the process is of vital importance. The great care with which the chromatin is divided between the two cells seems to show that this division is, of all these steps, the most significant. Recognizing in chromatin the substance which bears the hereditary qualities from cell to cell, and in the case of sex cells from animal to animal, this splitting has been conceived as having for its end the passing on of the hereditary qualities to each of the two daughter cells. Thus not only do these become structurally alike but each also possesses the same inherited characteristics as the other and as the parent cell. The various modifications of the process do not seem to affect this judgment. The equal division of characteristics is explained on the assumption that these characteristics correspond to units which are arranged in a longitudinal series from one end of the chromatin thread to the other, so that a longitudinal splitting of the thread involves the equal division of every unit and therefore the sharing of every characteristic.

74. Amitosis.—In contrast to the process just described, there has always been recognized another type of cell division known as *amitosis*, or direct cell division. Amitosis has been described as involving simply the constriction of the cytoplasm into two portions, this constriction also affecting the nucleus and dividing it into two portions, so that the whole cell becomes divided into two parts containing equal amounts of cytoplasm and nucleus. It seems to occur only in cells which are highly specialized, lacking in vitality, or undergoing degeneration.

75. Continuity of Cell Life and Chromatin.—Two conceptions flow directly from a consideration of the phenomena of cell division. One is that all cells must be derived from previously existing cells, just as all living things receive their life from previously existing living things. This fact has been recognized for a long time and expressed in the aphorism *omnis cellula e cellula*, or "every cell from a cell," which we owe to the German pathologist, Virchow. Another conception, based upon the equal division of chromatin qualitatively and quantitatively between the two daughter cells, is expressed in the phrase "continuity of chromatin"

and is that all chromatin has come from previously existing chromatin back to that of the first created protoplasm. This implies that in the first life created on this earth were inherent all the possibilities which have been realized in all living things that have since come from that life.

76. Growth of the Cell.—The two daughter cells resulting from cell division, each precisely similar to the parent cell except in size, grow and tend ultimately to reach the same size as the parent cell. This involves growth in all portions of the cell, and being growth by intussusception it is accomplished by the slipping in of particles of new material among particles already definitely arranged. Thus the organization, which is the central fact in protoplasm and is behind all life phenomena, is passed on unchanged.

CHAPTER XII

FORMS OF ANIMALS

Animals of various kinds seem to present a great variety of forms, but when these are carefully studied it becomes possible to recognize a small number of distinct types.

77. Asymmetry.—*Symmetry* is regularity of form and involves the existence of corresponding parts. In the case of some animals, particularly the more simple ones, there seems to be no symmetry; this condition is termed *asymmetry*, and the animals are spoken of as being asymmetrical (Fig. 19).

78. Spherical, or Universal, Symmetry.—An ideal form of symmetry which is rarely approached in nature would be a form in which an indefinite number of planes might be passed through the center of the animal and each plane exhibit a structure precisely similar to that of every other, as well as dividing the animal into symmetrical halves. This is termed *spherical, or universal, symmetry*. This is most nearly attained in some of the one-celled animals (Fig. 28 D).

79. Radial Symmetry.—Another form of symmetry which is presented by many of the lower many-celled animals is one in which the body can be divided by a number of radial planes into parts that are similar to each other. This type of symmetry is termed *radial symmetry* and the parts, since they are opposite around the center, are termed *antimeres* (Fig. 101).

80. Bilateral Symmetry.—Other animals are capable of being divided by a single median plane into similar right and left halves, the one being a mirror image of the other. This is termed *bilateral symmetry* and is characteristic of higher forms.

81. Metamerism.—Many bilaterally symmetrical animals have a body which is not divided into similar parts other than the right and left halves. Others, however, including the highest animals, are divided into a series of parts arranged in a linear series which, because they are placed one behind another, are termed *metameres*, or segments, the condition being termed *metamerism*. If these metameres are, generally speaking, similar to each other, it is known as *homonomous metamerism*, which is well illustrated by the common earthworm or angleworm (Fig. 134). If, however, these parts are dissimilar, the condition is termed *heteronomous metamerism*; an example of this type is the crayfish (Fig. 152), in

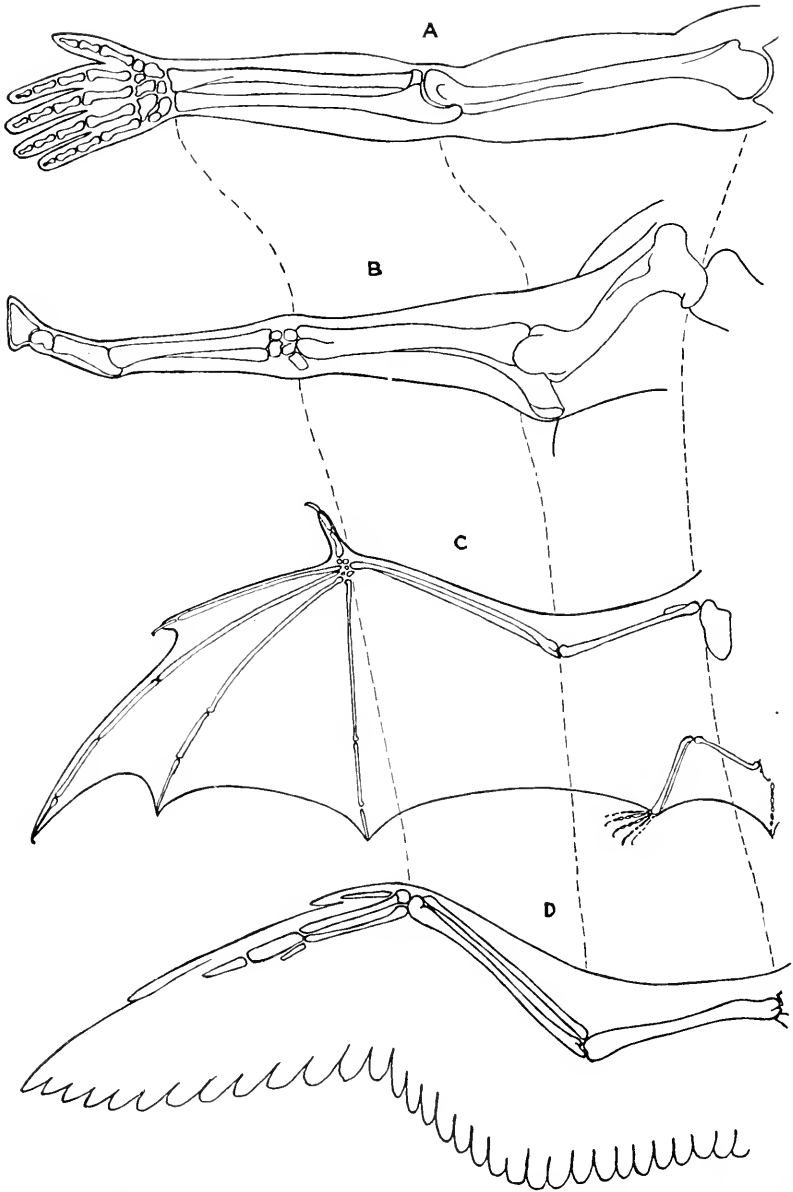

FIG. 13.—Outlines of the fore limbs and their skeletons, of man (A), horse (B), bat (C), and bird (D), to illustrate homology. The dotted lines pass through corresponding joints.

the case of which different metameres bear different types of appendages, such as feelers, or antennae, mouthparts, and legs.

82. Appendages.—If the body possesses such structures as have just been named or others which might be added, these are termed appendages. An *appendage* may be defined as a projecting part, capable of movement and performing some active function. Immovable horns, spines, hairs, and scales are not termed appendages, but movable spines, tentacles, legs, wings, and tails could all be recognized as such.

83. Homology and Analogy.—

Whenever parts of the body, whether in the same or in different animals, are similar in plan of structure, they are termed homologous and the condition is referred to as *homology*. This usually involves similarity in origin and in mode of development. Whenever parts which are structurally or morphologically different in plan perform the same function, they are analogous, and the phenomenon is referred to as *analogy*. Thus the foreleg of a horse, the arm of a man,

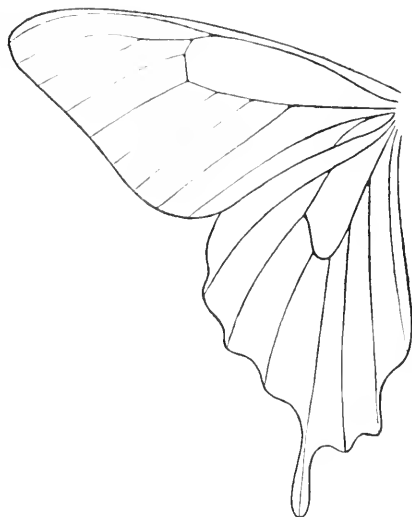

FIG. 14.—Outline of the wings of a butterfly and the veins in them, for comparison with *D*, Fig. 13, to illustrate analogy.

the wing of a bat, and the wing of a bird are all homologous parts (Fig. 13). This homology concerns not only the division into segments which correspond to upper arm, forearm, wrist, and hand but also involves the skeleton, muscles, blood vessels, and nerves. The wing of a bird and the wing of a butterfly, however, possess nothing in common structurally but perform the same function, and the case is recognized as one of analogy. The wing of a butterfly (Fig. 14) is formed by an outfolding of the surface layers of the body wall, mostly of the skin, becomes jointed at the point of attachment, and is moved by muscles within the body. Since all likeness may be expressed in varying degrees, homology and analogy can be spoken of as being more or less complete or perfect.

CHAPTER XIII

BEHAVIOR

By *behavior* is meant the sum total of an animal's movements. Nothing else can be included in behavior, since only by the movement of the body as a whole or of some part of it can an animal convey any indication of change within it. This also holds true with human behavior, since posture, facial expression, speaking, or any other mode of communication all involve movement. The movement of animals when involving no change in location of the animal is termed *motion*, but when change in location occurs it is *locomotion*.

84. Stimuli.—All movement is referred to some cause, either outside the animal or within it, which is termed a *stimulus*. If the cause is purely external the phenomenon is called external stimulation; if, on the other hand, the cause exists within the body of the animal, it is recognized as internal stimulation. The stimulus initiates a change, chemical and physical, within a part or whole of the animal which results in either motion or locomotion and which is called a *response*. External stimuli are either continuous or discontinuous. The first application of a *continuous stimulus* produces a movement, while the continuation of that stimulus, if it is maintained at the same intensity, has no effect. When the operation of the stimulus ceases, movement is again observed. A *discontinuous stimulus* may be looked upon as a series of similar stimuli each of which produces the appropriate response on the part of the animal, both when it begins and when it ends. Since the response takes a certain length of time, discontinuous stimuli, if following each other with sufficiently brief intervals between them, may produce a continuous effect. An example is the production of a tetanic, or prolonged, muscular contraction by a discontinuous electrical current.

85. Direct Response.—If the response which the animal gives immediately follows the application of the stimulus and seems to be determined by the nature and force of the stimulus, the response is termed direct and is called a *tropism*. Two words have been used in this connection: *tropism*, which means simply a turning, and *taxis*, which implies movement of the animal as a whole in response to the stimulus. Since the difference between these two is one determined by the locomotor ability of the organism, the word *taxis* has given way to the more general term *tropism*.

Tropisms are named with respect to the stimulating agent. The following are generally recognized:

1. *Thigmotropism*, or response to contact.
2. *Thermotropism*, or response to temperature.
3. *Phototropism*, or response to light.
4. *Chemotropism*, or response to chemical stimulation.
5. *Rheotropism*, or response to mechanical currents.
6. *Electrotropism*, or response to currents of electricity.
7. *Geotropism*, or response to the force of gravity.

Animals in nature are subject to all of these forms of stimuli except that of the electric current, which is purely an artificial stimulus.

If the response is such as to cause the animal either to turn toward the source of stimulation or to approach it, it is termed a *positive response*. If, however, it is such as to cause the animal to turn away from the source

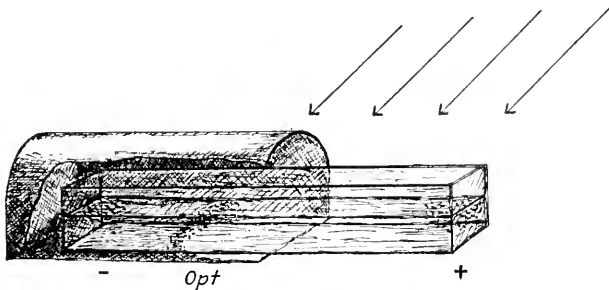

FIG. 15.—Sketch showing a long, rectangular glass aquarium partly covered by an opaque hood, and containing organisms responding positively and negatively to light, and to an optimum. The direction of the light is shown by the arrows and the positions assumed by the animals at + (positive), - (negative), and opt. (optimum).

of stimulation or to avoid it, it is termed a *negative response*. The minimum strength of the stimulus which is necessary to produce an effect is termed the *threshold* of stimulation.

Some animals do not seem to respond positively either to the strength of the stimulus immediately above the threshold or to a maximum strength of the stimulus but do seem to be attracted to a position in which they receive the stimulus in a degree intermediate between the maximum and minimum. In this case they are said to exhibit a response to an *optimum* of the stimulus, corresponding to a certain strength expressed in degrees of temperature, intensity of light, or strength of chemical solution (Fig. 15).

86. Conductivity.—Though the stimulus may be received at a particular point on the animal, the effect is not limited to that point but is conducted more or less throughout the body. This power of living matter to transmit the effect of the stimulus is termed *conductivity*. Irritability, or reactivity, which is the power to respond to stimuli, as well as con-

ductivity, which is the power to transmit this effect, are both properties of living matter.

87. Part Played by the Nervous System.—In animals possessing no nervous system, behavior is summed up in the responses to stimuli or in the tropisms which the animal exhibits. In animals that possess a nervous system, the structure relations within the nervous system modify the responses in a variety of ways. Two or more cells are involved between the reception of the stimulus and the response, which accordingly is said to be indirect. The presence of the nervous system also makes possible more numerous and more varied effects due to internal stimuli. The result is the production of the complex forms of behavior characteristic of the higher animals.

88. Physiological State.—The character of the response which an animal will give to a stimulus is determined not only by the kind and strength of the stimulus but also by the condition of the animal and depends upon the state of the metabolic processes within its body. Thus a one-celled animal in the body of which there is no food, which is hungry, and which is at the end of a cycle of metabolism may give a response different from that of an animal which has recently fed and in the body of which the metabolic cycle has just begun. In higher animals different parts contribute to the physiological state of the whole. Animals which possess a nervous system exhibit physiological states dependent upon the varying conditions of that system, which in turn have a metabolic basis. Repeated and abnormal stimulation may throw an animal into a condition of excitement in which it acts in a manner quite unusual. The different feelings of which we are conscious at different times, the mental attitudes which dominate us, and our varying ability to carry on our different activities are all connected with different physiological states. Physiological states are back of what is called temperament, or mood, and explain one's ability to excel on one occasion and his inability to perform creditably on another. It is a certain physiological state resulting from a change in our ordinary routine which causes us to feel and act differently after a holiday or after an unusual experience. This explains "blue Mondays" and "off days." The word psychological is sometimes used instead of physiological when the nervous system is involved.

CHAPTER XIV

CLASSIFICATION AND NOMENCLATURE

Whenever one has to deal with a great many objects of varied character it becomes necessary to arrange them in such a manner that any additional object can at once be put in its proper place with respect to the others, that any particular object can at once be found, and that they may be referred to by groups. Such arrangement and grouping are called *classification*. It is imperative in the arrangement of a library and increasingly so as the library grows in size, is necessary in every mercantile establishment, and to a degree even desirable in the handling of objects in our homes.

89. Definition.—*Zoological classification* may be defined as the grouping and arrangement of animals in such a way as to facilitate reference to them. If this grouping is based only upon the place where animals live or upon their form and structure, without regard to any relationships which may exist, it is termed *artificial classification*. If, however, an arrangement is secured such as to bring out the degree of relationship, assuming all animals to be related and to have evolved from the living matter first developed upon this earth, it could be called a *natural classification*. The basis of zoological classification is essentially artificial, but in so far as knowledge permits, zoologists endeavor to make it natural.

90. Arrangement of Groups of Animals.—The groups into which animals are arranged present a graded series, beginning with the whole, leading through those of gradually diminishing extent, and ending with each particular kind, which is a collection of like individuals. Generally speaking, any particular group will contain several groups of the next lower rank. It is evident that the characteristics of any one group will involve details of structure less fundamental than those of the next higher group and that, on the other hand, the characteristics of any group will be only those in which all the lower groups contained in it will agree. The names of the most widely used of these groups, in order of rank, illustrated by reference to a particular species of animal, are as shown on page 58.

These group names in their plural form may be treated either as Latin or as English words, as, for example, phyla or phylums, and subphyla or subphylums; or they may be given only their Latin plural, as genera; or only their English plural, as in the case of all the other groups above. The word species is the same in both singular and plural forms.

Kingdom: Animalia (all animals)

Subkingdom: Metazoa (many-celled animals).

Phylum: Chordata (chordate animals).

Subphylum: Vertebrata (vertebrates).

Class: Mammalia (mammals).

Order: Carnivora (carnivorous mammals).

Family: Canidae (doglike carnivores).

Subfamily: Caninae (dogs and their relatives).

Genus: *Canis* (dogs).

Species: *familiaris* (the domesticated dog).

If the number to be handled in any group is very large, for convenience in classification groups are introduced between those given. A common method is by the addition of the prefix sub-, by which device, for instance, several subspecies may be included in a species. In a similar manner may be formed subgenera, subfamilies, suborders, subclasses, and, as given above, subkingdoms and subphyla. Another device consists of the introduction of words with the prefix super-, a superfamily being a group lower in rank than a subclass but one which includes several families. If these devices do not reduce the groups to convenient size, a variety of other words has been employed, such as *series*, *division*, and *legion*. It has been found in nature that many widely distributed and variable species can be divided into smaller groups based upon geographical range, color, form, and other characteristics, and these may be called *races* and *varieties*. Various aspects of classification will appear as the different animals which make up the animal kingdom are treated more in detail, and the whole subject will later be reviewed.

The names of the groups of animals above families vary in form, but the name of the family always ends in *-idae* and that of a subfamily in *-inae*. In each case the name of the family or subfamily is derived from that of the genus in that family or subfamily which is taken as the type genus, the names *Canidae* and *Caninae*, for example, being both derived from the name *Canis*. The names of groups higher than the genus are always written with a capital initial letter when used in a taxonomic sense but are not italicized. Generic names are capitalized and usually italicized, while specific and subspecific names are italicized but not capitalized.

91. Nomenclature.—In order that each animal shall have a distinctive appellation and that this may be the same throughout the world, it is necessary to avoid common names, which differ in different localities and often have a very uncertain application, and also to use a language which is the common language of scholars everywhere. For this reason each animal bears a scientific name which is Latin in form, though it may not be in origin, and which includes the names of the genus and species to which the animal belongs. For the purpose of exact reference, and since different authors may have referred to different species under the same name, to the generic and specific names is added the name of the

individual whom we recognize as the original authority for the name used. Thus the scientific name of the dog is written *Canis familiaris* Linnaeus, since Linnaeus bestowed this name upon this particular species. The name of the author is not italicized. If the form of the name is not the exact one the author used, his name is enclosed in parentheses. For example, the name *Sorex aquaticus* was given by Linnaeus to the common mole, but since it belongs to a more recently established genus, *Scalopus*, the name is written *Scalopus aquaticus* (Linn.). Authors' names are often abbreviated, as Linn. for Linnaeus. The name of the subspecies may be added to that of the genus and species, as *Scalopus aquaticus machrinus* (Rafinesque), the subspecies of the common mole found in the upper Mississippi valley. Sometimes the common name of an animal is also the scientific name of the genus, in which case the difference is shown by italicization and capitalization. For example, paramecium and hydra are the common names of animals belonging respectively to the genera *Paramecium* and *Hydra*.

PART II
PROTOZOA

CHAPTER XV

AMEBA

A SIMPLE PROTOZOAN

This animal may serve as a type of the more simple one-celled animals, which are themselves the simplest forms in the animal kingdom.

92. Occurrence and Appearance.—Amebas occur commonly in fresh water. There are also numerous marine forms. The fresh-water species may be collected in a great variety of situations, such as watering troughs, spring pools, dams, stretches in streams where the water runs over rocky ledges, and wherever there is abundant aquatic vegetation. They are found gliding over the surfaces of submerged plants and of algae-covered mud, rock, or plankton. One method which has been suggested for securing them is to collect a mass of pond weed, place it in a flat dish, and cover it with water. A brown scum which gathers on the water in a few days will be found to contain amebas if they were present in the pond from which the weeds were obtained. Not all appropriate habitats contain this animal, however, and one frequently has to search for a considerable time before coming upon a supply.

When found, amebas are in the majority of cases only to be discovered by the use of the microscope. The very largest specimens of *Amoeba proteus* Leidy, however, are visible to the eye as minute whitish dots when seen against a dark background. Under the microscope an ameba appears like a mass of colorless jelly, irregular in form, and, when active, constantly changing in outline. The generic name given to this animal is *Amoeba*, and under the rules of nomenclature it cannot be changed, but the common name is now quite generally spelled ameba.

93. Structure.—The animal (Fig. 16) owes the irregularity of its outline to the fact that from the surface of the main mass extend numerous and variously shaped projections known as *pseudopodia*. These are constantly varying in length and thickness and may at any time be entirely withdrawn.

An ameba has no cell wall but possesses an extremely delicate outer layer known as a *plasmalemma*. This is too thin to be seen even with higher powers of the microscope, but by the movement of particles on its surface it may be shown to exist. Below this is a clear layer of cytoplasm, the *ectoplasm*, much thicker than the plasmalemma but still forming a thin layer over the surface of the cell. Within this and forming the bulk of the body is the more granular *endoplasm*. The layer of ectoplasm is

relatively thickest at the anterior end and at the tips of the projecting pseudopodia and is thinnest at the side away from the direction in which the animal may be advancing. Within the endoplasm are seen numerous vacuoles and a nucleus.

The vacuoles are of three types: (1) *Food vacuoles*, which appear like colorless drops of water inclosing particles of food. They are spherical in form if the food particle is small and compact but assume somewhat the form of the particle if it is large and elongated in any dimension. Food vacuoles disappear with the egestion of the feces from the body. (2) *Water vacuoles*, which appear like perfectly transparent colorless drops

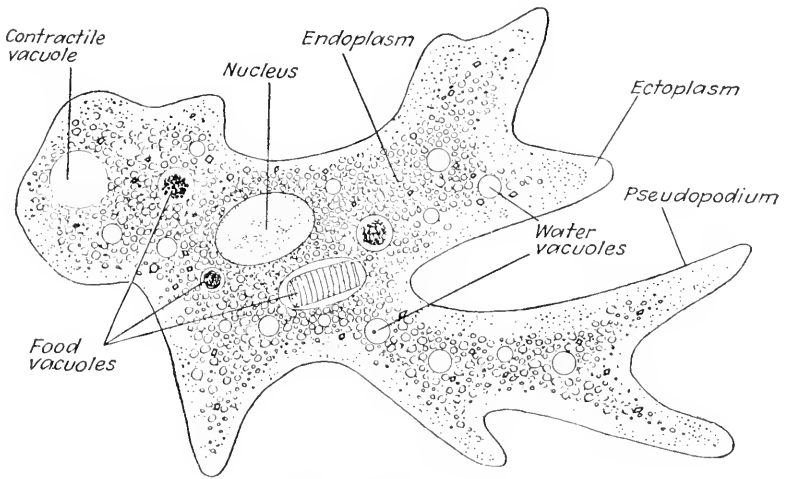

FIG. 16.—*Amoeba proteus* Leidy. $\times 1000$.

of a spherical shape. They do not change under observation. (3) *Contractile vacuoles*, of which there may be one or more and which appear like the water vacuoles. However, they change in size, gradually growing larger until they reach a maximum, when they suddenly contract and disappear, the process being regularly repeated. Because of this alternate filling and contracting these are sometimes known as pulsating vacuoles. They may sometimes be recognized by the possession of a faint pinkish tint. Throughout the endoplasm may be seen numerous granules of varying shapes and sizes, including crystals, whose nature can be determined by their crystalline form; and foreign substances, like bits of sand.

Somewhere within the endoplasm, and usually nearer the end away from that which is advancing, is the *nucleus*. It is finely granular in texture, homogeneous in appearance, and refractive to light, which gives it a brighter or clearer appearance than the surrounding endoplasm. It also frequently has a faint bluish color.

94. Metabolism.—The food of an ameba consists of minute aquatic plants and animals, though it will attempt to engulf any organism which it can surround. Small bits of organic matter are also taken in, but inorganic particles seem to be rejected unless they are accidentally taken in with a bit of food.

Ingestion takes place (Fig. 6) with the formation of pseudopodia. These envelop the food, which thus becomes completely inclosed in the body. With the food is taken in a certain amount of water and so a food vacuole is formed. Into this vacuole is secreted hydrochloric acid, which gives to its contents an acid reaction. An enzyme which acts on proteins is then added and the reaction becomes alkaline. No enzyme acting on carbohydrates has been demonstrated, and the same must be said for one acting on fats. As digestion proceeds, the digested and dissolved food is passed into the fluid of the food vacuole, whence it is absorbed into the surrounding protoplasm. It is then circulated to all parts of the body and assimilated wherever needed. Dissimilation also takes place everywhere in the body, the digestive secretions being passed into the food vacuoles and the excretions into the contractile vacuole. This, contracting at intervals, expels the excretions from the body, thus accomplishing elimination. After all that is digestible of the food has been removed from it and absorbed, the undigestible residue, or *feces*, is permitted to pass out through the wall of the body, the animal simply flowing away and leaving it behind. This is egestion.

Respiration takes place everywhere through the body surface, but the carbon dioxide may also be expelled through the contractile vacuole. A continuous supply of oxygen is necessary for the life of the animal. If an excess of food above the immediate needs is taken in, growth occurs by intussusception and the animal gradually increases in bulk. Food may not be immediately assimilated and undoubtedly some of the granules present in an ameba which is well fed represent unassimilated or stored food. Some of the crystals seen in the animal appear to be excretions.

95. Locomotion.—Locomotion in the ameba is accomplished by means of the *pseudopodia*, which are temporary locomotor structures. Many theories have been given to account for the manner in which pseudopodia are formed and the way in which they effect locomotion. Their formation has been attributed to a lessened surface tension at the points where they are formed or to an increased surface tension elsewhere. The freshly formed pseudopodium has been described as adhering to the substratum, the force of adhesion becoming a maximum at the extreme tip. However, the most careful and detailed description of locomotion in the ameba has recently been furnished by Mast. According to him the body of the moving ameba is divided into four parts: the *plasmalemma*, which is very thin and elastic; the clearer *ectoplasm*; the *plasmagel*, which is the

outer motionless part of the endoplasm; and the *plasmasol*, which is the central moving portion of the endoplasm. This is shown in Fig. 17, which represents a simple type with one pseudopodium to which also the following description applies. The plasmalemma is quite permanent and is stationary over that part of the surface in contact with the substratum, to which it adheres. At the side of the animal away from the advancing pseudopodium, the plasmalemma is being carried upward and over upon the upper surface; on this surface it is being carried forward; at the tip of the advancing pseudopodium it is moving downward; and it is laid down against the substratum in advance of that portion which is temporarily stationary and of which it now becomes a part. Through the center of the animal is a forwardly directed flow of plasmasol, which as it approaches the advancing tip turns to the side and becomes plasmagel.

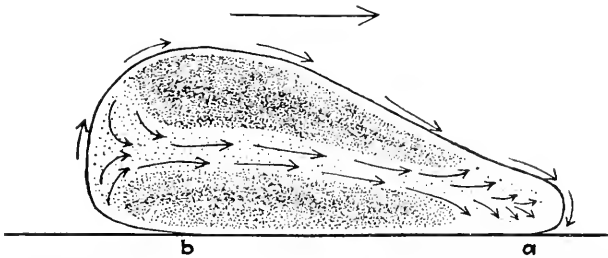

FIG. 17.—Diagrammatic representation of a simple amoeba, such as *Amoeba verrucosa* Ehrenberg, viewed from the side and moving by the formation of a single pseudopodium. The arrows along the surface show the direction of movement of the plasmalemma, which is stationary against the substratum from *a* to *b*. The arrows within the body show the direction of flow of the plasmasol from the area of solution at the temporary posterior end to the area of gelation near the temporary anterior end. The arrow above the figure shows the direction in which the animal is moving.

The onflow of plasmasol continues, serving to push this tip forward more and more. At the other side, the plasmagel is continually becoming plasmasol and thus providing the material for the continued flow. The forward movement of the amoeba is accompanied by a continuous gelation and decrease in volume of the protoplasm toward the tip of the developing pseudopodium and a continuous solution and increase in volume of that at the opposite side. In the case of an amoeba with several pseudopodia, one or more may be developing in the manner described above, while others may be disappearing. The latter will exhibit solution toward the tip and a flow of plasmasol back through the center into the main body. The elastic plasmalemma will show extension or contraction in different directions as it becomes adjusted to the changing outline. There is a curious resemblance in the manner of functioning of the plasmalemma to the continuous metallic belt which forms the tread in a caterpillar tractor.

96. Behavior.—An amoeba exhibits reactions to various stimuli. To contact it responds positively if the contact is a gentle one but negatively

if it is forceful. When coming quietly in contact with food or with any indifferent object an ameba tends to increase the amount of body surface in contact, but when anything touches it at all violently it draws back and moves away. It avoids a strong light but does not seek darkness, so it selects an optimum. This reaction may be complicated by the effect of temperature when it is exposed to the rays of the sun. To chemicals in solution the response varies with the character of the chemical. To the normal constituents of the water in which the animal lives it is indifferent;

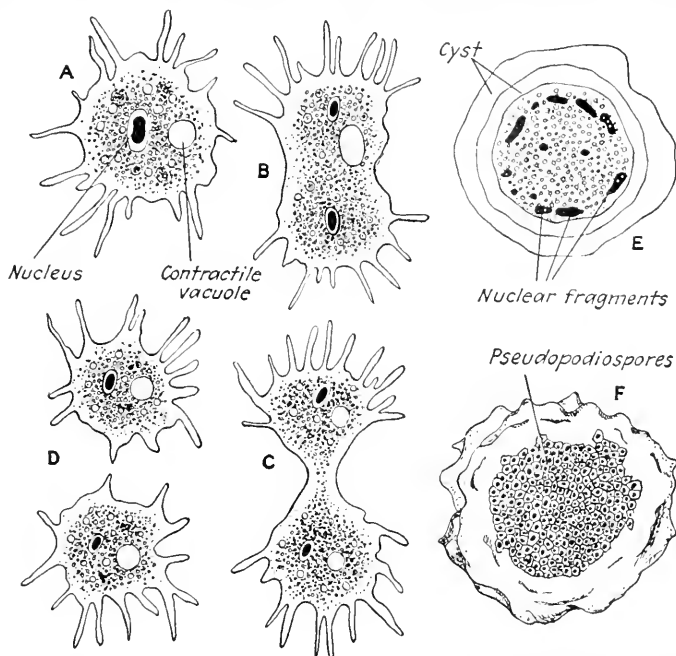

FIG. 18.—Fission and sporulation in *Amoeba*. Fission is illustrated in A to D, which represent four stages in fission in a European species. (Taken from Doflein, "Lehrbuch der Protozoenkunde," after F. E. Schulze.) E and F show sporulation in *Amoeba proteus*. (Also from Doflein, by the courtesy of Gustav Fischer.)

to substances which indicate the presence of food it responds positively, being thus brought to its food; to substances, however, which are not normal constituents of the water and which tend, therefore, to injure the ameba it responds negatively. Amebas have an optimum at a low temperature. Cold benumbs them as the temperature approaches the freezing point, while a temperature above 30°C. (86°F.) also retards their activities.

97. Reproduction.—At intervals amebas reproduce, doing so whenever they reach the limit of size, which in *Amoeba proteus* is about 0.25 mm., or 0.01 inch.

The ordinary form of reproduction is known as *fission*, or binary division. In this process the body elongates and a constriction appears in the

middle. The constriction gradually gets deeper and deeper, cuts through the nucleus, and passes entirely through the body of the animal. The ameba thus becomes divided into two individuals, each half the size of the parent and each with a nucleus half the size of that of the parent. Fission involves a very simple mitosis (Fig. 18 *A* to *D*).

Another form of reproduction is that of *sporulation*. This occurs only when conditions become unfavorable and is a means of carrying the animal over to a time when normal conditions are again reestablished. It occurs, therefore, when the body of water in which an ameba is living dries up and apparently comes about as a consequence of the increasing salt concentration of the water. It also occurs when the chemical composition of the water changes in any way so as to be unfavorable or when other environmental conditions threaten the death of the animal. In sporulation, the pseudopodia are first drawn in, and the animal assumes a spherical form; a three-layered cyst is then formed about the surface, which serves for protection (Fig. 18 *E*). Within the cyst the nucleus undergoes division into a great many fragments, and the cytoplasm becomes divided in such a way that a small amount surrounds each fragment of the nucleus. Thus are formed what are termed *pseudopodiospores* (Fig. 18 *F*). When the pond is again filled with water or when normal conditions are restored, the encysted mass takes up water, bursts its wall, and the liberated pseudopodiospores develop into little amebas.

CHAPTER XVI

PARAMECIUM

A MORE COMPLEX PROTOZOAN

The paramecium may serve as an example of a one-celled animal in which there is a considerable degree of specialization. Certain parts of the body are permanently modified for the performance of particular functions, a process generally known as division of labor.

98. Occurrence.—Paramecia appear in abundance in any water in which there is a considerable amount of decaying organic matter. They abound in streams and all bodies of water polluted by the entrance of sewage, feeding upon the bacteria which swarm in such water, and frequently appear in ameba cultures in which there is an accumulation of decaying animal and plant matter.

Since paramecia tend to gather at the surface and especially in contact with floating objects, they frequently form a white scum. They may, however, be found throughout the bodies of water in which they live.

99. Structure.—Paramecia (Fig. 19) are elongated in form and are frequently described as cigar-shaped, the anterior end being blunt and the posterior more pointed. Because the form is similar to that of a slipper, the anterior end representing the heel and the posterior the toe, they have been called slipper animalcules. A groove called the *oral groove*, or *peristome*, starts at the anterior end of the animal and runs obliquely backward from right to left or left to right, ending a little behind the middle of the body. If one were to conceive of himself looking at the paramecium from in front, this could be expressed by saying that the groove may run in a clockwise direction, which would be the direction corresponding to the direction of motion of the hands of a clock, or in a counterclockwise direction, which would be the opposite. In *Paramecium caudatum* Ehrenberg the groove usually runs clockwise, but in cultures in which this is the prevailing type others may be found. Occasionally a culture will appear in which the majority of the individuals show a counterclockwise direction. The body is covered with fine hairlike *cilia*, which in the species referred to are longer at the posterior end. Near the end of the oral groove is an opening known as the *mouth*. This leads into a *gullet*, which is a cleft running a short distance back into the cytoplasm.

Over the whole surface of the body is a colorless, elastic membrane known as the *pellicle*, or *cuticle*. This seems to be divided by raised lines

into a great number of very small hexagonal areas. From the center of each of these areas arises a cilium. Just below the pellicle is the clear and relatively firm *ectoplasm*, often called the *cortex*, which contains a great many spindle-shaped cavities placed with their longer axes at right angles to the surface. These cavities are filled with a semifluid substance and are known as *trichocysts*. They open to the outside along the lines which bound the hexagonal areas. The cilia are described as having an axial thread continuous with the cortex and a covering continuous with

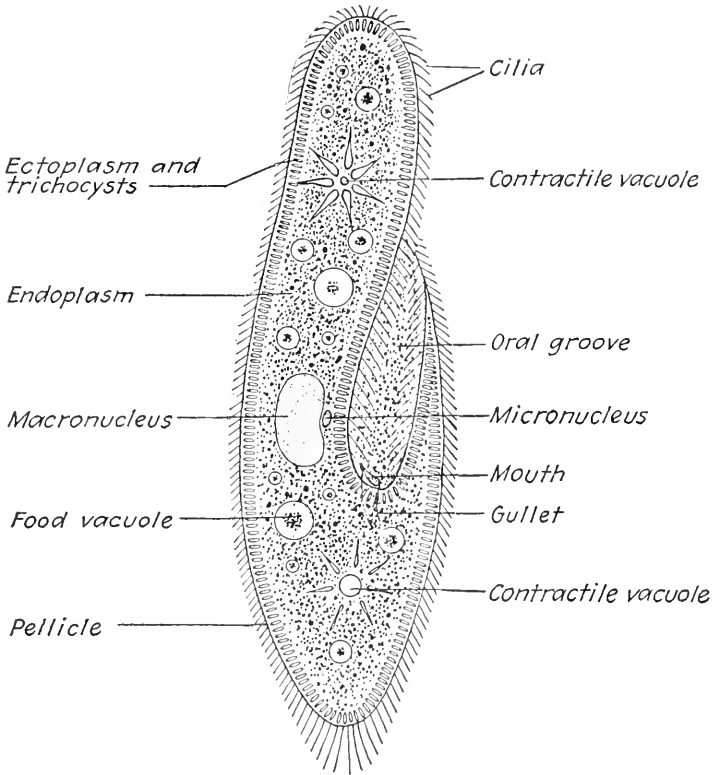

FIG. 19.—*Paramecium caudatum* Ehrenberg. $\times 400$.

the pellicle. The endoplasm contains *food vacuoles*, two *contractile vacuoles*, and numerous granular masses various in size, shape, and character.

The contractile vacuoles, one at each end of the body, lie between the ectoplasm and endoplasm and are made up of a central space surrounded by a system of radiating canals, from 6 to 10 in number. These radiating canals end blindly in the cytoplasm at the outer end and at the inner end empty into the central space, which in turn opens to the outside. After the central space becomes empty, the canals discharge their contents into it and then again gradually fill while the central space is being

emptied. The two vacuoles empty alternately at intervals of about 10 to 20 seconds.

Near the center of the animal or somewhat behind it, and not far from the mouth, is the *macronucleus*, which has somewhat the form of a lima bean, and a very much smaller *micronucleus*. The micronucleus is lodged in a depression on the surface of the macronucleus at a point which would correspond to the hilum of the bean, the place where the root comes out in germination.

100. Metabolism.—The food of paramecia consists of bacteria and minute forms of Protozoa. It is swept into the oral groove by the action of the cilia, carried back through the mouth, onward into the gullet, and finally passed into the endoplasm, where the food vacuole is formed. The passage through the gullet is effected by means of two or three *undulating membranes*, formed by rows of cilia placed side by side and fused. These food vacuoles are in constant circulation around the animal, following a definite course. Digestion takes place in the food vacuoles as it does in the ameba, and circulation, assimilation, and dissimilation are similar. Excretions are accumulated in the contractile vacuoles and eliminated through them to the outside. Expiration also takes place into the contractile vacuoles. Inspiration seems to be possible over the whole body surface. Egestion occurs at a particular point near the posterior end, where there is a potential opening through the ectoplasm known as the *anus*, or *anal spot*.

101. Locomotion.—Owing to the presence of the elastic pellicle, the body of the paramecium exhibits elasticity, which is not observed in ameba. It can force its way through a narrow passage, the body contracting as it does so, but on its exit from the passage it immediately assumes its normal shape.

Locomotion is effected by means of the cilia, which may beat either forward or backward and by means of which the animal swims in either direction through the water. Normally it moves forward. The cilia, however, do not beat directly backward but obliquely, so that the animal rotates on its long axis. The cilia in the oral groove also strike obliquely along the axis of the groove and

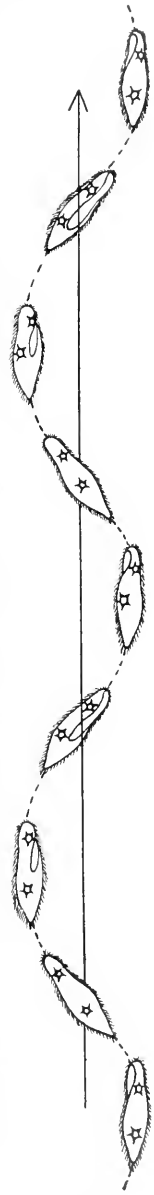

FIG. 20.

FIG. 20.—The spiral path followed by a swimming paramecium. (Modified from Jennings, "Behavior of the Lower Organisms," by the courtesy of Columbia University Press.) The rotation of the animal on its axis is indicated by the position of the oral groove. The large arrow shows the direction of motion, and the axis of the spiral.

produce a swerving. As a result of the combination of progression, rotation, and swerving, the animal follows a spiral path, the axis of the spiral being the direction of motion. This axis may be a straight line (Fig. 20). Thus the paramecium, which is asymmetrical, is enabled to pursue a direct course though it is unable to swim directly forward or backward.

102. Behavior.—Paramecia react to various stimuli in a manner somewhat similar to amebas, though apparently they are not affected

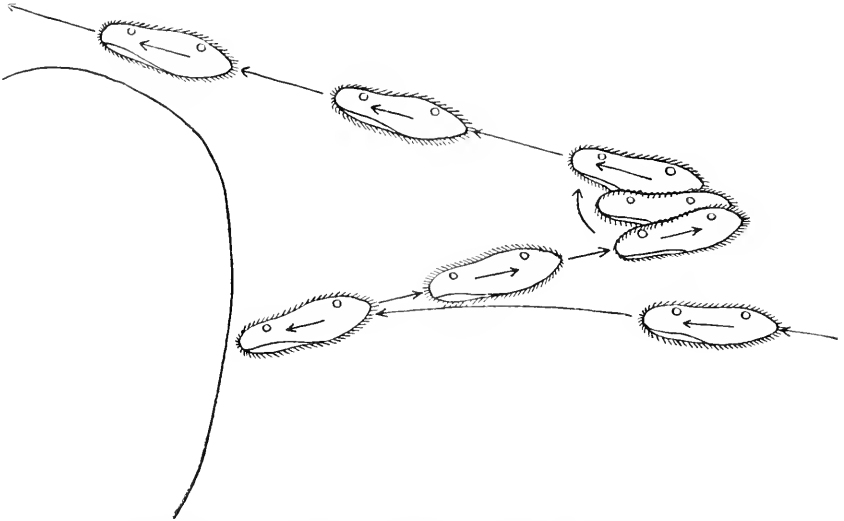

FIG. 21.—Diagram to illustrate the avoiding reaction given by a paramecium to a solid object. (Modified from Jennings, "Behavior of the Lower Organisms," by the courtesy of Columbia University Press.) The arrows between the successive positions represented indicate the path followed, and those drawn within the outlines of the animal the direction in which the animal is moving. The direction of movement is also indicated by the position of the cilia; no attempt has been made to show rotation by any other structural features.

by ordinary light. Their positive thigmotropism is seen in the tendency to come to rest against objects in the water. It is stated that for each chemical to which paramecia apparently give a positive reaction there is an optimum concentration in the region of which they tend to accumulate. The paramecium possesses a temperature optimum at about 26°C . (69°F .), or about the temperature of ordinary pond water in summer, when paramecia become most abundant. The animal possesses positive rheotropism, which leads it to swim against a current, or upstream. Paramecia also seem to respond negatively to gravity, tending to come to the top of the water in a vessel in which they are confined. The electric current affects the beating of the cilia, but this is not a natural stimulus, occurring only in the laboratory.

One mode of response of the paramecium is known as the "avoiding reaction," which takes place in the following manner: When a paramecium

comes in contact with a solid object, assuming it to be swimming at full speed forward, the force of the contact produces a negative response. The animal backs up, pivots upon its posterior end, and swims forward again. If it again strikes the object, it exhibits the same negative reaction, which is repeated until on swimming forward the animal passes the obstacle (Fig. 21). Though it is called an avoiding reaction, which would imply a consciousness on the part of the animal, all that it is doing is simply giving a series of negative responses. The term "avoiding reaction" thus gives rise to implications which are unwarranted, a fact usually indicated by inclosing the words in

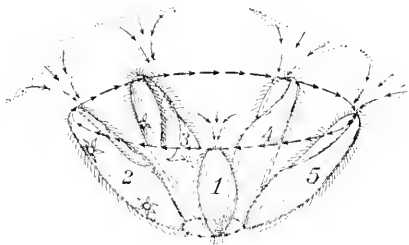

FIG. 22.

FIG. 22.—A paramecium shown pivoting upon its posterior end and sampling the water before starting off in a direction; which may be determined by the result of such sampling. (From Jennings, "Behavior of the Lower Organisms," by the courtesy of Columbia University Press.) The figures indicate successive positions and the arrows show the direction of movement.

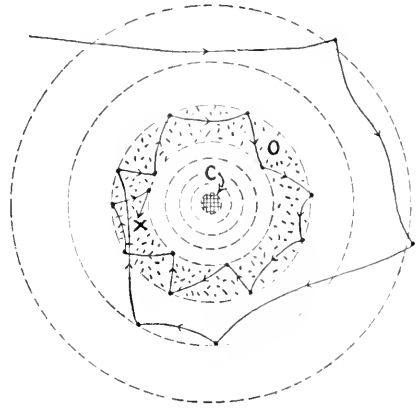

FIG. 23.

FIG. 23.—Diagram illustrating the method of trial and error in paramecium. (Modified from Borradaile and Potts, "The Invertebrata," after Kühn, by the courtesy of The Macmillan Company.) At the center is shown a soluble substance (C) which is dissolving and diffusing into the surrounding water. The circles represent zones of equal concentration, the zone O, in which protozoans, which might be paramecia, are gathered, being the zone of optimum concentration. The irregular line shows the path of a paramecium which enters the area involved and after repeated stopping, sampling, and change in direction, comes to rest in the zone of optimum concentration at x.

quotation marks. A slowly moving organism like an ameba would not exhibit such a response.

Paramecia also show what is known as the method of "trial and error," which implies a series of experiments on the part of the animal. A paramecium is constantly taking water into its oral groove with sufficient force to draw it from a little distance in front and to produce a cone of movement in the water. Thus it "samples" the water just ahead (Fig. 22). If the water is too hot or too cold or if it contains an injurious chemical substance, the animal gives an avoiding reaction. This may be repeated again and again. While paramecia seem to be swimming aimlessly through the water in all directions, the repetition of these avoiding reactions sooner or later brings them into that part of their environment which is most favorable (Fig. 23). The result

is the same as that seen in the "trial-and-error" mode of behavior of higher animals, and so this term is often applied to the activity of this and similar Protozoa.

Whenever a paramecium is responding to one stimulus it often will not be affected by another stimulating agent unless the second one is very strong. It has been found, however, that the response to gravity is always set aside whenever the animal receives any other stimulus.

The responses which paramecia give to stimuli are not always the same, the difference being due to the different *physiological states* of the animals. A paramecium which is fully fed tends to come to the surface and remain quiet in contact with some object, though the sources of its food supply may be, in a laboratory culture, at the bottom of the jar. When it becomes hungry, however, it reverses its responses, swims to the bottom, secures its food, and then once more seeks the surface. Thus one physiological state gradually becomes changed into another, and a definite rhythm is established in the animal's movements. It has been found that a response becomes more pronounced after it has taken place a number of times. This indicates a change in physiological state and shows an effect of one response upon succeeding ones which has been termed *summation of stimuli*.

When violently stimulated either by a chemical or by contact, a paramecium frequently responds by throwing out the contents of the trichocysts, which harden and form a barrier of fine threads. When the trichocysts are emptied, they are refilled by material which originates near the nucleus, probably from it, and passes through the endoplasm to the proper points in the ectoplasm.

103. Reproduction.—Paramecia reproduce only by *fission*, the animal being divided transversely into two. During this process both the macronucleus and the micronucleus divide, the old gullet divides into two, and two new contractile vacuoles arise by division of the old ones. The micronucleus divides mitotically, and perhaps the macronucleus does also. The entire process occupies from half an hour to two hours. Subsequent growth is rapid, and division occurs again after a number of hours. Paramecia multiply with great rapidity. It has been estimated that from one ancestor could be produced in one month, if all survived, a total of 265,000,000 individuals.

104. Conjugation.—At intervals occurs a phenomenon known as *conjugation* (Fig. 24). When this occurs, two paramecia come together, attached by the surfaces on which the oral grooves are located. The pellicle breaks down at the point of contact, as does also the ectoplasm, and an endoplasmic bridge is formed between the two animals. During this time the micronucleus of each conjugant moves from the concavity in the macronucleus, where it has been lodged, grows larger, forms a spindle, and divides. A second division follows immediately. Of the

four micronuclei thus produced three degenerate and disappear, and the fourth divides again, this time unequally. The smaller of the two micronuclei of each animal now moves over the protoplasmic bridge into

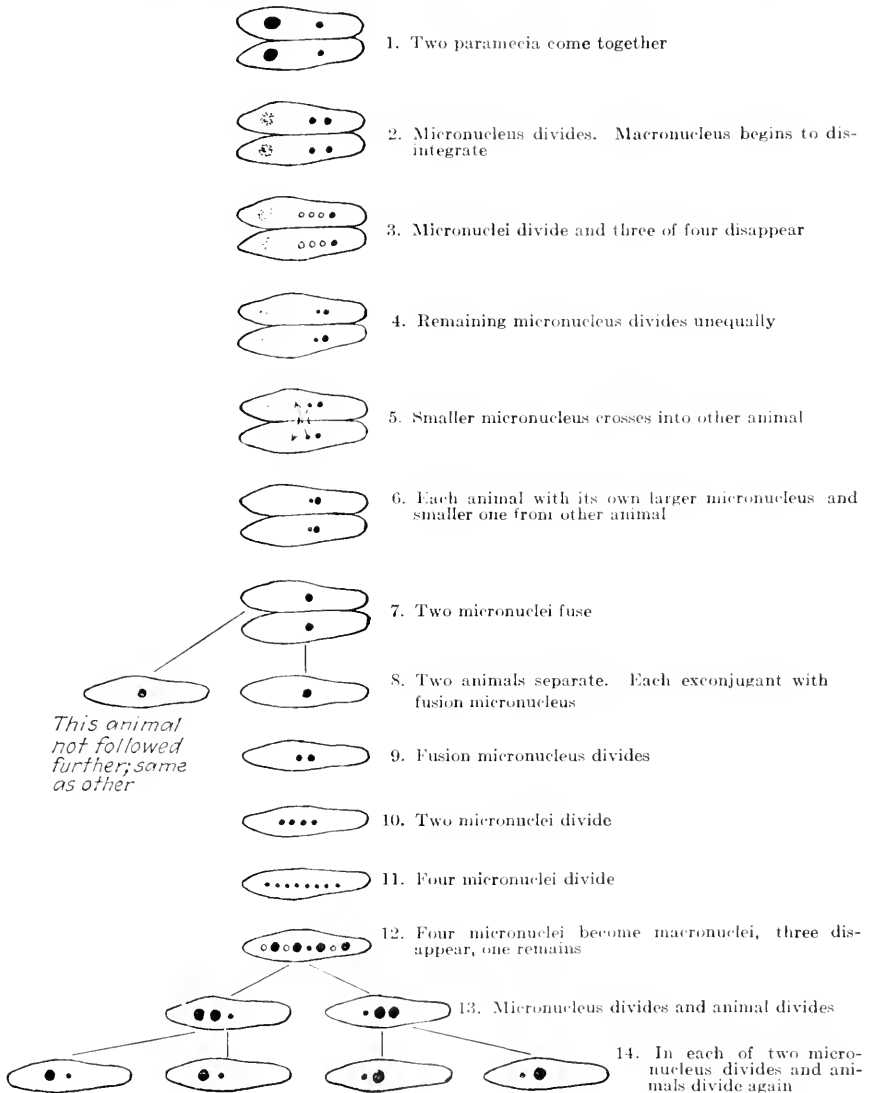

FIG. 24.— Diagram illustrating conjugation in *Paramecium caudatum* Ehrenberg. (Slightly modified from Jennings, "Life and Death, Heredity and Evolution in Unicellular Organisms," by permission.) Macronuclei are indicated by large black bodies, micronuclei by the smaller ones, and those micronuclei which disappear by small circles.

the other animal, passing the micronucleus from the other as it does so. Each of these micronuclei fuses with the larger micronucleus of the other animal, forming a fusion micronucleus. This process has been compared

to fertilization in higher animals which possess sex, the smaller micronucleus being viewed as male and the larger one as female. However, it cannot, properly speaking, be called fertilization, since no gametes are involved. The macronucleus begins to degenerate soon after the micronucleus leaves it, breaking up into fragments.

The two animals now separate and the fragments of the macronuclei slowly disappear, their substance being dissolved in the endoplasm. The fusion micronucleus in each of the exconjugants divides by mitosis into two, these into four, and these into eight, all equal in size. Four of

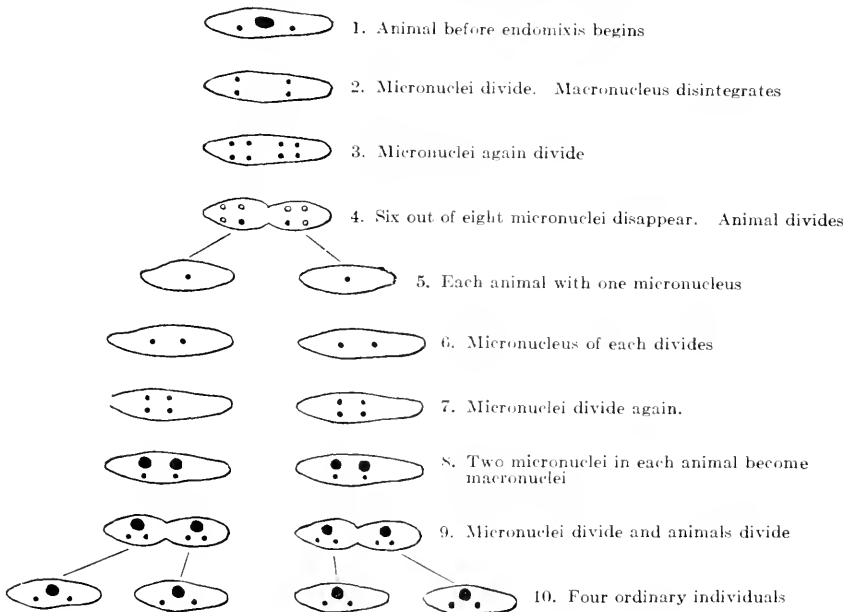

FIG. 25.—Diagram illustrating endomixis in *Paramecium aurelia* Müller. (From Woodruff, "Animal Biology," by the courtesy of The Macmillan Company.) Large black bodies are macronuclei, small ones micronuclei, and small circles micronuclei which disappear.

these then become larger and develop into macronuclei. Of the four remaining, three disappear. The fourth divides into two, and the animal divides, each of the two individuals formed having one micronucleus and two macronuclei. In each individual the micronucleus again divides and this is followed by fission, producing four animals each with one micronucleus and one macronucleus. This description applies to *Paramecium caudatum*; the steps in the process are variously modified in other species.

The significance of conjugation is uncertain. Some investigators believe that after a long series of fissions the animals become senescent and conjugation serves as a process of rejuvenation which restores their vitality. Woodruff, however, has succeeded in maintaining a culture since May 1, 1907, without conjugation. On the twenty-fifth anniversary

—May 1, 1932—the culture had attained the number of 15,300 generations. The significance may be in the determining of inheritance. The scrapping of the old macronucleus and the development of a new one from the fusion micronucleus suggest the need of harmonious direction of activities in an animal differing from the conjugant parent by nuclear material received from the other conjugant.

105. Endomixis.—An interesting phenomenon analogous to conjugation, but taking place within a single individual, has been observed in *Paramecium aurelia* Müller (Fig. 25). This species possesses two micronuclei, exhibits a definite rhythm in the rate of division, and periodically undergoes what has been called *endomixis*. During the process the macronucleus breaks down and disappears and the micronuclei undergo two divisions, producing altogether eight micronuclei. Six of these disintegrate and disappear. The paramecium then divides and each of the offspring receives one micronucleus. This micronucleus divides into two and these divide again, producing four. Two of these develop into macronuclei and two remain micronuclei. The micronuclei divide again and the entire animal divides, resulting in two, each with two micronuclei and one macronucleus. Four individuals have thus been produced. This process also occurs in *Paramecium caudatum* and in other forms. The result of endomixis may be the same as that of conjugation.

CHAPTER XVII

PROTOZOA IN GENERAL

The phylum Protozoa (prō tō zō' ā; G., *protos*, first, and *zoon*, animal)¹ includes all one-celled animals, the one cell which forms the body of the individual carrying on in simple fashion all of the general functions which are performed by the many-celled bodies of higher animals. This means that though the animals included in Protozoa are simple in that they are composed of only one cell, this cell is physiologically complex. Some of the Protozoa always exist as single cells. Others are associated in colonies in which they are all alike and each quite independent. In other protozoan colonies, however, certain functions, such as reproduction, are assumed by certain cells, which thus become reproductive individuals.

106. Classification.—Protozoa is the first phylum of the animal kingdom, but, since all other phyla have characteristics which they share and which distinguish them from Protozoa, it may be considered also as a group of higher rank than a phylum. In this case it becomes a subkingdom, with the same name, coordinate with the subkingdom Metazoa, which includes all the remaining phyla.

Protozoa may be characterized as composed of animals existing as single cells. In the case of certain types these one-celled individuals are associated in colonies.

The phylum is usually divided into four classes, each characterized by a distinctive locomotor structure or, in one class, by the absence of any such structure in the final stage of the animal. These classes are:

1. *Mastigophora* (mäs tī gōf' ō rā; G., *mastix*, whip, and *phoros*, bearing), or *Flagellata* (flă gěl lă' tā).—Have a limited number of long whiplike locomotor appendages known as flagella.

2. *Sarcodina* (sär kō dī' nā; G., *sarkodes*, fleshy), or *Rhizopoda* (rī zōp' ō dā; G., *rhiza*, root, and *podos*, foot).—Form pseudopodia, which are temporary structures developed from the surface of the body and which can be withdrawn.

3. *Sporozoa* (spō rō zō' ā; G., *spora*, seed, and *zoon*, animal).—Possess no locomotor structures in the final stage, though they have them in the earlier stages of their life histories.

¹The vowel sounds indicated in the pronunciation of this and other phyla and class names are described at the beginning of the Glossary (p. 557). In all cases where the nominative form of a Latin or Greek word does not contain the full root, the genitive is given, as, for instance, *podos*, genitive, instead of *pous*, nominative, for the Greek word for foot. If a word comes from the Greek through the Latin, the Greek is given.

4. *Infusoria* (in fū sō' rī à; L., *infusus*, poured into, crowded), or *Ciliata* (sīl ĭ ā' tã).—Have a very large number of permanent small hair-like appendages known as cilia.

By some authorities a fifth class is recognized which is called *Suctorina*. In the classification adopted here this is considered a subclass of the Infusoria.

107. Mastigophora.—A type of this class is the euglena (Fig. 26), a small greenish protozoan living in bodies of fresh water. This animal agrees with the paramecium in possessing, in addition to the ectoplasm and endoplasm, an elastic cuticle, which is striated. On the anterior end is a single long slender *flagellum* connected with a granule within the body known as a *blepharoplast*. This term is applied to any granule in a cell with which a cilium or flagellum is connected. The *mouth* is at the base of the flagellum. A permanent vesicle, the *reservoir*, into which several *contractile vacuoles* pour their contents, opens into the *gullet*. Close to the reservoir is a mass of red coloring matter called the *stigma*, or eyespot. It is, of course, not an organ of sight, though it is thought to be sensitive to light. Near the center of the body is a *nucleus*, and scattered through the protoplasm are many bodies of bright green color called *chromatophores*.

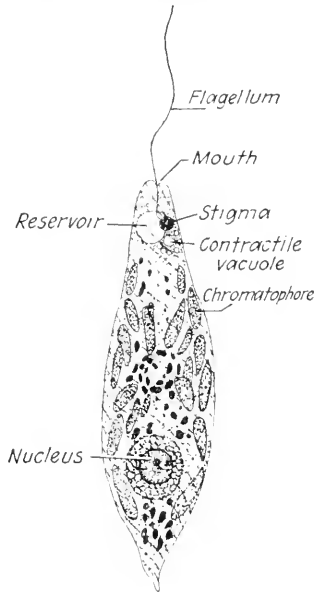

FIG. 26. *Euglena viridis* Ehrenberg. (Slightly modified, from Doflein, "Lehrbuch der Protozoenkunde," by the courtesy of Gustav Fischer.) $\times 800$.

Euglena is a type which possesses some of the characteristics of plants. Other members of this class show these to such a degree that they are by botanists considered plants and classified by them as such. A plantlike characteristic is the ability, by means of chlorophyll in the chromatophores, to manufacture part of its own food. This type of nutrition is known as *holophytic*, in contrast with the type which characterizes animals generally, which involves the ingestion of solid particles of organic food, and which is called *holozoic*. This resemblance to plants justifies their being considered the first class of the Protozoa. Many zoologists place Sarcodina first, believing them the simplest structurally.

Euglena illustrates particularly well a reaction to an optimum stimulus. When placed in a vessel, one end of which is lighted and the other darkened, the animals gather neither at the light nor at the dark end but in a zone between the two where the optimum of light for this animal is found.

The Mastigophora (Fig. 27) are divided into two groups: (1) Those which are animal-like and which may be holozoic, saprophytic, or entozoic. *Saprophytic* implies the absorption of nonliving organic matter in solution directly through the surface of the body. *Entozoic* means living within the bodies of other animals. Such species live in the intestinal tract or blood stream of man or in the intestines of insects. (2) Those

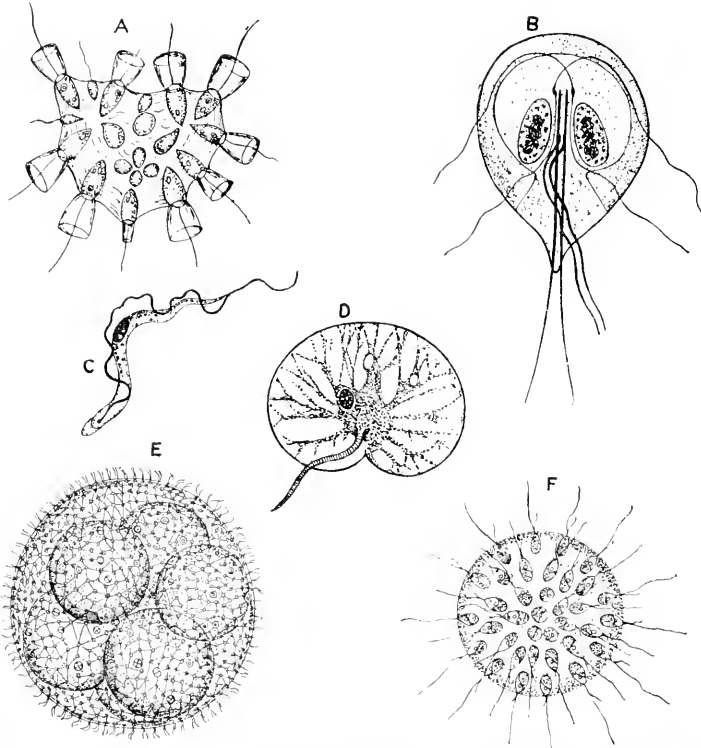

FIG. 27.—Several different species of Mastigophora. A, *Proterospongia hacckli* Kent. (From Kent, "A Manual of the Infusoria.") $\times 530$. B, *Giardia lamblia* Stiles. (After Wenyon, in *Archiv für Protistenkunde*, Suppl. I.) $\times 2200$. C, *Trypanosoma gambiense* Dutton. (From Wenyon, "Protozoology," by the courtesy of William Wood & Company.) $\times 1330$. D, *Noctiluca scintillans* (Macartney). (From Kent.) $\times 40$. E, *Volvox aureus* Ehrenberg. (From Doflein, "Lehrbuch der Protozoenkunde," after Klein, by the courtesy of Gustav Fischer.) $\times 110$. A colony containing six daughter colonies, developed from parthenogonidia. F, *Uroglenopsis americana* (Calkins). $\times 350$.

which are more plantlike and which may be holophytic, saprophytic, or entozoic.

An interesting form is the genus *Proterospongia*, which is a colony of individuals each bearing a flagellum and around it a protoplasmic collar. Another form, known as *Giardia*, the structure of which is quite complex, lives in the small intestine of man. These are both animal-like, as is also *Euglena*.

Among the plantlike types are several of interest, including *Uroglena*, found in reservoirs and imparting a peculiar oily odor and fishy taste to the water. Another form is *Volvox*, a very beautiful colonial animal—or plant—which lives in fresh water and which may consist of many thousands of cells. As it swims the spherical colony revolves, the motion

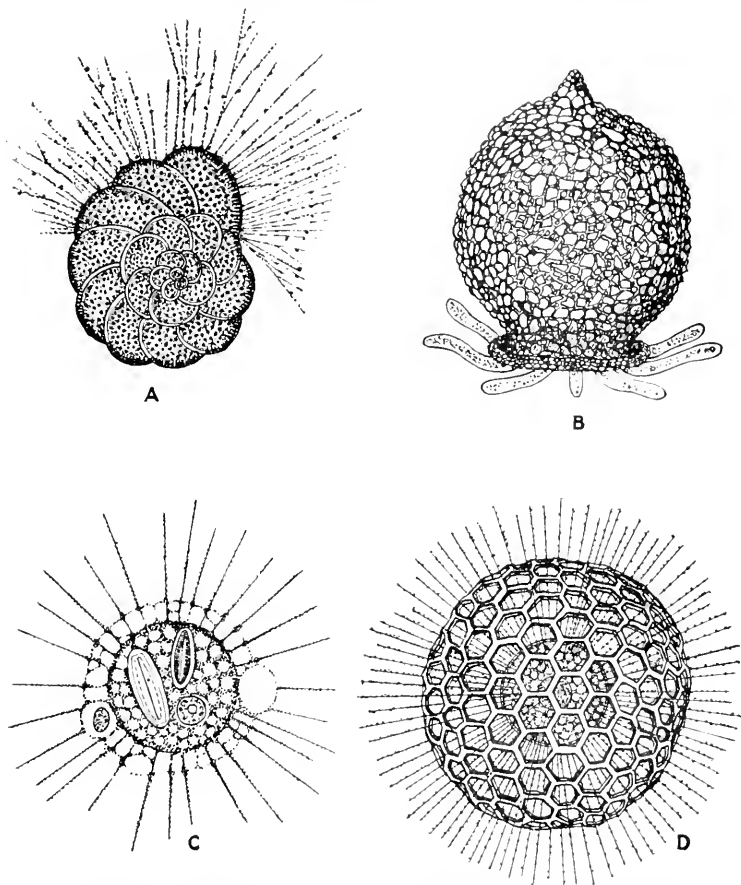

FIG. 28.—Different types of Sarcodina. A, *Rotalia freyeri*. (From Doflein, "Lehrbuch der Protozoenkunde," after Max Schultze, by the courtesy of Gustav Fischer.) An example of the Foraminifera. B, *Difflugia urceolata* Carter. (From Leidy, "Fresh-water Rhizopods of North America.") $\times 167$. The shell is composed of sand grains. C, *Actinosphaerium cichorni* Ehrenberg. (From Kudo, "Handbook of Protozoology," by permission of the publisher, Charles C. Thomas.) $\times 40$. One of the Heliozoa. D, *Heliosphaera incermis* Haeckel. (From Bronn, "Klassen und Ordnungen des Tierreichs," after Haeckel.) $\times 350$. One of the Radiolaria. The skeleton forms a lattice work on the surface of the body.

being due to the combined action of all the flagella. Still another example is a marine form known as *Noctiluca*. This animal frequently collects on the surface of the sea in enormous numbers, the jelly-like bodies forming a thick scum which has the color and appearance of thick cream-of-tomato soup and which sometimes covers an area of many acres. At

night, and when stimulated, these bodies are luminescent, giving to the water a pervading greenish white or bluish white light.

108. **Sarcodina.**—Sarcodina (Fig. 28) include not only the ameba but also many other similar forms, some of which are parasitic. A number of them secrete an external shell of chitin, cellulose, lime, or silica, or

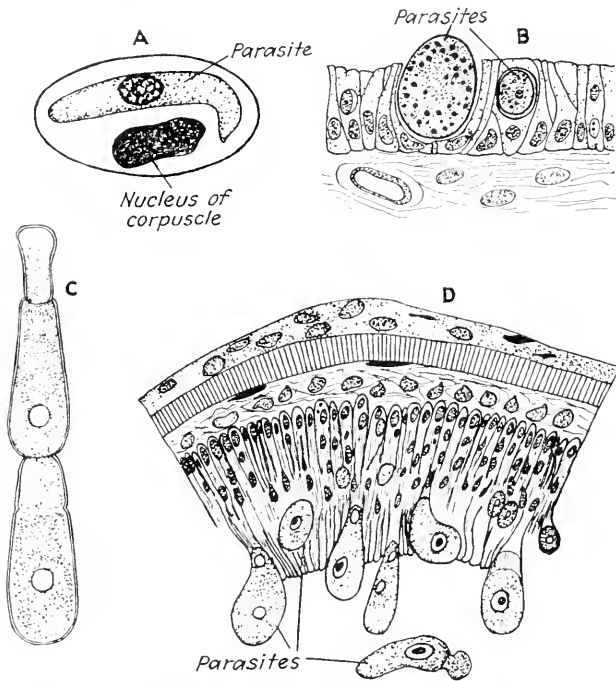

FIG. 29.—Examples of Sporozoa. A, a hemogregarine in the red blood corpuscle of a frog. (From Heyner and Taliaferro, "Human Protozoology.") $\times 550$. B, section through the intestinal epithelium of a rabbit, showing infection with one of the Coccidia, *Eimeria stiedae* (Lindemann). (From Doflein, "Lehrbuch der Protozoenkunde," after Thoma.) Highly magnified. C, *Gregarina blattarum* Siebold, from the digestive tract of the cockroach. (From Doflein, after Hertwig.) $\times 60$. Shows an endwise union of two individuals, a union which occurs commonly and is known as syzygy. D, section through the intestinal wall of a meal worm (the larva of a beetle), infected with *Gregarina polymorpha* (Hammerschmidt). (Also from Doflein, after Pfeiffer.) Highly magnified. Immature parasites in different stages of development are seen in the epithelium lining the intestine and one mature individual in the lumen of the canal. (A by the courtesy of The Macmillan Company; B, C, and D by that of Gustav Fischer.)

they build one of particles of sand and other foreign objects held together by one of these substances.

Interesting members of this class are the Foraminifera, which are mostly marine and which form shells of lime composed of numerous chambers united by openings called foramina, whence the name of the group. They occur in enormous numbers and exhibit great variety. When the shells of dead individuals sink to the sea bottom they form a soft mud or ooze, known as foraminiferous or Globigerina ooze, which, when solidified, becomes natural chalk.

Another group is Radiolaria. These have a central perforated capsule of chitin and a larger inclosing shell of silica. They also are marine, existing in great numbers in the ocean, and when their shells sink to the bottom they form what is known as radiolarian ooze. When solidified this produces a rock of the nature of flint. These rocks occur in strata several hundreds of feet in thickness.

Another group of Sarcodina found in fresh water have numerous slender, radiating pseudopodia containing axial threads of chitin. Because of the resemblance of the animal with these radiating pseudopodia to the sun surrounded by its rays of light, they are frequently termed sun animalcules, and the order to which they belong is called Heliozoa.

109. Sporozoa.—The Sporozoa (Fig. 29) in their early stages frequently are ameboid but in their final stages they lack locomotor organs and form spores. They are parasitic in other animals and are generally transmitted to the host in the spore form. In some cases the life of the individual ends upon the formation of spores but in other cases spores are produced at intervals during the animal's lifetime.

Among these forms are the gregarines, which exist within the cells of earthworms, cockroaches, and other insects as well as of other invertebrates and which in their later stages become free in the body cavities of these animals. Those of an order known as Coccidia are found in the liver and intestine of man and other vertebrates as well as in some invertebrates. Others are found in the blood or muscles of vertebrates or within the cells of fish. One form produces the silkworm disease known as *pébrine*. Pasteur discovered that this parasite is transmitted from the silkworm moth to the eggs before they are laid and that the caterpillars hatched from these eggs thus become infected. By showing how infection can be avoided he saved the silkworm industry of France at a time when its existence was seriously threatened.

110. Infusoria.—Infusoria (Fig. 30) occur in both fresh and salt waters, while others are found parasitic in the bodies of higher animals. *Paramecium* is an infusorian. *Opalina* is a form which lives in the intestine of the frog. In addition to cilia, infusoria frequently possess *undulating membranes* or *cirri*, formed by the fusion of numerous cilia. The body may be covered all over with cilia of approximately equal length, or it may have the cilia distributed over certain portions. The cilia are upon the ventral surface in a form known as *Stylonychia* and in a circle around the blunt end of the trumpet- or bell-shaped body in the forms known as *Stentor* and *Vorticella*. These cilia are sometimes varied in size and shape in the different parts of the body. Several types of Infusoria form branching, treelike colonies.

The Suctoria are attached animals the cilia of which are modified in such a way as to make tentacles of them. These have sucking discs at

the tip by means of which the suetorian captures other protozoans and passes them back to the mouth to be taken into the body.

111. General Facts.—Protozoa vary in size from minute blood parasites which are invisible or barely visible to the highest powers of the microscope to a gregarine, *Porospora*, which lives in the alimentary canal of the lobster and which may be 17 mm., or $\frac{2}{3}$ inch, in length. Most of

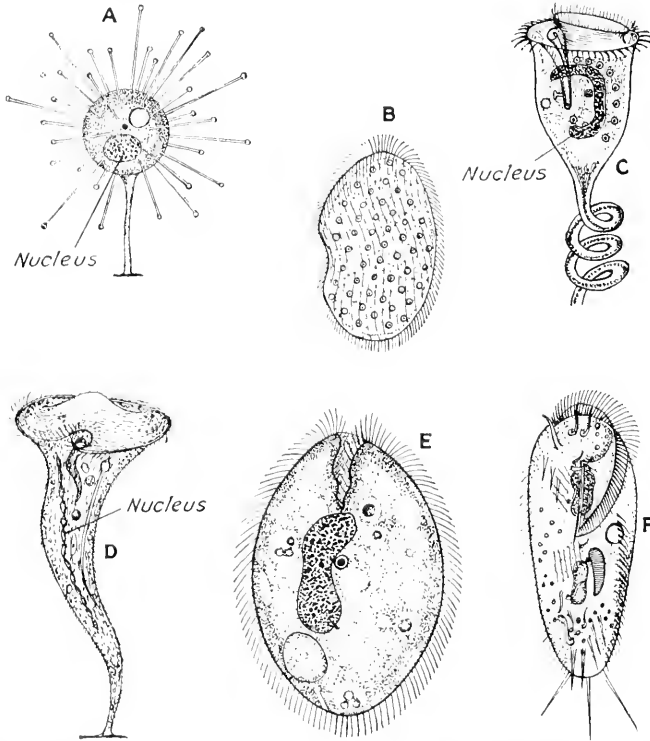

FIG. 30.—Some forms of Infusoria. A, a species of *Podophyra*. (After Bütschli, "Klassen und Ordnungen des Tierreichs.") To illustrate the Suetoria. Highly magnified. B, *Opalina ranarum* Purkinje. (From Kent, "A Manual of the Infusoria," after Zeller.) An infusorian parasite of frogs. $\times 80$. C, a species of *Vorticella*. (Modified from Hegner, "College Zoology," after Shipley and Macbride.) Showing a portion of the attachment stalk coiled. Highly magnified. D, *Stentor polymorphus* Müller. (From Kent.) $\times 60$. Attached individual. E, *Balantidium coli* Malmsten. (From Thomson and Robertson, "Protozoology.") $\times 400$. F, *Stylonychia mytilus* Ehrenberg. (From Kent.) $\times 100$. (C by the courtesy of The Macmillan Company; E by that of William Wood & Company.)

them are not visible to the unaided eye. The shapes of Protozoa are also exceedingly varied.

The cytoplasm of protozoans usually appears alveolar and is divided into ectoplasm and endoplasm. Sometimes the nucleus is scattered throughout the cell in small portions known as *chromidia*, when it is called a distributed nucleus. We have already noted that in certain cases there are two kinds of nuclei, the macronucleus and the micronu-

cleus. The former is believed to preside over the nutritive functions of the cell, the latter is active in cell division and transmits hereditary characters. This significance of the two seems borne out by the fact that after conjugation the old macronucleus disappears and a new one is formed from a micronucleus, which insures agreement in the hereditary

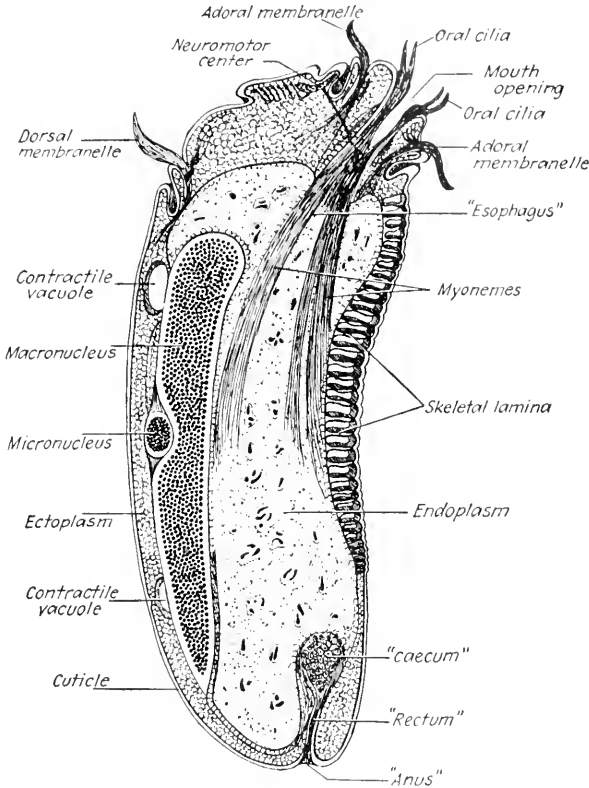

FIG. 31.—*Diplodinium caudatum* Fiorentini. (After Sharp, in *Univ. Calif. Pub. Zool.*, vol. 13, and by the courtesy of University of California Press.) An infusorian found in the stomachs of cattle, to illustrate the extreme of intracellular differentiation as exhibited by protozoans. Somewhat diagrammatic, and a composite based upon the study of actual longitudinal microscopical sections of preserved animals. $\times 750$. The black ring around the esophagus, the connection from it to the neuromotor center, and the solid black areas at the bases of the membranelles form the neuromotor apparatus.

character of the two nuclei. In many cases chromosome formation has been observed in the division of Protozoa, but in other cases it has not.

Some Protozoa, both flagellates and infusorians, show great specialization within the cell, and parts called *cell organs*, or *organelles*, are set aside for certain functions. This phenomenon is called in general, *differentiation*, and, since it occurs here within the cell, it is termed *intracellular differentiation*. Such parts are contractile strands of protoplasm called *myonemes*, which correspond to muscles in higher animals; conducting strands and coordinating centers, which perform the func-

tions of a nervous system; sensitive areas, which function as sense organs; and supporting parts, which form a sort of skeleton (Fig. 31).

The food of protozoans consists of organic matter, both vegetable and animal, living and dead. Their metabolism is, in general, similar to that described for the ameba or the paramecium. Because of the size of the animals the study of digestive enzymes is difficult, and there is little precise knowledge. Protozoans certainly digest proteins, have been shown to be able to use emulsified fats, and also are able to use certain starches.

In addition to fission, or binary division, and sporulation, protozoans sometimes exhibit a third type of asexual reproduction known as *gemmation*, or *budding*. In this case individuals of smaller size than the parent grow out from it like buds and when developed break loose, later growing to the same size as the individual which produced them (Fig. 32).

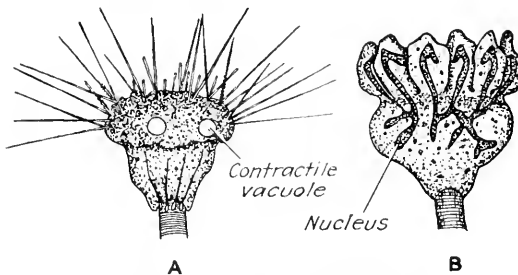

FIG. 32.—Gemmation, or budding, in *Ephelota gemmipara* (Hertwig). (After Hertwig, in *Morphologisches Jahrbuch*, vol. 1.) A, organism on stalk, showing two types of tentacles, suctorial and prehensile, the latter with spiral ridges on the surfaces. B, an individual showing the formation of buds, into each of which extends a portion of the nucleus. These buds become detached and free-swimming; they possess cilia on one side but later develop tentacles and become attached. $\times 120$.

112. Sexual Reproduction in Protozoa.—Some colonial protozoans exhibit a simple form of sexual reproduction. The animals in the colony become divided into two types: the ordinary ones, known as nutritive individuals, or nutritive zooids, which reproduce by fission in the ordinary way; and a second type which is represented by reproductive individuals or gametes. These gametes exist in two forms: the larger macrogametes, which, like egg cells, are usually not active; and the smaller microgametes, which, like the sperm cells of higher animals, are active. When these two types of sex cells unite, a zygote is formed from which a new colony may arise. The macrogametes may also show a type of sexual reproduction without fertilization. When this occurs, they remain within the colony, increase in size, divide into many cells, and finally escape to form new colonies. These groups of cells are known as *parthenogonidia* (Fig. 27 E). In many of the Sporozoa there are both sexual and asexual generations. The zygotes produce a number of spores which develop into sporozoites. These become nutritive individuals, or trophozoites, and these in turn may form another generation of gametes.

CHAPTER XVIII

PROTOZOA AND DISEASE

Protozoa which when living in the bodies of other animals are capable of producing disease in those animals are termed *pathogenic*. Many such Protozoa are known.

113. Pathogenic Protozoa.—Among the Mastigophora are the trypanosomes (Fig. 27 C). One of these, found in certain parts of tropical Africa, produces a disease known as trypanosomiasis, or, because it is characterized by a loss of consciousness, sleeping sickness. These trypanosomes are transmitted from one person to another by the so-called tsetse flies. The sleeping sickness of Africa should not be confused with a disease in this country which exhibits the same symptom and which sometimes goes by the same name; in the latter case the loss of consciousness is not caused by an animal parasite but is due to congestion in the blood vessels of the brain.

Among the Infusoria are forms belonging to the genus *Balantidium* (Fig. 30 E), which cause a type of dysentery known as balantidial dysentery. This is most common in the tropics.

Among the Sarcodina are ameba-like parasites, usually acquired through drinking contaminated water, which are the cause of a serious and often fatal form of dysentery known as amebic dysentery. Here also belong the parasitic organisms found in the mouth which produce the condition known as pyorrhea.

Sporozoa, however, includes a larger number of the protozoan parasites of man than do all the other classes together. Among these one of the most common is the malarial-fever parasite. The life history of this organism will be given in detail to illustrate the life cycle of a pathogenic protozoan, though it is more complex than that of many other types (Fig. 33). The spirochaetes, which cause syphilis and other diseases, are by some authorities considered as belonging to the Protozoa, while others consider them intermediate between the Protozoa and the Bacteria and more closely related to the latter.

114. Malarial Parasite.—The malarial parasite may exist in the blood of man, where it undergoes a series of asexual generations which may continue for many years and even through the lifetime of the person. The individual parasite lives in a red blood corpuscle, into which it enters while in the spore stage. Then it changes to a form resembling a minute ameba. It feeds upon the contents of the corpuscle and when full grown

nearly fills it. The parasite then sporulates. The rupture of the cyst formed in sporulation, accompanied by the rupture of the wall of the corpuscle, liberates numerous spores in the fluid of the blood. These enter other corpuscles and pass through a similar life history. The setting free of spores from many infected corpuscles corresponding to the starting

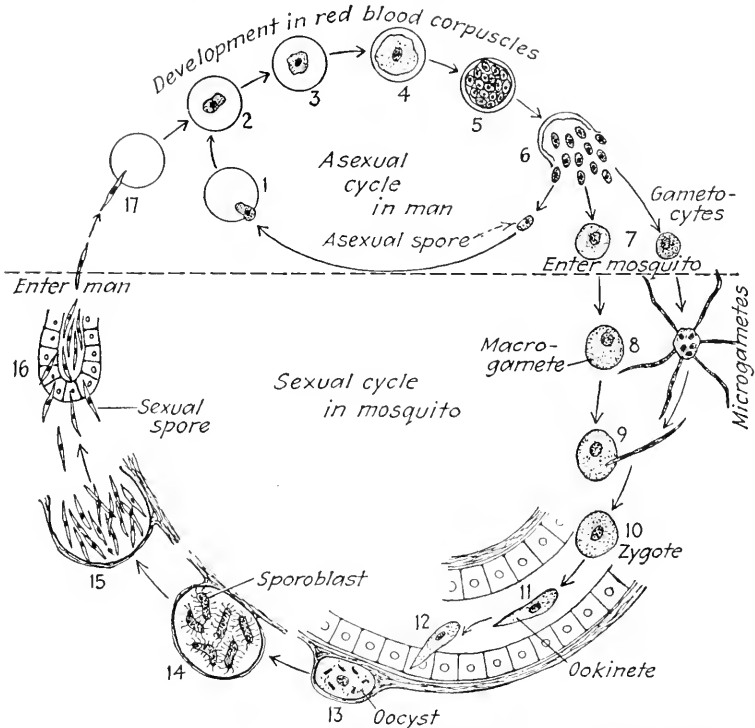

FIG. 33.—Diagram of the life cycles of the malarial parasite of the tertian type, showing the asexual cycle in man and the sexual cycle in an anopheline mosquito. Stages 1 to 6 show the entrance of the spores into a red blood corpuscle and the growth and sporulation of the parasite; stage 7, the production of gametocytes; stage 8, their transformation into gametes; stages 9 and 10, fertilization and the zygote; stages 11 and 12, the change of the zygote to an active form, the *ookinete*, which penetrates the wall of the stomach and encysts; stage 13, forming an *oocyst* below the outer layer of the stomach wall; stages 14 and 15, the development of several sporoblasts in the oocyst, the development from each of many spores, and their dispersal into the body cavities; and stage 16, the entrance of these spores into the salivary gland. They are introduced with the saliva into a human being, stage 17, enter red blood corpuscles, and another cycle is begun.

of a new generation, is accompanied by the liberation of poisons in the blood which cause an attack of chills and fever. The time between these attacks, therefore, indicates the period between generations of the parasite. These intervals are 24, 48, or 72 hours, corresponding to three forms of the disease known respectively as pernicious, tertian, and quartan malaria.

In addition to these spores, there are also produced within the red corpuscles spores which become sexual in character and by means of which

the sexual cycle of the parasite may be initiated. This sexual cycle, however, does not occur in the body of man but must take place in a mosquito. If these sexual forms, which are the microgametocytes and macrogametocytes, do not enter the body of a mosquito, they do not further develop.

The mosquito which is capable of transmitting the malarial parasite belongs to the genus *Anopheles*. It is distinguishable from the common mosquitoes, which belong to *Culex*, by the fact that it holds its body at an angle to the surface on which it rests. The body of a culicid mosquito is held parallel to such a surface. When the mosquito bites, it drills a hole through the epidermis with its proboscis and penetrates the vascular dermis. Then it injects into the wound saliva the effect of which is to prevent coagulation of the blood and thus permit the mosquito to suck until filled. It is the irritation caused by the saliva that produces the itching which is so often a feature of these bites.

If in the blood sucked up by the mosquito there are only ordinary spores, the mosquito does not become infected and is not capable of transmitting the infection. If, however, there are microgametocytes and macrogametocytes, these give rise in the stomach of the mosquito, respectively, to microgametes and macrogametes, which unite to form zygotes. These zygotes become elongated, exhibit a gliding movement, penetrate the wall of the stomach, and encyst just beneath the outer layer. In these cysts are produced a great many spores, which, when they are set free, make their way through the body of the infected mosquito to the salivary gland, in the cavity of which they accumulate. When this mosquito bites another person these spores are injected into the wound made by the proboscis, along with the saliva. In the blood they enter the red blood corpuscles, become ameboid, and thus another asexual cycle is begun.

It is evident from this outline of the life cycle that after biting a malarial individual and acquiring the infection, the mosquito cannot at once transmit the disease. It is necessary for such a transmission that there shall be sexual spores in the blood of the person bitten and that they shall be taken up by the mosquito. A sufficient length of time must also elapse for the sexual cycle to be completed and for spores to form from the zygote. This takes, on the average, about twelve days, though the time varies with the form of the disease and environmental conditions, such as temperature.

In the absence of man the female mosquito feeds on the blood of other animals or upon the juices of plants. The male mosquito does not feed, nor does it bite, and therefore cannot become infected and transmit the disease. The sexes may be distinguished by their antennae; those of the male are complexly branched and have a feathery appearance, while those of the female are simple, straight, and hairlike.

The malarial parasite belongs to the genus *Plasmodium*. Three species are recognized, corresponding to the three forms of the disease. *Plasmodium vivax* (Grassi and Feletti), producing tertian malaria, is the common one in the United States.

The malarial-fever parasite was discovered in Algeria in 1880 by a French army doctor, Laveran, who found it in the blood of patients suffering from malaria. In 1883 a Dr. King of Washington, D. C., presented evidence to show the transmission of the parasite by the mosquito; and this transmission was demonstrated experimentally by Sir Ronald Ross, an Englishman, in 1898. An Italian, Grassi, and his pupils worked out the complete life cycle. Previous to these discoveries it was generally believed that the disease could be acquired by the breathing of miasma rising from swamps and marshes, and the name, meaning literally bad air, was given because of this superstition. Owing to the work of the investigators named and others, it is now a fact of common knowledge that malaria can be conveyed to a person only through the bite of an infected mosquito of the proper kind.

PART III
METAZOA IN GENERAL

CHAPTER XIX

METAZOA

All animals which are not protozoans are included in one subkingdom known as Metazoa. All such animals are similar in that they have a many-celled body in which the cells are not all alike but are varied in structure and function, the activities of the whole being the result of their cooperative efforts.

115. Differentiation.—The modification of certain parts for the performance of corresponding functions is known as *differentiation*. In the Protozoa has been seen *intracellular differentiation* (Sec. 111), as a result of which one particular structure within the cell comes to perform one function and the other structures other functions. In the highest of the Protozoa this results in an exceedingly complex cell. In the Metazoa, however, complexity does not result from the complexity of the individual cells which make up the animal but from differences between them. This *intercellular differentiation* results in a great variety of cells within one body. Differentiation which is concerned with structure alone is *morphological differentiation*. Accompanying this, however, is differentiation in function, which results in cells of different structures having different functions, appropriate in each case to the structure. This may be termed *physiological differentiation*. All differentiation is based upon modification in the metabolic activities of the cells. As a result of differentiation the cells in the metazoan body become interdependent, in contrast to the independence which exists between protozoan cells, even in colonies. This interdependence, however, is forecasted in the case of certain of the colonial Protozoa such as the volvox, in which protoplasmic bridges extend from cell to cell and in which certain reproductive cells are differentiated. It thus appears that the line of demarcation between the Metazoa and the Protozoa is not so sharp as might be supposed. It may, however, be drawn on the basis of the differentiation in the non-reproductive, or somatic, cells, which does not occur in the Protozoa but is characteristic of the Metazoa.

116. Division of Labor.—Another term for physiological differentiation is that of *division of labor*. The idea conveyed by this expression involves an analogy between the development of the animal body and that of human society. Among very primitive peoples each individual is largely independent of his fellows, doing for himself all that he needs to have done. As society develops, certain individuals become

more proficient in the doing of certain kinds of work, and as a result a person skilled in one field exchanges the products of his labor for the products of the labor of another who is more proficient in some other field. This specialization in the work of the individual and the exchange of the results of that work develop in proportion as civilization advances. In the most highly civilized society the individual may spend his whole time doing simply one thing, as the making of a single part for a complex machine, most of the articles which he uses being secured by the purchase of the products of the labor of others. In the study of animals representing various groups from the lowest to the highest a similar reduction in the degree of independence and increase of the interdependence which accompanies specialization may be observed.

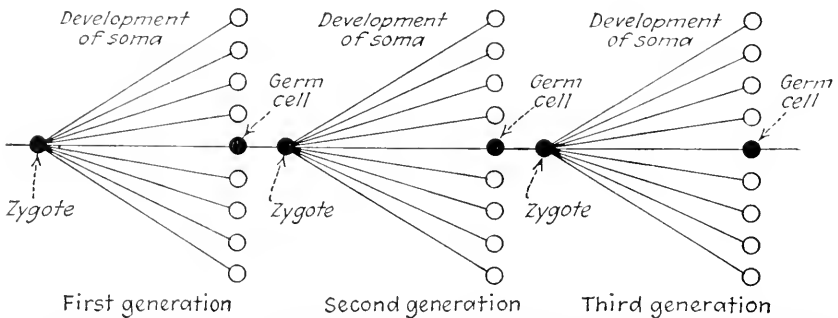

FIG. 34.—Diagram to illustrate Weismann's conception of the continuity of the germ plasm and the development of the somatoplasm anew in each generation. Germ cells are black, somatic cells white.

117. Somatic and Germ Cells.—The earliest type of cells to become differentiated from the rest are the sex cells, or *germ cells*. It has been seen (Sec. 112) that they are set aside even among some of the colonial Protozoa. All the cells in the body other than sex cells are termed *somatic cells*. When a metazoan reproduces sexually, either the egg cell or the zygote which is to participate in the formation of the new individual separates from the body of the parent, and by differentiation the whole organization characteristic of the particular species of animal is developed. With the death of such an individual all the somatic cells perish. If we call the protoplasm of the somatic cells *somatoplasm* and that of the sex cells which transmit hereditary characters *germ plasm*, it may be said that the thread of life continues from generation to generation through the germ plasm alone, the somatoplasm being formed anew in each generation from the germ plasm. Only in the case of asexual reproduction in the Protozoa does the whole animal live on in the bodies of its descendants—that is potential immortality.

The genetic continuity of the germ plasm was emphasized in the work of Weismann, whose conception is illustrated in the accompanying

diagram (Fig. 34). The hereditary units, which determine the possibilities open to the animal, are passed on from generation to generation in the germ cells. In the various types of somatic cells, under the environmental conditions which surround each, are realized and manifested such of these possibilities as taken together equip the individual with its characteristic features.

CHAPTER XX

TISSUES

As a result of differentiation a variety of cells is produced. These tend to be associated in groups of similar cells to which is applied, in general, the term tissues.

118. Definition.—A *tissue* is a group of somatic cells which are similarly differentiated—that is, which are similar in structure and which perform one or more functions in common—together with the structures produced by them. In some tissues is found intercellular material which is developed from the cells and which is very important in the performance of the particular function belonging to the tissue.

Among the various tissues in the body are recognized four distinct types, classified on the basis of both structure and function: (1) epithelia, or epithelial tissues; (2) supporting and connective tissues; (3) muscular tissues; (4) nervous tissues.

119. Epithelia.—An *epithelium*, or an epithelial tissue, is the type of tissue which covers any free surface, either the outside of the body or the walls of cavities within it. In the simplest Metazoa this is the only kind of tissue present and there may be little differentiation in it in the different parts of the body. In the more complex animals, however, the epithelia found in various parts of the body become quite diversified and are named according to the shape of the cells or to the functions which they perform. For example, an epithelium which on its outer surface is made up of very flat cells is termed a *pavement* epithelium; one in which the surface cells are in the shape of long prisms, set at right angles to the surface, is called a *columnar* epithelium; and one in which the cells on the surface bear cilia is known as a *ciliated* epithelium. If an epithelium possesses only one layer of cells it is termed *simple*; if it has several layers, *stratified* (Fig. 35). Examples of epithelia named from their function are *sensory*, *glandular*, *protective*, and *reproductive*.

The functions which epithelia perform are several. Some serve to protect the structures below them. Others contain sensory cells and serve to receive and transmit stimuli from the outside. Through epithelia all food has to enter the body, and also all waste matter has to leave. They also produce many of the secretions which, when poured out upon a surface, serve to moisten it, to lubricate it, or to digest food. Reproductive cells arise from what are called *germinal* epithelia.

All epithelia are similar in that their cells generally possess walls, they are relatively small and compact, are crowded closely together, and are usually cemented to one another by an intercellular cement secreted by the cells. The connective tissue underlying an epithelium often forms a thin sheet called a *basement membrane* (Fig. 35 *C* to *E*) to which the epithelial cells are attached. In some cases intercellular bridges of protoplasm connect one cell to the next, and in the absence of a basement membrane the deepest layer of cells in an epithelium may be anchored by rootlike projections which penetrate the tissue below them. Neither nerves nor blood vessels are ordinarily found in epithelia, though this does not apply to nerve terminals in sensory epithelia.

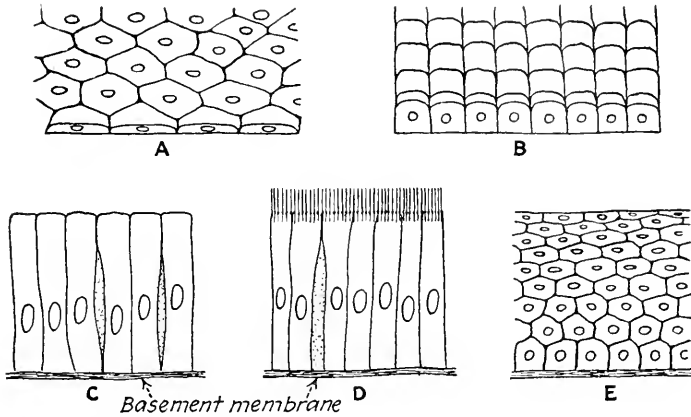

FIG. 35.—Semidiagrammatic sketches illustrating different types of epithelia. *A*, simple pavement epithelium, seen in surface view and in section. *B*, section of simple short columnar, or cubical, epithelium, also seen in surface view and in section. *C*, sectional view of a simple columnar epithelium. *D*, section of simple ciliated epithelium. *E*, section of a stratified pavement epithelium. All highly magnified. Figure 4*A* also shows a single very thin pavement epithelial cell.

When epithelial cells have a secretory function the secretion may be accumulated in droplets within the cells (Fig. 36). In the case of enzyme-secreting cells droplets or granules containing a *zymogen* are accumulated, and when secretion occurs the zymogen is transformed to the enzyme and passed out of the cell. These droplets or granules become massed at the outer end of the cell and the cells consequently become markedly granular in texture. The droplets or granules disappear when the enzyme is formed and passed out through the cell wall, to reappear during the time the gland is not secreting. Examples are the cells of the salivary glands and the pancreas. In some cases, however, as in the case of cells which secrete mucus, the droplets flow together and form a great mass toward the outer end of the cell. The secretion is set free by the rupturing of the cell wall. Examples are the mucus-secreting goblet cells of the intestines of vertebrates. In still

other cases the secretion involves the destruction of the whole cell, which pours out its contents to form the secretion; examples are milk glands and sebaceous, or oil, glands.

When epithelial cells undergo a change which makes them hard, the substance formed is horn, which chemically is a substance called *keratin*. In this fashion true horns, claws, nails, and tortoise shell are developed. In the case of teeth and some scales of vertebrates, however, *enamel* may be the substance produced. In some cases epithelia produce a hard covering by the hardening of a secretion; an example of such a hard covering is the cuticula of the bodies of insects, which contains *chitin*.

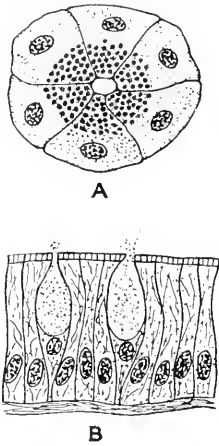

FIG. 36.—Figures to illustrate the secretory function in epithelial cells. A, cells of such a gland as the salivary glands or pancreas showing zymogen granules accumulated in the part of the cell adjacent to the lumen, or cavity, of the gland. B, two goblet cells from the intestine of a vertebrate showing the accumulation of mucus and its extrusion into the lumen of the intestine.

line which makes the tissue very firm and capable of giving effective support to even a large body. Special types of fibrous tissue which also serve to bind parts together include the *ligaments*, which connect the parts other than muscles, and the *tendons*, which serve to connect muscles to other parts at their point of attachment (Fig. 37).

An additional function which these tissues have, and which also is a passive function, is to store fat. *Fat* tissue is simply a connective tissue in which the cells, because they are filled with great globules of fat, have

120. Supporting and Connective Tissues.—These tissues are found in all parts of the body and differ from other tissues in the fact that the character of the tissue depends not so much upon the cells which it contains as upon nonliving intercellular materials formed by secretion from these cells. Examples of such materials are fibers, bone, and cartilage. Most of the embryonic connective tissue appears in the form of a network of branched cells and is known as *mesenchyme*.

A prominent function of these tissues is support, either of the body as a whole or of some particular part. Among supporting tissues having this function are *fibrous* tissues, which are characterized by bundles of fibers or single fibers between the cells. White, nonelastic fibers are usually collected in bundles; while yellow, elastic fibers are, in most cases, single and, since they branch and anastomose, or run together, tend to form a network. The fibrous tissues also serve to bind parts together and to hold them in place. Another type of supporting tissue is *cartilage*, in which the space between the cells is occupied by a substance known as *chondrin*, or “gristle.” Still another type is *bone*, in which there is laid down between the cells a deposit of salts of

become large and crowded upon each other, while the intercellular elements become the less conspicuous part of the tissue. The *blood* may also be considered as a connective tissue in which the intercellular elements are all in solution and form the blood fluid or plasma in which the cells float.

121. Muscular Tissues.—Muscular tissues have as their function motion and locomotion. As befitting cells set aside for this purpose,

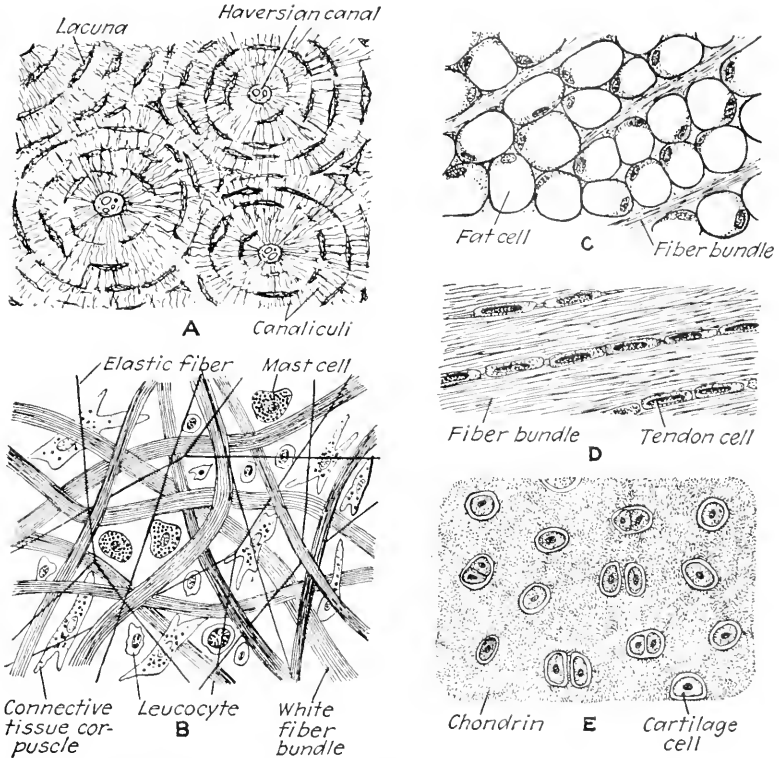

FIG. 37.—Different types of connective tissues; somewhat diagrammatic. *A*, bone, showing the haversian canals which transmit the blood vessels and nerves, and the lacunae, which lodge the bone cells, or bone corpuscles (refer to Fig. 4 *E*). *B*, portion of subcutaneous alveolar connective tissue, showing several tissue elements. *C*, fat. *D*, tendon in longitudinal section, showing longitudinal fiber bundles and rows of cells crowded into the space between them. *E*, section of cartilage with the cells lodged in spaces in the chondrin. All highly magnified.

they become more or less elongated or fiber-like. In some cases, in order to secure a greater length of the contractile fiber, it is composed not of one cell but of many, all united into a single fiber, which gives evidence of its composite nature only by the fact that it contains many nuclei. The protoplasm within these cells becomes organized in a very complex manner and in such a way as to determine the direction in which contraction shall take place. All muscle cells perform their function by

virtue of their power to contract; their subsequent elongation is simply a matter of relaxation and returning to a normal shape.

Three types of muscle tissue are recognized: (1) *skeletal*, striated and voluntary, found, generally speaking, in the muscles which are themselves organs under the control of the will and often attached to the skeleton; (2) *visceral*, nonstriated and involuntary, generally not under the control of the will and forming a part of other organs; and (3) *heart muscle*, a type intermediate between the two others, found in the heart (Fig. 38). Skeletal muscles consist of large multinucleated fibers which show a very marked cross banding or, as it is termed, cross striation; visceral muscle fibers are individual cells and do not show this cross striation; heart muscle is made up of individual cells which are involuntary but cross-striated.

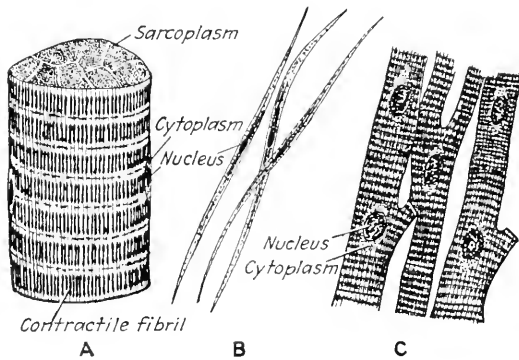

FIG. 38.

FIG. 38.—Different types of muscle cells. A, portion of a striated muscle fiber showing a section in which the contractile fibrils are divided into groups by partitions of semifluid sarcoplasm. Two nuclei are shown, surrounded by undifferentiated cytoplasm, and the whole fiber is surrounded with a delicate connective tissue sheath, or sarcolemma. B, three nonstriated muscle fibers, or cells. C, several cardiac muscle cells. All highly magnified.

FIG. 39.—Diagram of a nerve cell, possessing a cell body and a medullated motor nerve fiber, ending in a motor end plate. Such cells are characteristic of the spinal cord of vertebrates. The medullary sheath is acquired while the axon is in the outer layers of the cord, and the neurilemma as the fiber emerges from the cord. The nerve fiber is too long to be shown entirely, so a break is indicated.

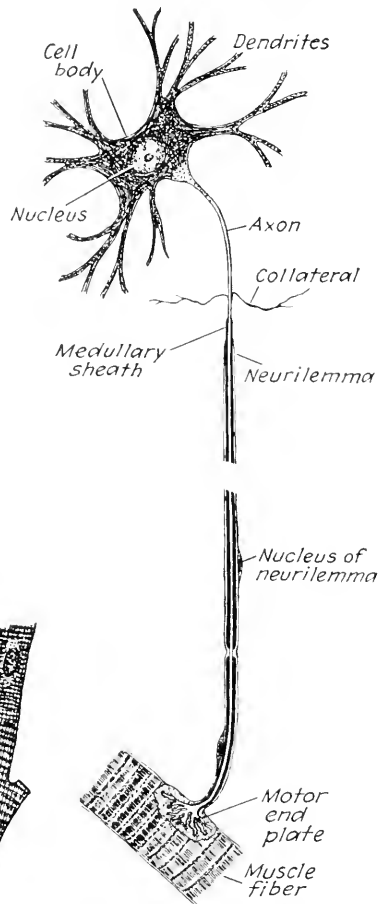

FIG. 39.

Of these types of muscle tissue, nonstriated muscles are found more generally in the lower animals and the striated muscles predominate in the higher forms. In the higher forms the nonstriated muscles are in

the walls of the alimentary canal, the blood vessels, and the gland ducts.

122. Nervous Tissues.—Nervous tissues contain *cell bodies* from which extend processes or nerve *fibers* which vary in length and in the degree to which they are branched (Fig. 39). The function of these tissues is to register the effect of stimuli and to conduct this effect from cell to cell until it finally reaches a cell which gives the appropriate response. The nerve cells of a brain may themselves initiate impulses which stimulate another part of the body to action. Finally, nervous tissues have the power to conserve the effect of stimulation and to use it in modifying future action. The effect of a stimulus conducted along a fiber is known as an *impulse*. Irritability and conductivity are properties of all protoplasm but are developed to the highest degree in these tissues. A fiber which transmits an impulse to the cell body of which it is a part is known as a *dendron* or *dendrite*, while a fiber which transmits an impulse in the opposite direction is an *axon*, or *axis cylinder process*. Some nerve fibers have a fatty sheath and are said to be *medullated*; others, which lack this, are *nonmedullated*.

CHAPTER XXI

ORGANS AND SYSTEMS

In the bodies of all Metazoa, except the lowest, tissues become associated together in such a fashion that several contribute to the performance of some function which belongs to the association as a whole.

123. Definitions.—An *organ* is a part of the body formed by an association of tissues all of which contribute to the performance of some function or functions. Many organs in the higher animals include representatives of all of the four different types of tissues. For instance, the heart is covered and lined with epithelium; the greater part of its wall is made up of muscular tissue; fibrous connective tissues serve to connect other tissues and give support; and nervous tissues receive the impulses from the central nervous system, coordinate them, and distribute them to the heart muscles.

Not only are tissues associated in the body to form organs, but organs are associated to form systems. A *system* is a group of organs which collectively perform certain related functions. Thus the body might be conceived of as being built up by adding cells to cells to form tissues, tissues to tissues to form organs, organs to organs to form systems, and systems to systems to form the whole; or it could be analyzed in terms first of systems, then of organs, then of tissues, and finally of cells.

124. Systems.—Nine systems are recognized in higher animals. A list of these with the most prominent functions follows:

1. *Tegumentary System.*—Protection, temperature regulation, elimination of a small amount of liquid waste, and external support.

2. *Digestive System.*—The ingestion, digestion, and absorption of food, the secretion of digestive ferments, egestion, and elimination of a small amount of liquid waste.

3. *Circulatory System.*—The transportation of food, oxygen, and the excretions of the body as well as the carrying about of certain internal secretions; also internal respiration.

4. *Respiratory System.*—The taking in of oxygen and giving off of carbon dioxide, or external respiration.

5. *Excretory System.*—The elimination of most of the liquid waste products derived from metabolism (this would be more appropriately named the eliminative system, but the name excretory has been universally used).

6. *Skeletal System.*—Protection and support.

7. *Muscular System*.—Motion and locomotion.

8. *Nervous System*.—Reception of stimuli, sensation, coordination, and causation of muscular and secretory activity.

9. *Reproductive System*.—Reproduction.

This enumeration does not cover all of the structures in the body. Such a tissue as fat, the function of which is storage, does not logically come under the head of any one of these systems. In the lower Metazoa many functions may be carried on in part by single cells and in part by tissues, and when finally organs and systems become clearly defined there is a gradual increase in the complexity of both, reaching its highest degree in the highest animals.

125. Organs Belonging to Different Systems.—Systems should always be analyzed in terms of the organs which compose them. The *tegumentary system* includes the skin and the structures contained in it, with the exception of sense organs, which are usually considered as part of the nervous system, and the skin muscles, which are generally referred to the muscular system. The skin occupies a somewhat equivocal position. It may play a part in absorption and in respiration as well as performing the functions already given. It has often been considered a single widely spread organ with smaller organs imbedded in it, such as various glands, and organs of attachment, like sucking discs.

The more important regions of the *digestive system* in the vertebrates are the mouth, pharynx, esophagus, stomach, small intestine, large intestine, and rectum, which may be considered, in a general sense, a series of tubular organs placed end to end making up the alimentary canal. Some of these also contain other accessory organs, such as tongue, teeth, and certain glands. Other accessory organs lying outside the canal, as salivary glands, liver, and pancreas, also belong to this system. The organs of the *circulatory system* are the heart, blood vessels, lymph nodes, and spleen. The *respiratory system* includes, in various animals, gills, lungs, air passages, and tracheae, or breathing tubes, of insects. The pharynx, and in some cases the mouth, may be considered as belonging to this as well as to the digestive system. Nephridia in the lower forms and kidneys in the higher, the bladder, and the tubes which convey the urine are the organs of the *excretory system*.

The muscles, individually, are the organs of the *muscular system* (Fig. 40); they contain muscle tissue and, in addition, fibrous connective tissue sheaths, tendons, and nerve endings. In a similar way bones and cartilages are examples of organs of the *skeletal system*; a bone, besides bone tissue, may contain marrow, a fibrous sheath, and cartilage, which coats certain areas on the bone, forming smooth surfaces for articulation with other bones (Fig. 40). One organ may be included within another and become a part of it, as blood vessels and nerves in muscles and bones.

The organs of the *nervous system* are the brain and spinal cord, nerves, and various sense organs. Nerves possess sheaths of connective tissue in addition to nervous tissue and are also supplied with blood vessels and smaller nerves.

Of the *reproductive system*, the most important organs are the gonads, under which are included the testis of the male and the ovary of the female. There are also to be added the ducts which convey the sperm

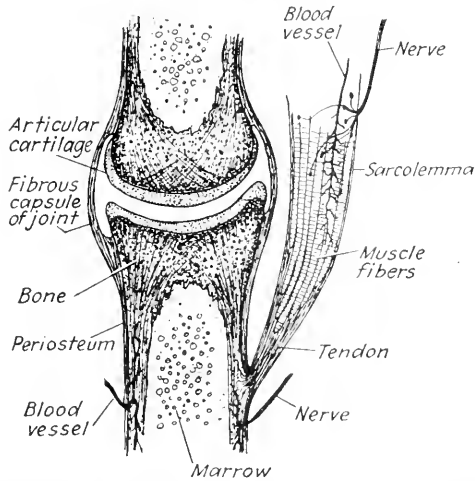

FIG. 40.—A diagram to indicate the nature of bones and muscles as organs and the mode of attachment of a muscle to a bone. A bone as an organ consists of several tissues, such as bone, articular cartilage, marrow, and the fibrous periosteum, and into it enter blood vessels and nerves. A muscle contains muscle fibers, is covered with a fibrous sheath, ends in a tendon, and also is supplied with blood vessels and nerves. The fibers of the tendon are interwoven with those of the periosteum, from which other fibers penetrate the bone, giving a firmer anchorage.

cells and egg cells and a variety of other organs, such as yolk glands and shell glands in the female and copulatory organs in the male.

These organs and systems will be described in greater detail when the animals which possess them are considered.

126. Other Parts of the Body.—Many divisions of the body are recognized which have no relation to organs and systems, such as the head, neck, trunk, and appendages. Appendages are usually not individual organs but often contain many organs belonging to several different systems. For instance the vertebrate limb contains organs of the tegumentary, circulatory, skeletal, muscular, and nervous systems.

CHAPTER XXII

REPRODUCTION IN THE METAZOA

The general subject of reproduction was introduced in Chap. X, and reproduction in Protozoa has been considered especially in Sees. 97, 103, 111, and 112.

127. Methods of Reproduction in Metazoa.—In Metazoa the usual type of reproduction is sexual, although asexual reproduction is found in the lower forms. *Fission* occurs when the animal's body divides into two individuals equal in size. The process is called *budding* when an individual gives rise to another by the separation of a part smaller than that which remains and which is the parent. Both fission and budding occur in many of the lower metazoans. Some of the lower worms also undergo what is called *fragmentation*. Though not the same as sporulation, in the sense in which the word is used in connection with Protozoa, fragmentation is a mode of reproduction analogous to it and occurs when the body divides into a large number of fragments each one of which becomes a complete individual.

128. Sexual Reproduction.—Sexual reproduction in Metazoa usually involves two parents. It is then termed *biparental*. In this case the two parents usually differ from each other in their external appearance. The one which is termed the male produces sperm cells; and the other, called the female, produces egg cells. A species of which this is true is termed *dicious*, or bisexual, referring to its existence in the two sexes. On the other hand, particularly among lower Metazoa, there are those species in which one individual produces both egg cells and sperm cells and which therefore contains the organs of both sexes. Such species of animals are represented by only one type of individual and are called *monecious*, or *hermaphroditic*. Different species of hydra and of earthworms are examples of monecious animals; almost without exception the vertebrates are dicious.

129. Uniparental Reproduction.—It is possible for an egg cell to develop without union with a sperm cell. When this takes place the phenomenon is termed *parthenogenesis*. It occurs in nature in a number of dicious animals in which exceedingly rapid reproduction contributes to the welfare of the race. Examples of such animals are plant lice, which are eaten by a vast number of other animals and which continue to exist only by virtue of exceedingly great powers of reproduction, and certain aquatic forms, like rotifers and water fleas, which are also eaten in great numbers by fish and other larger aquatic animals.

If rapidity of multiplication is the end reached in parthenogenesis, (this is attained to a still greater degree if the animal does not wait to become mature before it becomes capable of reproducing. Reproduction by an immature animal is known as *pedogenesis* and occurs in the case of a number of insects; for instance, the larvae of certain gall gnats and the pupae of some midges produce eggs which are capable of developing without fertilization.

130. Types of Fertilization.—Animals which are monecious are capable of fertilizing their own egg cells, though actually in nature few such animals do so. When this occurs, the phenomenon is known as *self-fertilization*. In the case of animals which are dicecious the fertilization of the egg cell of one individual must be by the sperm cell of another. This is known as *cross-fertilization*. Cross-fertilization is not the same as *hybridization*, the latter term being applied only when the two individuals belong to different species. Cross-fertilization is a very general phenomenon and is practically universal among the higher animals; hybridization is much less frequent.

131. Oviparity and Viviparity.—Many animals retain for a time within their bodies their egg cells and the embryos which develop from them and give birth to living young. Such animals are termed *viviparous* and the phenomenon is *viviparity*. On the other hand, a great many pass the egg cell out of the body for development. These forms are termed *oviparous* and the phenomenon *oviparity*. In oviparous animals the egg cell when passed out of the body is usually provided with a greater or less number of protective envelopes various in character, and to the egg cell plus all of these envelopes is applied the term *egg*. In some cases fertilization takes place within the body before these envelopes are added, and here, as in viviparous animals, the phenomenon is referred to as *internal fertilization*. On the other hand, the egg may be of a character which permits fertilization after passage from the body. Such a type of fertilization is termed *external fertilization*.

132. Metagenesis.—There are animals in which both sexual and asexual types of reproduction occur, and these in alternate generations. One or more generations produced in one manner are followed by one or more produced in the other. This phenomenon is termed *metagenesis*, or alternation of generations. It is illustrated best among some marine hydroids and jellyfishes, in connection with the study of which it will be more fully described.

CHAPTER XXIII

ORIGIN OF THE SEX CELLS

The first step in the production of a new individual sexually is the formation of sex cells. This takes place in gonads which arise from the germinal epithelium, which in turn is developed from the cells lining the coelom, or body cavity.

133. Gametogenesis.—The origin and development of the sex cells are termed *gametogenesis*. This may be divided into *spermatogenesis*, which deals with the male germ cell, called the sperm, sperm cell, or spermatozoon; and *oogenesis*, which deals with the female germ cell, called the egg cell, or ovum.

In all references to the male germ cell in this text it will be called a sperm cell. The objection to the word spermatozoon is that it perpetuates an error; it means, literally, "sperm animal" and was proposed at a time when it was believed that these cells were themselves animals living in the bodies of higher animals. The term egg cell is preferred to ovum because the latter has been used both in this sense and also to apply to the whole egg.

Both processes, spermatogenesis and oogenesis, begin (Figs. 41 and 42) quite early in the life of the embryo by the setting aside of a *primordial germ cell* from which come all of the sex cells which will be developed in that animal's body. This cell multiplies by repeated divisions until a very large number of cells is produced; the time during which this occurs is called the *multiplication period*. In spermatogenesis these cells are known as *spermatogonia*; and in oogenesis, *oogonia*. When the animal becomes sexually mature, these cells undergo the processes of growth and maturation, the *growth period* involving both an increase in the size of the cell and a union of like chromosomes in pairs. This union of chromosomes is termed *synapsis*. At the end of the growth period the male cells are termed *primary spermatocytes*; and the female cells, *primary oocytes*. From this time on the processes of spermatogenesis and oogenesis differ.

134. Spermatogenesis.—The periods of multiplication and growth having been completed in spermatogenesis, the *maturation period* follows (Fig. 41). The primary spermatocyte undergoes two maturation divisions. The first results in the formation of two *secondary spermatocytes*, and the second in the formation of two *spermatids* from each of these secondary spermatocytes, making four spermatids altogether. The

chromosomes, which were brought together in pairs in synapsis, are separated again in one of these divisions, in which case, instead of each chromosome dividing, whole chromosomes pass to the poles of the spindle. Thus the number of chromosomes becomes reduced to half the number contained in the primordial germ cell. This peculiar type of cell division

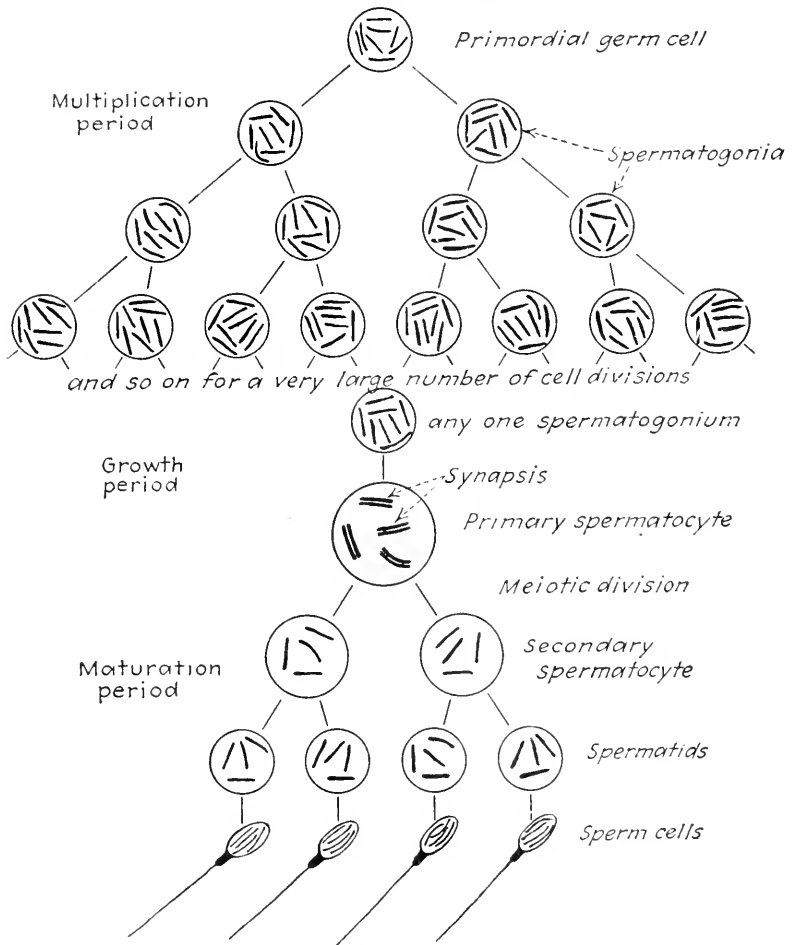

FIG. 41.—Diagram illustrating spermatogenesis, the haploid number of chromosomes being four and the diploid eight.

is known as a *reduction division*, or *meiosis*. The reduced number of chromosomes is known as the *haploid* number, while the larger number, found in all somatic cells and in all immature germ cells, is called the *diploid* number. Sometimes the reduction occurs in the first of these maturation divisions and sometimes in the second.

The spermatids undergo a process of modification or ripening which involves a change in form and also the loss of a considerable amount of

the cytoplasm. The nucleus becomes the larger part of the body, or head, of the mature *sperm cell*, which in many higher animals resembles in shape a tadpole with a very long tail. From a portion of the

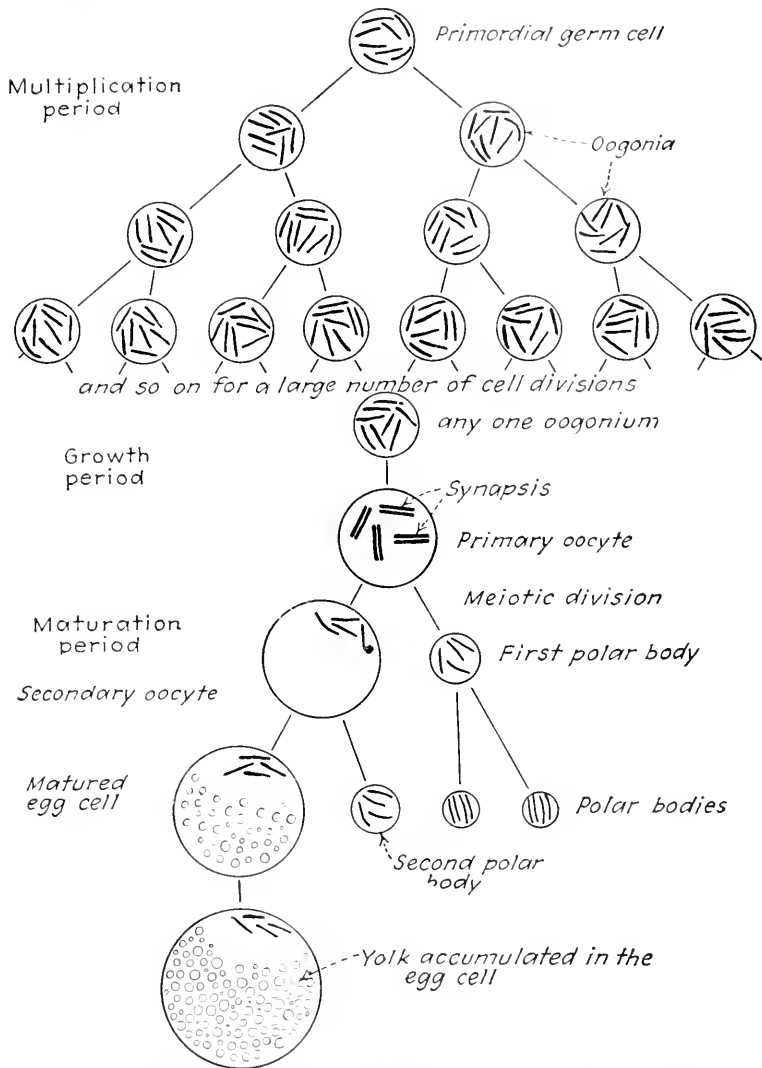

FIG. 42.—Diagram illustrating oogenesis, the chromosome number being the same as in Fig. 41.

cytoplasm is formed the tail, and between the head and tail, connecting one to the other, is a middle piece which contains the centrioles. This tail, by rapid vibrating movements, can propel the sperm cell through a liquid medium at a relatively high rate of speed.

135. Oogenesis.—In oogenesis, also, after the periods of multiplication and growth have been completed, the primary oocyte undergoes a first maturation division in which, in contrast to what occurs in spermatogenesis, it is very unequally divided (Fig. 42). One of the two daughter cells is small and, while it contains half the nuclear material, has practically none of the cytoplasm. The other is much larger, receiving in addition to half the nuclear material practically all of the cytoplasm. The smaller daughter cell is termed the *first polar body*; and the larger one, the *secondary oocyte*. Following this division a second division of the first polar body may occur, giving rise to two smaller polar bodies each equal in size to half of the first polar body. The secondary oocyte undergoes another unequal division, a *second polar body* being formed as before with very little cytoplasm, while the larger cell is known as the *egg cell*. As in spermatogenesis one of these two divisions is a reduction division in which the number of the chromosomes is reduced to the haploid number. The result of oogenesis, therefore, is to produce one large, functional egg cell and either two or three polar bodies depending upon whether or not the first polar body undergoes division. These polar bodies die, disintegrate, and disappear. In effect, all of the cytoplasm which would have gone to four cells if the divisions of the cells had been equal has been accumulated in the one. This egg cell becomes still larger by the accumulation within it of *yolk* and thus becomes fully mature. This accumulation of yolk in the mature egg cell is to provide the necessary food supply for the embryo which will develop from it until the developing individual can secure food for itself.

It should be observed that in both oogenesis and spermatogenesis all of the cell divisions except the reduction division are mitotic.

136. Comparison and Contrast between Spermatogenesis and Oogenesis.—It is clear from the description of the two processes that there are many ways in which they are alike; the more important similarities may be enumerated as follows:

1. Both start with a primordial germ cell.
2. Both pass through three periods, namely, multiplication, growth, and maturation.
3. Both undergo a process known as synapsis in the growth period.
4. Both possess two maturation divisions.
5. Both exhibit a reduction in the number of chromosomes.

On the other hand, the two processes are sharply contrasted in several ways:

1. Spermatogenesis results in the production from each spermatogonium of four similar sperm cells, all of which are functional, while oogenesis results in the formation from each oogonium of only one large cell, the egg cell, and of three small nonfunctional cells or polar bodies.

2. Mature sperm cells are very small and very active cells; mature egg cells, owing to their large size, are passive.

3. Because all of the sperm cells are functional and also because of a much greater number of multiplication divisions, the total number of sperm cells produced is enormously greater than the number of egg cells. The number of egg cells which become mature and may be fertilized is only a small fraction of the number actually produced. The rest act as nurse cells and contribute their substance to those which are to develop. A good example of this is seen in the fresh-water hydra, in the ovary of which a large number of egg cells are developed; only one of these, however, becomes fully mature and capable of producing another individual.

137. Division of Labor between the Germ Cells.—It will be observed that in spermatogenesis and oogenesis there has been a division of labor between the two types of sex cells. In order that fertilization shall occur the two cells must come together, and to assure the development of the embryo a large store of food is provided. If both cells had a store of food neither would be able to move effectively and their union could not occur, but the accumulation of a sufficient store of food in one while the other becomes small and active makes it possible for the latter to seek out the former and to unite with it. That practically every mature egg cell will be fertilized is also insured by the enormous number of sperm cells produced as compared with the number of egg cells. This greater number, however, imposes no proportionately greater strain upon the energy of the individual, since frequently there is no more material in 100,000 sperm cells than in one egg cell. In a certain species of sea urchin the volume of the individual egg cell is equal to that of 500,000 sperm cells.

138. Variations in Gametogenesis.—In the details of this process many variations occur in different animals. All of the sex cells which the animal produces may mature at the same time; this is the rule in insects, which, after the maturation and fertilization of the eggs, deposit them as rapidly as possible and soon die. Maturation periods may occur at intervals and the animal live through several breeding seasons. Many mammals exhibit this phenomenon. Birds have an annual breeding season. At other times than during the breeding season the sex organs in these animals are quiescent and the maturation of the sex cells is arrested. In still other animals, particularly in the male sex, maturation goes on continually and the animal can breed at any time. Under domestication the breeding season may be greatly extended. The domestic hen in the original state had a restricted breeding season and laid only a limited number of eggs. Under domestication the number has been increased until now (November, 1932) the record stands at 357 eggs in one year, which means practically continuous sexual activity.

CHAPTER XXIV

FERTILIZATION

In a general sense *fertilization* may be defined as the union of the sperm cell with the egg cell, though, as will be seen, the process involves several steps, takes a certain length of time, and there may be a question

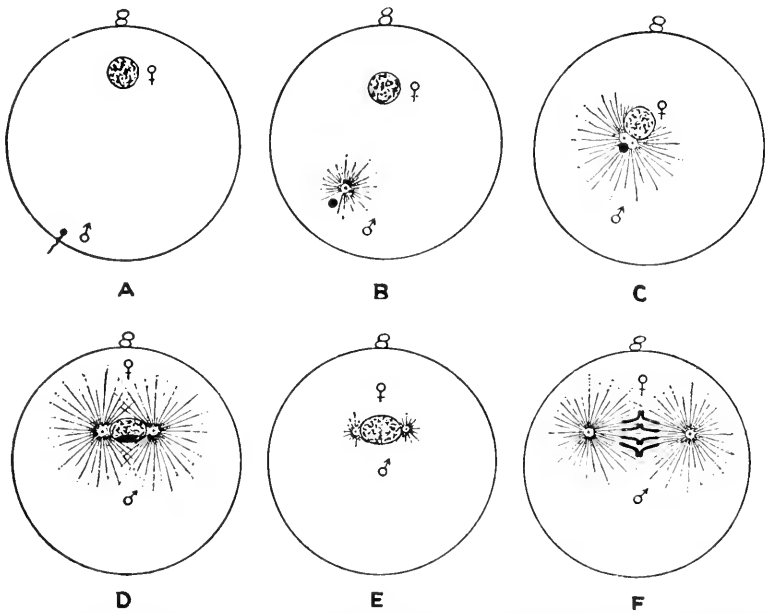

FIG. 43.—Diagrams showing the successive steps in the fertilization of the egg cell of a sea urchin, which is mature when the sperm cell enters. (From Wilson, "The Cell," by the courtesy of The Macmillan Company.) A, the entrance of the sperm cell; the maturity of the egg cell is indicated by the two polar bodies. B, the approach of the two pronuclei, the centriole of the sperm cell and the aster developed about it preceding the male pronucleus. C, the meeting of the two pronuclei; the centriole has divided. D, the formation of two asters about the two centrioles, now on opposite sides of the two pronuclei, which are undergoing fusion. E, the fusion nucleus representing the two pronuclei during a period of pause, while the asters are reduced in size. Fertilization may now be said to be complete. F, the first cleavage division, which follows the pause, at the beginning of the anaphase.

as to when the union is actually consummated. Two phenomena are involved: the activation of one cell by the other and the union of corresponding chromosomes from the two parents. The former effect is paralleled by *artificial parthenogenesis*. Loeb discovered in 1899 that the eggs of starfishes and sea urchins could be caused to develop by artificial

stimulation, and echinoderms have since been the favored types in such experimentation. Since that time successful experiments have been carried out with invertebrates other than echinoderms, especially annelids and mollusks, and with fishes and frogs, none of which develop parthenogenetically in nature. Several types of stimuli—mechanical, thermal, and chemical—have been found to be effective. The adult condition has been attained in but few cases. In an animal as high as the frog, however, tadpoles were reared which metamorphosed into adults.

139. Steps in Fertilization.—Usually the whole sperm cell enters the egg cell, but in some cases more or less of the tail is left outside and there enters only a nucleus the centrioles, and a very little cytoplasm. The

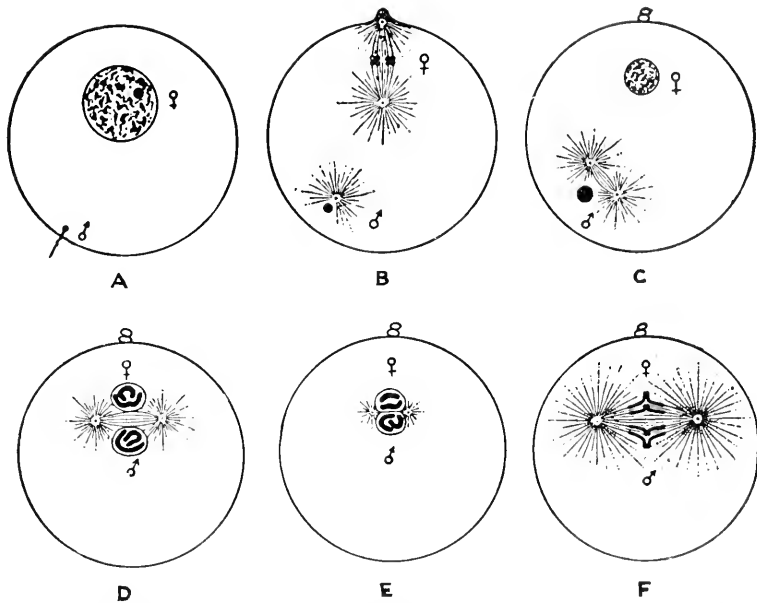

FIG. 44.—Diagrams showing the successive steps in the fertilization of the egg cell of a round worm, *Ascaris*, which matures after the entrance of the sperm cell. (From Wilson, "The Cell," by the courtesy of The Macmillan Company.) A, the entrance of the sperm cell; the egg cell is in the condition of a primary oocyte. B, the formation of the first polar body; development of a sperm aster. C, the matured egg cell, with the polar bodies; the male pronucleus has increased in size; from the one centriole has developed two, each with an aster, and a spindle lies between them. D, the two pronuclei, now about equal in size and each containing chromosomes, meet on the spindle. E, a pause corresponding to that in Fig. 43E. F, first cleavage division.

nuclei of the two cells, which are now called, respectively, the male and female *pronuclei*, may, if both are mature, at once approach and fuse. In this case cell division follows after a time (Fig. 43). On the other hand (Fig. 44), the entrance of the sperm cell may take place before the egg cell has attained the necessary maturity, in which case the male pronucleus remains at one side until the maturation of the egg cell is complete and undergoes a slow growth in size by absorbing the fluid

from the cytoplasm of the egg cell. Then the two pronuclei approach each other. At the same time the centrioles which were brought in with the sperm cell become active and a spindle is produced near the center of the egg cell. The two pronuclei meet at the equator of this spindle. Chromosomes are formed in each, the nuclear membranes disappear as in an ordinary mitosis, and the two sets of chromosomes gather on the equator of the spindle, producing an amphiaster stage. Then the steps which are seen in ordinary mitosis occur in regular order, including metaphase, anaphase, and telophase, the final result being a division of the cell. This division initiates the development of the embryo. Fertilization may be said to be completed when the sperm cell enters the egg cell, when the two nuclei fuse, or, in the case last described, when the two nuclei cease to retain their identity and the chromosomes which develop from them come to lie in the equatorial plane of the spindle.

In either of the cases described above, the chromosomes from the two parent cells appear clear and distinct and when they divide in the metaphase, each of the two groups of chromosomes which pass to the two poles of the spindle is half maternal and half paternal in origin. When at the end of the telophase the nuclei of the two daughter cells enter into a resting condition, these chromosomes lose their identity; but in each cell division which will follow in the development of the individual which is to be produced, the maternal and paternal chromosomes again appear. Thus the individual represents a mingling of the characteristics of the two parents, and each cell in the body has this mixed inheritance. As might be expected, the steps given above are varied in many ways in different types of animals but the essential facts remain the same.

140. Chromosome Reduction.—It now becomes evident why chromosome reduction occurred in gametogenesis. Every species of animal has a characteristic number of chromosomes, a number which is found in every somatic cell in the body and remains constant generation after generation. This number seems to have no relationship to the structure of the animal or to its rank in the scale of animal life. For instance, there are 2 chromosomes in a parasitic worm (*Ascaris*) found in the horse, 8 in the fruit fly, 28 in the spotted salamander, 48 in man, and 208 in two species of crayfish. If the numbers of chromosomes were not reduced in the maturation of sex cells, the fertilized egg cells would contain twice the number possessed by the cells of the parents, and their number would continue to double with each succeeding generation. Chromosome reduction, however, results in passing on the same number from one generation to the next. In all references to chromosomes up to this point only those which act as mates in synapsis have been considered. There are odd chromosomes which in meiosis pass to either

one or the other of the daughter cells. These are associated with the determination of sex and will not be considered until Chap. LXXIII is reached.

141. Significance of Synapsis.—In all of the somatic cells of the body the chromosomes of maternal and paternal origin remain separate in cell division, and since the corresponding ones from the two parents are similar, they appear in pairs of like chromosomes. In the process of synapsis in gametogenesis these like chromosomes unite, and this is followed by their separation again in chromosome reduction. In mitosis every chromosome is divided and the two daughter cells have the full, or diploid, number, but in meiosis whole chromosomes pass to the daughter cells, which thus acquire the haploid number. Since it is a matter of chance to which of the two poles of the spindle any particular chromosome goes, there is an assorting and chance distribution of chromosomes to the mature egg cell or sperm cell. Thus every individual not only represents a chance mingling of the chromosomes of its parents but also receives a chance selection from those of previous generations, the probable number received from each generation being progressively smaller in going back from one generation to the previous one. In one sense this union of the chromosomes in synapsis may be thought of as the final step in fertilization.

CHAPTER XXV

EMBRYOGENY

The word *embryogeny* may be defined as the development of an animal from the time when the fertilized egg cell begins to divide until the organism has acquired an organization comparable to that of the adult. Until that time it is an embryo, but afterward it receives different names in the different types of animals. Examples are the larvae of many invertebrates, the tadpoles of amphibia, the chicks of birds, and the

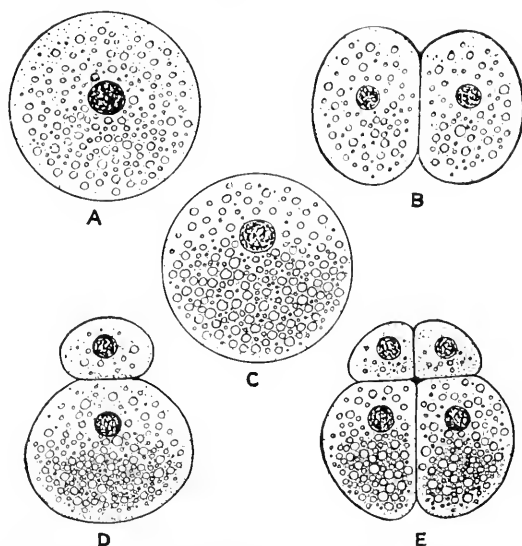

FIG. 45.—Diagrams of homolecithal egg cells and total cleavage. *A*, homolecithal egg cell with nearly uniform distribution of yolk. *B*, total equal cleavage resulting from the condition shown in *A*. *C*, homolecithal egg cell in which the yolk tends to accumulate toward the lower pole. *D*, total unequal cleavage of the egg cell shown in *C*, when the first cleavage plane is horizontal, resulting in the production of two unequal cells. *E*, cross section of an eight-cell stage, resulting from cleavage in *C* in a case in which the first two cleavage planes were vertical, giving rise to four equal cells, and the third was horizontal, producing four smaller cells at the upper pole and four larger at the lower. The protoplasm is stippled, the yolk indicated by the outlines of globules.

fetuses of mammals. Generally speaking, the higher the place of the animal in the animal kingdom the longer will be the embryogeny. Any particular embryogeny is a part of a corresponding *ontogeny*, which covers the development of the animal from the beginning until it reaches full maturity. The term embryogeny should not be confused with *embryology*, which is a broad science covering not only the embryogenies

of all animals but also a large amount of detail and generalization which is outside all embryogenies.

142. Types of Egg Cells.—A part of the process of maturation in the egg cell consists in the accumulation of yolk, but the amount of yolk thus stored and its distribution in the cell are not the same in all egg cells.

All egg cells show polarity. This is indicated by the polar bodies being formed at or near the upper pole and by the nucleus, which is always more or less excentric, being located nearer this pole. The opposite pole is called the lower pole.

In some cases the yolk is not very great in amount and is scattered throughout the cytoplasm. Such egg cells are termed *homolecithal* (Fig. 45 *A* and *C*). Most of the lower invertebrates and almost all of the mammals possess this type of egg cell, though in mammals the condition is not primary but secondary and is due to adaptation to the peculiar mode of development. In some homolecithal egg cells there

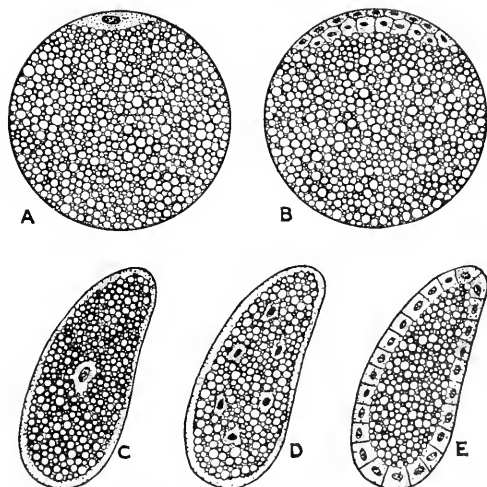

FIG. 46.—Diagrams of telolecithal and centrolecithal egg cells, and discoidal and superficial cleavage. *A*, telolecithal egg cell, in which the protoplasm is all at the upper pole. *B*, the discoidal cleavage which occurs in a telolecithal egg cell. *C*, centrolecithal egg cell, with a superficial layer of protoplasm, protoplasm around the nucleus, and strands of protoplasm connecting the two. *D*, the superficial cleavage of a centrolecithal egg cell; an early stage, when the nucleus has divided into several nuclei and each, with a portion of protoplasm about it, is migrating toward the periphery. *E*, later stage in superficial cleavage showing the nuclei and cytoplasm at the periphery, forming a superficial layer of cells, and the yolk at the center. The protoplasm is stippled, the yolk indicated by the outlines of globules.

is somewhat more protoplasm toward the upper than toward the lower pole and somewhat more yolk toward the lower than toward the upper pole.

In the egg cells of almost all vertebrates but the mammals, however, the yolk, which is present in very large amount, is massed toward the

lower pole, leaving the cytoplasm as a disc at the upper pole. In this case the egg cell is known as *telolecithal* (Fig. 46 A). In such egg cells the upper pole is called the *animal pole*; and the lower, the *vegetal pole*. Primitive mammals have telolecithal egg cells, and the ancestors of mammals doubtless had such egg cells.

In the insects a third arrangement is presented. Here the yolk occupies the central portion of the egg cell, inclosing within it, at the very center, the nucleus, which is surrounded by some of the cytoplasm, while the greater part of the cytoplasm forms a layer over the whole surface. Such an egg cell is called *centrolecithal* (Fig. 46 C). Here there is a considerable amount of yolk, though relatively not so much as in telolecithal egg cells.

143. Forms of Cleavage.—The process which follows fertilization and which results in the formation of a large number of cells from the fertilized egg cell is known as *cleavage*. The individual cells which are thus formed are termed *blastomeres*.

The effect of the difference in the amount and distribution of the yolk is seen in the different ways in which egg cells cleave. In an ideal embryogeny, which may be accepted as that of a homolecithal egg cell, the plane in which the first cell division takes place is typically meridional, passing from one pole to the other. The second cleavage plane is also meridional, being at right angles to the first, and results in the formation of four similar cells. The third cleavage plane, however, passes at right angles to the two others, and thus eight cells are produced. Of these the upper four will be smaller than the lower four. Since the whole egg has been involved in the cleavage, the egg is sometimes termed *holoblastic* and the cleavage is called *total*. If the yolk is quite evenly distributed and the cells which result from the cleavage are all approximately the same size, it is termed *equal* cleavage (Fig. 45 B). If, however, the yolk is not evenly distributed but is greater toward the lower pole of the egg cell, the cells at the upper pole will be decidedly smaller than the other four. This is termed *unequal* cleavage (Fig. 45 D and E). In some cases the two cells first formed differ in size, the first cleavage plane being horizontal and the smaller cell being above the larger. In other cases the difference in the size of the cells does not develop until the third cleavage occurs, the upper four being smaller than the lower. There are many modifications of these different types

In telolecithal and centrolecithal egg cells the cleavage planes do not pass entirely through the cell but only through the cytoplasmic portion, and thus the cleavage becomes *partial*; such egg cells are often termed *meroblastic*.

In telolecithal egg cells the division of the cytoplasm results in an embryonic disc at the animal pole, and accordingly the cleavage is termed *discoidal* (Fig. 46 B). As development proceeds and the cells continue

to multiply in number, this disc gradually surrounds the yolk, which is finally absorbed by the growing embryo.

In centrolecithal egg cells the nucleus in the center of the cell divides repeatedly, each of the daughter nuclei being surrounded by a little mass of cytoplasm. As these nuclei increase in number they migrate toward the periphery, accompanied by the bits of cytoplasm, and enter the superficial cytoplasmic layer. Now division of the cytoplasm takes place by planes which cut it at right angles to the surface, and this for a time leaves each cell open toward the yolk in the center. A little later the walls of these cells become complete. Because a superficial layer of cells is in this way formed around the yolk it is termed *superficial cleavage* (Fig. 46 *D* and *E*).

144. Steps in Embryogeny.—In the ideal embryogeny (Fig. 47) previously referred to as that of a homolecithal egg cell, cleavage may be conceived as resulting in the development of a compact mass of cells which, because of its general resemblance to the fruit of the mulberry tree, has been called a *morula*.

As the multiplication of cells continues, a cavity begins to form in the mass. The embryo is then called a *blastula*. This cavity increases in size until the blastula appears like a hollow rubber ball, the cells or blastomeres forming the wall, which is now called the *blastoderm*. The central cavity is variously known as the *cleavage cavity*, segmentation cavity, or blastula cavity and also as the *blastocoel*. The blastoderm in a typical blastula is a single layer of cells, but in certain cases it is made up of more than one layer.

As cell division is still going on, the blastula tends to increase in size with the increasing number of cells in the blastoderm, but these cells differ in size and also in the rapidity of their multiplication. Those toward the upper, or animal, pole are the smaller ones and are multiplying more rapidly, whereas those toward the other pole are larger and are multiplying more slowly. This unequal growth causes an expansion of the upper wall of the blastula and leads to an invagination of the lower cells, the blastula thus becoming converted into a double-walled inverted cup. As soon as this invagination begins, the embryo is termed a *gastrula*. As the gastrula develops further, the two walls come gradually closer together until finally the cleavage cavity becomes entirely obliterated. This process is called *gastrulation*, the cavity formed is known as the *archenteron*, or primitive digestive cavity, and the opening into it from the outside is termed the *blastopore*. The gastrula is thus made up of two layers of cells; the one forming the outer wall of the cup is called, because of its position, the *ectoderm*, and the one within, forming the lining, is known as the *entoderm*, or endoderm.

Now a third layer of cells appears between the two others, being developed in some cases from the ectoderm and in others from the

entoderm. This third layer is termed *mesoderm*. If the mesoderm is composed of a meshwork of scattered cells which have passed from either of the other layers into the blastocoel, it is known as *mesenchyme* (Fig. 47 *I*). In the embryogenies of certain animals the mesoderm cells are formed by an outpocketing of entoderm cells, which pushes into the space between the entoderm and ectoderm (Fig. 48). In those of other animals they are separated from the wall of the archenteron as solid masses of cells, which later become hollow. In both of the latter cases the cells surrounding these cavities form *mesothelium* (Fig. 48 *H* and *I*).

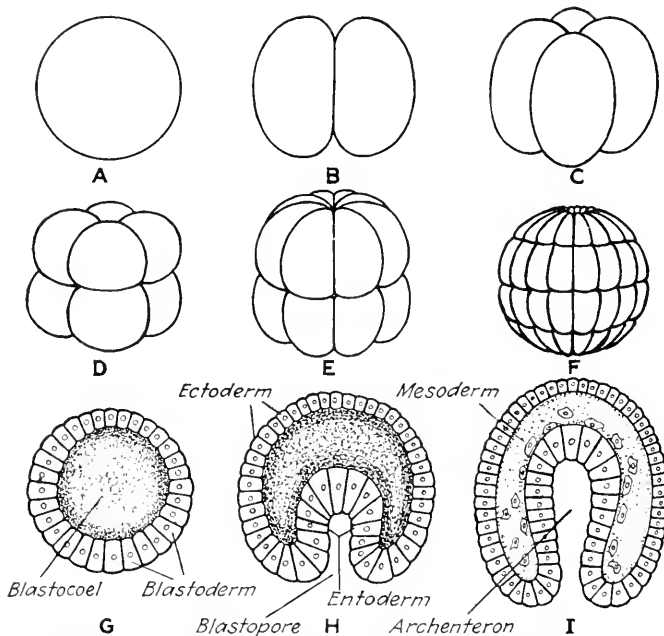

FIG. 47.—Diagrams illustrating the steps in an ideal embryogeny. *A*, the egg. *B*, the two-cell embryo. *C*, the four-cell stage. *D*, the eight-cell stage. *E*, the sixteen-cell stage. *F*, the morula, a solid mass. *G*, section of the blastula, with the blastocoel. *H*, section of the gastrula. *I*, gastrula in which the mesoderm cells are appearing in the blastocoel. These mesoderm cells will form mesenchyme.

From the three *germ layers* tissues are developed. The tissues then become arranged to form organs, the process being termed *organogeny*.

This series of stages and processes may be outlined in the following manner:

First stage: The egg cell (normally previously fertilized).

First process: Cleavage, or segmentation.

Second stage: The morula.

Second process: Formation of the cleavage, or segmentation, cavity.

Third stage: The blastula (*monoblastic*, or one-layered, embryo).

Third process: Development of the archenteron, or gastrulation.

Fourth stage: The gastrula (*diploblastic*, or two-layered, embryo).

Fourth process: Appearance of a third layer.

Fifth stage: The *triploblastic*, or three-layered, embryo (not given a particular name).

Fifth process: Tissue formation.

Sixth process: Organogeny (development of organs).

It should be remembered that the stages are not stopping points, that each of the processes lasts for a considerable time, and that the whole forms a continuous development. As the cleavage cavity first appears, the embryo is spoken of as an early blastula; as it increases in size, an older blastula; and just before invagination begins, a late blastula. In the same way reference may be made to an early and a late gastrula.

145. Variations in Embryogeny.—Since egg cells differ so much in the amount and distribution of the yolk it will be clear that many variations in the course of embryogeny are bound to occur, and all the steps in the ideal embryogeny described cannot be expected to appear in any actual individual embryogeny. Different types of cleavage have been previously noticed. In total cleavage the blastomeres may be spirally instead of regularly arranged. It is then called *spiral cleavage*. When the yolk is reduced to a minimum and the blastomeres are in contact by only a small area, there may be no morula stage but cleavage may result in the immediate development of a gastrula (Fig. 48). When the yolk is so abundant that the cleavage cavity is reduced to only a slit, invagination becomes impossible, and the resulting overdevelopment of the cells at the animal pole causes an outfolding. This is known as gastrulation by *epibole* (Fig. 253*G*). The archenteron is formed under this fold, which may gradually grow around and envelop the whole embryo. In the case of the mammal, as will be seen later, a very marked change in the character of the embryonic stages results from the condition which involves the attachment of the embryo to the wall of the maternal uterus and its nourishment from the blood vessels of the mother.

146. Germ Layers.—Reference has been made to three germ layers. The blastoderm, appearing in the blastula, gives rise in the gastrula to the ectoderm and entoderm, and the mesoderm is added in the triploblastic embryo. These layers, in all Metazoa but the sponges, retain this relative position, and from each arise a certain number of tissues.

The tissues derived from the ectoderm include the epithelial covering of the body, often known as the epidermis, which may extend inward a short distance at the external opening or openings of the digestive cavity or canal. They also include the epithelium lining all hollow organs the cavities of which open to a surface covered by epidermis. This includes such cavities as the external ear, the nasal chamber, and the spaces under the eyelids. All nervous tissues are also derived from the ectoderm.

From the entoderm is derived the epithelium lining the digestive cavity or canal, except at the open ends; also the epithelium lining all hollow structures formed as outpocketings of this cavity or canal. This latter category includes, in the air-breathing vertebrates, not only the

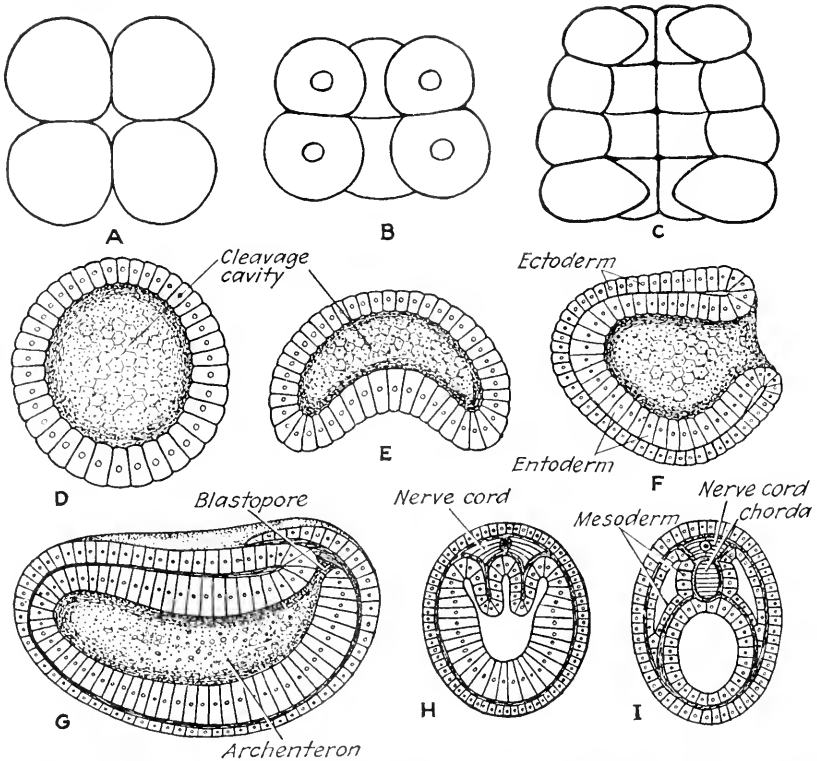

FIG. 48.—Stages in the development of amphioxus, one of the lower chordates. (Drawn from Ziegler models, based on the work of Hatschek.) A, the four-cell stage, polar view, showing a crevice between the cells. B, cross section through the opposite cells of an eight-cell stage, showing a median space. C, a median section of the 32-cell stage; the median space is developing into a blastocoel and the embryo is becoming a blastula without passing through the morula stage. D, cross section of the blastula. E, invagination. F, the gastrula has become asymmetrical and has turned on its side; the dorsal surface is flattened, the ventral convex. G, the diploblastic embryo, showing the ventral ectoderm growing over the blastopore and upon the dorsal surface, covering in the dorsal ectodermal cells which will form the central nervous system. H, cross section of a later stage, showing the chorda, or notochord, arising as a median dorsal outpocketing of the wall of the archenteron, and the mesoderm developing from dorsolateral outpocketings of the entoderm. I, cross section of a later stage, showing the central nervous system, the chorda, and the enteron in the median line, and on each side a mesodermal pouch, containing a coelomic cavity. The walls of this pouch are mesothelium.

linings of cavities of such organs as the liver and pancreas but also the lining of the so-called respiratory tract, consisting of the lungs and the passageways leading from the pharynx to them.

From the mesoderm are developed all of the other tissues of the body, including muscles, connective and supporting tissues, the blood vessels

and the blood which they contain, and the epithelial lining of all cavities developed in this layer. The mesodermal tissues in higher forms far exceed in bulk those from the ectoderm and entoderm combined.

It will be observed from what has been said that an epithelium may be derived from any one of the three layers. The epidermis is ectodermal in origin, the epithelium lining the greater part of the digestive cavity is entodermal, and the epithelium lining the cavities within the mesoderm, including the lining of the heart and blood vessels, is mesodermal. Skeletal parts may be formed not only from the mesoderm but sometimes from the ectoderm, and even in rare cases from the entoderm.

147. Coelom.—Any cavity formed in the mesoderm and surrounded by mesothelium is known as a *coelom*. When it is present the sex organs become developed from its wall and the excretory organs open into it. It is lacking in the lower Metazoa but it is present in most of the higher forms, in which it may be divided into several cavities. The layer of the mesoderm outside the coelom and lying against the body wall is called *somatic*; that inside the coelom and lying against the viscera, *splanchnic*.

Since three cavities develop during the embryogenies of higher animals it is well to bring them into contrast, as may be done in the table which follows:

Name of cavity	Time of appearance	Lining of wall	Fate
Segmentation or cleavage cavity.....	Blastula	Blastoderm	Disappears as the next is formed
Archenteron.....	Gastrula	Entoderm	Becomes the digestive cavity of the adult
Coelom.....	Triploblastic embryo	Mesoderm (mesothelium)	Becomes in the adult the body cavity and cavities derived from it

PART IV
METAZOAN PHyla

CHAPTER XXVI

SPONGES

THE PHYLUM PORIFERA

In the ocean are found many animals which would not be recognized as such by the ordinary observer, since they have neither power of movement nor power of locomotion, and since they form inert masses attached to various solid objects including the shells of other living animals. In many cases these are sponges, though some ascidians (Sec. 338) would fit the description. Sponges were long supposed to be plants and their animal nature was not fully established until about 1857, since which time they have been variously classified in the animal kingdom.

148. Relationship of Sponges.—

In many respects sponges are like colonial protozoans. For instance, they possess collar cells (Fig. 49) which are similar to the collared cells of the colonial flagellate protozoan, *Proterospongia* (Fig. 27A). On this account the sponges were for a time classified as colonial flagellate Protozoa. They differ from them, however, in the fact that the body is penetrated by a system of canals, whereas in colonial Protozoa the cells are upon the surface of the mass formed by the colony. They also differ in the fact that there are a number of different types of nonreproductive, or somatic, cells which perform different functions. In this respect sponges resemble higher animals. They have, therefore, been considered for some time to be Metazoa.

Sponges differ fundamentally from other Metazoa by not having any digestive cavity, which is present in some form in all higher animals except where lost from degeneration. Instead, digestion is always intracellular, or within the cells, as in Protozoa. Neither do they have body layers corresponding exactly to those in other Metazoa, in which ectoderm, mesoderm, and endoderm retain from the beginning the same relative position in the body. In the sponges the layer which appears in the embryo as an ectodermal layer comes in the course of development to line central cavities and to have the function of circulating water

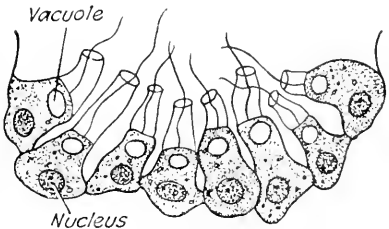

FIG. 49.—A number of collar cells, or choanocytes, from one of the flagellated chambers of a fresh-water sponge, *Spongilla lacustris* (Linnaeus). (From Borradaile and Potts, "The Invertebrata," after Vosmaer, by the courtesy of The Macmillan Company.)

through the body instead of carrying the animal about. These same cells are also digestive. In all other Metazoa digestion is carried on by cells of entodermal origin. In the sponges the layer which at the beginning seems to be entoderm comes to lie on the surface of the body and to perform the functions which we generally associate with ectoderm. The middle layer is not differentiated in the way the mesoderm is in all triploblastic animals and so is not recognized as a germ layer. The sponges are, if anything, diploblastic, but this term is not strictly applicable because of the difference in the manner of development of the two body layers. In view of these facts it seems best to include sponges in the Metazoa but to separate them as a distinct group from all the rest and to call them Parazoa—literally, animals set off at one side. The rest of the Metazoa are called Enterozoa, or animals with a digestive cavity. The group Parazoa contains but the one phylum, the Porifera.

149. Classification.—Porifera (pō rif' ēr ā; L., *porus*, pore, and *ferre*, to bear) is divided into three classes:

1. *Calcarea* (kāl kā' rē ā; L., *calcarius*, limy).—Sponges which possess spicules of carbonate of lime; all marine.

2. *Hexactinellida* (hĕx āk tī nĕl' lī dā; G., *hex*, six, *actinos*, ray, *ella*, Latin diminutive, and *eidos*, form).—Sponges with siliceous spicules having three axes; confined to the deep sea.

3. *Demospongiae* (dĕ mō spŭn' gī ē; G., *demos*, the people, and *spongia*, sponge).—Sponges with either spicules of silica, which are not triaxial, or a supporting framework of spongin, or both; mostly marine, but with a few fresh-water species.

150. Structure.—Various types of sponges differ greatly in their general form, in their size, and in their plan of structure (Fig. 50). Some are quite regular in shape, while others are irregular, being branched, often quite complexly so, fan-shaped, or cup-shaped. Some form raised masses, and others spread out like flat discs on the surface to which they are attached. Some are very small and are just visible to the naked eye, while others may be 5 feet in height. They are often brilliantly colored, and among the different species all colors may be seen. The shape of individuals of the same species is not always the same, though in a general way it conforms to a certain type; it may be much modified by environmental factors.

On the surface of the sponge are very many small openings called *ostia* and a much smaller number of larger ones known as *oscula* (Fig. 51). Water enters through the ostia and leaves through the oscula. All openings are surrounded by *spicules*, which appear like spines, and these may form a barrier over the ostia, protecting them from objects which might do injury to the sponge.

Within the body of simple sponges is a *gastral cavity* which opens by an osculum. In more complex sponges there may be many such cavities, each opening by an osculum.

151. Canal Systems.—In sponges there are three principal types of canal systems, known as the ascon, sycon, and rhagon types (Fig. 51), of which the *ascon* is the simplest. The body of a sponge of this type has a thin wall which is penetrated by simple canals that run clear through to the gastral cavity. In this type flagellated cells line this cavity.

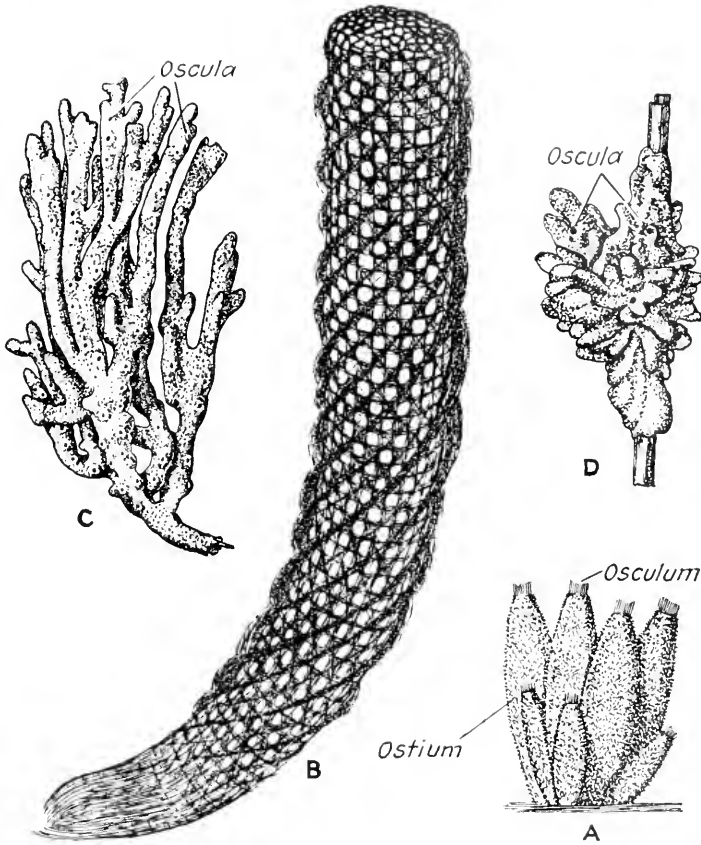

FIG. 50.—Different types of sponges. A, *Grantia ciliata* (Fabricius), one of the Calcarea, a simple sponge showing colony formation and budding. $\times 2$. B, skeleton of *Euplectella* sp., a hexactinellid sponge known as Venus' flower-basket, showing the form and general structure; the spicules are white and like spun glass. $\times 1\frac{1}{2}$. C, *Chalina oculata* Pallas, one of the marine Demospongiae. (From Minchin, in Lankester's "A Treatise on Zoology," by the courtesy of A. and C. Black.) $\times 3\frac{1}{2}$. D, *Ephydatia fluviatilis* (Linnaeus), a fresh-water sponge belonging to Demospongiae. (From Zacharias, "Die Tier- und Pflanzenwelt des Süsswassers.") $\times 3\frac{1}{2}$.

In the *sycon* type a more complex plan is presented, with incurrent and radial canals. The ostia lead into incurrent canals which do not open into the gastral cavity; radial canals open into the gastral cavity but not to the outside. The two types of canals lie side by side and are connected by minute pores. The radial canals are lined with the flagellated cells.

In the *rhagon* type the animal is much larger and the whole body forms a rather thick mass penetrated by a complexly branched canal system. In the fresh-water sponges, which may be taken to represent this type, the ostia lead into subdermal cavities. From these cavities incurrent canals run to chambers lined with flagellated cells. After the water has passed these flagellated cells it is carried by excurrent canals into a gastral cavity, which opens to the outside by an osculum.

152. Skeleton.—The classification of the sponges depends upon the character of the skeleton, which may be made up of spongin or of spicules. The spicules may be either calcareous or siliceous and differ in shape in the different forms. *Spongin* is a substance which chemically is similar to silk and which is formed by cells known as *spongoblasts*. Spicule-

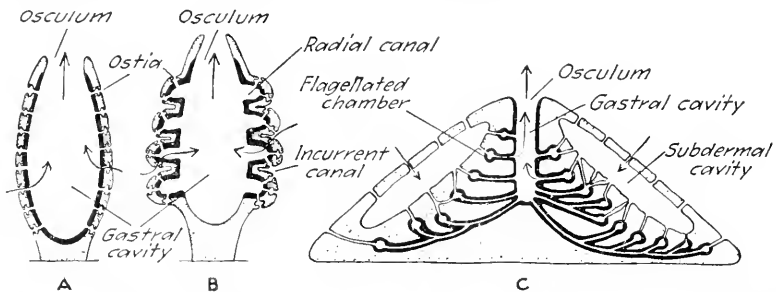

FIG. 51.—Diagrams of canal systems of sponges. A, ascon type. B, sycon type. C, rhagon type. (From Wieman, "General Zoology," A and B after Minchin, and C modified from Parker and Haswell, by the courtesy of McGraw-Hill Book Company, Inc.) The gastral epithelium is shown by heavy black, the dermal epithelium by a light line. Arrows show water currents.

forming cells are *scleroblasts*. The spicules may be straight rods with one axis, the *monaxon* type; or they may have three rays in one plane and be *triradiate*; or four rays lying in four planes, in which case they are known as *tetragon*. They may have six rays, the ends of three axes, in which case they are *triaxon*; or they may have numerous rays and be *polyaxon* (Fig. 52). Many modifications of each type occur.

153. Histology.—There are in the bodies of sponges a number of different types of cells. In the outer, or so-called *dermal layer*, are flat epithelial cells, contractile cells, gland cells which secrete the material that attaches the animal to its support, and the cells which form the skeleton. In the *middle layer* are reproductive cells and wandering cells, the latter capable of ameboid movement. The cells of the *gastral layer* are flat epithelial cells or collar cells. These cells, however, do not work together to the same degree as do the cells in higher animals. The whole is really a great colony of semi-independent cells, and individuality is so little evident that zoologists have not agreed upon what constitutes an individual. H. V. Wilson has found it possible, by gently squeezing sponges through the meshes of fine silk cloth, to separate them into individual cells. These cells will then gather together in small groups

and each group will grow into a sponge. This illustrates the semi-independent character of the cells.

154. Metabolism.—Metabolism is carried on practically in the same manner as it is in Protozoa. That there are, however, different enzymes acting on proteins, carbohydrates, and fats seems to be generally accepted.

The food of sponges consists of minute plants and animals and also small particles of organic matter which are drawn into the ostia and through the canals by currents produced by the movement of the flagella of the collar cells. As this current sweeps these objects past the collar cells they are seized upon by the cells and ingested by means of pseudopodia. The current of water proceeds onward into the gastral cavity and out of the body through the osculum. The food which has been taken by the collar cells is digested in food vacuoles in the same manner as it would be digested by protozoans. Further steps in metabolism also occur like those in protozoans. Each cell excretes and respire for itself. The cells which are not collar cells receive their food more or

less directly from the latter by absorption from cell to cell, aided by the ameiboid wandering cells, which serve to carry both food and waste matter about the body.

155. Behavior.—Little is known of behavior in sponges generally. The larvae are ciliated and swim about, but the adults are attached and never move from their position. Some sponges possess fiber-like cells around the ostia and oscula which are capable of slowly contracting and closing these openings or of relaxing and permitting them to open. The opening and closing are so gradual, however, that they do not attract notice unless particular attention is given to them. These openings tend to open when the water is in motion but close when the water becomes quiet; they also open in fresh water and in weak solutions of atropin and close on exposure to the air or on injury to the animal or when the animal is subject to the experimental action of weak solutions of ether and cocaine. These fiber-like cells, since they have the function of both receiving stimuli and contracting in response to them, are termed *neuromuscular* cells. Because groups of these cells surround openings which are closed by their contraction, the group is termed a *sphincter*. (This term is also applied to all muscles closing openings in the bodies of higher

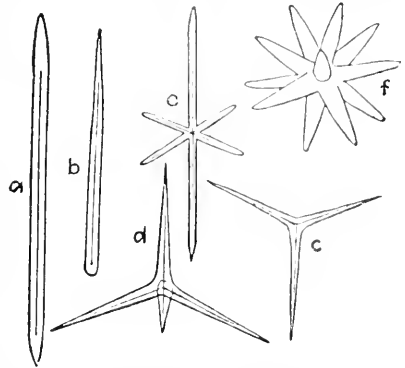

FIG. 52.—Types of spicules. (From Sollas, "Cambridge Natural History," by the courtesy of The Macmillan Company.) a and b, monaxon; c, triradiate; d, tetraaxon; e, triaxon; f, polyaxon.

animals and man, such as the muscle which shuts off the stomach from the intestine, that which guards the exit from the bladder, and that which controls the passage of egested matter from the posterior end of the alimentary canal.)

156. Reproduction.—Reproduction is both sexual and asexual. The asexual mode of reproduction involves the gradual formation of buds which arise near the point of attachment of the parent. After growing for a time thus attached a bud may separate and begin an individual existence. If budding continues and the individuals remain together, a colony is produced (Fig. 50 A).

In addition to budding, some sponges have the ability to form *gemmules*. These are groups of cells which gather together in the middle layer and become surrounded by a siliceous shell. They are formed when living conditions become difficult and thus preserve the life of the organism during such periods. In the fresh-water sponges gemmules are formed in the autumn, after which the adults die, and in the spring the gemmules develop into new sponges (Fig. 53).

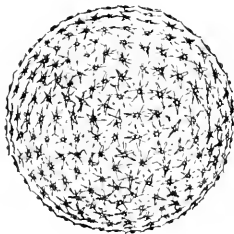

FIG. 53.—A gemmule of a fresh-water sponge *Ephydatia fluviatilis* (Linnaeus). (From Potts, *Proc. Acad. Nat. Sci. Philadelphia*, 1887.) The gemmule is covered by a chitinous shell in which are imbedded spicules. \times about 100.

Sexual reproduction also occurs, both egg cells and sperm cells being formed in the same animal. These sex cells lie in the jelly-like middle layer where fertilization takes place. An embryo is formed which escapes through the wall of the body and becomes a free-swimming ciliated larva. This later settles down and develops into a sponge.

157. Uses of Sponges.—The cleaned skeletons of those sponges which are composed entirely of spongin are familiar because of their many domestic uses. Among these are bath sponges and the surgeons' sponges used to take up blood and other fluids in surgical operations. Though today artificial sponges are made which in many cases take the place of natural ones, there is still a large market for the latter.

158. Cultivation of Sponges.—The best commercial fibrous sponges come from the coast of the Mediterranean Sea, from the shores of Florida and the West Indies, and from Australia. They are gathered by means of long-handled hooks, by dredging, or by divers. They are then allowed to decay, are washed, dried, bleached more or less, and sent to market.

Sponge culture is now carried on in several localities but most successfully in Italy and Florida. Commercial sponges do not flourish where the water is cold. The place selected for this purpose must have a clean bottom and must be exposed to currents which bring an abundant supply of well-aerated water and food. Specimens of the variety of

sponge to be cultivated are secured, cut into small pieces approximately one inch square, and fastened either to stakes or to sunken cement plates. From these pieces grow complete sponges which are ready for the market in a few years, the time depending upon the character of the sponge grown and the conditions. When the sponge is gathered, the part that remains after most of it is cut away will continue to grow and develop into another sponge.

159. Relations to Other Animals.—Sponges are used as food by very few animals, their spicules and the unpleasant character of their excretions rendering them objectionable. Because of this fact many other animals take refuge in sponges. The excretions of sponges also play a part in the disintegration of the empty shells of mollusks, the lime of which is thus turned back into the sea water to be used over again by other animals.

CHAPTER XXVII

HYDRA

A TYPE OF THE PHYLUM COELENTERATA

Hydras are abundant in bodies of fresh water everywhere and are excluded only from those where the water is foul or the temperature too high. They flourish in those which are clear, cool, and relatively permanent. Wherever they occur they may be found attached to solid objects in the water, such as leaves or stones on the bottom, dead tree branches

or weed stems, stakes and posts, living vegetation, or the undersurfaces of floating inanimate objects or plants. In any of these situations they will be found extending at right angles to the surfaces to which they are attached and, when hungry, with their bodies and tentacles stretched to the limit. When thus extended, the total length of the body and tentacles may reach two inches or even more. When the object to which it is attached is lifted from the water, the animal contracts and appears like a very small mass of green, brown, or white jelly, depending upon the species under observation.

160. External Features.—When examined under a hand lens, a hydra is seen to possess a tubular body which when it is extended is of a practically uniform diameter but which when it is contracted assumes an approximately spherical shape (Fig. 54). The attached end of this body is known as the *basal disc*. The power of attachment is due to an adhesive substance produced by gland cells in this disc. The free end of the body bears a ring of *tentacles* varying in number.

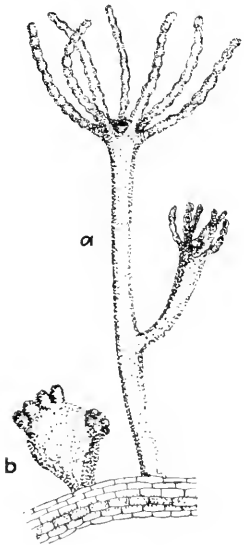

FIG. 54.—*Hydra viridissima* Pallas. A specimen possessing a bud, shown in *a* partially extended, and in *b* fully contracted. \times about 12.

Inclosed by these tentacles is a conical projection called a *hypostome*, at the apex of which is the slitlike mouth. Frequently one or more *buds* will be seen projecting from the side of the body, and a bud, if well-developed, may possess its own mouth, hypostome, and tentacles. On rare occasions there may be observed on the body of a hydra projections which are temporary reproductive structures. If these are conical and are situated nearer the tentacles

they are *spermaries*, or testes; if they are more knoblike and are situated nearer the base they are *ovaries* (Fig. 55).

161. Internal Structure.—When studied by means of sections (Fig. 55) in which the structure is brought out by appropriate staining, the hydra is seen to be made up of a body wall surrounding a large central

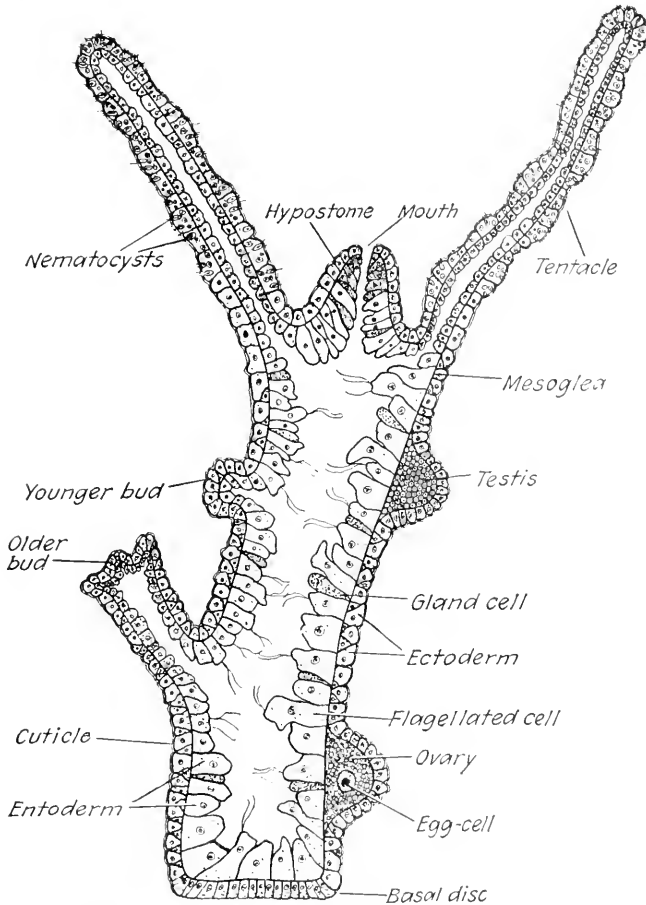

FIG. 55.—Somewhat diagrammatic longitudinal section of a hydra, showing two buds differing in age on the left, and a spermary and ovary on the right. Batteries of nematocysts are to be observed on the tentacles. In the gastrovascular cavity the entoderm is seen to be made up of flagellated cells, cells bearing pseudopodia, and gland cells. A delicate cuticle covers the ectodermal layer.

cavity known as the *gastrovascular cavity*, or *enteron*, which opens to the outside through the mouth. The gastrovascular cavity also extends outward into each tentacle, reaching nearly to the tip, though the canal so formed is very narrow.

The wall of the body and that of the tentacles is composed of two layers of cells separated by an extremely thin sheet of noncellular material

known as mesoglea. The outer cell layer is made up of smaller cells varying in shape, though typically cubical, the outer ends of which form a fairly even surface covered by a delicate cuticle. This layer is known as the *ectoderm* and includes a number of different types of cells which are scattered and not associated in such a way as to form tissues. Among these cells are epitheliomuscular cells, from which arise contractile fibers; sensory and nerve cells, of which conducting fibers in the mesoglea are branches; irregular interstitial cells; and on the basal disc, gland cells. The inner cell layer, known as the *entoderm*, is composed of short columnar cells of larger size and more irregular shape. The surface of the entoderm is neither so even as is that of the ectoderm nor does it possess a cuticle. In this layer are epitheliomuscular cells, nerve cells, and gastric gland cells. In the tentacles the cells of both layers become much shorter and the whole wall very much thinner.

The *mesoglea*, which is the layer between these two cell layers, is composed of several elements: (1) a supporting lamella, jelly-like in consistency, secreted by the cells of the two other layers, and giving a certain degree of support to the body; (2) two networks of nerve fibers, derived from the nerve cells in the two cell layers; (3) contractile fibers, prolongations of the epitheliomuscular cells in both ectoderm and entoderm.

162. Nematocysts.—Interstitial cells in the ectoderm of the body in which are formed nematocysts are known as *cnidoblasts*. A *nematocyst* (Fig. 56) consists of a sac of fluid within which is coiled a thread. When fully developed, the cnidoblast also possesses a projecting, sharply pointed *cnidocil*. As the cnidoblasts approach full development they migrate to the surface, and the projecting cnidocil, when it is stimulated, causes the nematocyst to react. In this reaction the coiled thread is thrown out, probably as a result of increased pressure within the sac. In one kind of nematocyst this thread is sharply barbed and carries a poison which serves to anaesthetize the animal into which it is discharged. In another type the thread is barbless, elastic, and becomes coiled around the object against which it is discharged (Fig. 56 *E*). By thus coiling around the spines and hairs of the prey these nematocysts impede its movements. No cnidoblasts seem to originate on the tentacles themselves, but great numbers migrate from the place of origin in the body to the tentacles, where the nematocysts can be used most effectively in the capture of food.

163. Neuromuscular Mechanism.—While the hydra cannot be said to possess tissues, much less organs and systems, there are developed definite mechanisms out of the variety of cells which the body possesses. Among these is the neuromuscular mechanism. This is made up of the scattered sensory cells lying on the surface of both ectoderm and entoderm; of the nerve cells, which with their processes form conducting

networks (Fig. 57); and of the contractile fibers of the epitheliomuscular cells. The sensory cells receive stimuli and the contractile fibers cause a modification in the form of the body. The contractile fibers connected with the ectoderm run longitudinally and those of the entoderm transversely, the two sets thus acting like longitudinal and circular muscles. These fibers are not found in the tentacles, which are extended by water forced into them from the enteron. The circular contractile fibers also

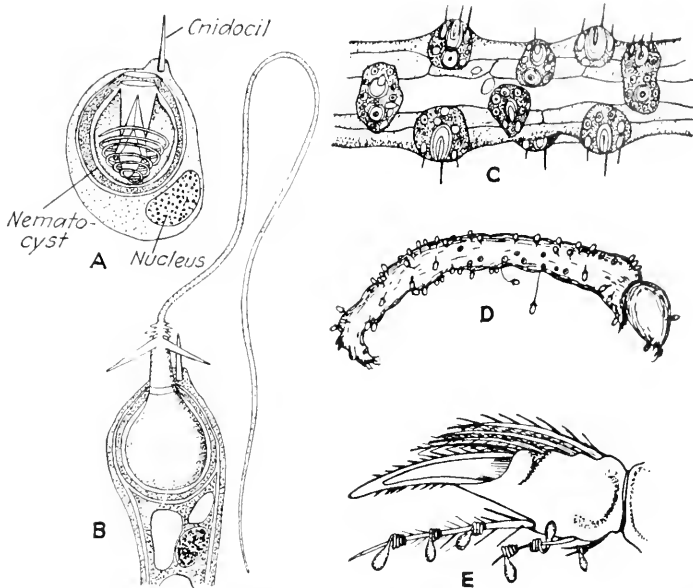

FIG. 56.—Sketches illustrating nematocysts and their action. A, a cnidoblast containing an undischarged nematocyst and possessing a cnidocil. B, the same with the nematocyst discharged. (A and B from *Dahlgren and Kepner, "Principles of Animal Histology," after Schneider.*) C, portion of a tentacle, showing the batteries of nematocysts. D, an insect larva covered with nematocysts as a result of capture by a hydra. (C and D from *Jennings, "Behavior of the Lower Organisms,"* by the courtesy of Columbia University Press.) E, last segment of the leg of a small aquatic animal, with nematocysts of a barbless type shown coiled about its spines; this impedes the movements of the animal. (From *Hegner, "College Zoology,"* after Toppe.) (A, B, and E are by the courtesy of The Macmillan Company.)

tend to be concentrated around the mouth and at the base of each tentacle, where they act like sphincters. The nerve cells seem to be most numerous around the basal disc and on the hypostome, which indicates a certain degree of localization of nervous activity. Owing to the more complete network formed by its nerve cells, the ectoderm is more active and its movements are more definitely coordinated than are those of the entoderm.

The nematocysts seem to be stimulated directly by chemicals in the water, such as the secretions from the body of the animals which serve as prey, and not by the nervous mechanism.

164. Metabolism.—The food of the hydra consists of any animal sufficiently small and weak that it may be held by the tentacles, anaesthetized by the poison of the nematocysts, and brought to the mouth into which it is passed. Small insect larvae and crustaceans form the bulk of the food. After being ingested the food is digested in the enteron by means of enzymes formed by the gland cells of the entoderm. This type of digestion, which is met here for the first time, is termed *extracellular digestion*. The hydra also possesses *intracellular digestion*, particles of food being taken into the entoderm cells by means of pseudopodia and

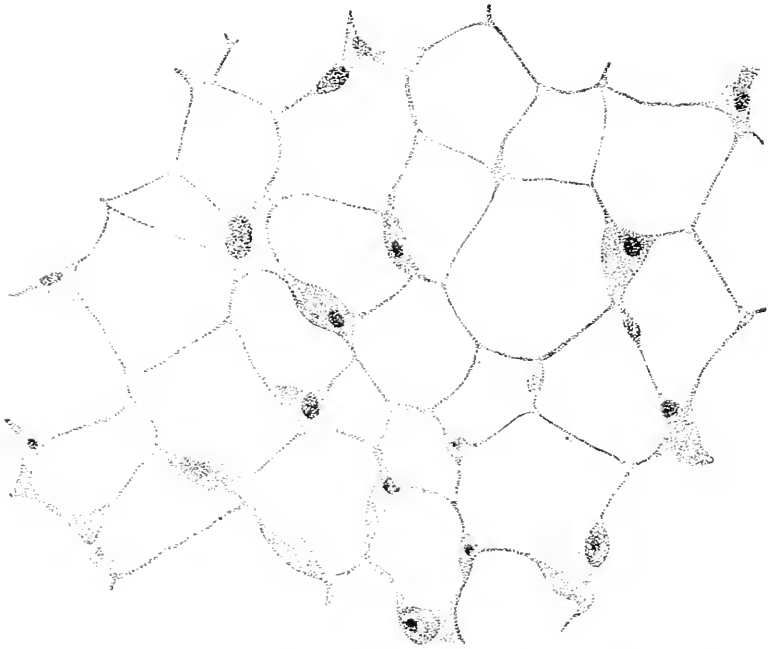

FIG. 57.—Nerve net of *Hydra oligactis* Pallas. (From Rogers, "Text-book of Comparative Physiology," by the courtesy of McGraw-Hill Book Company, Inc.) Highly magnified.

digested within food vacuoles. During the process of extracellular digestion the food is carried about in the enteron and mixed with the digestive juices; this circulation is due both to the movements of the body and to the currents formed by entodermal flagella. After digestion the food is absorbed into the entodermal cells and circulated by being passed from cell to cell. Secretion is performed by certain cells in both the ectoderm and the entoderm. Excretion is carried on by each cell for itself; and since the body consists essentially of two layers of cells, elimination and excretion become one process. Respiration, also, is carried on by each cell individually. Egestion takes place through the mouth, which thus functions also as an anal opening.

165. Behavior.—Hydras may be stationary for a time if conditions remain uniform and food is plentiful, but with changing conditions in the environment and the necessity of searching for food they usually exhibit considerable locomotor activity. When hungry the hydra will extend its body and tentacles, the latter being ready to grasp any food which comes in contact with them. If after a time no food is encountered, the animal moves to another location.

Locomotion may be accomplished in several ways: (1) One method is by a gliding movement, the basal disc sliding slowly over the substratum to which the animal is attached and at no time being free. (2) The animal may reach over with its tentacles and after attaching them may release the basal disc, bring it up close to the tentacles, and attach it once more, raising itself to an erect position in the new location. If this is repeated it represents a type of locomotion similar to that of a measuring worm. (3) Another way has been described as a modification of this method. The disc is released, carried clear over, and attached again beyond the tentacles, which causes the animal to turn a sort of handspring. (4) Finally, if the animal is dislodged, it may drop to the bottom and use its tentacles as if they were legs. When at the bottom of a pool it may form a gas bubble on its basal disc and by means of this rise to the surface.

Hydras respond to several conditions in the environment. To strong stimuli of any kind negative *responses* are given. To a nonlocalized stimulus, which is one that affects the animal as a whole, it responds by withdrawing its tentacles and contracting its body. To a localized stimulation, such as the contact of any moderate stimulus with a single tentacle or one particular point on the body, it responds by contracting the area affected, which may cause the withdrawal of that single tentacle or the bending of the body. But if the localized stimulus is a powerful one, the other tentacles and the rest of the body will be involved, and the reaction is then the same as that to a nonlocalized stimulus.

These animals respond to an optimum of light, which varies with different species. The green hydra possesses an optimum at a high degree of illumination, while the other species possess optima at a much lower light intensity. Hydras also possess a temperature optimum which is relatively low—that is, they flourish in cool water. They are found in abundance under the ice in winter but perish at a temperature which may be reached by a shallow pool exposed to the full warmth of the summer sun.

The response to chemicals depends upon the nature of the chemical. The animal avoids injurious chemicals and responds positively to those which indicate the presence of food. Chemotropism and thigmotropism both figure in the food-taking reaction, the feeding movements being much more vigorous if to the response due to contact with the struggling

victim is added the response to chemicals which may also be produced by it.

Hydras also exhibit varying *physiological states*, the reaction of a hungry hydra being distinctly different from that of one which has been fed. When a hydra has fed, it does not seem to be affected by such stimuli as would otherwise cause further food-taking movements and thus does not again feed until the digestion of its food has been completed and the undigested waste passed from the body.

166. Reproduction.—The hydra reproduces by both sexual and asexual methods, the latter being the one most commonly observed, and the former occurring only at times when conditions of existence become unfavorable.

Asexual reproduction is most frequently accomplished by *budding* (Figs. 54 and 55), buds being produced anywhere upon the body. They represent outpocketings of the whole body wall, the cavity of the bud being in direct connection with the enteron. As the bud grows, a mouth appears at its outer end and a ring of tentacles at the base of the hypostome. The bud becomes constricted at the point of attachment, separates entirely from the parent, and begins an independent existence. *Fission*, which is less frequent, is usually longitudinal, although cases of transverse fission occur.

In *sexual reproduction* temporary gonads are produced (Fig. 55). The gametes are developed from interstitial cells which accumulate at a certain place, multiply by repeated division, and give rise to oogonia or spermatogonia. In both the spermary and the ovary may be observed all of the steps in a typical gametogenesis. The sperm cells produced are exceedingly numerous and are set free in the water. In the ovary, however, one centrally located egg cell begins early to increase greatly in size at the expense of the other egg cells, feeding upon them and taking them into itself bodily. When this one cell becomes mature it occupies most of the space in the ovary. The ectoderm over it is ruptured, a sperm cell enters, and fertilization occurs. This fertilized egg cell, still in the ovary, undergoes total and equal cleavage. A hollow blastula is formed, which becomes converted into a solid gastrula by the filling in of the blastocoel by entoderm cells derived from the blastoderm. In the meantime a shell has been secreted about the embryo, which now breaks loose from the parent and falls to the bottom. Further changes involve cellular differentiation and the appearance of the mesoglea. Development proceeds at a rate varying with different environmental conditions. Finally, when these become favorable, the embryo increases in size and, as it elongates, ruptures the shell. Tentacles appear at one end, an enteron and a mouth are formed by the separation of the cells within, and the young individual gradually assumes the form and characteristics of the adult.

The same individual may produce both spermaries and ovaries at the same time, in which case self-fertilization is possible. They are usually not so produced, however, and cross-fertilization is the rule.

167. Symbiosis.—The green hydra, *Hydra viridissima* Pallas, exhibits an interesting association between a plant and an animal. Each cell of the hydra contains plant cells which are themselves individual one-celled plants belonging to a group known as algae. These plant cells possess chlorophyll and carry on photosynthesis. The association therefore represents a partnership in which both partners profit, the alga receiving carbon dioxide and nitrogen from the hydra and the hydra in turn being furnished with oxygen. Such an association is called *symbiosis*. By virtue of this condition the green hydra has its reactions somewhat modified, particularly its reaction to light, a liberal supply of which is needed by the algal cells.

168. Regeneration.—*Regeneration* is the replacement by an animal of any portion of the body which has been lost. It occurs naturally after an accident has befallen the individual, and it can be induced artificially by mutilation. In the hydra it readily occurs, and very small fragments may thus develop into complete animals. While regeneration may result in an increase in numbers, it is not a normal method of multiplication and cannot, therefore, be considered as reproduction. A hydra which has been partially divided into parts may regenerate in such a manner as to produce a compound animal with several hypostomes, each with a mouth and a ring of tentacles. Parts of two individuals may be grafted together, but they must be of the same species.

The hydra was the first animal known to have the power of regeneration, the discovery being made in 1744 by an Englishman named Trembley. It has been a favorite type for experimentation in this field ever since.

CHAPTER XXVIII

COELENTERATES IN GENERAL

The hydra belongs to a third phylum, known as Coelenterata, made up of animals which differ markedly from either Protozoa or Porifera and which, though they are very simple, agree in the general plan of structure with higher animals. This plan involves the existence of a central digestive cavity or enteron with a mouth opening into it. The wall of the body is made up of two cell layers, ectoderm and entoderm, which occupy the same relative positions as the corresponding germ

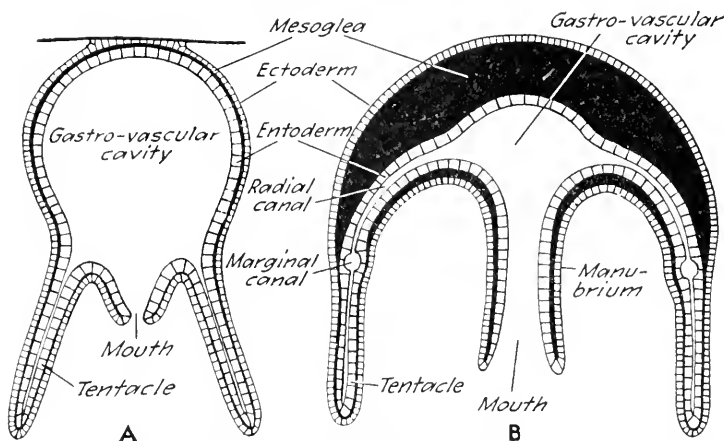

FIG. 58.—Diagrams illustrating the comparison of the structure of a polyp (A) with that of a medusa (B).

layers do in the embryo. For the reason that only two germ layers are considered to be represented, the coelenterates are termed diploblastic and may be compared to the gastrula stage in the development of higher animals. In some cases, as in certain sense organs, collections of similar cells form simple tissues, but there is no development of true organs. The coelenterates have a radial type of symmetry, the number of antimeres varying in different groups but tending to be of an even number. Another characteristic of all coelenterates is the presence of nematocysts, which have already been described.

169. Polyps and Medusae.—Coelenterates exist in the form of two general types. Those of the type known as *polyps* are attached to some object. They have a mouth and almost without an exception possess a ring of tentacles at the free end. Those of the *medusa*, or jellyfish,

type are free-swimming. Typically they have a bell-shaped body, with a ring of tentacles around the margin of the bell, and a mouth, which also may be surrounded with tentacles, in the center of the lower surface.

Neglecting the many various modifications of both the polyp and the jellyfish types, a typical polyp and a typical medusa may be directly compared (Fig. 58). If one should imagine a polyp to be turned over with the mouth directed downward; to be greatly broadened by lateral extension of the body, which becomes bell-shaped; to have the tentacles carried out to the margin of the bell; and then to show a great increase in the amount of mesoglea, one would have an animal with some of the marked characteristics of a jellyfish. The digestive portion of the enteron lies more or less in a projecting *manubrium* which hangs down like a clapper in the bell and at the tip of which is the mouth. The increase in the amount of mesoglea, which is almost all water, lessens the specific gravity of the body so that it is very little more than that of water. This enables the jellyfish to float easily. The increase in the amount of mesoglea, however, renders necessary the development of a system of canals to put the enteron in communication with all parts. This need is met by radial canals leading from the central enteron outward to a circular marginal canal, the latter in turn being in communication with the canals of the tentacles.

170. Classification.—The phylum Coelenterata (sèl ěn tēr ā' tà; G., *koilos*, hollow, and *enteron*, intestine) is divided into three classes:

1. *Hydrozoa* (hī drō zō' à; G., *hydra*, water serpent, and *zoon*, animal). Includes fresh-water hydroids, colonial marine hydroids, floating hydroid colonies like the Portuguese man-of-war, some of the smaller jellyfishes, and the polyps which produce the stag-horn coral.

2. *Scyphozoa* (sī fō zō' à; G., *skyphos*, cup, and *zoon*, animal).—Includes the larger jellyfishes.

3. *Anthozoa* (ăn thō zō' à; G., *anthos*, flower, and *zoon*, animal).—Contains the sea anemones, most of the coral-producing polyps, and also those colonial forms known as sea fans and sea pens.

171. Hydrozoa.—Among Hydrozoa the polyp type prevails. The hydra is an example of this group. Though they may be variously modified, hydrozoan polyps are always comparatively simple. The hydroid colonies have a pronounced superficial resemblance to plants, which they were at one time supposed to be. This led to the name of zoophytes—literally, animal plants—now rarely used. These colonies are found attached to various objects in the water, sometimes completely hiding the surface of the object and extending outward to a distance of several inches (Fig. 59). The jellyfishes belonging to this class are characterized by the possession of a *velum*, a circular shelllike fold which runs inward from the margin of the bell and incloses a chamber below the body (Fig. 66). The velum assists in locomotion by alternate

dilation and contraction which forces water out through a central opening in it with force sufficient to drive the animal through the water. Though a system of radial canals is developed in hydrozoan jellyfishes, these canals remain, generally speaking, few in number and unbranched. The hydrozoan jellyfishes are relatively small, most of them being less than an inch in diameter and the giants among them reaching a diameter of only 15 inches. They have a marginal row of tentacles and no tentacles around the mouth or, at most, a limited number.

172. Scyphozoa.—The jellyfishes of this class (Fig. 60) are very large as compared to the hydrozoan jellyfishes. There are records of

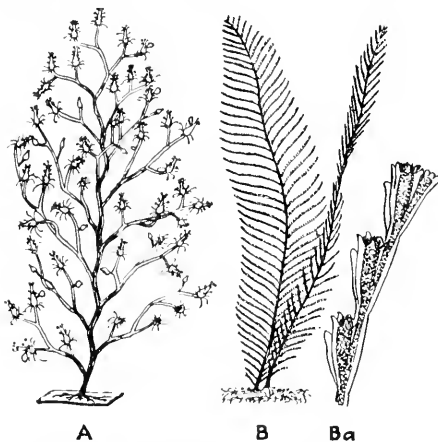

FIG. 59.—Colonies of colonial marine hydroids. A, *Pennaria* sp. \times about 3. Medusa buds are shown attached to the sides of the polyps from which they have been developed. B, *Sertularia* sp. \times 2. Ba, portion of a branch showing three pairs of polyps retracted into the sessile hydrothecae. \times 40.

individuals 12 feet in diameter and possessing tentacles 100 feet in length. Bulky as such individuals are, they consist almost entirely of water and when dried form only a thin film. There are in some cases scattered aneroid cells in the mesoglea but these are not considered as forming a third layer. These jellyfishes differ from the hydrozoan jellyfishes in not having a velum; in having a complexly branched system of radial canals; in the fact that the margin of the bell is divided into sections by notches, in each of which is a pair of marginal lappets; and, in many cases, in the abundance of fringed tentacles surrounding the mouth. Many of

these forms exist only as jellyfishes, generation after generation, but in some this type alternates with a modified type of polyp.

173. Anthozoa.—Among the Anthozoa are the sea anemones, which are polyps in which there extends downward from the margin of the mouth into the enteron a tubular membrane forming a *stomodeum*, or gullet (Fig. 61). The stomodeum, in turn, is fastened to the body wall by radially arranged membranes called *mesenteries*. These divide the enteron into a number of chambers which may be entered from below. Between these mesenteries are shorter ones running inward from the body wall and not meeting the gullet; thus recesses are produced on the outer wall of the chambers. Since these incomplete mesenteries may vary in length, they produce recesses of several degrees of depth and of varying breadth. Openings in the upper part of a mesentery, putting two chambers into communication, are called *ostia*.

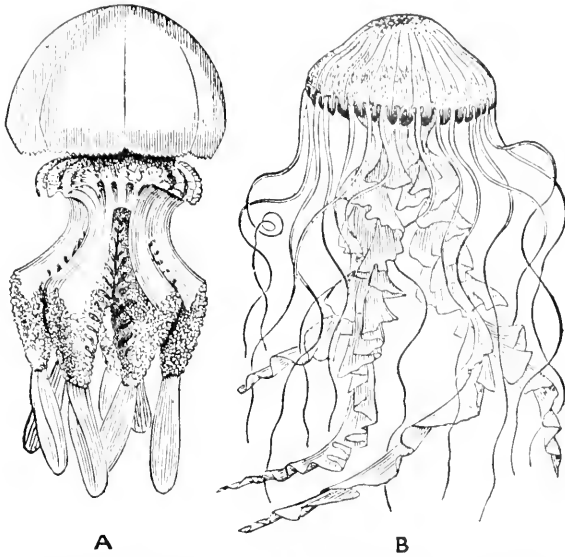

FIG. 60.—Two scyphozoan jellyfishes. A, *Rhizostoma pulmo* Haeckel. B, *Chrysaora hyoscilla*. (From Lankster, "A Treatise on Zoology," by the courtesy of A. and C. Black.) The first of these reaches such a size that the bell is 2 feet in diameter; in the second the bell may be 6 inches across.

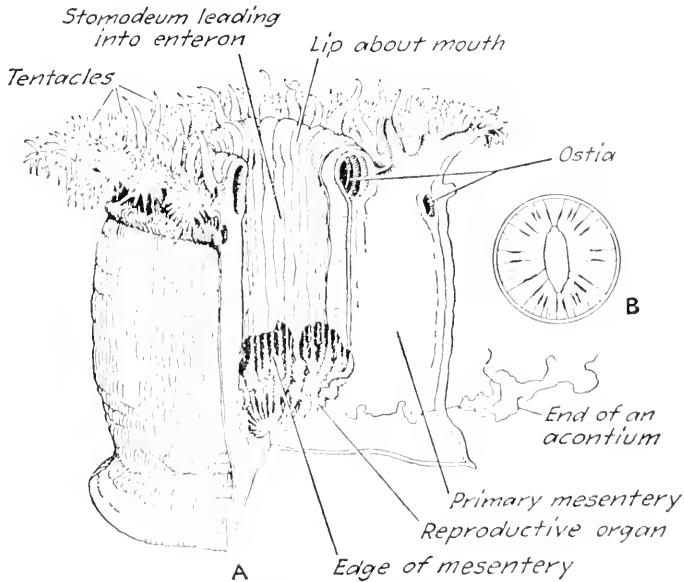

FIG. 61.—A sea anemone, *Metridium dianthus* Ellis. (From Woodruff, "Animal Biology," by the courtesy of The Macmillan Company.) A, view of polyp with one quadrant removed. B, diagram of transverse section, reduced in size, showing the general plan of the mesenteries.

Anthozoan polyps are much firmer in texture than are those of Hydrozoa and Scyphozoa, and the skin, though soft, is tough. Bands of contractile fibers lie on the surface of the mesenteries and by their contraction enable the animal to protect itself by drawing the body down into a compact mass with the mouth and tentacles completely hidden from view. In some cases cells exist among these contractile fibers, but these are not considered to form a mesoderm (Sec. 183). The upper surface of the polyp is covered with many hollow tentacles the

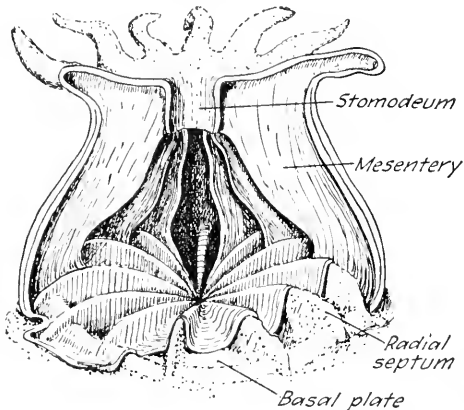

FIG. 62.—Diagram to illustrate the formation of coral by a coral polyp. (From Thomson, "Outlines of Zoology," after Pfuertscheller, by the courtesy of D. Appleton & Company.) This shows the formation of a basal plate and radial septa; it does not show the external wall or theca which rises gradually with the basal plate and radial septa as the coral is deposited.

cavities of which communicate with the enteron. These tentacles can be extended by water being forced into them and retracted by its withdrawal. Nematocysts are found on the tentacles and also on the acontia, which are threadlike structures attached to the base of the mesenteries and capable of being protruded through the stomodeum or through pores in the wall of the body. Acontia are believed to serve as weapons of offense and defense, while the tentacles are the food-securing structures. Sea anemones usually exist as single polyps, though groups may be formed by budding. Individuals may

attain a diameter of a foot or more.

A coral animal, which is usually an anthozoan polyp, secretes lime under the basal disc and around the side of the body, forming a cup. The mesenteries extending inward from the outer wall of the body are continued across the basal wall and tend to meet at the center. Ridges of lime are secreted corresponding to these mesenteries on the basal wall and, when the coral polyp is removed, indicate the plan of their arrangement (Fig. 62). Solitary coral polyps exist which may be several inches in diameter, but very frequently coral animals live in large colonies. The colonial polyps average smaller than the solitary ones, the smallest not exceeding $\frac{1}{16}$ inch in breadth. In the case of the sea fans and sea pens a very large colony of exceedingly minute polyps builds a skeleton of characteristic shape which suggests the common name (Fig. 63).

174. Color.—Hydroid colonies are generally whitish in color, though they may show a slightly brown or yellow tint. Anthozoan polyps

are often very brightly colored. Many jellyfishes are perfectly transparent and the mesoglea reflects rays of light with crystal-like clearness. Some, however, are beautifully tinted, and a few are strongly colored. Though all colors may be found, the prevailing colors are blue, various shades of rose or pink, yellow, or brown. Jellyfishes are more or less luminescent at night.

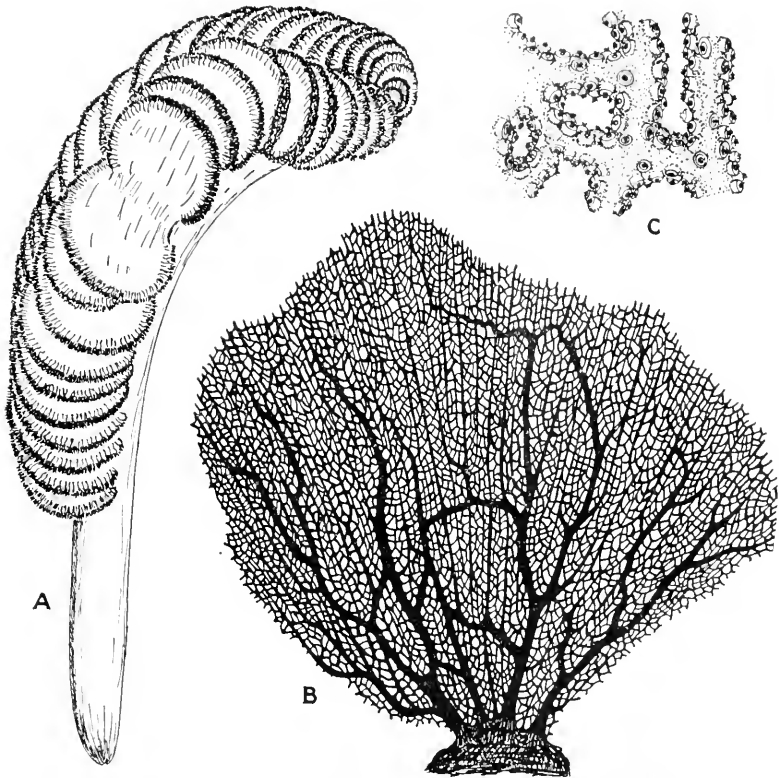

FIG. 63.—A, sea pen from Puget Sound, *Ptilosarcus quadrangularis* Moroff. $\times \frac{1}{2}$. The polyps are on the edges of the leaflike folds; the stalk is imbedded in mud or sand at the bottom of the sea when the animal is under natural conditions, but does not anchor the animal to a particular location. B, dried skeleton of a sea fan, *Gorgonia* sp. $\times \frac{1}{6}$. This colony is anchored to a mass of coral rock. C, portion of a sea fan colony, showing the polyps. $\times 8$. All from preserved specimens.

175. Polymorphism.—*Polymorphism* is a phenomenon which involves the appearance of the same species of animal in different forms. It is very generally exhibited by coelenterates. For instance, the colonies of many of the marine hydroids have polyps of two types, one nutritive, the other reproductive. In addition to these two forms there may also be the medusa, which represents a third form of the same species (Fig. 66). In the case of certain colonial hydroids there are several distinct types of polyps, accompanied by a division of labor between the indi-

viduals in the colony. In the Portuguese man-of-war (Fig. 64), for example, there are polyps which are nutritive, others which are sensory, others which contain batteries of nematocysts as weapons of offense and defense, still others which contain male gonads, and finally some which

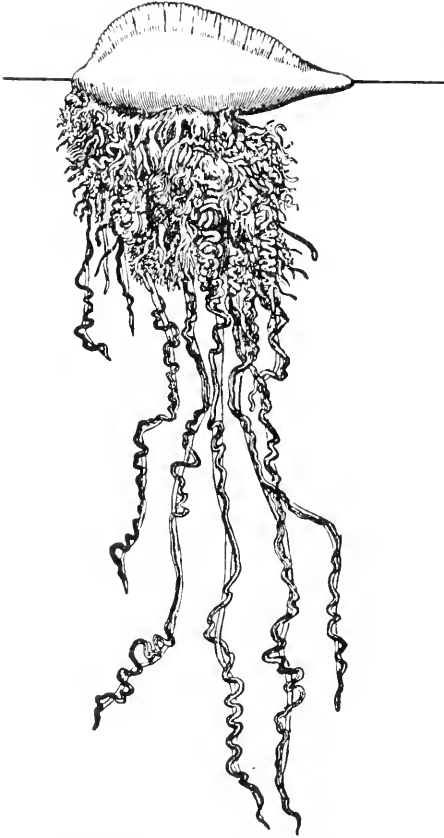

FIG. 64.—A Portuguese man-of-war, *Physalia physalis* Bosc. (From Packard, "Zoology," after Agassiz.) $\times 1_3$. The tentacles are capable of extension to a length of over 40 feet, and bear thousands of minute polyps.

capture many animals of considerable size, including even fish. In a similar manner sea anemones soon quiet the luckless animal which runs or falls upon the expanded tentacles, after which it is passed from one group of tentacles to another until it is put into the mouth. The smaller jellyfishes cannot sting severely enough to be noticed by a human being, but the larger ones may cause a marked effect, the sensation being similar to that following stinging by nettles.

The steps in metabolism in all coelenterates are similar to those described for hydra.

give rise to egg-producing medusae. There remain to be added to this enumeration polyps which unite in the production of a gas bag that serves to float the organism at the surface of the sea. This kind of polymorphism, where the unlike individuals are united in a single organism, is very rare. Polymorphism, however, is very general in the animal kingdom and may or may not be accompanied by division of labor.

176. Metabolism.—In all coelenterates ingestion of food occurs by means of the tentacles, which secure the food and pass it into the mouth. As a hungry jellyfish is carried along through the water by a current, aided in some cases by pulsations of the bell, its tentacles trail below and behind forming a net in which the prey is entrapped. These tentacles may be spun out till they resemble exceedingly fine threads; they are not strong, but, furnished as they are with batteries of nematocysts which soon paralyze the struggling victim, they serve well their purpose. The larger jellyfishes

177. Behavior.—Coelenterates respond to various stimuli, their responses in general being similar to those of the hydra. The hydra, however, has only scattered sensory cells, while many of the other coelenterates develop specialized sensory structures. On the tentacles of a jellyfish are groups of tactile cells. Between the bases of the tentacles and along the margin of the bell are structures which are believed to function as organs of equilibrium and hence are called *statocysts*. Other groups of cells are recognized as being olfactory. Finally, there are pigment spots which are sensitive to light.

178. Reproduction.—In coelenterates generally the same types of reproduction occur as in the hydra. In the case of the hydra, however,

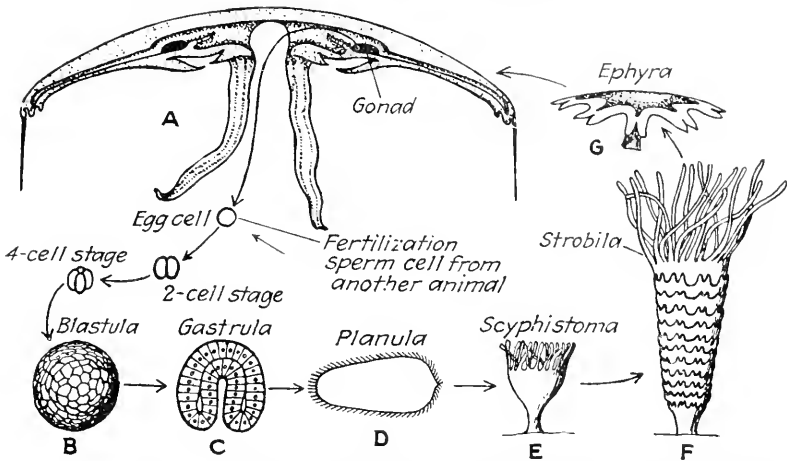

FIG. 65.—Diagram illustrating the life history of a scyphozoan jellyfish (*Aurelia*). A section of the body of a female animal is shown with gonads (A), from one of which an egg cell is produced. This is fertilized by a sperm cell from another animal, passes through the two-cell and four-cell stages, later becomes a blastula (B), then a gastrula (C), which is shown in section, and finally develops into a ciliated planula larva (D). After a time this becomes attached and changes to a scyphistoma (E), from which is developed a strobila (F). Each ephyra (G) from this strobila is the young of another animal.

the one individual exhibits all these types, while in other coelenterates asexual reproduction is often restricted to the polyps and sexual reproduction to the medusae of the same species. Budding may by its repetition give rise to colonies consisting of many hundreds and even thousands of individuals. Medusae remain single, are usually either male or female, and shed germ cells into the water. While, as a rule, they exhibit sexual reproduction, jellyfishes may produce other jellyfishes by budding from the surface of the manubrium. When the sex cells unite in fertilization, the embryo which develops grows into a ciliated free-swimming larva known as a *planula*, which, after its free life, settles down and becomes the parent individual of a hydroid colony.

Among the scyphozoan jellyfishes occurs an interesting type of budding called *strobilation* (Fig. 65). The planula, after becoming

fixed, develops into an individual somewhat like a hydra, known as a *scyphistoma*. This forms at its outer end a series of saucer-like buds piled one upon another, which as they grow older gradually develop into medusae; each of these buds is called an *ephyra*. When the *scyphistoma* has developed a whole series of such buds it is called a *strobila*. As the ephyrae are formed successively from the outer end of the parent individual it follows that the oldest will always be at the free end of the pile and the youngest at the lower end next to the parent. The ephyrae, when freed, gradually develop into mature jellyfishes.

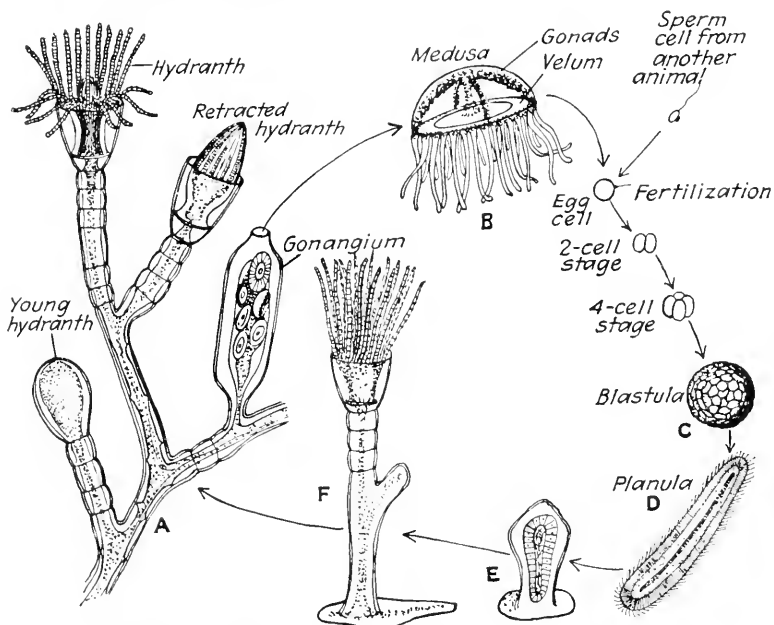

FIG. 66.—Diagram illustrating metagenesis, and also polymorphism, in the life history of a species of *Obelia*. A, portion of a colony, with hydranths and a gonangium; these and the medusa show three forms of the same species, which is polymorphism. B, sexual medusa, produced in the gonangium by budding and set free in the water. An egg cell from this is fertilized by a sperm cell from another animal, passes through two-cell and four-cell stages, and in time becomes a blastula. C. This passes through a gastrula stage and finally becomes a ciliated planula larva. D. The larva settles down, becomes attached (E), and from it a new colony is formed (F and A).

179. Metagenesis.—The phenomenon of a budding generation being followed by a generation which produces egg cells and sperm cells is known as alternation of generations, or *metagenesis*. The marine hydroids very generally illustrate this phenomenon, and *Obelia* may be taken as an example (Fig. 66). A colony of *Obelia* consists of individuals that have been asexually produced by budding from a parent which in turn was developed from a sexually produced planula. These polyps are of two types—nutritive and reproductive. The nutritive individuals, or *hydranths*, provide food both for themselves and for the reproductive

individuals, or *gonangia*. The latter produce medusae by budding, and the medusae in turn produce sperm cells and egg cells. From the fertilized egg cells develops another generation of planulae. The polyps thus represent the asexual generation and the medusae the sexual. Metagenesis is also shown by scyphozoan jellyfishes, the medusae reproducing sexually and the strobila asexually. The hydra is not an example of metagenesis, because the same individual possesses both types of reproduction.

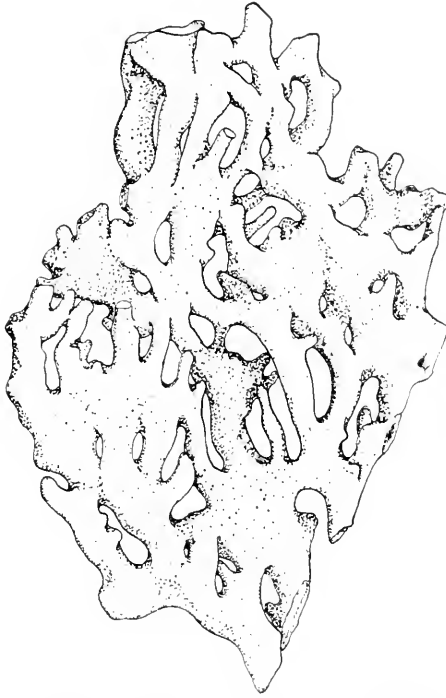

FIG. 67.—Portion of a hydrozoan coral, the pepper coral (*Millepora* sp.), often called the stag-horn coral. Natural size.

180. Corals.—*Coral* is a deposit of lime formed by coelenterate polyps. One type, the pepper coral, or stag-horn coral (Fig. 67), is distinguished from the rest by the fact that being produced by a simple hydrozoan polyp its mass is relatively continuous and the pits which lodged the living polyps are simple. On the other hand, most anthozoan corals possess pits which are larger, deeper, and show radial ridges of varying lengths. They are often delicately sculptured, producing a very beautiful effect. Among such corals (Fig. 68) are those known as the elk-horn coral, the brain coral, the rose coral, and the mushroom coral. The organ-pipe coral and the red, or precious, coral fall in a third group, produced by polyps related to sea fans and sea pens. Coral

polyps build masses of coral which after long periods of time become very extensive and are known as reefs. These when they margin the shore are called fringing reefs but when they lie at a distance from shore, inclosing a lagoon, are known as barrier reefs. The Great Barrier Reef of Australia (Fig. 69) is between 1100 and 1200 miles in length, and the

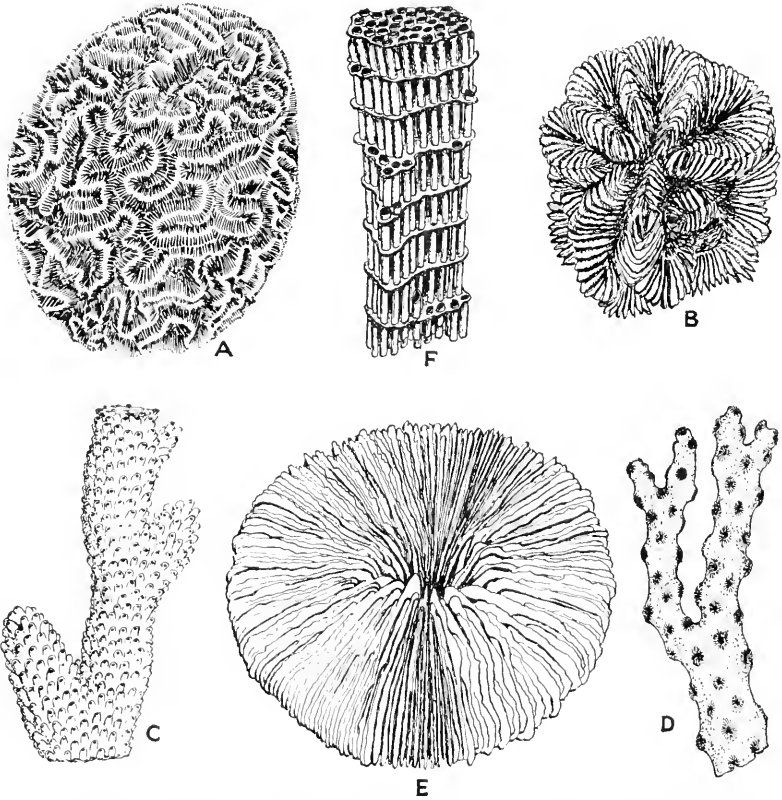

FIG. 68.—Several types of anthozoan corals. A, brain coral, *Meandrina sinuosa* Lesueur. $\times 1_2$. B, rose coral, *Meandrina meandrites* (Linnaeus). $\times 2_3$. C, portion of an elk-horn coral (*Acropora* sp.). $\times 2_3$. D, portion of another branching coral (*Oculina* sp.). $\times 2_3$. E, mushroom coral (*Fungia* sp.). $\times 1_3$. F, part of an organ-pipe coral (*Tubipora* sp.). $\times 2_3$. The last is made by an animal related to the sea fans and sea pens; the rest fall into another group, the corals of which are known as stony corals.

lagoon it incloses is in places 30 miles wide and reaches a maximum depth of 25 fathoms. When a barrier reef surrounds a submerged island, producing a circular reef with a lagoon in the center, it is known as an *atoll*.

181. Distribution and Economic Importance.—Coelenterates are distributed generally throughout all seas. A few representatives, none of which builds a skeleton, occur in fresh water. Coral polyps are much more abundant in the tropical regions and disappear entirely

north of a latitude about equal to that of the northern boundary of this country.

Coelenterates are relatively unimportant economically. Many tropical islands, however, particularly in the West Indies, are composed largely of coral rock built up in ages past. When first exposed this rock



FIG. 69.—A view of the Great Barrier Reef of Australia, with the mainland in the distance. The tide is low and much of the reef is exposed displaying a great variety of corals. (Photograph from the *American Museum of Natural History*, original by Saville Kent.)

is soft, but it hardens on continued exposure to the air. While soft it is easily sawed into blocks and used for building purposes. Precious coral is used in jewelry but is valuable only in case it possesses a conventional tint and a considerable degree of hardness. Corals of other kinds are frequently displayed as ornaments. Floating coelenterates serve as food for larger marine animals.

CHAPTER XXIX

PHYLUM CTENOPHORA

Bearing considerable resemblance to coelenterates because of their jelly-like consistency, the ctenophores are considered by many zoologists

to be a class of Coelenterata. For reasons which will soon appear, however, it seems more logical to put them in a separate phylum, Ctenophora (tē nōf' ō rā; G., *ktenos*, comb, and *phoros*, bearing). The ctenophores are all marine, and the species are relatively few in number. They are widely distributed but are most abundant in the tropics. They are very transparent and usually delicately tinted with some shade of blue, lavender, or pink.

182. Structure.—A typical ctenophore is ellipsoidal or nearly spherical in form and possesses eight rows of paddle plates running from one pole to the other (Fig. 70). Each *paddle plate* is a projecting shelf formed by the fusion of the bases of cilia which themselves fringe the margin of the plate. When seen from the side the plates resemble the teeth of a comb, which suggests one common name for this group—comb jellies. Because these rows of paddle plates form roughened ridges running from one pole to the other somewhat resembling the ridges on a walnut, ctenophores are often called sea walnuts.

The mouth is at one pole and leads into a *stomodeum*, which is connected with a series of *canals* running through the body. On each side is a sac into which may

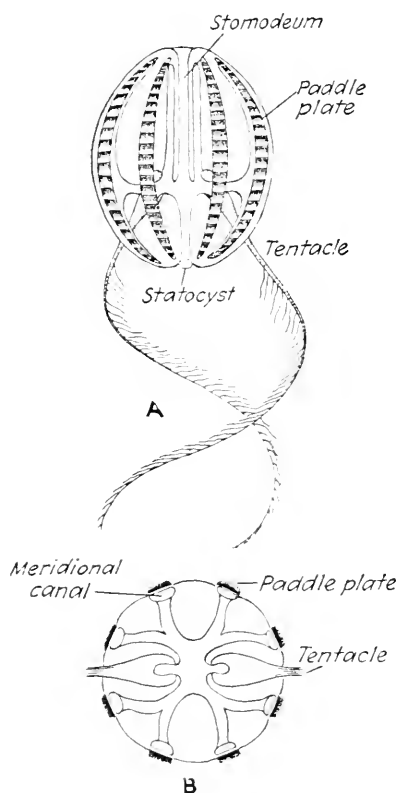

FIG. 70.—A ctenophore, *Pleurobrochia bachei* A. Agassiz, from Puget Sound. A, the organism seen from the side. Somewhat diagrammatic. $\times 1\frac{1}{2}$. B, diagram of a cross section of the animal to show the relations of the canals.

into a *stomodeum*, which is connected with a series of *canals* running through the body. On each side is a sac into which may

be retracted a tentacle; the *tentacles*, on the other hand, may be protruded to a considerable distance and trailed behind when the animal is moving. These tentacles bear cells which secrete an adhesive fluid and which are therefore known as glue cells, or *colloblasts*. At the aboral pole of the body is a collection of sense cells called a *statocyst*, which is believed to function in the maintenance of equilibrium.

Other ctenophores differ greatly from the typical form. In some the tentacles are lacking and the body is bell-shaped; others are pear-shaped, and a very different type, known as the Venus' girdle, is elongated, flattened, and bandlike, being sometimes over 3 feet long.

Ctenophores are monocious, the gonads lying on the walls of the meridional canals, which are under the rows of paddle plates, and the sex cells being passed out through the stomodeum.

183. Advances in Body Plan.—The arrangement of the bands of paddle plates give to ctenophores the appearance of having radial symmetry, but the arrangement of the internal canals and the presence of oppositely placed tentacles suggest bilateral symmetry. This combination of the two is by some termed *biradial*. Since bilateral symmetry is usually associated with the possession of a definite anterior and posterior end and a greater degree of purposefulness in movement, the ctenophores represent an advance over the coelenterates.

Another advance is the development of a *mesoderm*, simple as it is and represented merely by muscle cells. In contrast to the contractile fibers of coelenterates, which are only parts of cells, these muscle fibers are themselves modified cells. Also what is here termed a mesoderm is formed from the entoderm during the gastrula stage, while the cells which may be found in the mesoglea of coelenterates are derived much later from the ectoderm or entoderm and do not represent a true germ layer. Ctenophores may thus be considered *triploblastic*. This advance is significant in that it is the first step toward the building up of the powerful bodies possessed by higher forms and composed mainly of tissues derived from the mesoderm.

184. Activities.—Like the jellyfishes, ctenophores float in the water and are carried here and there by tide and wind. In locomotion the animal is propelled by the paddle plates which strike from the oral, or anterior, end backward. The movement is initiated, however, at the posterior end and wave after wave of movement passes rhythmically from this end forward along each row of these plates. When the animal is seen in the sunlight this frequently gives the effect of successive series of rainbow colors passing from one end of each band to the other. As the animal swims the tentacles trail behind, ready to capture any small organism that may come in contact with them and be held either by adhesion or by the coiling of the tentacles. Though the paddle plates

are not able to propel the ctenophores with a speed approaching that attained by the coelenterate jellyfishes, the animals appear to have more definiteness of movement.

Like jellyfishes, ctenophores serve as food for many marine animals, even for such large animals as whales. They are, however, of no direct economic importance to man.

CHAPTER XXX

FRESH-WATER PLANARIAN

A TYPE OF THE PHYLUM PLATYHELMINTHES

If the bottom of a spring-fed pool or the vegetation in it is carefully examined, it is probable that there will be seen a number of soft, flat, dark-colored worms gliding over surfaces with no apparent effort. These are planarians. They may also be found in streams and in permanent fresh-water ponds, in which the water is pure, cool, and clear. Some species seem to prefer being in currents while others prefer quiet water. When at rest, planarians tend to gather under stones lying on the bottom or in other places where the light is not bright. When abundant they may be attracted in great numbers to pieces of meat deposited in the water along the shore.

185. Structure.—A planarian (Fig. 71) has a body which is elongated, flattened dorsoventrally, blunt at the anterior end, and tapering to a point at the posterior end. The anterior end may be relatively square or it may be triangular with the apex pointing forward. This portion of the body is recognized as a *head* because it goes ahead in locomotion and because it possesses a nerve center, but it does not fulfill the ordinary conception of a head since it does not contain a mouth. There may be two lateral projections at the base of the head which are termed *ears*, but these neither hear nor have any other function of their own.

On the upper side of the head and near each other in the median line of the body may be seen two *eyespots*. On the ventral side of the body as far back as the middle, or even farther, is the *mouth*, through which may protrude the *proboscis*. The surface of the body is soft and is covered with cilia, which aid in locomotion.

186. Internal Structure.—Careful examination shows a planarian to possess many structures which have been found in none of the phyla hitherto studied. The mesoderm is well developed, forms the greater part of the mass of the body, and is composed of a meshwork of living

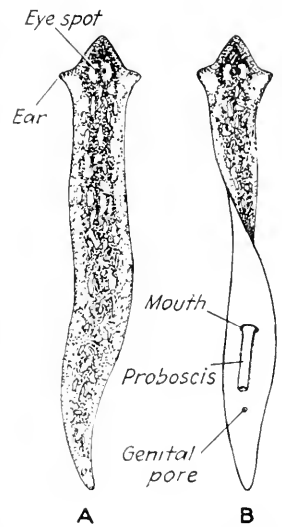

FIG. 71.—*Planaria maculata* Leidy. A, dorsal view. (From Woodworth, in Bull. Mus. Comp. Zool., vol. 31.) B, the animal turned to show features of the ventral surface. $\times 6$.

cells inclosing small spaces and known as the *parenchyma*. This parenchyma is covered externally by the epidermis. In it are imbedded a variety of other structures which make up more or less definitely organized systems.

One of these systems is the *digestive system* (Fig. 72 A). A mouth opening leads into a mouth, or buccal, cavity, which contains a protrusible *pharynx*. The wall of the pharynx forms a fold which projects forward

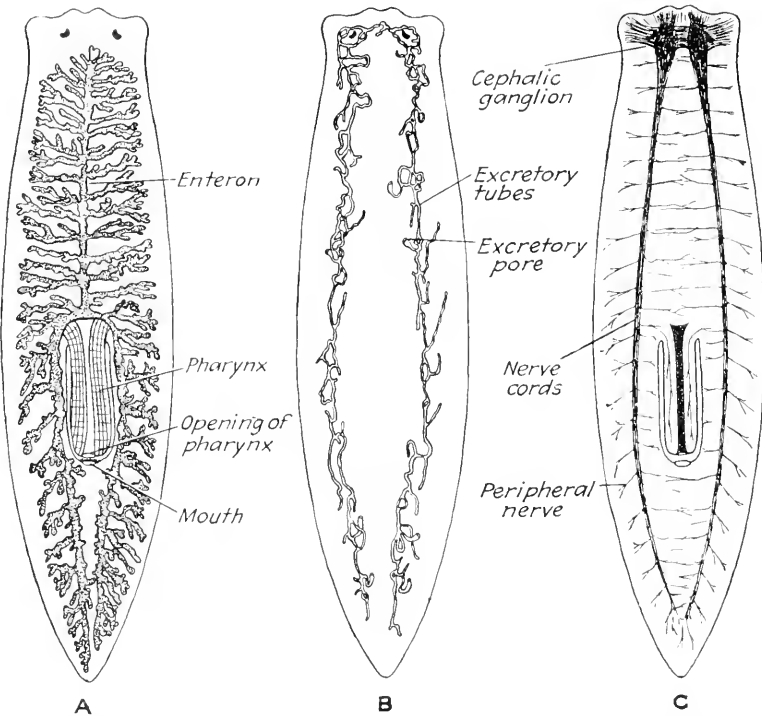

FIG. 72.—Systems of a planarian. Somewhat diagrammatic. A, digestive system. B, excretory system. C, nervous system. (From Parker and Haswell, "Text-book of Zoology," after Jijima and Hatschek, by the courtesy of The Macmillan Company.)

into that cavity for nearly its full length and at its outer end is entirely free. When protruded beyond the mouth opening, the pharynx forms a proboscis. The pharyngeal cavity leads into another cavity called an *enteron*, though sometimes referred to as an intestine. This consists of three main trunks, one anterior and two posterior and lateral, each of which has a large number of blind extensions, the whole representing a very complicated *gastrovascular cavity*. The possession of a lining of epithelium, of connective tissue, and of muscle fibers justifies the application of the term organ, at least to the pharynx, and that of system to the whole.

The so-called *excretory system* (Fig. 72 B) does not justify the term system. It consists in part of scattered *flame cells* (Fig. 73), which are hollow and contain a mass of cilia extending into the cavity of the cell. The cilia by their movements suggest a waving flame. The cavities of the flame cells communicate directly with slender tubes. The walls of these tubes are composed of a single layer of epithelial cells or, in the opinion of some observers, the tubes are made up of tubular cells placed end to end. These tubes lead into larger and larger ones until finally a pair of longitudinal and much coiled tubes is reached. One of these coiled tubes lies on each side of the body and the two are connected with a transverse tube at the anterior end, opening by two small pores on the dorsal surface behind the eyespots. Other openings to the outside along the longitudinal tubes also exist. These tubes are full of fluid containing the waste matter, and the flame cells, by means of their cilia, produce a current which carries this fluid outward. The scattered flame cells do not justify the name of tissue, though the tubes do, but there are no structures which conform to the definition of organ.

Muscle tissue is present in the form of sheets and bundles, the fibers of which run in different directions. An outer circular layer lies just under the epidermis, and below it are layers of external and internal longitudinal fibers which are separated by a set of oblique fibers. Bundles of muscle fibers also pass through the body dorsoventrally, between the branches of the intestine.

The *nervous system* (Fig. 72 C) is very simple. Two masses of nervous tissue containing nerve cells and fibers lie below the eyespots and form a nerve center. Such a collection of nerve cells is termed a *ganglion*. From these ganglia cords of nervous tissue, which are ganglionic in character, pass back, one on each side of the body. Both the ganglia and these two cords are connected by commissures. A *commissure* is a bundle of nerve fibers which in a bilaterally symmetrical animal crosses the middle plane of the body and connects corresponding nerve centers on opposite sides. A similar connection between centers on the same side is known as a *connective*. A *nerve* is a bundle of nerve

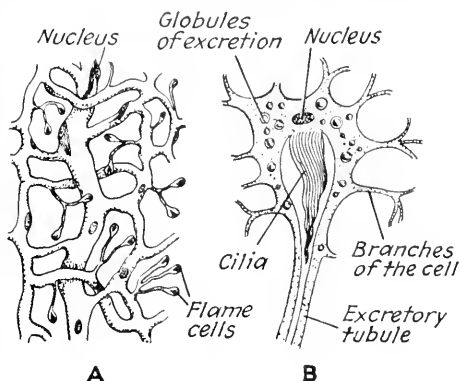

FIG. 73.—Semidiagrammatic sketches to illustrate the flame cells of a planarian. (From Benham, in Lankester's, "A Treatise on Zoology," by the courtesy of A. and C. Black.) A, part of the system of excretory tubes, showing the relation of the flame cells to them. Nuclei are seen in the walls and tufts of cilia projecting into the tubes, adjacent to the nuclei. B, flame cell.

fibers not in a center which conveys impulses from one part of the body to another. From both ganglia and nerve cords, peripheral nerves are distributed to the internal structures of the body and to the surface, particularly to the head, which is the most sensitive region. Since the

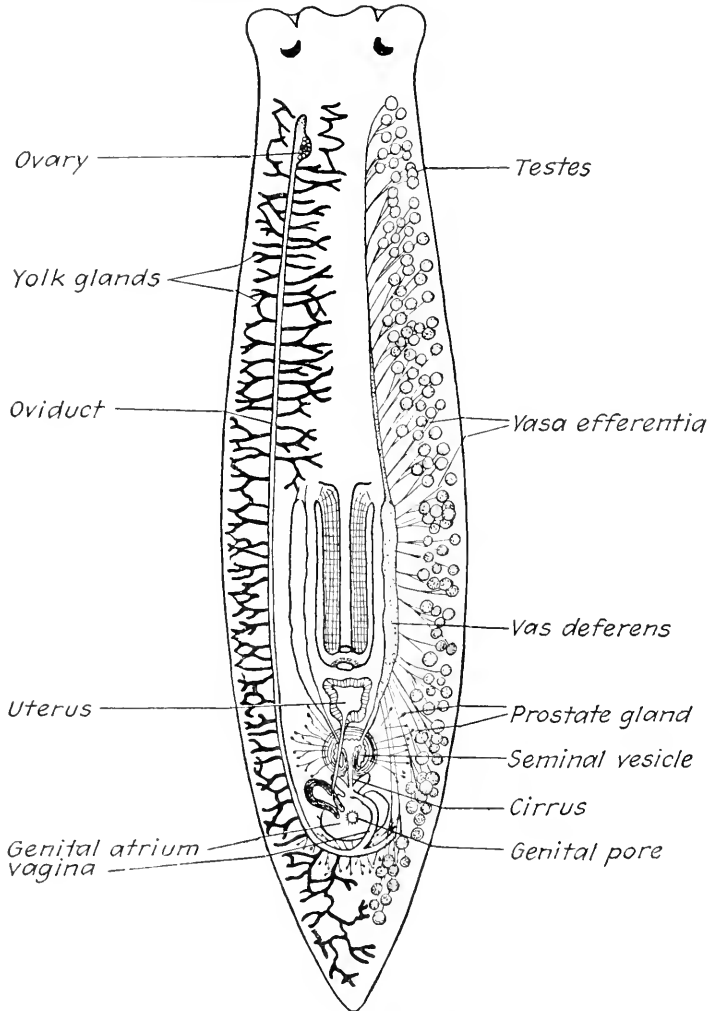

FIG. 74.—Reproductive system of a planarian. Somewhat diagrammatic. (From Parker and Haswell, "Text-book of Zoology," after Jijima and Hatschek, by the courtesy of The Macmillan Company.) The male organs are shown on the right side of the median line, the female organs on the left, each being omitted on the opposite side.

ganglia have connective tissue sheaths which more or less protect them, they may be recognized as simple organs. The peripheral nerves also have similar sheaths.

The reproductive system (Fig. 74) is the most complex of all and most fully justifies the term system. The male organs consist of numerous

spherical *testes*, which are masses of cells lying in the parenchyma. To each of these testes is connected a tube of thin epithelial cells called a *vas efferens*. All of these vasa efferentia join a large lateral tube on each side of the body known as a *vas deferens* which leads to a muscular *cirrus*, or penis, situated toward the posterior end of the body near the ventral side and behind the pharynx. A *seminal vesicle*, in which the sperm cells are accumulated, lies at the base of the cirrus. A number of *prostate glands* pour their secretion into these passages, the function of their secretion being to stimulate the sperm cells to activity. The sperm cells pass from the testes down the vasa efferentia and vasa deferentia and are transferred by the cirrus, in packets called *spermatophores*, to the uterus, either of the same or of another individual. In the uterus they are stored until needed.

The female reproductive organs consist of two *ovaries* and two tubular *oviducts*; one on each side, through which the egg cells pass backward. *Yolk glands* scattered along the course of the oviducts add their secretion to the egg cells as they pass, and a *vagina* transmits these cells to a *genital atrium*, a chamber which receives the opening of the cirrus. The pouchlike uterus is also connected with this genital atrium. The term *uterus* is applied to that portion of the oviduct in which the eggs accumulate and in which a part of the development of the embryo takes place. The genital atrium opens by a *genital pore* on the ventral surface behind the mouth.

The body is covered by a simple ciliated epithelium attached to a basement membrane. There are no structures corresponding to circulatory, respiratory, or skeletal systems. It is interesting to note that in the development of systems the reproductive system, upon which the perpetuation of the race depends, is in the lead, followed by the digestive system, necessary to the existence of the individual and the nervous system, which puts the animal in touch with its environment.

187. Metabolism.—The food of a planarian consists mostly of animal matter, though a little plant food is taken. The animal secures the food by means of its proboscis, through which ingestion takes place. Digestion, as in the case of the coelenterates and ctenophores, is both intracellular and extracellular. The food is distributed to all parts of the body by the much branched gastrovascular cavity, the wall of which serves everywhere for absorption. Circulation occurs by the passing of the absorbed food from cell to cell and through the spaces between the cells. Elimination takes place by means of the excretory system, and egestion is through the mouth. Respiration goes on over the entire surface, there being no structures developed for this purpose, though some authors attribute to the excretory system an expiratory function.

188. Reproduction.—This animal reproduces asexually as well as sexually. Asexual reproduction takes place by transverse *fission*.

In sexual reproduction *self-fertilization* readily occurs, since not only are the worms monocious or hermaphroditic, but both the cirrus and the vagina open into the common genital atrium. The egg cells received by this atrium from the vagina are passed into the uterus, where they are fertilized. When cross-fertilization takes place, the cirrus of one animal is protruded and inserted through the genital atrium into the uterus of the other. In this manner sperm cells are transferred from the animal which takes the part of a male to the uterus of the other which takes the part of a female. Every egg cell is surrounded by a large number of nurse cells, or yolk cells, each of which contributes its store of nourishment to the egg cell to which it becomes attached. One or more egg cells, with the yolk cells and the yolk, are then enveloped in a shell, sometimes called a *cocoon*, and deposited on stones or on vegetation in the water. The egg cell divides into blastomeres which increase in number and finally form a blastoderm surrounding a central cavity filled with yolk. Into this cavity are budded off cells which arrange themselves in such a way as to form a sheet of entoderm surrounding an innermost cavity which becomes connected with the outside and forms the gastrovascular cavity. Between the entoderm and ectoderm cells derived from them multiply and form the mesoderm.

189. Behavior.—A fresh-water planarian moves with no apparent effort, gliding over a surface and adjusting itself easily to every irregularity, this being made possible by the softness of its body. As it progresses it raises its head and turns it from side to side as if feeling its way. The cilia are locomotor structures, but they are so minute as to be invisible to the eye and thus the worm seems to slide over the surface on which it moves. The motion is rhythmic, waves of movement passing backward from the head. The cilia beat in a mass of slimy mucus secreted by glands on the under surface of the body, which forms a track for the animal, laid down as it progresses.

The animals respond to the same stimuli which are effective in other lower organisms—that is, to contact, to temperature, to light, to chemicals, and to water currents. They find their food by both chemical and contact stimuli. The chemical attraction of the juices of the food seems to bring them to it. When found, the food is held between the head and the substratum and compressed by the body before the animal moves forward to bring the proboscis in contact with it. A planarian reacts negatively to a variety of substances in strong solutions and positively in weak solutions, the effective strength varying with the substance. The eyespots seem to be light-perceiving, though of course the animal possesses no vision. Planarians alternate periods of activity with those of rest and are more active at night than during the day.

The behavior of a planarian is of a *reflex* type—that is, a stimulus received by a cell on the surface produces an impulse which is conducted along a nerve fiber to a cell in a ganglion or in a nerve cord. This cell in turn sends out an impulse which is transmitted either to muscle cells, which move, or to gland cells, which secrete. In other words, the effect is turned back or reflexed. The cell receiving the stimulus is called a *receptor*, the ingoing impulse an *afferent impulse*, the central cell an *adjustor*, the outgoing impulse an *efferent impulse*, and the cell which completes the action—not a nerve cell—an *effector*. A *reflex act* may be defined as an act involving these three types of cells or as an act involving an afferent and an efferent impulse in which the latter is conditioned upon the former.

Planarians are subject to different physiological states, the character of their reactions varying with hunger, fatigue, or nervous excitement.

190. Regeneration.—A planarian possesses a power of regeneration hardly less developed than that of the hydra. Pieces of their bodies may also be grafted together without great difficulty.

A noteworthy fact is that whenever a new body is regenerated from a piece, a head is developed on that margin of the piece which was nearest the head in the animal from which it came, while a new tail is developed on the opposite margin. The explanation of this was for a long time obscure but has been furnished by recent experiments. These show that in an animal possessing a head and a tail, as do planarians, there is a gradient in metabolic activity extending from near the anterior end to the posterior end. The rate of metabolism is greatest at the anterior end of this gradient and decreases gradually from this end to the other (Fig. 75). Thus it is that any fragment will differ in the metabolic activity of its different portions corresponding to their position with respect to the *axial gradient*. Consequently, from the margin where metabolic activity is greatest a head will develop, and from the other margin a tail. This conception of an axial metabolic gradient, proposed first by Child, can also be applied in explaining how reproduction in some worms may occur by transverse fission. It is assumed that when the animal gets so long that the gradient becomes exceedingly gradual, the posterior portion of the body escapes from the dominance of the anterior portion and a new center of metabolic activity, or another maximum in a new axial gradient, is established. Just in front of this center appears the constriction which divides the body into two parts.



FIG. 75.—Diagram to illustrate the metabolic gradient in a planarian. The change in the width of the black line shows the varying degrees of metabolic activity at different levels, such as *a, b, c*. The effect is, of course, not confined to the median line but extends from one side to the other.

CHAPTER XXXI

PHYLUM PLATYHELMINTHES

The phylum Platyhelminthes (plăt ĭ hĕl mĭn' thĕz; G., *platys*, broad, and *helminthos*, worm), of which a planarian has been taken as a type, represents in many respects a marked advance over previous phyla. *Bilateral symmetry* is here fully established. The animal possesses a definite head and tail. The head represents not only the part that goes ahead in locomotion but also the most sensitive part of the body and the portion in which is located a nerve center. This results in a definiteness in the movements of the animal which is in marked contrast to the haphazard locomotion of the coelenterates or the weak but more definitely directed swimming of the ctenophores. The presence of bilateral symmetry is not here accompanied, however, by the presence of metamerism. These animals have begun, too, to reap the advantages derived from the development of the *mesodermal layer*, and there is shown, in its inception, the *plan of organization* of all higher animals. This organization involves the development of tissues, organs, and systems and greatly increases the effectiveness of the organism. In the Turbellaria the gastrovascular cavity reaches its highest degree of development and of efficiency. By means of numerous complexly branched canals the food is distributed throughout the body of the animal, in spite of the fact that the development of the mesoderm has greatly increased the bulk and the number of cells to be reached. The nervous system in the free-living flatworms includes a pair of ganglia below the eyespots, which have by some been called a brain and which is a definite evidence of *centralization*.

191. Classification.—This phylum is divided into three classes as follows:

1. *Turbellaria* (tĕr bĕl lă' rĭ ā; L., *turbella*, a little stirring).—Consists of soft-bodied forms, usually free-living, with a ciliated epidermis which contains an abundance of secreting cells and which also produces rodlike bodies called rhabdites. The mouth is on the ventral surface but in different species it varies in location from near the anterior end to even behind the middle of the body.

2. *Trematoda* (trĕ mă tō' dā; G., *trematodes*, having pores).—Forms in which the soft, ciliated epidermis is replaced by a thick, firm cuticle, without cilia, in which the mouth is situated at or near the anterior end of the body and surrounded by a sucker, and in which there may also

be other suckers on other parts of the body. The trematodes are all parasites.

3. *Cestoda* (sěs tō' dā; G., *kestos*, girdle, and *eidos*, form).—The members of this class are also provided with a thick cuticular covering. They have a so-called head, or scolex, provided with suckers and in many cases also with hooks. The body is divided into a series of sections or proglottids which vary greatly in number in the different species. As a result of parasitism, which also prevails in this group, many organs are reduced and the digestive system is entirely absent.

192. Turbellaria.—In addition to the fresh-water planarians this class includes a great many free-living marine flatworms. These may be found making their way over the surface of rocks or other solid objects in the water and at low tide are often found closely adherent to the lower surfaces of rocks lying upon the beach. In the latter case they are difficult to detect because they make a very thin film and the mottling of the body is quite similar to the mottling of the surface to which they adhere. Some of these marine forms are relatively large, reaching a length of several inches, and are broadly oval or elliptical in outline. On the other hand, there are some which are so small as to be microscopic. The enteron of the more minute forms is simple and unbranched, while that of the larger forms is divided into one or more main branches. These in turn give rise to very complexly divided lesser branches which reach all parts of the body. Turbellarians are not confined to water, either salt or fresh, for in the tropics there are species which live in and on moist earth. The fresh-water forms may be in quiet water or in swiftly flowing streams; they may be collected under the ice in winter and have also been found in hot springs at a temperature of 47°C. (116.6°F.).

The larger forms are of various shades of gray, brown, or black, but the smaller ones are often brightly colored and may be green from the presence of symbiotic algal cells in the parenchyma. The eyespots may be absent, but the usual number is two; and one form, *Polycelis*, has a large number. Olfactory pits and statocysts may also be present. The turbellarians are richly supplied with glands. Some of these secrete a slimy mucus; others, at the ends of the body, act as adhesive cells; and still others produce material which forms *rhabdites* or rodlike crystalline bodies which are thought to serve as a means of defense or of capturing food.

193. Trematoda.—This class includes animals generally known as flukes. They are parasitic on and in a great variety of other animals, as on the skin of the salamander and certain fishes, on the gills of fishes and tadpoles, and in several internal organs of various vertebrates. The number of suckers and their location differ in different types. The pharynx is not protrusible but it is muscular and capable of suction. The type chosen to illustrate this class is *Clonorchis sinensis* Cobbold

(Fig. 76), a fluke which lives as an adult in the bile ducts of the liver of man, dog, and cat, and is found in China and Japan. In addition to the firm leathery cuticle, the absence of cilia, and the presence of suckers, all of which represent adaptations to a parasitic mode of existence, this form in its adult condition is to be contrasted with a planarian in the absence of eyespots and in the more highly developed reproductive system. The single excretory pore lies at the extreme posterior end of

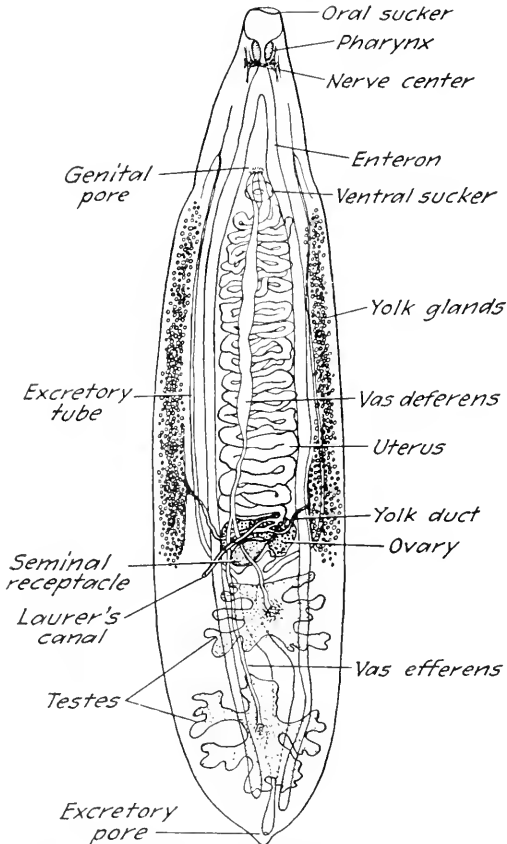

FIG. 76.—*Clonorchis sinensis* Cobbold. (Redrawn from Hegner, Root and Augustine, "Animal Parasitology," after Faust.) Dorsal view, showing internal structure. $\times 8$.

the body. Added to the female organs is a *shell gland* which secretes a substance that hardens the shells of the eggs (Fig. 77).

194. Cestoda.—This class includes the tapeworms, which are most common in the alimentary canals of vertebrates. A typical tapeworm (Fig. 78) consists of a more or less rounded head, or *scolex*, and a relatively slender neck, which together form one section of the body, and a number of other sections called *proglottids*. The scolex bears suckers and is projected at its free end into a *rostellum* which may have an encircling

row of hooks (Fig. 79). The proglottids represent individuals, and the whole forms a colony, of which the section forming the scolex and neck is the parent and in which new individuals are constantly being produced by transverse constriction at the end of the neck. The proglottids are carried farther and farther away from the point of origin as younger individuals are produced and gradually become mature, with fully developed sex organs. After the egg cells are fertilized they develop in the uterus. All other organs except the uterus disappear and finally the gravid proglottid becomes practically a sac of eggs, each egg containing an embryo. Ultimately these ripe proglottids are cast off and are passed out of the body of the animal containing the parasite with the feces. In the relation of the members of a tapeworm colony to each other there is a perfect correspondence to the relation of the individuals in a strobila. The scolex and neck correspond to the scyphystoma and the proglottids to the gradually developing ephyrae, both being cast off when mature. New proglottids are developed where the neck ends, in the same fashion as new ephyrae are budded off from the scyphystoma.

The effects of parasitism are carried much farther than in the flukes. Hooks may be added to the suckers as organs of attachment, and the nervous system is still further simplified; but still more striking is the complete absence of the alimentary canal, the digested food in the intestine containing the tapeworm being absorbed through the body wall of the parasite.

The simplest cestode lives in the body cavity of an annelid worm and has only one section, which is scolex and neck. In contrast to this form are others which may possess hundreds of proglottids and which may reach a length of many feet.

195. Metabolism.—The steps in metabolism in a free-living flatworm, as illustrated in a planarian, have been seen to be not greatly different in general character from those in the coelenterates. It should be noted

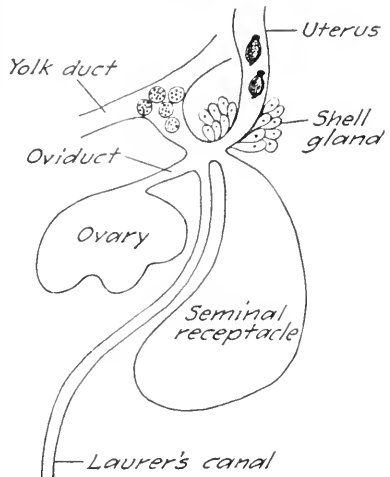

FIG. 77.—Diagrammatic sketch showing relationships of female organs in *Clonorchis sinensis*. (From a sketch by H. W. Manter.) The egg cells are formed in the ovary and passed into the oviduct, where they are fertilized by sperm cells from the seminal receptacle and provided with yolk and shell-forming material from the yolk gland. They then go on past the shell gland, the secretion of which hardens the shells, and into the uterus. The sperm cells in the seminal receptacle have come from another animal. In this case it is known that in copulation sperm cells are introduced through Laurer's canal, which opens to the outside. In some other flukes, however, there is no external opening to this canal and it seems to be a vestigial organ.

that though parasitism in the case of the tapeworm has resulted in the

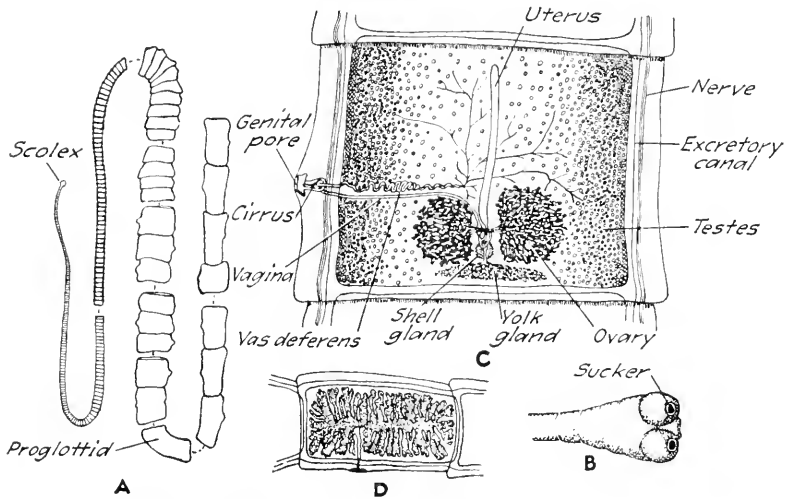

FIG. 78.—The beef tapeworm, *Taenia saginata* (Goeze). A, the whole tapeworm, with many portions omitted, to illustrate the change in the form of segments in different parts of the body. (From Leuckart, "Parasiten des Menschen.") $\times 1_2$. B, scolex and neck in an extended condition. The rostellum bears no hooks and the tapeworm is spoken of as unarmed. (From Leuckart.) $\times 5$. C, proglottid, showing the sex organs. (Also from Leuckart.) $\times 7$. D, ripe proglottid, showing the uterus distended with eggs. $\times 11_2$.

disappearance of the digestive system and the absence of the processes of ingestion, digestion, and egestion, all of the other processes in metabolism still remain. Absorption occurs over the surface of the body; circulation is from cell to cell; assimilation and dissimilation, secretion, excretion, and elimination are still carried on in the same manner as in the nonparasitic forms. Anal openings have been described in some trematodes and openings from the branches of the gastrovascular cavity to the outside in turbellarians, but the extent to which these can function in egestion is not known.

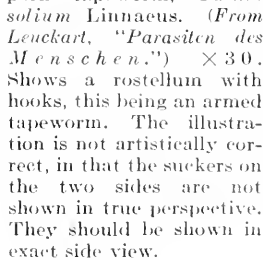

FIG. 79.—Scolex of the pork tapeworm, *Taenia solium* Linnaeus. (From Leuckart, "Parasiten des Menschen.") $\times 30$. Shows a rostellum with hooks, this being an armed tapeworm. The illustration is not artistically correct, in that the suckers on the two sides are not shown in true perspective. They should be shown in exact side view.

196. Reproduction.—Reproduction in this phylum occurs both sexually and asexually. Sexual reproduction is, however, the more usual type. Asexual reproduction in a planarian is usually by transverse *fission*, but a type of *fragmentation* has also been described in which the body breaks up into a number of fragments each of which by a process analogous to regeneration becomes a complete individual. The production of proglottids is also asexual reproduction.

197. Occurrence and Economic Importance.—The phylum Platyhelminthes contains a large number of species, and a very large percentage of vertebrates are infected by the parasitic forms. From an economic standpoint the free-living flatworms are of no importance, but both trematodes and cestodes produce a great deal of injury to domestic animals. Among trematodes several flukes are parasitic in man. Human tapeworms often cause serious symptoms but are usually not dangerous to life. Nevertheless the larvae of one tapeworm, *Echinococcus granulosus* (Batsch), which lives as an adult in the dog, may occur in man, where they form cysts known as hydatids and, if not removed by operation, are often fatal. The injuries to domestic animals caused by tapeworms, though not so serious as to cause the death of the animal, are often sufficient to interfere somewhat with their usefulness.

CHAPTER XXXII

PARASITISM

ILLUSTRATED BY THE FLATWORMS

Parasitism is a very common association of animals of different species, characterized in a general way by the fact that one individual, known as the *parasite*, lives at the expense of another, called the *host*, but does not devour it. Some parasites infect only one host, but in other cases they pass successive periods of their lives in different hosts. In the latter case the host in which they reach the adult condition is known as the *final host*; and those in which they live during their larval development, *intermediate hosts*.

198. Structure of Parasites.—The parasitic flatworms illustrate several of the salient features of internal parasitism. The loss of certain organs by the parasite has been noted. The organs markedly affected are those of the digestive and nervous systems. On the other hand, other organs become more highly developed and new structures appear. Such structures are hooks and suckers, which serve for more effective attachment and result in more perfect adaptation of the organism to the conditions of parasitic life. The epidermis is modified to resist the digestive juices of the host. Of the organs which show increased development the reproductive organs are the most prominent. There is so much uncertainty attached to the conditions of life that if it were not for the production of an enormous number of eggs, these parasites would cease to exist. At several points in the life history of the liver fluke and at two places in the life history of the tapeworm chance determines whether the life history is to come to an end or to continue. It is stated that a single liver fluke may give rise to as many as 500,000 eggs, and estimates of the number of eggs produced by a single tapeworm colony reach 60,000,000.

199. Sheep Liver Fluke.—The development of the sheep liver fluke (*Fasciola hepatica* Linnaeus) is usually taken as a type of that of the trematodes. This fluke is relatively large, being about an inch long. The most frequent final hosts are sheep and cattle, but it may be found in any one of a number of smaller mammals and rarely in man. The parasite may be lodged in other tissues than the liver. In man it has been known to live four years. This fluke is found in various parts of the world wherever sheep are raised, and different species of snails serve as intermediate hosts in different regions.

200. **Life History of the Sheep Liver Fluke.**—The following is an epitome of the life history of this liver fluke (Fig. 80):

1. The egg cell is produced in the ovary of the fluke and is passed down the oviduct, being fertilized on the way. It becomes enveloped by yolk derived from the yolk glands and chitin-forming material also

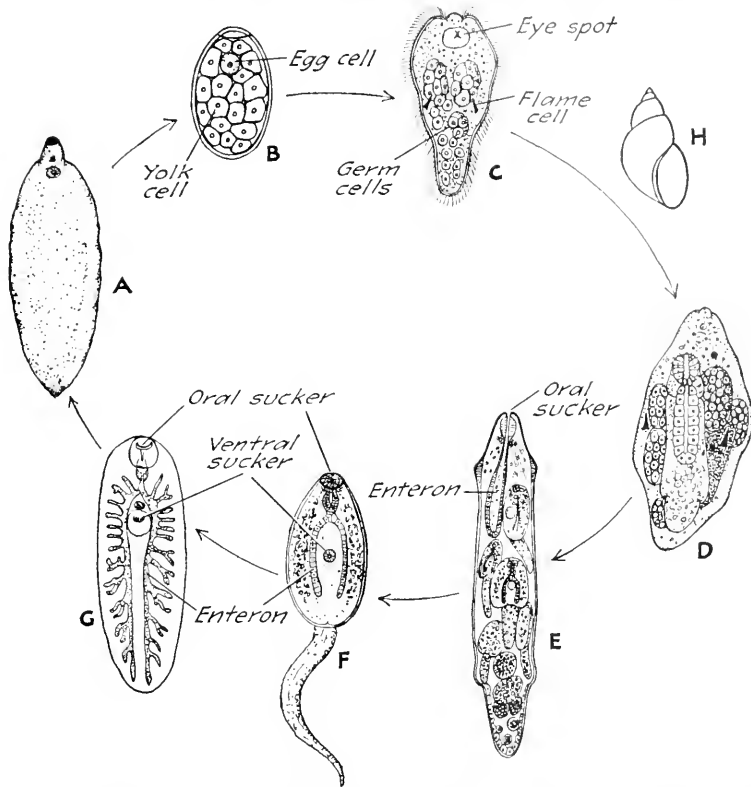

FIG. 80.—Diagram of the life history of a sheep liver fluke. A, the fluke. Natural size. B, the egg. $\times 135$. C, the miracidium with cilia, eye spot, and developing germ cells. $\times 135$. D, the sporocyst, containing developing rediae. (C and D from Leuckart, "Parasiten des Menschen.") $\times 135$. E, the redia, with cercariae developing within it. (From Brumpt, "Précis de Parasitologie," after Thomas, and by the courtesy of Masson & Co.) $\times 135$. F, the cercaria, somewhat modified. (From Leuckart.) $\times 150$. G, the young fluke. (From Borradaile, "Manual of Zoology," after Thomas, and by the courtesy of Oxford University Press.) H, *Lymnaea humilis* Say, the snail which is supposed to be the intermediate host of the sheep liver fluke in the United States. $\times 1\frac{1}{3}$.

received from the yolk glands is hardened into a shell by a secretion from the shell glands (Fig. 77).

2. The egg passes to the uterus of the fluke and there development begins.

3. The egg, containing the embryo, passes out of the uterus of the fluke and out of the body of the sheep with the feces, by way of the bile ducts and intestine.

4. If the egg falls into water which is at a temperature of about 24°C. (75°F.), the embryo continues to develop and, after two or three weeks, hatches, producing a ciliated larva known as a *miracidium*. This larva resembles a free-living planarian in that it possesses a soft ciliated skin and a double eyespot on the dorsal surface anteriorly. It also has a pair of flame cells, a ganglion beneath the eyespots, and a pointed rostrum at the anterior end. It swims about in the water but dies if it does not find a snail of the right species within eight hours.

5. Having found such a snail the miracidium enters its pulmonary chamber and remains there. After about two weeks the parasite attaches itself to the wall of this chamber by its rostrum, burrows into the tissues, reaches the liver, and changes into a *sporocyst*.

6. Within the sporocyst, from germ cells which, without fertilization, develop and pass through the blastula and gastrula stages, there are produced a number of *rediae* which escape from the sporocyst. Each redia is provided with a mouth, an oral sucker, and a simple enteron.

7. Within each redia, daughter rediae are produced from unfertilized germ cells. There may be several generations of these.

8. Finally a generation of rediae gives rise to a different type of larva known as a *cercaria*, which is quite different in form from a redia. The cercaria possesses a body and a tail, a ventral sucker in addition to the oral sucker, and a branched enteron.

9. The cercaria leaves the snail and after swimming about in the water for a short time encysts on a bit of vegetation. At the time of encystment the tail is lost, and within the cyst the structure gradually comes to resemble that of the fluke.

10. If this cyst is eaten by a sheep, the immature *fluke* is freed from the cyst in the alimentary canal and by means of the bile ducts passes to the liver, where it becomes mature.

This life history is considered as representing one generation, the different stages being larval forms. The sheep liver fluke, therefore, exhibits a complicated *metamorphosis*. The reproduction which occurs in the sporocyst and redia stages is interpreted as *pedogenesis*.

There are trematodes which develop directly from the egg, but the more usual life history includes several stages, and very frequently the parasite has two, and sometimes even three, hosts.

201. Life History of a Tapeworm.—The life history of a cestode (Fig. 81) also involves two hosts, the final host becoming infected with the parasite through eating the intermediate host. A typical life history is that of the beef tapeworm, *Taenia saginata* (Goeze), the adult of which is found in the human intestine, and which passes through the following steps in its life history:

1. The egg cell is produced in the ovary, passed into the oviduct, fertilized, supplied with yolk, inclosed in a shell, and carried to the uterus.

In the uterus there develops in this *egg* a six-hooked *embryo*. As the proglottid becomes ripe and passes out of the body of the host with the feces, it carries with it thousands of embryos, still inclosed in the egg shells.

2. If this proglottid falls upon vegetation and is eaten by a cow, the eggs are freed from the proglottid in her intestine and the embryos escape.

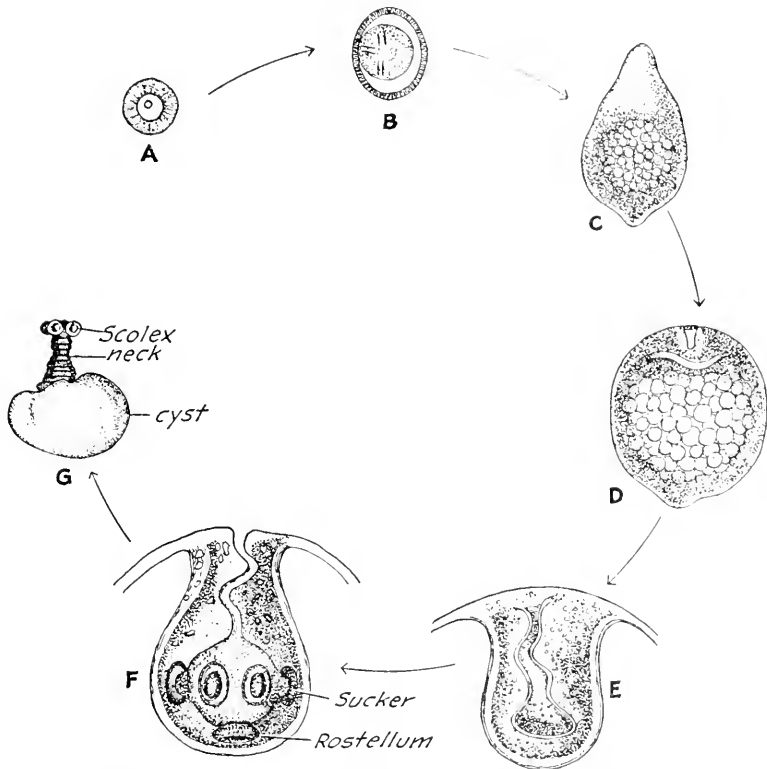

FIG. 81.—Diagram showing the life history of *Taenia saginata*. A, the egg. $\times 550$. B, egg containing six-hooked embryo. $\times 550$. C, young cysticercus. $\times 30$. D, cysticercus showing beginning of the papilla. $\times 30$. E, the papilla showing an early stage in the development of the scolex. $\times 30$. F, the papilla containing the scolex, with suckers and rostellum. The latter has rudimentary hooks, which later disappear as the rostellum is retracted into the scolex. $\times 40$. G, the scolex and neck everted but still attached to cyst. $\times 3$. (All from Leuckart, "Parasiten des Menschen.")

They bore their way through the wall of the alimentary canal and, migrating through the tissues, reach the voluntary muscles, especially the muscles of mastication, where they become encysted.

3. The encysted larva in from three to six weeks develops a bladder-like sac filled with a clear watery fluid and so becomes a bladder worm, or *cysticercus*. One side of the wall of this sac gradually becomes thickened, is inverted, and forms a hollow papilla projecting into the sac.

From the outer surface of the wall and in the cavity of this papilla develops a scolex, with hooks and suckers.

4. If the flesh of the cow has been insufficiently cooked and is eaten by man, the cysticercus is freed in the alimentary canal, the papilla becomes everted, the scolex and neck project from the side of the bladder, and the latter is destroyed.

5. This scolex attaches itself to the wall of the intestine, begins to develop proglottids, and thus a new *tapeworm* is produced.

The life history of the tapeworm seems best interpreted as including an asexual generation of proglottids produced from the scolex and neck by a process of budding. These proglottids in turn reproduce sexually. Thus the life history illustrates the phenomenon of *metagenesis*.

202. Behavior of Parasites.—The life history of these parasites shows a changing behavior in the passage from one larval form to another and from one host to another. Only changing chemical and contact reactions can explain the entrance of a miracidium into the body of the snail and the leaving of it by the cercaria. Changing physiological states undoubtedly accompany this changing behavior.

203. Practical Aspects.—A knowledge of the life histories of such parasites as those that have been considered is evidently of great value, since it dictates the character of the control measures which must be taken. It is evident, for example, that if the fluke infection is discovered in a flock of sheep, all infected animals should be removed from the flock. It is also evident that when infection is known to exist, a flock should be removed to a pasture which contains no standing water and, if possible, to one which has never had sheep upon it before. The character of the life history of the fluke explains the freedom from infection in the flocks on the dry ranges of the western states. In man the liver fluke may produce no serious symptoms, but in some cases it has produced fatal results. It has been removed from superficial abscesses. In the sheep it causes serious functional disturbances and often death, though the parasite may pass out of the host and spontaneous recovery ensue.

Man is subject to infection by tapeworms acquired from pork, fish, and, less frequently, other animals, but the beef tapeworm is the most common human tapeworm in this country. Most human tapeworm infection can be avoided by measures that will insure careful meat inspection and the consumption of no meat that is not well cooked.

CHAPTER XXXIII

PHYLUM NEMATHELMINTHES

The representatives of the phylum Nematelminthes (něm á thěl mǐn' thēz; G., *nematos*, thread, and *helminthos*, worm) are called, collectively, roundworms or threadworms. Some of them are free-living; others are found in plant tissues, where they may be the cause of plant diseases; and still others are parasites in other animals. Generally speaking, the nematelminths are small and even microscopic, but a small number reach a larger size and a few may even be several inches in length.

204. Structure of an Ascaris.—An ascaris may be taken as a type of the phylum. Logically a free-living type would be preferable, but the size of an ascaris and the ease with which it may be secured render it the most practical one. The genus *Ascaris* includes roundworms of about the size and with the general proportions of an earthworm but possessing no metamerism (Fig. 82). A common species, known as the eelworm or the pig ascaris, *Ascaris lumbricoides* Linnaeus, is found in the intestines of pigs and human beings. The mouth is at the anterior end of the body and an anal opening at or near the posterior end. When opened, the animal is seen to possess a relatively thin body wall surrounding a central cavity, through which runs the alimentary canal (Fig 83). This canal consists of a short muscular sucking pharynx, a long nonmuscular intestine, and a short rectum. The excretory system consists of two longitudinal canals, one of which runs along each side of the body, the two opening to the outside by a single pore on the ventral surface near the mouth. There are no flame cells, but four large branched excretory cells are present in the anterior part of the body. A circumpharyngeal nerve ring, containing nerve cells, surrounds the pharynx and is connected with two

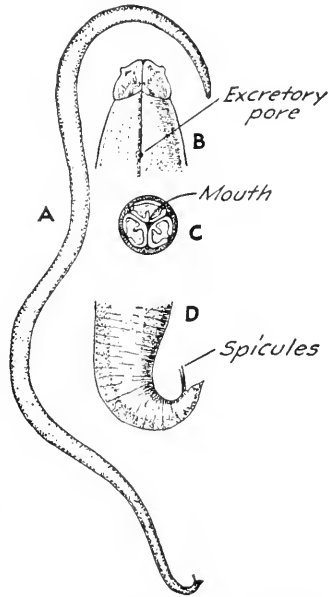

FIG. 82.—*Ascaris lumbricoides* Linnaeus. A, male. $\times \frac{1}{2}$. B, the anterior end of the body. C, end view of the anterior end, showing three lips. D, posterior end. (B to D from Leuckart, "Parasiten des Menschen.") Magnified.

larger nerve trunks, one dorsal and the other ventral, and one or two smaller trunks on each side. The body cavity is not strictly comparable to the coelom of higher forms, since it lies between the entoderm of the alimentary canal and the mesoderm which forms the muscular layers of the body wall (Fig. 83), whereas a typical coelom is completely invested by mesoderm. Large cells, containing enormous vacuoles, have been described as present in the body cavity.

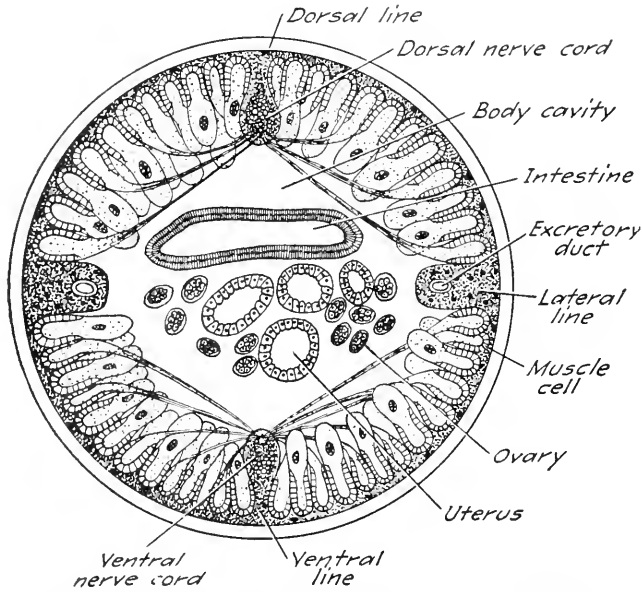

FIG. 83.—Semidiagrammatic cross section of an ascarid. (Based upon Leuckart, *wall chart*.) Processes of the muscle cells are seen running across to the dorsal or ventral nerve cords.

205. Characteristics and Advances.—The nemathelminths are bilaterally symmetrical and triploblastic. The greatest advance is seen in the development of an *alimentary canal* to replace the gastrovascular cavity, the disadvantages of which are easily made apparent. An animal which has a gastrovascular cavity, the one opening into which serves as both mouth and anus, is manifestly at a great disadvantage when it comes to taking in food and passing out waste. Attention has been called to the fact that a hydra which has fed will not again take food until the food it already has is digested and the waste matter is passed out. Should an animal with such a digestive cavity take additional food, the mixing of food at various stages of digestion would inevitably occur, which would be clearly a disadvantage. Furthermore, although the digested food seems to be effectively distributed by the much-branched gastrovascular cavity of the turbellarian, the increasing development of the mesoderm makes such distribution correspondingly more difficult. In contrast to

this the alimentary canal, open at the two ends and running the length of the body, makes it possible for the animal to feed continuously, taking food at the mouth and passing it gradually through the intestine. Here each successive increment is kept separate, at least to a considerable degree, from the food taken earlier and later, and the feces from each are egested in due time. An alimentary canal, however, will be most effective if it is a straight unbranched tube, and it seems to be a significant fact that when we come upon such an enteron it is at once divested of all branches. In the absence of this means of distributing the digested food some other means must exist, and this is furnished by the *body cavity*.

206. Classification.—The phylum Nematelminthes may be considered as including three classes:

1. *Nematoda* (něm á tō' dá; G., *nematos*, thread, and *eidos*, form).—Either parasitic or free-living.

2. *Gordiacea* (gōr dī ā' shē á; L., *gordius*, referring to a complicated knot).—Parasitic in the larval stages and free-living and aquatic as adults.

3. *Acanthocephala* (á kǎn thō sěf'-ā lá; G., *akantha*, thorn, and *kephale*, head).—All parasitic.

207. Free-living Nematodes.—An inconceivably large number of minute free-living threadworms exist in the soil, in sand, mud, and debris from standing and running water, and in the sea. They are thus adapted to a great variety of habitats, are very resistant to drying and freezing, and are disseminated in numerous ways. The number of species is now believed to be very large, but to a great extent they are undescribed. At the present time these free-living nematodes are often called *nemas* (Fig. 85).

208. Metabolism.—The food of roundworms is mostly fluid, being either blood or other juices from the host if the worm is a parasite; the juices of plants; or water containing microorganisms or organic matter in solution if the animal is free-living. This liquid food is pumped into the alimentary canal by the pharynx, is digested in the intestine, and is freely passed by absorption through the thin wall of the intestine into the body cavity. By means of this cavity it is distributed throughout the body. Within tissues it is passed from cell to cell. Egestion takes

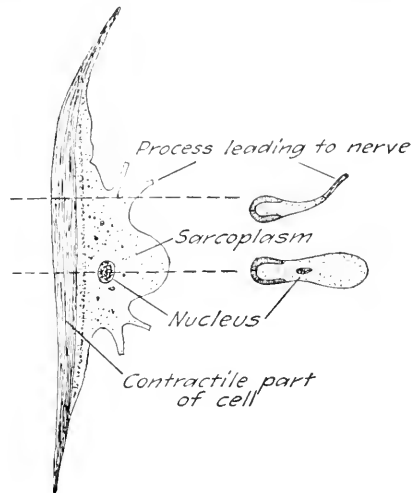

FIG. 84.—A muscle cell from an ascaris. These cells run longitudinally and are shown in cross section in Fig. 83. At the right are shown two sections of the same cell to show how the appearances seen in Fig. 83 are produced. (*The cell from Leuckart, "Parasiten des Menschen."*) The contractile part of the cell is indicated by lines, the non-contractile part by stippling.

place through the anal opening and elimination is effected by the excretory system.

209. Reproduction.—The nemathelminths are all dieocious, and fertilization is internal. After fertilization those eggs which develop within the body, as in the species of *Trichinella*, are lodged in the uterus, where they hatch, the female bringing forth living young. In case the eggs are laid, they are provided with yolk and shells and when passed out of the body contain embryos. The shell is often heavy and very resistant

to chemicals which would injure the organism. The larva, which at first may be free and may remain so in free-living nematodes, enters, in the case of all parasitic forms, into another animal which may be either an intermediate or a final host.

210. Life History of the Pig Ascaris.—The parasitic nematodes possess some very interesting and remarkable life histories. One of these is that of an ascaris found in the pig. The adult pigs are immune from infection by this parasite, which, if it is found in a mature pig, must have entered it when it was young. The eggs of the parasite, after being passed out with the feces and mixed with the soil in the hog lot, are taken up by the young pigs as soon as they begin to root about; or if infested soil is caked upon the body of the mother, the eggs may be taken in when suckling. The eggs pass into the intestine of the young

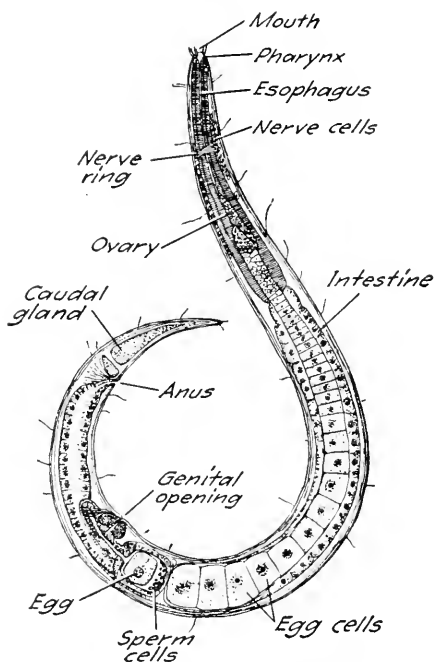

FIG. 85.—*Monhystera sentiens* Cobb, a free-living nematode. Side view of female. Probably the most widely spread nematode genus, found in fresh water, in the sea, and in soil. (From Cobb, in Ward and Whipple's "Fresh-water Biology," by the courtesy of John Wiley & Sons, Inc.) $\times 94$.

pig and by the destruction of the shells the larvae are freed. The larvae then leave the intestine by puncturing the wall and pass by way of the portal system of blood vessels to the heart. From the heart they follow the pulmonary artery to the lungs, make their way through the walls of the lung cavities into the air spaces in the lungs, and then, by following the free surfaces of the air passages to the pharynx, reach the alimentary canal. Following this canal they return to the intestine to complete their growth, mature, and reproduce.

This journey through the body is injurious to the young pig, retarding its growth. The passage of the worm through the lungs causes serious pulmonary disturbances, and young pigs harboring the parasite remain poorly nourished, weak, and unprofitable to the grower. Infection is avoided by carefully cleaning the body of the mother before the time for farrowing, by placing her at this time in a perfectly clean pen with clean straw, and by removing both her and the young pigs to clean pasture just as soon as they can be taken out of the farrowing pen. It is also not advisable to use the same hog lot year after year.

211. American Hookworm.—

Another nematode that makes an interesting journey through the body of the host, which is man, is the hookworm, *Necator americanus* (Stiles). In our southern states this worm (Fig. 86) formerly affected a large population, estimated to number two millions, known as "poor whites," who were noteworthy for their shiftlessness, although they were the descendants of very good immigrant stock. These people lived in cabins, frequently with no other floor than the bare earth, were in the habit of going barefooted, and were unsanitary in the disposal of fecal waste. The eggs of the hookworm produced in the bodies of the persons afflicted with this parasite are passed out with the feces and deposited on moist earth. The larvae which hatch from these eggs moult twice before they become infective. Then when the skin of another person,

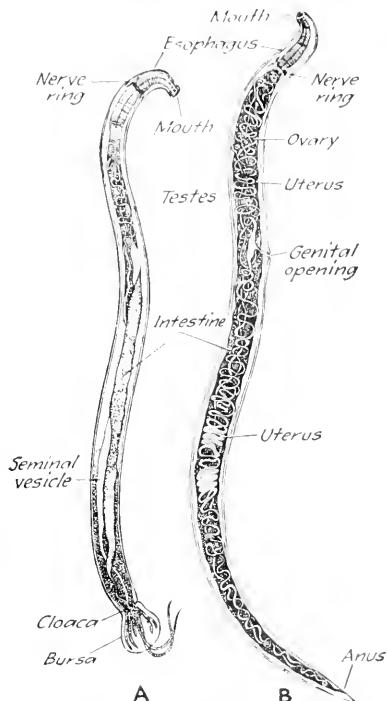

FIG. 86.—*Necator americanus* (Stiles). A, male. B, female. (From Manson, "Tropical Diseases," after Placcencia, by the courtesy of Cassell & Company.)

most frequently that on the foot or the hand, comes in contact with this infested earth, the larvae enter the body by boring through the epidermis and thus reaching the lymphatics or capillaries immediately under it. They may enter the body by means of water or food but this is not the usual mode of infection. From the point of entrance the larvae pass either by the veins alone or by lymphatic vessels and veins to the heart and from there, still following the stream of venous blood, through the pulmonary artery to the lungs. Leaving the blood, they pierce the walls of the lung cavities, enter those cavities and follow the air passages to the pharynx, from which, by way of the

alimentary canal, they go to the intestine. Here they mature and another generation is produced.

In the passage through the lungs injury is done which predisposes the host to lung diseases. While in the intestine the parasites feed upon the blood of the host, which is obtained by puncturing the intestinal wall. When this puncture is made, a poison is introduced which prevents the coagulation of the blood, and so the person loses blood from hemorrhage in addition to that which is taken by the parasite. Anemia and weakness result which incapacitate the person for any effective effort. By preventive measures, such as putting floors in the houses, requiring the people to wear shoes, providing sanitary means for the disposal of fecal waste, and by appropriate treatment of the patients, the disease has been very largely eradicated. Through education of the people further infection has been prevented.

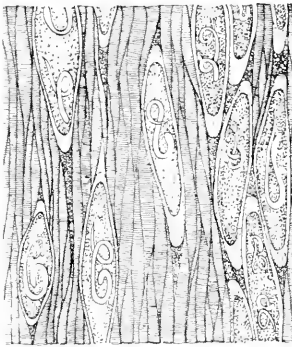

FIG. 87.—Section of pork containing encysted larvae of *Trichinella*.

212. *Trichinella*.—A third parasitic nematode is that known as *Trichinella spiralis* (Owen), which is the cause of a disease known as trichinosis in rats, pigs, and human beings. The animal which acquires this parasite does so by eating the meat of another animal which has the disease and in the flesh of which are the encysted larvae in an advanced stage of development. When these are taken into the alimentary canal they are freed from the cyst and escape into the intestine, where they live upon the food in the canal and become mature in as short a period, perhaps, as two days. In the body of the female, eggs are produced, and fertilization, development, and hatching take place, the worm being viviparous. The female burrows into the wall of the intestine and deposits the young larvae in the lymph spaces of the villi (Fig. 8). The larvae follow the lymphatics and blood vessels to the voluntary muscles in various parts of the body where they encyst (Fig. 87). After a rapid development in the cysts they are ready to be transferred to another host. If this does not occur soon, lime becomes deposited in the walls of the cysts and the larvae may remain alive for many years. The length of life of the adults is usually only a few weeks.

Since both rats and pigs eat the dead carcasses of other animals, the parasite when present is likely to be passed from one animal to another and to give rise to generation after generation. Man comes into this cycle of parasitism by eating inadequately cooked pork and thus taking in the larvae, which pass the rest of their life history within his body. The disease is very serious, being usually fatal. It can, of course, be prevented by the inspection of meat and by the destruction of infected

meat whenever found. Even infected meat, however, would not be dangerous if it were thoroughly cooked. An undesirable practice which formerly prevailed on farms in some localities was to leave dead animals exposed where living animals could eat them. It is better to burn such carcasses or to bury them so deep that animals cannot reach them.

213. Filaria.—The nematodes known as filariae include a number of species which affect both man and domestic animals, particularly in the tropics. The most injurious type is *Wuchereria bancrofti* (Cobbold), which is a threadworm living in the lymphatic system of man. The larvae of this parasite are carried about in the blood, retreating to the center of the body in the daytime but at night migrating to the peripheral blood vessels in the skin. At times the adults exist in such numbers as to obstruct the passage of the lymph and cause a swelling of the limbs and other parts of the body, which suggests the name of the resulting disease, elephantiasis. At night, when the larvae are active and are in the peripheral vessels, they are sucked up by mosquitoes. They continue their development for a time in the mosquito's body and when the mosquito bites another person are transmitted to him. Elephantiasis is a very serious disease, particularly in the South Sea Islands.

214. Hairworms.—A worm which is popularly known as the horsehair snake, and which is believed by many ignorant of zoology to be produced in water from the hairs of horses, is by most authors placed in this phylum. The class to which this worm belongs, known as the Gordiacea, and of which the type genus is *Gordius*, includes several forms, some occurring in fresh water and others being marine. The life histories of these is not well known. The egg is laid in the water and from it hatches a larva with a large proboscis and hooks at the anterior end. Using these in boring, a larva has been known to force its way into the body of an aquatic insect. Full-grown larvae have been found in beetles, grasshoppers, and crickets, and larvae in different stages of development in spiders, earthworms, and snails, but how they got into these hosts does not seem to be known. The fully developed larva escapes from the host into water, where it matures and where it may be found, often coiled about among the leaves of aquatic vegetation (Fig. 88).

215. Spiny-headed Worms.—Another class of worms which may also be placed in Nematelminthes is that of the spiny-headed worms, or

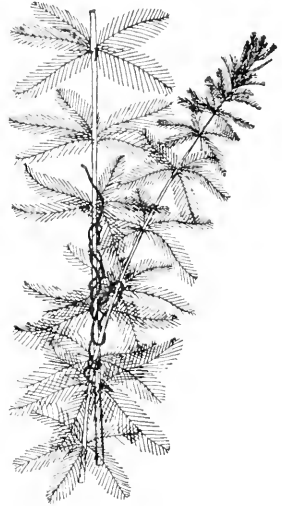

FIG. 88.—Portions of two branches of water milfoil (*Myriophyllum*) in which is coiled a specimen of *Gordius*. Natural size.

Acanthocephala. Such a worm has a protrusible proboscis covered with hooks at the anterior end of the body (Fig. 89). By means of the proboscis it becomes attached to the intestinal wall of the host, which is always a vertebrate. The worm lacks an alimentary canal and absorbs digested food in the intestine of the animal in which it lives. All classes of vertebrates are parasitized by these worms, but they occur more commonly in the fishes, in turtles, and in birds like the herons and bitterns.

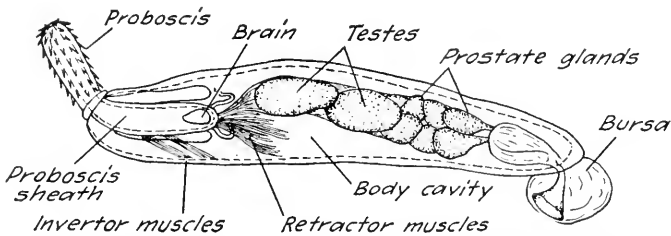

FIG. 89.—*Echinorhynchus ranae* (Schränk), showing general organization of a young male. (From VanCleave, "Invertebrate Zoology," by the courtesy of McGraw-Hill Book Company, Inc.)

The intermediate hosts of many of them are Crustacea and aquatic insects. A spiny-headed worm which infects the pigs in the southern parts of this country has as its intermediate host the larva of the June beetle, known as the white grub, which is rooted up and eaten by the pig.

216. Economic Importance.—It is clear that some of the parasitic nematodes are of great economic importance on account of the production of disease both in man and in domestic animals. Among the thread-worms are also some which are injurious to cultivated plants. Others are distinctly beneficial, feeding upon the injurious forms or destroying various injurious microorganisms.

CHAPTER XXXIV

OTHER UNSEGMENTED WORMS

From the time of Linnaeus in 1758 until the end of the last century a diverse group called Vermes, or worms, was recognized as one of the primary groups of the animal kingdom. It has now been broken up into several groups, some of which are considered phyla. Included among these are Platyhelminthes, Nemathelminthes, Annelida, and the phyla considered in this chapter.

217. Phylum Nemertinea.—One of these phyla, by some classified with Platyhelminthes, is Nemertinea (něm ər tīn' ē ā; G., *nemertes*,

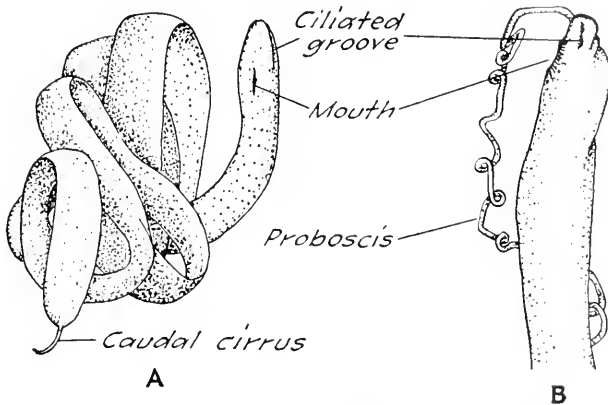

FIG. 90.—*Cerebratulus*, a nemertine. A, *Cerebratulus lacteus* (Verrill), a common species of the Atlantic Coast. The head seen from the ventral side. (From Pratt, "Manual of the Common Invertebrate Animals," by permission.) Natural size. B, *Cerebratulus* sp. from Naples, showing a side view of the head with proboscis everted. From a preserved specimen. (From Sheldon, "Cambridge Natural History," by the courtesy of The Macmillan Company.) $\times 2$.

unerring), which contains the bandworms. They are flat and bandlike (Fig. 90), resembling somewhat in this respect the flatworms, but are clearly distinguished by certain structural features, among which is the presence of a long *proboscis* which lies in a sheath within the body, dorsal to the alimentary canal. This proboscis may be protruded anteriorly and used as an organ of touch and also as a protective and defensive organ. Another characteristic is the development of the *blood-vascular system*, which is seen here for the first time and which consists of a median dorsal and two lateral trunks. These animals also possess an *alimentary canal* with mouth and anus. They are generally considered as possessing

no coelom. The nervous system consists of two ganglia, one on each side of the proboscis at the anterior end of the body connected by commissures dorsal and ventral to the proboscis, and two nerve trunks running backward along the sides of the body. Many of them have eyespots, and some possess eyes with a sort of lens, pigment, and retina.

A few species are found in moist earth and fresh water, but most of them are marine, being found coiled up under stones and other objects on the beach at low tide or crawling over the sand as the water recedes with the falling of the tide. Many nemertines are brightly colored. They are exceedingly soft-bodied and when lifted have not sufficient

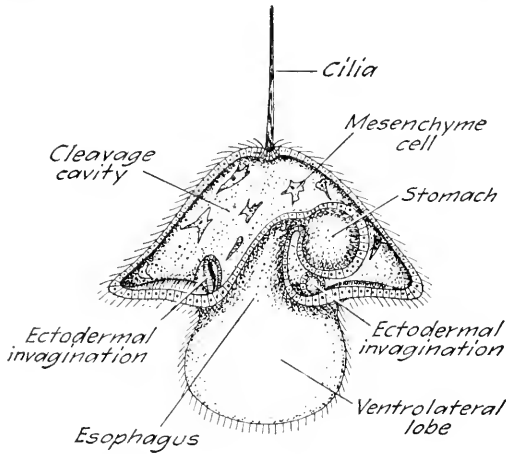

FIG. 91.—The pilidium larva. Median section, showing the inner surface of the ventrolateral lobe on the farther side. This lobe is hollow, containing a prolongation of the cleavage cavity. (Compiled from several sources.)

consistency to support their own weight. As one raises them by one end they continue to stretch until finally they may even break in two. One genus, *Malacobdella*, is parasitic in a European marine bivalve mollusk.

The bandworms feed on other animals, both dead and living. They move by means of cilia which cover the surface of the body, by constrictions of the body wall, by vertical undulations of the body, or by using the proboscis as an organ of attachment. They secrete a great deal of mucus which may of itself become firm and produce a protective tube, or they may make a tube by sticking together particles of sand. They possess great powers of regeneration, which might be expected considering the readiness with which the body is broken. They also show autotomy, which is the ability of an animal itself to break its body into pieces.

The larval nemertine, known as a *pilidium*, is a ciliated swimming larva, somewhat conical in form, with downwardly projecting lateral lobes and a long tuft of cilia at the apex (Fig. 91).

218. Phylum Chaetognatha.—The group Chaetognatha (kē tōg'-nāth ā; G., *chaite*, horse's mane, and *gnathos*, jaw) has been variously placed in the animal kingdom; by some it is considered allied to the nemathelminths and by others to the annelids. By still others it has been ranked as a phylum. It is a small group containing the arrow worms, the most familiar of which belong to the genus *Sagitta* (Fig. 92). These are small, straight-bodied, and exceedingly transparent worms with a true coelom, an alimentary canal, and the body divided into three parts, which do not seem to be metameres. There are supraesophageal and ventral ganglia, two eyespots, and other sensory structures. Arrow worms have neither vascular nor excretory systems. They swim about on the surface of the sea, being present at times in very large numbers.

219. Phylum Rotifera.—The phylum Rotifera (rō tīf' ēr ā; L., *rota*, wheel, and *ferre*, to bear) includes small, aquatic animals, many of them

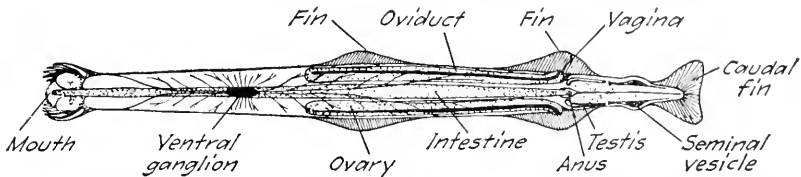

FIG. 92.—*Sagitta hexaptera* D'Orbigny. Ventral view. (From Lang, "Text-book of Comparative Anatomy," after O. Hertwig.) $\times 20$.

not larger than protozoans. They are often encountered abundantly in waters in which Protozoa also abound. Rotifers can be recognized by the possession on the anterior end of cilia which in some cases are grouped in circles. Such circular groups, owing to waves of motion which pass rhythmically around the circle of cilia, produce when in action the effect of revolving wheels (Fig. 93). Moreover, if the internal structure is examined it at once reveals a complexity belonging not only to a metazoan animal but also to one which is triploblastic and bilaterally symmetrical and which possesses organs and systems. Owing to the presence of the rings of cilia on the head, these forms have often been called Trochelmintes (trōk hēl mīn' thēz; G., *trochos*, wheel, and *helminthos*, worm).

The bodies of rotifers are divided into three regions, which are a head, a trunk, and a foot, the last forming the pointed posterior end. The foot is frequently bifurcated and may assist in locomotion by serving to kick the animal along (Fig. 94). It possesses a *cement gland*, the secretion of which affords a means of attachment in the fixed forms. The body is covered by a cuticula. The cilia are the principal means of locomotion and also serve to create a current of water which brings food to the mouth. There is a large *body cavity* which is like that of Nematelminthes and therefore not strictly comparable with the coelom of higher forms. It contains the alimentary canal, and in its walls are the gonads and flame cells. The alimentary canal opens into a cloaca near

the posterior end of the body. The term *cloaca* is applied to any cavity into which open both the alimentary canal and ducts belonging to the excretory and reproductive systems, and which in turn opens externally. A ganglion lies against the wall of the body dorsal to the pharynx and a second one may be present on the ventral side. Sense organs are also present in the form of antennae, or feelers, and eyespots. The food of rotifers consists of protozoans and other small organisms.

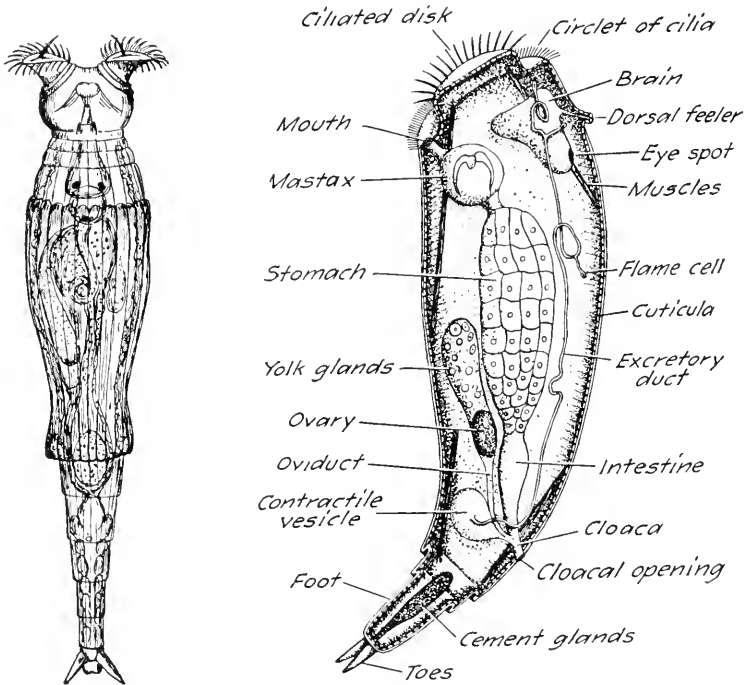

FIG. 93.

FIG. 94.

FIG. 93.—*Philodina roseola* Ehrenberg. Not a typical rotifer, but one of the first types studied by microscopists; the ciliated disks on the head of the organism suggested the name rotifer. It both creeps and swims. A common American species. (From Jennings, in Ward and Whipple, "Fresh-water Biology," after Weber, by courtesy of John Wiley & Sons, Inc.) $\times 300$.

FIG. 94.—Diagram of a rotifer in section to show internal structure. The specimen is a female. (From Parker and Haswell, "Textbook of Zoology," by the courtesy of The Macmillan Company.)

Rotifers are dioecious and also polymorphic. The males are usually smaller than the females and frequently exhibit *degeneration*. This is a condition involving simplification of structure and loss of organs. It is exhibited by parasites, as in the platyhelminths, but it also occurs apart from parasitism. The eggs are carried by the oviduct into the cloaca and thus reach the outside. Rotifers produce three types of eggs—female-producing summer eggs, smaller male-producing summer eggs, and female-producing winter eggs. Both types of summer eggs have

thin shells and develop parthenogenetically. The winter eggs have thick shells, and development follows fertilization. The winter eggs require a considerable degree of acidity of the water to soften the shells so that they may hatch, and if this does not occur they are capable of living for many years and of still developing when placed under suitable conditions.

A marked peculiarity of certain rotifers is their power to undergo drying and when again under favorable conditions to resume life activities. This ability and their small size contribute to the ease with which they may be dispersed by the wind. This ease of dispersal by wind, added to the possibility of their being carried on the feet of water birds, has resulted in a distribution which is of more cosmopolitan character than that exhibited by any other group of animals. Rotifers which produce fertilized eggs cannot resist desiccation.

220. Phylum Bryozoa.—The animals included in the phylum Bryozoa (brī ō zō' ā; G., *bryon*, moss, and *zoon*, animal) are known in a general way as moss animals and sea mats. They are colonial forms and their manner of growth reminds one of the colonial hydroids, but their structure distinguishes them very clearly. Like the hydroids they have plantlike characteristics which often cause them to be included in collections of dried seaweeds brought as souvenirs from a seaside trip. The bryozoans are mostly marine, though a few live in fresh water. They are all very small, but a colony consisting of a large number of individuals may attain considerable size, projecting in some cases several inches from the surface to which it is attached. Some of these colonies show a treelike manner of growth and suggest the name sea moss (Fig. 95). Other colonies form matlike masses and are quite appropriately termed sea mats. They may be free, like the fronds of seaweeds, or encrust the surface of stones or other objects.

The individual animal lives in a cup-shaped or tubular chitinous shell, known as a *zoecium*, which is open at the outer end (Fig. 96). The surface of the body lines the inner wall of the shell and the animal is capable of withdrawing itself into a body cavity which in these forms is a true *coelom*. The chitinous shells of the individuals form together a support for the colony. Sometimes lime is added. Because of their superficial resemblance to corals such forms are known as coralline bryozoans. A mouth at the outer end is surrounded by a crown of ciliated tentacles termed the *lophophore*, which exhibits the form of a horseshoe when it is expanded. The U-shaped alimentary canal opens



FIG. 95.—A colony of marine bryozoans, *Bugula turbinata* Alder. A British species; an American species, *Bugula turrita* (Desor) is somewhat similar. (From Harker, "Cambridge Natural History," by the courtesy of The Macmillan Company.) Natural size.

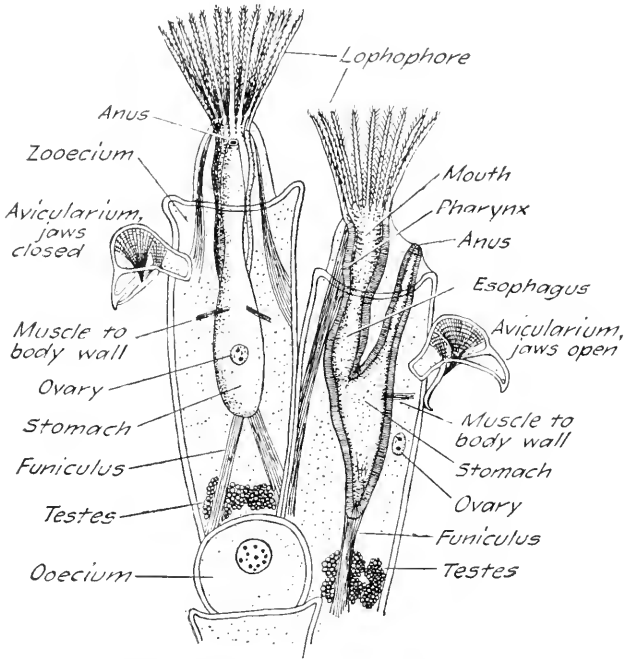

FIG. 96.—*Bugula avicularia* (Pallas), a European species. Two zooids are shown, the one at the left entire, that at the right turned 90 degrees to the first and sectioned. Two avicularia are shown, one with the jaws closed and the other with them open. An oocidium is also included in the figure. (Redrawn from Parker and Haswell, "Text-book of Zoology," somewhat modified.) Much magnified.

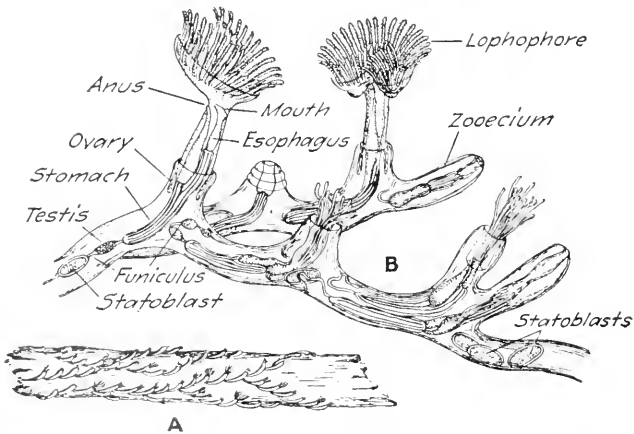

FIG. 97.—Fresh-water bryozoans. A, colony of *Plumatella* sp., growing on a fragment of a small branch of a tree. About natural size. B, several zooids of a colony of *Plumatella repens* (Linnaeus), a European species. (From Allman, "Monograph of Fresh-water Polyzoa.") Highly magnified.

by an anus situated near the mouth and either within or without the lophophore. There are neither circulatory nor excretory organs. The nervous system consists of a central ganglion between the mouth and anus. Reproduction is both sexual and asexual, the latter taking place by budding. These animals are either monocious or diecious. The eggs are fertilized in the coelom and develop in a modified portion of the body cavity called an *ooecium* which serves as a brood pouch. The larva is in many respects like a trochophore.

Certain species produce individuals of a peculiar type called *avicularia*. These are highly modified forms possessing a pair of strong jaws, which probably are used in defense.

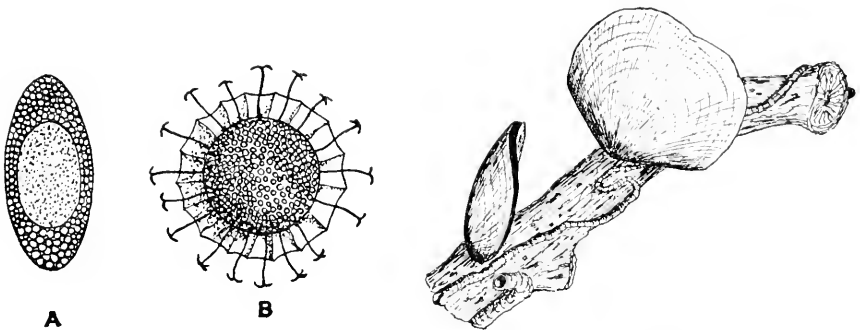

FIG. 98.

FIG. 99.

FIG. 98.—Statoblasts of two genera of fresh-water bryozoans. A, *Plumatella*. B, *Cristatella*. Much magnified.

FIG. 99.—Two specimens of *Tercebratella transversa* (Sowerby), a brachiopod common on the Pacific Coast. Natural size.

The fresh-water bryozoans (Fig. 97) form mosslike colonies attached to plants, sticks, or stones, usually near the surface of quiet water, though they have been found in Swiss lakes at a depth of over 40 fathoms. Some have the power of movement, the whole colony very slowly crawling along on its base. These fresh-water forms have developed a type of winter egg known as a *statoblast* (Fig. 98), which is produced in the fall, inclosed in a chitinous shell, and may either fall to the bottom of the body of water in which it is or float. Freezing does not interfere with its development in the spring but rather seems to stimulate it.

An enormous number of fossil forms have been described and some of these are very similar to species now living.

221. Phylum Brachiopoda.—The animals included in Brachiopoda (brăk ī ōp' ō dā; G., *brachion*, arm, and *podos*, foot) resemble certain mollusks in that they possess a bivalve calcareous shell (Fig. 99). For that reason they have in the past been generally considered as belonging to the field of conchology, the science which deals with the mollusks. They have also been frequently grouped with the Bryozoa in a phylum called Molluscoidea. The brachiopods, however, differ from the bivalve

mollusks in that the two valves of the shell are dorsoventral and not lateral and that the internal structure is more wormlike than mollusk-like. They are often called lamp shells because of the resemblance of the shell, when viewed from the side, to an antique lamp. The ventral valve is larger than the dorsal one and at the margin where the two articulate extends beyond the other, forming a beak. The tip of this beak is pierced by an opening, or *foramen*, through which is passed a fleshy *peduncle* which permanently attaches the animal to some object.

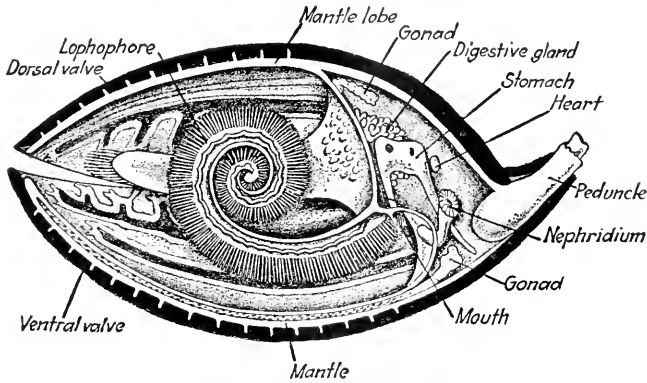

FIG. 100.—Semidiagrammatic longitudinal section of a brachiopod, *Magellania lenticularis*. (From VanCleave, "Invertebrate Zoology," after Parker and Haswell, by the courtesy of McGraw-Hill Book Company, Inc.)

Brachiopods also possess a *lophophore* (Fig. 100), which consists of two coiled arms bearing many ciliated tentacles. The function of this lophophore, as in the Bryozoa, is to collect food and draw it into the mouth. A true *coelom* is present. The animal possesses a heart and blood vessels.

The brachiopods are all marine and have lived in the seas since very ancient times. In past ages they have been more abundant than at present, but many of them have come down to us practically unchanged. One, *Lingula*, lives in the seas today and exhibits the same characteristics as it did in the Silurian period, which, according to different estimates, was anywhere from 25,000,000,000 to 300,000,000 years ago (Fig. 312).

CHAPTER XXXV

STARFISH

A TYPE OF THE PHYLUM ECHINODERMATA

Starfishes are generally distributed along all marine coasts but are much more abundant where the shore is rocky than where it is composed of sand or mud, for they can make little headway on a bottom which is soft and yielding. They are also found clinging to piers, piling, and other solid objects in the water which offer firm attachment. Along the shores

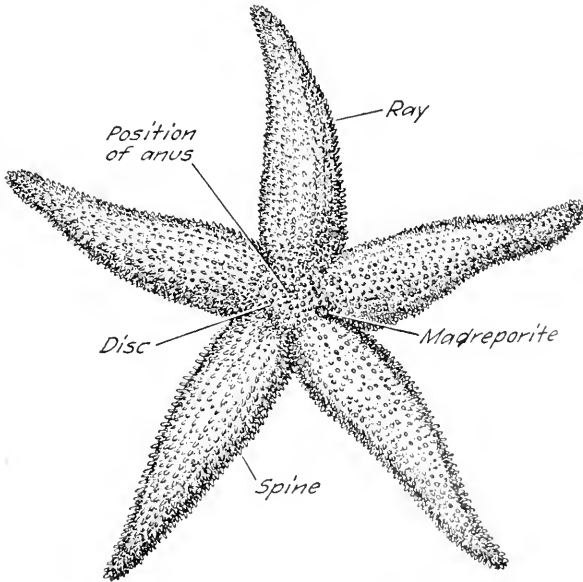

FIG. 101.—Aboral surface of a starfish, *Asterias vulgaris* Verrill. From a preserved specimen. $\times \frac{1}{2}$.

of Puget Sound, where conditions are very favorable and where starfishes become exceedingly abundant, the rocks at low tides are often closely sprinkled with them. In certain places a bushel basket may be filled with those which have gathered under a large boulder, where they are protected from the direct rays of the sun and therefore do not suffer greatly from drying. They usually remain quiet in the daytime. When clinging they adhere closely and it sometimes requires considerable force to dislodge them, the tube feet being torn in the effort.

222. External Appearance.—A typical starfish is an animal consisting of a *disc* from which arise five *rays*. The bases of these rays occupy the whole circumference of the disc, but they taper to blunt points at their tips. The upper, aboral surface (Fig. 101) is covered with *spines*, around the base of which are grouped very minute organs known as *pedicellariae*. When examined under the microscope a *pedicellaria* (Fig. 103 A) is seen to possess two jaws which differ somewhat in different types. These structures serve to rid the surface of the body of foreign objects. The disc and rays may be considered as divided by imaginary lines into sec-

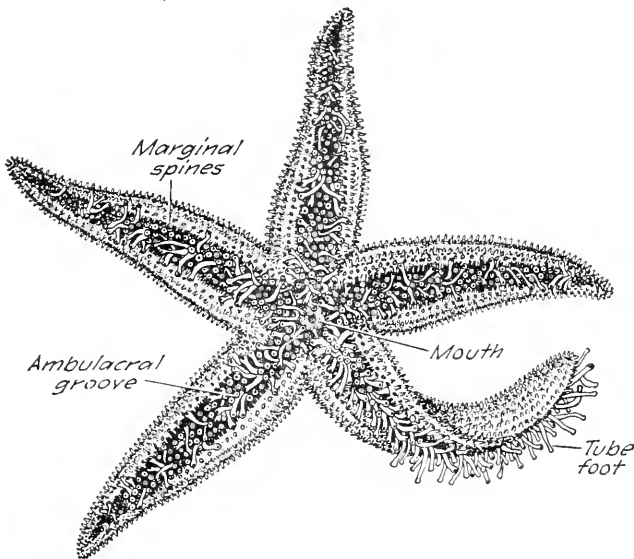

FIG. 102.—Oral surface of a starfish, *Asterias vulgaris* Verrill. From a preserved specimen in which the water-vascular system had been injected before preservation so that the tube feet are extended. One ray turned as if the animal were beginning an effort to turn over. $\times 1\frac{1}{2}$.

tions, the lines running from the center of the disc to the tips of the rays being *radii*, and those running from the same point to the apices of the angles between the rays being *interradii*. On one of these interradii and sharply distinguished by its smooth appearance is a little circular area which is called the *madreporite*. In some cases it is possible to distinguish a very minute anal opening close to the center of the disc.

On the lower or oral surface (Fig. 102), and in the center of the disc, is the *mouth*, which is surrounded by a soft membrane, the *perioral membrane*, or *peristome*, bounded on the outside by a ring of calcareous plates or ossicles. From this ring an *ambulacral groove* (Fig. 103 A) runs out the middle of each ray to the tip, the width of this groove being less than the width of the ray but leaving only a relatively narrow strip along each side. The margin of this groove is furnished with longer

spines, known as *marginal spines*. These project more or less over the groove, which is nearly filled with tube feet.

223. Skeleton and Musculature.—The skeleton of the starfish consists of a large number of calcareous *ossicles* bound together by connective tissue. These ossicles are regularly arranged about the mouth and in the ambulacral groove, where they form flat plates lying vertically

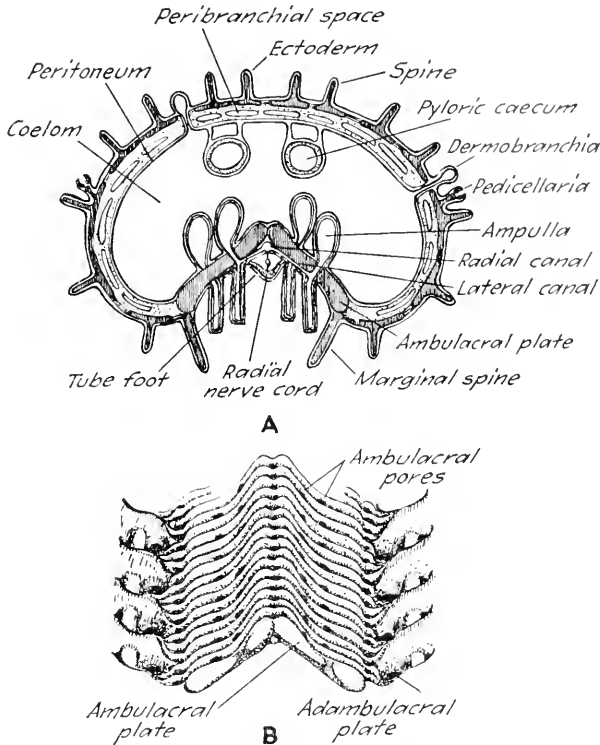

FIG. 103.—Ray of a starfish. A, diagrammatic cross section to show especially the arrangement of the ambulacral plates and the tube feet. B, ambulacral and adambulacral plates of a dried and cleaned specimen, showing the pores for the tube feet. $\times 3$.

face to face on either side of the mid-ambulacral line and nearly at right angles to it (Fig. 103 B). The plates in the ambulacral groove are also inclined, so as to give the groove the form of a trough when looked at from below. These ossicles, the fibrous tissue between them, and the spines, as well as the pedicellariae, are covered with a soft epidermis.

The rays of the starfish are not rigid but may be moved about by muscle fibers in the body wall. There are also longitudinal and transverse muscle fibers in the ambulacral groove which make it possible for the rays to be bent toward the aboral side and for the ambulacral groove to be closed by the drawing inward of the margins.

224. Water-vascular System.—The *water-vascular* system, which is peculiar to the echinoderms, is a system of canals filled with water, which serves as a locomotor system (Fig. 104). The madreporite on the aboral surface, when examined closely, is seen to be marked by fine radiating grooves along which are numerous minute openings, making of the whole plate a sieve. Through this water enters the system and is strained as it does so. From the madreporite a *stone canal*, so called because of lime in its walls, runs downward across the body cavity to a *ring canal*

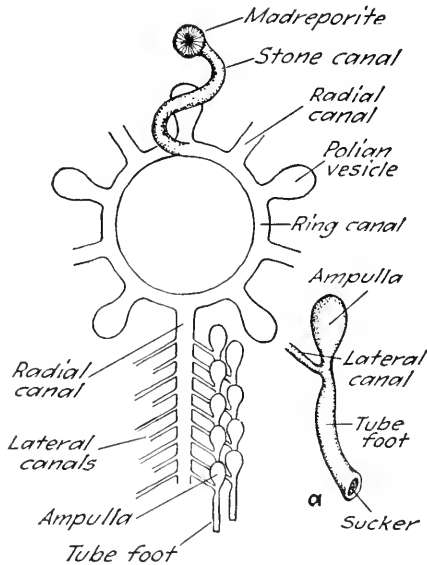

FIG. 104.—Diagram to illustrate the arrangement of parts in the water-vascular system. *a*, tube foot and ampulla, enlarged.

which lies at the outer margin of the perioral membrane. In the stone canal just below the madreporite, as well as on the inner surface of the madreporite itself, are cilia, the movement of which forces water into the canal. From the ring canal a *radial canal* runs out each ray, lying at the bottom of the ambulacral groove. From this radial canal arise *lateral canals* which lead to the tubes connecting the ampullae and the tube feet. The *ampullae* are sacs lying inside the wall of the ray; the *tube feet* lie outside it and in the ambulacral groove. The tube which connects each ampulla with its tube foot runs through an ambulacral pore (Fig. 103 A), formed by the separation of adjacent ossicles. These

pores are in two rows on each side corresponding to the two rows of tube feet and the lateral canals are thus alternately longer and shorter. In the walls of the ampullae are circularly arranged muscle fibers which by their constriction, working on the principle of a bulb syringe, lessen the capacity of these ampullae. The tube feet are hollow organs cylindrical in form, in many cases with a sucker at the outer end, working on the principle of a vacuum cup. The lateral walls of these organs contain muscle fibers.

The manner in which locomotion is accomplished is as follows: When the animal is about to move in a given direction, the ray—or rays—pointing in that direction is raised and the tube feet are elongated as water is forced into them by the contraction of the ampullae. When these tube feet have been extended as far as possible, which in a starfish a foot in diameter may be as much as two inches, their outer ends are brought in close apposition to the object upon which the starfish is resting and the

suckers take hold firmly. The muscles of the tube feet now begin to contract, forcing the water out of them and back into the ampullae. As these tube feet shorten, those in other parts of the body relax their hold and the animal is drawn forward by just the length of the contracting tube feet. Now the tube feet in the other parts of the body again take hold, after which the ampullae of the anterior rays are once more brought into play. Water is forced into the tube feet which are in advance, causing them automatically to release their hold and allowing them to be again extended and attached in a new place. Thus the animal literally pulls itself along a tube foot's length each time a tube foot acts. But since all the tube feet do not act in unison, progression is a steady forward movement.

225. Internal Organs.—The starfish has a true *coelom*, which is very large and reaches to every part of the body. The space in the water-vascular system represents a portion of the coelom cut off from the

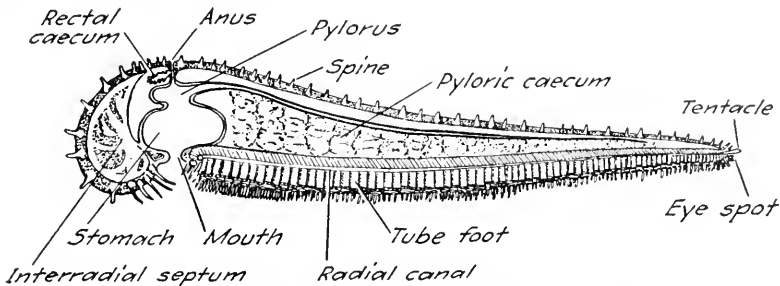

FIG. 105.—Section of a starfish along one radius and the opposite interradius. The parts in the median line of the ambulacral groove are not shown.

rest. The coelom is everywhere lined with a *peritoneum*, or lining membrane, and is filled with coelomic fluid.

The digestive system of the starfish is an *alimentary canal* (Fig. 105), shortened by the flattening of the body and considerably modified. It is divided into a very short esophagus, a large thin-walled stomach, a pyloric sac, and a very slender rectum ending at the anal opening, which is small and non-functional. The pyloric sac is extended outward opposite the axis of each ray, and into each extension opens a pair of complexly branched *pyloric*, or *hepatic*, *caeca*. These caeca nearly fill each ray. Pouches connected with the rectum are known as *rectal caeca*. The number of these varies in different species. The stomach seems to secrete only mucus, but the pyloric sac, as well as the glands in the pyloric caeca, forms digestive enzymes which act on proteins, fats, and carbohydrates.

Starfishes are *dieocious*. The ovaries and testes are much branched organs lying at the bases of the rays, one on each side of each interradius. The sex cells are passed out through a number of ducts which open on each interradial plate.

226. Feeding and Metabolism.—As the starfish moves about over a surface it secures animals which are unable to run away, such as oysters, mussels, barnacles, clams, snails, and tube-dwelling worms, or those which are surprised and captured before they can escape, such as crustaceans and even small fish. When an object is captured which can be passed through the mouth into the stomach, this is done and digestion takes place within the body, after which the indigestible part is thrown out through the mouth. If, however, a starfish finds itself over such an animal as an oyster or mussel, which is firmly attached and protected by a shell, it has recourse to a novel mode of circumventing its prey. Tube feet are attached to the two valves of the shell and then a steady pull is exerted which tends to draw the valves apart. This pull may be resisted by the mollusk for some time, but sooner or later the muscles of the victim relax. The stomach of the starfish is then everted through the mouth and immediately inserted into the crack between the two valves. Though the mollusk may for a time again attempt to close this crack, the starfish ultimately succeeds in inserting enough of its stomach so that it can be wrapped about the body of the mollusk, which is then digested within its own shell. When digestion is complete the starfish draws the stomach back into its body by means of retractor muscles and moves on to find other prey. It is stated by MacBride that if the mollusk is not firmly attached, the starfish will pick it up between its rays; on one occasion a starfish which was confined was observed to walk about all day carrying with it a mussel which it was unable to open.

When the food is digested it is absorbed through the walls of the alimentary canal into the coelom and is thus distributed to all parts of the body. Elimination probably takes place in part through the rectal caeca but also in another and very curious manner. Ameboid cells, known as *amebocytes*, lying in the coelomic fluid, pick up particles of waste and make their way out through the walls of the *dermobranchiae*—literally, skin gills—thus getting outside the body with the waste, not again to return. These dermobranchiae (Fig. 103 A) are pouches of peritoneum filled with coelomic fluid and may be projected outward through thin places in the wall of the body, pushing the epidermis in front of them. Their function is mainly respiratory. When the animal is exposed by the ebbing of the tide they are retracted within the body wall and remain so until the animal is again covered by the return of the tide. The effect of these dermobranchiae, when fully extended, is more or less completely to cover the surface of the body with a soft tissue through which one who touches the animal can feel the firmer wall of the body. The amebocytes are produced in structures attached to the ring canal of the water-vascular system, known as polian vesicles (Fig. 104) and Tiedemann's bodies.

227. Nervous System and Behavior.—The nervous system is less highly developed than in the phyla previously studied, there being no central ganglion. The system consists of a *nerve ring* encircling the perioral membrane, radial *nerve cords* lying at the bottoms of the ambulacral grooves and reaching to the tips of the rays, nerves on the dorsal surface of each ray which converge toward the center of the aboral disc, and scattered nerve cells and sense cells lying among the cells of the epidermis and distributed above the nerve cords. The principal sense organs are the *pigment spots*, one at the tip of each ray, below a so-called tentacle (Fig. 105). The pigment spots are light-perceiving and the

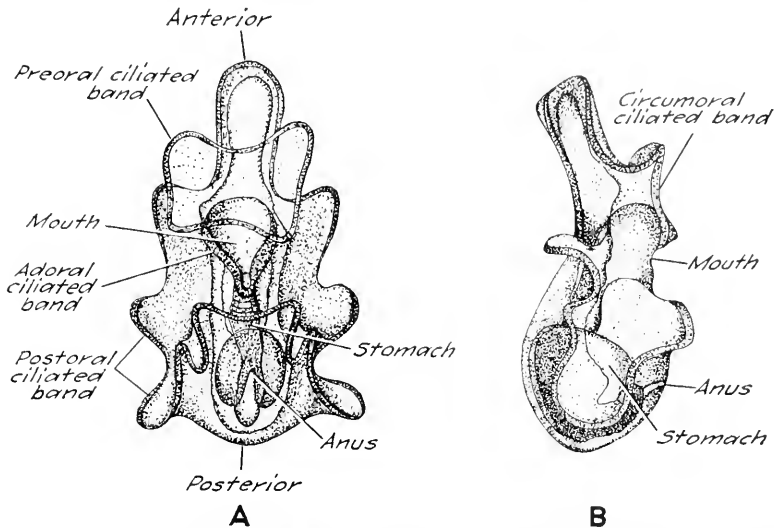

FIG. 106.—Bipinnaria larva of *Asterias vulgaris*. (From Field, in *Quar. Jour. Microsc. Sci.*, vol. 34.) A, ventral view of a larva five weeks old, to show the bilateral symmetry. The body bears a number of lobes, and two bands of cilia, one preoral, the other postoral. The latter is not visible where it passes over upon the dorsal surface, but actually is a continuous band. The internal organs are seen through the partly transparent body. $\times 52$. B, lateral view of a three-weeks-old larva, enlarged to the same size as A. $\times 63$. Because of the difference in age there is lack of agreement in certain details, but it is hoped the two views will enable the reader to visualize the larva.

tentacles tactile organs. The tube feet and the pedicellariae are very sensitive to touch.

Starfishes as a rule are not very active in the daytime, but at night they move about in search of food. They respond to such stimuli as contact, light, temperature, and chemicals. Jennings carried out some experiments which indicated the ability of a starfish to form a habit. When a starfish is placed upon its aboral surface it draws two or three of its rays back under its body, attaches the tube feet to the substratum, and turns itself over. In most starfishes there is a tendency regularly to use certain rays, and these were determined for those experimented upon. By restraining these rays, Jennings succeeded in developing in individuals

the use of others. One animal was trained in 180 lessons, ten on each of eighteen days, so to use certain rays; after an interval of seven days and when left to its own initiative it was still using them. This type of action acquired as a result of the repetition of an act is known as a *habit*.

228. Reproduction.—Both sperm cells and egg cells are set free in the water, where fertilization takes place. The eggs undergo total and equal cleavage, after which follows a typical embryogeny, including the development of a hollow blastula, a gastrula formed by invagination, and a triploblastic embryo. A larva known as a *bipinnaria* (Fig. 106)

is produced which is bilaterally symmetrical but which gradually metamorphoses into the radially symmetrical adult.

229. Regeneration and Autotomy.—The starfish has a considerable power of regeneration. If the disc is deprived of all its rays it will regenerate them all, and a single ray with only a portion of the disc will regenerate the whole animal (Fig. 107).

The starfish also possesses the power of *autotomy*. Ordinarily the part dropped off is regenerated. This ability serves as a safeguard to the animal which, if it finds itself caught by one or more rays, can simply drop them off and make its escape.

230. Economic Importance.—Starfishes are of economic importance only as they are enemies of oyster fishermen or as they destroy clams and other marine animals which serve as human food. Oysters live

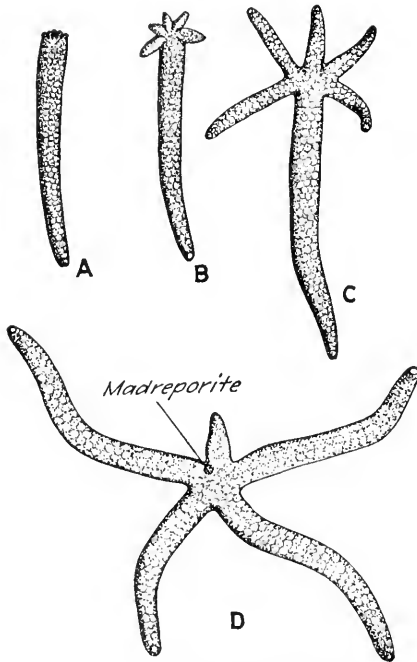

FIG. 107.—*Linckia guildingii* Gray, one of a group of starfishes noted for their regenerative ability. A to C, three specimens showing regeneration of the whole animal from one ray. In such a case five arms are regenerated making six altogether, five being the normal number. When the disk is uninjured only the rays lost are regenerated, as in D. Natural size.

adherent to solid objects lying upon the bottom of the sea in areas known as oyster beds. Starfishes come upon these oyster beds and destroy the oysters in the manner already described (Sec. 226). Owners of oyster beds formerly were in the habit of using drags made of frayed rope ends which they hauled over the beds behind a vessel and in which the starfishes became entangled. The drag with its starfishes was then hauled upon the deck. The starfishes were chopped to pieces and thrown back into the water, but since the pieces were capable of regeneration this

simply multiplied the number of animals. It is now the practice to carry them to shore and deposit them above high water mark where they are left to die. They may then be used as a fertilizer. The amount of damage done by starfishes may be considerable if they are not actively combated. A single one placed in a dish containing some clams of good size was observed to devour over 50 of these in six days.

CHAPTER XXXVI

PHYLUM ECHINODERMATA

Echinoderms are sharply distinguished from all other animals by several characteristics. One of these is a secondary radial symmetry which does not entirely mask a primitive bilateral condition. If a line is drawn through the interradius of a starfish on which the madreporite lies and is continued along the radius of the opposite ray, the animal will be seen to be divided into two similar halves. The two rays adjacent to the madreporite have been called the *bivium* and the three nonadjacent rays the *trivium*. Other characteristics show retrogression, and still others specialization.

231. Retrogression.—Retrogression may be defined as the possession by an animal of a lower grade of organization than that which has been attained by its ancestors—in other words, the animal has gone backward in its development. This is not to be confused with *degeneration*, which is simply the loss of characteristics. The cestodes, for instance, show a loss of the alimentary canal due to degeneration. The echinoderms also show a change in the alimentary canal, but instead of disappearing it tends to return to a condition seen in animals with a gastrovascular cavity. Retrogression should not be confused, on the other hand, with the simplicity which belongs to animals lower in the evolutionary scale. This mistake was for a long time made by zoologists in grouping echinoderms with the coelenterates under the term Radiata, because they were seen to possess radial symmetry. Evidences of the fact that echinoderms are much higher in the scale of animal life than are coelenterates are seen not only in many details of the adult structure but also in the fact that the larvae show indications of an advanced condition.

It is this evidence from the larva which leads to the view that echinoderms illustrate *retrogression*, which is shown in the following ways: (1) The larva shows bilateral symmetry, while the adult exhibits a secondary radial symmetry; (2) the former possesses an alimentary canal, but in starfishes the anal opening nearly or quite disappears and the enteron structurally and functionally tends to return to the condition of a gastrovascular cavity; (3) the nervous system in the larva promises a development higher than any type studied up to this time, but in the adult it acquires a character not greatly in advance of the coelenterates, possessing little evidence of centralization.

232. Specializations.—Specialization or adaptation is the development of structures which fit an animal to perform certain particular functions or to meet certain peculiar conditions in the environment. The echinoderms show some of the most marked examples of *specialization* to be found anywhere in the animal kingdom. Among these are (1) the entire water-vascular system, (2) the spines and plates which form the exoskeleton, (3) the pedicellariae, (4) the dermobranchiae, and (5) the amebocytes.

233. Classification.—The phylum Echinodermata (ē kī nō dēr' mā tā; G., *echinos*, hedgehog, and *dermatos*, pertaining to skin) is divided into five classes:

1. *Asteroidea* (ās tēr oi' dē ā; G., *aster*, star, and *eidos*, form).—The starfishes.

2. *Ophiuroidea* (ō fī ū roi' dē ā; G., *ophis*, serpent, *oura*, tail, and *eidos*, form).—The brittle stars and serpent stars.

3. *Echinoidea* (ēk ī noi' dē ā; G., *echinos*, hedgehog, and *eidos*, form).—The sea urchins and sand dollars.

4. *Holothurioidea* (hōl ō thū rī oi' dē ā; G., *holothourion*, water polyp, and *eidos*, form).—The sea cucumbers.

5. *Crinoidea* (krī noi' dē ā; G., *krinon*, lily, and *eidos*, form).—The feather stars and sea lilies.

234. Asteroidea.—The general characteristics of this class are illustrated by the starfish. The bases of the rays take up the entire circumference of the disc and thus are not definitely marked off from it. The number of rays varies in different species from 5, which is the most usual number, to more than 40. Though usually an odd number, it is not invariably such, since there are forms in which the number is regularly six. In some the disc is small and the rays are long and slender; in others the disc is large and the rays short and broad. This shortening and broadening of the rays may go so far as to produce pentagonal types. Starfishes are rather generally distributed, being absent only from the polar regions.

235. Ophiuroidea.—This class differs from the preceding in that it possesses slender rays sharply marked off from the disc and in that the rays have no ambulacral grooves. Owing to the slenderness of the rays none of the viscera extends into them and they are exceedingly flexible and capable of very rapid movement. A madreporite is found on the ventral surface, but tube feet, if found at all, exist only on the ventral surface of the disc, adjacent to the mouth, where they serve as tactile organs and pass the food into the mouth opening (Fig. 108). The types known as brittle stars and serpent stars are found under stones on the beach at low tide. When the tide is in they wander more or less about the bottom, having somewhat the same feeding habits as the starfishes, but cannot eat objects of any considerable size. Brittle stars are capable

of rapid locomotion, but serpent stars are even more active, the rays writhing about like the tails of so many snakes when the animal is strongly

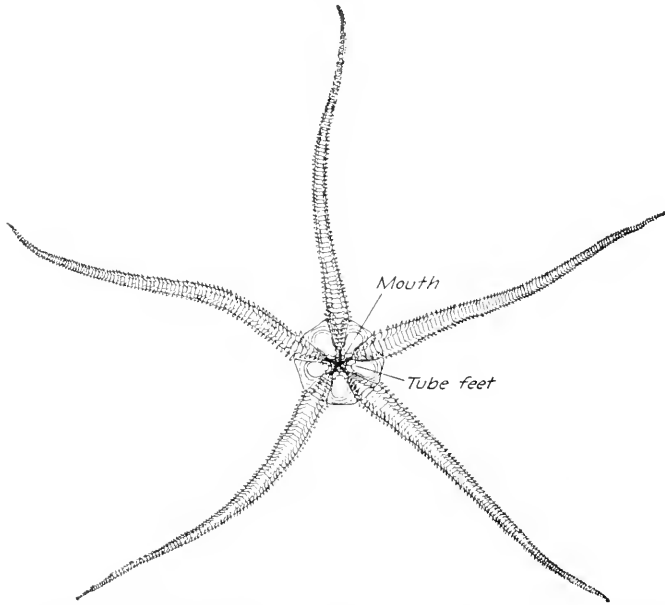

FIG. 108.—A brittle star, *Ophioderma* sp. The oral surface. From a preserved specimen. $\times 1\frac{1}{2}$.

stimulated. The basket stars are characterized by complexly branched rays ending in tendril-like tips. They are found mostly in water of considerable depth, clinging to masses of seaweed. Owing to the slenderness of the rays of ophiuroids, they are more likely to be broken than are those of ordinary starfishes. Autotomy is also more frequent, while regeneration is relatively rapid and complete.

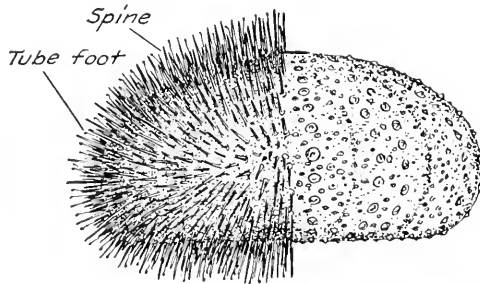

FIG. 109.—A sea urchin, *Strongylocentrotus dröbachiensis* (Müller). From a preserved specimen. The spines have been stripped from the right half; they and the tube feet show on the left. $\times 3\frac{1}{4}$.

236. Echinoidea.—Echinoidea, or sea urchins (Fig. 109), are animals which have lost their rays and possess a skeleton made up of rows

of plates running from the oral to the aboral surface. These plates are divided into five pairs of *ambulacral* rows, between which are an equal number of pairs of *interambulacral* rows. The ambulacral rows are perforated for the exit of tube feet and correspond to those in the ambulacral groove of the starfish, while the interambulacral rows would correspond to the interradial plates of the starfish (Fig. 110). One may conceive of a starfish being transformed into a sea urchin by an increase in the vertical diameter of the body and a shortening of the rays until they disappear. With the disappearance of the rays the ambulacral bands run up around the side of the body and terminate near the aboral pole. The mouth of the starfish is simply an opening in the center of a soft perioral membrane; in the sea urchins, however, it is provided with five converging teeth. These are set in a complicated skeletal box, pentagonal in shape and known as an *Aristotle's lantern* (Fig. 111). This is made up of numerous ossicles, lies within the body, and contains muscles which move the teeth. The food of sea urchins consists of algae, which they remove from the surfaces of rocks with their teeth.

Respiration in sea urchins usually takes place by ten branched pouches arranged in a circle around the mouth. The tube feet are also said to be respiratory. The latter may be exceedingly long if the spines on the surface of the animal are long, since they reach beyond the spines. The tube feet are used both in locomotion and in holding to surrounding objects. In locomotion the spines are used to prevent the pull of the tube feet from rolling the animal over and also as levers to help pry the animal onward. The pedicellariae of sea urchins are on a stalk and usually have three jaws.

Sea urchins differ in the length and number of the spines. The cake urchins and sand dollars are exceedingly flat forms with numerous very

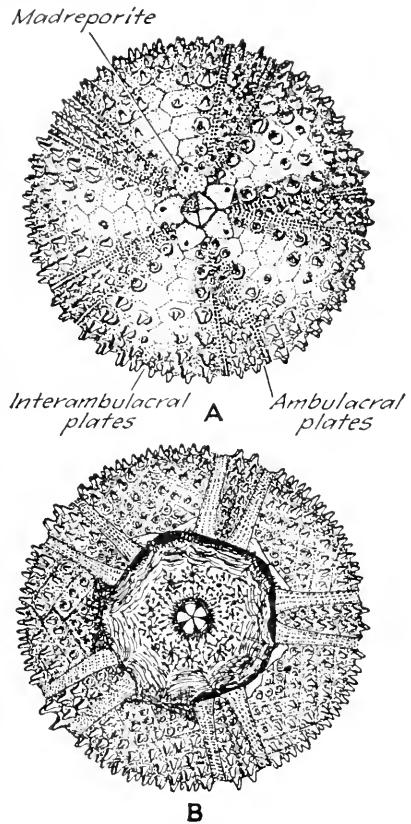

FIG. 110.—Dried shell of a sea urchin of the genus *Arbacia*. Shows the arrangement of plates. A, the aboral surface. B, the oral surface, with the perioral membrane torn loose for about two-thirds of its attachment. Dried pedicellariae are still attached to this membrane. Natural size.

small and short spines; they are found on sandy beaches, burying themselves just under the surface of the sand as the tide goes out but moving about on the sand after the tide has returned.

237. Holothurioidea.—The sea cucumbers, which make up this class, differ from other echinoderms in the fact that they are greatly elongated along the oral-aboral axis, the mouth being at one end and surrounded by branched tentacles, while the anal opening is at the opposite end of the body (Fig. 112). The body wall is muscular and possesses few and small calcareous plates. The madreporite is internal. Tube feet are present and serve as organs for clinging and for locomotion.

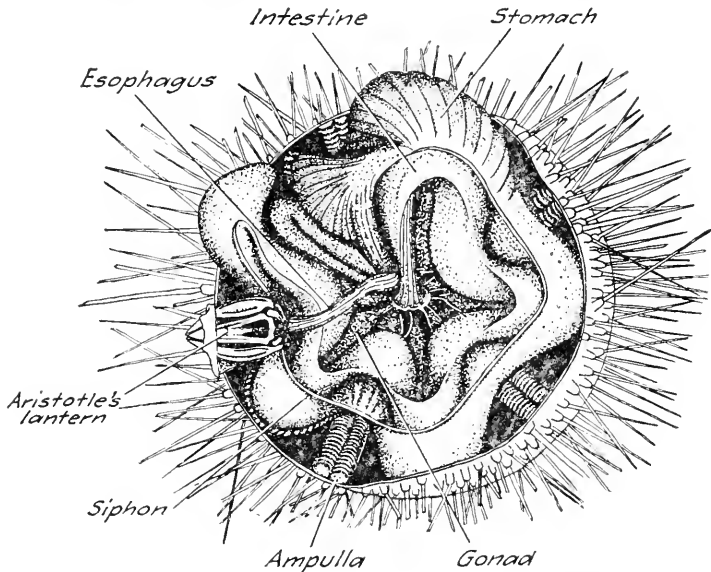

FIG. 111.—Internal structure of a sea urchin. (From Delage and Hérouard, "Traité de Zoologie Concrète," after Milne Edwards.) The oral wall of the shell has been removed and the contents of the body are viewed from the oral pole with the Aristotle's lantern and esophagus turned to the left.

One type of sea cucumber is represented by those which conceal themselves in the crevices between rocks and which have the tube feet all around the body in five double rows. Some of the tube feet adjacent to the mouth, as well as the tentacles, are used in procuring food. A cloaca is present in a typical sea cucumber and contains the openings of two long branched tubes, the *respiratory trees* (Fig. 113). Respiration occurs in these as well as through the cloacal wall and the walls of the tentacles and tube feet. The respiratory trees also serve as excretory organs. The madreporite takes water in from the coelomic cavity. Other sea cucumbers possess tube feet on only one side of the body and travel about on that side, looking like huge caterpillars. Still others burrow in the mud like earthworms and have no tube feet at all; they

seek their food at the surface of the mud and secure small living plants and animals by means of their tentacles. The last named are the most primitive of echinoderms.

The holothurians exhibit a remarkable form of *autotomy* and *regeneration*. When irritated the whole alimentary canal and the respiratory trees may be thrown out through the mouth, there being developed from

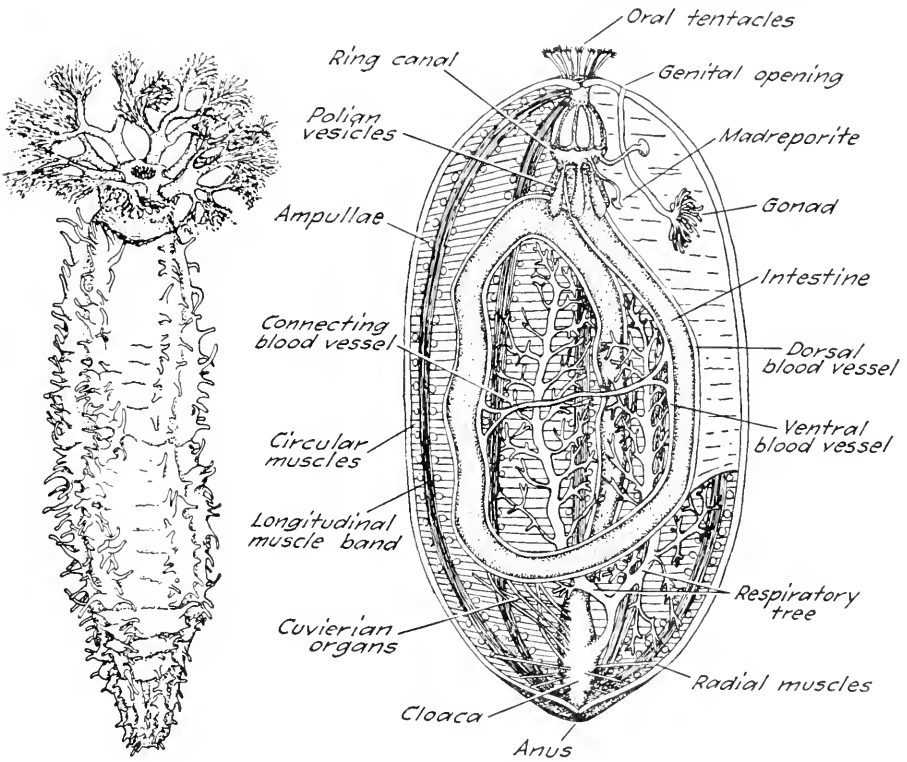

FIG. 112.

FIG. 113.

FIG. 112.—A sea cucumber, *Cucumaria planci* Brandt, from the Mediterranean. From a preserved specimen. $\times 2_3$.

FIG. 113.—Diagram of the internal anatomy of a sea cucumber, representing the animal laid open and the wall of the body turned to each side.

the lower branches of the latter a mass of white tough threads in which a possible enemy may become entangled. These structures, however, are soon regenerated.

238. Crinoidea.—The sea lilies, which were exceedingly abundant in the seas ages ago, are echinoderms which, typically, are attached by the aboral surface to a stalk that rises from the bottom and frequently possesses many rootlike branches (Fig. 114). The oral surface is uppermost and the disc is surrounded by more or less complexly branched rays bearing smaller pinnules arranged like the barbs on a feather. The

tube feet are tentacle-like and without ampullae. Crinoids are found mostly at moderate depths, but a few belong to the deep-sea fauna. They may be free-swimming, when they are known as feather stars (Fig. 115).

239. Reproduction.—The reproduction of all echinoderms is similar to that of the starfish. They all develop a bilaterally symmetrical swimming larva, and all undergo metamorphosis. The larvae of the different classes resemble each other in a general way, but each is quite distinct. That of a starfish is known as a bipinnaria or brachiolaria, that of a brittle star as an ophiopluteus, that of a sea urchin as an echinopluteus, and that of a sea cucumber as an auricularia.

240. Behavior.—In the echinoderms the nervous system does not seem to control the muscles as does a centralized system in other animals but simply maintains a certain *tonus*, a condition accompanied by readiness to respond to stimuli. The response itself is, generally speaking, direct. Pedicellariae react to the presence of an object in contact with the skin near them by seizing it in their jaws and either holding it or so moving as to carry it away from the point of contact. In this way they serve to keep the surface clean, especially over the dermibranchiae. A strong stimulus results in locomotor impulses being carried to the tube feet through the nervous system, which in this way functions in coordination. Habit formation has been referred to in the preceding chapter.

241. Color.—The echinoderms when living are very strikingly colored, but color may mean nothing in the discrimination of species, some forms quite regularly exhibiting a particular color but others showing marked variations. Almost all colors are represented in the group, various shades of red and orange being common. There are also varying tints from cream to almost white, and innumerable shades of buff, brown, green, blue, and purple, some being almost black. When a group of sea cucumbers are seen on the bottom with their tentacles spread and possessing varied and brilliant hues, they appear as striking as a bed of variously colored flowers.

242. Occurrence and Economic Importance.—Because of the possession of skeletons by echinoderms their parts have been preserved in abun-

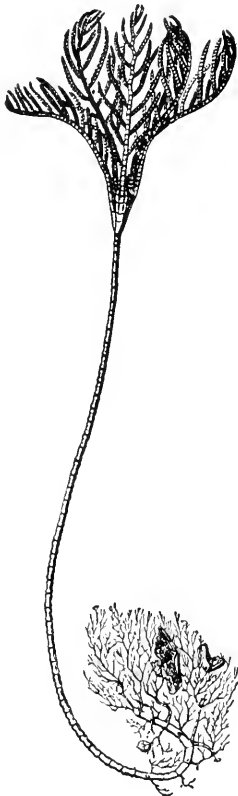

FIG. 114.—*Rhizocrinus lofotensis* Sars. (From Bather, in Lankester's "A Treatise on Zoology," after Wyville Thomson, by the courtesy of A. and C. Black.) $\times 4^{1/2}$.

dance in rocks from very early times, and many limestone strata are filled with such fossils. Among these are spines and plates, sections of the stems of crinoids, and in some cases the crinoid body, very nearly perfect. At the present time echinoderms are widely distributed and abundant in all seas. The phylum is one of the few which has always been exclusively marine.

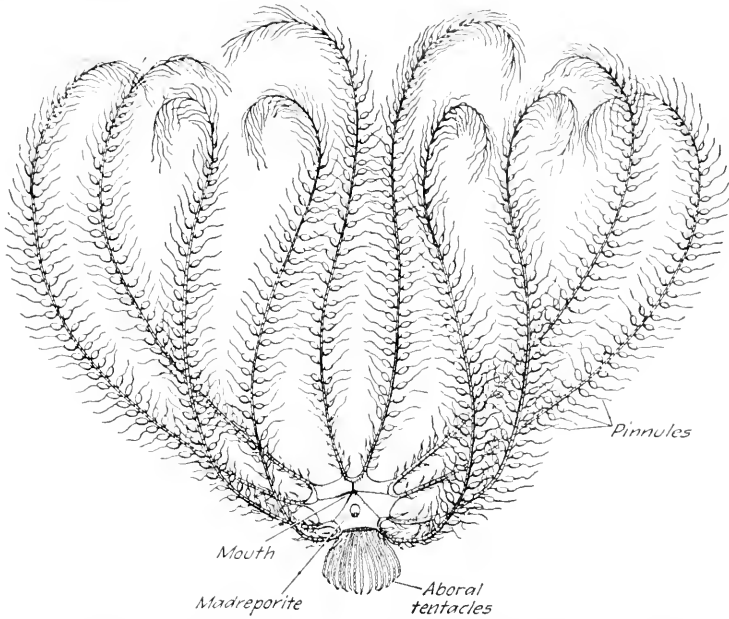

FIG. 115.—A feather star, *Antedon* sp. From a preserved specimen. Natural size. The animal is in a breeding condition as shown by the dilatation of the base of the pinnules.

Of this phylum only starfishes and sea cucumbers are of much economic importance. As has been previously indicated, the starfishes are enemies of the oyster. Sea cucumbers are used as food among the islands and along the shores of the South Pacific Ocean and in China, the animals being dried and passing as articles of commerce under the names of *bêche-de-mer* and *trepang*.

CHAPTER XXXVII

FRESH-WATER MUSSEL

A TYPE OF THE PHYLUM MOLLUSCA

Fresh-water mussels are found in ponds, lakes, or streams. In ponds or lakes, where the water is quiet, they lie nearly buried in the mud at the bottom, moving about from time to time and leaving a furrow to mark the path which they have followed. In running streams they are found most abundantly where the water runs rapidly and where plenty of food is brought to them. In such locations they are sedentary, remaining wedged in between the stones and protected from the force of the current

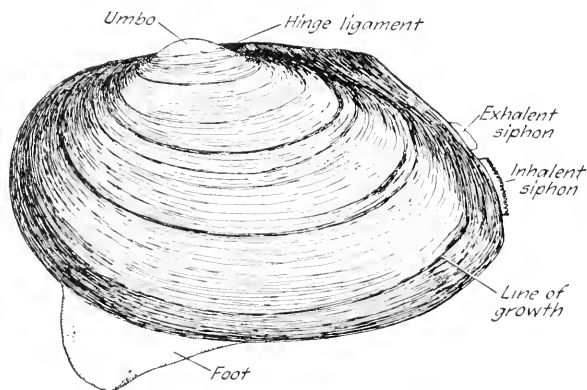

FIG. 116.—*Anodonta grandis* Say. From a preserved specimen from Nebraska. $\times \frac{1}{2}$. A typical fresh-water mussel. The lines of growth are numerous but only the most pronounced are annual lines. This specimen was probably in its sixth year.

which would otherwise sweep them down into quiet pools where they might be buried in the mud. Because of this danger of being buried by the deposition of mud they are not often found in the broad, deep estuaries of such a river as the Mississippi or in wide, shallow rivers which carry large amounts of sand and detritus, such as the Missouri, the Platte, and the Kansas.

243. External Appearance.—A typical mussel is oval when viewed from the side, the anterior end being rounded and the posterior pointed (Fig. 116). The thickness is greatest at a point above and behind the middle of the body and near the dorsal side; from this point it diminishes in all directions but more gradually toward the ventral side, the margin forming a sharp edge anteriorly, posteriorly, and ventrally. A cross section has the outline of a conventional heart (Fig. 118). The animal is

covered by a bivalve *shell*, the valves being lateral in position. When buried in the mud only a small part of the posterior end is left free, and at this point may be seen projecting from between the two valves the open ends of the *siphons*, by means of which water is circulated through the animal, the current entering through the ventral siphon and leaving through the dorsal one. When the animal is moving, a muscular *foot* is projected ventrally and anteriorly between the two valves. This foot ends in a blunt point where its anterior and ventral margins meet, and this point is capable of being extended to form a sort of hook by means of which the animal pulls itself along.

244. Shell.—The two valves of the shell are fastened together along the dorsal side by a *hinge ligament* which is elastic and which tends to

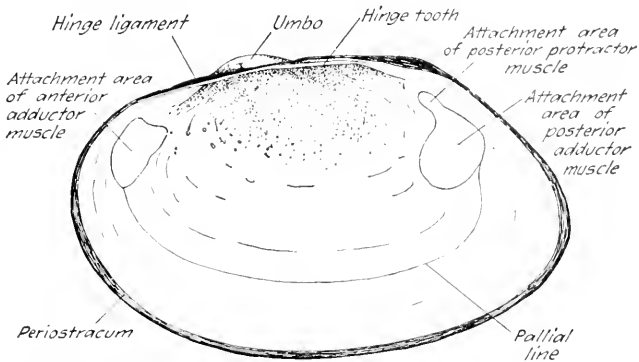

FIG. 117.—*Anodonta grandis* Say. Showing inner surface of a left-hand valve. $\times \frac{1}{2}$.

draw the valves together dorsally and to cause them to gape ventrally. Close to this ligament, on either side and nearer the anterior than the posterior end, is a point known as the *umbo*, which represents the oldest portion of the shell. On the outer surface of the shell (Fig. 116) may be seen a great number of concentric lines arranged around the umbo as a center and gradually increasing in distance from the umbo until the margin of the shell is reached. They represent *lines of growth*, several of which may be formed during one year, though the annual lines are somewhat more prominent than the intermediate ones. In older animals the shell at the umbo is very often eroded. Elsewhere it is covered by a skin-like horny layer called the *periostracum*, which gives color to the shell. The periostracum extends a little way beyond the margin of the shell except at the hinge ligament.

The inner surface of each valve (Fig. 117) often possesses elongated sharp ridges and toothlike projections which hold the valves from slipping out of position. These are known as *hinge teeth*. They vary greatly in degree of development in different types and may be absent. There are roughened areas serving for the attachment of the anterior and posterior *adductor muscles*, which run from one valve to the other and hold the two

together. A little way from the ventral margin and parallel to it is seen a small groove, known as the *pallial line*, which marks the attachment of the muscle layer of the mantle, or pallium.

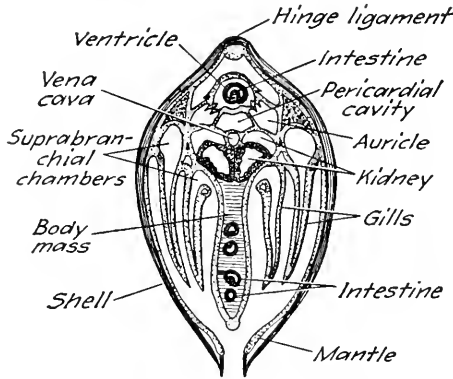

FIG. 118.—Diagrammatic cross section of a fresh-water mussel. (From Parker and Haswell, "Text-Book of Zoology," after Howes, by the courtesy of The Macmillan Company.)

When viewed in cross section the shell is seen to exhibit several layers: (1) a horny layer or *periostracum*, sometimes called the epidermis; (2)

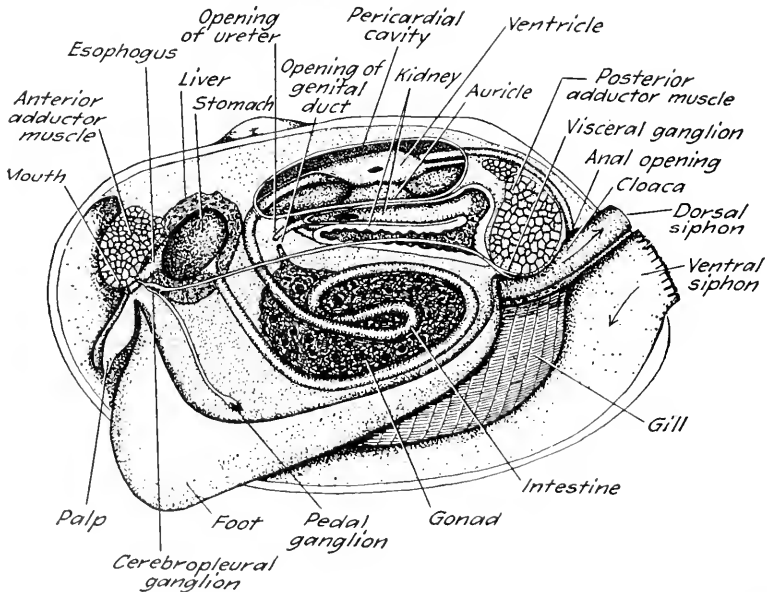

FIG. 119.—Diagram of the internal anatomy of a fresh-water mussel. (Compiled from various sources.) The mantle and gills on the near side are not shown, and the body is indicated as having had a part of the wall cut away. The stomach, liver, gonad, pericardium, and kidney are shown in section.

a series of layers of carbonate of lime, together known as the *prismatic layer*; (3) a layer of *nacre* or mother-of-pearl, also carbonate of lime,

made up of many thin lamellae. The naere is thickest at the hinge ligament and becomes gradually thinner toward the margin. The shell is constantly being added to at the margin and thus increased in surface area, and at the same time it is constantly increasing in thickness by deposition from within.

245. Internal Anatomy.—Inclosed in the shell is an animal which is very soft and which when removed from the shell becomes to a considerable degree shapeless. It may be described as made up of a body mass and foot, a mantle, and two pairs of gills (Fig. 118). The relation of mantle and gills to the body mass is similar to that which a man's clothes would have to his body if his coat, corresponding to the mantle, were grown to his back, and he had on two vests, unbuttoned in front and attached to the sides of his body, corresponding to the gills.

246. Body Mass and Foot.—The *body mass*, or visceral mass, is a soft mass filling the upper part of the space between the two valves and is continuous externally with the mantle. Ventrally it becomes narrowed and hangs down in the mantle cavity (Fig. 118), its ventral muscular margin forming the foot. In this body mass are contained various organs, including those of the digestive, circulatory, excretory, and reproductive systems (Fig. 119).

247. Mantle.—The *mantle* lines the inner surfaces of the valves of the shell but it extends a short distance beyond their edges and forms, with the periostracum, a soft margin. This mantle secretes the carbonate of lime which is continually added to the edge of the shell and to its inner surface. The space inclosed by the two halves of the mantle is known as the *mantle cavity*.

248. Gills.—The *gills*, which with the mantle carry on respiration, are platelike and are in pairs on each side of the body mass, to which they are attached. Each gill is composed of two *lamellae* joined all around the margin and also connected by a number of cross partitions known as *interlamellar junctions*, which divide the inclosed space into a large number of compartments known as *water tubes*. Each lamella is a sort of mesh-work made up of vertical ridges, known as *gill filaments*, connected by horizontal bars. Some of these meshes possess openings which permit water to pass through into the water tubes. The gill filaments are strengthened by chitinous rods. The water tubes open above each gill into a passageway known as a *suprabranchial chamber*. The base of the inner lamella of the inner gill is attached to the body mass from the anterior margin backward for a distance which varies in different types of mussels. The attachment is short in those known as anodontas and long in unios. Where the lamella is free there is left a narrow slitlike passage which leads from the mantle cavity directly into the inner suprabranchial chamber on each side. Since these two inner lamellae meet behind the body mass and continue onward posteriorly, the two inner

suprabranchial chambers unite, and the passage between the two inner plates of the inner gills and the body mass is really narrowly U-shaped, inclosing the body mass behind. The outer suprabranchial chambers enter the chamber formed by the union of the inner suprabranchial chambers and in the wall of the common passage is the anal opening. From the anus onward the passage may be called a cloaca; it opens to the outside through the dorsal siphon. The water which enters through the ventral siphon fills the mantle cavity (Fig. 120), bathes the gills, enters the water tubes, passes up them to the suprabranchial chambers, and by means of the cloaca and dorsal siphon escapes from the body. A current is maintained by cilia which cover the walls of these passages.

249. Digestive System and Metabolism.—The *mouth* is an opening on the dorsal wall of the mantle cavity toward the anterior end. On

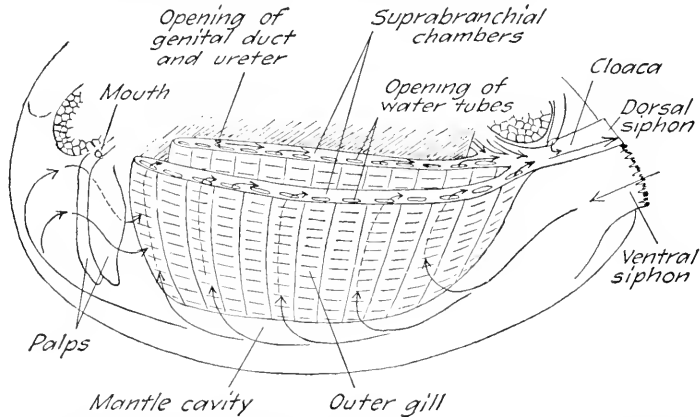

FIG. 120.—Diagram to illustrate the circulation of water through a fresh-water mussel. The suprabranchial chambers are shown as if cut open. The current is maintained by cilia on all the wall surface of the mantle cavity, aided by movements of the gills and labial palps. The labial palps also direct the food particles into the mouth.

each side of it is a pair of triangular *labial palps* (Fig. 119). Cilia on the surface of these palps help carry the food into the mouth. From the mouth a short *esophagus* leads to a broadly dilated *stomach*, which receives the secretion of the *liver*. From the stomach a narrow coiled *intestine* leads to the cloaca, through which the feces obtain exit from the body.

The food of fresh-water mussels is made up of particles of organic matter, including microscopic plants and animals, brought in through the ventral siphon. These food particles are strained out as the water passes through the gills and are carried toward the mouth by cilia, the labial palps collecting and directing them into the mouth opening.

250. Circulatory System.—The circulatory system includes a *heart* made up of a ventricle and two auricles. It lies in a *pericardial cavity* in the dorsal part of the body mass (Fig. 119), and a portion of the intestine passes through the ventricle. From the ventricle the blood is dis-

tributed over the body. It is collected again in a *vena cava* lying below the pericardium and is passed through the kidneys to the gills and back to the auricles.

251. Excretory System.—The organs of elimination are two U-shaped *kidneys* (Fig. 119) lying just below the pericardial cavity, one on each side of the *vena cava*. From each arises a thin-walled tube or *ureter* which opens on the lateral surface of the body mass toward the anterior end and at the level of the inner suprabranchial chamber. If the inner lamella of the inner gill is attached beyond the point where it opens, the opening is directly into that chamber.

252. Musculature.—The muscles include, among others, the adductors which serve to close the shell (Fig. 119) and the protractors and retractors which cause the protrusion and withdrawal of the foot.

253. Nervous System.—The central nervous system is represented by several centers, or ganglia, scattered throughout the body in pairs. Among these are the *cerebropleural ganglia* near the mouth, the *pedal ganglia* in the foot, and the *visceral ganglia* below the posterior adductor muscles (Fig. 119). The two cerebropleural ganglia are connected by a commissure and each one by connectives with the other two ganglia on the same side. From the ganglia nerves lead to various parts of the body. There are few sense organs. An organ of equilibrium lies in the foot a short distance posterior to the pedal ganglia and below them. It consists of a cavity known as a *statocyst*, containing a mass of lime called a *statolith*, the movement of which stimulates the sensory cells. On the surface over each visceral ganglion is a sheet of epithelial cells which appear to be sensory and form an organ known as an *osphradium*, the function of which is uncertain. It may be used in testing the water in the mantle cavity. Tactile cells are abundant on the edges of the siphons and along the margins of the mantle. The margins of the siphons also seem to be sensitive to light.

254. Behavior.—Since the unios move about but little and may even remain for a long period of time in exactly the same place, behavior is confined mostly to the opening and closing of the siphons, which are stimulated both by light and by contact. The stimulation of the *osphradium* by injurious substances dissolved in the water may cause the valves to close. The sense of equilibrium would function in enabling the animal to assume an upright position in case conditions forced it to take up a new location. The anodontas move about freely and when turned upon one side soon right themselves.

255. Reproduction.—In mussels the sexes are separate. The reproductive organs are situated in the body mass just above the foot, and the *vasa deferentia* in the male, or the *oviducts* in the female, open just in front of the opening of the *ureters*. The sperm cells when passed out through the *vas deferens* into the suprabranchial chamber escape from the

body through the dorsal siphon and are carried by the water to another individual. The egg cells do not leave the body but, owing to a reversal of the direction of motion of the cilia on the walls of the suprabranchial chambers, are carried into the gills and reach the marsupia. Here they are fertilized by sperm cells from another mussel, which have entered through the ventral siphon. A *marsupium* in this animal is a portion of a gill modified to serve as a place for the development of the eggs.

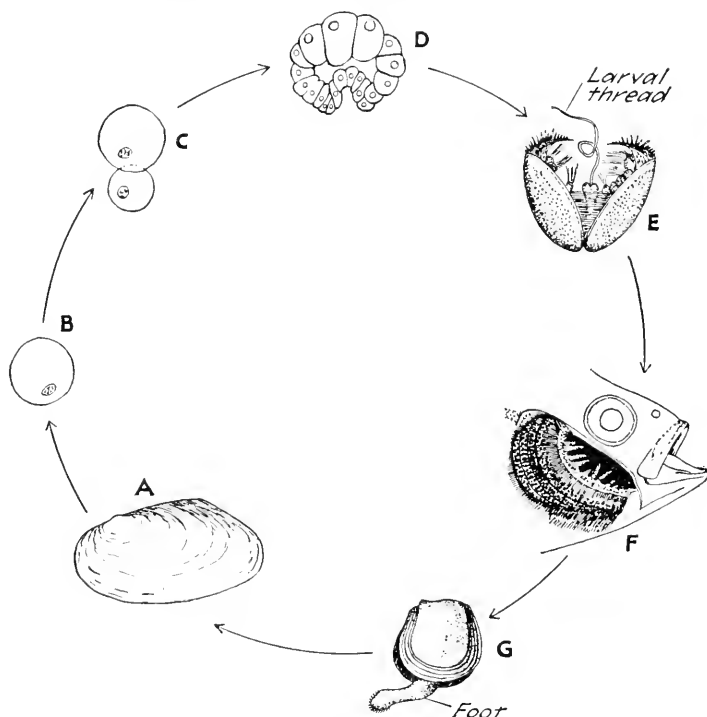

FIG. 121.—Diagram to illustrate the life history of a fresh-water mussel. *A* to *E* are of *Unio complanatus* (Dillwyn); *F* and *G*, of *Lampsilis ligamentina* (Lamarek). (*B* to *E* are from Lillie, *Journal of Morphology*, vol. 10, and *F* and *G* from Lefèvre and Curtis, *Bull. Bureau of Fisheries*, vol. 30.) *A*, the adult. \times about $1\frac{1}{4}$. *B*, the egg. \times 55. *C*, Two-cell stage, showing unequal cleavage. \times 55. *D*, section of the gastrula. \times 122. *E*, glochidium. \times 92. *F*, head of rock bass with operculum cut away to show glochidia attached to the gills. *G*, young mussel one week after leaving the fish. Much magnified. Several lines of growth have been formed.

The eggs undergo total and unequal cleavage. Blastula and gastrula stages are passed through, and a larval form known as a *glochidium* is developed (Fig. 121). This larva has a shell consisting of two valves closed by an adductor muscle. A long *larval thread* extends from the body of the larva between the gaping valves of the shell. It is, however, not present in all species. Fertilization usually occurs in a unio in spring or early summer, and by the middle of August or the first part of September the glochidia have become sufficiently mature to be freed from the

marsupium and to be carried out of the dorsal siphon by the currents of water flowing through the body. Since the unios usually live in running water, their glochidia are swept along by the current until they are carried into the mouths of fish with the water which the latter use in respiration. As they pass the gills of the fish they attach themselves to the gill filaments, clinging by the valves of the shell and also, perhaps, attached by the larval thread, which penetrates the tissues. The closure of the valves seems to be due to chemical stimulation by salts escaping from the tissues of the fish. On the gills of the fish the larvae live a parasitic existence

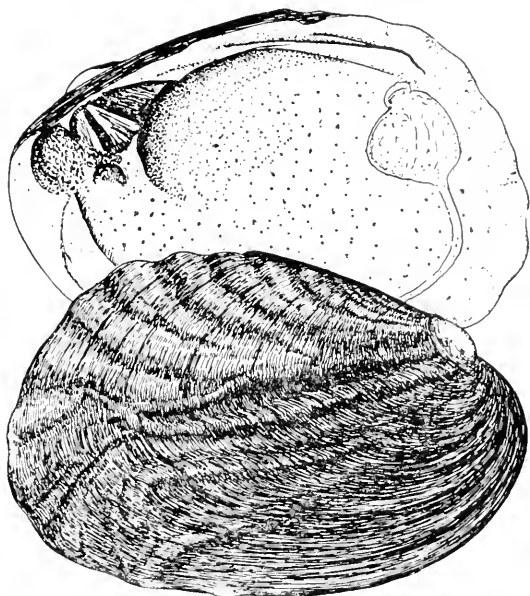

FIG. 122.—Shell of a unio, *Quadrula undulata* (Barnes). From the Grand River, Michigan. For comparison with the anodonta type, Figs. 116 and 117. This is one of the species most sought for button making. $\times \frac{2}{3}$.

until development is completed and they are ready to metamorphose into small adults. After this has occurred they escape from the fish, fall to the bottom, and begin an independent life.

256. Other Fresh-water Mussels.—A large number of species of mussels, belonging to several genera, may usually be found in any portion of this country. They differ markedly in size and shape and in the details of structure. They may be all grouped under two types—the stream type, known in a general way as *unios*, and the quiet-water type, known as *anodontas*. The former (Fig. 122), usually found in running water, are generally stationary, have thick shells with prominent hinge teeth, and the glochidia develop mostly in the gills of fishes, though they may also be attached to external surfaces. The anodonta type (Figs. 116 and 117), on the other hand, includes forms that live in still water, moving

freely about in search of food, have thin shells with the hinge teeth greatly reduced or absent, and the larvae develop on the fins, opercula, or margins of the mouths of fishes, as well as on the gills.

An anodonta living in quiet water and not subject to rough treatment needs neither a thick shell nor well-developed hinge teeth to safeguard itself against injury. Not being able to count upon its food being brought to it, it wanders freely, especially at night, in search of the food it needs, usually remaining quite stationary during the daytime. When the glochidia from these forms are released from the parent, they fall to the bottom and lie there until stimulated by the contact of some part of a fish coming to rest on the bottom or until carried into the mouth of a fish in its breathing. They then seize the surface of the fish thus presented and become attached by the teeth in the margin of the shell and by the larval thread in the same manner as do the glochidia of the unios. Here the closure of the valves seems to result from a contact stimulus. In anodontas the eggs are usually fertilized between the middle of July and the middle of August, and the glochidia are discharged the next spring or early summer. When these glochidia attach themselves to the surface of a fish, the skin of the fish grows around them and they become known as blackheads.

Not all unios occur in rapidly running streams, and when one lives under conditions described as proper for the anodontas it exhibits to a considerable degree both the structure and the habits of an anodonta, as well as a similar manner of reproduction. In a Minnesota lake, surrounded by sandy beaches, unios of the species *Lampsilis luteola* (Lamarck) have been observed to come in from the deeper water during quiet nights and to migrate freely about in the shallow water alongshore, returning to the deeper water with the coming of the dawn and leaving a tortuous furrow as evidence of their nocturnal wandering.

One result of the parasitic period in the life of the mussel is a far more rapid dispersal of the species than if that depended entirely upon the locomotor ability of the mussel itself or even upon the current, since transportation by fish permits the spreading of mussels from the lower portion of a stream toward its source.

CHAPTER XXXVIII

MOLLUSKS IN GENERAL

Mollusca is a phylum more numerous in known species than any other except Arthropoda. The mollusks are exceedingly varied in form and structure and represent a great difference in grade of organization between the lowest and highest. Indeed, the whole phylum may be considered as representing a long line of descent from wormlike ancestors. They have several features in common which distinguish them from all other animals. One of these is the presence of a mantle, which varies in form in different classes. Since the shell is secreted by the mantle, its form varies accordingly. The mantle cavity, which is the respiratory cavity, also varies in form and in the character of the respiratory organs contained in it. Another characteristic structure of mollusks is the ventral muscular foot, which is sometimes absent, as in the oyster. This foot is typically not an appendage, since in most cases it is merely a portion of the muscular wall of the body modified to form a smooth surface which serves in locomotion. In the Cephalopoda, however, the foot is modified in such a manner as to produce several long mobile tentacles provided with suckers, which are truly appendages.

257. Classification.—The phylum Mollusca (möl lüs' kâ; L., *molluscus*, soft) is divided into five classes according to the characters of foot, mantle, shell, and respiratory organs. The classes are as follows:

1. *Amphineura* (äm fī nū' rā; G., *amphi*, on both sides, and *neuron*, nerve).—The chitons.

2. *Gastropoda* (gäs tröp' ō dā; G., *gastros*, stomach, and *podos*, foot).—The snails.

3. *Scaphopoda* (skā föp' ō dā; G., *skaphe*, boat, and *podos*, foot).—The tusk shells.

4. *Pelecypoda* (pěl ē šip' ō dā; G., *pelekys*, hatchet, and *podos*, foot).—The bivalve mollusks.

5. *Cephalopoda* (sěf äł öp' ō dā; G., *kephale*, head, and *podos*, foot).—The squids, octopuses, and nautiluses.

258. Amphineura.—The Amphineura are clearly the most primitive of the mollusks, reminding one in some respects of the worms. They have a body which is flattened and elongated. In some of these forms there is no shell, but the dorsal surface is covered by a soft mantle containing many small limy spicules (Fig. 123 D). In this case the foot lies in a groove on the ventral surface. In other forms known as chitons

the mantle is more or less completely covered with a series of eight overlapping calcareous plates which together make up the shell (Fig. 123 A), and the broad flat foot occupies the greater part of the ventral surface. Between the margin of the foot and the edge of the mantle on each side is a row of marginal gill filaments (Fig. 123 B). The nervous system includes four longitudinal nerve cords, united in the chitons to an anterior nerve ring (Fig. 123 C) and in other types to cerebral ganglia. As a whole the system is distinctly wormlike.

The chitons are all marine and live firmly attached to rocks and other solid objects alongshore between tide marks and also just below the low tide mark. They move with great slowness and adhere so closely to rocks that they are torn loose only by the exercise of considerable

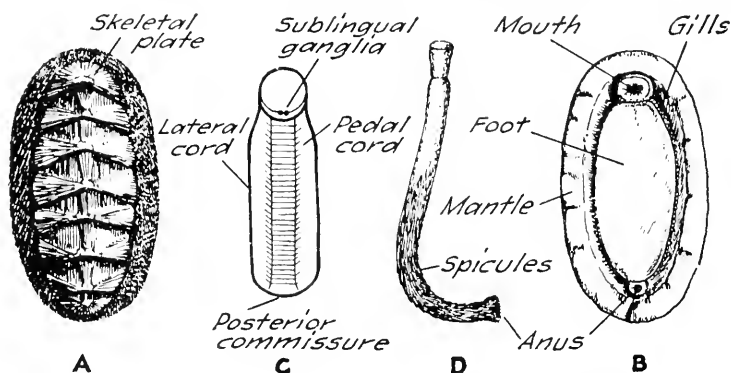

FIG. 123.—Amphineura. A, upper surface of a chiton, *Ischnochiton* sp. Natural size. B, lower surface of the same chiton. C, diagram of the nervous system of a chiton. (From Cooke, "Cambridge Natural History," after Hubrecht.) D, a primitive, wormlike species, *Chaetoderma nitidulum* Loven. (Also from Cooke, "Cambridge Natural History.") $\times 234$. Found in the North Atlantic Ocean at considerable depths. Possesses no foot, and has limy spicules in the skin. (C and D by the courtesy of The Macmillan Company.)

force. The more wormlike and shell-less forms are found on coral polyps and hydroids at depths of 50 fathoms or more.

259. Gastropoda.—The gastropods possess an elongated flat foot making up the entire ventral surface of the body except for a short portion at the anterior end. They also possess a well-developed head and may have a shell, which is often spirally coiled and therefore asymmetrical. This class includes a number of very distinct types.

The type which is most commonly thought of as representative is a snail with a spirally coiled shell. In such an animal the body consists of a head, a more or less distinct neck, a foot, and a visceral mass which is developed into a sort of hump on the dorsal side of the body. The head bears two pairs of fleshy *tentacles*, a relatively short pair anteriorly which are *olfactory* in function, and a longer pair posteriorly which bear the *eyes* at the tip (Fig. 124). These tentacles are hollow and capable of being inverted like the finger of a glove when the tip is pulled down inside.

When completely inverted the tentacles may not be seen at all, but as eversion takes place they become longer and longer until finally in the case of those bearing the eyes these appear like small beads at the tips. These eyes can perceive light but do not afford vision, as do those of the highest mollusks. The mouth contains a chitinous plate covered with teeth which is known as a *radula*. It serves as a grater and by a rasping action can remove the epidermis from leaves or a growth of algae from the surface of submerged objects.

The visceral mass bears a mantle which secretes a shell, but since this mass is not of sufficient consistency to hold the shell in a constant position in the median line, its weight carries it to one side. Growth is also faster toward the outside of the shell. Consequently, as the margin is extended by growth it tends constantly to change its direction of inclina-

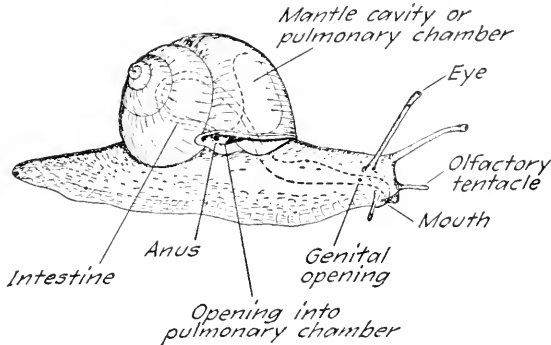

FIG. 124.—European edible snail, *Helix pomatia* Linnaeus, shown in an extended condition. (Modified from Schmil, "Text-book of Zoology," by the courtesy of A. and C. Black, and of Quele and Meyer.) Somewhat diagrammatic, the positions of the alimentary canal and mantle cavity being indicated by dotted lines.

tion and gradually develops a spiral form. Under the mantle is a mantle cavity the wall of which is kept moist by a secretion and serves in respiration.

The number of ganglia in the gastropods is much greater than that in the mussel, and they lie closer together in the body (Fig. 125). The sense organs include, besides eyes and olfactory organs, a pair of organs of equilibrium similar in structure to those of the mussel, one lying on each side of the head near the supraesophageal ganglion.

In locomotion the body is protruded from the shell, the foot is extended, and a slime gland behind the mouth secretes a mass of slime which passes back under the foot and forms a pathway upon which the animal glides, its course being marked by the track of slime left behind. Some snails can move with a moderate degree of rapidity, Baker ascribing to them a speed of two inches per minute.

Snails are either dioecious or monoecious. In case they are monoecious, self-fertilization does not usually occur, but in copulation there is reciprocal fertilization.

Some snails are terrestrial, in which case they breathe by taking air into the mantle cavity, the surface of which is kept moist by a mucous secretion. Other snails are pulmonate and inhabit fresh water, in which case it is necessary for them to come to the surface of the water at intervals to fill the mantle cavity with air. In the case of others, which live at all times submerged, water is taken into the mantle cavity, where respiration may take place through the walls of the cavity or by means of gills. The majority of snails are marine. Many of them reach a considerable size and develop shells possessing great beauty of form and color. A snail shell may be made up of many coils in one plane, or it may

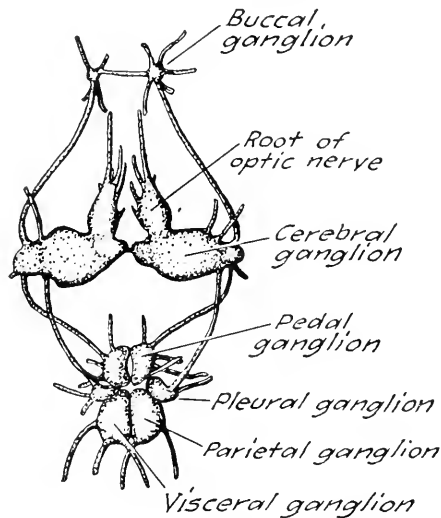

FIG. 125.—Somewhat diagrammatic representation of the central portion of the nervous system of *Helix pomatia*. (From Lang, "Text-book of Comparative Anatomy.")

be extended into a spire. On the other hand, the mouth of the shell may be greatly expanded and the coiling be reduced to one turn or even a part of a turn, as in the abalone. There may be no coils at all, as in the case of the limpets, which have symmetrical conical shells. Still another type of snail is one fitted for pelagic life. This has the foot broadly expanded and of the shape of a pair of wings, giving to the animals the names of butterfly snails or sea angels. Some snails secrete an operculum which serves as a lid to the opening of the shell, being so placed on the body that when the animal is in the shell the operculum just fills the aperture.

Another type of snail includes the naked snails or slugs, which may be without any shell at all or may have only a small chitinous disc occupying the same location on the body as the shell and embedded in the mantle. These are in part terrestrial forms and are often seen under objects lying on the ground in fields or gardens. There are also naked marine snails,

often called sea slugs or nudibranchs, usually found in beds of seaweeds, which exhibit varied forms and a wide range of colors.

260. Scaphopoda.—This class contains a limited number of mollusks which are found at moderate depths in the sea, buried in the mud at the bottom. They have a mantle which is tubular in form and which secretes a tubular shell open at both ends and larger at one end than at the other. This shell is curved like the tusk of an elephant, so these are sometimes called tusk shells (Fig. 126). The foot protrudes through the larger end and is used for boring in the mud.

261. Pelecypoda.—This class, also known as the Lamellibranchiata, is represented in both fresh and salt water and includes forms which are similar to the fresh-water mussels already described. They possess no head and have a bivalve shell. Among the various types of pelecypods are mussels, scallops, oysters, clams, and the shipworm. Many of the marine forms in this group are permanently attached to firm objects on the bottom or along shore, from which objects they can be dislodged only with great difficulty. This attachment may be by horny threads, forming a *byssus*, as in the marine mussels, or may be due to the disappearance of a part of the under valve of the shell and the firm adherence of the animal's body to the substratum through the hole so formed, as in the case of some oyster-like forms. Such forms do not move about in the adult stage, and the foot may be undeveloped. Scallops have numerous eyes along the margins of the mantle.

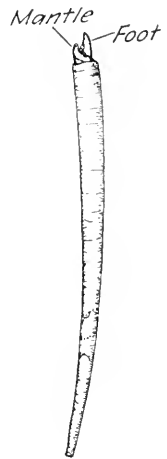

FIG. 126.—
A tusk shell,
Dentalium pretiosum Sowerby,
from Puget
Sound. Natural
size.

In many bivalves a blind sac or caecum connected with the intestine secretes a rodlike body, or *crystalline style*, the function of which is unknown.

262. Cephalopoda.—The cephalopods make up a group which in many respects is very much higher than any other class of mollusks. They are all marine. They have the dorsoventral diameter of the body greatly increased and the anteroposterior diameter greatly reduced. They may even become so flattened anteroposteriorly that ends and surfaces change places. What appears to be the anterior or head end when the animal is in its normal position is really the ventral surface, and the apparent posterior or tail end is the dorsal surface; the real anterior end is the upper surface and the real posterior end the lower surface (Fig. 127). In addition to this marked change in the axes the foot is concentrated about the "head" and has become divided into a number of *tentacles* situated in a ring about the mouth. These tentacles have a great many sucking discs. The relationship of mantle and shell to the body differs in different types of cephalopods.

In the case of both the squid and cuttlefish, the mantle incloses a cavity on the lower surface and ends just behind the head in a free margin, or *collar*. From under this collar projects a *siphon*, out of which water can be forced by the contraction of the mantle, driving the animal back-

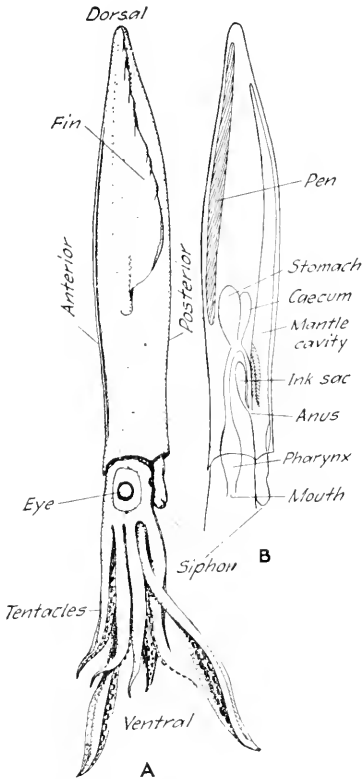

FIG. 127.—Common squid of the Atlantic coast, *Loligo pealei* Lesueur. From a preserved specimen. $\times 1\frac{1}{2}$. A, lateral view. B, diagram to show position of certain internal structures. The body is placed so as to bring out the position of the morphological axes; its normal position in the water is at an angle of 90 degrees to this, with the anterior surface above (Sec. 262).

ward through the water. The shell in the cuttlefish is a horny and limy plate concealed under the skin of the upper surface of the body; it is formed by a pocket of the mantle. In the squid it is only horny. There are two *fins*, one on each side of the body toward the tail end, which may be used for forward locomotion and as a means of directing the course of the animal. When swimming forward the tentacles are pressed together, are extended in front, and are used for steering. The siphon may also determine the direction of backward motion by being pointed either toward or away from the head as the water is forced through it. There are two powerful chitinous jaws in the squid resembling an inverted parrot's beak, and a radula is present. There are also two gills in the mantle cavity.

The nervous system consists of several pairs of ganglia brought together in close proximity in the head. The sensory organs include two very highly developed eyes, two organs of equilibrium, or statocysts, and one which is probably an olfactory organ. The eyes (Fig. 128) are large and superficially similar to those of the vertebrates but when critically compared with them are found to be fundamentally different in structure. The resemblance is a case of

analogy. The eyes of cephalopods are capable of distinct vision—that is, they have the power to form a picture.

Squids possess a gland known as the *ink sac* that secretes a black coloring matter which, when spread in the water, produces a cloud like a smoke screen behind which the animal makes its escape from an enemy.

Another type of cephalopod is the octopus, or devilfish (Fig. 129), which has no shell but possesses a large bulbous body. The mantle

cavity and siphon resemble those of the squid and are used in a similar way. Large octopuses are dangerous antagonists and are feared by

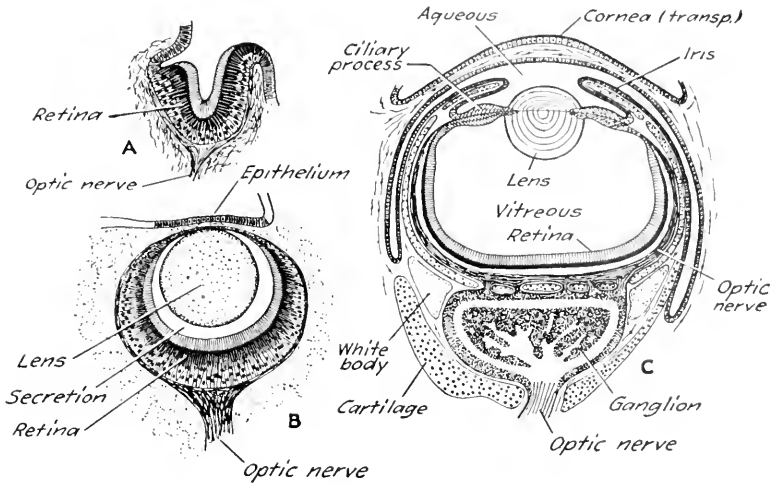

FIG. 128.—Eyes of mollusks. A, eyespot of *Patella*, a gastropod, possessing only an area of pigmented epithelium, or retina, and optic nerve. B, the eye of *Murex*, another gastropod, showing a well-developed eye with lens, retina, and optic nerve. (From Cooke, "Cambridge Natural History," after Hilger, by the courtesy of The Macmillan Company.) C, diagrammatic section of the eye of a cuttle fish, *Sepia* sp., showing many parts analogous to the eye of a vertebrate. (From Jordan, "Allgemeine Vergleichende Physiologie der Tiere," after Hensen, by the courtesy of Walter de Gruyter & Company.) All figures much magnified.

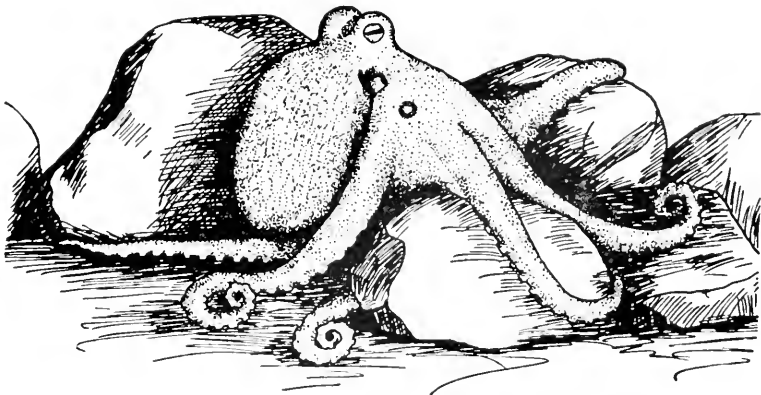

FIG. 129.—An octopus, *Polypus bimaculatus* (Verrill). A small specimen drawn from life. (From Johnson and Snook, "Seashore Animals of the Pacific Coast," by the courtesy of The Macmillan Company.)

divers, for if they get hold of a person under water struggling merely causes them to cling the tighter, and release can be secured only by chopping the tentacles from the body.

A third cephalopod type is the chambered, or pearly, nautilus (Fig. 130), which lives on the bottom of the sea near certain islands in the south Pacific Ocean. The shell is coiled in one plane and is composed of a series of compartments, each representing a chamber which has in the

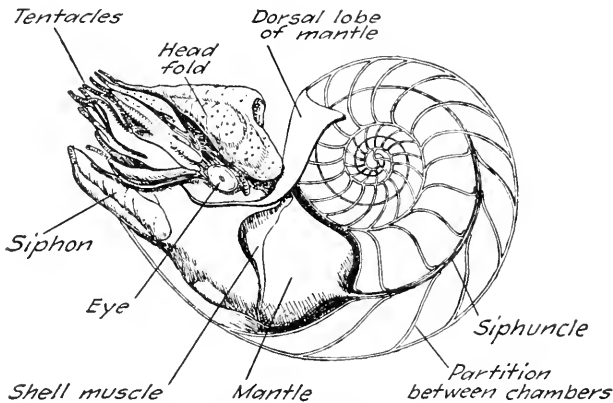

FIG. 130.—A female chambered nautilus. (From Hertwig and Kingsley, "Manual of Zoology," after Ludwig and Leunis, by the courtesy of Henry Holt & Company.) The shell is bisected, but the animal is not.

past been occupied by the animal, but which has been deserted as it and the shell have grown larger. The animal lives in the outermost compartment. The partitions are concave toward the mouth of the shell. These compartments are stated to be filled with gas, which gives

buoyancy to counteract the weight of the shell. Through the center of them and piercing the successive partitions clear back to the end of the coil is a tube which lodges a cylindrical mass of tissue known as the *siphuncle*.

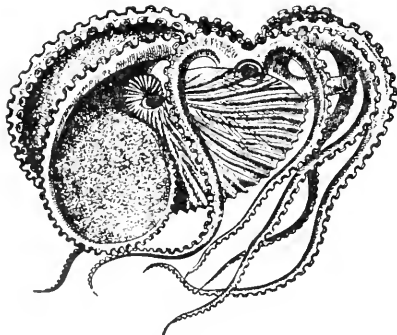

FIG. 131.—Paper nautilus, *Argonauta argo* Linnaeus. Female, swimming. (From Claus and Sedgwick, "Text-book of Zoology," by the courtesy of The Macmillan Company.) \times about $\frac{1}{4}$.

mollusks. The animal swims in this shell as if in a boat, propelling itself by means of the tentacles.

Among the cephalopods are the largest of the invertebrates. The giant squid reaches a total length of over 50 feet, including the tentacles,

and the outspread tentacles of the largest octopus possess a span of 30 feet. Among living types the shelled ones are relatively small, but some fossil forms with shells reached a large size. The shells of the straight-shelled Silurian types exhibit a length of 15 to 18 feet, and those of the coiled ammonoids of the Jurassic, which resembled the living pearly nautilus, a diameter of from 4 to 6 feet (Sec. 584 and Fig. 313).

263. Metabolism.—The food of mollusks is exceedingly varied. The pelecypods take any minute particles of organic matter found in the water, while the snails and their allies scrape the epidermis from living or dead plants or gather algae from the surfaces on which they grow. On the other hand, the cephalopods, powerful and active forms as they are, are carnivorous and will feed upon any animal which they can overcome. Squids destroy a great many fish, and an octopus will undertake to capture anything which it can grasp with its tentacles. One large marine gastropod, *Sycotypus*, lives in shallow water and feeds on other mollusks, while another, known as the oyster drill, *Urosalpinx*, feeds on oysters and other bivalves, boring a hole through the shell of the victim with its radula and eating out the soft parts.

264. Behavior.—The behavior of the most simple types of mollusks is correspondingly simple, but that of the cephalopods is very complex. One striking fact about mollusks is that in the case of the lowest class, the Amphineura, which is wormlike, there is a nervous system similar in some respects to that of the flatworms. In other classes there are numerous scattered ganglia. These in the cephalopods are grouped together in the head. The close proximity of these ganglia offers an opportunity for quick communication between them and effective coordination, produces a real *brain*, and has resulted in developing a very efficient organism, to which some zoologists have attributed the possession of intelligence.

The sense which most mollusks depend upon is that of smell. With few exceptions they seem to be sensitive to light, and it has already been shown that the cephalopods have excellent vision.

265. Reproduction and Regeneration.—Asexual reproduction never occurs in Mollusca, but the animals may be either monocious or dieocious. Though some of them produce only a few eggs, others produce large numbers. It is stated, for example, that 9,000,000 eggs may be laid by a single oyster. Some snails, and also some small fresh-water bivalve mollusks, are viviparous.

Molluscan eggs are holoblastic but undergo unequal cleavage. Development typically includes a trochophore stage but this is not represented in the development of land and fresh-water mollusks. The cephalopods have a larva which develops within the egg. The *trochophore* larva (Fig. 132) is top-shaped with a ring of cilia about the margin of the expanded upper portion and with an eyespot at the apex of the body.

The mouth opens near the ring of cilia and the anal opening is below at the tip of the body.

Since a trochophore larva appears in the development of bryozoans and annelids, as well as mollusks, and since it resembles in a certain degree some rotifers, the suggestion has been made that these groups may have all descended from a common ancestral form called a trochozoon. There are many strong arguments against this view as well as others for it.

Regeneration of lost parts and repair of injuries are general among the mollusks, but they do not include replacement of ganglia, the loss of which causes death.

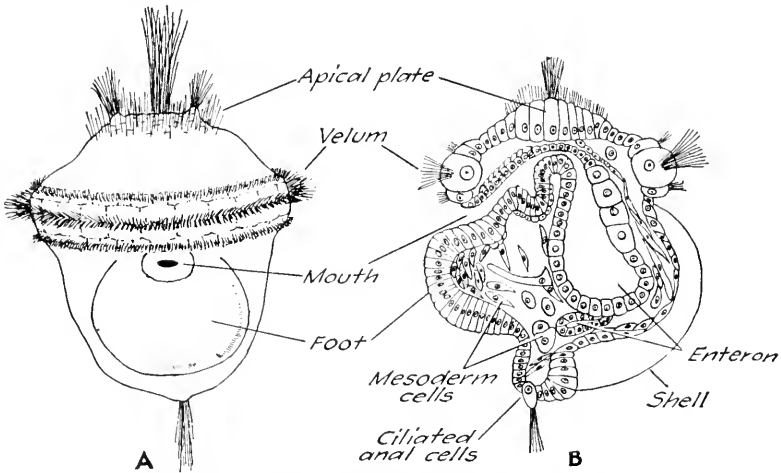

FIG. 132.—Trochophore of *Patella*, one of the limpets. A, viewed from the ventral side. B, median section of a slightly older trochophore. (From Korschelt and Heider, "Text-book of Embryology.")

266. Economic Importance.—Mollusks are of economic importance from several points of view. Their greatest value is as human food. The reports of the U. S. Fish Commission showed, in 1930, a total value of canned oysters, clams, and other shellfish, and of by-products amounting to over \$17,000,000. The total for 1931 was nearly \$14,000,000. Snails are much eaten in some countries of Europe and to a certain degree also in this country. Among the bivalve mollusks clams, oysters, scallops, and other forms are regular articles of diet. The value of the oyster industry alone along the Atlantic seaboard has been estimated at between \$30,000,000 and \$40,000,000 annually. The arms of squids are also cut off and used as food. The shells of many of the mollusks are for one reason or another articles of commerce. Many of them are sold as ornaments on account of their beauty. Others are used in the production of pearl buttons, and the pearl-button industry has attained great proportions in this country, especially in Ohio, Illinois, and Iowa.

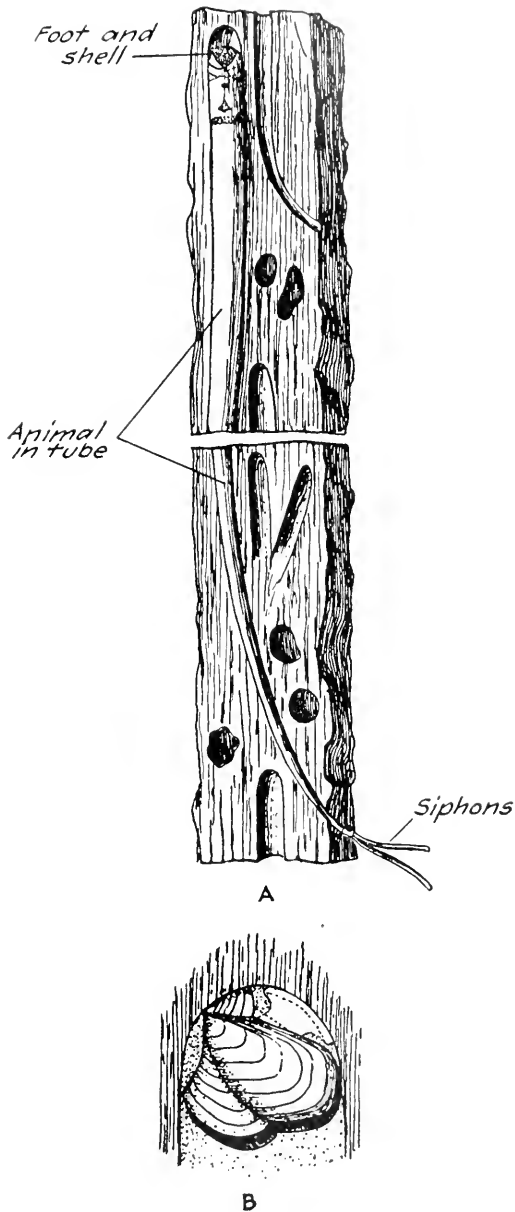

FIG. 133.—Shipworm, *Teredo navalis* Linnaeus. A, section of a block of wood showing parts of several empty tunnels and one containing an animal. The whole is divided, and only the two ends shown to allow it to come within the limits of the figure. (From Cooke, "Cambridge Natural History," after Möbius, by the courtesy of The Macmillan Company.) Natural size. B, the shell, mounted in position at the end of a tunnel, lateral view. (From Miller, Univ. of California Pub. in Zool., vol. 26, by the courtesy of the University of California Press.) $\times 5\frac{1}{2}$.

The value of products derived from fresh-water mussels, in 1930 and 1931, amounted to about \$5,000,000 in each year. The supply of shells, however, has greatly diminished, and the future prosperity of the industry will rest on the success of experiments in artificial propagation now being conducted. The shells of mollusks are crushed and sold as "grit" to be fed to fowls, while cuttlefish bone is given to captive songbirds as a source of lime. Pearls are also a product of mollusks, being developed in the shells of a number of bivalve forms. Whenever any irritating particle gets in between the mantle and the shell, a nacreous covering called mother-of-pearl is secreted around this particle, thus forming the pearl. Parasitic worms or infective organisms may also cause the formation of pearls.

Some mollusks are injurious. In addition to those which attack oysters and other bivalves of value may be mentioned the shipworm, *Teredo navalis* Linnaeus. This is a bivalve with an elongate wormlike body (Fig. 133) ending posteriorly in two long slender siphons which reach the outer end of the tube in which the animal lives. At the anterior end are two small valves, not hinged but separate and movable. With the sharp anterior edges of these valves the animal burrows into the wood of ships and piling, sometimes to a depth of 4 feet, its siphons being extended into the water for the purpose of feeding and breathing. It has long been disputed whether or not the animal eats the wood which it removes and the particles of which are passed back through the body and out of the siphon, but it now seems definitely proved that it does and that it also gets food in small particles from the water as do other bivalves. The tube which serves to lodge and protect the soft body is smallest at the outer end, largest at the inner, and becomes lined with nacre secreted by the mantle. Some snails secrete an acid which dissolves limestone rock and thus they excavate cavities in which they live.

The defenceless condition of most mollusks makes them the prey of many other animals, including all classes of vertebrates. They are also the intermediate hosts of many parasitic worms.

CHAPTER XXXIX

EARTHWORM

A TYPE OF THE PHYLUM ANNELIDA

Earthworms are very generally distributed, being absent only from regions where the soil is nearly pure sand and deficient in humus or from mountain regions where the soil is scanty and also poor. Very heavy soils with much clay in them are not favorable, and earthworms are unable to live in soils that are strongly acid. During the daytime they remain in their burrows in the ground, but at night they may come out and move about on the surface. A species common in Europe and America, *Lumbricus terrestris* Linnaeus, may serve as a type.

267. External Characteristics.—The most prominent characteristic of the earthworm is the division of its body into *metameres* to the number of 175 in fully mature individuals, not including a half metamere at the anterior end known as a prostomium (Fig. 134). The metameres, which may be numbered XXXI or XXXII to XXXVII are, in mature worms, swollen and whitish, the skin containing glands which take part in reproduction. These metameres form a region known as the *clitellum*.

The surface of the worm is covered by a thin transparent *cuticula* marked by fine striae which produce iridescence. The cuticula is pierced by bristle-like *setae*, which are present in all but the anterior two or three metameres and the last. These setae are very small chitinous rods similar in form to an old-style *s* (*f*) and serve as organs of locomotion. There are four pairs to a metamere, one pair on each side just below the middle and the other on each side midway between the first pair and the ventral median line.

The mouth is a crescent-shaped opening on the anterior side of the first metamere, overhung by the *prostomium*. The anal opening is a slit on the posterior side of the last metamere. Minute *dorsal pores* located in the mid-dorsal line at the anterior margin of each metamere behind the eighth or ninth are openings from the coelom directly to the outside. Other openings on the surface will be referred to in connection with the organs of elimination and reproduction.

268. Internal Structure.—The body wall of the earthworm forms a thin-walled tube (Fig. 135), the cavity of which is the *coelom*; this is separated into compartments by cross partitions, or *septa*, which mark the boundaries of the metameres. These partitions are more or less incomplete or even absent between certain metameres at the anterior

end of the body. From one end of the animal to the other the alimentary canal extends, a tube within a tube. It is held in place by the partitions, the coelomic spaces thus becoming ringlike. In the ventral portions of metameres IX to XV are the reproductive organs, while above the alimentary canal is the dorsal blood vessel and below it the ventral blood vessel and nerve cord. Each metamere, except the first three and the last, also contains a pair of nephridia. The coelomic spaces are lined by a delicate epithelium known as the *peritoneum*. They are filled with the coelomic fluid, which is colorless and which, when the worm contracts, can flow from one space to another through a small opening in each septum above the ventral nerve cord.

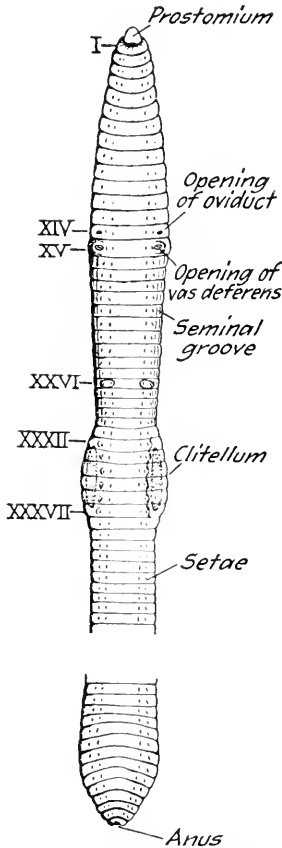

FIG. 134.—An earthworm, *Lumbricus terrestris* Linnaeus. Ventral side of the more anterior and the most posterior segments. From a preserved specimen. $\times 1\frac{1}{3}$ in length and about 2 in diameter. Segments numbered in roman.

269. Alimentary Canal and Metabolism.—The alimentary canal is divided into a greater number of regions than in any type previously discussed and these are more highly specialized (Fig. 136). These regions include a *buccal cavity*; a muscular *pharynx*; a narrow *esophagus*; a thin-walled ciliated *crop*, or *proventriculus*; a thick-walled muscular *gizzard*; and a thin-walled *intestine*, which begins at metamere XIX.

The *food* of earthworms consists of organic matter in the soil and of living or decaying leaves. The worms will also eat bits from the bodies of dead animals when they can secure them. The organic matter in the soil may be gathered at any time, but the fragments of leaves are secured from the surface of the ground at night. Taken in at the mouth by a sucking action of the pharynx and mixed with a secretion from salivary glands in the pharyngeal wall, this food is passed to the crop. From here it goes into the gizzard where it is ground and is then passed on into the intestine where digestion and absorption take place.

Feces are egested at the anal opening. They appear in the form of castings outside the burrows. Enzymes are produced in the intestine which act on proteins, fats, and carbohydrates.

270. Circulatory System.—The circulatory system of the earthworm is a complicated system of blood vessels through which the blood is forced by a sort of peristaltic action of the muscle fibers in the walls of

the vessels. *Peristalsis* is the passage of a series of rhythmic contractions along a vessel which advances the contents of that vessel in the same direction as that in which the waves of contraction progress. In metameres VII to XI are five pairs of dilated vessels, often called *hearts* (Fig. 136), which connect the dorsal to the ventral blood vessels. They are really dilated vessels exhibiting powerful peristaltic movements. Valves in the dorsal vessel and hearts prevent back flow. The blood which is circulated in these vessels consists of a liquid *plasma* in which float colorless ameboid cells called *corpuscles*. In the plasma is dissolved a red coloring substance known as *hemoglobin* which aids in the inspiration and transportation of oxygen by combining with it, forming *oxyhemo-*

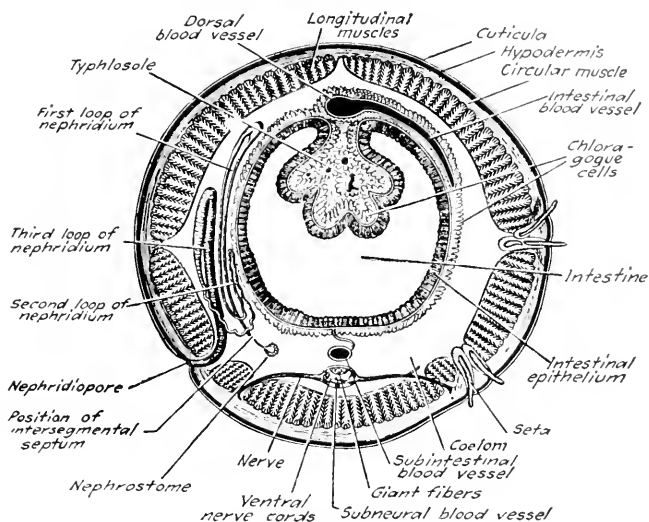

FIG. 135.—Diagrammatic cross section of an earthworm at about the middle of the body. (From Marshall and Hurst, "Practical Zoology," by the courtesy of G. P. Putnam's Sons.) The nephrostome of the segment in front is shown for the sake of completeness.

globin. Much more oxygen can be contained and transported in combination than if it were free. This combination is formed when oxygen is taken into the body and is only temporary, being broken up again in the tissues, thus liberating free oxygen for their use. Respiration takes place through the whole surface of the body.

271. Excretory System.—The excretory system consists of a number of organs called *nephridia* (Fig. 137), a pair of which is present in every metamere but the first three and last. Each of these possesses a ciliated funnel called a *nephrostome* located in the posterior part of the coelom of one metamere and opening into a thin ciliated tube passing through the septum into the coelom of the next metamere. Here the tube becomes complexly looped and ultimately opens by a *nephridiopore* between the two double rows of setae. Cilia on the nephrostome create

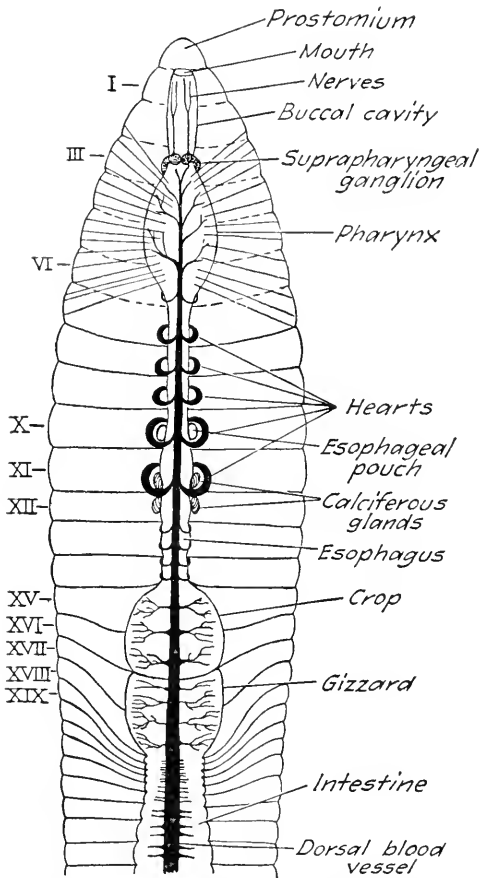

FIG. 136.—Diagrammatic representation of the anterior part of the alimentary canal of an earthworm. Based upon a preserved specimen. The blood vessels are shown in solid black. Segments numbered in roman.

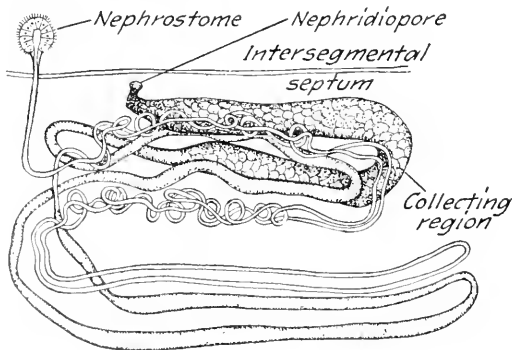

FIG. 137.—Diagrammatic view of the nephridium of an earthworm. In the body this is invested with soft connective tissue and the loops of the tubule are crowded together. Highly magnified.

a current which draws solid waste particles from the coelomic fluid into the nephridial tube and cilia in the tube pass these onward and out of the body. Glands in the coiled tube also take nitrogenous waste matter from the blood and add it to the liquid in the nephridium, which results in its elimination.

272. Musculature and Locomotion.—The muscles of the earthworm are arranged in two layers. An outer layer of circular muscle fibers just below the skin forms a continuous sheet about the body. An inner layer of longitudinal muscles is arranged in several bands—two dorsal, two ventral, and a lateral one on each side between the double rows of setae (Fig. 135).

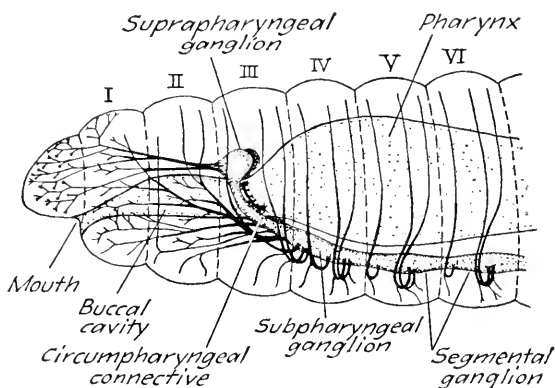

FIG. 138.—Anterior portion of the nervous system of an earthworm. Lateral view. (From Hess, in *Jour. Morphology*, vol. 40.) Segments numbered in roman.

Locomotion is carried on by extension, contraction, and flexion of the body due to the muscle layers and also by the use of the setae. Muscles attached to the latter structures serve to retract them within their sheaths in the skin or, when they are protruded, to move them either forward or backward. Accordingly, acting as so many little levers, the setae serve to propel the body in either direction within the burrow.

273. Nervous System.—The nervous system in the earthworm consists of segmentally arranged, paired ganglia and a nerve trunk, which together form a *central nervous system*, and of *peripheral nerves* which distribute fibers to various parts of the body. The central nervous system begins anteriorly in a pair of *suprapharyngeal ganglia* (Fig. 138) fused into a bilobed mass which is located in the third metamere and above the front end of the pharynx. From these ganglia two nerve trunks known as *circumpharyngeal connectives* pass around the pharynx, one on each side, to unite below in the same metamere, forming a ventral nerve cord. Upon this is a bilobed dilatation in the fourth metamere formed by the *subpharyngeal ganglia*. The *ventral nerve cord* continues

backward to the posterior end of the body showing a ganglion in each metamere, each ganglion being really a fused pair. Nerves from each ganglion supply the structures in that metamere.

274. Behavior.—The earthworm possesses no special sense organs, but it responds to several stimuli. The response to a *mechanical stimulus* is positive when the stimulus is not too strong and is continuous but negative when it is of contrary character. This leads the worms to remain at rest when in their burrows and to seek the greatest amount of contact with surrounding objects when moving about on the surface. They will move from their places in their burrows when the ground is struck a hard blow and, if they are close to the surface, will come out of them. It is this type of reaction which leads earthworms to leave their burrows during a heavy rain, when the earth is pounded by the falling raindrops, and to crawl upon the surface where they are soon beaten into insensibility and even killed. This explains why it is that after such a rain dead worms are frequently found on the surface of the soil, while others are crawling about seeking again to enter their burrows. Darwin showed that they did not react to sounds but would respond to sound vibrations as mechanical stimuli. This result was secured when a flower pot containing soil in which were some earthworms was placed upon a piano, thus providing a means by which the sound vibrations could be communicated to the pot and to the soil.

Earthworms respond positively to *chemicals* which indicate the presence of food and negatively to harmful substances. This reaction occurs not only when the substance comes in contact with the body but also when a substance with a pungent odor is still a little distance away. The reaction to moisture is always positive.

Earthworms are sensitive to *light* in varying degree in different parts of the body, the anterior end of the body being most sensitive, the posterior part next, and the middle portion least. Slight differences in light intensity are detected, and the worms will seek a region of faint illumination in preference to one where the light is strong. The effect of these responses to strong and weak light tends to keep the worms in their burrows during the daytime but leads them to emerge at night.

The earthworm exhibits various *physiological states* which are determined not only by the state of metabolism within the body but also by previous stimulation. After being repeatedly and violently stimulated the nervous system is put into such a condition that even slight stimulation causes a response out of all proportion to the strength of the stimulus.

Earthworms remain near the surface of the soil only when it is moist, and as the soil dries they gradually retire farther into the ground, remaining below the upper limit of moisture. This occurs regularly in the latter part of the summer when the ground becomes dry. They return to the surface again in the spring when the ground is full of moisture. At

Lincoln, Nebraska, their burrows have been followed to a depth of more than 18 feet from the surface. In winter they usually remain below frost line.

275. Reproductive System and Reproduction.—Both sets of sex organs (Fig. 139) are present in each individual earthworm, this animal being monocious. The male organs include three pairs of *seminal vesicles*, the first two of which open into a common central reservoir in the tenth metamere and the third into a similar reservoir in the eleventh metamere. In each reservoir is found a pair of *testes*. From each reservoir *vasa efferentia* lead into a common *vas deferens* on each side, the outer opening of which is in metamere XV. The sperm cells are produced in the testes, matured in the seminal vesicles, and passed out through the *vasa efferentia* and *vasa deferentia*.

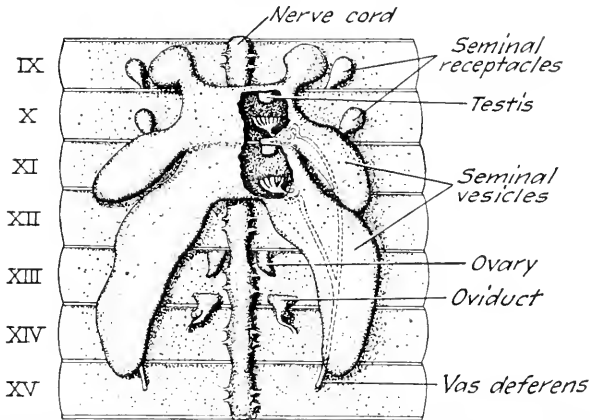

FIG. 139.—Reproductive organs of an earthworm. (From Wieman, "General Zoology," by the courtesy of McGraw-Hill Book Company, Inc.)

The female organs consist of a pair of *ovaries* in metamere XIII. The egg cells are set free in the coelom and on each side are collected by a ciliated funnel which leads into an *oviduct* in metamere XIV; this opens to the outside on the ventral surface of this metamere. In addition there are two pairs of *seminal receptacles* in the ninth and tenth metameres, which open to the outside in the grooves between the ninth and tenth, and the tenth and eleventh, metameres.

Self-fertilization does not take place in the earthworm, but sperm cells are transferred from one individual to another by a process of *copulation*. Two worms come together with their ventral surfaces in contact and with their anterior ends pointed in opposite directions (Fig. 140 A), placing themselves so that metameres IX, X, and XI of one worm are opposite the clitellum of the other. They are held together by two slime tubes formed from mucus secreted by the clitellar and other skin glands, each tube extending from metameres IX to XV of one worm

and through the length of the clitellum of the other. Sperm cells are passed out through the vasa deferentia of one worm and flow in two canals formed by apposing grooves on the ventral surfaces of the two animals (Fig. 140 B), to the openings of the seminal receptacles of the other, into which they enter. The same thing occurs on the part of the other animal, and thus a reciprocal exchange of sperm cells takes place. The worms then separate, each having its seminal receptacles filled with sperm cells from the other worm, ready to be used in fertilization when egg laying occurs. At that time a *cocoon* (Fig. 140 D) is secreted about the clitellum and then slipped forward over the head of the worm. As it passes the openings of the oviducts several egg cells are passed into it; and as it passes the openings of the seminal receptacles, numerous sperm

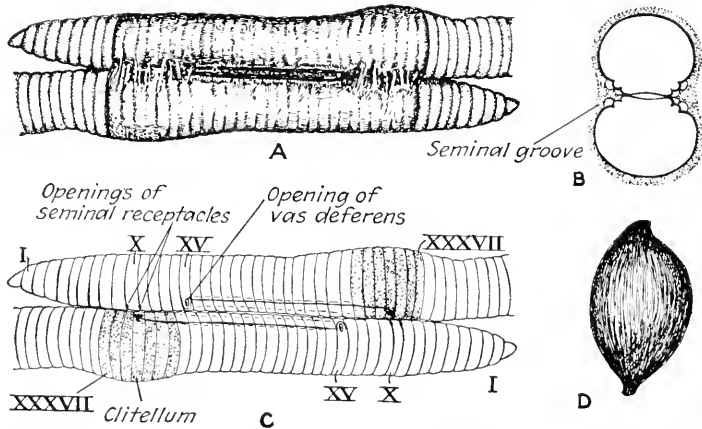

FIG. 140.—Reproduction in the earthworm. (From Curtis and Guthrie, "Text-book of General Zoology," by the courtesy of John Wiley & Sons, Inc.) A, two worms enclosed in bands of mucus. B, transverse section showing the seminal grooves. C, a sketch to show the path of the seminal fluid from the openings of the vasa deferentia on one worm to the openings of the seminal receptacles on the other. D, the cocoon.

cells. There is also added an albuminous secretion from skin glands which serves to nourish the developing embryos. As the cocoon leaves the worm the two ends come together and thus is formed an inclosed cavity, within which fertilization takes place. One worm will form many such cocoons.

The eggs are holoblastic but undergo unequal cleavage; a hollow blastula is formed, and later a gastrula by invagination. All of the egg cells which are contained in the cocoon do not develop into embryos, most of them appearing to serve as nurse cells. Those which do develop produce small worms very similar to the adult, which escape from the cocoon in about two or three weeks. When the young worm first becomes free it lacks a clitellum, that appearing later as the worm acquires sexual maturity.

Asexual reproduction does not occur in the earthworm.

276. Regeneration.—Earthworms have a considerable power of regeneration and exhibit it in a manner which suggests two axial gradients. One of these has a maximum near the anterior end of the worm and fades out rapidly in the metameres which lie behind (Fig. 141). The other has a maximum at the posterior end and fades out toward the anterior end of the body. A new head can be regenerated at the anterior end of a posterior fragment only as far back as the fifteenth to the eighteenth metamere; beyond the fifteenth the newly formed head is not perfect. A new tail cannot be developed on an anterior fragment farther forward than the twelfth metamere; back of the twelfth a posterior piece may regenerate an anterior tail, but such a two-tailed worm, of course, cannot survive. This existence of two gradients seems to be correlated with the greater sensitiveness of the body at the two ends than in the middle.

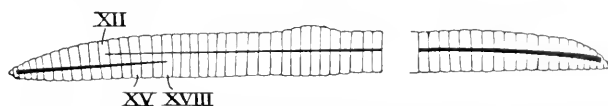

FIG. 141.—Diagram to show the possibilities of regeneration in the earthworm. Regeneration of a head end is perfect back to segment XV, imperfect as far as XVIII; regeneration of a tail end occurs back of XII.

Experiments in *grafting* earthworms have been tried by suturing fragments together and then permitting them to unite. In this way several pieces may be combined to make a very long worm, a short anterior and a short posterior piece may be united to form a very short worm, two tail pieces may be united to form a worm with a tail at each end, or two tail portions may be grafted to an anterior piece to form a double-tailed worm. Of course such abnormal individuals cannot long survive.

277. Economic Importance.—Earthworms are exceedingly important economically because of their influence in increasing soil fertility. By opening up the ground and permitting access of air they help to freshen it, and by bringing earth from below to the surface they serve to develop a thicker layer of humus. In passing the soil through their bodies nitrogenous waste is added to it in such form that it can be utilized by plants. The honeycombing of the soil also permits moisture to penetrate it more rapidly. Charles Darwin, in his book on "The Formation of Vegetable Mould through the Action of Worms, with Observations on Their Habits," brought together the results of forty years of observation and a wealth of facts bearing upon this subject. Rarely does the work of earthworms cause injury; the loosening of soil in the walls of irrigation ditches, however, has given trouble in some parts of the West.

CHAPTER XL

REFLEX ACTION

Reflex action has already been referred to in Chap. XXX; it exists in animals of the grade of flatworms and those higher in organization. The structure in the earthworm is so easily correlated with the elements in this type of action that it is usually studied in detail in this connection.

278. Nervous Functions.—The functions of the nervous system are the reception of stimuli, the conduction of nervous impulses, and the stimulation of other cells of the body (Sec. 124). A nervous *stimulus* is any outside influence exerted upon any part of a nerve cell and producing an effect. This effect transmitted through the cell or any of its branches is termed a nervous *impulse*, and when this impulse is communicated as a stimulus to any other cell through an appropriate point of contact, it starts an impulse in the other cell if it is a nerve cell or causes it to act if it is a muscle or gland cell.

The unit of structure in the nervous system is the *neuron*, which may be defined as a nerve cell including all of its branches, or fibers. In development the branches grow out from the cells to their ultimate point of distribution. A neuron which receives a stimulus is known as a *receptor*, and one which conducts the impulse from the receptor to the acting cell or cells is known as an *adjustor*. The cells which act and which are not neurons but muscle or gland cells are termed effector cells, or simply *effectors*. Neurons generally show *polarity*, which is the ability to transmit impulses more readily in one direction than in another. This is related to their position with reference to other neurons, to sense cells, or to effectors.

The impulse is passed from a fiber of one neuron to that of another at one or more points where the fibers or their branches come in intimate contact. It is believed that they do not become structurally continuous. Such a contact area is known as a *synapse*. An impulse is communicated to the effector cell usually through some form of nerve ending, such as a motor end plate, in which the fiber comes in intimate contact with the cell.

All fibers which transmit impulses toward the cell body of the neuron are termed *dendrites*, of which there may be several; the one which transmits an impulse in the opposite direction is termed the *axon*, or the axis cylinder fiber. The path by which impulses pass from the periphery to a nerve center is termed the *afferent* path, while that by which impulses

are carried from the center to the effector cells is known as the *efferent* path.

279. Reflex Acts.—In a typical and ideally simple *reflex act* a receptor neuron situated in the hypodermis is stimulated from without (Fig. 142), the stimulus being received directly by the cell body or by a short dendrite. An afferent impulse follows the axon of this cell to a synapse in a central ganglion where it is passed to the dendrite of an adjustor neuron. This sends out an efferent impulse along its axon to a muscle cell, the effector, causing contraction and resulting in a movement appropriate to the stimulation which originated the act. This entire mechanism is

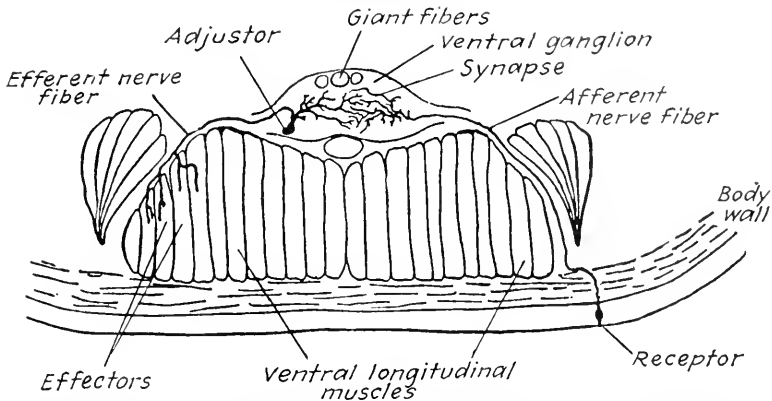

FIG. 142.—Diagram illustrating reflex action in an earthworm. (From Parker, in *Popular Sci. Mon.*, vol. 75, after Retzius.)

called a *reflex arc*. Actually such a simple reflex does not occur, since in any action several receptors are stimulated at the same time and several effectors participate in the action. Also not one but several adjustors are usually involved, and they form chains of neurons through which conduction takes place. Since each of these adjustors is in communication with several others, spreading or radiation of the impulse also occurs.

In the earthworm not only may several adjustors in the same ganglion be involved in a reflex act, but it is also possible for impulses to pass from one ganglion to another. This transmission of an impulse from one metamere to another is due to adjustors the axons of which are known as *association fibers*. The association fibers are contained in three tracts known as *giant fibers*—though they are really bundles of fibers—which lie in the dorsal part of the ventral nerve cord. These fibers put the cell of which they are a part into communication with cells in other ganglia in front of the ganglion in which this cell is located or behind it. In this way very strong stimuli may affect the entire body of the earthworm, causing it to act as a whole.

280. Anterior Ganglia.—The two anterior pairs of ganglia of an earthworm are larger than the others, and to the first of these, or the supra-

pharyngeal ganglia, is often given the term brain (Fig. 138). However, these ganglia apparently do not function in any way different from the other ganglia of the body. Their size is due in part to the greater area from which they receive afferent impulses and to which they distribute efferent impulses and in part to the fact that they innervate the most sensitive part of the body. Either an increase in the area served and the number of structures involved or an increased sensitiveness of the parts means an increase in the number of neurons in any nerve center and therefore an increase in size. The ganglia in question do not possess two attributes which are associated with the brains of higher animals. They do not exercise that dominance over the functions of the body generally that a true brain should and may be removed and regenerated with the rest of the anterior end of an earthworm. It is better, therefore, to avoid the use of the word brain in connection with this type and with other invertebrates with a nervous system of this character.

CHAPTER XLI

ANNELIDS IN GENERAL

The most striking advance shown by annelids is the appearance of *metamerism*. A forecast of this may be considered as shown in the transverse groovings on the body of some of the Nematelminthes, but in that case no internal segmentation corresponded to this external indication. Metamerism in annelids involves not only the division of the body wall into a series of sections but also a metamerie arrangement of internal structures, shown most strikingly by the excretory and nervous systems. The irregularly distributed groups of flame cells opening to

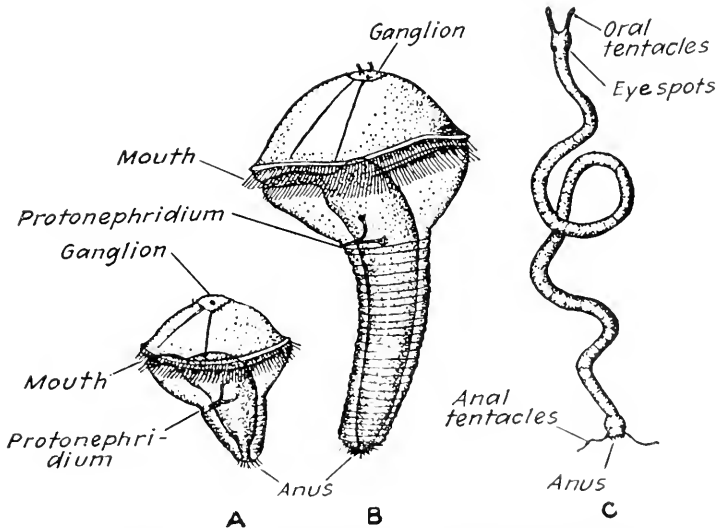

FIG. 143.—*Polygordius* sp., showing two stages in the development of the trochophore larva (A, B) and the adult (C). (From Wieman, "General Zoology," after Hatschek and Fraipont, by the courtesy of McGraw-Hill Book Company, Inc.) A and B much magnified, C \times about 2.

the outside through one or a few openings of a common large duct, seen in previous phyla, are replaced in members of this phylum by a series of excretory organs arranged in pairs, one pair to a metamere and each complete in itself. The nervous system, also, instead of showing a general tendency toward the accumulation of cells in a few ganglia or nerve tracts, shows the development of *metamerically arranged ganglia* connected by a ventral nerve cord. An earthworm is really made up of a series of nervous units. These may act individually but are so related

in a central nervous system as to be capable of acting in concert. This makes possible both unity and variety of action. Different metameres may carry on differing activities, while in case of necessity all may be brought into play in an action involving the body as a whole. Still another advance is seen in the greater degree of *specialization* exhibited by the digestive system, which is here divided into a larger number of regions than heretofore, each region having a special function to perform.

281. Classification.—The phylum Annelida (ă něl' ĭ dā; L., *anellus*, a little ring, and G., *eidōs*, form) is divided into four classes:

1. *Archiannelida* (ār kī' ä něl' ĭ dā; G., *archi-*, first, + *annelida*).—Primitive annelids which possess neither setae nor parapodia.

2. *Chaetopoda* (kē tōp' ō dā; G., *chaite*, horse's mane, and *podos*, foot).—Annelids with setae, and in one of the two subclasses with parapodia, which are fleshy lateral outgrowths of the body wall.

3. *Hirudinea* (hī rōō dīn' ē ā; L., *hirudo*, leech).—Annelids possessing neither setae nor parapodia but having suckers, which are an adaptation to parasitic life.

4. *Gephyrea* (jē fī rē' ā; G., *gephyra*, bridge).—A small and heterogeneous group, apparently more



FIG. 144.

FIG. 144.—A sandworm, *Nereis virens* Sars. From a specimen. The parapodia bear foliaceous lobes which are conspicuous in the figure. $\times 23$.

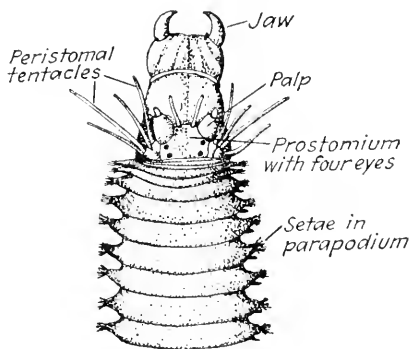

FIG. 145.

FIG. 145.—Anterior end of a sandworm (*Nereis*) with prostomium and peristomium protruded and extended. (From Wieman, "General Zoology," after Ehlers, by the courtesy of McGraw-Hill Book Company, Inc.)

appropriately placed in Annelida than in any other phylum.

282. Archiannelida.—A type of this class is *Polygordius*, a small worm about an inch and a half long, living in the sand of the seashore

(Fig. 143). It is only indistinctly metameric externally, but internally it shows clear metamerism and a structure somewhat resembling that of the earthworm. The prostomium bears a pair of fleshy tentacles which are both sensory and respiratory. The other members of this class are also small in size, simple in structure, and are marine. One type, *Dinophilus*, has eyespots, moves by means of cilia, and has other characters reminiscent of the planarians.

283. Chaetopoda.—The chaetopods are divided into two subclasses, one being Polychaeta, the species of which are mostly marine. The type of this subclass usually studied is *Nereis*, the sandworm (Fig. 144). This is an abundant form living in burrows in the sand or mud of the seashore. These burrows sometimes reach a depth of two feet and the sand forming their walls is held together by mucus. Although similar in many ways to the earthworm, the sandworm shows many striking differences. The anterior metameres (Fig. 145) are distinct from the rest and are recognized as forming a *head*, divided into two parts, prostomium and peristomium. The *prostomium* possesses a pair of feeling organs or palpi, a pair of tentacles, and two pairs of eyes. The *peristomium* contains the mouth, with a pair of chitinous jaws, and bears four additional pairs of tentacles. The *tentacles* are organs of touch, the *palpi* probably of taste and smell, and the *eyes* of light perception. Along the sides of the body are fleshy projections, or *parapodia*, a pair to each metamere except those of the head, each parapodium bearing several clusters of setae. These parapodia also are abundantly supplied with blood vessels and serve in respiration. The sexes are separate in *Nereis*, which is generally the case in all the polychaets.

Other polychaets show a tendency to the division of the body into portions which have been likened to the thorax and abdomen of arthropods. Some of the polychaets reach a large size, attaining a length of three feet. These frequently construct tubes, various in nature, in which they live. The tube may be limy, cylindrical, and attached to rocks, over the surface of which it follows a very irregular course, gradually growing in length and increasing in diameter as the worm grows. In other cases it is made of grains of sand cemented together, and in still other cases it is chitinous. In these tube-dwelling forms the parapodia frequently become much reduced in size. In worms known as sabellids the palpi become greatly developed, complexly branched, frequently feather-like, and serve as organs of respiration (Fig. 146). These so-called gills are often vividly colored and when expanded are objects of great beauty. Polychaet worms exhibit all colors, and many are luminescent.

The other subclass of the chaetopods is Oligochaeta, most of the members of which are either terrestrial or fresh-water forms. They lack parapodia and tentacles, and the setae are single, though they may

be near together in pairs. This group includes not only the earthworms but also many other forms of varied structure. Some species are very large, one found in Java being said to attain a length of several feet with a correspondingly great diameter. Some are able to climb trees.

Among the fresh-water oligochaets are a large number of small and relatively simple forms with not more than a pair of setae to each metamere, in some cases less. These are, in general, very transparent and

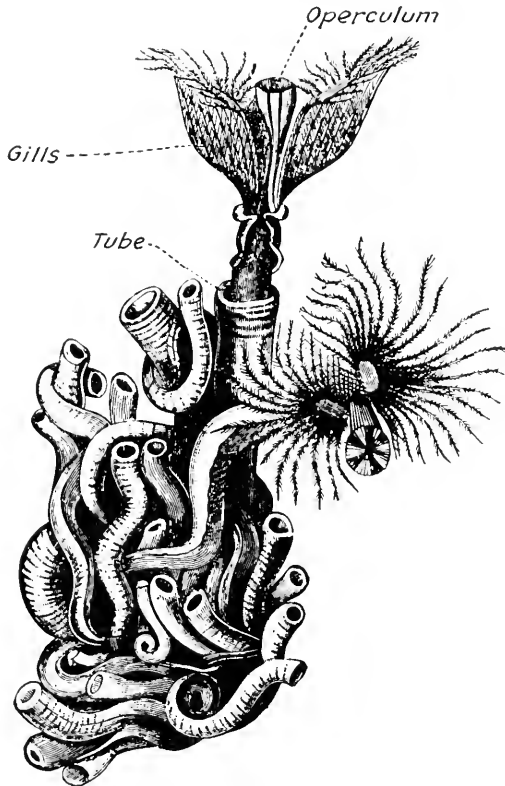

FIG. 146.—A colony of sabellid worms, *Serpula vermicularis* Linnaeus, showing the mass of tubes and the expanded tentacles. (From Benham, "Cambridge Natural History," after Cuvier, by the courtesy of The Macmillan Company.) The operculum closes the tube after the worm has withdrawn into it. Natural size.

without color, though sometimes, as in *Aeolosoma*, they contain brightly colored oil globules scattered through the body. Some of them live in aquatic vegetation, crawling about by movements of the setae combined with the undulations of the body. Others live in tubes in the mud at the bottom of ponds or other bodies of water, and frequently in colonies containing large numbers of individuals. They project themselves from the mouth of these tubes, waving their bodies backward and forward, but retreat into the tubes when strongly stimulated. A colony of such worms in activity presents an animated appearance.

284. *Hirudinea*.—The class *Hirudinea* contains the leeches, which differ from other annelids in that they possess two *suckers*, one inclosing the mouth and the other being ventral to the anal opening. They also have a smaller number of metameres than in other annelids. There appears to be a greater number of these, however, than really exist, because each one is marked by several transverse grooves (Fig. 147).

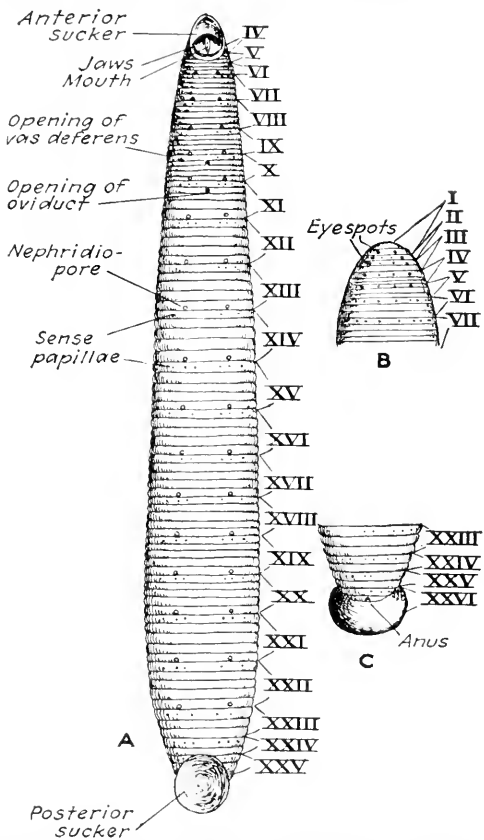

FIG. 147.—The medicinal leech, *Hirudo medicinalis* Linnaeus. (From Borradaile, "Manual of Elementary Zoology," by the courtesy of Oxford University Press.) A, the whole animal, ventral surface. The segments are shown by roman numerals. B, the anterior end, dorsal surface. C, the posterior end, dorsal surface. A, natural size; B and C slightly enlarged.

The suckers are used as organs of attachment when the animal is at rest and also as organs of locomotion when the animal moves about upon a firm substratum, the movement being similar to that of a measuring worm. Leeches are able to swim freely through the water, the body performing vertical undulations.

The mouths of some leeches, such as the medicinal leech (Fig. 147), are provided with jaws armed with chitinous teeth. When such a leech

attaches itself to another animal for the purpose of securing blood these teeth are brought into play as a means of scarifying the surface and thus permitting the blood and lymph to flow freely. At the same time salivary secretions are introduced into the wound which prevent coagulation of the blood. Consequently the wound produced by a leech bite is usually very irritating. The blood is sucked up by the action of a muscular pharynx and passed into a crop, which is very long and provided with lateral branches that give it great capacity. It has been stated that a medicinal leech can take in three times its own weight of blood and that this supply will last it for nine months. The blood which is stored in the crop is from time to time passed on into the stomach, where it is digested; from here it goes into the intestine for absorption.

There are other leeches which have a protrusible proboscis in place of jaws, and still others which lack both jaws and proboscis. They attack animals of various groups but more particularly the vertebrates. Snails, fish, and turtles are among the forms most commonly preyed upon, but mammals entering the water also become victims. There are land leeches, occurring chiefly in the tropics, which are serious pests. One species of European land leech feeds upon earthworms.

Leeches are hermaphroditic, but, as in the case of the earthworm, cross-fertilization takes place. The sperm cells are collected in bundles called *spermatophores* which are passed from one worm into the body of another. The eggs of many leeches are deposited in chitinous *cocoons* that are attached to the surface of hard objects in the water where they form brown, elliptical, moderately convex objects. Some leeches are viviparous. Others carry their eggs attached to the ventral surface of their bodies, and when the young are hatched they remain with the parent for a time, attached by the posterior sucker.

285. Gephyrea.—The affinities of this group are uncertain but it has more resemblance to the annelids than to any other phylum recognized in this text. Its members are all marine (Fig. 148). Some show traces of metamerism while others do not, but they may have lost this feature through degeneration.

286. Metabolism.—The food of some annelids is made up entirely of small animals; that of others includes both microscopic plants and animals; that of still others consists of any organic detritus; while that of leeches is only blood and lymph. The alimentary canal of all annelids shows a high degree of specialization. Circulation is carried on by means of coelomic cavities and blood vessels. Excretion takes place into both the coelomic fluid and the blood, and elimination is accomplished by means of nephridia. These in some cases have no opening into the coelom and so eliminate only liquid waste. Respiration always takes place through the body surface but may be more or less limited to certain areas, as to the parapodia or the tentacles about the head.

287. Behavior.—The behavior of the earthworm has been described. That of other types seems to be similar, subject to the possibilities and limitations depending upon different modes of living and in some cases to life in a fixed tube. Many annelids have eyespots or eyes. An *eyespot* is simply an area on the surface of the body made up of cells with light-absorbing pigment. By the addition of other parts such an

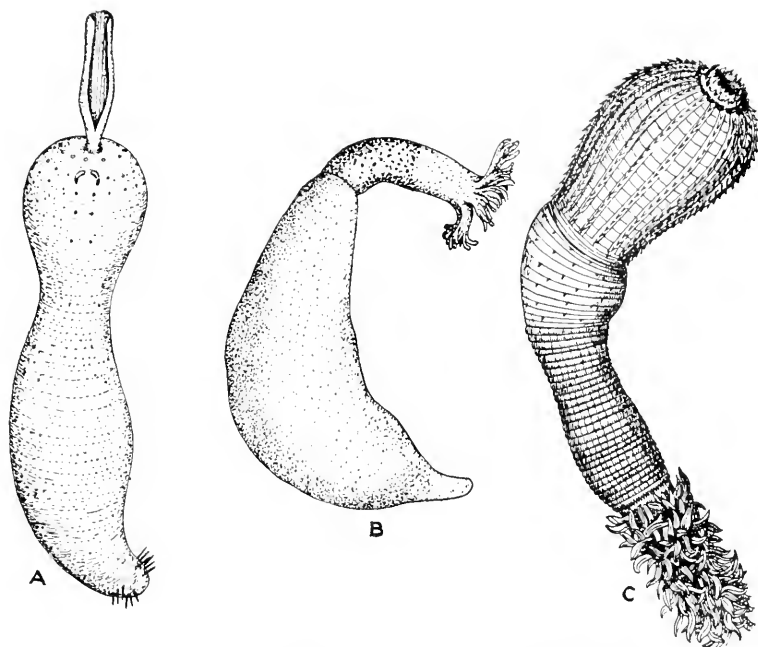

FIG. 148.—Three types of Gephyrea. A, an echiurid, *Echiurus pallasi* Guerin, found along the northern Atlantic coasts, of both this continent and Europe, living in sandy and muddy beaches. South in North America to Maine. (From Delage and Hérouard, "Traité de Zoologie Concrète.") $\times 1\frac{1}{2}$. B, a sipunculid, *Dendrostoma alutaceum* Grube. Found among coral reefs near shore from Cape Hatteras to the West Indies. (From Gerould, in Proc. U.S. Nat. Mus., vol. 44.) $\times 4$. C, a priapulid, *Priapulid caudatus* Lamarek. Found in shallow water along the sand and mud beaches of the Arctic ocean. (From Shipley, "Cambridge Natural History," by the courtesy of The Macmillan Company.) Natural size.

area becomes an *eye*. The eye of the sandworm is globular and is composed of a cup of pigmented cells, the inner ends of which form *rods*; a central gelatinous mass, the *lens*; and a thin cuticular area on the surface, the *cornea*. The rods, lens, and cornea are all transparent and transmit light. Leeches, which possess no eyes, palpi, or tentacles, are exceedingly sensitive to touch and are apparently attracted to their prey by vibrations coming to them through the water. It is possible that they are also stimulated by secretions from the bodies of the animals on which they feed, also brought through the water.

288. Reproduction.—Reproduction has been referred to in the case of the earthworm and of the leech. Sexual reproduction in other forms is similar. There is, however, a type of asexual reproduction by means of transverse *fission* which sometimes occurs in annelids, the result of which is to produce a colony of several individuals moving about together (Fig. 149). In *Aeolosoma* this is the ordinary mode of multiplication, and sexual reproduction seems to be rare.

In some of the polychaets the sex cells are produced from the epithelium lining the coelomic cavities in the posterior metameres of the body.

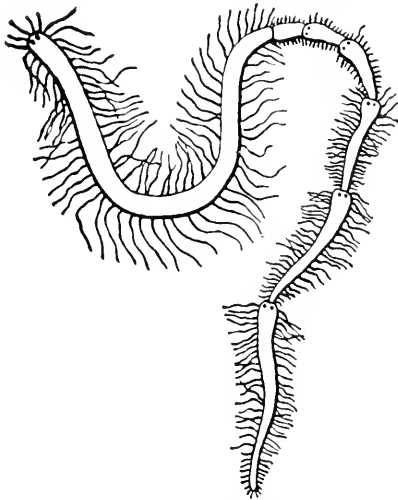

FIG. 149.—A chain of individuals formed in an annelid, *Myrianida* sp., by budding. (From Hertwig and Kingsley, "Manual of Zoology," after Milne-Edwards, by the courtesy of Henry Holt & Company.) The budded individuals develop in order, the one at the end of the chain being the oldest; compare with asexual reproduction in the tapeworm colony.

the sexual part of the body separates by fission, forming a swimming *sexual zooid* with a new head, tentacles, and eyespots. The *asexual zooid* which remains regenerates all the lost metameres and is ready to reproduce again. In one family the sexual zooid does not at once separate; both it and the asexual one multiply by transverse fission and this continues until a chain of as many as 16 individuals is produced, the anterior ends of each of which are asexual and the posterior sexual. All of the individuals in a chain are of the same sex. In still another type, which lives in a sponge in the eastern seas at a depth of over 100 fathoms, a branched colony of worms is produced by lateral budding.

The larva of most of the marine annelids is a *trochophore* (Fig. 143 A and B). This larva does not occur in fresh-water forms and of course is never seen in the terrestrial types.

289. Occurrence and Economic Importance.—The distribution of various annelids, especially the marine forms, is very general, though characteristic species are found in each region. Economically the earthworm has been shown to be generally a very beneficial type. The leeches, which live a parasitic life, should be considered injurious, enemies of both man and the domestic animals which serve him. The medicinal

leech, however, has in the past been of service to physicians and played such a part in medicine in the sixteenth century as to earn for the physician himself the appellation of leech. Most other annelids are of little

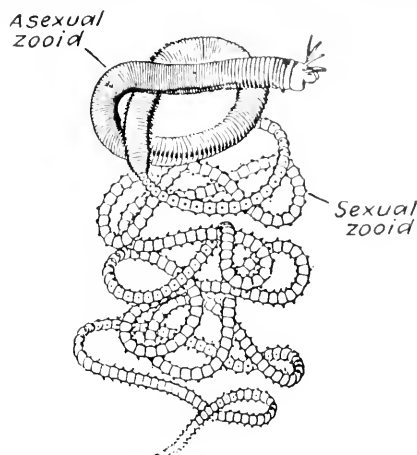

FIG. 150.—A palolo worm, *Eunice viridis* (Gray), showing asexual and sexual zooids. (From VanCleave, "Invertebrate Zoology," after Woodworth, by the courtesy of McGraw-Hill Book Company, Inc.)

importance, though some are used as fish bait. In the South Seas a worm known as the palolo (Fig. 150) is gathered by the natives when it swarms in the breeding season in October and November and is used as food, being considered a great delicacy.

CHAPTER XLII

CRAYFISH

A TYPE OF THE PHYLUM ARTHROPODA

The crayfish is a fresh-water form abundant throughout this country and represented by many species. Some of these prefer quiet waters and others running streams. There are also cave dwellers among them. Crayfishes usually spend the day in hiding under rocks or logs or other objects at the bottom of the pond or stream in which they live, though they may be tempted to come out by food which comes near their place of concealment. At night they become active, leaving their holes and wandering freely in search of food. They are often captured in large numbers in traps and may easily be caught by hand on a hook baited with a piece of meat. The meat is grasped by the pincers and held with such tenacity that a quick jerk will bring the animal out of the water. In books they are called crayfishes, but the names more commonly applied in this country are crawfishes or crawdads.

290. External Characteristics.—Crayfishes are metameric, the metameres being grouped into two regions, the *cephalothorax* and the *abdomen* (Fig. 151). The surface of the body is covered with an exoskeleton composed of chitin mingled with lime salts. On the dorsal surface of the cephalothorax the skeleton forms a continuous shell known as the *carapace*. A transverse *cervical groove* marks the division between parts corresponding to the head and thorax. A median forward extension of the carapace beyond the eyes is called the *rostrum*.

The cephalothorax includes 13 metameres, 5 representing the head and 8 the thorax, to each of which characteristic appendages are attached ventrolaterally. The first metamere bears a pair of *antennules*, and the second a pair of very long, many-jointed *antennae*, or feelers. On the third metamere is a pair of *mandibles*, and on the fourth and fifth metameres are two pairs of *maxillae*. A portion of the second maxilla is modified to form a scooplike plate known as the *scaphognathite*, or bailer.

Of the thoracic metameres, the sixth to the eighth bear *maxillipeds*, and the ninth to the thirteenth, *walking legs*. In the first three pairs of legs the segment next to the last is prolonged so that its tip is even with that of the last, and the two together form a pincer. In the first pair this pincer is very powerful, is called a *chela*, and the leg, a *cheliped*.

Of the six abdominal metameres, the first five bear appendages which are quite typical, except that the first two pairs are somewhat

modified in the male for use in reproduction (Fig. 152). The abdominal appendages are known as *swimmerets*, although they have no function in connection with swimming. The appendages of the last abdominal segment are broad and flat and are called *uropods*. With the *telson*, which is a projection of the segment backward in the median line, they

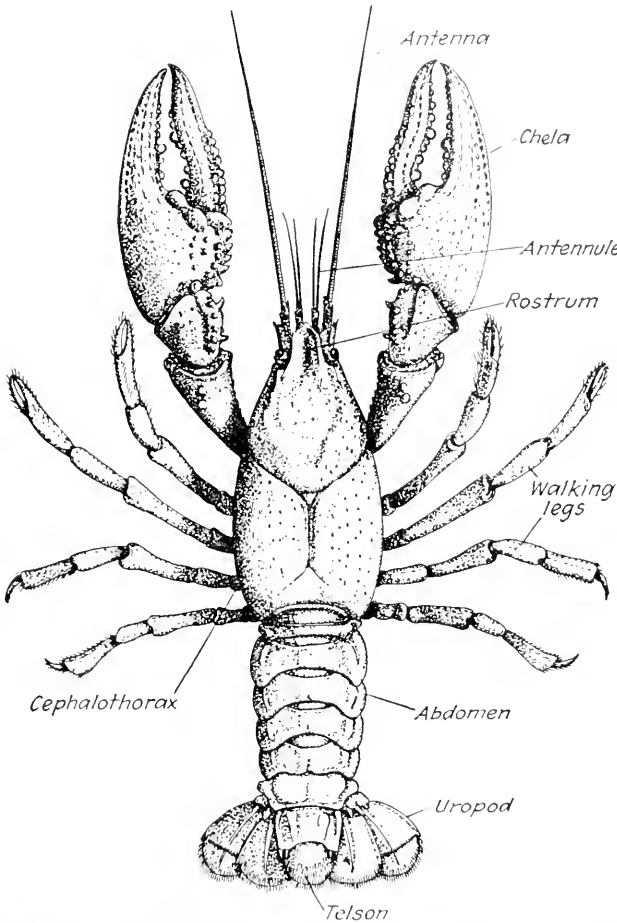

FIG. 151.—*Cambarus diogenes* Girard, one of the commonest and most widely distributed crayfishes of the United States east of the Rocky Mountains. [From Hagen, *Mém. Mus. Comp. Zool., Harvard Univ.*, vol. 2 (under the name *C. obsesus* Hagen).] $\times \frac{2}{3}$

form a broad, flat, paddle-like structure used in one form of locomotion. All of these appendages are reducible to a common plan and result from the modification of a typical *biramous*, or two-branched, appendage.

In addition to these appendages there are two stalked *eyes*, attached to the first segment on each side of the base of the rostrum, which can be extended and withdrawn and also pointed in different directions.

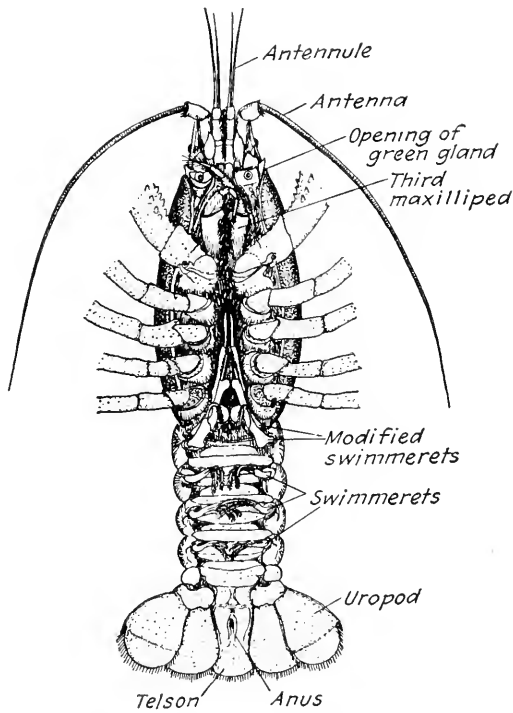

FIG. 152.—Under side of *Cambarus virilis* Hagen, a common species in the central states. From a male specimen from Wisconsin. $\times 2_3$.

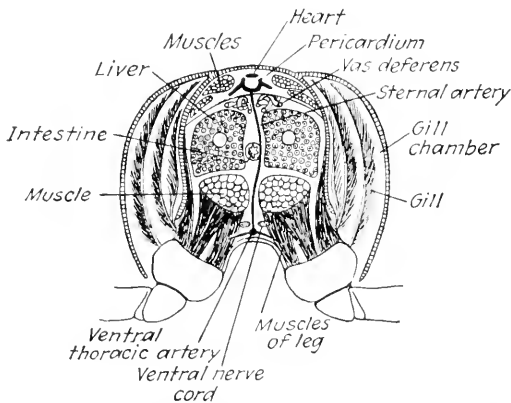

FIG. 153.—Diagrammatic cross section through a crayfish (*Cambarus*) in the posterior part of the cephalothorax, to show the gill chambers and gills.

There are two *gill chambers*, one on each side of the body, lying between the lateral wall of the body and a broad plate extending ventrally from each side of the dorsal surface. Each gill chamber is open in front, forming a channel in which lies the scaphognathite, or bailer, of the second maxilla. It is also open by a narrow slit along the ventral side and in the lower part of the posterior end. In this chamber, in the crayfishes of the eastern states, which belong to the genus *Cambarus*, are two rows of *gills*. The outer row is attached to the first joints of the appendages from the second maxilliped to the fourth walking leg (Fig. 153). The inner row of gills, double except in the case of the first one, arises

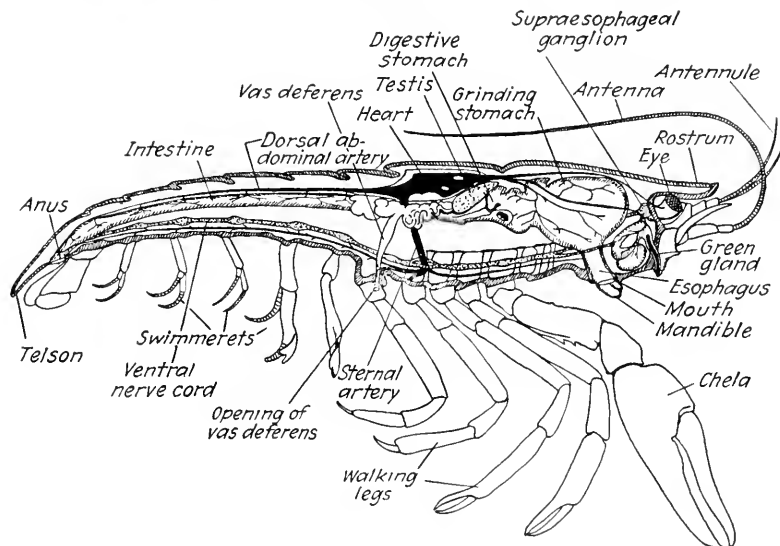

FIG. 154.—Partly diagrammatic longitudinal section of the European crayfish, *Astacus fluviatilis* Fabricius. (From Borradaile and Polls, "The Invertebrata," after Shipley and MacBride, by the courtesy of The Macmillan Company.) The individual is a male and the first two swimmerets are modified to form copulatory appendages.

from the membrane attaching the same appendages to the wall of the body. In the crayfishes of the Pacific coast, which belong to the genus *Astacus*, there is also a third row attached to the wall of the body itself. In respiration a current of water is maintained in the gill chambers produced by movements of the swimmerets, which direct water into the posterior end of the chamber, while it is being bailed or scooped out from the anterior end by the scaphognathite.

291. Internal Structure.—The various systems in the crayfish are well developed (Fig. 154). Some of the systems, like the muscular and nervous systems, are still metameric in their arrangement, but others show much condensation. The *coelom* is greatly reduced in capacity and becomes divided into separate cavities, including those containing the reproductive organs and those about the green glands, which are excretory

organs. Other spaces around the alimentary canal which contain blood and form what is known as a *hemocoel* are not truly coelomic.

The alimentary canal consists of a buccal cavity, esophagus, stomach, and intestine. The *stomach* is divided into two portions, one grinding and the other digestive in function. Between the two portions is a *strainer* composed of hairlike setae which permits the food to pass only when it has been ground into very fine particles.

The circulatory system includes the *heart*, seven arteries leading to various parts of the body, and spaces in the tissues called *sinuses* which communicate with a large space around the heart known as the *pericardial sinus*. Valves are present in the arteries and also guard the openings from the pericardial sinus into the heart.

The excretory organs of the crayfish are a pair of bodies known as *green glands* situated in the ventral part of the head in front of the esophagus, the ducts from which open through papillae on the basal segments of the antennae.

The crayfish possesses a well-developed muscular system, the muscles being attached to the various portions of the exoskeleton.

The nervous system (Fig. 155) is in many respects similar to that of the earthworm,

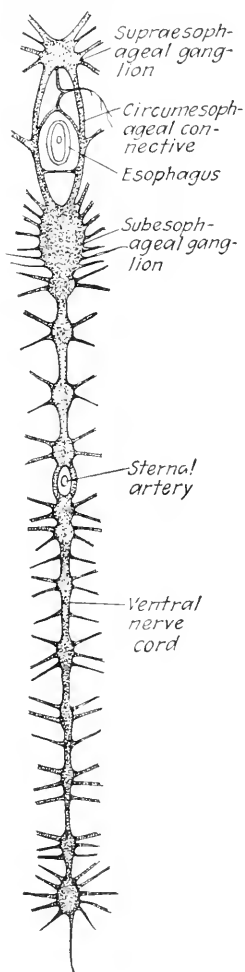

FIG. 155.

FIG. 155.—The central nervous system of a crayfish (*Astacus*). (From Lang, "Text-book of Comparative Anatomy," after Vogt and Yung.)

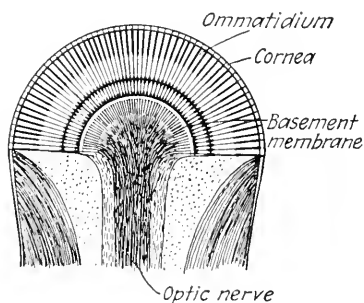

FIG. 156.

FIG. 156.—Diagrammatic representation of the eye of a crayfish.

including a *supraesophageal ganglion*; *circumesophageal connectives*; a *subesophageal ganglion*, representing a fusion of the ganglia of the metameres from III to VII; and a ventral gangliated *nerve cord* with ganglia in each segment posterior to the seventh. This condensation of metameric ganglia in the subesophageal ganglion promotes

coordination of all of the appendages used in connection with the process of food taking. The *sense organs* of the crayfish consist of a pair of eyes and a pair of statocysts. Tactile organs also are well developed in different parts of the body, particularly upon such parts as the chelae of the walking legs, the mouth parts, the ventral surface of the abdomen, and the edge of the telson. There also seems to be a general distribution of organs for the perception of chemical stimuli.

Crayfishes are *dicious*. The *vasa deferentia* open on the median side of the base of each last walking leg. The openings of the oviducts are at the base of each third walking leg.

292. Eyes and Vision.—The crayfish possesses *compound eyes*. Each eye is hemispherical in form and is covered by a transparent *cornea* which represents a modified portion of the cuticula (Fig. 156). The cornea is divided into rectangular facets, each one of which is the outer end of a rodlike unit known as an *ommatidium*. These ommatidia—of which there are approximately 2500—are radially arranged rods tapering toward the base, which causes their axes to converge toward a common center. From the ommatidia lead nerve fibers which, together, make up the *optic nerve*. When an ommatidium is observed carefully it is seen to consist of a corneal facet at the outer end (Fig. 157), within which is a lenslike structure known as the *vitrella*. Back of the vitrella is the *crystalline cone*, and back of the crystalline cone the *rhabdom*, on the outer side of which are the sensory cells, making up a *retinula*. The corneal facet, vitrella, crystalline cone, and rhabdom are all transparent. Pigment cells are scattered over the surface of the ommatidium. In bright light these cells are distributed throughout the length of the ommatidium; in dim light, however, they contract, leaving much of the wall without pigment.

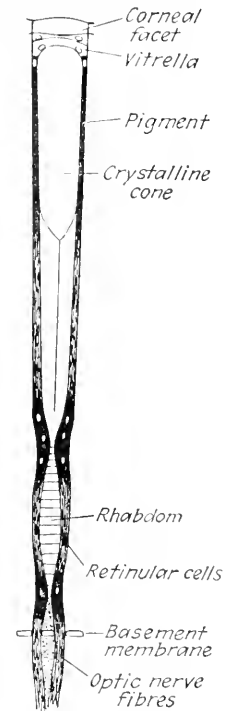

FIG. 157.—A single ommatidium from the eye of a crayfish. Somewhat diagrammatic.

A compound eye sees just as many little images as there are ommatidia, and since these images together make up the whole of the picture received by the animal, the picture has been termed a *mosaic image*. There is, however, some overlapping of the separate images. The production of a separate image for each ommatidium results from the fact that each of the ommatidia is long and slender, and since the pigment along the sides absorbs all the rays which it receives, only those rays reach the bottom and stimulate the retinula which are practically in line with the axis of the ommatidium. In dim light the withdrawal of pig-

ment from the wall of the ommatidium permits all of the rays entering it to be reflected backward, increasing the amount of light falling upon the retinula and thus giving a stronger stimulation. This probably does not result in a clear image but enables the animal to distinguish between light and dark. A compound eye has a great disadvantage when compared with such an eye as the vertebrate eye in that the animal cannot focus with it, thus limiting the distance to which vision is possible. It has, however, the great advantage that it more readily perceives movement in the visual field, since any motion almost inevitably results in a stimulus being withdrawn from one retinula and applied to another.

293. Statocyst.—At the distal end of the basal segment of each antennule is a sac, lined with chitin, which is continuous with the chitinous covering over the surface of the body; this is a *statocyst*. On its walls are sensory hairs and in its cavity are grains of sand or other hard objects known as *statoliths*. While the animal is in a normal position there is no movement of these statoliths, and though they are in contact with certain of the sensory hairs no stimulation is received. When, however, the position of the animal is changed, their movement causes them to come in contact with other hairs and this acts as a stimulus. There results a sensation which causes the animal to respond in such a way as to maintain its equilibrium. When the cuticula over the surface of the body is shed, that which lines the statocyst is lost with the rest, and other statoliths must be placed by the animal in the statocyst before it can again function.

294. Feeding Habits.—The food of the crayfish consists mostly of the flesh of dead animals lying at the bottom of the body of water in which it lives, bits of which it tears off with its large chelae. Living animals which the crayfish can grasp and hold with its chelae may also serve as food, such animals including snails, tadpoles, insects, and even small fish. The food is held by the maxillae and maxillipeds and chewed by the mandibles. Crayfishes readily devour one another when in captivity. They feed at night but are most active at dusk and dawn.

295. Behavior.—When the bottom is observed through the clear water of a lake or stream, there may very frequently be seen beside a stone or other object a slight depression leading to a burrow under the object and presenting a very clean appearance. This appearance, which gives one the impression of every particle of debris having been swept away, is due to the presence of a crayfish in the burrow and the constant current of water maintained by the animal in its breathing. Sometimes the antennae may be seen projecting from the opening. The animal is more or less in contact with the walls of the burrow. It faces the opening, ready to receive any stimuli which may come and to emerge quickly to seize any food which is presented. In this position the swimmerets are waving forward and backward, and the bailer is working actively in

the opening at the anterior end of the gill chamber, resulting in the maintenance of a current forward through the chamber. The legs are often moved quietly backward and forward, serving to wave the gills back and forth and thus aid in respiration. Some crayfish live in burrows in the ground which reach down to the water level. When a pond or stream dries up, the crayfish digs its burrow deeper and the earth excavated by the animal is brought to the entrance and built up into a characteristic mud chimney, which may be capped over with mud.

When attacked the crayfish defends itself with its chelae and resists being dragged from the burrow, but if the object under which it is hidden is raised, the animal is ready to dart away in the turbid cloud which is spread through the water and so escape. If food comes near enough to the opening of the burrow that its presence is detected, the animal emerges, walking by means of its walking legs, seizes the food, and immediately backs into the burrow again.

The crayfish is able to walk in any direction. It can also dart backward, the movement being the result of an extension of the abdomen and a spreading of the telson and the uropods, followed by a sudden flexion of that part of the body. The resistance of the water drives the animal rapidly backward. Since this action carries the animal only a short distance, it is often repeated, and thus the crayfish makes a series of backward darts.

Crayfishes respond positively to contact stimuli and seek to place themselves in such a position that as much of the body as possible is in contact with a firm surface. Chemical substances dissolved in the water also act as stimuli. Food not only causes a movement of the animal toward it but also excites chewing movements, and if meat juices are added to the water, vigorous movements of such a type result. Chemicals which are not normal to the water in which the crayfish is living may cause it to rub its legs together or to scratch the surface of its body with them. If the chemicals are in considerable concentration, however, the animal may endeavor to escape entirely from the stimulus.

Simple experiments have led to the general opinion that the behavior of the crayfish is in part instinctive and in part habitual. An *instinct* is an action involving an inherited association of reflexes all tending toward a certain end. A *habit* is an action of similar character, but it is acquired during the lifetime of the individual by the continued repetition of a particular action.

296. Reproduction.—Pairing of the sexes may take place either in the spring or in the fall. If at the former time, the young become well-developed before winter; if at the latter, the eggs may not be laid until the following spring. The author, however, has observed a female crayfish with very recently hatched young as late as the latter part of October in an extremely warm fall season. During pairing the sperm

cells are transferred by the first two pairs of swimmerets of the male from the opening of the vasa deferentia to the seminal receptacles of the female. The seminal receptacles are cavities inclosed in folds of the cuticula between the fourth and fifth pairs of walking legs. There the sperm cells remain until the eggs are matured. At this time the latter are passed out of the oviducts, which open at the bases of the third pair of legs, and backward in a groove between the bases of the legs of the two sides of the body, receiving sperm cells and being fertilized on the way. The eggs finally become attached to the swimmerets by a glue-like secretion, masses of them appearing like so many bunches of grapes (Fig. 158). They remain attached during development, their aeration being assisted by movements of the swimmerets.

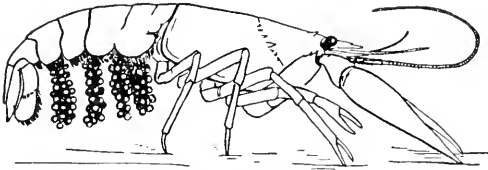

FIG. 158.—A female crayfish with eggs attached to her swimmerets. (From Andrews, in *Am. Natur.*, vol. 38.)

Cleavage is superficial and the embryo develops from a thickening of the blastoderm on one side. Limb buds appear, which correspond to the different appendages; metameres are formed; and the embryo gradually assumes the characteristics of the adult. Hatching takes place in from five to eight weeks, but the larvae remain clinging to the swimmerets of the mother for about four weeks longer. During this time they grow, shedding the exoskeleton at intervals but undergoing no metamorphosis. The process of shedding, which is an adjustment to permit growth, is known as molting, or *ecdysis*. This occurs seven or more times during the summer. It is said that the life of the crayfish covers a span of from three to four years. They reproduce annually after the second year.

297. Regeneration and Autotomy.—Crayfishes have the power of restoring lost appendages, and under normal conditions the same sort of appendage is restored as that which was lost. Under experimental or abnormal conditions, however, an abnormal appendage may replace the lost one. Crayfishes also have the power of autotomy, breaking off a walking leg at a point near the base known as the breaking point. This enables a crayfish to escape if its leg is grasped by an enemy or closed upon by the valves of a mussel buried in the bottom over which the crayfish is walking. The structure of the leg is modified at the breaking point to make autotomy easier, but the action is under the control of the individual.

298. Economic Importance.—In many localities crayfishes serve as food, but in most parts of this country they are used only as fish bait.

They are an agency in the destruction of decaying animal bodies in the water and from this standpoint are beneficial. Since they make holes in dams and levees they may cause serious damage. The cotton growers of the South also suffer because the crayfish eats young cotton plants. Especially in the clay lands of Alabama and Mississippi do they interfere with the raising of both corn and cotton.

CHAPTER XLIII

CRUSTACEA

Crustacea (krūs tā' shē à; L., *crusta*, a hard shell), to which the crayfish belongs, is a class included in the phylum Arthropoda (är thröp' ō dá; G., *arthron*, joint, and *podos*, foot). The animals of this class are distinguished from the other arthropods by the fact that they carry on respiration by means of gills, though some of them have become adapted to terrestrial life. Many of the aquatic forms are found in fresh water, but most of them are marine. Wherever found the individuals are very numerous and frequently occur in vast numbers. The body is divided into three regions, which are head, thorax, and abdomen; in some cases, as in the crayfish, the first two divisions may be united to form a cephalothorax. The head usually consists of five united metameres and bears two pairs of antennae; a pair of mandibles, or jaws; and two pairs of maxillae. The number of metameres in the thorax and abdomen varies in different types. The thorax possesses a number of segmented appendages, usually locomotor, while the abdomen may bear appendages with other uses. The appendages exhibit homology, being biramous and constructed on the same plan, but are specialized, each in a manner fitting it for the function it performs. Not all crustaceans are brightly colored, but among the marine shrimps are some of the most brilliantly colored of animals.

299. Malacostraca.—The many forms of Crustacea may be divided between two subclasses. The first of these, or Malacostraca (mäl à kōs' trā ká; G., *malakos*, soft, and *ostrakon*, a hard shell), includes types which in general are of large size, the largest being the largest of the arthropods and so large as to be conspicuous among invertebrates generally.

The *decapods*, which agree in having five pairs of walking legs, include crayfishes, lobsters, crabs, and shrimps. The more familiar of the crabs, or those which may be termed typical, differ from crayfishes and lobsters in the breadth of the cephalothorax, which frequently is broader than long, and in the fact that the abdomen is brought forward under the cephalothorax and closely applied to it (Fig. 159). The legs in the shore crabs are particularly short and in consequence of the breadth of the body are separated by a considerable interval. This explains the peculiar sidling gait of the animal in rapid locomotion. Shore crabs occur in abundance on the beach between tide marks, crawling under the rocks

and other objects for safety when the tide goes out. Other larger crabs, including the edible ones, find it less easy to hide and follow the water out with the tide. A soft-shelled crab is one which is caught in the process of molting after it has shed its old shell and before the new one has hardened. Among the various types of crabs is the hermit crab (Fig. 307), which possesses a soft abdomen and lives in the empty shells of snails. Sometimes the sea bottom along the shore will be covered with what at

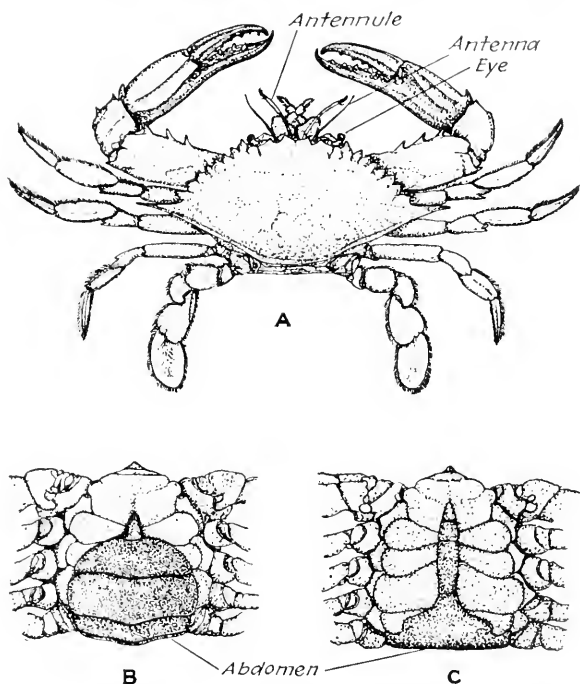

FIG. 159.—The blue or edible crab of the Atlantic coast, *Callinectes sapidus* Rathbun. From preserved specimens. A, upper surface. $\times \frac{1}{3}$. B, under surface of female to show breadth of abdominal metameres between which and the thorax the eggs are carried, attached to the swimmerets. $\times \frac{1}{2}$. C, under surface of body of male to show the narrowness of abdominal metameres. $\times \frac{1}{2}$.

first glance appear to be unnaturally active snails, but which on examination prove to be snail shells containing young hermit crabs. Sometimes these snail shells also bear other animals, such as sponges, hydroids, and sea anemones. Some crabs, known as spider crabs, have very long legs, which give them considerable speed in locomotion. A Japanese spider crab, the largest known crustacean, is said to reach a measurement of 20 feet from tip to tip of the outstretched legs.

The *isopods* are common in the sea and in bodies of fresh water and are in part terrestrial. They are flattened dorsoventrally and lack a carapace. All the legs are similar in structure except the posterior pair and, in the male, the anterior pair. The terrestrial forms, commonly

known as sow bugs (Fig. 160) and pill bugs, live under stones, boards and other objects upon the ground and are also found in damp cellars and in greenhouses, where the air is moist.

The *amphipods* are a third group of Malacostraca distinguished from the two preceding groups by being laterally compressed and by having an elongated abdomen. They have three pairs of anterior thoracic legs and on the abdomen three pairs of posteriorly directed jumping appendages. They also lack a carapace. They are found in all waters, a common fresh-water form, *Hyalella* (Fig. 161), being one of the most generally distributed of all North American animals. Amphipods are

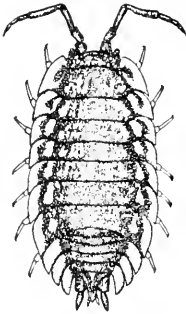

FIG. 160.

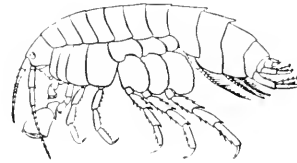

FIG. 161.

FIG. 160.—An isopod, *Oniscus asellus* Linnaeus. (From Paulmier, in Bull. 91, N. Y. State Mus., by the courtesy of the New York State Museum.) $\times 3$.

FIG. 161.—An amphipod, *Hyalella dentata* (Say). (From Paulmier, in Bull. 91, N. Y. State Mus., after Smith, by the courtesy of the New York State Museum.) $\times 6$.

also found on the beach between tide marks, where, because of their power of jumping, they are termed beach fleas.

300. Entomostraca.—Entomostraca (čn tō mōs' trā ká; G., *entomos*, cut in pieces, and *ostrakon*, a hard shell) are, generally speaking, of small size but they occur in numbers that can hardly be realized. It has been estimated that on the average each cubic meter of water in the small Wisconsin lakes contains about forty thousand individuals. Cladocerans have been observed in a small alkaline lake in Cherry County, Nebraska, in such numbers that the whole lake, when seen from a distance, was of a red color. Entirely around the shore was a windrow of these animals, cast up by the water, a foot wide and from an inch to two inches in depth. A wide-mouthed bottle filled by one dipping from the water of the lake at the shore was about half filled with the organisms after preservation of the material and on settling. The group (Fig. 162) includes Cladocera (klá dōs' ēr á; G., *klados*, sprout, and *keras*, horn), also known as water fleas; and Copepoda (kō pēp' ō dá; G., *kope*, oar, and *podas*, foot), some of which are parasitic on fish, being called fish lice. A third order is Ostracoda (ōs trā kō' dá; G., *ostrakodes*, having a shell), which are inclosed in bivalve shells and look like miniature mollusks.

Among the Entomostraca parthenogenetic reproduction is very common. During the spring and summer, in our fresh-water ponds and lakes, only the females of the common water fleas are to be found, and generation after generation of female individuals come from thin-shelled summer eggs which develop parthenogenetically in the brood pouch of the mother. In the autumn males appear, and thick-shelled winter eggs are produced, which are fertilized and live over the winter, to hatch and produce females the following spring. Parthenogenetic reproduction represents a rapid method of reproduction, which is necessary if these animals are to maintain themselves, since they form a very

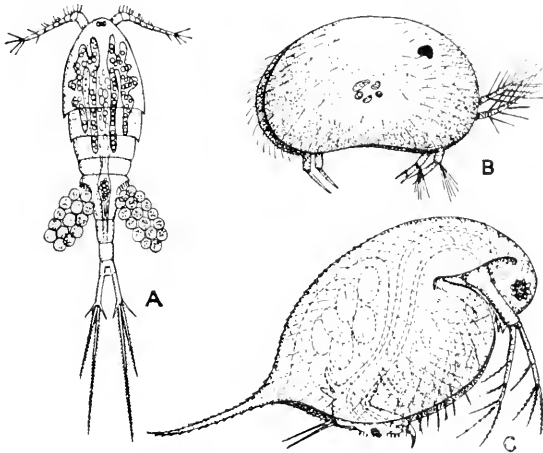

FIG. 162.—Three types of entomostracans. A, a copepod, *Cyclops* sp. (From Bronn, "Klassen und Ordnungen des Tierreichs," after Claus.) Female with eggs. B, an ostracod, *Cypris* sp. (Modified from Thomson, "Outlines of Zoology.") C, a cladoceran, *Daphnia pulex* (de Geer), a very common and widely spread species. (Compiled from several figures.) The figure represents a female with six eggs in the brood pouch. All figures highly magnified.

large element in the food of fishes and other animals. They are thus indirectly of economic importance.

The barnacles, which form an order of Entomostraca known as Cirripedia (sír ĭ pē' dī à; L., *cirrus*, curl, and *pedis*, foot), are Crustacea that have become fixed and inclosed in a calcareous shell of several pieces. The larvae are free-swimming but soon fasten themselves, back down, upon a firm surface, grow shells, and remain for the rest of their lifetimes attached (Fig. 163). If above the level of low tide barnacles close their shells when the tide goes out but when the tide returns reopen them and begin to collect food. This is brought to the mouth by the currents of water created by the movements of the legs. They occur sometimes in great numbers, completely covering the surfaces of rocks; younger generations, graded in size, are attached to the surfaces of the older generations so that 25 or 30 may exist within the area of only one square

inch. A square meter of rock area observed in Puget Sound was estimated to bear 41,500 individual barnacles, and since the rocks everywhere were covered with them, the total in the one locality must have been enormous. A colony of such barnacles presents a very animated spectacle when all of the individuals are kicking their legs at the same time.

301. Behavior.—The behavior of the crayfish has been described, and that of forms which are like it in structure is similar. Brief references to behavior have also been made as it is exhibited by barnacles, but nothing has been stated with regard to that of swimming forms, par-

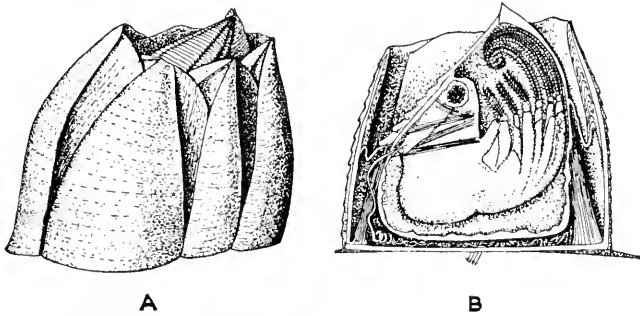

FIG. 163.—Barnacles. A, *Balanus hameri* Darwin. The shell of the animal is closed up, concealing the occupant. B, *Balanus tintinnabulum* Linnaeus, showing the internal anatomy of the animal, also with the shell closed. (From Bronn, "Klassen und Ordnungen des Tierreichs," after Charles Darwin.) Natural size.

ticularly entomostracans. These are exceedingly active, swimming or darting here and there and seeking that light intensity to which they are best adapted. Owing to the fact that some are adjusted to bright light and others to dim, there is a vertical migration in bodies of water of considerable depth which brings to the surface in the daytime certain forms which migrate to deeper levels at night. Others which remain at these deeper levels in the daytime come to the surface at night. In addition to light stimuli, crustaceans respond to contact and to chemical stimulation.

302. Reproduction.—Most crustaceans are dioecious, though the barnacles are not. The eggs are centrolecithal, undergo superficial cleavage, and from them are produced larvae, which, as in the crayfish, may be miniatures of the adults, or which, as in the shrimp, may be quite different and pass through several larval stages, thus undergoing complicated metamorphoses. The young of crabs have very prominent eyes and for this reason have received the name of *megalops*. Many crustaceans carry their eggs about attached to abdominal appendages and in some cases contained in a brood pouch. The larvae may also be so carried for a time.

303. Economic Importance.—A large number of crustaceans have been used as food, especially lobsters, shrimps, and crabs, and, in some localities, crayfish. Reese states with reference to lobsters that in Canada alone 100,000,000 have been caught in a single year. He also says that the total catch in the United States in 1892 was about 23,250,000 pounds; in 1905 it was about 11,750,000 pounds, which sold for more money than the catch of 1892. The catch in 1924 amounted to nearly 9,750,000 pounds. No more recent figures are available. The supply has been seriously depleted and efforts are being made to replenish it by the artificial rearing of young lobsters, which are liberated at places favorable for their growth. The crab-fishing industry centers about Chesapeake Bay, but there has been a serious diminution in the supply. The Gulf States furnish most of the shrimps marketed in this country and they are the most important one element in the fisheries of those states. In 1930 the value of canned shrimps and crabs, and by-products of these, amounted to over \$5,000,000; and in 1931 the amount was over \$4,000,000. These figures are from the U. S. Fish Commission; they do not include the value of the animals used in a fresh state.

304. Biogenesis.—More than a century ago Von Baer directed attention to the fact that there was a resemblance between the early stages in the life of higher Metazoa and the adults of lower forms. With the general acceptance of the concept of evolution a very natural explanation of the fact was to assume that this resemblance was due to ancestry, the lower forms having ceased to develop after reaching the condition in which they now are, and the higher forms having continued to develop but indicating in their early stages the characters of their ancestors. This conception has been termed *biogenesis* and formulated in the *biogenetic law*. Biogenesis is to be contrasted with *abiogenesis*, a term synonymous with special creation, the idea of which is that each individual form was the result of a separate creative act and when created had the characteristics it now possesses. Strong arguments for the biogenetic theory have been derived from the Crustacea.

The shrimp, *Penaeus* (Fig. 165), is a good example of the application of the biogenetic law. This organism hatches as a larva known as a *nauplius* (Fig. 164), exhibiting three pairs of appendages and a frontal eye and resembling the larvae of Crustacea generally, including those of the simpler forms. From the nauplius is produced the *protozoaea*, which has 6 pairs of appendages and rudiments of segments. From this in turn is derived the *zoaea*, which possesses 8 pairs of appendages, with 6 more developing, and has a distinct cephalothorax and abdomen. The *zoaea* changes to a *mysis*, with 13 pairs of appendages on the cephalothorax. Finally, from the *mysis* is produced the adult shrimp, which has 19 pairs of appendages. Many crustaceans pass through a nauplius stage, which may represent an ancestral type now extinct. The proto-

zoaea and the zoaea correspond also to no living forms, but the mysis resembles very closely crustaceans belonging to the genus *Mysis*, which is an ancient type still living.

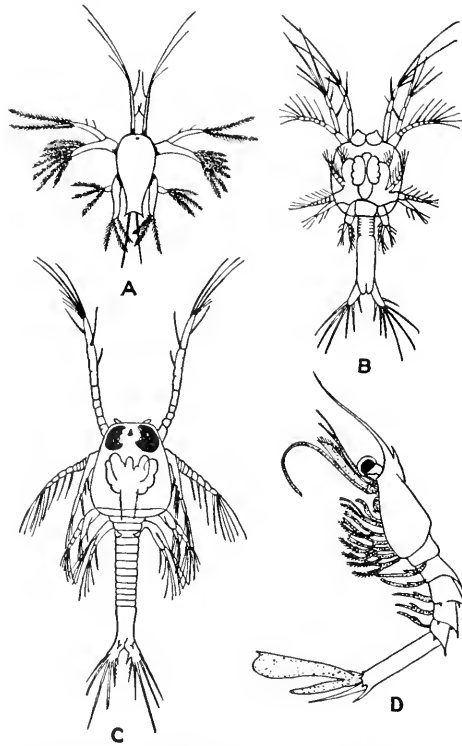

FIG. 164.—The developmental stages in the life history of a shrimp, *Penaeus* sp. A, nauplius stage. B, protozoaea stage. C, zoaea stage. D, mysis stage. Highly magnified. (From Lang, "Text-book of Comparative Anatomy," after Fritz Müller.)

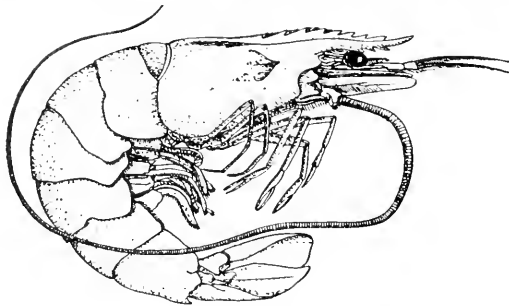

FIG. 165.—An adult shrimp, *Penaeus semisulcatus*. $\times 1\frac{1}{2}$. (From Hurley, "The Study of Zoology," after de Haan.)

Because of this correspondence, which seems to show in the higher forms a succession of stages recapitulating ancestral conditions, the biogenetic law has also been termed the *law of recapitulation*. It has

been expressed in the phrase "ontogeny recapitulates phylogeny," *ontogeny* being defined as the development of the individual, completed within a single lifetime, and *phylogeny* as the development of the race, covering, perhaps, ages of time and unnumbered generations. The biogenetic law has also been considered as illustrated by a correspondence between the egg cell and a single-celled animal; the blastula and a colonial protozoan; the gastrula and a supposed gastrula-like ancestor of the Metazoa called a *gastraea*; and the triploblastic embryo on the one hand and a triploblastic animal on the other.

This conception has been a fruitful one in its influence upon zoological progress, since it has directed attention to the broader principles underlying embryological development. However, it has also been criticized very severely because its proponents have applied it in too sweeping a manner and without due consideration of the fact that the animal kingdom represents many lines of descent and that resemblances may be the result not of common ancestry but of similar adaptations arrived at independently and adjusting unrelated forms to similar environments. It is interesting to note, in this connection, that while the shrimp possesses all those free-living larval types and thus shows a complicated metamorphosis, the crayfish, in the same group, which carries its young about on its swimmerets, shows no metamorphosis at all.

CHAPTER XLIV

ONYCHOPHORA AND MYRIAPODA

Onychophora (ón ĭ kŏf' ō rā; G., *onychos*, claw, and *phoros*, bearing) is a class of the phylum Arthropoda which in a natural classification should come first, since it is not only the simplest of the arthropods but has a pronounced resemblance to the annelids, suggesting a derivation of arthropods from annelid-like ancestors.

305. Onychophora.—The typical genus of this class is *Peripatus*, which contains numerous species reported from widely separated localities in Australia, New Zealand, Tasmania, New Britain, the Malay Archipelago, South America, Mexico, West Indies, and Africa. It is a wormlike form with a soft skin covered by papillae, each papilla bearing

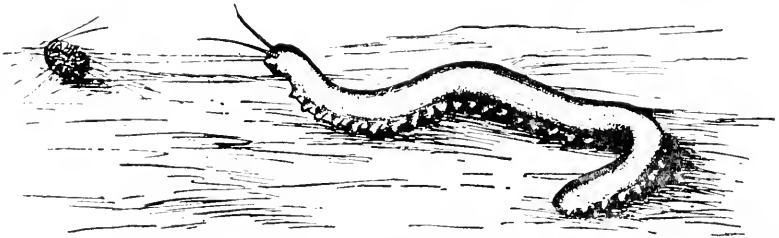

FIG. 166.—*Peripatus*; an individual shown entangling a cockroach in sticky threads formed by a secretion ejected from papillae on its head. (From Pearce, "General Zoology," by the courtesy of Henry Holt & Company.)

a spine. Metamerism is not marked externally, but there is a series of short, fleshy legs in pairs, each ending in two claws. There is also an oral papilla on each side of the mouth and a pair of simple eyes.

Peripatus shows a number of annelid-like characteristics. The skin is thin and not so heavily chitinized as in the arthropods generally, there are paired and segmentally arranged *nephridia* in all but the first two metameres, and there is a marked resemblance to the annelids in the general arrangement of internal organs. In other ways, however, it seems to be truly an arthropod, since it has *tracheae* (Sec. 311), appendages modified to form jaws, and *body cavities* which are hemocoelic. It differs, however, both from other arthropods and from annelids in having a single pair of jaws, in the texture of the skin, and in the simplicity of the metamerism.

The species of Onychophora live in crevices in rocks, under stones, and in the dark recesses of rotting logs, where they move slowly about from place to place, always avoiding the light. When disturbed a very

sticky slime is ejected from the oral papillae. This indicates that this is a weapon of defense, although it ordinarily serves in the capture of small insects and other animals used as food (Fig. 166). Owing to the velvety texture of the skin and its rich coloring, Onychophora are described by Sedgwick as animals "of striking beauty."

306. Myriapoda.—Myriapoda (mīr'ī āp'ō dā; G., *myrios*, ten thousand, and *podos*, foot) is a third class distinguished particularly by four characteristics: (1) The metameres are many, all metameres back of the head are alike in appearance, and there are numerous pairs of similar running legs; (2) the head has a pair of antennae, a pair of mandibles, and one or two pairs of maxillae; (3) the animal breathes by *tracheae* opening to the outside by metamericly arranged pores; and (4) the excretory organs are *malpighian tubules*, like those present in insects, opening into the posterior end of the intestine. The body of all myriapods is elongated, sometimes nearly cylindrical and at other times dorsoventrally flattened, rarely being compressed from side to side. Myriapods are widely distributed and flourish under a variety of conditions. The class is divided into several orders, two of which are larger and better known than the rest, one including the centipedes and the other the millipedes.

307. Centipedes.—The centipedes, or hundred-legged worms (Fig. 167), have a body which is, generally speaking, flattened dorsoventrally and which may consist of from as few as 15 to as many as 175 or even 200 metameres. Each of these metameres, except the last two and the one just behind the head, bears a pair of legs. The one next to the head has a pair of *poison claws*, or maxillipeds, by means of which the animal kills the other small animals which it uses for food.

Centipedes are active, rapidly moving myriapods living under the bark of logs and objects lying upon the ground. They are predaceous, catching and devouring any living animals which they are able to overcome. In tropical countries they reach a considerable size, sometimes a foot in length, and the bite of such a centipede is often painful, although not ordinarily dangerous to human life. A form known as the house centipede, *Scutigera*, is common in the southern United States in houses.

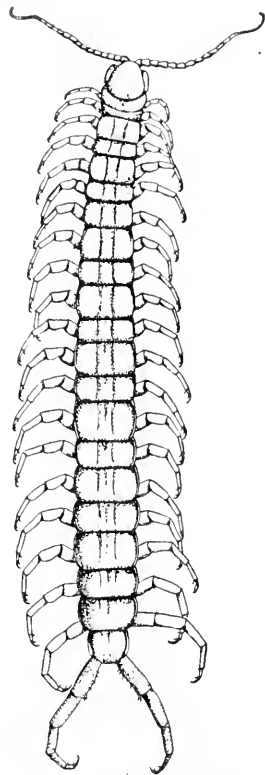

FIG. 167.—A Tropical American centipede, *Scolopendra* sp. From a dried specimen. $\times 23$.

It is slightly compressed laterally, has long legs, and runs with great speed. It is a beneficial form, since it preys upon various noxious insects, such as cockroaches and bedbugs, which live around houses.

308. Millipedes.—The millipedes, or thousand-legged worms (Fig. 168), differ from the centipedes in several ways. The body is cylindrical rather than flattened. The legs are very short, generally two pairs to a segment, and the animal tends to react by rolling up into a flat coil instead of by running away. There is a pair of mandibles and one of maxillae, and either simple or compound eyes. The millipedes also

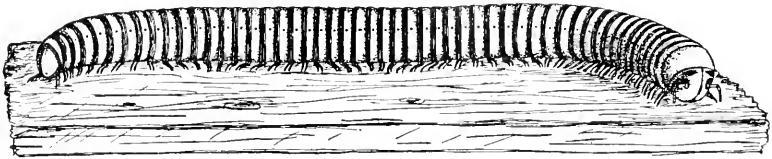

FIG. 168.—A millipede, *Spirobolus* sp., from South Carolina. From a preserved specimen. Natural size.

live in dark, moist places but feed principally upon plant food and therefore are likely to be injurious, whereas the centipedes are likely to be beneficial.

309. Reproduction in Myriapods.—In all myriapods the sexes are separate. Some millipedes are known to lay large numbers of eggs in cells excavated in the ground, which are later sealed up, but in the case of the centipedes the eggs are laid singly in the damp earth. The larva when hatched has only a few metameres and a few legs. The larvae of the millipedes have only three pairs of legs, in this respect resembling insects. As the animal grows, new metameres, each with a pair of legs, are added just in front of the posterior one. Thus the total number of metameres in the body is an indication of the age of the individual.

CHAPTER XLV

CLASS INSECTA

The fourth class of Arthropoda is Insecta (in sĕk' tã; L., *insectum*, having been cut into). The number of described species of insects is enormous; some of the more recent estimates place it as high as 600,000. It is also certain that a very large number have not yet been described. In the number of known species the class far surpasses all other animal groups combined, and the number of individuals is correspondingly large. Insects are represented everywhere on the land surface of the earth, except at the poles and at the glaciated summits of the highest mountains. They are also numerous in fresh water but are almost entirely absent from the oceans, though one type of true bug is known which occurs on the

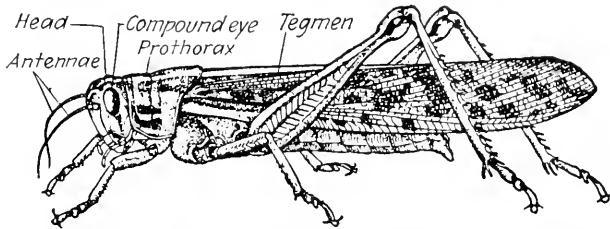

FIG. 169.—A locust, *Schistocerca americana* Drury, which may serve as a typical insect. (From Lutz, "Fieldbook of Insects," by permission.) Natural size.

surface of the sea even at a considerable distance from land. The largest insects are certain beetles, the bodies of which reach a length of more than 6 inches, and certain moths, the wing spread of which may be as great as 10 inches. On the other hand, the most minute insects known are no longer than 0.01 inch.

310. External Characteristics.—Insects agree in having three divisions of the body—head, thorax, and abdomen (Figs. 169 and 170). The metameres represented in the head are so fused as to make it difficult to determine the exact number, but the full number is considered to be six. The thorax contains three, termed in order *prothorax*, *mesothorax*, and *metathorax*, or, sometimes, called pro-, meso-, and metanotum. The first is freely movable, but the two others are fused. There is much variation in regard to the number of metameres present in the abdomen, where the posterior ones are variously modified, but the full number is considered to be 11.

The head bears a pair of *antennae*, several mouth parts, and a pair of compound eyes (Figs. 170 and 171). The antennae usually consist of

many segments but vary greatly in their length and still more in the details of form and structure. They bear a variety of sense organs which

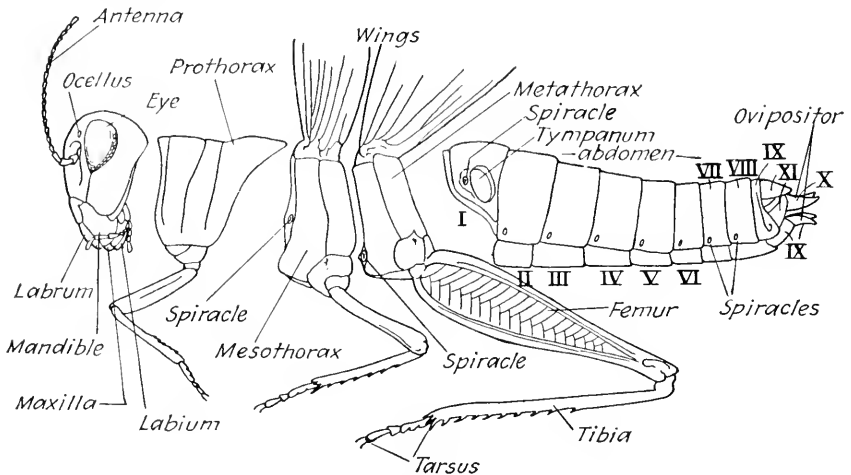

FIG. 170.—Diagram of a locust with parts of the body separated to show metameres and other structures. Abdominal metameres numbered in roman numerals. (Modified from several previous authors.)

are tactile, olfactory, or auditory in function. The difference in structure of those of the male and female frequently serves to distinguish the sexes.

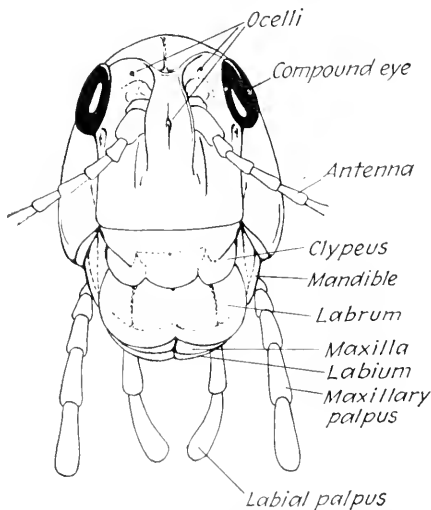

FIG. 171.—Front view of the head of a lubber grasshopper, *Brachystola magna* Girard, from Nebraska. $\times 3\frac{1}{3}$. Illustrates biting mouth parts.

The mouth parts of insects are of two distinctly different types, one fitted for biting, the other for sucking. The former are referred to as mandibulate, the latter as suctorial. *Mandibulate insects* (Fig. 171) possess an upper lip, or *labrum*, and a lower lip, or *labium*. Between these and meeting in the median line are two strong jaws, or *mandibles*, and behind the mandibles is a pair of *maxillae*. Both the maxillae and the labium bear jointed organs known as *palpi*. The mandibles are used for chewing and work transversely, the labrum and labium preventing the escape of the food from between them. The maxillae help to feed the food into the mandibles, while the palpi are sensory, sending impulses into the nervous system which determine the activity of the other mouth

parts.

parts. In *suctorial insects* (Fig. 172) a *proboscis* is present which can be thrust into the tissues of plants or other animals or which may be used in merely taking liquid from a surface. This proboscis is not developed from the same parts in different insects. In the bee it is formed by the maxillae and the labial palpi; in the mosquito, by the labrum and epipharynx; in the butterflies and moths, by the maxillae; and in other insects, in still different fashions. The adults of some insects have only rudimentary mouth parts and are incapable of feeding; this is true, for instance, of our large native silkworm moths.

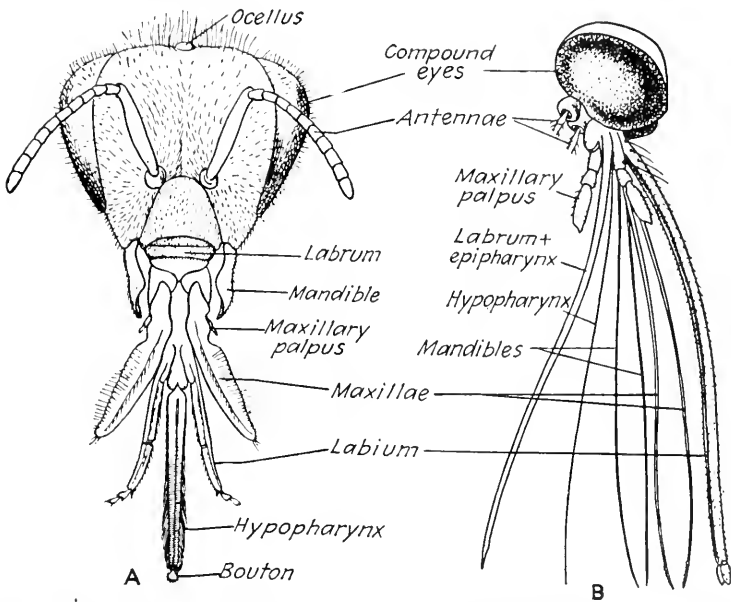

FIG. 172.—Suctorial mouth parts. A, honeybee. Head viewed from in front. (From Herms, "Medical and Veterinary Entomology," by the courtesy of The Macmillan Company.) B, head of a female mosquito, viewed from side with mouth parts separated. (From Matheson, "Handbook of the Mosquitoes of North America," by permission of the publisher: Charles C. Thomas.) Both greatly enlarged.

Insects generally have a pair of *compound eyes*, although these differ greatly in size in different types or may be absent. Some of them also possess simple eyes, or *ocelli*, placed between and in front of the compound eyes (Figs. 171 and 172).

Each of the metameres of the thorax bears a pair of legs and each of the two posterior ones, as a rule, a pair of wings. The *legs* of insects are variously modified and used in a great variety of ways (Fig. 173). Running insects generally possess long and slender legs, the three pairs being equally well-developed. Jumping insects like the locusts and crickets have extremely long hind legs, and the joint known as the femur is very large. Insects living in the water may have hind legs modified

for swimming by being broadened and paddle-like and having their area increased by hairs along the margins; or in the case of other aquatic insects, the middle pair of legs is elongated and used like a pair of oars. Some burrowing insects have the forelegs modified for digging; in the mole cricket they have a curious resemblance to the forefeet of the mole. In the mantids, and also to a lesser degree in the walking sticks, the forelegs are increased in size and fitted for grasping prey. Many insects

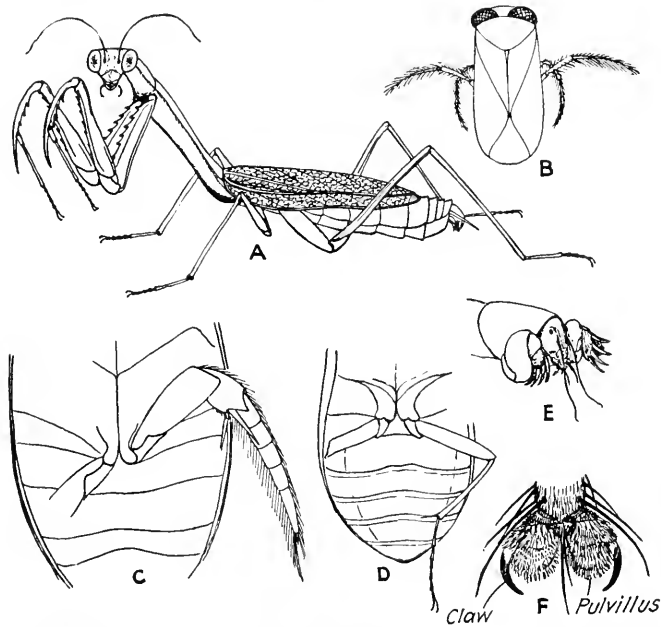

FIG. 173.—Modifications of legs in insects. *A*, praying mantis, *Stagmomantis carolina* (Linnaeus), to show forelegs modified for holding prey. Natural size. *B*, water boatman, *Corixa* sp., with hind legs used as oars. $\times 2$. *C*, part of under surface of a ground beetle, *Calosoma scrutator* Fabricius, to show hind leg fitted for running. $\times 1\frac{1}{4}$. *D*, part of under surface of a mole cricket, *Gryllotalpa hexadactyla* Perty, to show digging forelegs. About natural size. *E*, fore part of the body of a house fly to show claws and pulvilli, or pads of hairs, together with longer hairs, all for clinging. Highly magnified. (*A* to *E* from specimens; *F* from Kellogg, "American Insects," by the courtesy of Henry Holt & Company.)

cling to walls and ceilings by means of pads of hairs at the tips of the legs. When these are pressed against a surface the air is forced out and the pad holds by suction.

The great majority of insects have *wings*, though there are wingless types in a great many of the orders. The wings represent outfoldings of the wall of the body in which the two sides of the fold have come into contact and have grown together. Along certain lines, however, they have failed to unite, and in these places chitinous tubes are developed. These are called *veins*, or *nervures*; they serve to strengthen the wing and divide its surface into areas called *cells*. While wings are growing and, in

the case of insects with complete metamorphosis, while they are being expanded after emergence from the pupa, tracheae extend into the veins. Around the tracheae are spaces which are extensions of the hemocoel and which convey blood. In growing wings there are also living tissues between the two sheets of surface cuticula. When the wing becomes mature and fully expanded, however, these tissues cease to be living; respiration and circulation in the wing stop; and the appendage becomes a hard, dry structure, which is moved as a whole by muscles within the body.

There are a great many modifications of wings shown in several of the accompanying figures. Sometimes they are soft and membranous, at other times heavily chitinized and very rigid. Examples of the latter type are the anterior wings of the beetles, known as *elytra*, and of the locusts, known as *tegmina*; in both cases these wings serve as protecting sheaths for the folded posterior pair of membranous flight wings when the latter are not in use. In the flies the hind wings are reduced to minute threadlike rods tipped with knobs and known as *halteres*, or balancers (Fig. 174).

Insects generally possess *tracheae*, or breathing tubes, which open to the outside by laterally placed *spiracles* (Fig. 170). Spiracles are elliptical openings each guarded by two flaps, which may be closed to prevent the entrance of dust. The number of spiracles varies in different types, though there is only one pair to a metamere. The number of metameres which may have them is 11, including the prothorax, the mesothorax, the metathorax, and the first 8 metameres in the abdomen. They are always lacking, however, in one or more of these metameres, and the maximum number present is 10 pairs.

The abdomen of insects never bears true appendages but may in aquatic forms have tracheal gills along the sides or at the posterior end of the body. These gills may be threadlike or leaflike or may be much branched. In them is a network of tracheae between the cavities in which and the water is an interchange of gases.

The terminal metameres of the abdomen are often greatly modified, being reduced in size and forming parts which enter into various types

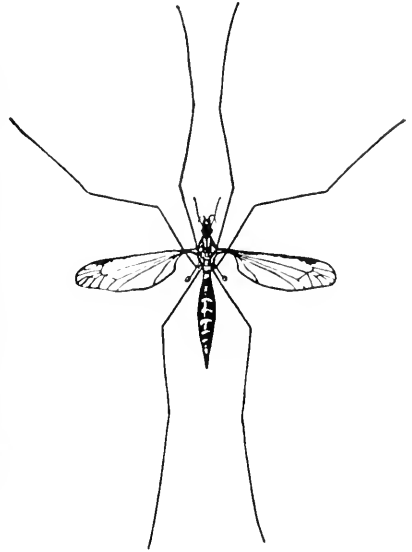

FIG. 174.—A crane fly, showing the modified hind wings or halteres. Male, adult. (From Sanderson, "Insect Pests," after Weed, by permission.) About natural size.

of apparatus used in copulation, egg laying, or stinging. This results in a lessening of the apparent number of metameres.

311. Internal Structures.—The body cavities of an insect are not truly coelomic but are parts of a *hemocoel*. A *heart* lies under the dorsal wall of the abdomen and blood circulates through these hemocoelic spaces. The circulation is not so important as in most animals, however, since it plays practically no part in respiration. When the body of an

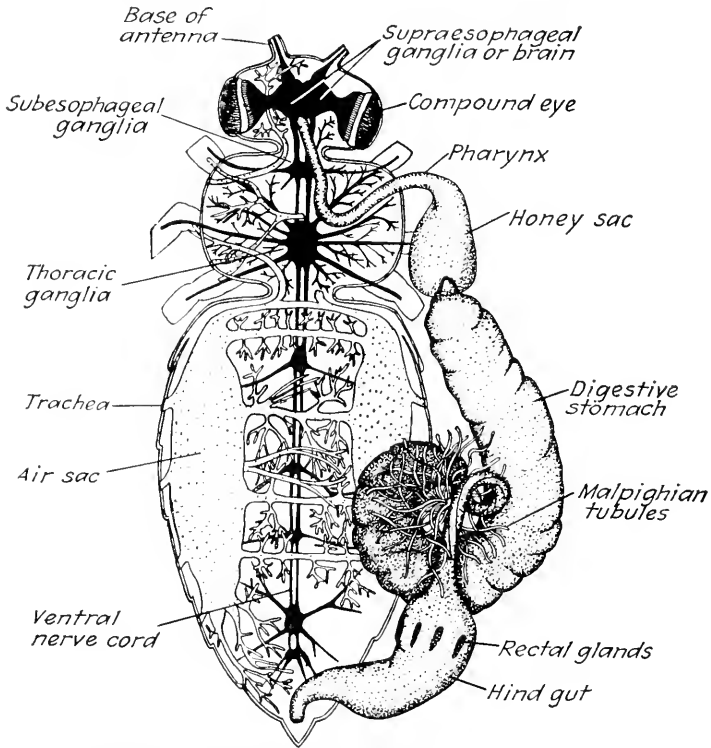

FIG. 175.—A honeybee dissected to show the digestive, nervous, and tracheal systems. (From Leuckart wall chart.) Illustrates the digestive system of a suctorial insect.

insect is opened, many white glistening tubes are seen. These are the *tracheae*. They are held open by rings of chitin, branch repeatedly, and the finer branches reach all parts of the body. In insects of active flight the tracheae are dilated in certain places and form *air sacs* (Fig. 175). By means of this system of tubes oxygen is conveyed directly to the tissues of the body and carbon dioxide is carried away. Although the blood contains both oxygen and carbon dioxide it is only in the amount that any tissue would have. In some cases aquatic forms do not possess gills, but water is taken into the posterior end of the alimentary canal, the wall of which is lined with papillae supplied with tracheal tubes.

The alimentary canal is modified according to the character of the food. A mandibulate insect (Fig. 176) usually possesses an *esophagus*, which may be dilated posteriorly to form a *crop*; a muscular gizzard, or *proventriculus*, which grinds the food and also strains it; a digestive stomach or *ventriculus*, which receives the secretion from a number of gastric glands, or caeca; and an *intestine*, which receives the digested food and into which also open the tubular organs of elimination, the *malpighian tubules*. Suctorial insects do not have a gizzard, but in place of it they have a muscular *pharynx* which acts as a pump and a sac for the storage of juices (Fig. 175).

The nervous system of insects is similar in general plan to that of the earthworm, but there are two *ventral nerve cords* (Fig. 175). The two ganglia of each pair are separated and communicate by a commissure. In the lower insects there is a pair of ganglia to each segment, but in the higher forms the number is reduced. In the latter forms the thoracic ganglia are increased in size and the supraesophageal and subesophageal ganglia are not only increased in size but tend to be brought together by the shortening of the circumesophageal connectives. This results in such a degree of centralization and cephalization that these anterior ganglia may properly be called a *brain* (Figs. 175 and 177). Their removal interferes with the coordination of movements and results in death, though this is not immediate.

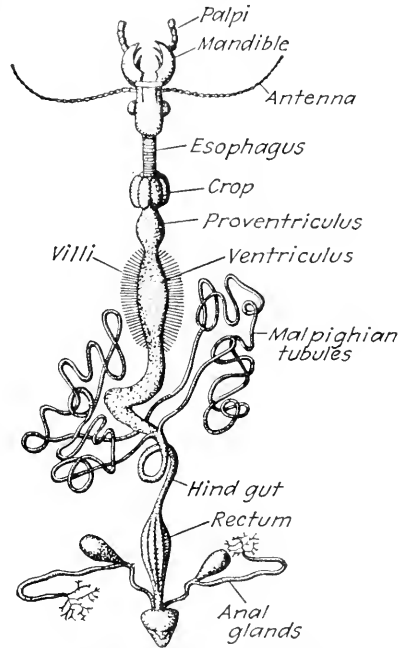

FIG. 176.—Digestive system of a beetle, *Carabus auratus* Linnaeus, as an example of a mandibulate insect. (From Lang, "Text-book of Comparative Anatomy," after Dufour.)

312. Senses of Insects.—Insects possess a great variety of sense organs and several may serve for the reception of the same general type of stimulus. The compound eyes and ocelli are both organs of sight, although the exact function of the latter is not well understood. The compound eye of an insect is similar to that of the crayfish. The sense of smell is highly developed in insects though olfactory organs are known to exist only on the antennae. On the palpi and about the mouth are organs of taste. Tactile organs are located on the antennae and elsewhere about the body. That insects have a sense of hearing is indicated by the variety of sounds they produce. Sometimes these are

the result of rubbing rough surfaces together. The locust rubs the femora of the hind legs against the outer surfaces of the tegmina or produces the crackling sound heard in flight by rubbing the front edges of the hind wings against the tegmina. The shrilling of a cicada is due to the vibration of a stiff chitinous membrane drawn across a sound chamber; this vibration is controlled by muscels. The buzzing of many insects is due to rapid vibration of the wings. The auditory organ of a locust is a pit, or *tympanum*, on the first abdominal metamere, closed by a thin kidney-shaped tympanic membrane (Fig. 170). Organs believed to be auditory also exist on the antennae of many insects and on

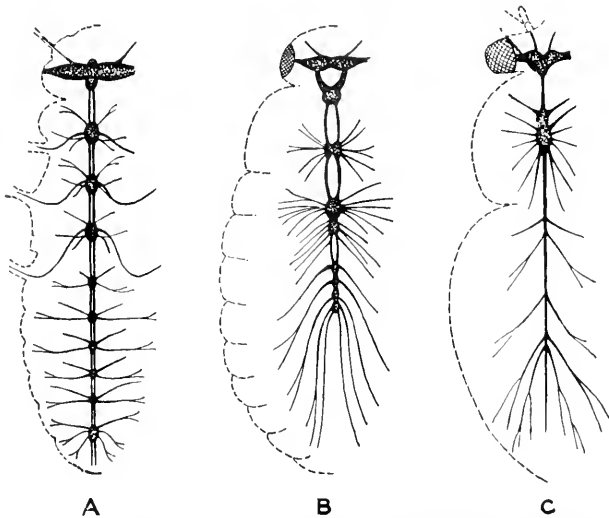
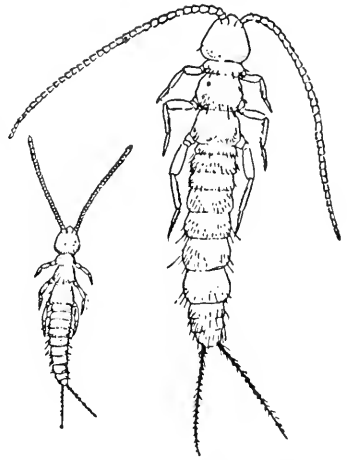

FIG. 177.—Nervous systems of three insects to illustrate condensation and cephalization. A, a termite, one of the lowest insects. B, a water beetle. C, a fly, the highest type. (From VanCleave, "Invertebrate Zoology." A after Lespès, B and C after Blanchard, by the courtesy of McGraw-Hill Book Company, Inc.)

the legs of katydids. A few insects, especially the larvae and adults of certain beetles known respectively as glowworms and fireflies, are luminescent. The emission of light, like the utterance of sounds, probably serves to bring the sexes together.

313. Reproduction.—Insects are always diceious. The eggs, which are fertilized internally, undergo superficial cleavage and develop much as do those of the crayfish. From the egg hatches a larva which differs in character in the various groups. Most of the insects exhibit a *metamorphosis*. Only a few do not do so, and these are termed ametabolous (Fig. 178) and are grouped together as *Ametabola* (ăm ē tăb' ō lâ; G., *ametabolos*, unchangeable). Most of them pass through several stages, but the number of stages varies. In all insects the larval form is the period during which growth takes place, no insect growing after it has become adult.

In many cases the *larva* bears a considerable degree of resemblance to the mature insect, being hatched, however, with a relatively large head and small thorax and abdomen and frequently with no more than rudiments of wings. As successive molts occur the proportions of the body gradually change and the wings increase in size. The stages which follow the successive molts are called *instars*. The last molt transforms the larva into an adult in which the regions of the body have acquired the adult size and proportions and wings have become of full size and functional. Thus in this type of insects there is no stage corresponding to the pupa, and the metamorphosis is termed incomplete. *Incomplete metamorphosis* (Fig. 179) occurs, generally speaking, in the lower insects, and those which have it are called Hemimetabola (hēm ĩ mē tāb' ō lā; G., *hemi*, half, and *metabole*, change) or Heterometabola (hēt ēr ō mē tāb' ō lā; G., *heteros*, different, and *metabole*, change), the latter because metamorphosis is varied in character in different types. Usually the larvae of insects with incomplete metamorphosis are termed *nymphs*, and sometimes those of such of these as are aquatic, *naiads*. There is a more pronounced change when a naiad, which carries on aquatic respiration, becomes an air-breathing adult than when the nymph of a terrestrial form changes into the adult insect.



A third group of insects, according to development, is Holometabola (hō lō mē-tāb' ō lā; G., *holos*, whole, and *metabole*, change). These pass through a *complete metamorphosis*, which includes both a larval and a pupal stage (Fig. 180).

The larva of a butterfly or a moth is called a caterpillar; that of a beetle, a grub; that of a fly, a maggot; and those of other groups have still other names. During the larval period organs may develop which are peculiar to that stage in the life history of the animal. At the close of the larval period a *pupa*, or chrysalis, is formed, which is covered with a hard shell. During the pupal stage the greater part of the organs of the larva undergo degeneration, the organs of the adult developing in their stead. However, the nervous system is not thus "scrapped," nor are the reproductive organs. Most pupae are inactive, but some are able to move about by flexion and extension of the body or by using the spines on the movable metameres as levers.

FIG. 178.—Young and adult of *Campodca staphylinus* Westwood. The simplest living insect, and an example of Ametabola. (From Kellogg, "American Insects," by the courtesy of Henry Holt & Company.) $\times 11$.

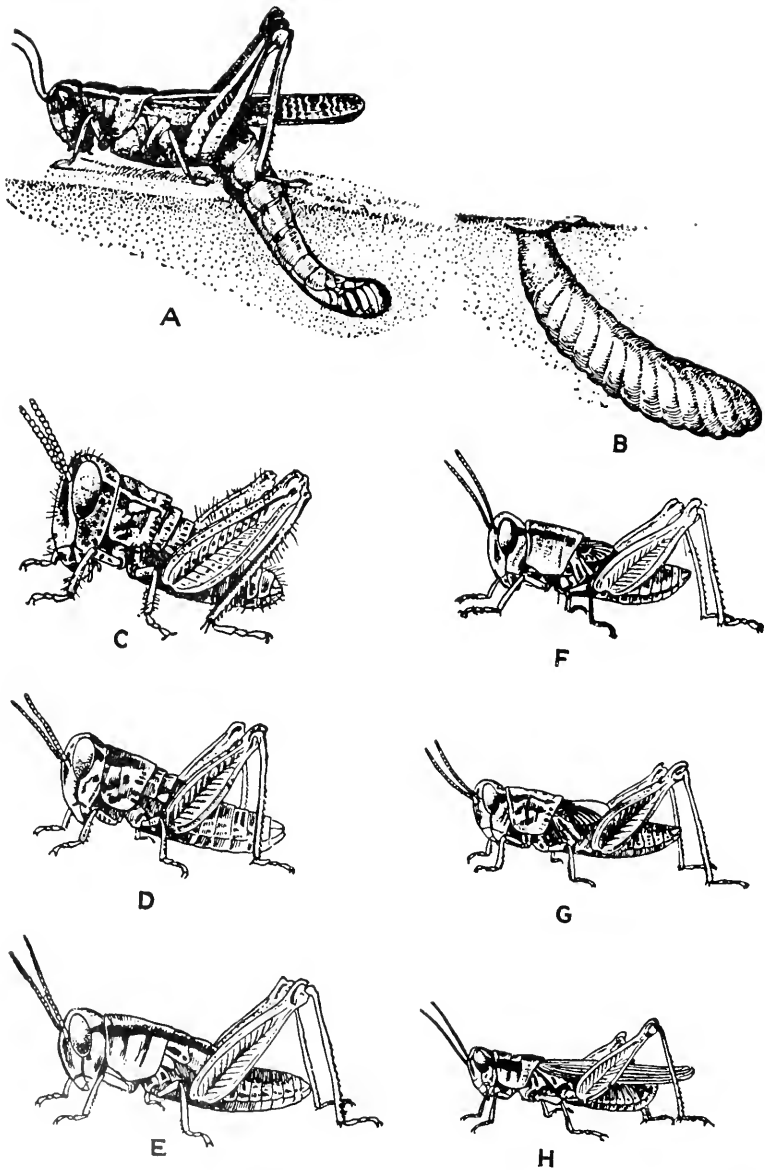

FIG. 179.—Life history of a hemimetabolous insect, a locust. *A*, oviposition. *B*, egg mass in the ground. (From Walton, *Farmers' Bull.* 747, *U. S. Dept. Agr.*, *A* after Webster.) *C* to *H*, stages in the development of the red-legged locust, *Melanoplus femur-rubrum* De Geer. *C*, just hatched; *D*, after first molt; *E*, after second molt, showing beginning of wing pads; *F*, after third molt; *G*, after fourth molt; *H*, adult. *C* to *G* enlarged, *H*, natural size. (From Kellogg, "*American Insects*," after Emerton, by the courtesy of Henry Holt & Company.)

Some insects exhibit in their life history even more than the four stages—egg, larva, pupa, and adult. In some beetles there are two types of larvae, one with legs and caterpillar-like, the other without them and maggot-like, and one of these types follows the other. This condition is known as *hypermetamorphosis*. In other cases a subimago stage precedes the adult, or *imago* stage, the change from subimago to imago involving a molt and a modification of certain details of structure.

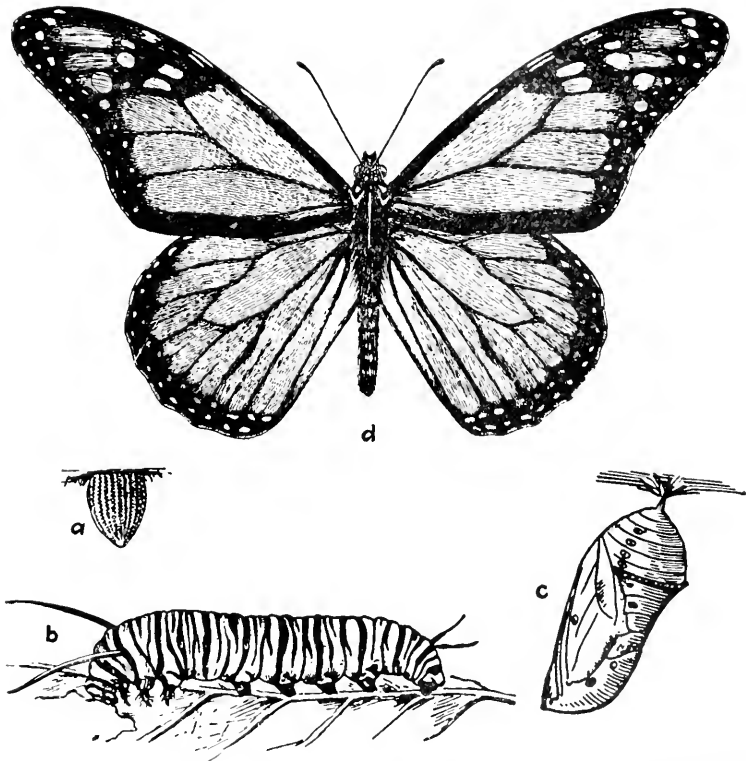

FIG. 180.—Life history of a holometabolous insect, a butterfly, *Danaus archippus* Fabricius; a, egg; b, larva; c, pupa; d, adult. Natural size. (a to c from Jordan and Kellogg, "Animal Life," by the courtesy of D. Appleton & Company; d, from a specimen.)

314. Autotomy.—Some insects possess the power of autotomy, but regeneration is known to occur regularly only in the walking sticks. An example of autotomy is presented by the locust; if held by the hind leg and pressure is made on the femur, it will break off this leg. Termites and ants have deciduous wings, which are shed after swarming.

315. Injuries Due to Insects.—Insects affect man injuriously in a great many ways. They may annoy him by their presence or by their bites or stings. The insect may be poisonous and its attack may cause effects which are painful though rarely of themselves serious. Insects may also be the means of transmitting disease-producing organ-

isms. They may injure man by affecting in similar ways his domestic animals. Insects may destroy grain, fruit, and vegetable crops or ravage forests, and they are the cause of serious damage to a great variety of manufactured products. The annual losses due to insect pests in the United States have been estimated in recent years at close to \$1,000,000,000.

316. Benefits from Insects.—To offset these injuries some benefits are to be credited to insects. Perhaps the most prominent benefit is the destruction of injurious insects by certain others which thus become beneficial. Some insects themselves are made use of by man, examples being blister beetles, used in medicine, and the cochineal insect, which is a source of coloring matter. The products of insect work, such as the silk of the silkworm and the honey and wax of bees, may also be utilized. A few insects are used by uncivilized races as food. A very curious use of ants by the Indians in South America, described by Bruner, is in a sort of surgical procedure where they serve in place of sutures in holding the margins of wounds together. The ants used are large and have powerful jaws. Bringing the margins of the wound together with one hand, the "surgeon" holds the ant with the other and permits it to bite through the two margins. When the jaws are locked, the body is torn from the head and the locked jaws remain in position until healing has closed the wound. Then they are removed. In this country and in Europe, fly maggots have recently been made use of in surgery. Introduced into wounds in which there is a considerable amount of dead and decaying tissue, they remove this, thus paving the way for the filling in of the wounds by regenerating healthy tissue.

One relation of insects, which is important in the preservation of the normal checks and balances which regulate all animal life, is that they form a very large part of the food of other animals, particularly birds. Their abundance under normal conditions provides an adequate food supply for such animals, many of which themselves are of great value. Some of these economic relationships will appear in the discussions which follow.

317. Injurious Types.—Some of the more common and familiar of the injurious insect types may be briefly reviewed. The food of the termites (Fig. 181) consists of dead wood; they sometimes attack piled lumber, and in the tropics they are a scourge because of their attacks on dwellings, furniture, and all other articles made of wood. In the Eastern states their ravages, however, are chiefly observed in the tunneling of dead logs in forests. Termites shun the light except when a new brood of winged individuals swarms, mating occurs, and new colonies are established. If lumber is removed from contact with the ground and placed upon cement blocks or stones, making it necessary for the termites to come to the light to reach it, the wood will not be attacked, as it would be if placed upon

wooden blocks or directly upon the ground. It has long been a source of speculation as to how these insects can digest the cellulose of the wood, which few other animals are able to do. It has recently been discovered that it is because of the presence of symbiotic intestinal Protozoa which change the cellulose so that the termites can use it. In the absence of this protozoan the termite is helpless and dies, and the protozoan seems not to flourish outside the alimentary canal of the termite.

Being vegetable feeders and likely to attack growing crops, locusts have affected man since the very beginning of agriculture. Migrations

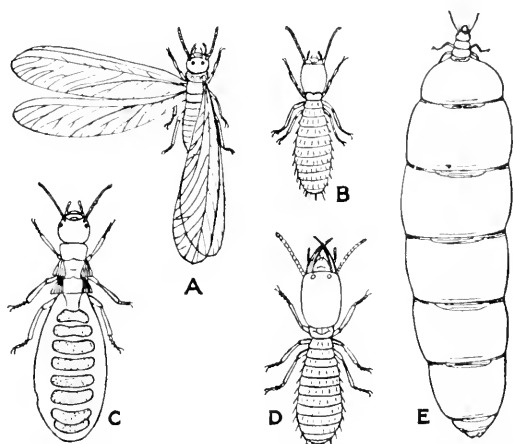

FIG. 181.—A termite, *Reticulotermes flavipes* Kollar. A, winged male. B, larva. C, dealated queen. D, soldier. E, queen of a tropical African species. (A to D, from Bruner, "Study of Entomology," after Riley; E, from Kellogg, "American Insects," after Nassonow, by the courtesy of Henry Holt & Company.) A to D, $\times 4$; E, natural size.

of locusts from arid regions into those under cultivation have frequently been recorded in history, accompanied by marked economic results, in some cases even causing large numbers of people to move from the region thus affected. Locusts belong to the order Orthoptera (ōr thōp' tēr ā; G., *orthos*, straight, and *pteron*, wing), which also includes cockroaches, mantids, walking sticks, katydids, and crickets.

Many different types of insects are known as lice. What are called biting lice are found on birds and mammals. They do not bite their hosts but eat feathers, hairs, and epidermal scales. Their presence on the animal, however, occasions irritation, and it is to allay this irritation that birds are in the habit of dusting themselves. The sucking lice possess probosces which can puncture the skin of their hosts, which are birds and mammals. They attack domestic poultry but come upon them only at night, hiding in crevices in the poultry houses during the day.

The term bug in its proper sense is applied only to the Hemiptera (hē mīp' tēr ā; G., *hemi*, half, and *pteron*, wing). Among terrestrial bugs are bedbugs, chinch bugs, squash bugs, and a variety of others, which are all injurious for one reason or another. Chinch bugs, which have been very destructive to small-grain crops in the Mississippi valley, have been controlled most successfully by means of a contagious disease

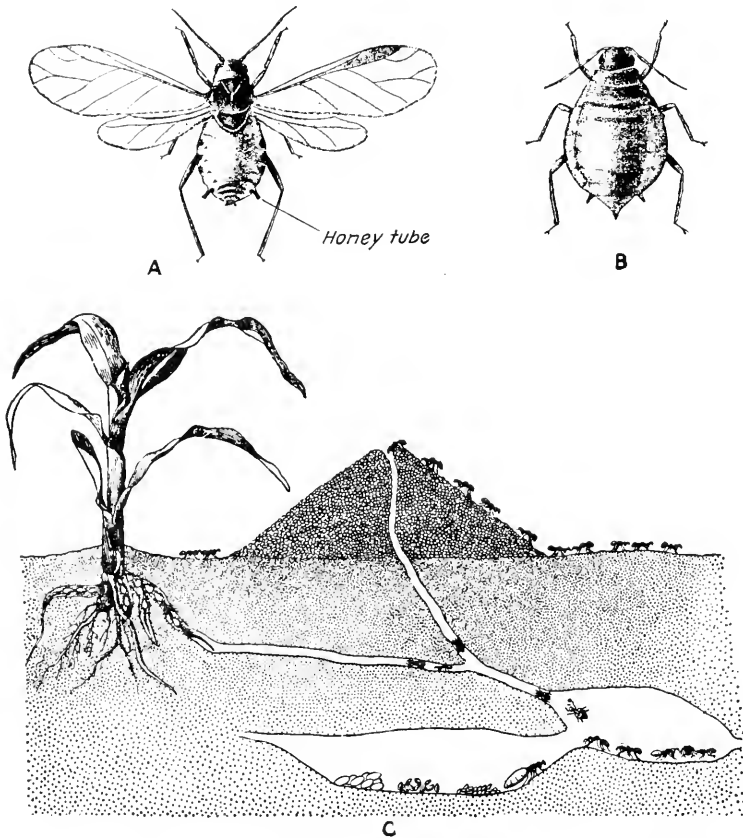

FIG. 182.—The corn-root aphid, *Anuraphis maidiradicis* (Forbes), the eggs and larvae of which are cared for by the brown ant, *Lasius niger* var. *americanus* (Emery). A, the winged form. B, the wingless form. Both much enlarged. C, diagram to illustrate the care of the adults by the ants during the winter and their placing them on the roots of the young corn plants in the spring. (From Davis, *Farmers' Bull.* 891, U. S. Dept. Agr.)

spread among them by releasing in the fields artificially infected bugs. Aquatic forms include the water boatmen, back swimmers, and water striders, which skate about on the surface of water upheld by the surface film.

The order Homoptera (hō mōp' tēr ā; G., *homopteros*, having similar wings) is related to Hemiptera. In it are the plant lice, or aphids. They are small but they exist in enormous numbers, since many partheno-

genetic female generations occur during the summer. In the fall males are produced and fertilized eggs are laid which hatch out in the spring, starting the first of another series of parthenogenetic female generations. Most plant lice (Fig. 182) are wingless, though there are winged females. They are often very injurious to plants, puncturing the leaf or stem and sucking the sap. Many of these excrete a sweet substance known as honeydew which is eaten by ants and other insects. The bodies of others are covered with a white, cotton-like substance, also an excretion.

In the order Homoptera belong also the cicadas or harvest flies. Among these are the longest-lived of insects, the seventeen-year cicada living as a nymph for seventeen years before emerging as an adult. These insects lay their eggs in slits made by the female in the twigs of

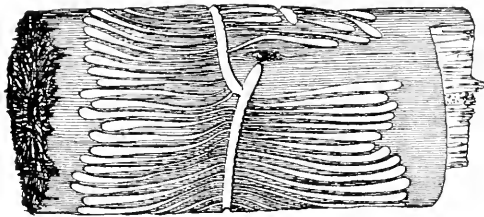

FIG. 183.—Work of an engraver, or scolytid, beetle, in a box elder limb. The female beetle bores through the bark and then makes tunnels between the bark and wood. She deposits eggs from time to time and the larvae hatched from them begin lateral tunnels which increase in size as the larvae grow. When fully grown the larvae change to pupae at the end of the burrows they have formed and when the beetles emerge they eat through the bark and make their escape. In the specimen from which the figure was drawn is evidence that when the female encountered a knot, she backed up and started a tunnel at an angle which caused her to avoid the obstacle. Natural size.

trees. When hatched the nymphs drop to the ground, burrow into it, and live in chambers on the roots, feeding upon the sap.

The order Coleoptera (kōl ē ōp' tēr ā; G., *koleopteros*, sheath-winged), which includes the beetles, contains many destructive forms. Among these are borers in the trunks and limbs of trees (Fig. 183) and stems of other plants; and the leaf beetles, which destroy foliage. The potato beetle is a leaf beetle. Weevils attack seeds and fruits, carpet beetles injure rugs and carpets, and wireworms damage the roots of plants. Both the larvae and imago of beetles cause damage.

The order Lepidoptera (lēp ĩ dōp' tēr ā; G., *lepidos*, scale, and *pteron*, wing) includes butterflies and moths, which are destructive only in the larval stage. The larvae of some are borers in the stems of plants and those of others eat the foliage. Among those affecting trees are the larvae of the tussock and gypsy moths, the webworm, and the cankerworm. The army worm, the cotton worm, and the corn bollworm injure field crops. The codling moth attacks the fruit of the apple (Fig. 184). The clothes moth is injurious to clothing and other articles made of wool, to furs, and to feathers, and the grain moth destroys stored grain. Most

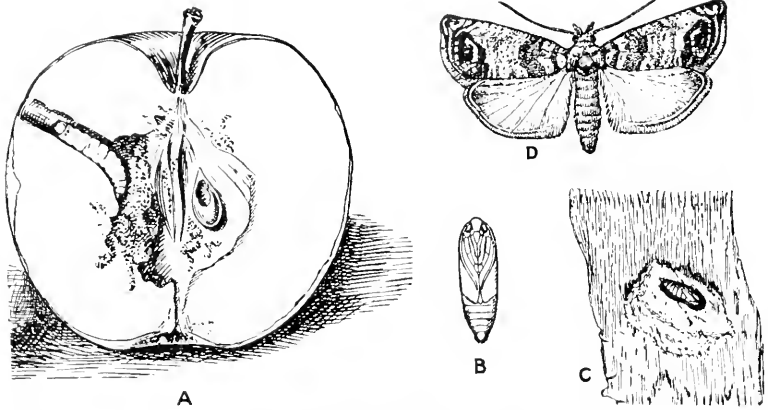

FIG. 184.—Codling moth, *Carpocapsa pomonella* Linnaeus. (From *Farmers' Bull.* 171, by Simpson, and 283, by Scott and Quaintance, *U. S. Dept. Agr.*) A, larva, working in an apple. B, pupa. C, pupa in cocoon. D, adult. A, B, and D, $\times 1\frac{1}{2}$; C, $\times \frac{1}{2}$. The moth lays eggs in the eyes at the blossom ends of young apples and the larvae which hatch from them burrow into the apple, where they pass the larval period. After the apple falls, the larva leaves it, seeks a sheltered crevice, such as a crack in the bark, or under an object on the ground, and forms a silken cocoon, within which it changes to a pupa.

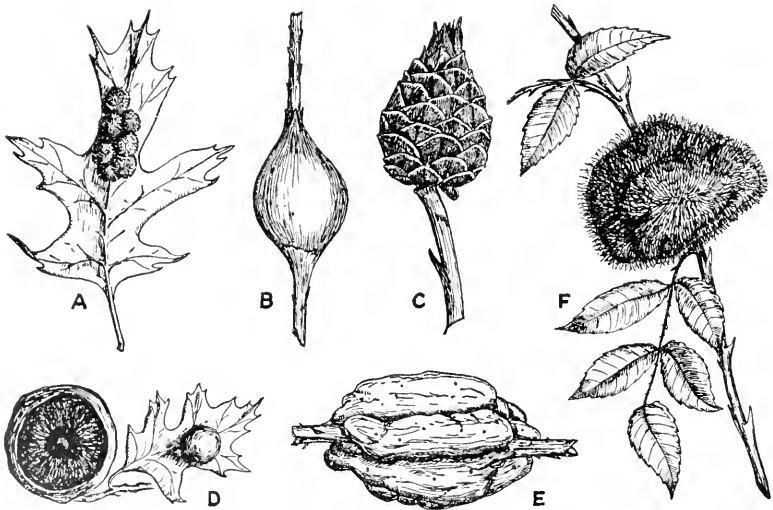

FIG. 185.—Plant galls due to insects. A, galls on oak caused by a gall wasp, *Dryophanta tanata* Gill. B, a gall on a goldenrod stem caused by a gall fly, *Eurosta solidaginis* Fitch. C, a gall developed on the end of a willow shoot and caused by a gall fly, *Rhabdophaga strobiloides* Walsh. D, a so-called oak apple, caused by a gall wasp, *Amphibotips conflucens* Harris. E, a blackberry gall, caused by a gall wasp, *Diastrophus nebulosus* Osten Sacken. F, a rose gall caused by a gall fly, *Rhodites rosae* (Linnaeus). All about natural size. (A to E from Metcalf and Flint, "Fundamentals of Insect Life," after Felt, by the courtesy of McGraw-Hill Book Company, Inc.; F from Comstock, "Manual of the Study of Insects," by the courtesy of Comstock Publishing Company.)

of the moths, and some of the butterflies, form cocoons as protective coverings for the pupae, and the same is true of some other insects, including beetles. A *cocoon* may be constructed by the cementing together by the larva of the hairs of its own body or objects of various kinds, including grains of sand or bits of vegetation. It may also be made of silk spun by the larva from a secretion formed by silk glands.

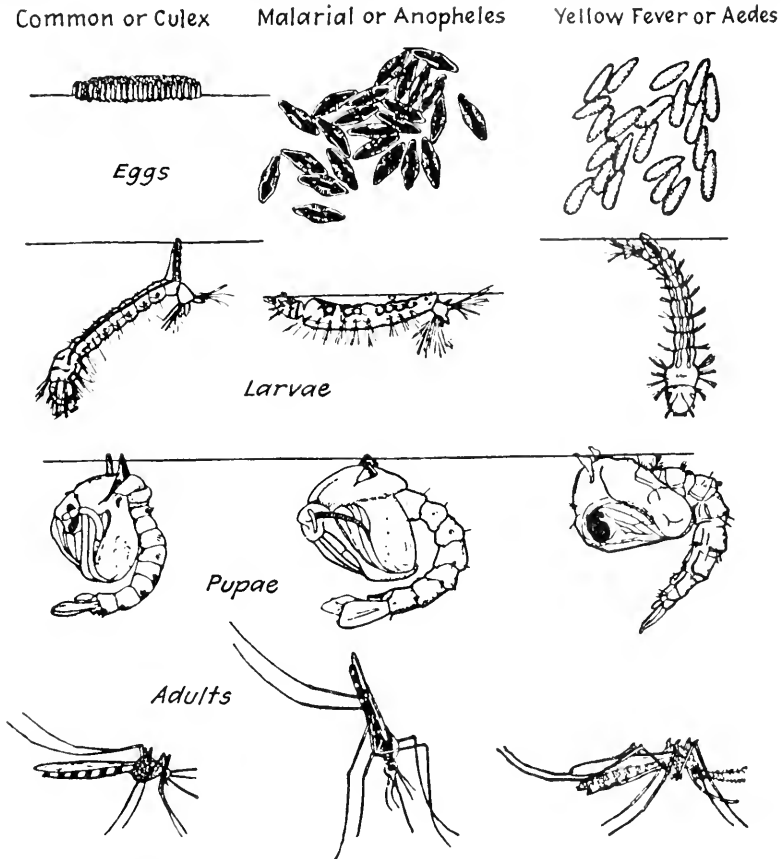

FIG. 186.—Comparison of three important kinds of mosquitoes, *Culex*, *Anopheles* (Sec. 114), and *Aedes*, showing eggs, larvae, pupae, and adults. $\times 2$ or 3. (From *Mitcalf and Flint, "Destructive and Useful Insects,"* after *Pieper and Beauchamp*, by the courtesy of *Scott, Foresman and Company*.) *Aedes* transmits yellow fever. The horizontal lines indicate water level; the stages of each type are in a vertical column.

The gall wasps, belonging to the order Hymenoptera (hī mēn ǒp' tēr à; G., *hymenopteros*, membrane-winged), and the gallflies, belonging to the Diptera, are small and rarely noticed, but the results of their work are frequently conspicuous (Fig. 185). They possess an ovipositor with which they pierce plant tissues and deposit eggs. Either poison injected at the time of the laying of the egg or irritation arising from the growth

of the larva causes a hypertrophy, or overgrowth, of the plant tissues and results in the production of conspicuous swellings on the stems or leaves. These growths are *galls*. Galls are also produced in other ways, and the study dealing with them is a subject by itself known as *cecidology*.

The Diptera (dīp' tēr ā; G., *dipteros*, two-winged), or flies, have only the forewings developed and functional. Among them are the mosquitoes, which are annoying because of their bites but which are more important because of the part they play in the transmission of diseases. Mosquitoes (Fig. 186) lay their eggs on the surface of the water, the larvae feeding upon organic matter contained in it. In this way they help to clear up the water of stagnant pools. The larvae, or wrigglers, have

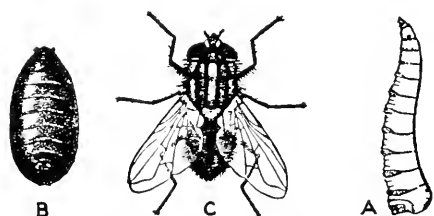

FIG. 187.—House fly, *Musca domestica* Linnaeus. A, larva. B, pupa. C, adult. $\times 4$. (From Howard, *Farmers' Bull.* 459, U. S. Dept. Agr.)

an air tube at the posterior end of the body through which they can obtain air for breathing. At frequent intervals they wriggle their way to the surface and thrust this tube through the surface film to take in oxygen and throw off carbon dioxide. The oxygen lasts them for a time, but its exhaustion makes another trip to the top necessary. The pupa spends much more of its time at the surface, breathing through two tubes at the anterior end. When the adult emerges it rests upon the surface of the water until its wings are expanded and dried, and then it flies away. Only the females, which may be recognized by their simple antennae, suck blood. The males, which have feathered antennae, are not known to feed at all. In the absence of blood the females make use of nectar or juices of plants, and it is possible that the males may at times use the same food. The larvae of mosquitoes may be destroyed by coating the surface of the water with oil, which gets into the breathing tubes and kills them by suffocation. The numbers of mosquitoes may also be reduced by draining off water standing in barrels, cans, or other receptacles, which offers opportunity for the development of the larvae.

The house fly (Fig. 187), which also belongs in the Diptera, is an abundant insect and exceedingly dangerous, since it carries disease germs upon its feet and its habit of alighting upon moist masses of all kinds results in its transferring them to human food. It is thus known to transmit typhoid fever and tuberculosis. The larva feeds in manure and other filth. The insect may be controlled by covering the receptacles for such material and by the use of poisons and traps. It should be kept out of houses and away from food by the use of screens.

Fleas make up another insect order. Since they are suctorial and attack man, they are also transmitters of human diseases. The rat

flea seems to be the agent in the transmission of bubonic plague from rats to man.

318. Combating Injurious Insects.—Injurious insects may be combated in many ways. Mandibulate insects can be destroyed by placing poisoned food where they will get it or by spraying poisons in solution on the leaves or fruit of plants which they eat. This method can be applied in the case of cockroaches, crickets, earwigs, ants, beetles, and lepidopterous larvae. Suctorial insects may be sprayed with oily substances which close the spiracles and cause suffocation, or if they are in a room where they can be reached with poisonous gases, they may be destroyed by fumigation. Insect powders usually produce their effects by being

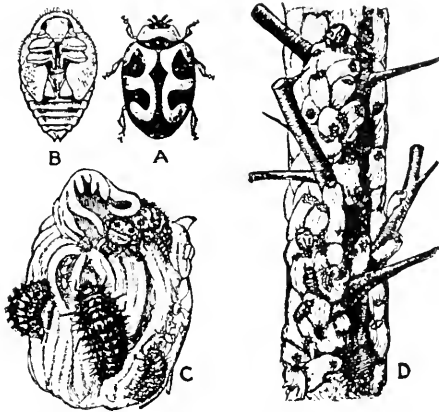

FIG. 188.—Australian lady-beetle, *Rodolia cardinalis* Mulsant, and the scale insect on which it feeds, *Icerya purchasi* Maskell. A, the adult beetle; B, the pupa; C, larvae feeding on the scale insect; D, a twig of orange, showing the scale lice, and larvae and adults of the beetle. A to C, $\times 4$; D, natural size. (From Marlatt, Year-book, U. S. Dept. Agr., for 1896.)

breathed into the tracheal tubes. In some cases insect pests may be secured in numbers by jarring the plants and collecting them in appropriate hoppers, after which they may be killed in the manner most convenient. Insects may be trapped in a number of ways and may be combated by the spreading of infectious diseases among them. The most important factor in insect control, however, is their destruction by birds, and to this end insectivorous birds should be zealously protected.

319. Beneficial Insects.—Both the larvae and the adults of the order Odonata (\bar{o} $\bar{d}\bar{o}$ $\bar{n}\bar{a}'$ $\bar{t}\bar{a}$; G., *odontos*, tooth), which includes the dragon flies and damsel flies, are carnivorous, the adults being beneficial because of their destruction of mosquitoes, which form a large part of their food.

Some beetles are beneficial because they attack injurious insects. Among these are the tiger beetles and ground beetles, which live upon the ground and destroy cutworms and other noxious insects which they can capture. Ladybirds, or lady beetles, are very beneficial because of their

destruction of plant lice and scale insects, both the larvae and adults being eaten by them. The orange growers of California, when made desperate by the ravages of a cottony scale insect which threatened ruin to their orange groves, were able to overcome the pest by the help of ladybirds imported from Australia (Fig. 188). Here also are to be considered the burying and the carrion beetles, which bury or destroy dead animals and organic matter which might otherwise prove offensive.

The order Neuroptera (nū rōp' tēr ā; G., *neuron*, nerve, and *pteron*, wing) includes the lace-winged flies, sometimes called aphid lions because the larvae, as well as the adults, feed on plant lice. Their eggs are laid

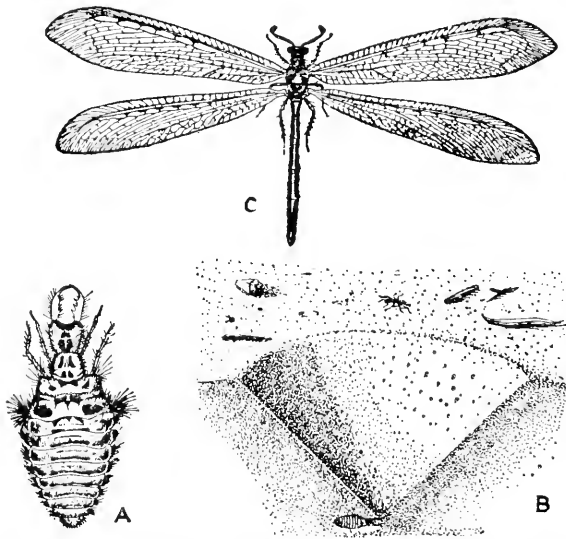

FIG. 189.—Ant lion, *Myrmelcon* sp. A, larva, $\times 2$. B, pit, with concealed larva, $\times 2_3$. C, adult, slightly enlarged. (A and C from Kellogg, "American Insects," by the courtesy of Henry Holt & Company; B, original.)

on plants and mounted on a long stalk, which insures immunity from the attacks of enemies. The order also includes the ant lions, the larvae of which live in the ground, concealed at the bottom of conical pits (Fig. 189). They feed upon insects which when running over the ground fall into these pits. The victim slides to the bottom of the pit, where it is seized by the ant-lion larva and sucked dry, after which the body is thrown clear of the pit by a jerk of the head of the captor. The pits are excavated by the throwing out of the grains of earth in a similar fashion and naturally are found only in loose, sandy soil. They are also placed under overhanging ledges of rock or under vegetation where they are protected from rain. Frequently many occur within a small area. The pits increase in size with the growth of the larva until they reach a diameter of from two to three inches.

Some Lepidoptera are useful because their visits to flowers result in cross-pollination. Chalcid flies and ichneumon flies, which belong to the Hymenoptera, are beneficial because they attack the developmental stages or the adults of many injurious insects. The egg is laid on or in the host the soft tissues of which the developing larva destroys. The larva of one ichneumon fly attacks the borers in shade trees, and the fly is often seen laying its eggs in the trunks and larger limbs of such trees (Fig. 190). It is $1\frac{1}{2}$ inches long and has an ovipositor 6 inches long, with which it drills a hole through the wood into the burrow of the boring larva where it deposits an egg. Many seeing this insect at work hold it responsible for the injury to the tree which is caused by the concealed borer.

320. Social Insects.—Social instincts are exhibited by a considerable number of insects, especially by termites and some beetles. Some lepidopterous larvae make communal webs. In the Hymenoptera, however, and especially among the ants, bees, and wasps, the most striking instances of insect societies occur.

Among social insects the honeybee (Fig. 191) stands out not only as a type but also as that invertebrate which has been most intimately associated with mankind and has reached the highest degree of domestication. For ages before man learned how to manufacture sugar he depended for his sweets very largely upon the bees, and honey was an important element in human diet.

A swarm, or society, of honeybees includes three distinct types—workers, drones, and queen. In a swarm of 60,000 individuals there are perhaps 200 drones and but one queen, all the rest being workers. Of the three types the queen is the largest, is distinguished by the greater length of her abdomen, and lives for many years. She lays all of the eggs from which are produced the rest of the members of the swarm. The workers are infertile females which do not normally lay eggs but perform all of the labor of the society. They live for only a few weeks. The drones are the males and are produced from unfertilized eggs. They perform no service in the hive but exist only for the purpose of fertilizing the eggs. They are relatively broader than either queens or workers, intermediate in size between them, and may be recognized by their very

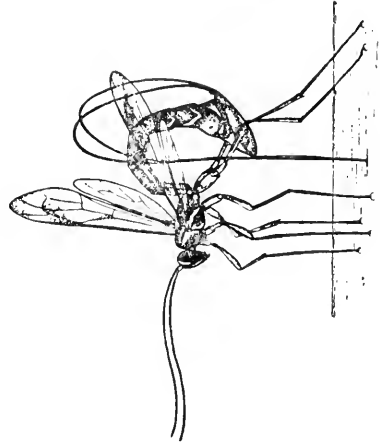

FIG. 190.—An ichneumon fly, *Megarhyssa lunator* (Fabricius), depositing its eggs in the tunnels of *Tremex columba* (Linnaeus), on the larva of which its larva feeds. Natural size. (From Graham, "Principles of Forest Entomology," by the courtesy of McGraw-Hill Book Company, Inc.) The figure shows the characteristic attitude of the insect when drilling.

large eyes. The activities of the workers comprise the gathering of nectar from flowers, the manufacture of honey from this nectar, the collecting of pollen and gum, the building of the comb, the care of the young, the cleaning and ventilating of the hive, and the guarding of it from enemies.

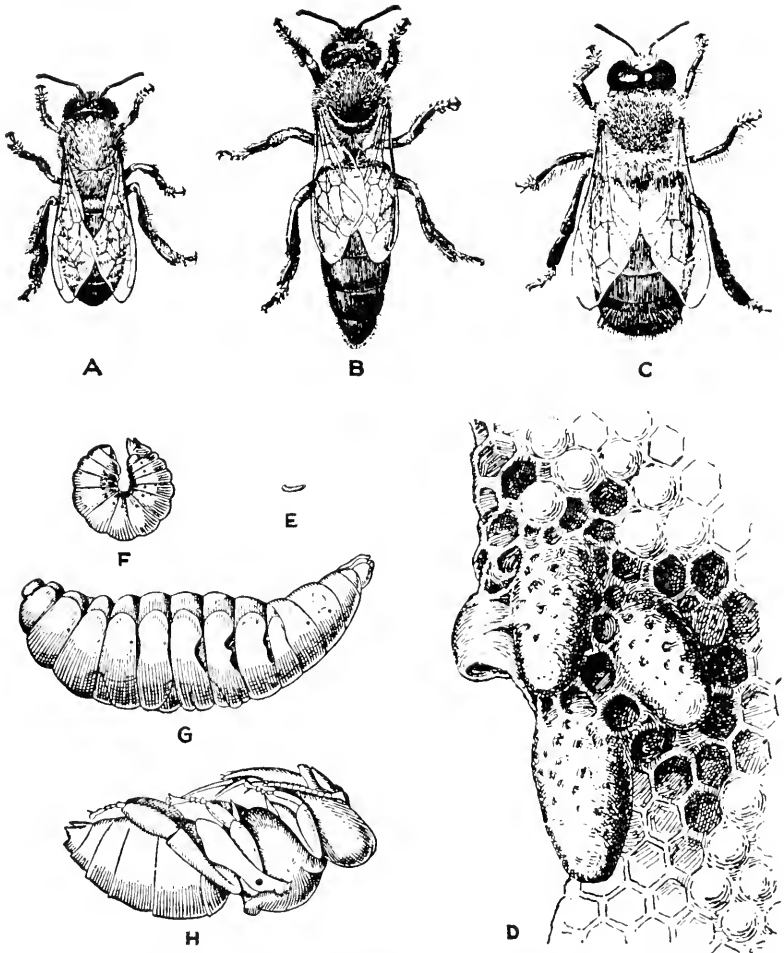

FIG. 191.—The honeybee, *Apis mellifica* Linnaeus. A, worker. B, queen. C, drone. D, portion of comb showing queen cells. E, egg. F, young larva. G, old larva. H, pupa. A to C, somewhat enlarged; D, natural size; E to H, much enlarged. (From Phillips, *Farmers' Bull.* 447, U. S. Dept. Agr.) In D a part of the cells are capped.

The pollen is gathered from flowers and is used as food by all members of the society, but particularly by the growing larvae. In the form in which it is fed it is known as beebread. For the first three days of their lives all of the larvae are fed the same kind of food, which is a bee milk composed of digested honey and digested pollen. After this time the

food is different for the different types of larvae. Those which will develop into workers are given by the nurse bees undigested honey mixed with digested pollen, and those which will develop into drones are fed undigested honey and undigested pollen. The queen larvae, however, are fed upon a rich albuminous bee milk composed of digested honey and digested pollen, mixed with a glandular secretion, the whole being known as royal jelly.

The number of bees in a hive increases rapidly during the spring, since the queen lays from 1000 to 1200 eggs per day and new workers are continually being produced. A few new queens are also developed and a small number of drones. When the number in the hive becomes too great for its capacity, swarming occurs, as a result of which a new society is started elsewhere. If the present swarm is too weak to allow swarming with safety, as rapidly as new queens develop they and the old queen are permitted to have access to one another, whereupon one stings the other to death, since a queen will tolerate no rival in her hive. If, however, the swarm is strong enough, then the worker bees keep the two queens apart and the old queen with a portion of the swarm leaves to establish a new swarm elsewhere, while the new queen becomes the queen of the parent swarm. The new queen soon leaves the hive on her marriage flight, during which she mates with drones. She then returns to the hive, not again to leave it until, perchance, she is in turn forced to lead a new swarm away, resigning her place to a still younger queen. During her marriage flight she receives into the seminal receptacle of her body all of the sperm cells of which she will make use as long as she lives in fertilizing the eggs she lays. A strong swarm will produce many queens; Comstock states that "one morning we found the lifeless bodies of 15 young queens cast forth from a single hive—a monument to the powers of the surviving Amazon in triumphant possession within." At the close of the season the drones are killed off or driven out by the workers to die, and no new drones are produced until the following spring. If at any time the swarm is without a queen, the workers are able, by proper care and feeding, to develop a new queen from an egg or young larva, which, in the ordinary course of events, would have produced a worker.

Among wild bees are found a great many different kinds, showing every gradation between those which live a solitary life and those types which approach the honeybee in the degree of specialization and the variety of activities carried on. Among bees which lead a solitary life there is no distinction between queen and worker, since the queen herself provisions the cells in which she lays her eggs. In the case of bumblebees only the females live through the winter, and in the spring each queen bumblebee has to select a place for her nest, lay her eggs, feed the young, and thus develop a society before she can assume the prerogatives of a

queen and be cared for by the workers. In some bumblebee societies there are workers of different sizes, as well as queens and drones. The

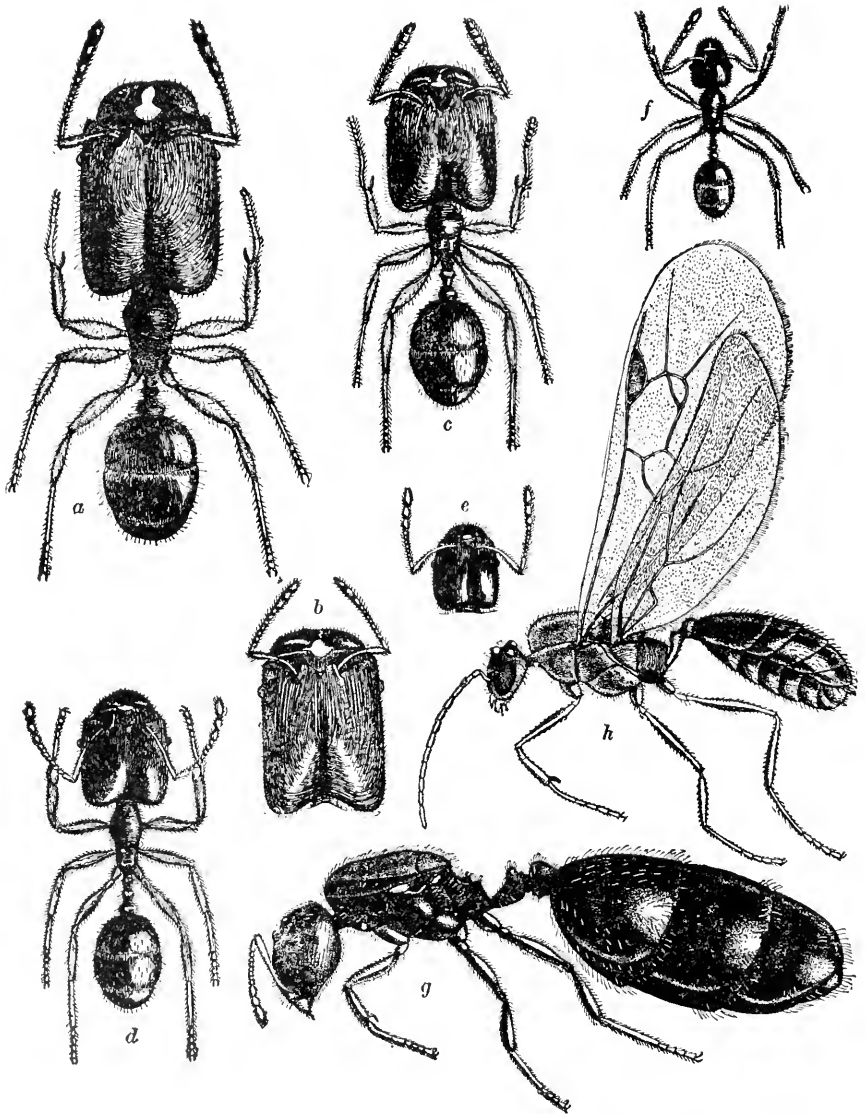

FIG. 192.—Polymorphism as illustrated in an ant, *Phidole instabilis* Emery. *a*, soldier; *b* to *c*, intermediate types between soldier and worker; *f*, typical worker; *g*, dealated female, *h*, male. Much enlarged. (From Wheeler, "Ants," by the courtesy of Columbia University Press.)

bumblebee performs a very important service in cross-fertilizing the red clover, which in many parts of this country is an important hay crop but

which will not develop fertile seeds unless there are bumblebees in the region to carry the pollen from one flower to another.

Wasps and hornets may be distinguished from bees by the possession of jaws instead of suctorial probosces, by the body being smooth and not hairy, and by the legs being never modified for the carrying of pollen. They provision their cells with other animals which they collect and paralyze by stinging before placing them in the cells. Sometimes these cells are provisioned and then sealed, while in other cases the young are fed by the parents as in the case of the bees. The solitary wasps mine in the earth, excavate cavities in wood, or build mud nests. They take no care of their young. The wasps which build the mud nests of many cells, which are familiar in most parts of this country, provision these cells either with the caterpillars of butterflies or moths or with spiders.

Another insect type which lives in societies and shows specialization and polymorphism is the ant (Fig. 192). There are many species of ants, and they form what has been recognized as a dominant type, dominance being shown in the following ways: (1) by the vast number of individuals which exist; (2) by the variety of structures they display, there being a very large number of species; (3) by their wide distribution, which includes the entire globe; (4) by their longevity; and (5) by their manifold relationships to plants and to other animals. Though the males live only for several months, the lives of the workers may cover a span of five or six years, and the queens may survive for as many as fifteen years. Among ants 27 different types of individuals have been recognized, including 7 types of males, an equal number of types of fertile females, and 13 types of infertile females or workers. Not all of these exist in the same society, but many of them may. Among the workers are food gatherers, nurses, soldiers, and other types. This division of labor is accompanied by great differences in size and structure, fitting the different types of workers for the particular duties they have to perform.

CHAPTER XLVI

CLASS ARACHNIDA

The spiders and allied forms make up the fifth class of Arthropoda, known as Arachnida (ă răk' nī dā; G., *arachne*, spider, and *eidōs*, form). They are distinguished from most of the preceding classes by the fact that the head and thorax are grown together forming a cephalothorax. They have four pairs of walking legs and no antennae.

321. External Structure of Spiders.—Spiders have a compact body and a large and more or less globular abdomen, without any trace of

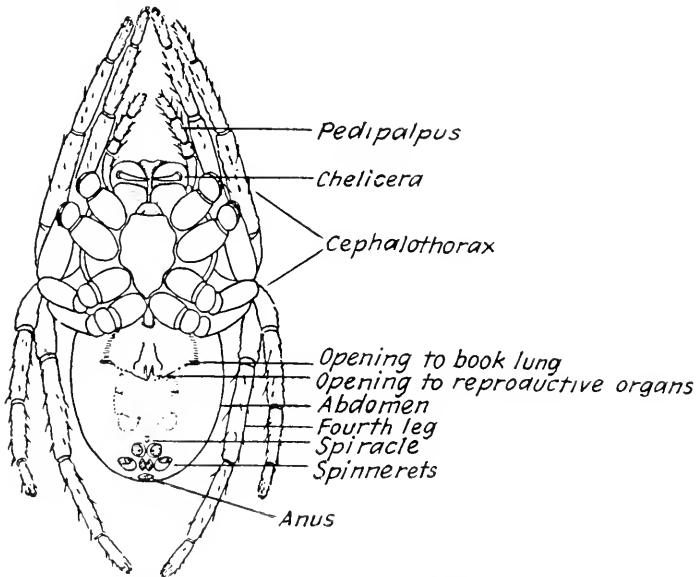

FIG. 193.—Under side of a spider, *Araneus sericatus* Clerck. Enlarged. (From Linville, Kelly, and Van Cleave, "Text-book in General Zoology," after Emerton, by permission of the authors.)

metamerism. The abdomen is separated from the cephalothorax by a deep constriction which leaves a slender peduncle connecting the two.

The mouth parts consist of a pair of jaws, known as chelicerae, and a pair of pedipalpi. Each *chelicera* bears a terminal claw, at the tip of which opens the duct from a poison gland (Fig. 194). The *pedipalpi* are leglike in appearance but their function is rather that of palpi (Fig. 193). Dorsally on the front of the head are the *simple eyes*, of which most spiders have four pairs, though there may be only one, two, or three pairs (Fig. 194).

Certain cave spiders are blind. The legs often have pads of hairs between their terminal claws which enable the animal to cling to walls and ceilings.

At the posterior end of the abdomen are the spinning organs, consisting of two or three pairs of *spinnerets* (Fig. 193), which are finger-like appendages, sometimes jointed. At the tip of each of these spinnerets open many small spinning tubes, from which the silk is spun. The silk is secreted in glands within the body and passes out in a liquid condition, hardening as soon as it comes in contact with the air. The anal opening lies just posterior to these spinnerets, and just in front of them may be a single *spiracle*. On the ventral surface of the abdomen anteriorly are three openings. In the median line is the genital opening, protected in the female by a plate known as the *epigynum*; and on each side, a slit placed transversely, which is the opening into an air sac. The spiracle may be farther forward than stated above, and there may be two just behind the genital opening.

322. Internal Structures.—The alimentary canal includes a narrow esophagus, a sucking stomach, a digestive stomach, and an intestine

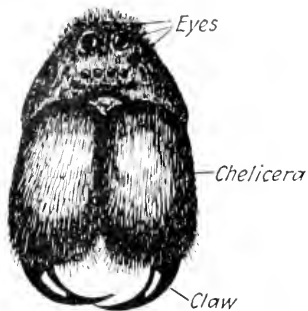

FIG. 194.—Front view of head of *Lycosa carolinensis* Walekenaer. A large female from Lincoln, Nebraska. $\times 4$.

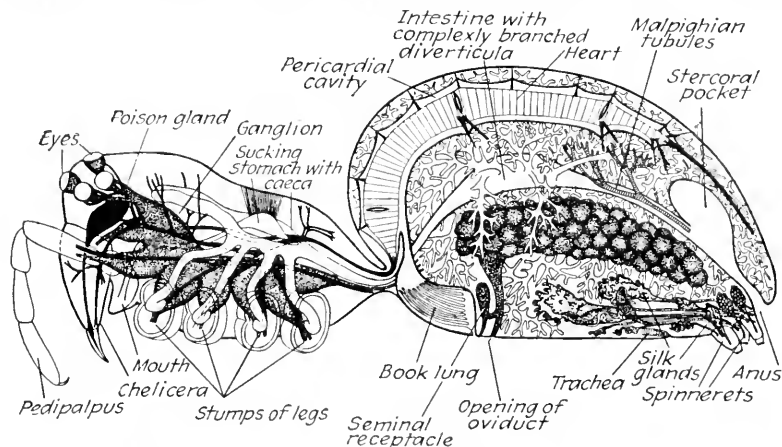

FIG. 195.—Median section of a female spider, diagrammatic, to show internal structure. (From Comstock, "The Spider Book"; copyright, 1912, by Doubleday, Doran & Company, Inc.) The nervous system in the cephalothorax is stippled, as is also the reproductive system in the abdomen. The heart is crosslined and the blood vessels in black; the poison gland and duct are also black. The malpighian tubules are finely crosslined and the spinning glands and ducts shaded. The alimentary canal and diverticula are white.

(Fig. 195). *Malpighian tubules* empty into the intestine near the posterior end. The circulatory system consists of a heart, lying in a pericardial cavity situated dorsally in the abdomen; and of arteries,

sinuses, and veins. In the tissues the blood flows through irregular spaces which lack continuous walls; it is, therefore, not a closed system.

The respiratory organs are two air sacs from the anterior walls of which arise from 15 to 20 leaflike folds supplied with blood capillaries. These folds are sometimes called collectively a lung book, and the whole apparatus is generally termed a *book lung*. There are tracheae in the abdomen but the tracheal system is not extensive and does not play a large part in respiration.

In addition to the malpighian tubules, which the spiders share with insects and myriapods, they also possess in many cases two *coxal glands* in the cephalothorax, which are homologous with the green glands of the crayfish.

The nervous system of the spider consists of a bilobed ganglion above the esophagus and a subesophageal ganglionic mass, with nerves running to various parts of the body (Fig. 195). This represents a condensation in the nervous system greater than that met with in any other type which has been studied and goes along with a high degree of coordination of activities.

323. Metabolism.—The food of spiders consists of juices from their prey, which are drawn into the sucking stomach by the contraction of muscles attached to the wall of the cephalothorax. When a spider feeds upon an insect, the latter is well crushed between the bases of the chelicerae and is then held against the mouth while the sucking process is going on. From the sucking stomach the food passes onward through the alimentary canal; it is acted upon by digestive fluids secreted by the digestive stomach and also by a secretion from the so-called *liver*, which is a large digestive gland surrounding the alimentary canal in the abdomen, the secretion of which resembles the pancreatic secretion of higher forms. Elimination takes place through the malpighian tubules, the coxal glands being generally small and frequently quite degenerate.

324. Reproduction.—The sexes of spiders are always separate, and fertilization is internal. The male transfers the sperm cells from his genital opening to the seminal receptacle of the female by means of his pedipalpi, which in this sex are very large and modified in many and curious ways characteristic of different species. The eggs are laid in a silken *cocoon* which may be attached to some object or carried about by the female. The young leave the cocoon soon after hatching. They undergo no metamorphosis.

325. Spinning Activities.—The characteristic feature in the life of all spiders is the production of silk, which may be used in the construction of a hiding place or home for the spider, and which also serves in the construction of a web for the capture of prey. Small silken threads are used in spinning the silk of attachment discs which serve to fasten larger threads in place, for making a swathe of silk to be thrown about the

struggling prey, and sometimes in making a broad, wavy band across the center of the web. Larger threads are used in the construction of the web itself.

The spiders make use of two kinds of silk, one of which is dry and inelastic, the other viscid and elastic. In the orb web, which may be taken as a type, the framework is composed of threads made up of the first kind of silk, while the spiral threads which pass around the web from one radiating thread to the next are made of silk of the second kind. If examined with a lens this viscid and elastic silk will be found to have numerous beadlike masses of sticky material which help to hold the prey when it touches the web. It is supposed that these two kinds of silk are spun from different spinnerets.

Silk is used not only to line a nest or form a web but also to fashion the cocoon. Some spiders spin an anchor line by means of which they may return to a certain point from which they have leaped or fallen. Others make bridges of silk, spinning threads off into the air until they become attached to some object on the farther side of a space; the lines are then drawn taut by the spider. Still other spiders make use of silk in the construction of balloons, spinning a loose mass of threads which are sufficient to buoy the animal up and enable it to be carried along by the wind. These aeronautic or flying spiders have been known to travel hundreds of miles in this fashion.

326. Behavior.—Spiders can see but a very short distance, apparently distinctly only within a radius of four or five inches. They do not seem to use other senses, except the one of touch, but that sense is exceedingly delicate, especially on the pedipalpi and on the terminal joints of the legs. Spiders act largely from instinct but they form some habits and have many activities which are as justly considered intelligent as are those of any insects.

327. Economic Importance.—Spiders are of little economic importance other than the service which they render in the destruction of injurious insects, but this is more or less offset by their destruction of beneficial ones. Many spiders, particularly those of the tropics, are feared as being poisonous. The larger ones might be able to inject by their bite a sufficient amount of poison to cause marked effects, though rarely, if ever, are they fatal to man. In this country the only spider the bite of which is serious is a greasy-looking black species, *Latrodectus mactans* (Fabricius), with a very large globular abdomen on the lower side of which are some yellow or reddish spots. It is usually found under objects lying upon the ground but may also inhabit dark outbuildings.

328. Scorpions.—Another type of arachnid is the scorpion (Fig. 196), the body of which is clearly metameric. It is divided into a *prosoma* or cephalothorax; a *mesosoma*, which is made up of the broadened anterior abdominal metameres; and a *metasoma*, which includes the slender

posterior metameres of the abdomen. The metasoma forms a tail which, in an attitude of attack or defense, is carried above the rest of the body so that the posterior end is directed forward. This terminates in a sharply pointed, clawlike appendage, which is not a metamere, and at the point of which opens the duct from a poison gland. There are two median simple eyes on the upper side of the cephalothorax and three lateral ones on each side. The pedipalpi are very large and curiously like the chelipeds of the decapod crustacea. There are four pairs of lung

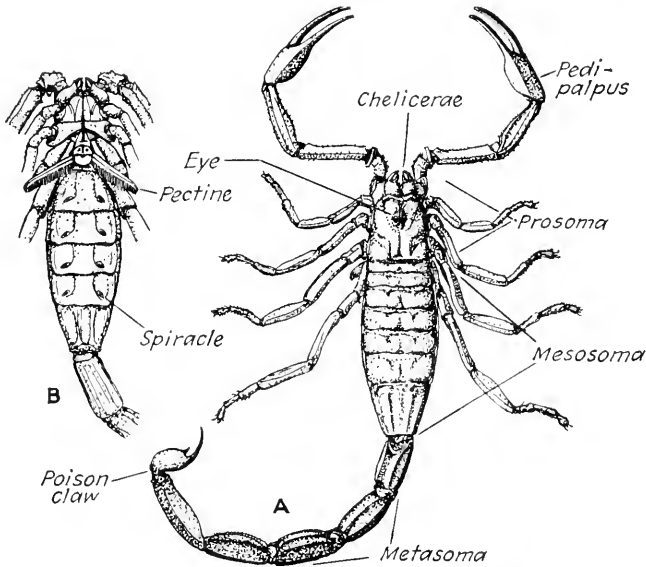

FIG. 196.—A Tropical American scorpion, *Centruroides* sp. A, dorsal view of entire animal. B, under side of body. Natural size.

books opening by spiracles on the under surface of the abdominal metameres from the third to the sixth.

Scorpions live mostly in tropical and subtropical regions and are nocturnal in their habits. Their food consists of spiders and large insects which they seize with the pincers of their palpi and sting to death. The sting also serves as a weapon of defense. It is, however, impossible for the scorpion to sting itself to death, as it has often been said to do. The sting rarely, if ever, proves fatal to man.

329. Mites.—Another group of arachnids contains the mites (Fig. 197), which in turn include the ticks. These are very small arachnids without external signs of metamerism and without division into cephalothorax and abdomen. Mites breathe through tracheal tubes. The cephalothoracic appendages are similar to those of spiders, although the pedipalpi are not so large. The abdomen shows neither the slits into the air sacs nor the spinnerets at the posterior end. Nevertheless, some

mites can spin silken threads from openings on the ventral side of the abdomen, in some cases near the anus.

Among mites are many which are of decided economic importance. The ticks are parasitic upon various animals and, since they pass from one individual to another, are capable of transmitting diseases. In the

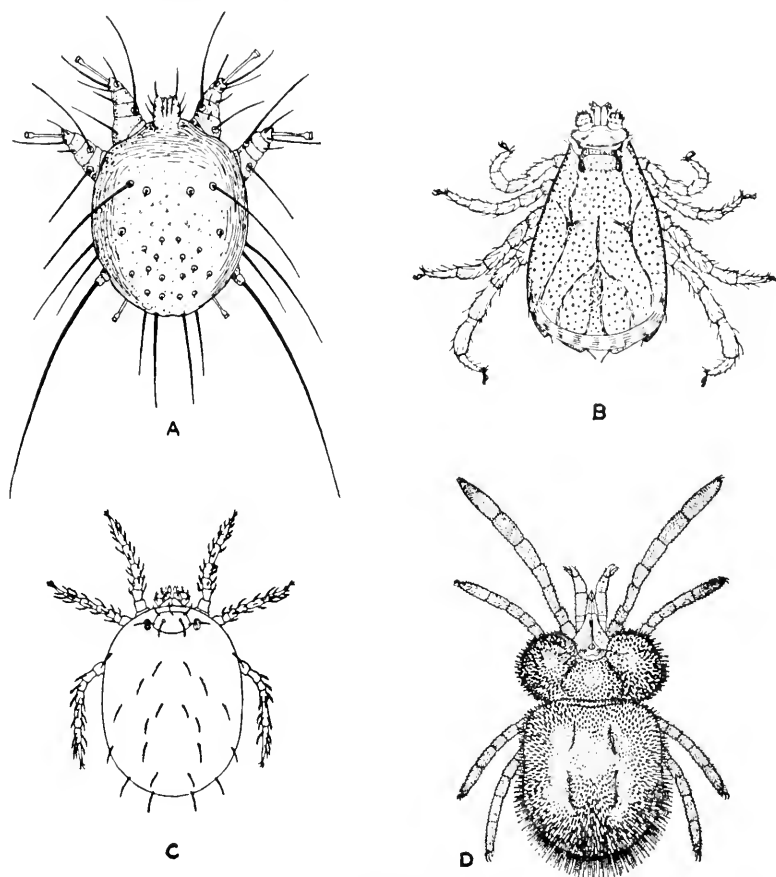

FIG. 197.—Mites. A, an itch mite, *Sarcoptes scabiei* DeGeer. Male from above. Greatly enlarged. B, Texas cattle fever tick, *Margaropus annulatus* (Say). Male. $\times 16$. C, chigger, *Trombicula irritans* (Riley). Larva. $\times 75$. D, adult of chigger. Greatly magnified. (A, C, and D from Ewing, "Manual of External Parasites," by permission of the publisher: Charles C. Thomas; B from Salmon and Stiles, "Cattle Ticks of the United States," Bur. An. Indus., U. S. Dept. Agr.)

case of the cattle tick, which carries the organism causing Texas cattle fever, the parasite is taken up by a parent mite and introduced into another host by the bite of the young of that mite, transmission thus involving two generations. This disease is said at one time to have caused an annual loss of \$100,000,000, but its frequency has now been reduced by preventive measures.

Other parasitic mites are the itch mites; the follicle mites, which live in the sweat glands and hair follicles of man and some domestic animals;

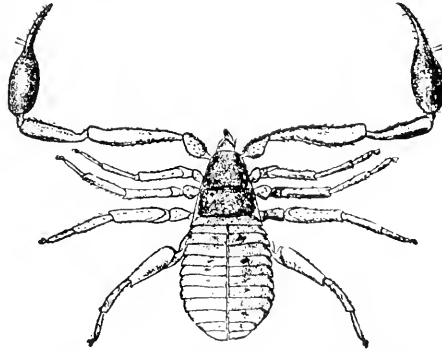

FIG. 198.—A pseudoscorpion. (From Comstock, "The Spider Book"; copyright, 1912, by the courtesy of Doubleday, Doran & Company, Inc.) \times about 9.

and the scab mites, which produce scabies. The animals generally known in this country as chiggers are the larvae of red velvet mites.

Mites that infest plants include the "red spider," which attacks house plants; many that produce galls; and some that cause diseases of leaves,

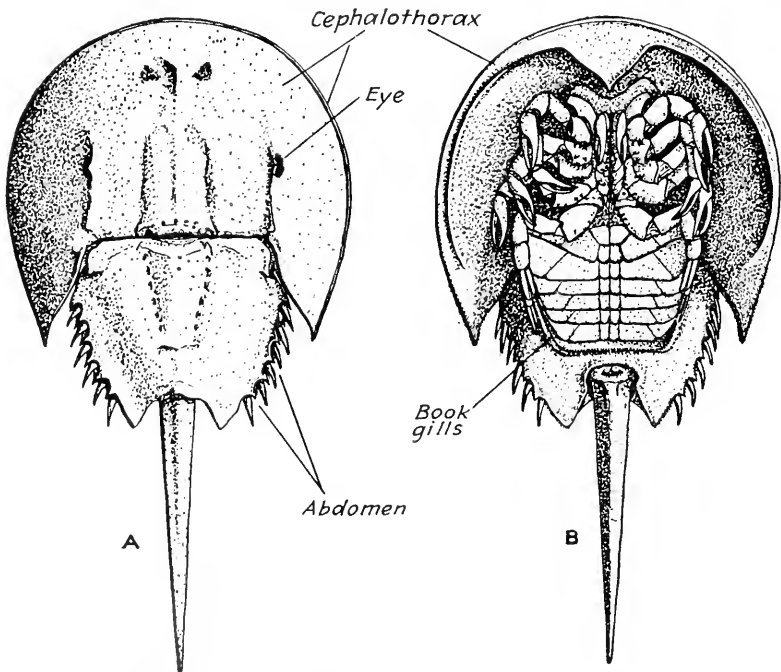

FIG. 199.—King crab, *Limulus polyphemus* (Linnaeus). A, dorsal view. B, ventral. $\times 1\frac{1}{5}$.

such as the one which causes the pear-leaf blister. Still other mites are found in food products, such as cheese, sugar, and preserved meats.

330. Other Arachnids.—Among other arachnids are the well known harvestmen, or daddy longlegs, which are like small-bodied and very long-legged spiders, but which have no constriction between the thorax and the metameric abdomen.

Another type is represented by the pseudoscorpions (Fig. 198). These have pedipalpi much like those of the scorpions but are very much smaller and lack the long tail. They are found throughout this country, but, being of small size, they do not often excite notice.

Still another type which belongs here is the king crab, or horseshoe crab (Fig. 199), which is a marine animal found along the Atlantic coast from Maine to Yucatan. It differs from other arachnids in that it lacks malpighian tubules and possesses book gills. *Book gills* are similar to book lungs but the leaves lie exposed on the ventral side of the abdomen, and oxygen is taken from the water. The king crab, together with a few mites, represents all of the arachnids which are marine. It is nocturnal, wandering along the shore in shallow water and feeding upon any animal which it can overpower.

Relatives of king crabs and perhaps their ancestors are the trilobites (Fig. 314). They were present in the earliest known fauna, that of the Cambrian age, and reached their maximum of size, number, and variety in the Silurian (Fig. 312). The largest were nearly two feet long. They disappeared at the end of the Carboniferous, and related types resembling modern crustaceans and king crabs appeared.

CHAPTER XLVII

ARTHROPODS IN GENERAL

From what has already been said in regard to the different groups included in this phylum the general characteristics have become evident and need only to be briefly reviewed.

331. Characteristics and Advances.—The animals belonging to Arthropoda are *metameric* (Fig. 200), and all exhibit more or less of a tendency for the different metameres to be grouped into three *regions*, namely, head, thorax, and abdomen. In Onychophora and Myriapoda the latter two are not evident; in the spiders and in many Crustacea the head and thorax are combined into a cephalothorax; in insects, however, the three regions are distinct. Another characteristic of the group is that typically each metamere bears a pair of *jointed appendages*, though

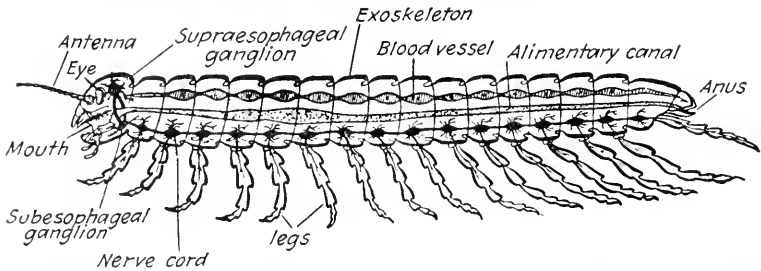

FIG. 200.—Diagrammatic representation of the structure of an arthropod. (From Schmil, "Text-book of Zoology," by the courtesy of A. and C. Black, and Quelle and Meyer.)

in many groups a greater or less number of these appendages are absent. The cuticula often becomes highly chitinized and in the Crustacea is also hardened by the addition of lime salts. The nervous system resembles that of the annelids in having metamericly arranged ganglia, but in the higher forms it shows a pronounced tendency toward fusion of the ganglia and to *cephalization*, or the localization of control in the head region. The increase in the number and variety of appendages, which makes for variety in action, as well as the higher development of both central nervous system and of sense organs, is the chief advance shown by the phylum. There is also a high degree of specialization in the alimentary canal, which is divided into distinct regions and modified in accordance with the character of the food.

332. Classification.—The classes of this phylum have been discussed but may be systematically presented as follows:

Section I. BRANCHIATA (brān kī ā' tā; G., *branchia*, gill). Mostly aquatic, possessing gills.

Class 1. Crustacea.

Section II. TRACHEATA (trā kē ā' tā; G., *tracheia*, rough). Air-breathing, with tracheae or book lungs, or water-breathing, with book gills.

Division A. *Protracheata* (prō trā kē ā' tā; G., *pro*, before, + *tracheata*). Primitive, annelid-like.

Class 2. Onychophora.

Division B. *Antennata*. With antennae.

Class 3. Myriapoda.

Class 4. Insecta.

Division C. *Arachnoidea* (ā rāk noi' dē á; G., *arachnoeides*, like a spider). Without antennae.

Class 5. Arachnida.

333. Behavior.—The most striking thing in the behavior of arthropods is the great development of *instincts*. These frequently become so complex and adjust the animal so perfectly to the conditions of its existence that to most people they seem to imply the exercise of intelligence. In addition to instinct most zoologists recognize a primitive form of *intelligence* in the higher insects and in the spiders. However, the readiness with which some higher crustaceans modify their behavior would seem to indicate that if intelligence is attributed to the two groups mentioned, it should also be recognized in them.

CHAPTER XLVIII

PHYLUM CHORDATA

The last of the phyla, and from the standpoint of efficiency the highest, is Chordata (kôr dā' tá; G., *chorde*, cord, referring to the notochord). In addition to the vertebrates, which are, generally speaking, the largest, most conspicuous, and best known animals, the phylum includes several forms of which only zoologists are aware and which, therefore, have no common name. Some of these lower chordates are very unlike the vertebrates and reveal their chordate character only after close study.

334. Characteristics.—The chordates possess three characteristics which set them apart from all other animals, these being the possession of (1) a notochord, (2) pharyngeal slits, and (3) a tubular nervous system dorsally situated in the body. Of these structures the notochord and the pharyngeal slits remain throughout life in only the lower chordates, being in the higher ones replaced by other structures. The nervous system, however, persists with the same general character throughout, in the highest chordates reaching a very high degree of development and functional activity.

The *notochord* first appears, both ontogenetically and phylogenetically, as a rod of cells. It is derived from a longitudinal outfolding of the dorsal wall of the archenteron which becomes pinched off and lies at the dorsal side of the alimentary canal (Fig. 201). It is, therefore, entodermal. In somewhat higher types it becomes converted into a more rigid, though still flexible, rod which runs the length of the body, serving to stiffen it. In the vertebrates the notochord develops in the embryo, but in the adult there is formed about it a series of bones which together make up a vertebral column. This is the axis of an internal skeleton, to which is added a large number of other bones providing support and giving attachment to muscles. As the vertebral column becomes more highly developed the notochord practically disappears. Flexibility in the vertebral column is secured either by articulation of the separate bones, or vertebrae, or by the compression of discs of fibrocartilage between them.

The *pharyngeal slits* are a series of passages on each side of the body toward the anterior end leading from the cavity of the pharynx to the outer surface of the body. They are found in all lower chordates and in the lower vertebrates. In their walls are developed networks of

blood vessels making it possible for respiration to take place. In the higher vertebrates, however, these slits, which start to develop during embryonic life, either become closed or never are open, and the respiratory function is assumed by lungs. The latter are developed as ventral outpocketings of the pharynx somewhat posterior to the pharyngeal slits. Because of their formation from evaginations of the wall of the pharynx which unite with invaginations of the body wall, the pharyngeal slits are lined with entoderm internally and ectoderm externally.

The *dorsal tubular nervous system* develops from a strip of ectodermal cells lying in the median line on the dorsal side of the body. This strip of cells sinks inward, forms a groove, and then, by the meeting of the side walls above, becomes a tube, called the medullary tube (Fig. 201). This development of a central nervous system by invagination is peculiar to the chordates. Typically this tube, when first formed in the embryo, opens at the anterior end to the outside and at the posterior end turns ventrally around the end of the notochord to become continuous with the posterior end of the archenteron. Later the opening to the outside is closed and the connection with the archenteron is severed, thereby producing a closed neural tube the cavity of which is known as the *neurocoel*.

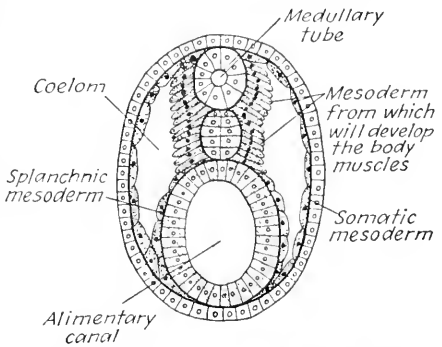

FIG. 201.—Somewhat diagrammatic representation of a section through the body of an amphioxus larva at a stage later than any shown in Fig. 48, with which it may be compared. The ectoderm is white, the entoderm lined, and the mesoderm stippled.

In the vertebrates the anterior end of this neural tube becomes dilated and forms the brain, while the remaining part becomes inclosed in the vertebral, or spinal, column and forms the spinal cord.

Another characteristic of the chordates is the gradual obscuring of the metameric condition in the body wall by the fusion of the metameres and the shifting of superficial muscles. Throughout the phylum, however, the deeper structures remain metamerically arranged.

335. Advances Shown by the Chordates.—In the characteristics just enumerated the chordates show advances over all lower phyla, and these advances are the foundation upon which their supremacy in the animal kingdom rests. An internal skeleton does not give so great a leverage to muscles as does the exoskeleton of the arthropods, but this mechanical disadvantage is more than balanced by the freedom of movement which is allowed. An organism incased in an exoskeleton can never be so mobile, and on the whole can never become so efficient, as can one the body and appendages of which possess an internal skeleton. The

pharyngeal slits offer a mode of respiration more effective than that allowed by any type of respiratory organ possessed by lower forms because the slits are interposed directly in the path of the circulation and all of the blood in the body passes through them. In tracing the development of the earlier phyla it has been evident that their nervous systems have advanced in the degree to which they have been centralized, thus bringing about more effective coordination. The development of a continuous tubular nervous system makes possible the most intimate association of ganglionic masses and thus the greatest degree of interaction between them. A continuous tubular nervous system also offers more surface for the escape of fibers than do separate metamericly arranged ganglia, thus permitting an increase in the number of nerve cells. The obscuring of the metamerism is in the interest of unified action of the body. The arthropods develop the possibilities of metamerism to the maximum degree. The chordates retain the advantages of the metameric plan but relinquish it to the degree desirable to secure the greatest unity in the operation of the body as a whole. Other advances possessed by the vertebrates but not shared by the lower chordates remain to be discussed later.

336. Classification.—The chordates are usually separated into four subphyla, as follows:

1. *Hemichordata* (hěm ĭ kôr dā' tâ; G., *hemi*, half, and *chorde*, cord), or *Adelochorda* (ăd ē lō kôr' dā; G., *adelos*, concealed, and *chorde*, cord). Includes two or three types of marine wormlike animals, which are all small, some very minute.

2. *Urochordata* (ū rō kôr dā' tâ; G., *oura*, tail, and *chorde*, cord). Includes the tunicates, also marine, which illustrate extreme degeneration and, in a sense, retrogression.

3. *Cephalochordata* (sěf à lō kôr dā' tâ; G., *kephale*, head, and *chorde*, cord).—Includes a marine type known as the amphioxus which has a somewhat fishlike form.

4. *Vertebrata* (vēr tē brā' tâ; L., *vertebra*, a joint).—Includes fish, amphibia, reptiles, birds, and mammals.

CHAPTER XLIX

LOWER CHORDATES

The chordates belonging to the first three subphyla represent three very diverse types. The hemichordates were until quite recently considered worms and the tunicates were formerly put in a phylum by them-

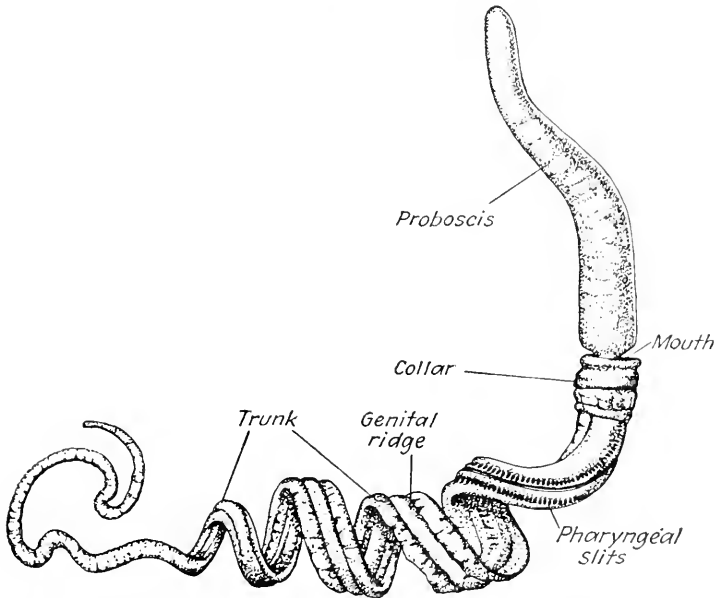

FIG. 202.—*Dolichoglossus kowalevskii* (A. Agassiz), found on the Atlantic coast. An adult male. $\times 2$. (From Bateson, *Quart. Jour. Mic. Sci.*, n. s., vol. 25.) *Dolichoglossus* is by many considered only a subgenus of *Balanoglossus*.

selves and included among the invertebrates. The resemblance of the amphioxus to the vertebrates has, however, long been recognized.

337. Hemichordata.—The genus *Balanoglossus* may be taken as a type of this subphylum (Fig. 202). To this genus belong wormlike animals which burrow in muddy areas along the seashore, passing the mud through their bodies and taking out the organic matter in the same fashion as the earthworm takes organic matter from the soil. Different species range in length from an inch to 4 feet, and some of them are brightly colored. The body consists of three portions, an anterior proboscis, a ringlike collar, and a metamerie trunk similar in many ways to the body of an annelid. The mouth opening is ventral and just in

front of the collar. There is a dorsal pouch at the anterior end of the alimentary canal which originates like a notochord as a dorsal outpocketing of the archenteron and which runs forward into the proboscis. Its

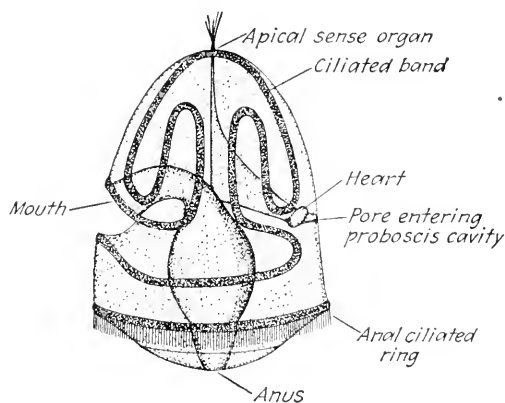

FIG. 203.—*Tornaria* larva, viewed from the side. (From Thomson, "Outlines of Zoology," after Spengel.)

function is to stiffen the proboscis, which is an aid in burrowing. The claims of *Balanoglossus* to inclusion in the phylum Chordata rest upon the fact that this structure is considered a notochord, that the animal possesses a large number of pharyngeal slits, and that in the region of the collar a portion of the dorsal nerve cord seems to be definitely tubular. The dorsal nerve cord is also formed by a process of invagination. This type is monoecious. The larva, called a *tornaria* (Fig. 203), is free-swimming and resembles the larvae of the echinoderms.

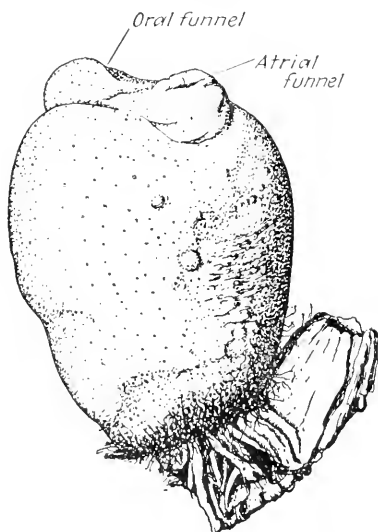

FIG. 204.—*Pyura aurantium* (Pallas), a sessile ascidian from Labrador. $\times 23$. (From VanName, *Proc. Boston Soc. Nat. Hist.*, vol. 34.)

338. Urochordata.—This subphylum includes the tunicates, which may be either free-swimming or fixed forms. The typical tunicates, also called ascidians, are fixed forms in the adult stage (Fig. 204) and are inclosed in a *tunic* composed of animal cellulose the composition of which is very similar to that of plant cellulose. It is the presence of this tunic which suggests the name

tunicate. When one of these animals is stimulated, the body is strongly contracted and the water is thrown out through the mouth with consider-

able force. This reaction suggests another name, sea squirts, that has been applied to such animals.

Under the tunic of one of these ascidians and surrounding the body proper is an *atrial cavity* (Fig. 205). The body always has two openings, one known as the *oral funnel*, which is the mouth opening, and the other as the *atrial funnel*, or *atriopore*, which opens into the atrial cavity. Water enters the oral funnel, passes into a pharynx in the walls of which are numerous pharyngeal slits, through these into the atrial cavity, and out through the atriopore. As the water passes through the pharyngeal slits, respiration occurs and food is strained out. On the side of the pharynx which corresponds to the ventral surface is a ciliated groove called the *endostyle*. A sticky mucous secretion produced in this endo-

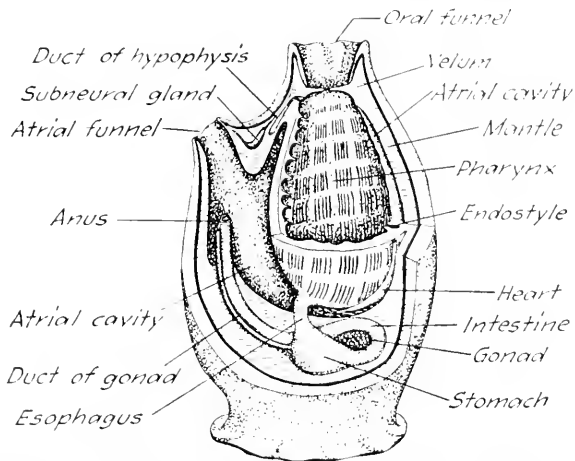

FIG. 205.—Anatomy of a typical ascidian. (From Newman, "Vertebrate Zoology," after Hertwig.)

style is continually being passed onward to the intestine and serves to convey food particles to that portion of the alimentary canal, where digestion and absorption take place. The anus is situated near the atriopore and the water which passes out through the atriopore carries with it the feces. The heart is a pulsating tube, lying ventral to the stomach, which drives the blood first one way and then the other by alternate series of beats opposite in effect. The adult animal possesses one of the characteristics of a chordate in having *pharyngeal slits*, but it has no notochord and the nervous system consists only of a ganglion embedded in the body wall between the two funnels and associated with a *subneural gland*.

A study of the development of a tunicate reveals all of the chordate characters. The tunicates are all monocious, and cross-fertilization is the rule, fertilization taking place outside the body. From the egg is pro-

duced a larva somewhat like a frog tadpole in form. It possesses a typical notochord which is largely confined to the tail and which extends only as far forward as the pharynx. The pharynx has but a small number of slits. There is a dorsal neural tube, which is dilated at the anterior end into a simple brain. At the anterior end of its body the larva possesses adhesive papillae, a pair of eyes, and *otocysts* which are comparable to the otocysts, or primitive ear cavities, of vertebrates. When the organism, after a short, active, free-swimming life, is ready to metamorphose, it attaches itself to a solid object by the adhesive papillae (Fig. 206); the tail, notochord, and most of the neural tube disappear, and the brain degenerates into a simple ganglion. The sense organs are lost. While the tail is disappearing, the mouth is gradually changing its location from the point of attachment to the free end of the body, moving up along the dorsal side. This results in a great increase in the extent of the ventral surface, and since there is a corresponding decrease in the

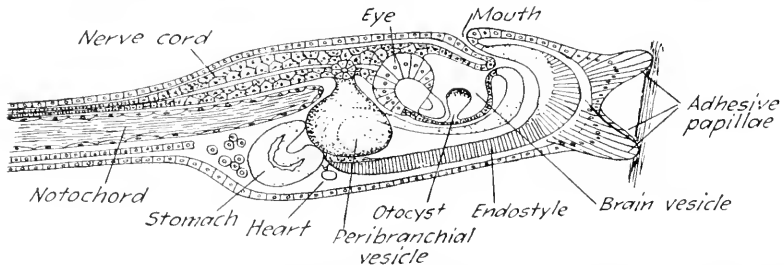

FIG. 206.—Section through the anterior part of the body of a tunicate larva, after fixation. From the right side. (From *Delage and Hérourard, "Traité de Zoologie Concrète,"* after Kowalevsky.)

dorsal surface, the anal opening and the mouth are brought near to one another, causing the alimentary canal to become U-shaped. The atrial cavity develops from invaginations on the two sides of the body, at the bottom of which are the pharyngeal slits. These invaginations come to open into each other and to surround the whole pharynx; the external opening of the cavity becomes the atrial funnel. The outer wall of the atrial cavity is the *mantle*. Finally the cellulose tunic is secreted by the ectoderm of the mantle and the animal has ceased to have any resemblance to the active tadpole-like larva, which bore the promise of a highly developed adult. The number of pharyngeal slits increases and becomes multiplied by the appearance of partitions, so that the wall of the pharynx becomes quite sievelike.

It is thus clear that in the metamorphosis of the tunicate a very pronounced degeneration has taken place; indeed, the fixed adult upon superficial examination seems little higher than a sponge. Some fixed tunicates which reproduce by budding form colonies having a common tunic. These colonies may be spread over the surface of rocks and have somewhat the appearance of a piece of pinkish fat pork.

Free-swimming tunicates, either single or colonial, live in the surface waters of the sea. They move about by forcing water out of the posterior atrial opening or openings. Some colonial types form chains of

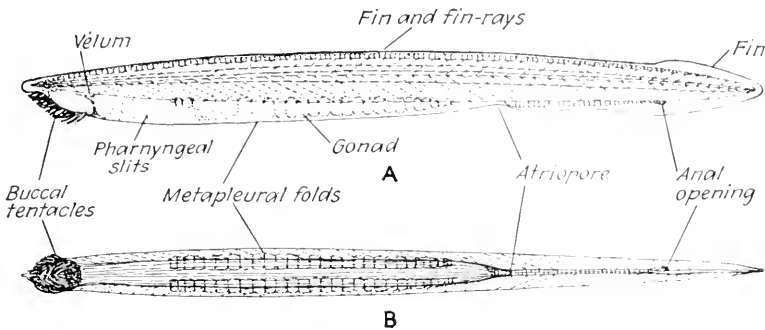

FIG. 207.—An amphioxus. A, seen from the side; B, from below. Some details of internal anatomy indicated by dotted lines. From a specimen. $\times 21\frac{1}{2}$.

individuals produced from a parent by budding, omitting the free-swimming larval stage.

The tunicates are the only chordates which exist in attached colonies. There is an alternation of generations in the life cycle of some, a sexual

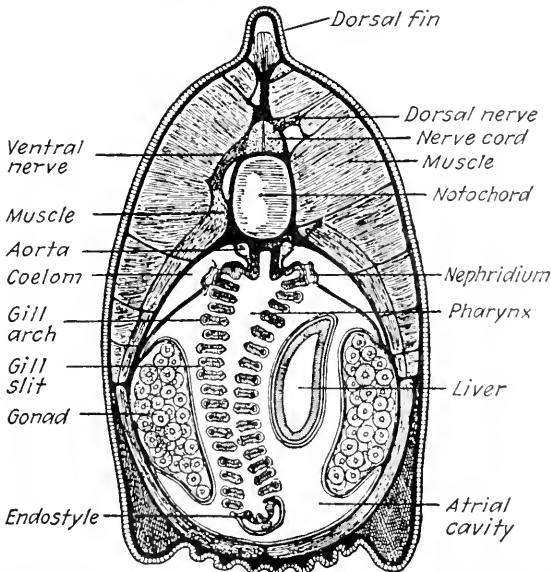

FIG. 208.—Cross section through the gill region of amphioxus. (From Hertwig and Kingsley, "Manual of Zoology," after Lankester and Boicri.)

generation, in which develops a larva that metamorphoses into a free-swimming adult, being followed by an asexual generation, which reproduces only by budding. Thus these animals show retrogression in their

manner of reproduction, returning to asexual reproduction and metagenesis, which are found elsewhere only among the lower metazoan phyla. They also show a type of colonial life which is more characteristic of the lower phyla. Another striking phenomenon is the marked degeneration which takes place during metamorphosis.

339. Cephalochordata.—The type of this subphylum is the amphioxus, often called the lancelet (Fig. 207). It is a small marine animal reaching a length of but two or three inches and pointed at both ends. It is found on the sandy beaches of tropical and subtropical regions of the world.

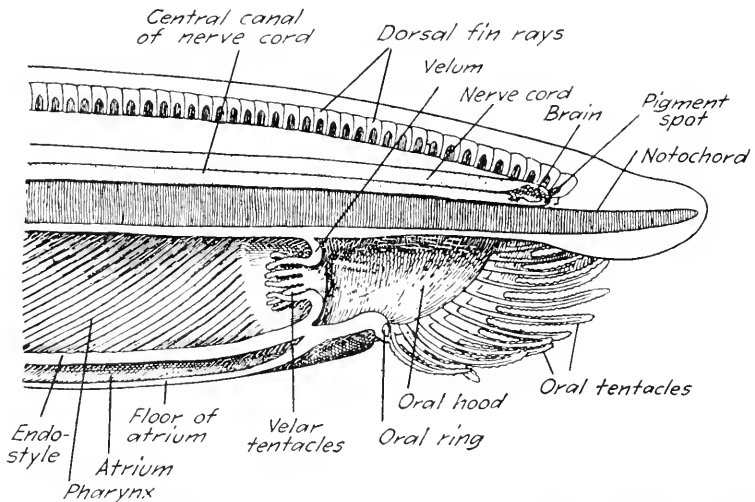

FIG. 209.—Median longitudinal section of an amphioxus. (From Borradaile, "Manual of Zoology," by the courtesy of Oxford University Press.)

The mouth of the amphioxus opens on the ventral surface of the body near the anterior end, while the anal opening is on the same surface nearly at the posterior end. A *fin* runs in the median line of the body from the anterior end backward, around the tail, and forward on the ventral surface, passing to one side of the anus, and ends at the atriopore. The *atriopore* is an opening at a point about one-third of the length of the body from the posterior end. From this point two lateral, ventral folds, known as *metapleural folds* (Fig. 208), run forward to the region of the mouth. The atriopore is the posterior opening of an *atrial cavity* which surrounds the ventral side of the body from this point forward and into which open the *pharyngeal slits*. Water passes from the mouth to the pharynx, through these slits into the atrial cavity, and thence out through the atriopore. Food is secured in the same manner as in the tunicates, a ventral *endostyle* functioning exactly as in those forms.

Running dorsally from one end of the body to the other is the *notochord*, a slender rod tapering at both ends and composed of vacuolated

cells. Stiffness is added to this rod by the cells being filled with liquid. On the dorsal side of the notochord is the tubular *nerve cord* which possesses a small central canal and which is dilated at the anterior end to form a rudimentary brain, known as a *cerebral vesicle* (Fig. 209). At the anterior end of the nerve cord is an *eyespot*. The only sense other than light perception known to be possessed by the amphioxus is that of touch.

The circulatory system, which does not include a heart, is not more complicated than that of the earthworm. As in vertebrates, however, the course of the blood is the reverse of that in the earthworm, being forward in a ventral vessel and backward in a dorsal one. Elimination is carried on by a *nephridial system* resembling that of some of the annelid worms.

Amphioxus lives buried in the sand with only the anterior end exposed. The current of water rising from the atriopore serves to create a sort of tube in which the body lies. In this position the *oral hood* and *buccal tentacles* are opened wide to gather all the food particles possible. At times the animals come out and swim around in the water, particularly at night and during the breeding season. When they bury themselves in the sand, they enter head first and burrow very rapidly.

Amphioxus is dieocious. In the evenings of the breeding season, which is in early summer, eggs and sperms are set free at the surface of the sea, and there fertilization takes place. Cleavage is total and equal (Fig. 48), and a gastrula is produced by invagination. The mesoderm develops from entodermal pouches. A free-swimming larva is produced which gradually grows into an adult, at which time it begins to bury itself in the sand. There is, therefore, no metamorphosis.

340. Economic Value.—None of the lower chordates is of much economic value except as laboratory material. However, in *Science* for July 27, 1923, Light tells of the use of the amphioxus for food in China and speaks of "a total of hundreds of tons of amphioxus taken during the year" off the southern coast of that country.

CHAPTER I

SUBPHYLUM VERTEBRATA

The last subphylum, Vertebrata, is distinguished from the other subphyla of Chordata by several characteristics, though it shares with them all the characteristics that belong to the chordates as a whole. Instead of a type being selected to illustrate this subphylum, a general description will be given applicable to vertebrates generally.

341. Distinguishing Characteristics.—Some of the distinguishing characteristics of the vertebrates are as follows: (1) The notochord is more or less completely replaced by a vertebral column, which is made up of a series of separate bones called *vertebrae*. (2) The vertebral column and other supporting structures form an internal skeleton, or *endoskeleton*. (3) As a rule two pairs of *appendages*, either fins or limbs, are developed. (4) All vertebrates possess a *heart*, ventrally situated, with at least two chambers. (5) In the blood are *red blood corpuscles* which contain hemoglobin; white blood corpuscles also exist, as they do in the blood of the higher invertebrates, but the hemoglobin was in those types dissolved in the plasma of the blood. (6) All vertebrates possess a *brain* which is divided into five parts known as vesicles, each in its primitive form containing a cavity. (7) They possess a more or less distinct *head*, in which are situated several organs of special sense. (8) A large *coelom* is present which is almost entirely filled with the organs of the digestive, respiratory, excretory, and reproductive systems; the small space not occupied by these systems contains a serous, or watery, fluid. (9) The vertebrates are also alike generally in that they possess a posterior prolongation of the body behind the anal opening, forming a *tail*.

342. Body Plan.—Generally speaking, the vertebrate body is divided into three parts—head, trunk, and tail. A *neck*, which is simply a constricted region between the head and trunk, may be present, though this is not marked in the lower vertebrates or those fitted for aquatic life. In the terrestrial types, one of the two pairs of appendages is situated in the thoracic region, which is the anterior portion of the trunk, while the other pair is situated in the pelvic region, which is the posterior portion just in front of the tail. These positions are dictated by mechanical necessity when the limbs are used for both support and locomotion. In aquatic types where the body is buoyed up by the water this arrangement is frequently modified. The anterior appendages appear in various animals as pectoral fins, forelegs, arms, or wings; the posterior ones are either pelvic fins, hind legs, or the only legs.

In all the vertebrates below the mammals the coelom is divided into a pericardial cavity containing the heart and a general body cavity. In the mammals it includes a pericardial cavity, a thoracic cavity containing

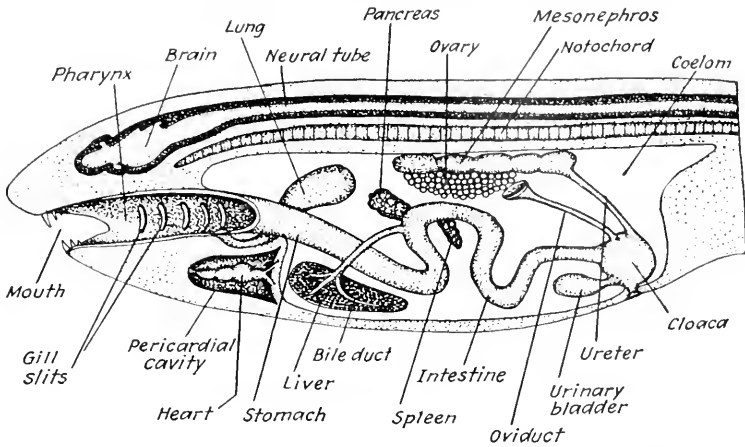

FIG. 210.—Diagrammatic longitudinal section of the female of a lower vertebrate. (Re-drawn, with modifications, from Hegner, "College Zoology," after Wiedersheim.)

the lungs, and an abdominal cavity filled with the organs of the digestive, excretory, and reproductive systems.

The general arrangement of organs within the body may best be understood by the aid of diagrams (Figs. 210 and 211) showing ideal

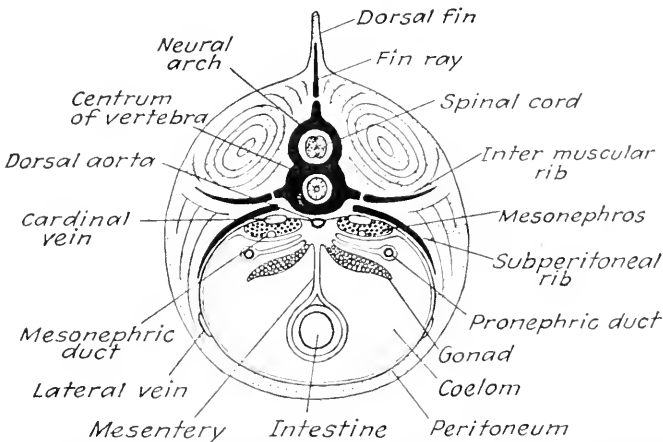

FIG. 211.—Diagrammatic cross section of a lower vertebrate. (From Parker and Haswell, "Text-book of Zoology.")

longitudinal and cross sections, neither of which corresponds precisely to the structure of any one vertebrate but both of which bring out general relationships illustrated more or less completely in all.

343. Skin.—Vertebrates are covered with a skin, or integument, consisting of two parts—an outer epidermis, derived from the ectoderm and consisting of stratified pavement epithelium; and an inner dermis, mesodermal in origin and consisting largely of connective tissue (Fig. 212). The *epidermis* has only a few nerve endings, which are in the deeper layers, and no blood vessels. The deepest layer is made up of living cells which regularly undergo division and replace the dead, horny, scale-like cells which are continually being lost from the surface. These deep cells are supplied with blood from a dermal capillary network lying just below the epidermis. From the epidermis are derived certain

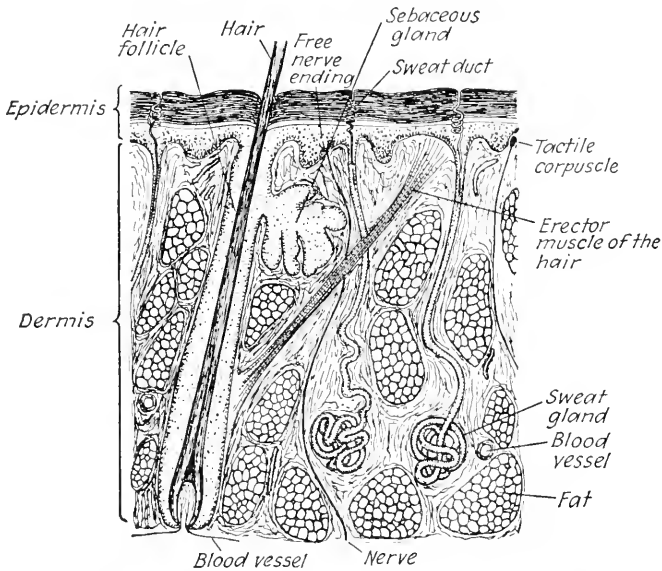

FIG. 212.—Somewhat diagrammatic section of the mammalian skin.

external skeletal structures such as horny scales, feathers, hairs, nails, hoofs, and claws and the enamel of the teeth.

The *dermis*, or *corium*, contains nerve endings, including specialized groups of epidermal cells forming tactile organs. It also contains numerous glands, such as the mucous glands of fishes and amphibia and the sweat, oil, and milk glands of mammals. Bones are sometimes developed in the dermis. From the dermal layer are also derived the dentine and the cementum of the teeth.

344. Skeleton.—The skeleton of vertebrates is divided into an *exo-skeleton* and an *endoskeleton*. The former includes all dermal cartilages and bones, to which may be added the epidermal skeletal structures; and the latter, all the deeper-lying skeletal parts. The endoskeleton is made up of *axial* and *appendicular* portions (Fig. 213). The former includes the skull, the vertebral column, the ribs, and in the higher forms a

sternum; the latter is composed of the girdles and the limbs. The *girdles* are parts of the skeleton which more or less completely surround the trunk and to which the skeletons of the limbs are articulated.

The skeleton in the lowest vertebrates may be completely membranous; in those next higher in structure it is made up largely of cartilage; while in those still higher it includes both cartilage and bone.

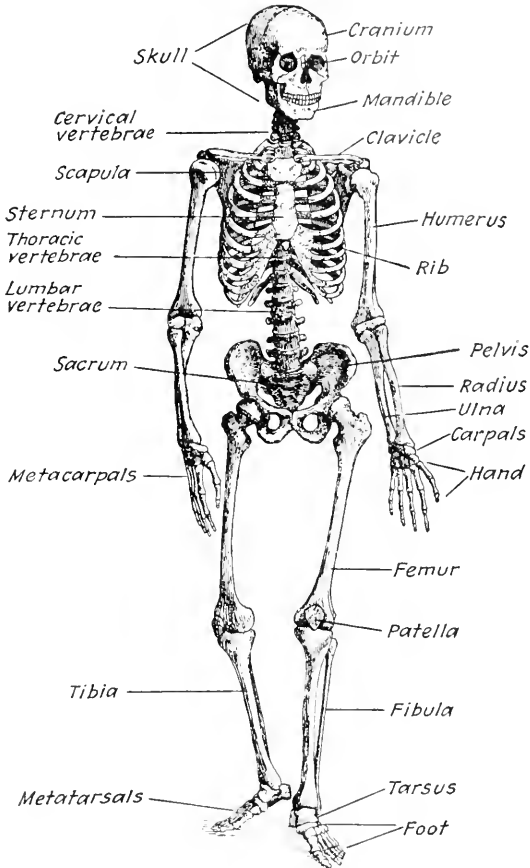

FIG. 213. - Human skeleton.

Although some cartilage always remains, the proportion of bone increases in the highest forms. In the embryological development of a vertebrate the same order is to be observed, the skeleton passing through membranous, cartilaginous, and bony stages. This is an illustration of the biogenetic law. When the bones develop they either replace cartilage, in which case they are known as *cartilage bones*, or they are formed in fibrous tissue, frequently around cartilage, when they are known as *membrane bones*.

Bone tissue consists of an intercellular matrix of salts of lime which masks the cellular elements. Under the microscope, however, the cells, called *bone corpuscles*, appear, lodged in spaces called *lacunae*. Small canals called *canaliculi* run from one lacuna to another and contain the branching processes of the cells. In the living animal the bones are surrounded, except on articular surfaces, by a fibrous covering, or *periosteum*, firmly anchored by fibers which penetrate the bone itself; the articular surfaces are covered with cartilage. Blood vessels and nerves enter the mass and are distributed through it, reaching, in many bones, a central cavity containing marrow. The *marrow* is a form of connective tissue composed largely of cells, from which are produced the new red blood corpuscles needed continually to replace those worn out by use. Bones are bound together and held in place by fibrous ligaments.

The skull may be divided into two parts, a cranial part, or *cranium*, made up of the bones which surround the brain, and a *visceral part*, which includes the bones developed about the mouth and nasal chambers. To the latter are added other bones which lie in lower forms about the gill slits and which in the higher forms are more or less intimately associated with the skull.

The vertebral column consists of a series of individual bones known as *vertebrae*. It extends through the neck, trunk, and tail and is divided into four regions. The *cervical* vertebrae are in the neck; the *thoracic* vertebrae in the anterior part of the trunk; the *sacral* vertebrae in the posterior part of the trunk where, with the pelvic girdle, they form the pelvis; and the *caudal* vertebrae in the tail. Ribs may be developed in connection with all the regions of the vertebral column, though they are most constant and reach their greatest development in the thoracic region, where in the highest forms they, together with the sternum, form a thoracic basket inclosing the lungs. Several ribless vertebrae lying between the thoracic and sacral regions, corresponding to what is known in the human body as the small of the back, are in the mammals recognized as a fifth region and called *lumbar* vertebrae.

The girdle to which is attached the anterior pair of appendages is known as the *pectoral girdle*. The girdle of the posterior appendages is known as the *pelvic girdle*, and with the sacral vertebrae forms the pelvis. The bones forming the skeletons of the two limbs correspond, and this correspondence may be brought out by reference to diagrams (Fig. 214). The homology between the limbs also includes blood vessels, muscles, and nerves.

345. Muscular System.—The voluntary muscles of vertebrates are usually attached to some part of the skeleton and are known collectively as the flesh of the animal. Their attachment is frequently by means of a tendon, which is a dense mass of parallel connective tissue fibers continuous on the one hand with the muscle sheaths and on the other intermin-

gled with the fibers of the periosteum. In some cases striated muscles have ceased to be under the control of the will and thus in a sense have become involuntary. Such are some of the muscles used in swallowing. The involuntary, or non-striated, muscles are found mostly in the walls of the alimentary canal and the blood vessels. The cardiac muscles are in the wall of the heart. Both involuntary and cardiac muscles are usually not recognized as part of the muscular system but as parts of the systems to which the organs containing them belong.

346. Digestive System.—The digestive systems of different vertebrates present many modifications. In general the system may be

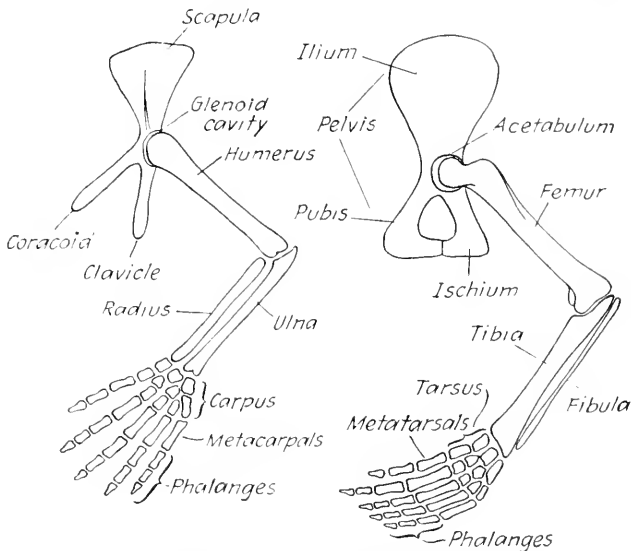

FIG. 214.—Diagram to illustrate the homology between the skeletons of the fore and hind limbs.

divided into an alimentary canal, beginning at the mouth and ending at the anus, and accessory organs, including glands connected to the alimentary canal by ducts. The regions of the alimentary canal are, in order, mouth, pharynx, esophagus, stomach, and small and large intestines (Fig. 215).

The mouth cavity, also called the *buccal cavity*, usually contains jaws bearing teeth for the mastication of the food and a tongue which is used in handling the food and may assist in securing it. In connection with the mouth may be several pairs of *salivary glands* the secretion of which, the saliva, contains an enzyme, *ptyalin*. This in an alkaline medium converts starches into sugars. The saliva also contains the secretion of mucous glands lying in the walls of the mouth; it serves to moisten the food and make its swallowing easier.

The *pharynx* in the lower vertebrates is respiratory in function, since in its walls lie the gill slits. In the higher forms it serves as a common passageway for the food from the mouth into the esophagus and for the air from the nasal chamber into the windpipe, or trachea.

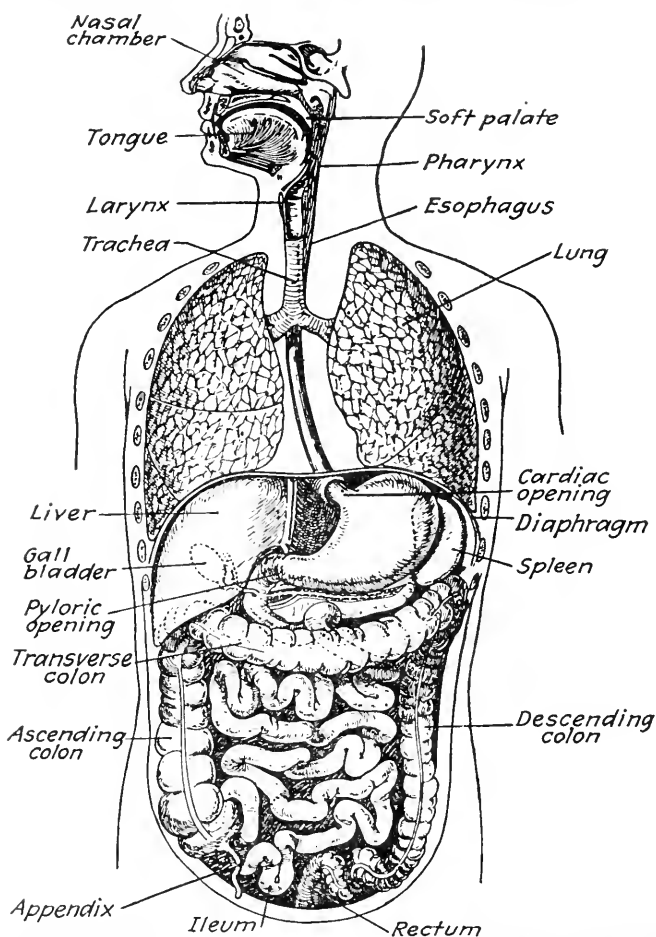

FIG. 215.—Alimentary canal of man. (From Sobotta, "Deskriptive Anatomie," by the courtesy of J. F. Lehmann's Verlag.)

The *esophagus* may be simply a passageway for food on its way to the stomach, or as in the case of many birds, it may be dilated to form a crop for the storage of food.

The *stomach* is an organ in which the food is reduced to liquid form and in which a certain amount of digestion takes place. In the walls of the stomach are glands which secrete *pepsin* and *rennin* and also hydrochloric acid, giving to the contents an acid reaction. The *rennin*, in this acid medium, serves to coagulate the protein of milk, separating it as the

curd, while the pepsin partially digests proteins, changing them to peptones. A sphincter muscle called the *pyloric valve* controls the passage of the food from the stomach into the small intestine and prevents the passing of any food which is not quite liquid. Thus as the food is gradually reduced to liquid form in the stomach it is passed in a series of spurts or jets into the intestine.

The *small intestine* is digestive and absorptive in function. Into it empty the ducts of two glands, the liver and the pancreas. In the secretion of the *pancreas* are several enzymes. These are (1) *trypsin*, which completes the conversion of proteins into peptones and also changes the peptones into amino acids, which can be absorbed; (2) *amyllopsin*, which forms soluble sugar from starches; and (3) *steapsin*, which changes fats into soluble fatty acids and glycerin, both of which are capable of being absorbed. The wall of the intestine also contains glands which secrete enzymes capable of changing nonabsorbable sugars into those which are absorbable. All of these enzymes act in an alkaline medium. The secretions poured into the intestine serve to neutralize the hydrochloric acid of the stomach and to render the food alkaline.

In the small intestine the digested food is absorbed into lymphatics and blood vessels which lie immediately under the lining epithelium. The absorbing surface of the intestine is increased by its length, usually much greater than that of the body, and also by the formation of folds and of very numerous minute finger-like projections called *villi* (Fig. 8).

The *liver* is the largest single organ in the body and has a variety of functions. In it is secreted the *bile*, which is stored in the *gall bladder* and passed into the intestine as needed. The bile assists in breaking up the fats and preparing them for absorption and is also antiseptic in its action. In addition to this the liver is a great storage organ where carbohydrates are accumulated in the form of *glycogen*, so that though the animal may be unable for some time to secure more, it has a supply sufficient to maintain muscular activity. In the liver protein wastes are broken up into urea, which is then carried by the blood to the kidneys where it is eliminated.

The *large intestine* contains mucous glands the secretions of which lubricate the passage. In the anterior part of it digestion and absorption are completed. In the posterior part, called the *rectum*, the undigestible residue is accumulated. Sphincter muscles control its passage from the body. In some vertebrates the anal opening is not upon the surface but upon the wall of a *cloaca*, into which also open the ducts from the excretory and reproductive systems. The cloaca in turn opens to the outside.

347. Respiratory System.—In the lower forms of vertebrates respiration occurs through the walls of the gill slits or through gills, which are branched projections from the walls of the slits. In terrestrial verte-

brates, however, is generally found a pair of *lungs* (Fig. 215), together with the windpipe, or trachea, and a voice box, or larynx. The lungs originate as outpocketings from the ventral side of the pharynx and are lined, as is the pharynx, with entodermal epithelium.

348. Circulatory System.—The blood in vertebrates consists of a fluid plasma in which float white corpuscles, red corpuscles, and blood platelets. The red corpuscles contain hemoglobin, which unites with oxygen to form oxyhemoglobin. In this form the blood carries a much greater amount of oxygen than could be carried if it were only in solution (Sec. 270). The carbon dioxide is carried in the plasma in combination as sodium carbonate. The white corpuscles, or *leucocytes*, are ameboid in character and are able to ingest and digest foreign particles, including unicellular organisms. These corpuscles escape from the blood through the walls of the capillaries and wander about in the looser tissues. They serve to rid the body of deleterious substances or may help to protect it from disease-producing germs. The blood platelets produce a substance active in bringing about the coagulation of the blood. It is believed that they are formed from white blood corpuscles. The fluid part of the blood, or plasma, contains in solution proteins which may be caused to coagulate, or clot. Clotting occurs whenever an opening is produced in the wall of a blood vessel and the clot blocks the opening, preventing excessive hemorrhage. When the clot is removed from the plasma, the fluid remaining is termed serum.

The circulatory system of vertebrates includes a central organ—the heart—which receives the blood returned from the body or, in certain cases, also from the lungs and sends it out again either over the body or to the lungs. In addition there is a closed system of vessels, including arteries, capillaries, and veins. It is through the walls of the capillaries that the interchange of gases and of food and waste takes place.

The circulatory system also includes the spleen and the lymphatics. The *spleen* (Fig. 215) is an organ in which old and useless red blood corpuscles are broken down and the products passed into the blood. The *lymphatic vessels* serve as an accessory return circulation, picking up the plasma which has leaked from the blood vessels all over the body, together with white corpuscles which may be added to it, and pouring both back into the veins a short distance from the heart. This fluid containing plasma and white corpuscles is called *lymph*. Into the lymphatic system are also absorbed the products of fat digestion. At intervals along the lymphatic vessels are masses of tissue known as *lymph nodes*, or lymph glands, in which are formed the white blood corpuscles and in which foreign particles and infectious organisms are removed from the lymph before it is added to the blood.

349. Excretory System.—The excretory system consists of the kidneys, the ducts leading from them, and in some cases a bladder.

The *kidneys* serve for the elimination of liquid waste which contains the end products of metabolism. The ducts connected directly to the kidneys are known as *ureters*; they meet to form the *urethra*. Where

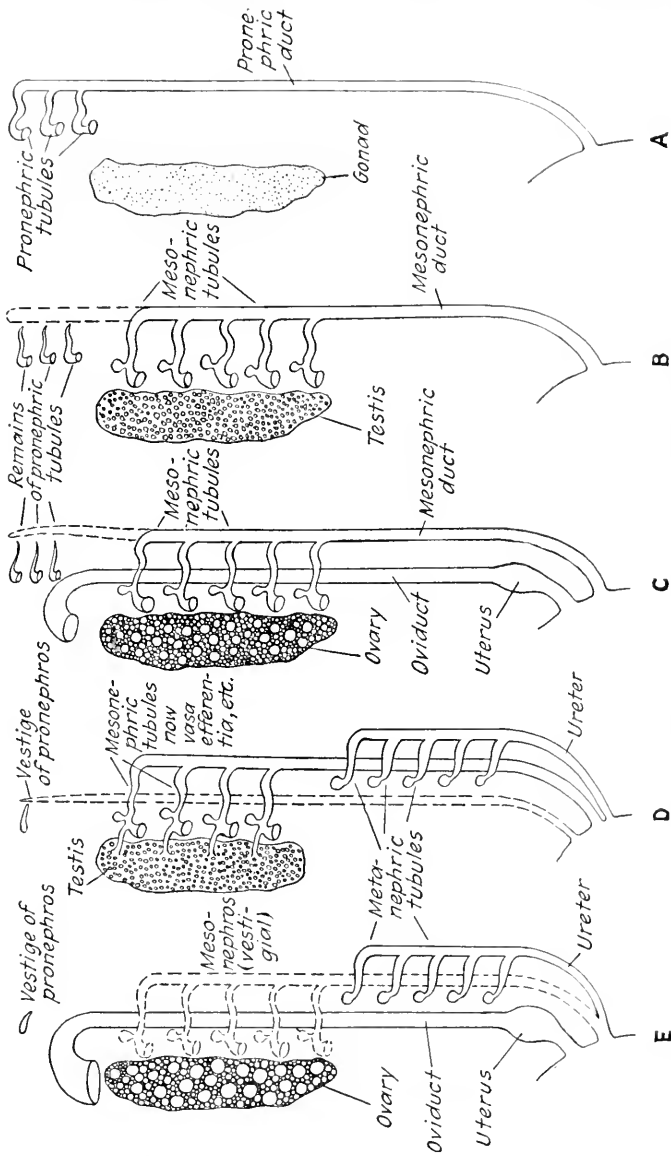

FIG. 216.—Diagrams of different types of kidneys. A, pronephros; B, mesonephros, male; C, mesonephros, female; D, metanephros, male; E, metanephros, female.

they meet, a *bladder* may be developed in which the urine is stored before being passed out of the body.

There are three types of kidneys in the vertebrates, all similar in plan, which involves a series of nephridial tubules metamericly arranged

(Fig. 216). If these tubules belong to metameres located far forward in the body, the organ is called a *pronephros*, or head kidney; such tubules open freely into the coelom by a ciliated funnel and take the waste from it (Fig. 217). The vascular organ which passes the excretions from the blood into the coelom is known as a *glomus*. If the metameres represented are farther back, the organ is called a *mesonephros*; each

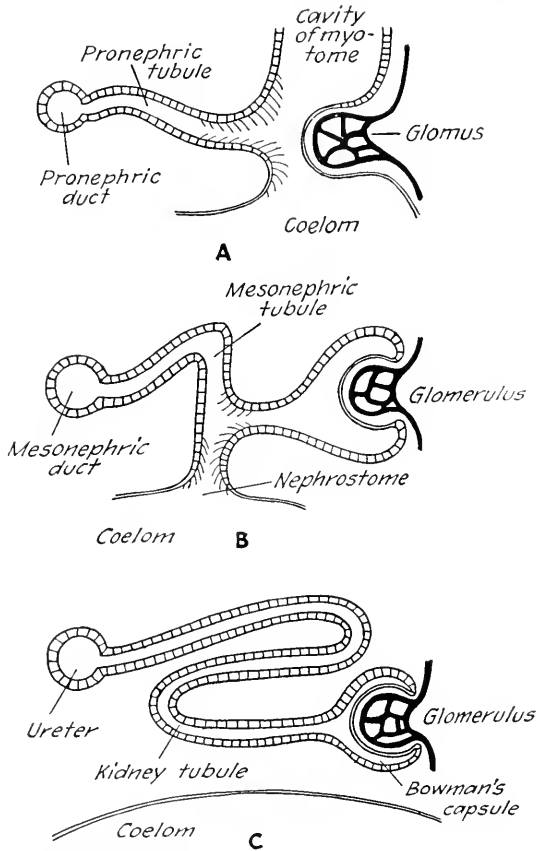

FIG. 217.—Diagrams to show relations of kidney tubules. A, pronephros; B, mesonephros; C, metanephros.

mesonephric tubule, while still opening into the coelom, takes the excretions from a knot of capillaries known as a *glomerulus*. The third type, or *metanephros*, originates still farther posteriorly; the metanephric tubules do not communicate with the coelom, but each ends in a cuplike cavity inclosing a glomerulus. These appear to form both a phylogenetic and an ontogenetic series. The pronephros is functional only in the lowest group of vertebrates; although it appears early in the embryological development of all higher forms, only vestiges remain in the adults of the highest. The mesonephros is functional up to and including the

Amphibia; it appears in early stages in the development of still higher forms and also becomes vestigial in the adults of these forms. The metanephros is the functional kidney of the reptiles, birds, and mammals. This, therefore, is another illustration of the biogenetic law.

350. Nervous System.—The nervous system of a vertebrate consists of a brain and a spinal cord, together forming the *central nervous system*; and of nerves, ganglia, and sense organs, forming the *peripheral nervous system*. The nerves which lead to and from the brain or spinal cord are called respectively cranial or spinal nerves and form the *cerebrospinal system*. They receive afferent impulses from various sense organs which they carry to the appropriate center and efferent impulses which they conduct from nerve centers to active organs, such as muscles and

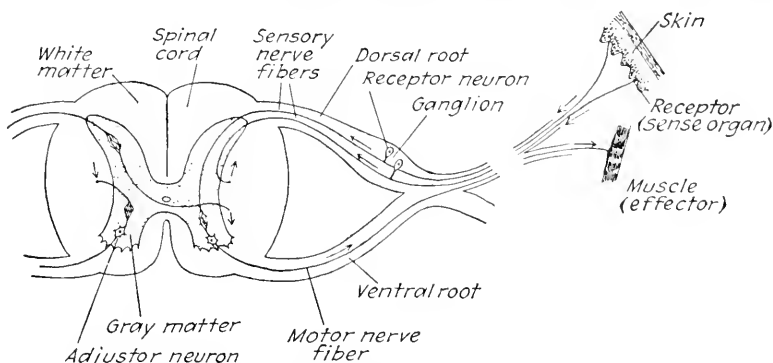

FIG. 218.—Diagrammatic cross section of spinal cord and diagram of a spinal nerve. To show reflex paths; should be compared with Fig. 142.

glands (Fig. 218). Peripheral ganglia connected with these and situated in various parts of the body serve as local centers for the control of certain localized activities. Ganglia of that character are similar in function to the central ganglia of animals in the lower phyla.

There is also a portion of the peripheral nervous system, including both ganglia and nerves, which is to a considerable degree detached from the rest and which carries on its functions mostly without any interference from the central nervous system. For this reason it is known as the *autonomic nervous system*. The nerve fibers belonging to the cerebrospinal system run from origin to destination without branching; this serves to keep the impulses separate and distinct, as is necessary in all voluntary action. Those of the autonomic system, however, branch freely, causing the effect of any stimulus to be radiated in all directions. The system is thus very widely affected by stimuli, which suggests the term sympathetic, also applied to it. This system controls the involuntary muscles of the body. Its nerves run to and from the various regions of the alimentary canal and through the cerebrospinal nerves fibers from it reach all of the blood vessels throughout

the body, where they control the involuntary muscles in the walls of these vessels. The largest ganglion in this system, the *semilunar ganglion*, is situated in the upper part of the abdominal cavity. It gives off nerves to the liver, stomach, and other neighboring organs.

The brain, or *encephalon*, originates in the embryo as a dilated portion of the neural tube, divided at first into three parts known respectively as the forebrain, mid-brain, and hind-brain. It becomes divided later into five parts, the forebrain and the hind-brain each being again divided into two. From the anterior part of the forebrain, or *telencephalon*, are developed the cerebral hemispheres, which are prolonged anteriorly into a pair of olfactory lobes. The other part of the forebrain lies below or behind the cerebral hemispheres and is known as the tween-brain, or *diencephalon*. From the mid-brain, or *mesencephalon*, are developed the optic lobes. From the two parts of the hind-brain come the cerebellum, or *metencephalon*, and the medulla, also called medulla oblongata, the *myelencephalon*. In the wall of the brain, the gray matter, which contains nerve cells, is on the outside, and the white matter, which is made up of bundles of nerve fibers, is on the inside.

In the spinal cord the relationship of gray matter and white matter is reversed (Fig. 218). The gray matter, the original medullary tube developed in the embryo, is within, and the fibers from the brain which reach the surface in the medulla, together with fibers derived from the cells of the spinal cord itself, form a sheath of white matter on the surface. Each spinal nerve arises by two roots, dorsal and ventral. The *dorsal root* is made up of afferent fibers and bears a ganglion in which are the cell bodies connected with these fibers; the *ventral root* contains the efferent fibers.

In the earthworm the receptor neurons are located on the surface; in the chordates they lie in the ganglia of the dorsal roots of the spinal nerves. In the latter epithelial sense cells, forming *receptors*, receive the stimuli and start impulses in the sensory fibers, which are the dendrites of the receptor neurons. These impulses pass through the dorsal root ganglia and by the axons of the receptor neurons into the cord, where through synapses they are delivered to the adjustor neurons (Fig. 218). Part of the cranial nerves correspond to the dorsal, or sensory, roots of spinal nerves; others, to ventral, or motor, roots; and still others, to the two united.

351. Sense Organs.—Vertebrates possess a number of highly developed sense organs, or receptors. Some of these are stimulated by contact; among them are various types of cutaneous sense organs, including receptors for pain and temperature, as well as lateral line organs, and also organs of hearing. Others, such as organs of taste and smell, respond to chemical stimulation; and eyes serve for the reception of light. There are also internal receptors which function mostly in muscular

control and in the directing of the activities of the alimentary canal. The organs of equilibrium belong to the last category but will be considered in connection with the ear.

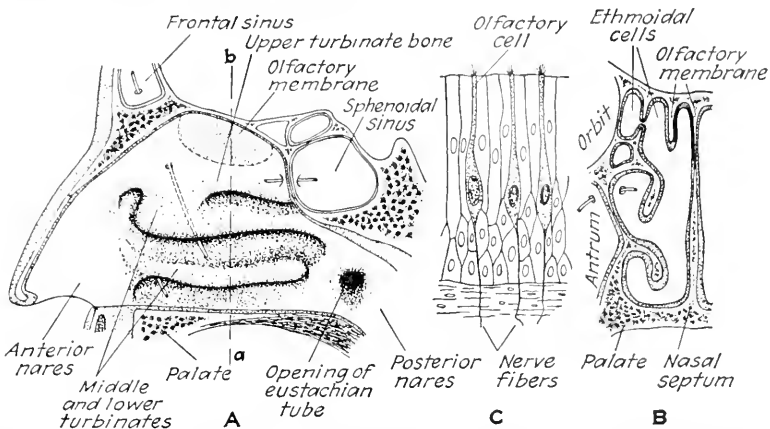

FIG. 219.—Olfactory organ in man. A, view of side wall of the nasal cavity to show distribution of olfactory epithelium. Probes are passed through the passages leading to the frontal sinus, the sphenoidal sinus, and the antrum in the cheek bone, all of which may be infected from the nose. Olfactory membrane stippled. B, vertical section, made on line *ab* in Fig. A, showing the nasal cavity of one side, with the nasal septum. A probe is passed through the passage to the antrum. Olfactory membrane black. C, section of a portion of the olfactory mucous membrane; highly magnified.

A variety of *tactile organs* is found in various vertebrates and on different parts of the body, but they share a common plan. Nerve endings occur between epithelial cells, and the impulses are produced by the mechanical stimulation due to pressure upon these delicate endings.

The *lateral line organs*, which are found along the sides of the bodies and about the heads of some aquatic vertebrates, have for a long time puzzled zoologists and have had attributed to them various functions. Recent investigations by Parker, however, seem to show that these are stimulated by vibrations in the water of too great wave length and too little frequency to cause sensations of sound and that they give to the animal information concerning movements in the water which are important in the securing of food, the avoidance of enemies, and adjustment to currents.

The most important *organs of smell* (Fig. 219) consist of sheets of sensory epithelial cells situated in the nasal passages. Substances carried through the air in the form of fine particles fall upon this sensory epithelium and are dissolved in the fluid secreted on its surface. The cells are stimulated chemically, and the result is the

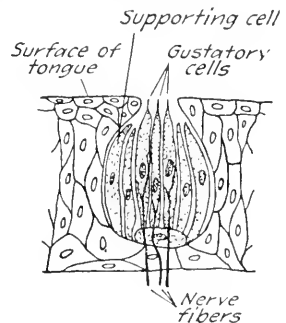

FIG. 220.—Human taste bud, somewhat diagrammatic. Highly magnified.

sensation which is called smell. Small particles entering the mouth through the air and being dissolved in the saliva or entering it in solution can affect in a similar way groups of cells known as *taste buds* (Fig. 220) on the surface of the tongue, soft palate, or pharynx and cause a sensation which is recognized as taste. From what has been said it is evident that the senses of smell and taste are allied and that one may both smell and taste a substance at the same time. In some aquatic animals taste buds also occur on the outer surface of the head and especially on the soft barbels of such fish as the catfish and bullhead.

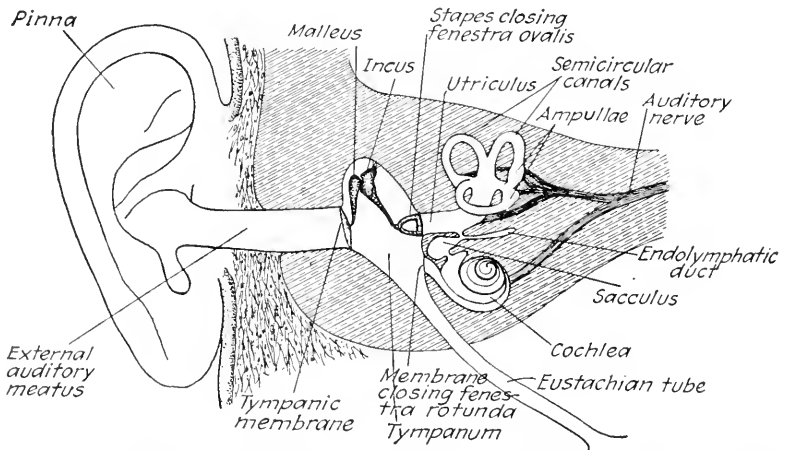

FIG. 221.—Diagrammatic section of the human ear. Cavities unshaded. The cochlea is shown made up of three coils, each divided by a continuous membrane which is not continued to the tip. In this way the cavity of the cochlea is divided into two parts, the *scala vestibuli*, which opens into the sacculus, and the *scala tympani*, the end of which is shut off from the tympanum by a membrane closing the *fenestra rotunda*, also called *fenestra cochlearis*. The two *scalae* communicate at the tip of the cochlea.

352. Ear.—The ear of vertebrates may consist of three parts (Fig. 221). These are the inner ear, which is present in all forms and which contains the essential organs of hearing and equilibrium; the middle ear, which is found only in the Amphibia and in higher classes of vertebrates; and the outer ear, which is confined to the reptiles, birds, and mammals. The outer ear is well developed only in the mammals, in which is usually added a broadly expanded *pinna*—the visible part and that ordinarily called the ear. The human ear, as an example of the most highly developed auditory organ, will be described.

The *inner ear* is inclosed in the temporal bone, which forms a part of the side wall of the cranium. It consists of cavities and canals, surrounded by a fibrous membrane, which together form the *membranous labyrinth*. These in turn are fitted into a system of bony spaces forming the *bony labyrinth*. Lymph fills the membranous labyrinth and occupies the space between it and the bony labyrinth. The membranous labyrinth

includes one chamber known as the *sacculus*, in connection with which is the organ of hearing, and another known as the *utricleus*, in connection with which is the organ of equilibrium. The two cavities—*sacculus* and *utricleus*—communicate with one another through the *endolymphatic duct*, and each has a potential opening into the middle ear.

The *sacculus* is the ventrally situated chamber. In connection with it is a spirally coiled canal known as the *cochlea* (Fig. 222). In the canal of the cochlea is a sheet of sensory cells known as the *organ of Corti*, which is the essential organ of hearing. Sound waves stimulating these cells mechanically give rise to impulses which, transmitted by the auditory nerve, are interpreted by the brain as sensations of sound. In connection with the *utricleus*, which is the more dorsal chamber, are three *semi-circular canals* lying in three planes. At the end of each of these canals

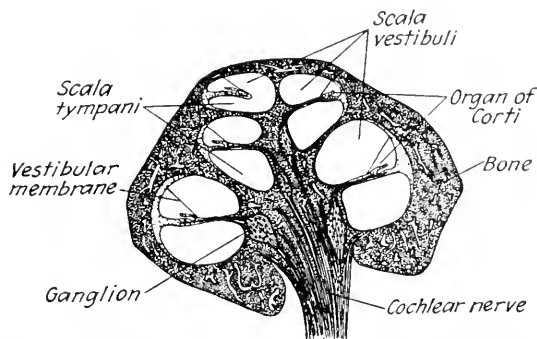

FIG. 222.—Section of the cochlea showing the two scalae, which communicate at the tip of the coils, and the essential organ of hearing, the organ of Corti, lying in a part of the scala vestibuli separated from the rest by a thin membrane, called the vestibular membrane, or membrane of Reissner. The mass of bone surrounding the cochlea is shown cut away from the rest of the temporal bone, in which the whole auditory organ is contained.

is a dilatation known as an *ampulla*, in which are sensory hairs which, when the body is moved, are stimulated by waves of movement in the lymph and give a sense of position or of equilibrium. The opening from the *utricleus* into the middle ear, known as the *fenestra ovalis*, is closed by the innermost of three bones known as the *stapes*, while the opening from the *sacculus* into the middle ear, the *fenestra rotunda*, is closed by a thin membrane.

The *middle ear* is known as the *tympanum*. It is a cavity filled with air across which sound waves are conducted by a chain of three bones called, from without inward, *malleus*, *incus*, and *stapes*. The first two of these are represented in amphibians, reptiles, and birds by one bone, the *columella*. This cavity is in communication through the *eustachian tube* with the cavity of the pharynx and thus opens to the outside.

The *outer ear* is separated from the middle ear by a *tympanic membrane*. Sound waves entering the outer ear set this membrane into vibra-

tion; these vibrations are transmitted by the bones of the middle ear to the fluid which fills the inner ear and by this fluid to the sensory cells in the cochlea.

The withdrawal of the inner ear from the surface and its lodgment in a cavity in the skull are clearly in the interest of greater protection to an organ which has acquired a more delicate adjustment in the higher forms. The chain of ossicles forms a very sensitive sound-conducting apparatus. The connection of the middle ear with the pharynx adjusts the pressure in the middle ear to changing air pressures outside the body. As the pressure of the surrounding air rises or falls, the tympanic membrane would be forced inward or outward if it were not that through the eustachian tube air enters or leaves the middle ear, thus equalizing the pressures on the two sides of the membrane. Pressures are equalized as between the middle and inner ear by the elasticity of the membrane closing the opening in the wall of the sacculus. When the pressure in the middle ear rises, this membrane is bent inward, and the pressure within the inner ear is correspondingly increased; when the pressure in the middle ear falls, the membrane is bent outward, and the pressure in the inner ear is correspondingly diminished.

353. Eye.—The eye is the organ of sight and consists of a variety of structures which contribute to this function. The *eyeball*, which is the organ of sight proper, is somewhat like a roughly spherical camera (Fig. 223). Its wall is composed of three layers. These are the outer, or *sclerotic*, layer, which gives support; the middle, or *choroid*, layer, which is vascular; and the inner, or *retinal*, layer, which is sensory. Light is admitted through a transparent *cornea*, which is the anterior portion of the sclerotic coat. The amount of light falling upon the sensitive retina is regulated by a circular curtain, the *iris*, a part of the choroid layer; the central opening in the iris is the *pupil*. Just behind the iris is the *lens*, by means of which the rays of light, which have to a degree been brought together by the convex cornea, are focused on the retina. When light stimuli fall on the retina, they give rise to impulses which are conveyed to the brain and there produce the sensation of sight. Behind the retina is a *pigment layer* the function of which is not known. The cavity of the eye is divided into two chambers. The *outer chamber*, in front of the lens, is filled with watery *aqueous humor*; and the *inner chamber*, behind the lens, is filled with the jelly-like *vitreous body*. The outer chamber is again divided into the *anterior chamber* in front of the iris and the *posterior chamber* behind it. The structure of the eye can best be understood by reference to a diagram (Fig. 223).

Accommodation, which is the adjustment of the eye to far and near vision, is limited in the lower vertebrates but is well-developed in the higher ones. It may be described as it occurs in man. It should first be stated that the lens is elastic and tends of itself to become thicker

or more convex. It is inclosed in a thin fibrous capsule which is attached all around by a *suspensory ligament* to a body known as the *ciliary body*, to which also the iris is attached and which contains a muscle known as the *ciliary muscle*, in the form of a complete ring. All of these belong to the choroid layer. The tendency of the eyeball to maintain a globular form causes a tension on the lens capsule which serves to flatten the lens and to focus the eye for distance. When it is desired to focus on a near object, the ciliary muscle contracts. This pulls the margin of the suspensory ligament inward or toward the pupil, releases the tension of the capsule, and permits the lens to thicken or become more convex. Thus focusing on a distant object is not a muscular act, but focusing on a near object is. As an individual grows older this elasticity of the

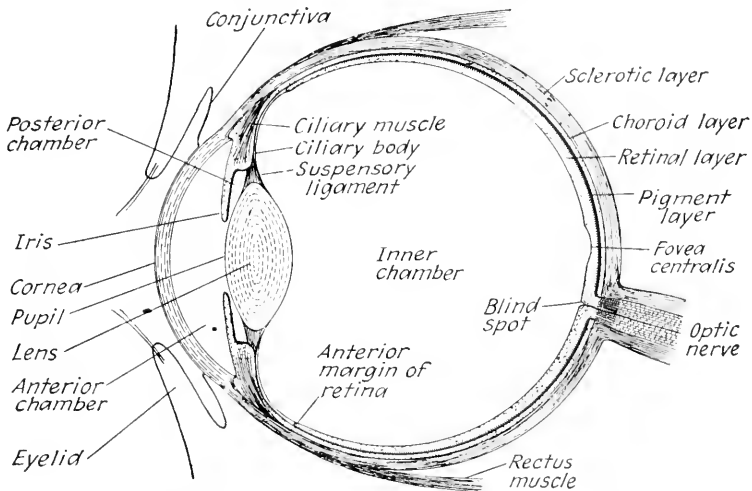

FIG. 223.—Somewhat diagrammatic section of the human eye.

lens becomes less and less, and thus, while old people with normal eyes find no serious difficulty in seeing things at a distance, they have to put on glasses to assist the eye in focusing on near objects and to enable them to read.

Accessory organs of sight are the *lids*, which protect the eye; the *lachrymal glands*, which secrete a fluid that bathes the free surface of the eyeball and prevents it from drying; and several muscles, which move the eyeball and point it in various directions.

354. Reproductive System.—All vertebrates are diecious, except the lowest group, the hagfishes. In the male the essential organs are the testes and the vas deferens; in the female they are the ovary and the oviduct. There may be present in the female, along the oviduct, glands which add albumen, shell, and pigment to the eggs, while in the male sex there may also be accessory organs of copulation. In most

lower vertebrates fertilization takes place in the water, both egg cells and sperm cells being passed out of the body of the parents. In terrestrial vertebrates, however, internal fertilization is the rule. Internal fertilization is usually accompanied by egg laying, and the young develop outside the body. Thus these forms are oviparous. In all groups of vertebrates, however, occur those animals which are viviparous; and the mammals, almost without exception, possess that character.

355. Advances Shown by Vertebrates.—The advances shown by the chordates, as enumerated in Chap. XLVIII, give to them advantages over all other animals, and in the highest vertebrates there result the most efficient types of animal life this earth has yet known. As a group the vertebrates are the largest and most powerful of animal types; they are the most complex in structure and at the same time their functions are most perfectly coordinated; and their sense organs, if not the most varied, are at least the most effective in furnishing to their possessors knowledge of their environments. Far ahead of any other system in the extent to which its development has been carried is the nervous system the functioning of which is such as to lift the higher vertebrates much above all other animals.

356. Classification.—Vertebrates are divided into seven classes as follows:

1. *Cyclostomata* (sī klō stō' mā tā; G., *kyklos*, circle, and *stomatos*, mouth).—Roundmouths, including hagfishes and lampreys.

2. *Elasmobranchii* (ē lās mō brān' kī ī; G., *elasmos*, metal plate, and L., *branchia*, gill).—Including sharks, skates, and rays.

3. *Pisces* (pīs' sēs; L., *pisces*, fishes).—Fishes, including all ganoids, teleosts, and lungfishes.

4. *Amphibia* (ām fib' ī ā; G., *amphibios*, leading a double life).—Salamanders, frogs, and toads.

5. *Reptilia* (rēp til' ī ā; L., *reptilis*, creeping).—Lizards, snakes, turtles, and crocodiles.

6. *Aves* (ā' vēz; L., *aves*, birds).—Birds.

7. *Mammalia* (mā mā' lī ā; L., *mammalis*, of the breast).—Mammals.

CHAPTER LI

CLASS CYCLOSTOMATA

The cyclostomes are frequently separated from the other classes of vertebrates to form a group higher in rank than a class but known by the same name, Cyclostomata. Such a group is coordinate with Gnathostomata (năth ō stō' mā tā; G., *gnathos*, jaw, and *stomatos*, mouth), which includes all the other classes. The lack of jaws and

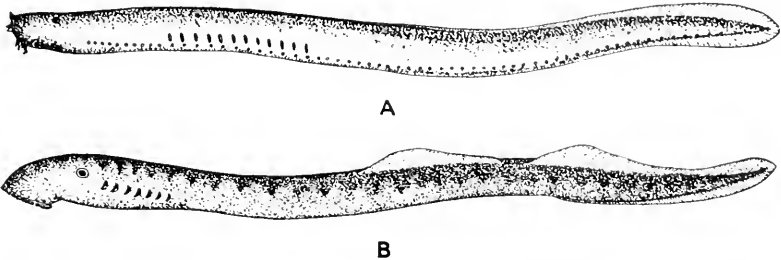

FIG. 224.—Cyclostomes. A, California hagfish, *Polistotrema stouti* (Lockington), with 12 gill slits. $\times \frac{1}{3}$. (From Châlester, "Zoology," after Dean.) B, sea lamprey, *Petromyzon marinus* Linnaeus, with seven gill slits. $\times \frac{1}{8}$. From preserved specimen.

teeth, which are replaced by a suctorial mouth, is the most prominent characteristic of the cyclostomes. They also have an elongated, eel-like body with a leathery skin devoid of scales, are without paired appendages, possess a fibrous skeleton to which in one type is added some cartilage, have a single olfactory pit, and seven or more gill slits. They also differ from fishes in having no air bladder, oviducts, or cloaca. While free-living when young and feeding upon small particles in the water, they are as adults generally parasitic on other fishes.

357. Classification.—The cyclostomes are divided into two subclasses. The first of these, Myxinoidea (mĭk sĭ noi' dē à; G., *myxinos*, slime fish, and *eidōs*, form), includes the hagfishes; the second, Petromyzontia (pĕt rō mī zōn' tĭ à; G., *petra*, stone, and *myzontos*, sucked in), contains forms known popularly as lampreys, or sometimes as lamprey eels. The latter name, however, is not correct since the eels, properly speaking, are bony fishes.

358. Myxinoids.—The myxinoids, or hagfishes (Fig. 224A), are noteworthy because of the enormous amount of slime they secrete when captured and confined in a small space, one large specimen being said to produce enough to fill a bucket. Hagfishes do not lead a strictly parasitic

life, since they commonly enter the gills or mouths of dead fishes and remain in the body, feeding upon it, until they have completely destroyed all but the skin and skeleton. They also may attack living fish, if these are disabled. Marked characteristics are the possession of four pairs of tentacles around the mouth, the presence of but one semicircular canal in the inner ear, a large number of gill slits, and a functional pronephros in the adult. There is no metamorphosis in the hagfishes.

359. Lampreys.—The mouth of the lampreys (Fig. 224B) is provided with an oral funnel armed with chitinous teeth (Fig. 225). Cartilages are present in the skull, about the notochord, around the gills, and in connection with the fins, but the notochord remains in full development. The number of gill slits is usually seven. The functional kidney in the adult is a mesonephros. The ureter opens into a urinogenital sinus, which also receives the sex cells liberated in the body cavity from the

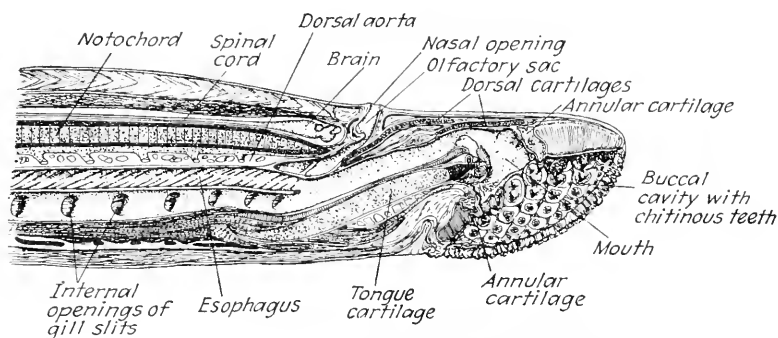

FIG. 225.—Median longitudinal section of the anterior part of the body of an adult sea lamprey. From a specimen. $\times 34$.

gonad. The brain is primitive, in many respects resembles that of the embryos of higher forms, and has a very small cerebellum (Fig. 226). The spinal cord is much flattened dorsoventrally. There are two semicircular canals in the ear.

Lampreys live in both fresh and salt water and are active and voracious, attacking fish much larger than themselves. They attach themselves to their prey by means of the sucker-like oral funnel, which is prevented from slipping by the chitinous teeth it contains. The flesh of the fish is then lacerated with the sharp chitinous end of the tongue so that blood and lymph can be sucked from the body. When the body of the fish has been drained of its fluids or the lamprey is filled, the latter loosens its hold, and the former goes away with an open sore which usually becomes infected and results in its death. Lampreys are, therefore, serious enemies of fish.

The larva, called an *ammocoetes*, has an oral hood something like that of amphioxus, a median eye, an endostyle, also resembling that of

amphioxus, and undergoes a metamorphosis when it becomes adult. In the adult the endostyle becomes the thyroid gland.

360. Relationship of the Cyclostomes.—The characteristics which have been given for these animals show distinctly adaptation to a parasitic mode of life. However, the relatively large number of gill slits, the presence of a functional pronephros in the adult hagfish, and the condition

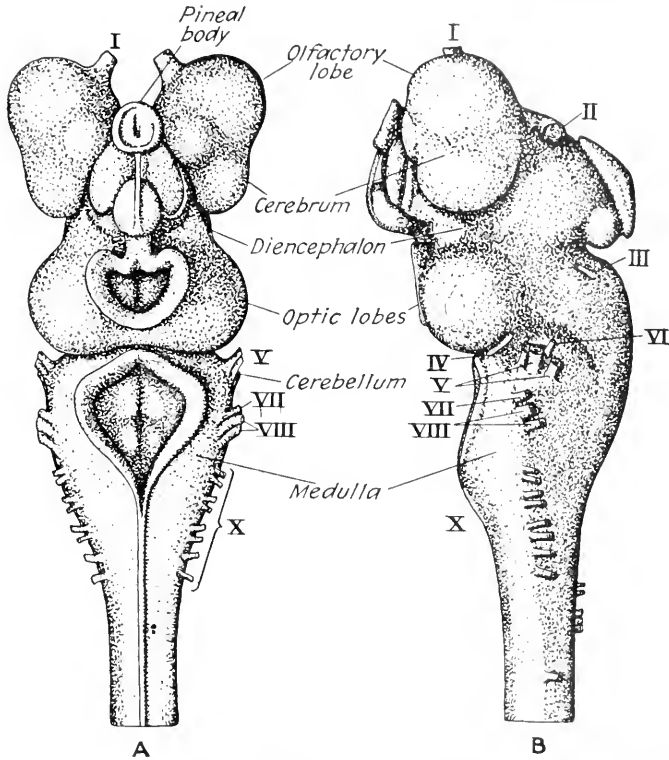

FIG. 226.—Brain of lamprey. A, dorsal view; B, lateral view. (From a Ziegler model, after Wiedersheim.) The roots of the cranial nerves are marked by roman numerals.

of the brain all point to the fact that the cyclostomes are more primitive than other vertebrates. Some of the amphioxus-like characteristics of the larval lamprey seem to show the inheritance of characteristics possessed by a common ancestor of both cephalochordates and vertebrates.

361. Economic Importance.—The hagfish has never been an article of food, but the flesh of the lamprey is sometimes eaten both in Europe and in America. Both of these animals, however, are to be considered as economically injurious.

CHAPTER LII

CLASS ELASMOBRANCHII

The elasmobranchs are very different from the cyclostomes and in many respects resemble the true fishes. They have paired fins, jaws, fishlike gill arches, and gills. There is a well-developed cartilaginous skeleton. They differ, however, from the true fishes in the following respects: (1) There is no bone in the skeleton; (2) the paired fins do not have fin rays; (3) they possess a peculiar type of scale known

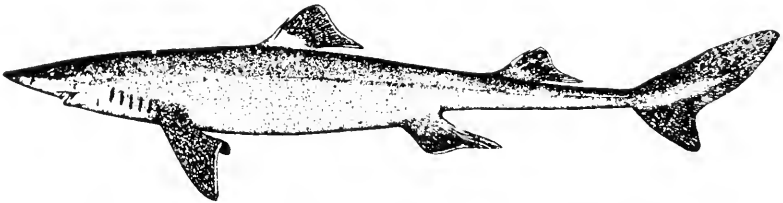

FIG. 227.—Dogfish shark, *Squalus acanthias* Linnaeus. $\times 1_{10}$. (From Jordan, "Guide to the Study of Fishes," by the courtesy of D. Appleton & Company.)

as the placoid scale; (4) the openings of the gill slits are exposed; and (5) they have a spiral valve. A dogfish shark is usually selected as the type of Elasmobranchii.

362. Dogfish Sharks.—The dogfish sharks belonging to the genera *Squalus* and *Acanthias* are abundant in both the north Atlantic and north Pacific oceans. Their bodies are fusiform, or spindle-shaped (Fig. 227); they do not reach a large size, being not more than four or five feet in length. They possess two dorsal fins, each of which in *Squalus* has a spine in front of it, a caudal fin, and pectoral and pelvic fins. The caudal fin is of a type known as *heterocercal*—that is, its dorsal lobe is larger than the ventral lobe. A portion of the pelvic fins is modified in the male sex forming organs known as *claspers*, which are used in copulation.

The mouth is a transverse slit on the ventral side of the head, and the jaws are armed with very sharp teeth the points of which are directed backward. Behind the teeth in use are numerous rows of other teeth, lying against the inner surface of the jaw, which are ready to be brought forward and replace teeth which may be lost. On each side are five gill slits. Behind each eye is an opening known as a *spiracle*, which develops like a gill slit but which in the adult is modified and is no longer functional as such. By means of the spiracle, however, water may be taken in for respiration when the mouth is full of food.

The body of the dogfish is covered with *placoid scales* (Fig. 237), each of which is composed of a sharp toothlike portion projecting through the skin and attached to a plate lying in the dermis. They neither overlap nor touch one another. The points of these scales are directed



FIG. 228.—Spiral valve of a ray. The arrow shows the direction in which the food passes. (From Wicman, "General Zoology," modified from Mayer, by the courtesy of McGraw-Hill Book Company, Inc.)

backward. They thus offer no resistance to the hand if the animal is stroked from the head to the tail, but when an attempt is made to stroke it firmly in the opposite direction they effectively resist the movement.

The stomach is U-shaped and is marked off from the intestine by a constriction containing a sphincter muscle. The characteristic feature of the digestive system of the dogfish is the presence in the intestine

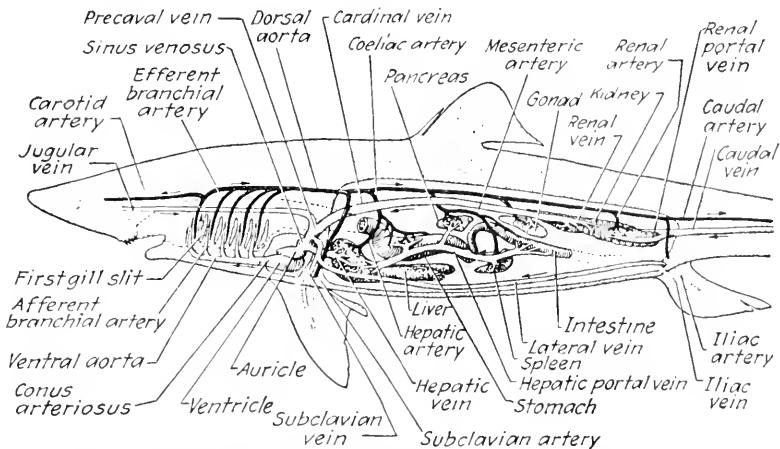

FIG. 229.—Diagrammatic lateral view of the circulatory system of a dogfish shark. Vessels carrying oxygenated, or arterial, blood in black, those carrying venous blood, light. (From Woodruff, "Animal Biology," by the courtesy of The Macmillan Company.)

of a spiral fold, the *spiral valve* (Fig. 228), which projects inward from the wall and which, by interfering with the direct passage of the food, increases the time during which it is in the intestine and therefore the time allowed for absorption.

The circulation of the dogfish is typical of fishes generally (Fig. 229). The blood passes from the ventricle forward in a *ventral aorta* and by afferent *branchial arteries* to a capillary network in the gills, where it is oxygenated and where the carbon dioxide is given off. It is collected again by efferent branchial arteries which carry it to the *dorsal aorta*,

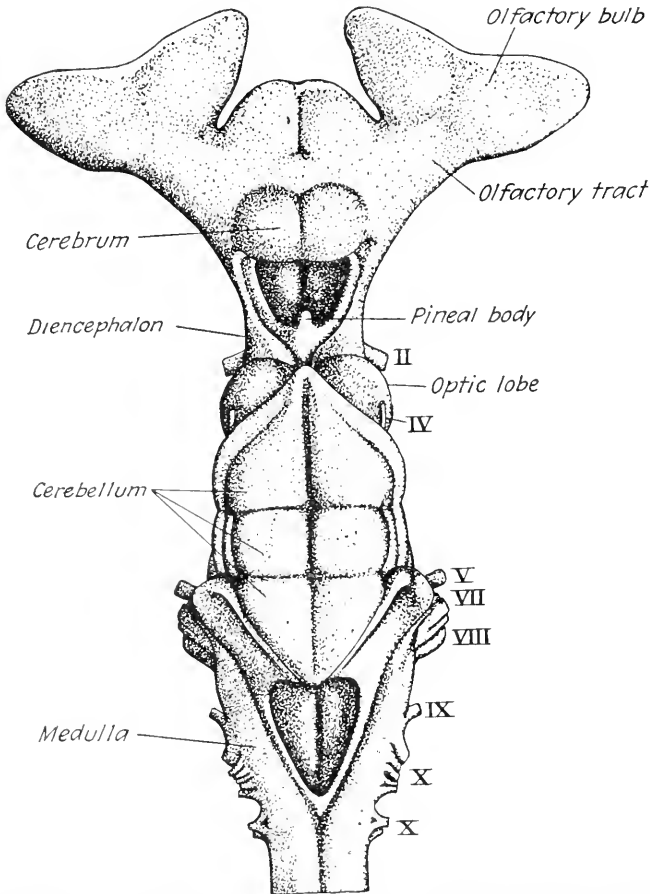

FIG. 230.—Brain of a European dogfish shark, *Scyllium canicula* Cuvier. Dorsal view. (From a Ziegler model, after Wiedersheim.) The roots of the cranial nerves are marked by roman numerals.

by which, in turn, it is distributed throughout the body. Returning from the peripheral vessels by the veins the blood is carried back to the heart, that from the tail passing through a *renal-portal system* in the kidney, that from the alimentary tract through a *hepatic-portal system* in the liver. A portal system is a capillary system interposed in the course of a vein. All of the venous blood is received by the *sinus venosus*, from which it passes into the *auricle*, or atrium, and then into the *ven-*

tricle. A dilated portion of the ventral aorta just in front of the ventricle is known as the *bulbus arteriosus*, or *conus arteriosus*.

The dogfish brain (Fig. 230) is much more highly developed than that of the cyclostomes, and three regions stand out prominently, these being the olfactory lobes, the optic lobes, and the cerebellum. The size of these three lobes is connected, respectively, with the high development of the sense of smell, the considerable development of the sense of sight, and the very delicate sense of equilibrium. The olfactory sac is correspondingly large and the eyes well-developed. Only the inner ear is present. It lies in the auditory capsule and consists of a utriculus with three semicircular canals and a small simple saeculus. There are lateral line organs and mucous canals on the head, the latter lodging organs similar in structure to the lateral line organs and which probably have a similar function. The kidney is a mesonephros.

Fertilization is internal and the eggs develop in a portion of the oviduct known as the uterus. The dogfish shark is viviparous, but when born the "pups" still possess a yolk sac.

363. Other Sharks.—A great variety of other sharks exist, many of which, unlike the dogfish shark, lay eggs. Such eggs are always provided with horny shells which protect them from injury after they are laid. Whale sharks are interesting because they grow to be the largest fish known, being said to reach sometimes a length of 50 feet. Fossil remains indicate the former existence of types still larger.

364. Skates and Rays.—Skates and rays are distinguished from sharks by the fact that the sides of the body are greatly extended, the whole animal being flattened dorsoventrally. The skates (Fig. 231), viewed from the upper side, have somewhat the shape of a kite with a sharp tail. The electric rays are more nearly circular in shape and have paired electric organs on the dorsal surface which are capable of giving a powerful electric shock. These *electric organs* are pillars of modified muscle cells, and the energy produced is turned into a difference in electrical potential instead of being expended in movement. The difference in potential between the two ends of such a pillar of cells is considerable, and the shock correspondingly severe. The sting rays have long flexible tails with spines which are capable of producing very serious wounds. Another interesting type is the sawfish. The body of the sawfish, which may attain a length of 20 feet, is not broadened like that of skates and rays, to which it is related, and the snout is greatly prolonged, reaching a length of half the rest of the body. The snout is armed on each side with a row of sharp teeth, which make it a very formidable weapon capable of cutting a gash in the body of even such an animal as the whale.

365. Extinct Elasmobranchs.—There are many extinct elasmobranchs, some of which are obviously more primitive than any now living

and also more primitive than any other known fishes, either living or extinct. They had a terminal mouth instead of a ventral one. The eggs were probably fertilized externally, since the male had no claspers. In them also the notochord persisted as a continuous rod, the vertebral column being little more developed than that of the cyclostomes. Their characteristics seem to point to a primitive fish ancestor which had an

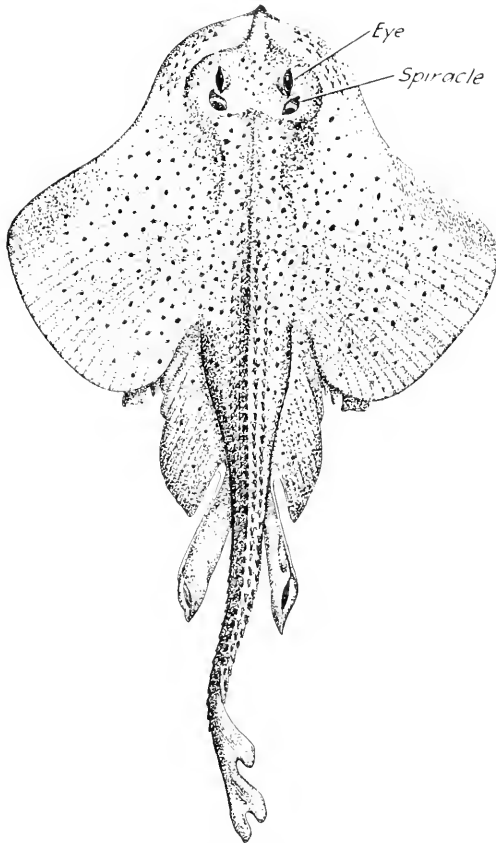

FIG. 231.—Common skate, *Raja erinacea* Mitchill. $\times 1\frac{1}{5}$. (Redrawn from Jordan "Guide to the Study of Fishes," by the courtesy of D. Appleton & Company.)

elongated spindle-shaped body, a mouth armed with dermal teeth, a greater number of gill slits than in any existing forms, paired fins, and a diphycecal tail fin made up of a single lobe.

366. Economic Facts.—Sharks have always been feared by man and undoubtedly at times they will attack human beings in the water. They are, however, less likely to do so than is generally supposed. One of the dogfish sharks found on the Atlantic coast is an important enemy of the lobster, and a second devours large numbers of valuable food fish. It is stated that the spined dogfish shark, *Squalus acanthias*

Linnaeus, also does serious damage by destroying nets, devouring captured fish, stealing bait, and driving away or destroying schools of squids used as bait. The damage done by these sharks to Massachusetts fishermen alone has been estimated at not less than \$400,000 per year. Sharks, however, have been made use of in various ways. From them is secured an oil; the flesh which remains after the removal of the oil is sold as a fertilizer; the skin has been tanned; and the flesh itself has been canned and sold commercially under the name of grayfish.

CHAPTER LIII

CLASS PISCES

The bony fishes, which form the third class of vertebrates, Pisces, include a large assemblage of types of an exceedingly varied character. They possess the following characteristics: (1) The skeleton is more or less bony, resulting from replacement in different degrees of the primitive cartilaginous skeleton. (2) The gills on each side are covered and protected by a fold, or *operculum*, supported by dermal bones. (3) The pelvic girdle is usually small or absent. (4) The fins are supported by fin rays. (5) The dermis contains scales of different types, but in no case are they placoid. (6) Most of the bony fishes have an air bladder. (7) The brain includes a small cerebrum, very small olfactory lobes, and well-developed optic lobes and cerebellum. Practically all of these characteristics present a contrast to those of the elasmobranchs.

367. Classification.—The class Pisces may be divided into two subclasses—Teleostomi (těl ē ōs' tō mī; G., *teleos*, complete, and *stoma*, mouth), or bony fishes proper, and Dipnoi (dīp' nō ī; G., *dipnoos*, with two breathing apertures), or lungfishes. There are four divisions of Teleostomi: (1) Crossopterygii (krō sōp tēr ĭj' ĭ ī; G., *krossoi*, fringe, and *pterygion*, fin), or lobe-finned ganoids; (2) Chondrostei (kōn drōs' tē ī; G., *chondros*, cartilage, and *osteon*, bone), or cartilaginous ganoids; (3) Holostei (hōl ōs' tē ī; G., *holos*, whole, and *osteon*, bone), or bony ganoids; and (4) Teleostei (těl ē ōs' tē ī; G., *teleos*, complete, and *osteon*, bone), which includes the common bony fishes and far exceeds in number of species all of the other divisions combined.

368. Crossopterygii.—The lobe-finned ganoids were very abundant in the Devonian period, twenty million years or more ago. Because fishes were the dominant form of animal life, this period is known as the age of fishes. The Crossopterygii, however, are now represented by only two types, both found in Africa. There are evidences that this group is ancestral not only to all higher fishes but also to the terrestrial vertebrates. A fact which indicates the last relationship is the existence of a larva which is very similar to the tadpoles of Amphibia. Both the larva and the adult use the pectoral fins as supporting appendages. The air bladder in *Polypterus* (Fig. 232), one of the two living types, is used not only as a hydrostatic organ but also as an accessory respiratory organ, being connected by a primitive trachea with the pharynx and used as a lung.

369. Chondrostei.—In the Chondrostei, or cartilaginous ganoids, the pelvic fins are not used to support the body, and the tadpole-like larva has been considerably modified. The skeleton is largely car-

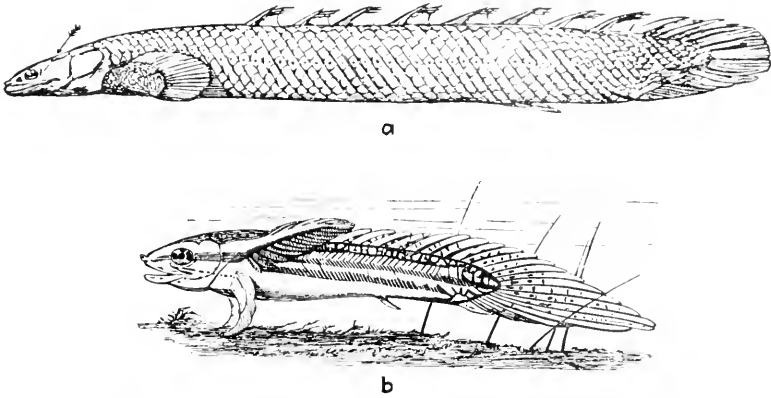

FIG. 232.—A crossopterygian, *Polypterus senegalus* Cuvier a, the adult. $\times \frac{1}{3}$. b, the larva. $\times 2\frac{2}{3}$. (a from Bridge, "Cambridge Natural History," b after Budgett, by the courtesy of The Macmillan Company.) The latter figure does not show the fact that the gills are alternately long and short. The arrow and line in Fig. a point to the position of the left spiracle.

tilaginous, but the cartilage is overlaid with dermal bones. The sturgeons (Fig. 233) are examples of this group.

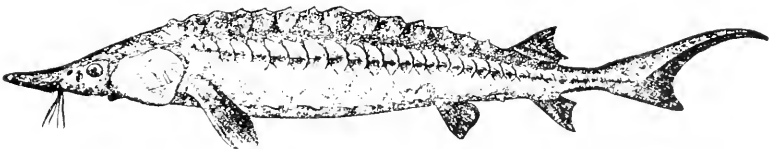

FIG. 233.—Lake sturgeon, *Acipenser rubicundus* LeSueur. $\times \frac{1}{18}$. (From Jordan, "Guide to the Study of Fishes," by the courtesy of D. Appleton & Company.)

370. Holostei.—The Holostei, or bony ganoids, have a completely ossified skeleton. In some the scales form a complete armor. Examples

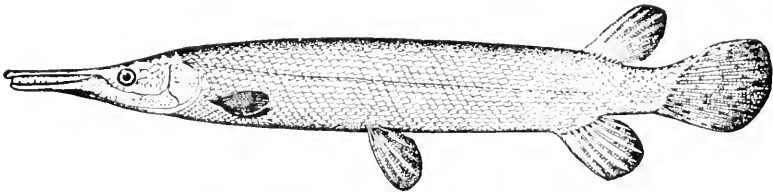

FIG. 234.—Alligator gar, *Lepisosteus tristoechus* (Block and Schneider). $\times \frac{1}{60}$. (From Jordan, "Guide to the Study of Fishes," by the courtesy of D. Appleton & Company.)

are the fresh-water dogfish, or bowfin, and the gars and gar pikes (Fig. 234). The development of the bowfin betrays primitive characteristics. The eggs are nearly holoblastic, and the early development is rather more

like that of a lobe-finned ganoid or an amphibian than like that of a bony fish.

371. Teleostei.—The teleosts are a large and relatively modern group, presenting now a variety and a number of species greater than at any previous time. In this division come the most of our food fishes (Fig. 235).

372. Dipnoi.—The lungfishes have for a long time been noteworthy among fishes because of the belief that they represented the forms from which amphibians and higher vertebrates arose. More recent investigations, however, seem to throw doubt upon this belief and to indicate that the lungfishes are degenerate descendants of the lobe-finned ganoids, which they resemble. When the bodies of water in

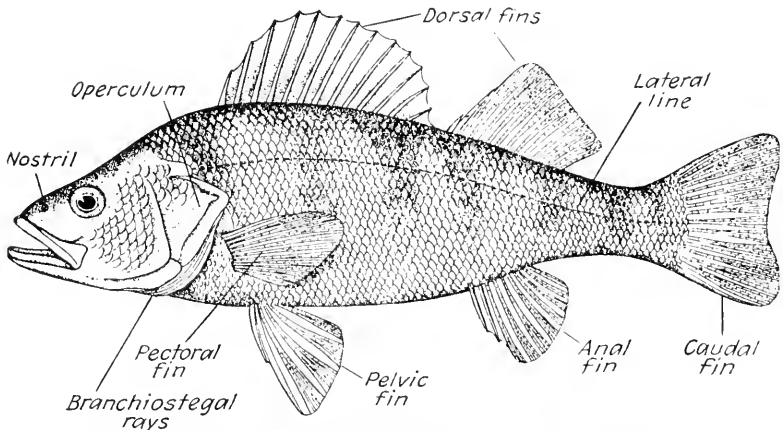

FIG. 235.—Common perch, *Percas flavescens* (Mitchill). $\times \frac{1}{3}$. Labeled to show features of a typical fish. (From Forbes and Richardson, "Fishes of Illinois.")

which they live dry up and become foul, lungfishes possess the ability to come to the surface and take air into their air bladder, which serves functionally as a lung. Others live in marshes and when these dry up the fish becomes dormant in the mud at the bottom, coiled in a burrow lined by a capsule of hardened mucus secreted by the glands of the skin. Within this capsule the lungfish remains, surrounded by a slimy mucus and breathing through an air hole the margin of which is turned inward to form a tube which is inserted in the mouth of the fish. During this time the air bladder is used constantly as a lung.

The lungfishes are represented by several types, one in Australia, another in Africa (Fig. 236), and a third in Paraguay. Not only do they have a tadpole-like larva similar to that of the Crossopterygii on the one hand and the Amphibia on the other, but they also have a more primitive type of embryogeny than that of any other living fish, the egg being holoblastic and gastrulation taking place by invagination.

373. Body Form.—The form of a primitive or typical fish is that of a spindle, broadest in front of the middle. This is also the shape of a submarine torpedo and is that shape which enables a body to cleave

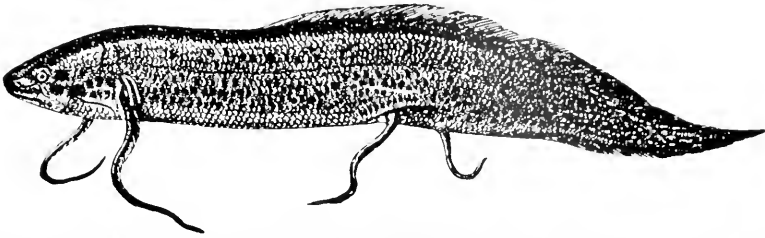

FIG. 236.—African lungfish, *Protopterus annectens* Owen. $\times 1_3$. (From Packard, "Zoology," after Boas, by the courtesy of Henry Holt & Company.)

the water with the least amount of retardation from resistance in front, friction laterally, or suction behind. The fins, being thin in the plane of movement, offer little interference.

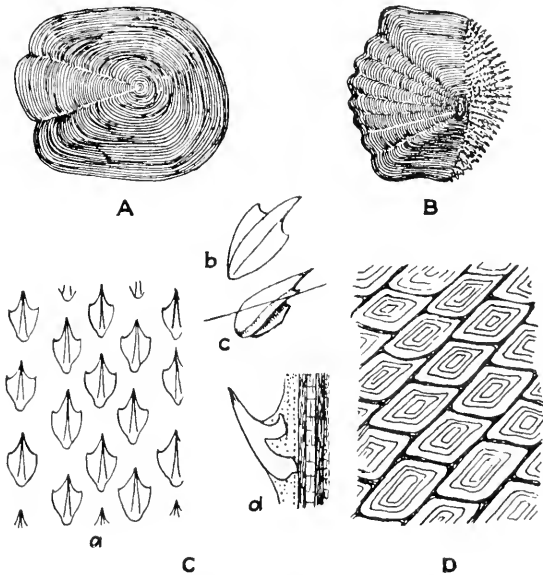

FIG. 237.—Scales of fishes. *A*, cycloid scale of northern pike, *Esox lucius* Linnaeus. $\times 8$. *B*, ctenoid scale of common perch, *Perca flavescens* (Mitchill). $\times 9$. *C*, placoid scales of dogfish shark, *Squalus acanthias* Linnaeus: *a*, surface view of a number; *b*, view of dorsal surface of one; *c*, side view of one, isolated, the surface level being indicated by a line; *d*, side view of one in position. *a*, $\times 30$; *b*, *c*, and *d*, $\times 60$. *D*, ganoid scales of *Lepisosteus osseus* (Linnaeus). $\times 2$.

Those fish which are built for speed or live in swift currents approximate the typical spindle shape; those which live in quiet waters tend to become flattened from side to side; and those which are adapted for life close to the bottom become flattened dorsoventrally. A slender,

eel-like body permits the animal so shaped to explore crevices. Many fishes, however, show modifications, often very curious, that fit into none of these general types.

374. Scales.—Most fishes possess a soft epidermis, below which are dermal scales. These are composed of bone and appear in several different forms (Fig. 237). *Placoid* scales are characteristic of elasmobranchs, and the types known as *cycloid* and *ctenoid* are found in the bony fishes. Scales of the two latter types overlap like shingles on a roof. Cycloid scales are elliptical in shape, are marked by concentric lines, and are found more frequently in the lower teleosts. In the ctenoid type the portion not overlapped by adjacent scales is covered with small, toothlike points. A fourth type of scale, the *ganoid* scale, has a hard external enamel-like covering of ganoin which is produced by the dermis. (True enamel is a product of the epidermis.) Ganoid scales may overlap, but in some cases they are rhombic in form and are arranged like tiles, meeting but not overlapping. In some fishes the scales are small and completely hidden in the skin, or they may, as in the catfishes, be entirely absent; in other cases, as in the trunk fishes, they form a complete bony box, the fins being articulated into openings in this box.

375. Fins.—The swimming appendages vary in number and precise location, but they are always of two kinds: (1) unpaired median fins, which include the *dorsal*, *caudal*, and *anal* fins; and (2) paired lateral fins, which include the *pectoral* and *pelvic*, or *ventral*, fins. The principal use of the fins is in locomotion, but various modifications for other purposes occur. By some fish they are used in walking; by others, such as the flying fish, they are used as gliding planes; or they may be modified to form sucking discs. The pelvic, and rarely the caudal, fins may be absent.

376. Locomotion.—In a fish the caudal fin is the principal locomotor organ, the paired fins being held closely against the side of the body in rapid movement and the other median fins being spread to maintain the vertical position. The body is relatively rigid anteriorly but toward the base of the tail it is very flexible. In rapid swimming the tail is carried from side to side in such a manner as to trace a figure 8, a path of motion similar to that of an oar in the sculling of a boat. The course taken by the fish is directed upward or downward and to either side by modification in the strength of the strokes of the caudal fin. In quiet maneuvering the paired lateral fins come into service, being used like oars. When the body is at rest they also serve to maintain equilibrium. If both paired fins are removed, a fish turns completely over with the ventral side upward, and removal of those of one side causes the fish to lie upon that side.

377. Air Bladder.—A characteristic organ in bony fishes is the *air bladder*, or swim bladder, which lies against the dorsal wall of the

coelom and which is a hydrostatic organ. It arises as an outgrowth from the anterior portion of the alimentary canal, and in the ganoids and in some teleosts a narrow open duct still connects the two. Through this duct water may enter and leave the air bladder. The organ tends to be divided into two chambers. The anterior chamber contains in its wall a so-called *red gland* which takes oxygen from the blood and passes it into the bladder; the posterior chamber is thin-walled and permits reabsorption of gases by the blood. In this way the amount of gases in the air bladder may be controlled. If more gases are passed into the air bladder, the specific gravity of the fish is lessened and it

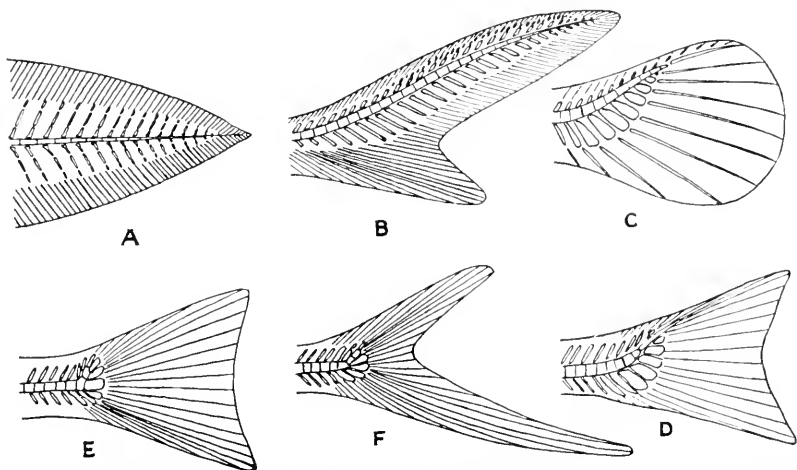

FIG. 238.—Diagrams to illustrate various types of caudal fins in fishes. *A*, diphyccercal type (dipnoan, *Protopterus*). *B*, heterocercal type (cartilaginous ganoid, sturgeon). *C*, homocercal type (bony ganoid, *Lepisosteus*). *D*, homocercal type (teleost, salmon). *E*, homocercal type (higher teleosts). These figures show a progressive series. *F*, a heterocercal type representing a secondary modification for a particular purpose (teleost, flying fish, *Cypselurus*).

rises in the water. If, on the contrary, gases are removed, the specific gravity is increased and the fish sinks. A fish, therefore, is able to maintain its position in the water without muscular effort and quietly to rise or sink in this manner. Some species, particularly bottom forms, have no air bladder.

378. Forms of Tails.—The caudal fins of fishes differ in shape, these differences being correlated with the habits of the fish (Fig. 238). The primitive type of tail is that which is evenly rounded dorsoventrally and consequently termed *diphyccercal*, or *protocercal*. This form is not exhibited by many living fishes but is common among extinct types. The *heterocercal* type in which the caudal fin is divided into two lobes, one lobe being larger than the other, has been described for the shark. This type of tail, when the dorsal lobe is the larger, gives greater strength

in swimming to strokes that would serve to direct the fish toward the bottom, and it is, therefore, possessed very largely by those forms which are bottom feeders. The presence of a tail of this type in the shark is correlated with the ventral position of the mouth and the fact that the animal turns over when it seizes an object on the surface. The larger ventral lobe of the flying fish enables it to attain a maximum speed as it leaves the water. A third type is the *homocercal* type, in which case the two lobes, dorsal and ventral, are about equally well developed. This type of tail is common in the large majority of bony fishes.

379. Colors of Fishes.—While most of our common fishes do not possess bright colors, some of them are at times very brightly colored. Especially is this true of the males of certain minnows during the breeding season. Still more brilliant, however, are certain fishes in tropical waters, particularly those found on the coral reefs, the colors of which are not exceeded in variety or intensity by any other group of animals. The colors of fishes are due to pigments developed in certain dermal cells known as *chromatophores*. The main pigments are red, orange, yellow, and black, but various tints are produced by varying combinations of these pigments. These colors are modified by the reflection of light from the scales, which contain crystals of *guanin*. Blue is such a structure color, and by combinations between it and the pigments a variety of shades of green is produced. The reflection of light from the irregular surface of the scales produces iridescence. White is the result of an absence of pigment. All of these factors together serve to produce the brilliancy and variety of colors which fish present.

The colors of fish can be modified by the contraction and expansion of the chromatophores, which have an ameboid character (Fig. 251). By means of changes of the chromatophores not only are spots rendered less brilliant or more so but also the general tone of coloration is made to vary considerably. These changes are appropriate to the environment of the fish and may serve to produce a protective coloration.

380. Internal Anatomy.—The internal skeleton of fishes includes a vertebral column composed of simple vertebrae, the body of each being hourglass-shaped, or amphicoelous. The skull contains a large number of parts and is mostly bony but still contains some cartilage. The pelvic girdle is absent, the ventral fins being attached to a flat bone which is not recognized as representing the pelvis. On the whole the bones which form the skeleton are slender and not very firm. They do not help to support the weight of the body, which is buoyed up by the water, but are only for muscle attachment.

The digestive system consists of a mouth; a pharynx, the walls of which are pierced by four pairs of gill slits; a short esophagus; a stomach; and an intestine. Teeth are found on the roof of the mouth as well as on both jaws. Three tubular outpocketings, called *pyloric caeca*,

open into the intestine and serve to increase its capacity, taking the place of the spiral valve of the dogfish shark.

The circulatory system includes a heart which lies in a sac called the pericardium lying below the pharynx. The pericardial cavity represents a portion of the coelom.

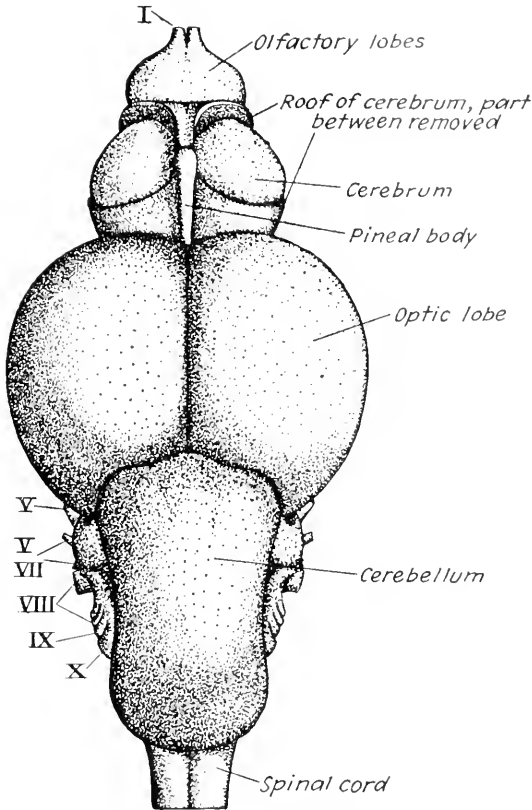

FIG. 239.—Dorsal view of the brain of a teleost fish, a salmon. (From a Ziegler model, after Wiedersheim.) The cerebellum conceals the medulla in this view. The roots of the cranial nerves are marked by roman numerals.

The respiratory system consists of four pairs of *gills* supported by an equal number of bony arches. Each gill bears a double row of gill filaments abundantly supplied with capillaries. The gills are protected externally by the opercula. Internally they are safeguarded by gill rakers from injuries which might be caused by solid particles carried into the pharynx with the water. The gill rakers are projections from the gill arches and are supported by spinelike bones.

The excretory system consists of paired kidneys, lying just below the backbone in the coelomic cavity, which are mesonephroi. From

them ureters carry the excretions to a urinary bladder which opens to the outside through a urinogenital sinus located posterior to the anus.

The brain consists of small cerebral hemispheres, small olfactory lobes, large optic lobes, a large cerebellum, and a medulla (Fig. 239).

381. Food of Fishes.—The food of fishes is highly varied, consisting of aquatic vegetation; of all the smaller forms of animal life found in the water, such as insects, crustaceans, mollusks, and worms; and in some

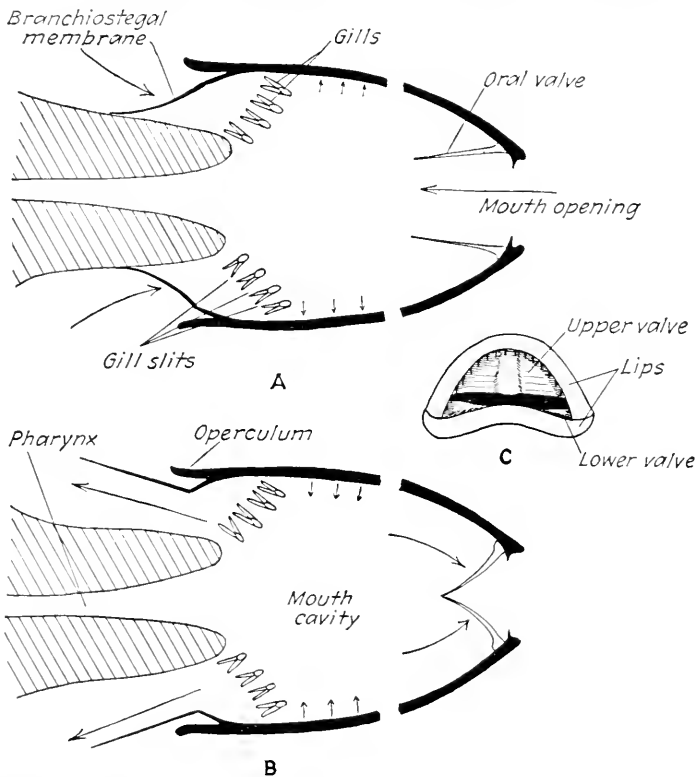

FIG. 240.—Diagrams to illustrate the mode of breathing in teleosts. (From Dahlgren, *Zool. Bull.*, vol. 2.) A, the passage of water into the mouth; B, its passage out through the gills; C, front view of the mouth of a sun fish, *Eupomotis gibbosus* (Linnaeus). The anterior part of the mouth cavity is shown in vertical section in A and B, the posterior part in horizontal section. The large arrows indicate both the movement of the water and the pressure exerted by it; the smaller arrows the direction of movement of the walls of the mouth.

cases of larger animals, including not only other fishes but amphibians and higher vertebrates which accidentally get into the water. Some are distinctly predaceous and others more decidedly herbivorous; still others gather mud and debris from the bottom, straining out the living and dead organisms which it contains. All fish are very voracious. The ultimate source of the food of most fishes is the plankton (Sec. 537) which the water contains and which, though not often serving directly as fish food, provides food for the multitude of organisms upon which fish feed.

The teeth of fishes are not used in mastication but in holding the prey. They are, however, sometimes modified as crushing organs, especially in those forms which eat large numbers of mollusks. Teeth that are lost are generally soon replaced.

382. Respiration.—The mechanism of respiration in the fish involves the use of the mouth, the opening of which is guarded by fleshy valves; the passages through the gill slits; and chambers outside the gill slits and under the opercula, which open by the slits behind the opercula. The chambers of the two sides communicate below and the exit from them is closed externally by a mucous membrane called a *branchiostegal membrane*. While the mouth is held open (Fig. 240) the walls of these cavities are dilated by the action of certain muscles and water rushes in through the mouth opening, being prevented from entering through the gills by the closing of the branchiostegal membrane. Then, pressure being applied to the water in these cavities by other muscles which contract the walls, the oral valves are forced shut, the branchiostegal membrane opens, and the water escapes between the gills. While the gills are thus bathed with the water which passes them, respiration takes place. This whole operation is continually repeated. The mouth does not need to close in breathing, though its opening is usually seen to become alternately larger and smaller as breathing continues. Thus the apparatus acts something like a force pump the chamber of which is guarded by valves in such a manner as to permit water to pass only in one direction. A fish can be smothered by preventing the closure of either the oral valves or the branchiostegal membrane. If a stringer is passed through the mouth and the gill slits, breathing is interfered with and the fish is soon killed.

383. Senses of Fish.—A fish possesses two olfactory sacs, one on each side of the head and each opening to the outside through two external apertures. Taste organs occur in the mucous membrane of the mouth. The senses of smell and taste are, at best, not well-developed. The sense of touch is better developed, however, especially around the mouth and on barbels on the head.

The lateral line system consists usually of a continuous tube on each side of the body just below the surface, lodging on its inner wall the lateral line organs and opening to the outside by pores passing through the tips of the scales lying in this line. Sometimes there are two or three lateral lines.

The eyes possess no eyelids, the cornea is flattened, and the lens is almost spherical. The pupil is very large to allow free admission of light, because the water absorbs so much of the light that even at a moderate depth it is greatly reduced. When at rest the eye is focused at a distance of about 15 inches and adjustment to more distant vision is afforded by the movement of the lens. In other words fishes are near-

sighted. They can see clearly enough, however, to catch very active prey, and some are even known to capture insects above the water. Others, like trout, evidently detect movement very quickly even at a distance of many feet from the water in which they are. *Anableps*, a surface minnow, has its eye divided horizontally into two parts (Fig. 241), one part for seeing below the surface of the water and the other for seeing above it. It feeds on insects flying over the water and is found in the streams of tropical America.

The ear consists of a membranous labyrinth which is lodged in a cavity in the side wall of the skull. This cavity does not form a bony labyrinth. Sound waves to be perceived must be transmitted through the outer wall of the skull and through the tissues forming the wall of the body outside it. In all fishes the ear is mainly an organ of equilibrium.

384. Behavior.—Fishes, generally speaking, lead very active lives; the predatory ones, especially, are constantly on the alert for food. In our lakes and ponds the smaller fishes retreat to deeper water and

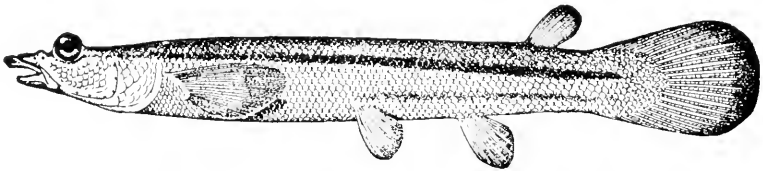

FIG. 241.—*Anableps dowii* Gill, a Tropical American fresh-water surface fish, the eyes of which are divided by a partition into two parts, one for seeing outside of the water, the other in it. $\times 1\frac{1}{2}$. (From Jordan, "Guide to the Study of Fishes," by the courtesy of D. Appleton & Company.)

to the protecting cover of vegetation during the day, but at night they approach both the surface and the shore in search of food. This is accompanied by a similar movement on the part of the larger predatory fishes which prey upon them. In captivity, and when given an abundance of food, fishes may at times be seen to rest, buoyed up by the water or lying against the bottom, and it is probable that in a natural state they spend brief intervals at ease. Bottom feeders and herbivorous forms go more quietly at the task of securing food than do the predatory types, which dart rapidly at anything that appears like prey. This instinct to snap at a moving object is the cause of the readiness with which predatory fishes take an artificial bait. Some fish, known as gobies, live in holes in the mud of beaches, where they may be dug out at low tide; others are able to attach themselves to rocks by a sucker, or they may hide in cracks and crevices. Some show a definite preference for a certain locality, and a predaceous fish may regularly frequent a particular station from which it watches for prey. Nevertheless fish migrate to avoid adverse conditions such as seasonal changes, to search for food, or to find proper conditions for reproduction. Practically

all of the actions of fish are dictated by instinct, though they also form habits. They possess little intelligence.

385. Reproduction.—The sexes of fish are separate. Fertilization may take place by the male depositing the seminal fluid, or *milt*, which contains the sperm cells, over the eggs, called *roe*, at the time of laying;

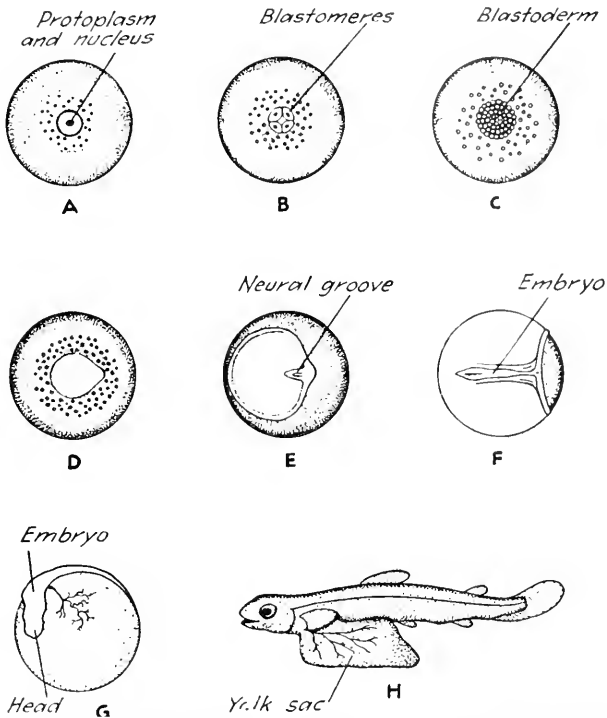

FIG. 242.—Stages in the development of a salmon. A, the egg before development begins. B, four-celled stage. C, the blastoderm. D, blastoderm elongated in the direction of the longitudinal axis. E, the blastoderm with thickened margin, and the beginning of the neural groove. F, the yolk nearly covered by the growth of the margin of the blastoderm and the embryo elongating. G, the embryo raised up on the top of the egg, the yolk now being enclosed by the yolk sac. H, the animal much older, having developed the external appearance of a fish, but with the yolk sac still attached below. (Mostly from Parker and Haswell, "Text-book of Zoology," after Henneguy, by the courtesy of The Macmillan Company.)

or it may occur a short time after the milt and roe are passed out into the water. The female is usually the larger sex, in some cases her length exceeding that of the male several times. Most of the eggs of fishes are relatively small and surrounded by a protective covering which may be adhesive and by which they may be attached to each other and to solid objects. They may be laid separately, or they may be deposited in groups. If laid separately, as in the case of some marine types, very large numbers of eggs are devoured by other fish and by other animals.

If laid in masses, they are less likely to be eaten. The young fish, or *fry*, are constantly exposed to destruction. Though enormous numbers of eggs are produced, amounting to many millions for each individual during the breeding season, only a relatively small number produce young that reach maturity. Some fish are viviparous, both fertilization and development being internal and the young being born with the characteristics of the adult. The young of oviparous forms often differ in appearance from the parents, and sometimes the change from larval to adult characters is so pronounced as to amount to a metamorphosis.

The egg is telolecithal, and discoidal cleavage takes place (Fig. 242). The division of the protoplasmic area at the top, called the *germinal disc*, results in the formation of a germinal area, or *blastoderm*, which at first forms a disc on the upper side of the egg. As development proceeds, the blastoderm spreads out, gradually grows around the egg, and comes to inclose the yolk completely. While the germinal disc is still confined to the upper side of the egg, a thickening appears at the margin of this disc, which is more marked at the point that will form the head of the embryo. From this point a raised strip of tissue runs backward in the median line. This strip is marked lengthwise by two lateral ridges bounding a median groove which is the medullary, or neural, groove. The embryo, which thus develops on the upper side of the egg, rises higher and higher above the surface, the yolk being at the same time gradually used up as food. The neural groove becomes a neural tube by the meeting of the lateral margins and so the central nervous system arises. The head becomes free at the anterior end of the embryo and a tail forms at the opposite end. As the length increases, various structures characterizing the fully developed fish make their appearance, and the young animal hatches with the underside of the body distended by the yolk still remaining. The yolk is soon used up, but by that time the fish is sufficiently developed to secure its own food, and it begins to eat the more minute forms of life in the water, increasing the size and variety of its food as it grows larger. It is evident from this description that the entire egg ultimately contributes to the body of the fish.

During the breeding season temporary mating in some cases occurs and the pair may cooperate in the construction of a nest and the care of the eggs and young. The males of some marine forms have pouches for the carrying of eggs during development. This indicates the wide diversity in behavior during reproductive activity.

386. Ages of Fish.—Some fish, such as the ice fish of China, live only a year. Such short-lived fish have a definite size which they may attain. Others, like salmon, live only a few years and die at the first reproductive period, after spawning. Still others live for a long time, it is believed for from twenty to thirty, and perhaps even sixty, years and continue

to grow as long as they live. The rate of growth, however, gradually diminishes as they get to an advanced age.

387. Deep-sea Fishes.—There are many fishes which have become adjusted to the conditions of life at great depths in the ocean and have become highly modified in several directions (Fig. 243). Some of these have become exceedingly slender, thus reducing the bulk of the body.

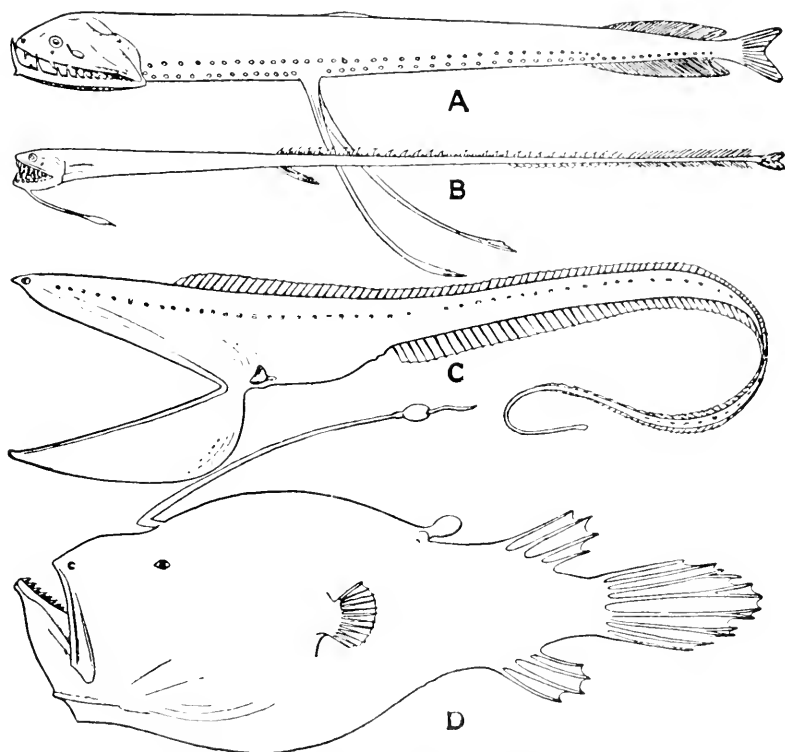

FIG. 243.— Deep-sea fishes. *A*, *Photostomias guernei* Collett; length $1\frac{1}{2}$ inches, taken at a depth of 3500 feet. *B*, *Idiacanthus ferox* Günther; 8 inches, 16,500 feet. *C*, *Gastrostomus bairdii* Gill and Ryder; 18 inches, 2300 to 8800 feet. *D*, *Cryptopsaras coussii* Gill; $2\frac{1}{4}$ inches, 10,000 feet. (From Lull, "Organic Evolution," after Schuchert, "Historical Geology," by the courtesy of The Macmillan Company.)

Another modification which is very general in these forms is the development of enormous mouths, as if to make the most of the opportunities presented for the securing of food. Sometimes the eyes are enlarged to gather all the light possible, though in other cases they are small and apparently useless. Luminescent organs are frequently developed. Extraordinary shapes are assumed, and in one very marked type the male has become minute, lives parasitically attached to the surface of the female, and receives food passed from the blood vessels of the female into its own, the two sets of vessels being in contact.

388. Remarkable Fishes.—Among the bony fishes are a number remarkable for one reason or another. The smallest species, and also the smallest of the vertebrates, is a Philippine goby, which does not reach $\frac{1}{2}$ inch in length; the largest of those which possess the usual form attain a length of 15 to 20 feet; but one fish which is elongated, flat, and bandlike in shape and is known as the oarfish, or the king of the herrings, attains a length of 25 feet. The oarfish may be the basis of some stories of sea serpents. The climbing perch of southeastern Asia climbs out of the water on the roots and trunks of low trees for the purpose of capturing food. The anterior spine of the dorsal fin of an angler fish is greatly elongated and can be directed forward. At the end of this spine and in a forward position of the spine in front of the mouth hangs a fleshy, brightly colored bulb which in some species bears an interesting resemblance to an animal upon which the fish feeds. In one type the bulb at the tip is luminescent. This fish with the luminescent bulb was described by Aristotle in the fourth century B.C. Ever since his time these fish have been described as using the bulb as a lure to bring other fishes within reach of its mouth, and to this these fish owe their name. Some recent authorities, however, have doubted the validity of the assumptions upon which rests this ancient zoological tradition.

389. Economic Relations.—Fish are of great economic importance, having from time immemorial been an important element in the food of man. Not only are they themselves eaten as food, but the eggs of certain ones, particularly Russian species of sturgeon, are eaten as *caviar*. The flesh of some marine forms, however, is poisonous and cannot be safely eaten. Some of the best known game fish are not good for food, the tarpon, for example, being one of the most famous and yet ordinarily not being eaten.

Some fish are capable of inflicting a poisonous wound by means of dorsal spines or a spiny operculum. Others are harmful because of their destruction of the eggs, the young, or even the adults of food fish and other valuable animals.

Fish are more often cultivated in the Old World than in the New, both for food and as pets. The Japanese have produced many curious artificial varieties of the goldfish, originally a native of China. From some fish is secured guanin, which in suspension in water is known as *pearl essence* and which is used in the manufacture of artificial pearls.

CHAPTER LIV

TERRESTRIAL VERTEBRATES

The fourth class of the vertebrates, Amphibia, exhibits a transition from life in water, which has been characteristic of all vertebrates previously studied, to life in air. Nevertheless, the amphibians do not show a complete emancipation from aquatic life. Some of them remain

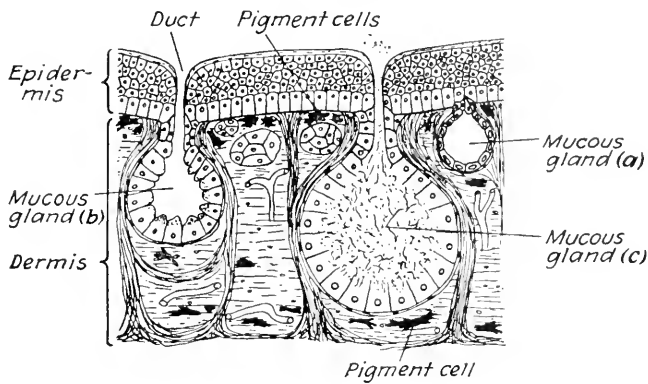

FIG. 244.—Somewhat diagrammatic section of the skin of a frog to show stages in activity of mucous glands. Gland *a*, the section of which does not go through the duct, is not active; gland *b* is beginning to form mucus in the epithelial cells which line it; and gland *c* is actively secreting.

gill breathers through life and are confined to bodies of water. The majority pass through their earlier stages in the water, then acquire lungs and become air-breathing and terrestrial. A very few have by the acquirement of special adaptations become quite independent of water for their reproduction, but even these require some moisture and cannot live under arid conditions.

390. Changes Incident to the Acquirement of a Terrestrial Mode of Life.—The first change involves the acquisition of an abundance of *mucous glands* in the skin to keep it from drying (Fig. 244). A fish possesses glands in its soft epidermis, the secretions of which protect it from contact with the water and from the entrance of infectious organisms, but these are inadequate to prevent rapid drying when the animal is exposed to the air. Even the least adapted amphibian can remain out of water a much longer time than can a fish. The soft skin which salamanders and frogs possess is in toads replaced by a dry, hard skin, which adjusts them to relatively drier situations.

A moist skin may, under certain conditions and in certain types of amphibians, serve also for respiration. Generally speaking, how-

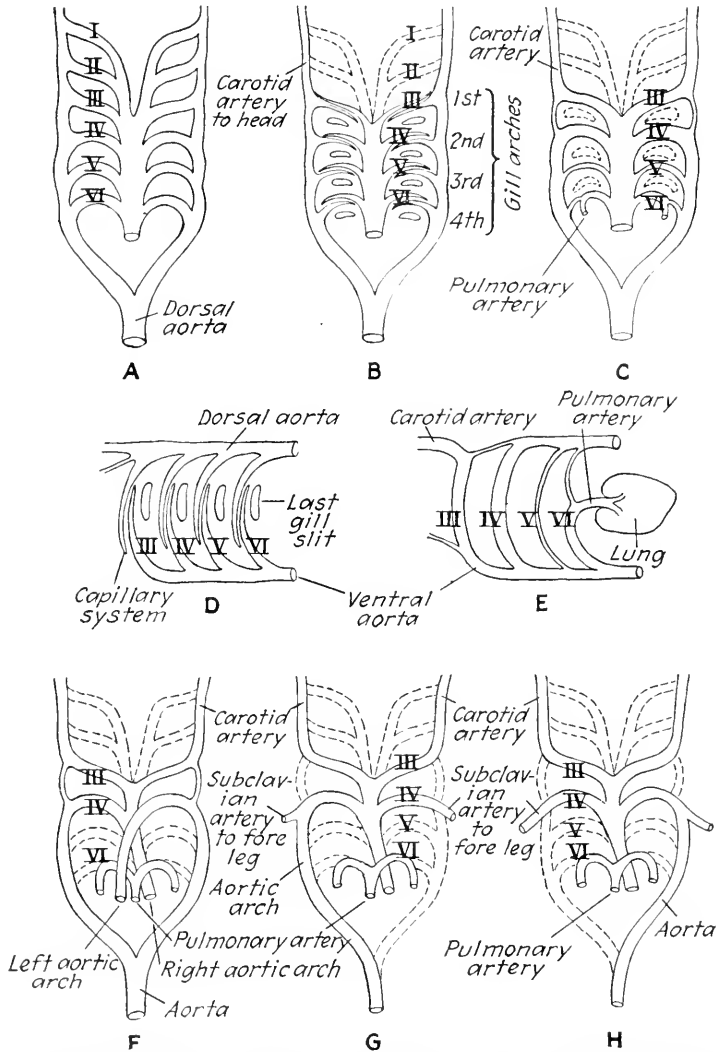

FIG. 245.—Diagrams showing steps in the changes in the branchial arches accompanying the development of lung breathing. A, the primitive or embryonic condition; B and D, the condition in fishes, D being a lateral view; C and E, tailed amphibian, E being again a lateral view; F, a reptile (lizard); G, a bird; H, a mammal. The corresponding arches are numbered in roman numerals. Vessels which have disappeared are indicated by dashes. (Based upon Wiedersheim and Parker, "Elements of the Comparative Anatomy of Vertebrates.")

ever, terrestrial amphibians have acquired *lungs*, which are paired sacs developed from the ventral side of the pharynx, by means of which they take oxygen directly from the air. This is a second adaptive

change. Gills are still possessed by the larvae but these are lost during metamorphosis.

The third adaptation, which is connected with the development of the lungs, involves changes in the circulatory system which result in a *double circulation*, the blood being sent from the heart to the lungs for aeration, returned again to the heart, and then sent out over the body. This change includes a remodeling of the branchial circulation possessed by fishes which is still retained by larval amphibians (Fig. 245). Of the four pairs of branchial arches characteristic of the fish, the first of each side becomes in lunged amphibians the basal portion of a common carotid artery, which supplies the corresponding side of the head; the

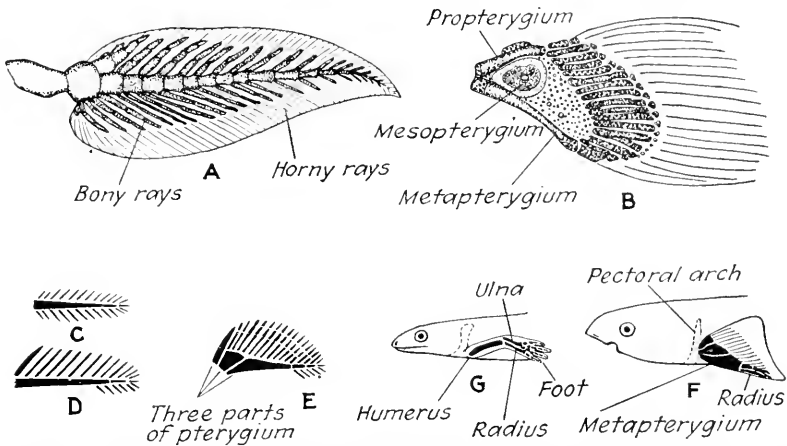

FIG. 246.—Diagrams to illustrate the theoretical change of a fin into a limb. A, pectoral fin of *Ceratodus*, an extinct dipnoan, representing a primitive fin. B, pectoral fin of *Polypterus*, a lobe-finned ganoid, or crossopterygian, now living. C, D, E, hypothetical changes from A to B. F, pectoral fin of a pro-amphibian, a hypothetical form intermediate between *Polypterus* and an amphibian. G, condition in amphibian. (A, B, F, and G from Wiedersheim, "Vergleichenden Anatomie der Wirbeltiere"; C to E, from Kingsley, "Outlines of Comparative Anatomy of Vertebrates," by the courtesy of P. Blakiston's Son & Co.)

second becomes an aortic arch, through which the blood passes to the trunk and tail; the third disappears; and the fourth, in part, becomes the basal portion of the pulmonary artery leading to the lung. A cutaneous branch of this fourth arch also becomes developed in an amphibian when it breathes through the skin. The heart becomes three-chambered, the single auricle of the fish being divided in the amphibian into a right auricle which receives the blood from over the body and a left auricle which receives the blood returned from the lungs. The ventricle remains single and serves to send out blood both to the systemic and to the pulmonary circulation, but its walls become thrown into folds which prevent a complete mixing of the arterial and venous blood.

A fourth change is incident to the use of the *limbs* to support the body and to serve as locomotor appendages on land. Paddle-like

fins become replaced by jointed limbs (Fig. 246) which form a system of levers, these limbs being divided into three portions—upper limb, lower limb, and a third portion which in the forelimb becomes the carpus and the forefoot, and in the hind limb the tarsus and hind foot. A tail fin is present in some amphibians, but this fin is simply a fold of the skin without a fin skeleton. In order better to support the weight of the body, the limb skeletons become rather firmly attached to the axial skeleton and the skeleton as a whole becomes to a greater extent bony and distinctly more rigid.

A fifth adaptation in the amphibians for terrestrial life is seen in the *eyes*, which become supplied with lids for protection and with lachrymal glands to moisten the eyeball and prevent it from drying. The lens also becomes more flattened and capable of more distant vision.

Since sound waves are transmitted less perfectly in the air than in the water the ear also shows adaptation. A *middle ear* is formed which in many amphibians is closed externally by a tympanic membrane and across which sound is transmitted by means of a bony rod called the *columella*. The columella is articulated with a second bone, the *stapes*, set into the opening in the wall of the sacculus. A *eustachian tube* is developed connecting the middle ear with the pharynx. This tube and the cavity of the middle ear together represent a modified pharyngeal slit and correspond to the spiracular canal of the elasmobranchs.

391. Origin of Terrestrial Adaptations.—Although, as has been noted before, certain fishes do at times leave the water it is only for a brief interval that they do so and they show no changes adapting them to life in the air. Other fishes such as the lungfishes have acquired adaptations which enable them to breathe air when the water becomes very foul or during periods when they remain dormant in the mud left by the drying up of bodies of water. These adaptations, however, are not believed to be exactly similar to the pulmonary adaptations of Amphibia.

For the origin of the amphibians one must go back to the Crossopterygii, which were noted as possessing larvae similar to amphibian tadpoles and which used the forelimb as a means of support while resting on the bottom. The Devonian period (Fig. 312) was the age of fishes, at which time they were the highest animal types living. It is thought that during the latter part of this epoch there were seasons of warmth and heavy rainfall followed by more and more prolonged periods of drouth. Under these conditions it is believed that from the lobe-finned ganoids arose different types of animals showing adaptations to terrestrial life and that the amphibians represent a successful type which has persisted to the present day. The earliest trace of amphibians is the footprint of a three-toed animal found in Pennsylvania in rocks of the upper Devonian period. This animal possessed feet instead of

fins. This is the only clue, and a very inadequate one, to the manner in which feet developed out of fins. It has, however, been suggested that the fin rays might have been reduced in size and number and the basal bones of the fin rearranged (Fig. 246). Thus an appendage was formed which came to possess five digits, the typical number in the amphibian limb.

CHAPTER LV

CLASS AMPHIBIA

The name Amphibia indicates that these animals live at different times in their life history in two environments—water and air. They generally possess a soft skin which is kept moist by an abundant mucous secretion. No exoskeletal structures are developed in any living forms, except in the Apoda, but some extinct amphibians possessed a more or less complete dermal armor made up of bony plates. Typically they possess four jointed legs. Two nostrils are present which open directly into the anterior part of the mouth cavity. Lungs appear in amphibians for the first time, developing as outpocketings from the ventral side of the pharynx. These have thin elastic walls the superficial area of which is increased by folds; the recesses between these folds are known as *alveoli*. There are renal-portal and hepatic-portal systems. The kidney is a mesonephros and the urinary ducts open into a cloaca. The eyes are usually supplied with lids. The middle ear appears, and in many species of frogs a flat, circular tympanic membrane is to be seen behind each eye.

392. Classification.—The class Amphibia is usually divided into three orders:

1. *Urodela* (ū rō dē' lá; G., *oura*, tail, and *delos*, visible).—Amphibians with tails, including salamanders and newts.

2. *Salientia* (sā lī ěn' shī á; L., *salientis*, leaping).—Tailless amphibians, including frogs and toads.

3. *Apoda* (ăp' ō dá; G., *a*, without, and *podos*, foot).—The cecilians, which are legless types.

393. Urodela.—The tailed Amphibia are the typical forms. They retain a tail throughout life; possess limbs of a primitive character set at right angles to the body, the fore- and hind limbs being approximately equal in size; and have teeth in both jaws. These forms show a gradual transition from aquatic to terrestrial life and may be divided into two groups. Those which retain their gills and are aquatic throughout life are known collectively as *perennibranchs*; those which lose their gills upon becoming adult and assume a terrestrial mode of life are known as *caducibranchs*.

Among the perennibranchs living in eastern United States is the mud puppy, *Necturus*, which has three pairs of fringed external gills and a gill cleft behind each (Fig. 247A). As in all of the perennibranchs

the eyes are without lids. These animals live a rather sluggish existence on the muddy beds of lakes and rivers. They are most active at night, when they wander about in search of food. The most primitive of the perennibranchs and perhaps the most primitive salamander is the hellbender, *Cryptobranchus*, of the eastern states, which is a large species reaching a length of nearly 2 feet. It has no external gills and the gill clefts are vestigial. The hellbender, like the mud puppy, is a very

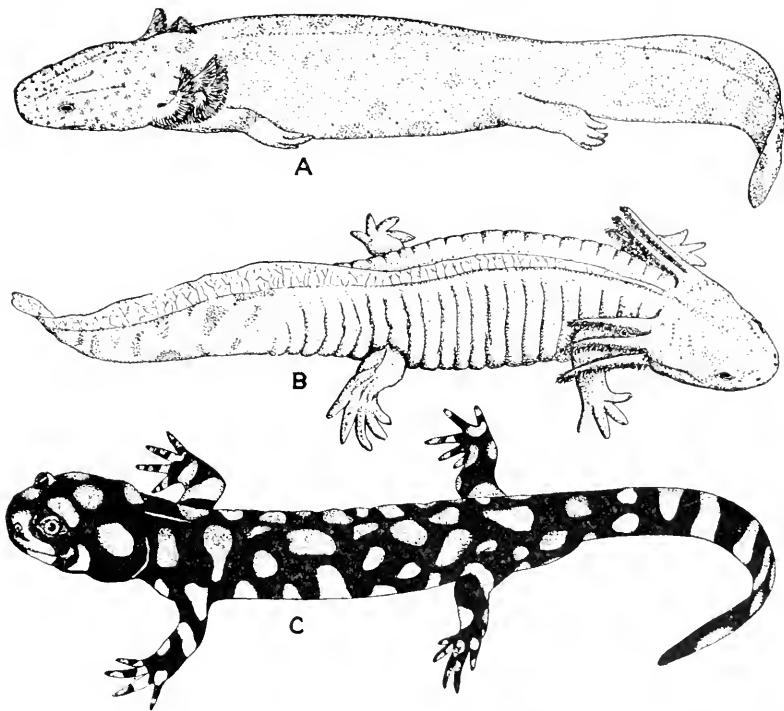

FIG. 247.—Urodeles. A, mud puppy, *Necturus maculosus* (Rafinesque), from Ohio. $\times \frac{1}{3}$. B, axolotl larva of *Ambystoma tigrinum* (Green). $\times \frac{2}{3}$. C, tiger salamander, *Ambystoma tigrinum* (Green). The axolotl and the salamander from Nebraska. $\times \frac{2}{3}$. A and B from preserved specimens, C from a living one.

voracious bottom form. A similar amphibian, found in Japan, is the largest of all living types, exceeding 5 feet in length.

One of the commonest caducibranchs found in eastern United States is the large tiger salamander, *Ambystoma tigrinum* (Green). This animal (Fig. 247C) deposits its eggs singly in ponds in the spring. The young salamander passes through a tadpole stage and metamorphoses into a terrestrial form which lives in damp situations under stones or logs and which frequently finds its way into cellars. The common newt found in eastern United States is a small form, *Desmognathus*, which lives under logs and stones. The female lays her eggs in a hole in the

moist earth and coils her body about them. When hatched the larvae are nearly mature. An alpine newt which occurs in mountain lakes in Europe brings forth its young alive, the tadpole stage being undergone and metamorphosis taking place in the uterus of the mother.

394. Salientia.—The tailless Amphibia are, generally speaking, divided into two types, those without a tongue and those with one. Among those without a tongue is the curious Surinam toad. This is an aquatic toad with very large hind feet and a short, broad head. During pairing the oviduct is protruded through the cloaca and passed forward between the back of the female and the abdomen of the male. As the eggs are passed from the oviduct, they are fertilized and spread over the back of the female, to the surface of which they become firmly adherent. Gradually they sink into pockets in the skin, each pocket having a sort of lid. In these pockets the young develop until they are prepared for independent life. The male of the European obstetrical frog carries strings of eggs on his hind legs and releases the tadpoles in water when they are ready to hatch.

The tongued forms include both frogs and toads. There is no sharp distinction between the two but usually a soft-skinned, partly aquatic type is known as a frog (Fig. 254*G*), and a harder-skinned, more terrestrial one as a toad. The true toads also have no teeth on either jaw. They have a harsh, warty skin, ridges on the head, and a kidney-shaped raised area behind the head on each side known as the parotoid gland (Fig. 250). When disturbed, toads frequently pass water from the bladder, and the superstition is widely spread to the effect that the handling of a toad will cause warts. They are nocturnal in habits, feeding upon insects, worms, and snails. Their skins contain glands which produce noxious secretions and they are therefore rarely eaten by other animals.

The frogs have a body which is somewhat spindle-shaped, pointed anteriorly, and rounded posteriorly. The forelegs are weak and the toes only slightly webbed; but the hind ones are long and strongly muscled, with long, fully webbed toes, fitting them for leaping and swimming. On superficial examination the male of common frogs may be distinguished from the female by the greater thickness of the inmost digit of the forefoot. The metamerism of the body wall is greatly obscured, this being due in part to the shortness and compactness of the body and in part to the development of muscles connecting the limbs to the trunk.

Just in front of each gonad is a yellowish *fat body* which in the frog consists of a series of finger-like lobes; it seems to be a fat-storage organ. Above the anterior end of the cloaca is the *spleen* in which worn-out red blood corpuscles are destroyed and in which white corpuscles are formed. There are also several glands falling under the general designation of ductless glands, the secretions of which are known as internal

secretions. Examples of such are the *thyroid glands*, one of which is situated ventrally on each side of the body in the region of the throat. Others are the *thymus glands*, which lie below and behind each tympanum, and *adrenal bodies*, one on the ventral side of each kidney.

The tree frogs, or tree toads (Fig. 248), possess dilated adhesive discs upon the toes. Among these types is an interesting tree frog found in Brazil which makes a nest for its eggs and young at the bottom of a pond, building a mud wall about it; another frog found in Venezuela carries its eggs and young in a shallow pouch on its back until the latter are almost ready for metamorphosis; and still another found in Java has greatly enlarged feet, the toes being connected by webs, making it possible for the animal to glide or sail through the air for a considerable distance. A curious little tree frog found on the island of Martinique

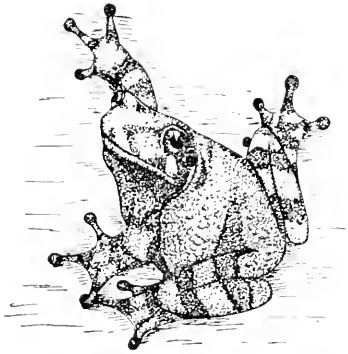

FIG. 248.—Common eastern tree toad, *Hyla versicolor* LeConte. Male, from Staten Island, New York. $\times 2_3$. (Redrawn from Dickerson, "Frog Book.")

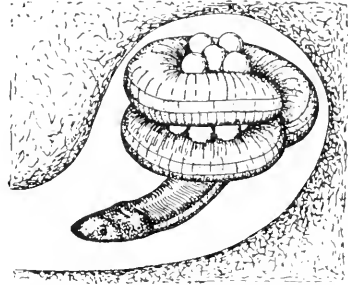

FIG. 249.—Asiatic cecilian, *Ichthyophis* sp., with eggs. (Modified from Thomson, "Outlines of Zoology," after P. and F. Sarasin.)

glues its eggs to a leaf, where they form a foamy mass. In this case development is practically completed in the egg and there is no aquatic larval period. Thus some of these forms have practically emancipated themselves from any need of an aquatic environment, though they must still live in a moist locality.

395. Apoda.—The Apoda, or eceilians, sometimes called blindworms, are generally distributed in tropical and subtropical countries. They possess neither girdles nor limbs but have concealed dermal scales. They burrow in the earth somewhat as does an earthworm and are not unlike an earthworm in general appearance. The mouth is at one end of the body and the anal opening almost at the other, there being merely a rudiment of a tail. The eyes are also rudimentary and practically functionless, but the animal possesses a protrusible tentacle-like organ lying in a groove between the eyes and nose by means of which it feels its way about. In one type found in southern and southeastern Asia

the female lays her eggs in masses in a shallow hole near the water and coils herself about them (Fig. 249). The larval stage is passed in the egg, the larva possessing three pairs of external gills which are lost when it hatches. This larva swims about in the water for a while, coming to the surface for air, but at length the gill clefts close, the tail fin is lost, and the animal becomes terrestrial, leading a burrowing life. Some types of Apoda are viviparous. The whole group is to be looked upon as the result of a very pronounced degeneration.

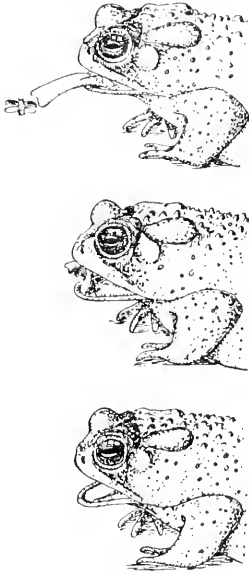

FIG. 250.—Showing the manner in which a toad takes an insect. The tongue is extruded in an exceedingly rapid movement and is inverted in the action; the insect adheres to its sticky dorsal surface, which is underneath, and is drawn back into the mouth. (Modified from Dickerson, "Frog Book.")

396. Food.—The food of frogs and toads is composed of any living animals which they can secure, particularly worms and insects. These are captured by means of the protrusible tongue, which can be extended considerably beyond the margin of the mouth and which is covered by a sticky secretion (Fig. 250). Some animals are also grasped by the jaws but the teeth are not used in mastication, the food being swallowed whole. Salamanders, on the other hand, have much better developed teeth, which they use in biting and tearing flesh. They not only feed on worms, crustaceans, insects, and mollusks but also eat fish and other amphibians and will tear pieces from the bodies of dead animals in the water. They are distinctly cannibalistic.

397. Color Changes in Amphibia.—The skin of amphibians contains color-bearing cells, or chromatophores, which in the case of many forms, particularly the frogs, are ameoboid and enable the animal to modify its color (Fig. 251). There are also cells containing granules of guanine which change these colors by refraction of light. The conditions here are similar, therefore, to those existing in fish. Color changes occur as a result of direct stimulation of the chromatophores by light, temperature, or moisture in the environment and in response to stimuli received from the nervous system.

398. Nervous System and Sense Organs.—The brain of the frog includes two large olfactory lobes which are united in the median line and two cerebral hemispheres which are relatively larger than those possessed by any forms lower than the amphibians (Fig. 252). There are also two well-developed optic lobes and a medulla. The cerebellum, however, is so reduced that it can hardly be distinguished; it is a transverse mass dorsally located at the anterior end of the medulla. The

spinal cord is short, corresponding to the shortness of the body. Like the brain it is inclosed in two membranes—a firm outer protective *dura mater* and a more delicate inner vascular *pia mater*. The cerebrospinal system includes 10 pairs of cranial nerves and also 10 pairs of spinal nerves.

The principal sense organs of the frog are the eyes, the auditory organs, and the olfactory organs. In addition to the upper and lower eyelids there is a third, called the *nictitating membrane*, which is fused with the lower one. The lens is large and nearly spherical and there is little power of accommodation. The auditory organ has been in a general way described in the preceding topic. There are three semi-circular canals. The olfactory epithelium lines cavities just within each of the nostrils.

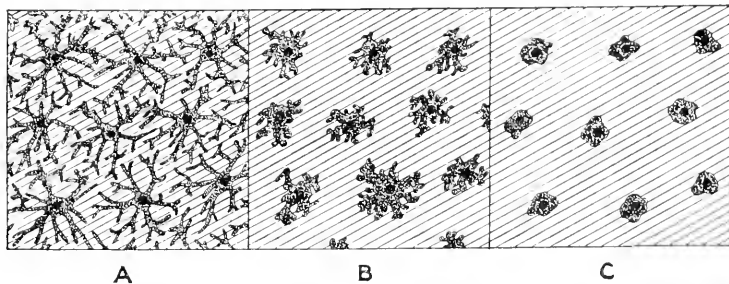

FIG. 251.—Diagram to illustrate modification of color by amoeboid chromatophores. A, pseudopodia fully extended; B, partially extended; C, contracted. In A the color present in deeper layers of the skin, represented by crosslining, is obscured, and in C it prevails.

399. Behavior.—Endeavors have been made to determine the function of the different regions of the frog's brain by the removal of one after another in the living frog. It has been found that removal of the cerebral hemispheres, together with the olfactory lobes, seems to have little effect. When the mid-brain is removed the frog loses its power of spontaneous movement, which is clearly connected with the loss of sight. Also the spinal cord becomes more irritable, which shows that the destruction of the mid-brain and the loss of sight have removed a control which was necessary to nervous equilibrium. The very small size of the cerebellum seems to show that it has no important function. After all of the brain is removed except the medulla the animal still continues to breathe, will snap at food brought in contact with its jaws, is able to leap, swim, and right itself when placed upon its back. Destruction of the medulla, however, results in death. This clearly shows that the vital centers are lodged in the medulla and that the actions of the frog are very largely reflex in character.

Since it is true that the activities of the frog are mainly reflex it is also clear that they are governed largely by *instinct*. The fact that

the removal of the anterior part of the brain in front of the medulla has so little effect upon its activities indicates plainly the low grade of intelligence possessed by the animal. The roof of the cerebrum in all forms up to Amphibia has been epithelial and without nerve cells. In

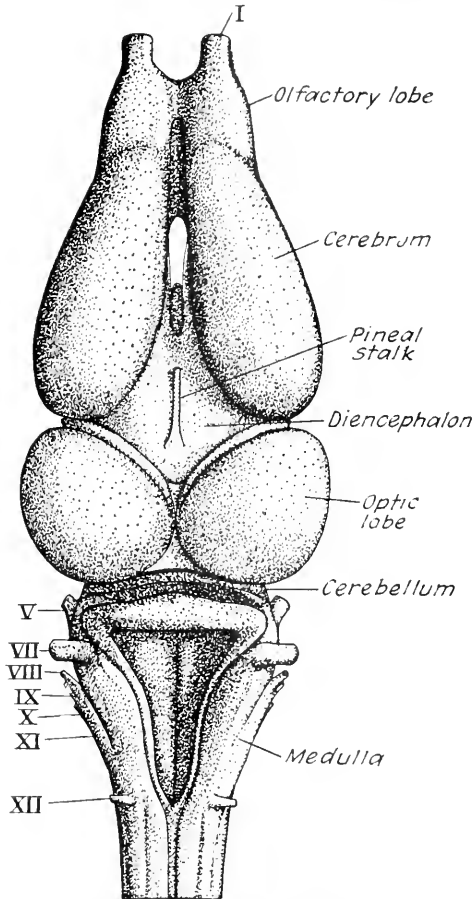

FIG. 252.—Brain of European frog, *Rana esculenta* Linnaeus, viewed from above. (From a Ziegler model, after Wiedersheim.) The roots of the cranial nerves are marked by roman numerals.

Amphibia it contains nerve cells, but these are inside and are covered by fibers and are not organized into a cortex.

The frog responds directly to many *external stimuli*. It is sensitive to light, the whole skin being affected. The animal is said to exhibit a negative phototropism since it avoids bright light and, when exposed to it, faces it, that being the position in which the smallest amount of light will be received by the skin of the body as a whole. Frogs are also stimulated by contact and tend to crawl under objects and into crevices. Both of these responses are modified by temperature. Natu-

rally frogs avoid a degree of heat which would cause their skin to become dry.

Frogs can form simple *habits*, although they do so very slowly. Yerkes found that after about a hundred trials a frog was able to traverse the proper path in a simple labyrinth of passages. Some intelligence may have been involved in this behavior, but it was, apparently, largely the formation of a habit.

400. Reproduction and Development.—All Amphibia are dioecious. The eggs are set free in the body cavity of the female and are collected by the open ends of coiled oviducts. They are accumulated in thin-walled distensible portions of the oviducts known as uteri. The glands of the oviducts secrete the gelatinous coating of the eggs. Certain facts have been stated in regard to the reproduction of particular forms, but the development of the frog will be given in detail as typical of the class.

Frogs deposit their eggs in water in the spring. While in the body of the female the eggs are surrounded with a layer of transparent jelly which is thin, but as soon as the eggs are brought in contact with the water this jelly absorbs water and swells, becoming thick and serving as a protective covering. During egg laying the male clasps the body of the female by his forelegs and fertilizes the eggs by depositing sperm cells upon them as they are passed out of the cloaca. The upper pole of the egg, called the animal pole, is dark in color, and the lower, or vegetal pole, is light because of the massing of the yolk in that portion. The eggs are holoblastic but, owing to the amount of yolk, undergo unequal cleavage (Fig. 253). The upper and smaller cleavage cells are known as *micromeres*, the lower and larger ones are the *macromeres*. A blastula cavity, or blastocoel, is formed, and gastrulation takes place by epibole, a fold of micromeres growing around and inclosing the macromeres, leaving the yolk visible only through the blastopore. This visible portion of the yolk is termed the *yolk plug*. Soon after gastrulation there is developed a groove, called the *medullary groove*, running dorsally from the blastopore forward toward what will become the anterior end of the larva. The blastopore gradually becomes obliterated by the contraction of its margins. The embryo now becomes elongated and the head and tail become free.

Later, and after the embryo has become better developed, a swelling appears on each side near the anterior end of the body. Below each swelling is developing a gill arch, and in front of it a depression which moves toward the ventral side of the body and unites with that of the other side to form a *ventral sucker*. Above the ventral sucker an invagination called the *stomodeum* marks the beginning of the mouth, while toward the posterior end of the body, below the tail, which is developing backward, is formed another invagination, the *proctodeum*, which will

become the cloacal opening. The medullary groove is converted into a medullary tube by the meeting of the ridges on each side of it. This tube in turn develops into the central nervous system. Eyes appear on each side of the head, and *external gills* are formed which project outward from the branchial arches. At the same time muscle segments are seen developing under the skin on each side of the body and tail. The yolk is massed in the ventral portion of the body causing it to be much swollen.

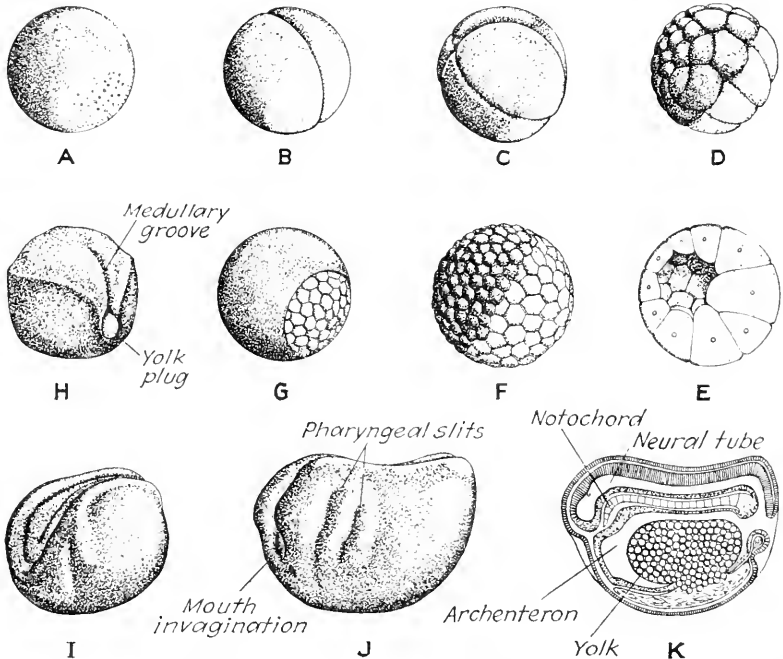

FIG. 253.—Early stages in the development of a frog. *A*, egg cell, before cleavage. *B*, two-cell stage, and *C*, four-cell. *D*, blastula, and *E*, section of it. *F*, beginning gastrulation by epibole, and *G*, the process more advanced. *H*, stage showing the yolk plug, and *I*, somewhat later. *J*, stage with pharyngeal arches and slits; *K*, median section of same stage. From specimens and Ziegler models.

While still within its albuminous envelope, the embryo moves about inside this envelope by means of cilia on the epidermis, but, upon hatching (Fig. 254), the cilia disappear and the animal swims by the movement of its tail. The two pairs of external gills become long and branched. For a few days after hatching, the larva spends most of its time clinging to objects in the water by its ventral sucker and lives upon the yolk still contained in the archenteron. About the time the yolk is used up a connection appears between the cavity of the stomodeum and that of the anterior end of the archenteron and another between the cavity of the proctodeum and that of the posterior end of the archenteron, which thus becomes converted into an alimentary canal. The animal

now begins to swim, feeds on algae and other vegetable matter, and is known as a tadpole. At this time the external gills begin to shorten, and *internal gills*, of which there are four pairs, are being formed. A fold grows around the body just behind the head, covering the gill slits on both sides and producing a chamber known as a *branchial pouch*. The branchial pouch opens on the left side by a circular opening called the *spiracle*. By this time the external gills have ceased to function and the internal gills serve in respiration, water being passed through

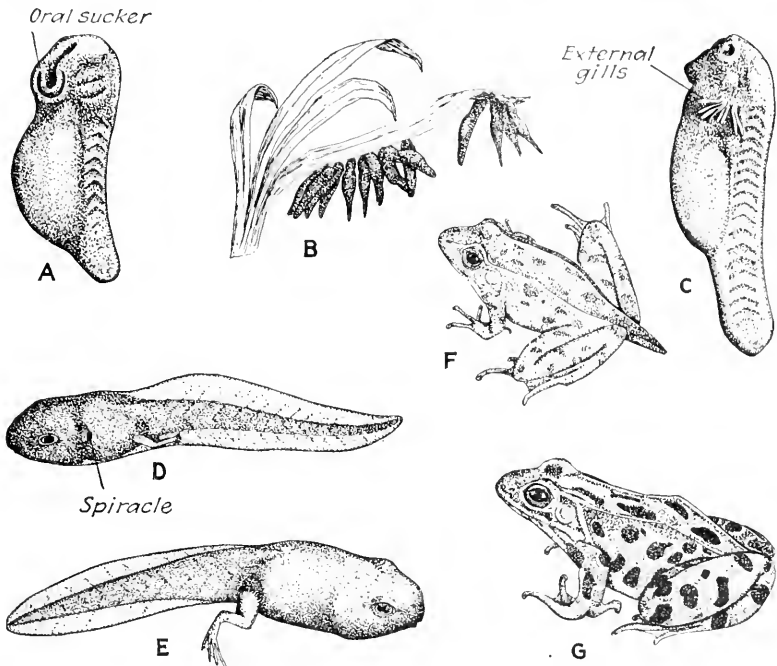

FIG. 254.—Later stages in the development of the frog. *A*, embryo at time of hatching. *B*, tadpoles clinging to vegetation after hatching. *C*, stage showing external gills. *D*, gills covered by an operculum, the branchial chamber opening to the outside by the spiracle; hind legs appearing. *E*, hind legs well developed. *F*, late stage in metamorphosis; legs all present, and tail nearly gone. *G*, the adult leopard frog, *Rana pipiens* Schreber. From models, and preserved and living (Fig. *G*) specimens.

the mouth, on through the gill slits, into the branchial pouch, and out through the spiracle.

Of the two pairs of limbs the hind pair appear first. Later the forelimb on the left side emerges through the spiracle, while the one on the right side breaks through the wall of the branchial pouch. The tail diminishes in size, being in part absorbed by cells in the body and in part inclosed by the body, until it is no longer apparent from the outside. The internal gills are also absorbed and lungs develop to function as respiratory organs, after which the gill slits close and the branchial pouch disappears. During the time between the giving up of branchial

respiration and the functioning of the lungs the skin becomes very vascular and respiration is carried on through it. Thus metamorphosis takes place gradually and changes the tadpole into a frog differing from the adult only in size.

401. Neoteny and Pedogenesis.—Pedogenesis has already been defined as the production of young by an immature animal. In the tailed amphibians cases are known in which the larval characters are retained until after sexual maturity. These animals may either be looked upon as adults which, having not metamorphosed, retain certain larval characteristics, or they may be considered as being larvae in which the reproductive organs are precociously developed. This prolongation of larval characteristics into advanced age has been termed *neoteny*, and reproduction by these animals may be termed *pedogenesis*. A classical example of these is seen in the larvae of species of *Ambystoma*. Under certain circumstances these salamanders do not metamorphose but retain their gills and their aquatic life and yet become sexually mature. In this condition they are known as *axolotls* (Fig. 247B). It has been found possible under experimental conditions to control metamorphosis and to produce the axolotl type at will. In nature these are particularly abundant in alkaline lakes and ponds throughout the semiarid regions of the West, and south into Mexico.

402. Regeneration.—Amphibians possess greater powers of regeneration than any other vertebrates. Limbs and tails of larvae when cut off readily regenerate. This of course is an advantage when mutilation occurs as the result of seizure by enemies.

403. Hibernation.—The power of hibernation is sometimes considered as an additional adaptation to terrestrial life. During the winter and frequently during seasons when bodies of water become dry, amphibians will bury themselves in the mud at the bottom and remain there in a dormant condition until spring or until the water is restored. During this period of dormancy the lungs are not used in breathing, and respiration must take place through the skin. The temperature of the hibernating animal remains slightly above that of the earth about it, only a small amount of physiological activity is maintained, and the organism lives on food stored in its body. In some tropical countries amphibians exhibit a similar dormant condition during the heat of the summer. This phenomenon is known as *estivation*.

404. Economic Importance.—Amphibians are almost without exception beneficial, and some, particularly the toads, are of considerable importance as destroyers of noxious insects. Frogs are used as food, the hind legs only being eaten, and frog farms are now being operated in Wisconsin, California, and a number of other states. Frogs are also used very extensively in laboratory experimentation and as fish bait.

CHAPTER LVI

REPTILES AND BIRDS

The next two classes, which include reptiles and birds, have so many features in common that it has been suggested that they form a single class, the Sauropsida. This view, however, has not been generally accepted. These classes differ from Amphibia by characteristics which show a more decided adaptation to terrestrial life and which completely emancipate the animals included in them from an aquatic environment. Although there are in each class types that have returned to aquatic life, they do not again regain the characteristics which belong to aquatic vertebrates as such.

405. Structural Characteristics.—Among the structural characteristics which the reptiles and birds possess in common and which separate them from the amphibians are: (1) They possess but one condyle at the base of the cranium; the amphibians have two. A *condyle* is a rounded projection for articulation with the vertebral column. (2) The lower jaw on each side is connected with the cranium by means of a *quadrate* bone, a bone derived from the first branchial, or hyoid, arch. (3) A complete *thoracic basket* is formed by the ribs, which meet a sternum, or breastbone, in the ventral median line. (4) Respiration is carried on throughout life by *lungs*, and though branchial arches appear early in embryonic life, their development ceases before gill slits are formed. (5) The kidney is a *metanephros*. (6) The eggs are *meroblastic* and not holoblastic. (7) Embryonic membranes known as the *amnion* and *allantois* are developed during embryonic life.

Reptiles and birds also differ from mammals in the following ways: (1) The latter have two condyles. (2) In mammals the quadrate bone does not enter into the articulation of the lower jaw but becomes one of the bones of the middle ear, the lower jaw itself articulating with the cranium. (3) Mammalian development shows characteristic modifications, adjusting the young to development within the body of the mother.

406. Embryonic Modifications.—The eggs of fishes and of amphibians, which are laid in the water and buoyed up by it, are usually protected only by a gelatinous covering. The aquatic environment prevents them from drying and they do not suffer from the effects of mechanical contacts since they move freely in the water in which they are suspended. When, however, as in the case of the reptiles and birds, the eggs are deposited outside water, they need protective envelopes to prevent

them from drying and also need to be safeguarded from mechanical injuries. Certain coverings of the egg meet the former need, and an amniotic sac the latter.

407. Egg.—Three coverings are added to the egg cells as adaptations to development in a non-aquatic environment (Fig. 255). These are (1) a layer of *albumen*, which provides protection against drying and mechanical injury and also serves as food for the embryo; (2) an *egg membrane*, which in some cases becomes thick and leathery and to which may be added lime; and (3) a *shell*, present in many reptiles and normally in all birds, composed entirely of lime. The albumen, the membrane, and the shell are all secreted by glands lying along the course of the oviduct in the order in which the envelopes which they form are added.

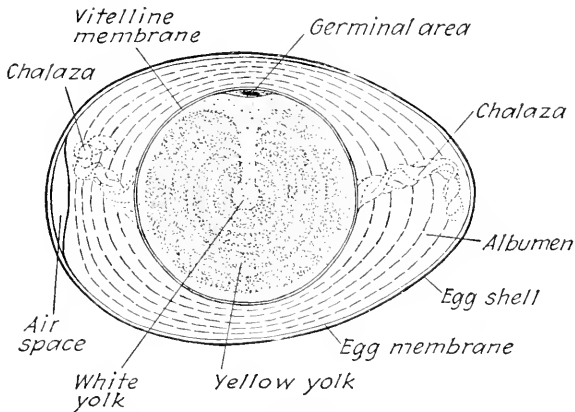

FIG. 255.—Diagrammatic section of a hen's egg.

408. Amnion.—Since the eggs of reptiles and birds are meroblastic, discoidal cleavage occurs and a sheet of cells, the blastoderm, is formed. From a part of the blastoderm is developed the embryo, and the rest of it grows around and completely envelops the yolk. The blastoderm splits, forming two layers, ectoderm outside and entoderm inside, next to the yolk. Between these appears a third layer, the mesoderm, and this also splits into two layers, one of which, the somatic layer, lies next to the ectoderm and with it forms the somatopleure, the other, the splanchnic layer, next to the entoderm and with it forms the splanchnopleure. Between these two mesodermal layers is the coelom (Fig. 256 B). The *amnion* is a fold of the blastoderm outside the area forming the embryo and is composed of two layers (Fig. 256 C), ectoderm and somatic mesoderm, or somatopleure. As this fold grows up around the embryo it meets above and incloses a sac, known as the *amniotic sac*, which surrounds the embryo and which becomes filled with a watery liquid known as the amniotic fluid (Fig. 256 D). The embryo is free to move in this sac and thus is protected from jar, though the eggs may

be rolled about or be subjected to blows from without. The outer wall of the amniotic fold is continuous with a fold of the somatopleure which grows down around the yolk sac. As the splanchnopleure also extends down around the yolk sac a space is formed between the somatopleure and splanchnopleure, the wall of which is mesoderm and which is known as the *extra-embryonic coelom* (Fig. 256 D).

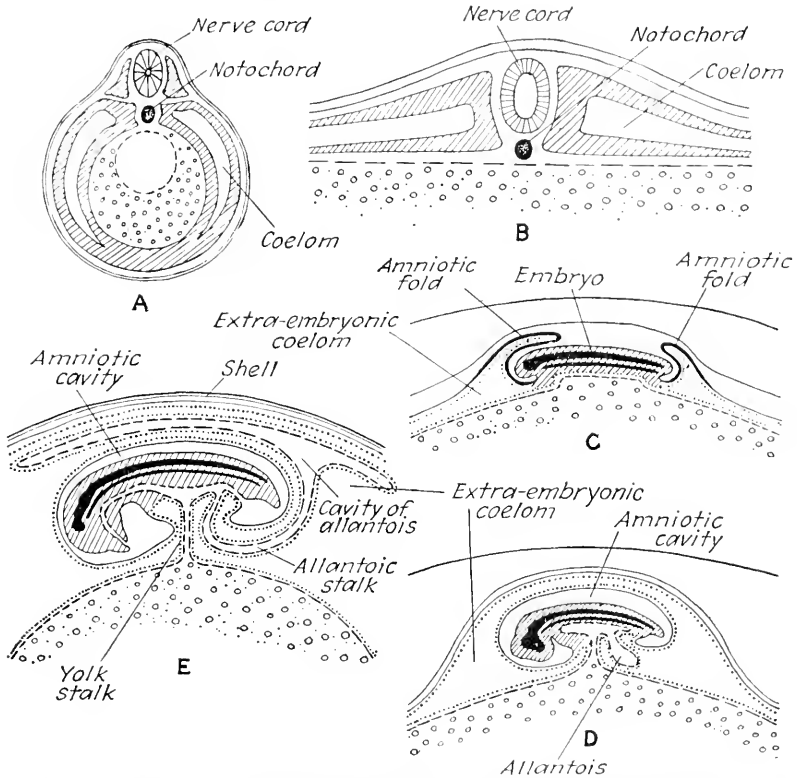

FIG. 256.—Diagrams of the development of a bird's egg. A, cross section of an amphibian embryo for comparison with B, which is a cross section of an avian embryo at an early stage. C, D, and E, stages in the development of amnion and allantois in the bird, shown in longitudinal section. Ectoderm is shown in C, D, and E by a solid line, entoderm by dashes, mesoderm in mass by crosslines, and somatic mesoderm and splanchnic mesoderm by dots.

409. Allantois.—Since the embryo needs oxygen, a means must be provided for respiration. This is afforded by the *allantois*, which is an outpocketing of the enteron posterior to its connection with the yolk sac, the wall of which consists therefore of entoderm and splanchnic mesoderm. This outpocketing projects into the extra-embryonic coelom (Fig. 256 D) and as it develops it expands mushroomlike against the outer wall of that cavity (Fig. 256 E). The amnion and allantois together form what has often been termed a *chorion*, which is spread

out over the inner surface of the egg membrane. The egg membrane is in turn in close contact with the shell. Into this chorion extend the allantoic blood vessels, which form a rich capillary network (Fig. 257). Since the shell is in all cases sufficiently porous to permit of the passage of air, respiration is carried on through it. This explains why it is fatal to the developing embryo if the shell is covered by any material which closes the pores and makes it impervious to the passage of gases.

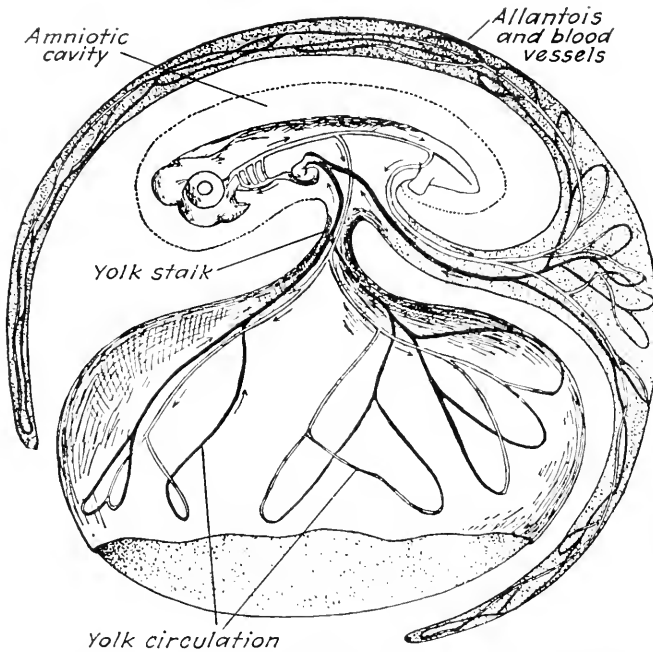

FIG. 257.—Diagram of a stage in the development of a bird's egg, later than shown in Fig. 256, and indicating the circulation; arteries unshaded, veins black. Arrows show direction of blood flow. (From Wilder, "History of the Human Body," by the courtesy of Henry Holt & Company.)

When the young animal hatches from the egg, the connections of the amnion and allantois with the body are broken, and these are left behind in the empty shell. Though not much tissue is sacrificed, this presents a contrast to the condition seen in all previous types, in which all of the egg cell became part of the body of the animal to which it gave rise.

410. Body Coverings.—The birds and reptiles are distinguished particularly by the body coverings. Reptiles possess horny epidermal scales which usually overlap, and birds are covered by feathers which are similar in their origin and in their general mode of development to scales and which are, therefore, looked upon as modifications of them.

CHAPTER LVII
 CLASS REPTILIA

All reptiles possess three regions of the body—head, trunk, and tail. There is generally a sufficient constriction behind the head to form a neck. The typical body covering is composed of overlapping epidermal scales which form a hard coat of mail, protecting the body against drying and also against injury from ordinary mechanical contacts. Well-developed eyes are present, protected by lids in all forms except the snakes; two nostrils are situated toward the end of the snout; and behind

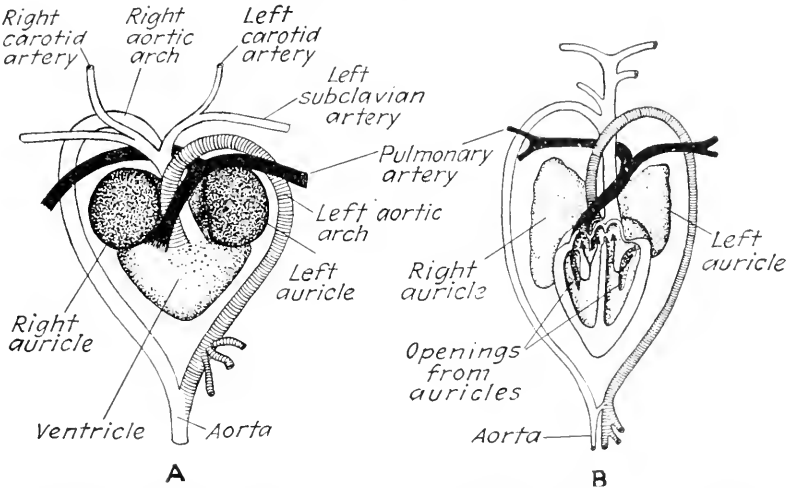

FIG. 258.—Reptilian hearts. A, heart and associated blood vessels of snapping turtle, viewed from in front. From a specimen, but somewhat diagrammatic. B, similar representation of crocodile's heart. (From Hertwig and Kingsley, "Manual of Zoology," by the courtesy of Henry Holt & Company.) Neither figure shows the venae cavae or the pulmonary veins. In both figures the vessels carrying arterial blood are unshaded; those carrying venous blood are black; and those carrying mixed blood are crosslined. The heart of the crocodile is cut open to show the chambers; the direction of blood flow is shown by arrows and the connection between the two aortic arches is also shown.

each eye is an ear opening. The mouth is terminal and the jaws may bear teeth, as in most reptiles, or may be furnished with a horny beak, as in the turtles. A cloacal opening marks the posterior end of the trunk region proper and the beginning of the tail. Four limbs are generally present, lacking only in snakes and a few lizards.

411. Classification.—The class Reptilia is divided into four orders:

1. *Squamata* (skwā mā' tā; L., *squamatus*, scaly).—Chameleons, lizards, and snakes.

2. *Rhynchocephalia* (rĭn kō sē fā' ĭ a; G., *rhynchos*, snout, and *kephale*, head).—One living type, a lizard-like animal found only in New Zealand.

3. *Crocodylia* (krōk ō dĭl' ĭ ā; G., *krokodeilos*, crocodile).—Crocodiles and alligators.

4. *Testudinata* (tēs tū dĭ nā' tā; L., *testudinatus*, like a tortoise).—Turtles and tortoises.

412. Internal Structure.—The heart of a reptile consists of two auricles and a double ventricle (Fig. 258A), the latter being divided by a septum which, however, is perforated, except in Crocodylia. The blood from the veins enters the right auricle, passes into the right ventricle and thence to the lungs. From the lungs it is returned to the left auricle, goes to the left ventricle, and out through the two aortic arches to the arteries. The blood in the two ventricles mingles to a certain extent, and so mixed blood is sent out over the body. In the Crocodylia (Fig. 258 B), where the ventricles are quite separate and the left aortic arch as well as the pulmonary artery arises from the right ventricle, a communication between the two aortic arches permits mixing of the arterial and venous blood. Renal-portal and hepatic-portal systems are both present, the latter being better developed than in the amphibians.

The lungs of reptiles are rendered more complex than those of the amphibians by repeated divisions of the bronchi and an increase in the number of the alveoli. This increases considerably the surface through which respiration is carried on.

The brains of reptiles (Fig. 259) show an advance over those of the amphibians in the better development of the cerebral hemispheres and of the cerebellum. The greatest advance, however, is in the appearance of a *cerebral cortex*. Here, as a result of the multiplication of the nerve cells and their regular arrangement, the roof of the cerebrum is divided into an outer gray layer and an inner white one. The cells in the gray matter are arranged in distinct groups or areas corresponding to the particular activities which they control. Such a brain roof is called a cortex.

In the reptiles the organs of sight and hearing are generally well developed, as are also to a lesser degree those of taste and smell, while the skin over various parts of the body is very sensitive to touch. There is usually a middle ear, with a tympanic membrane, a eustachian tube, and a columella. In the chameleons and snakes the tympanic membrane is absent; in the turtles it is on the surface of the body; and in the lizards and crocodiles it is at the bottom of a pit, which may be considered the beginning of an outer ear.

413. Squamata.—This order is characterized by a typical scaly covering which is shed periodically. In the case of snakes it is cast off complete and at one time, but in the lizards it is stripped off in shreds

during a period of several days. Three groups of Squamata are usually recognized—chameleons, lizards, and snakes.

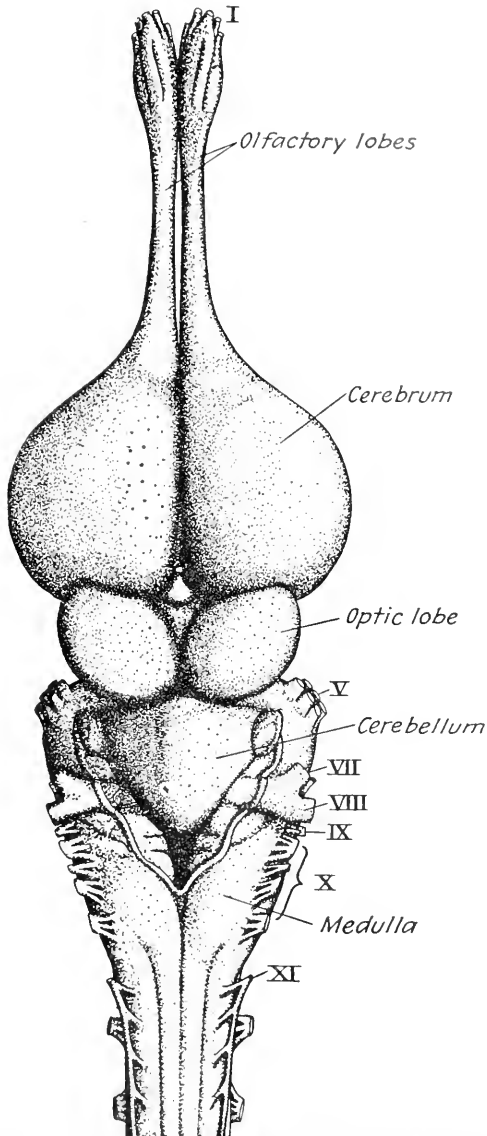

FIG. 259.—Brain of alligator, *Alligator mississippiensis* (Daudin), viewed from above. (From a Ziegler model, after Widersheim.) The roots of the cranial nerves are marked by roman numerals.

414. Chameleons.—Some lizards are erroneously called chameleons because of the ease with which they change color. This term, properly

speaking, should be restricted to certain Old World reptiles which possess several pronounced characteristics (Fig. 260). Among such characteristics connected with arboreal life may be mentioned a lateral compression of the body; the possession of a long prehensile tail which is not easily broken and which if lost cannot be regenerated; and the existence of long, slender limbs with digits so arranged that two are opposable to the three others, making the foot effective in grasping. In each group of digits, they are united nearly to their tips. The eyelids are united, except for a small central opening. The eyes are capable of being moved

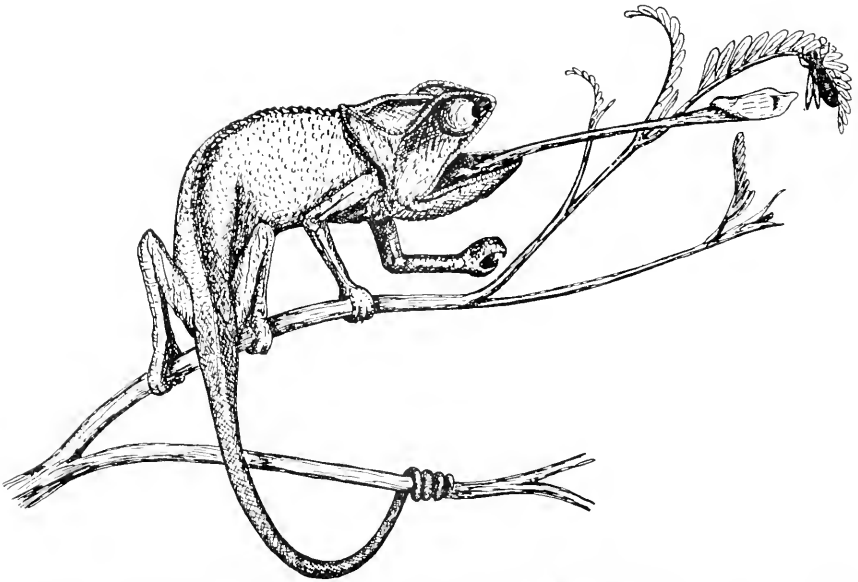

FIG. 260.—Common chameleon of southern Europe, *Chamaeleo vulgaris* Daudin. (Based upon figure in Brehm, "Thierleben.") $\times 2_3$.

independently and it is stated that the peculiar structure of the lids makes it possible for the animal to locate objects very exactly. The tongue, which is club-shaped and abundantly provided with a sticky secretion, can be protruded to a distance of six inches or more. This enables the chameleon to use its tongue for capturing insects, which constitute its entire diet. Chameleons are generally oviparous, although a few produce living young. They are famed for their power of changing color, which is due to the presence of chromatophores in the skin, affected both by outside stimuli and by stimulation by the nervous system.

415. Lizards.—The lizards are the most typical of the reptiles. The limbs are well-developed and modified for running, climbing, or digging. Rarely limbs are absent, in which case the animal has very

much the appearance of a snake. This is true of the so-called glass snakes of Europe and America, which are really lizards, and of some

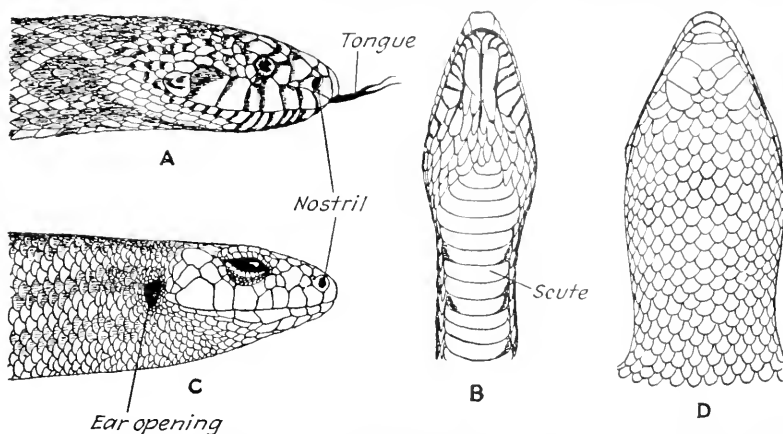

FIG. 261.—Heads of a bull snake, *Pituophis sayi* (Schlegel), and of a lizard, *Platiodon septentrionalis* Baird. A, head of the snake, from the side; B, from below. C, head of the lizard, from the side; D, from below. A and B, $\times 2_3$; C and D, $\times 2$.

burrowing lizards, known as worm lizards, found in southern United States. Legless lizards may be distinguished from snakes (Fig. 261) by the presence of movable eyelids and an external ear opening, both of which snakes lack, and by having small overlapping scales on the ventral side of the body instead of the transverse scutes which snakes possess. The tails of lizards are generally long, easily broken off or separated into pieces, and with equal ease more or less completely regenerated, though the regenerated appendage does not possess vertebrae. Lizards are in most cases oviparous and the eggs are protected by a thin shell with little lime in it. They feed largely on insects, worms, and other small animals and some are to a considerable degree vegetable feeders.

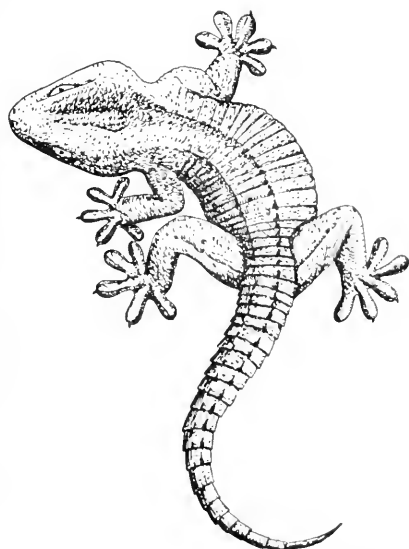

FIG. 262.—Wall gecko, *Tarentola mauritanicus* (Linnaeus), of southern Europe. (From Beckm, "Thiërchen.") $\times 2_3$.

Geckos (Fig. 262) are lizards which inhabit all warmer regions, are nocturnal, and have toes fitted for climbing, thus enabling them to run over trees and rocks and even over the walls and ceilings of buildings. The flying dragon, found in southeastern Asia and the East Indies, has

the ribs extended beyond the sides of the body and covered by a thin membranous fold of the skin, forming a sort of gliding plane. In tropical America are large lizards known as iguanas which are a favorite article in the native diet. The horned toads of the West are lizards. The only poisonous lizard known is the Gila monster found from southwestern United States to Central America. The largest lizards in the world are the monitors of the Lesser Sunda Islands in the Malay Archipelago which reach a length of 15 feet.

416. Snakes.—Snakes differ from lizards and chameleons in the structure of the lower jaws; in the absence of both free limbs and girdles, though in a few forms a trace of the pelvic girdle is present; and in the absence of a urinary bladder.

Owing to the fact that the lower jaws on the two sides are but very loosely connected in the median line and that they are also loosely attached to the quadrate bone, which is in turn loosely attached to the skull, the mouth may be greatly expanded. Since there is no sternum and the ribs are not attached ventrally, the throat and body are capable of great distension. Thus snakes, which always swallow their food whole, are able to ingest objects actually much greater in diameter than the head or body of the snake itself. During the process of swallowing, the teeth, which point backward, are used to hold the prey and those of the two sides are brought into use alternately. While the teeth of the jaws on one side are holding the prey, those of the jaws on the other side are loosened and that side of the mouth is carried forward over the object being swallowed, after which those teeth are again set in. Then the teeth on the first side are loosened and that side of the mouth is carried still farther ahead and those teeth in turn set in. Thus by working the two sides of the mouth alternately, the animal gradually forces the object down into its esophagus, through which it is passed by peristaltic movements to the stomach. Since during the process of swallowing food the passage of air through the mouth would be interfered with, the glottis is carried far forward in the floor of the mouth, opening just behind the lower teeth. The cartilages of the trachea prevent it from being closed, and breathing is in this way permitted while the food is being swallowed.

Over the sides and back of the body of a snake the scales overlap like shingles on a roof. On the ventral surface, however, there is a series of broad scales known as *scutes*, each one of which runs from one side of the body to the other and which overlap like the weatherboards on a house. The posterior margin of a scute can be projected, and as its rough edge is pressed against the surface on which the snake is, it serves as an organ of prehension. As waves of contraction pass from the head backward, while the scutes are used in clinging, a slow forward gliding results, which is the normal mode of locomotion. This is usually accompanied by lateral convolutions. The latter mode of locomotion is also

used on a smooth surface where the scutes do not gain a hold. When the snake is alarmed, it attempts to make more rapid headway by alternately throwing the body into coils and then straightening it again. Swimming is also accomplished by lateral convolutions of the body.

The whole epidermal covering is shed at one time and several times during a year. After a new horny covering is formed under the old one, the latter is freed along the margins of the jaws and the animal literally crawls out of its old skin, which becomes turned inside out in the process. When snakes are about to shed, the old skin becomes dull and opaque. The eyelids are fused over the eyes, which are covered with transparent scales, and since at this time these scales also become opaque, the snake is partially blind. After shedding, the new covering is bright and the eyes are once more perfectly clear.

Snakes possess very good vision. As they have no tympanic membrane, their sense of hearing is not highly developed. Their sense of smell is good, but that of taste poor. The tongue is slender, deeply forked, and lodged in a sac in the floor of the mouth. When the jaws themselves are closed, the tongue may be protruded through an opening formed by notches in the two jaws (Fig. 261). The tongue is used as an organ of touch and with it the snake tests objects. Contrary to popular opinion it can inflict no wound.

The majority of snakes lay eggs but a few are viviparous. The idea is prevalent that snakes can swallow their young when danger threatens but this is not supported by scientific observation.

Snakes are more abundant in the tropics than elsewhere and are frequently absent from islands, though found on the adjacent continents. Some snakes live mostly in and about fresh water; some live in salt water; others are subterranean, burrowing in the ground; while still others are expert tree climbers. The largest of snakes are a python found in Burma, which reaches a length of over 30 feet, and an anaconda of the region of the Amazon in South America, which may approach 40 feet in length.

417. Venomous Snakes.—The sea snakes are very poisonous. They are tropical forms found in the Indian Ocean, the adjacent parts of the Pacific, and along the western coast of South America. They belong to the same general group as the coral snakes and the cobras, all having tubular fangs in the anterior part of the upper jaw, in connection with which are poison glands which secrete a very effective venom. The cobras are found in India, China, the Malay Archipelago, and Africa. These snakes are capable of expanding the anterior part of the body and of raising the head and that part of the body well off the ground. In this attitude they strike. India is outstanding for the number of species of venomous snake living in its area and many people die there from snake bites each year.

Among the snakes called vipers are the pit vipers, represented in the New World by the many species of rattlesnakes, the water moccasin, and the copperhead. In all of these the young are brought forth alive. The water moccasin, found in southern United States, is one of the most poisonous of all snakes. The copperhead, found farther north, is also very venomous. Rattlesnakes possess a series of hollow epidermal

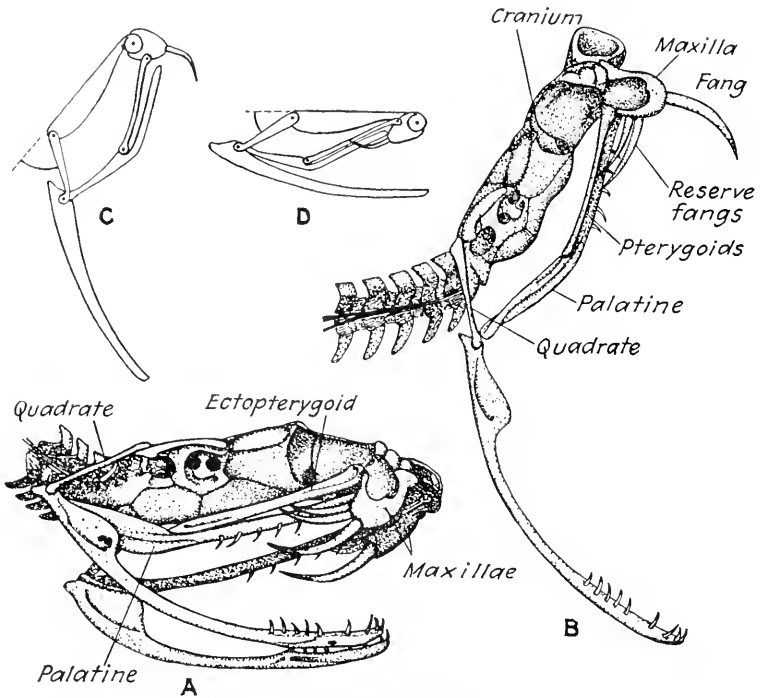

FIG. 263.—Skull of rattlesnake, *Crotalus confluentus* Say. From a young specimen from Montana. A, entire skull, seen from the side and below. B, lateral view, with jaws of only one side shown. The erection of the fang is caused by the thrust of the ectopterygoid against the movable maxilla. When the mouth is closed the ventral end of the quadrate, to which the lower jaw is articulated, is carried backward, the palatine and pterygoids are brought up toward the floor of the cranium, and the fangs lie against the roof of the mouth. But when the mouth is opened the articulation of the quadrate and lower jaw is brought forward, causing the palatine and pterygoids also to be carried downward and producing a forward movement of the ectopterygoid, which in turn erects the fang. In C and D is shown a mechanism which would work in the same fashion.

buttons linked together and forming a rattle attached to the tip of the tail, which is itself flattened, hardened, and constricted to receive the anterior margin of the basal rattle. A new button is added to the series of rattles every time the skin is shed. Since this may occur several times a year, and since rattles may be lost, the number possessed by an individual is no precise indication of the age of the snake.

The pit vipers (Fig. 263) have long, curved fangs near the anterior end of the upper jaw. When the mouth is closed they lie against its

upper wall, but when it is opened widely they are raised and stand nearly at right angles to this surface. In this position when the snake strikes, they are driven straight forward into the body of the animal struck; at the same moment poison is injected into the wound from the poison glands at the bases of the fangs. Snakes use their poison fangs both in securing prey and in defending themselves from enemies. When fangs are lost they are replaced by other fangs which lie concealed behind the functional ones and come up one at a time to take the place of the lost fangs.

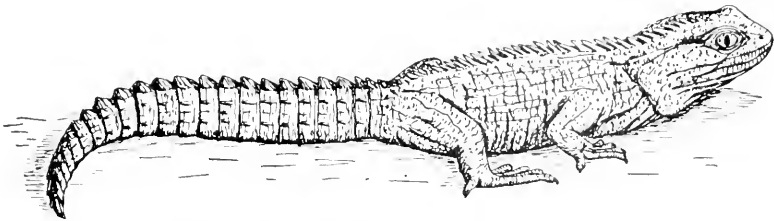

FIG. 264.—Tuatara, *Sphenodon punctatum* (Gray), of New Zealand, an example of the Rhynchocephalia. \times about $\frac{1}{6}$. Compiled from several sources.

418. Rhynchocephalia.—The only representative of this order is the tuatara of New Zealand, *Sphenodon punctatum* (Gray). It was formerly found throughout New Zealand but is now restricted to some small neighboring islands and is threatened with extinction. It is lizard-like (Fig. 264), about two feet in length, lives in burrows, is nocturnal in its habits, and feeds on any other animal it can secure. Among other structural features which it possesses is a more highly

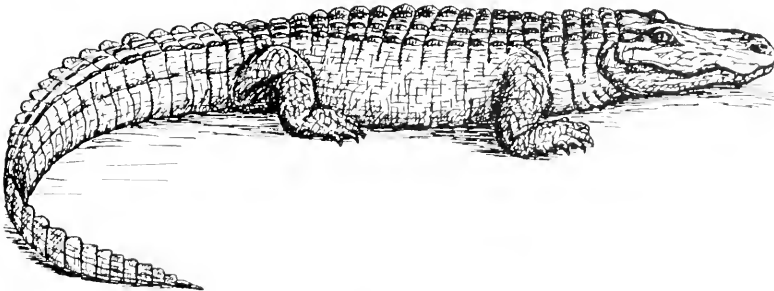

FIG. 265.—North American alligator, *Alligator mississippiensis* (Daudin), an example of the Crocodilia. \times about $\frac{1}{16}$. From several sources.

developed *pineal eye* than is possessed by any other animal. This is an eye developed from a median dorsal outgrowth of the diencephalon; it is rudimentary in all living vertebrates, being most highly developed in lizards, and is often called the pineal gland or pineal body. It is believed to have functioned as an eye in types now extinct and in living forms it has been looked upon as a gland of internal secretion. Although this animal has some characteristics which belong to fossil reptiles and has long been looked upon as the most primitive of existing reptiles,

it now seems probable that it is not an ancestral form from which other lizards have sprung but rather a highly modified type which has persisted from earlier times.

419. Crocodilia.—This order contains some of the largest living reptiles, the gavials of southern Asia and the caymans of South and Central America reaching a length of 20 feet or more and a Philippine crocodile having been captured measuring 29 feet in length. A crocodile

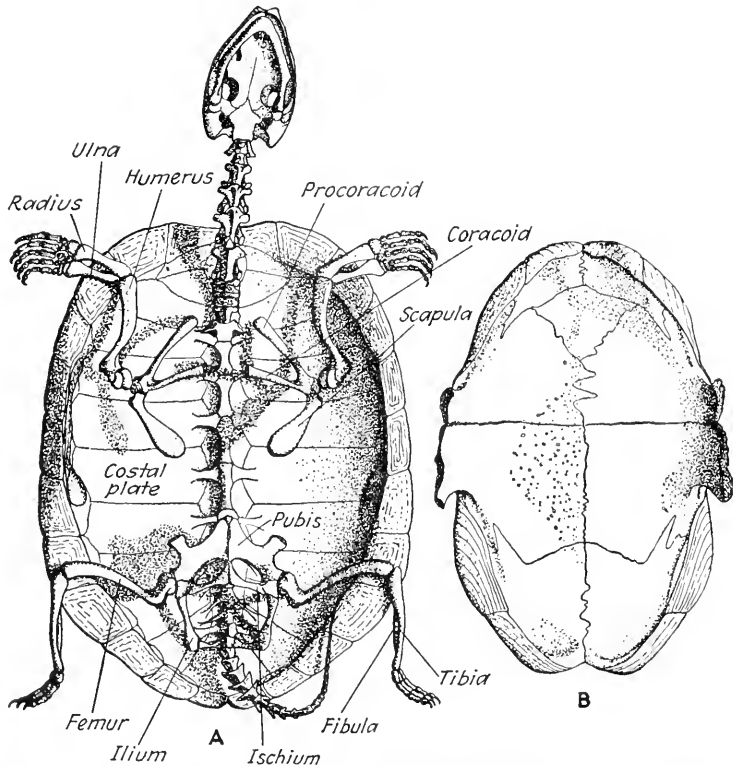

FIG. 266.—Skeleton of a European turtle, *Cistudo lutaria* (Marsili). From a mounted preparation. A, the carapace with the internal skeleton. B, the plastron, removed. The limb skeletons are inside the ribs. $\times 35$.

and an alligator (Fig. 265) are found in southern United States. Crocodilia are lizard-like in form but the scales do not overlap, being set into the thick, leathery skin, broadened, and sometimes raised to form ridges. The snout is long and the nostrils are at its tip. Since the eyes project from the top of the head, the animal can lie just under the surface of the water with only its eyes and its nostrils exposed. The eyes are covered with lids and both nostrils and ears possess valves which may be closed when the animal is under water.

There are several noteworthy details connected with the internal anatomy. The teeth are conical, set in sockets, and are capable of

being shed at intervals and replaced. The tongue is flat and cannot be protruded, but it may be lowered and carried backward to prevent water from entering the esophagus if the mouth is opened while the animal is submerged. Lateral folds meet and form a palate that separates the nasal chamber from the mouth and the nasal chamber becomes divided by a median septum. The lungs are in a pleural cavity separated from the rest of the body cavity by a diaphragm analogous to that of the mammals.

420. Testudinata.—The turtles and tortoises, which names are used interchangeably, show the greatest departure from the typical reptilian form. The body is inclosed in a shell (Fig. 266) consisting of a dorsal carapace and a ventral plastron. Into this shell may be drawn the head and neck, limbs, and tail, when the animal is threatened with danger. Although turtles breathe by means of lungs, they may remain under water for a considerable time before needing to come to the surface for air. Since the shell prevents the lungs from being expanded and contracted, air is pumped into them by movements of the neck and feet. Some aquatic turtles also possess thin-walled sacs on each side of the cloaca which may be alternately emptied and filled with water and through the vascular walls of which respiration may take place while the animal is submerged.

All turtles are oviparous. Their eggs, which are nearly spherical, are covered with a hard, white shell and deposited in nests in the ground.

America is the richest of all regions in its turtles and tortoises. Giant tortoises found on islands off the west coast of South America and in the Indian Ocean reach a weight of more than 300 pounds and probably attain an age of over four hundred years. They are relics of past ages and owe their survival to the isolation of the islands on which they live. The largest turtle known is a marine leathery turtle which reaches a weight of 1000 pounds or more.

421. Economic Importance.—Reptiles are economically either injurious or beneficial. Most snakes, being nonvenomous and destroying injurious insects and mammals, are distinctly beneficial, though some do injury by destroying birds and their eggs and young. Other snakes are dangerous to man because of their venom. Generally speaking, lizards are beneficial because of their insect-eating habits; one or two have been noted as being sources of food; and on the other hand one type, the Gila monster, is poisonous. Crocodiles and alligators are feared in the countries in which they live because of their attacks upon persons going into the water, but they are valuable for the skins which they furnish. None of the turtles is injurious, and some are useful as food, being more often used in this manner than are any other reptiles. Certain tortoises yield tortoise shell which is widely used commercially, although it is now largely replaced by an artificial product.

CHAPTER LVIII

CLASS AVES

Although birds have many points in common with reptiles, living birds are easily separated from living reptiles by certain pronounced characteristics, the most prominent of which is the possession of feathers. Living birds are all bipeds, the only reptiles sharing this characteristic being the extinct dinosaurs from which the birds were probably derived. Another characteristic of living birds is the absence of teeth, their jaws being covered by a horny beak; this characteristic, however, is shared with the turtles. The caudal vertebrae are greatly reduced in number, and all but a few of the anterior ones, which remain free, are fused into a single bone known as the *pygostyle*, or plowshare bone; this characteristic is shared with extinct reptiles. Birds also possess forelimbs modified to form wings; there were flying reptiles, now extinct, but their wings were not constructed upon the same plan as those of birds, nor are they regarded as the ancestors of birds. It appears, then, that in spite of the similarities in fundamental structure and mode of development between birds and reptiles, both living and extinct types can be clearly distinguished.

422. External Characteristics.—The body of a typical bird is spindle-shaped, being fitted by form for rapid movement through the air. It is divided into four regions—head, neck, trunk, and tail. The neck is long and flexible, correlated with the modification of the forelimb for flight. The latter fact makes it necessary for the bird to use its beak in the carrying on of certain activities connected with the securing of food and nest building which in other animals belong to the forelimbs.

The forelimb is relatively slender, possesses muscles nearly to the tip, and is covered by feathers. Along the posterior margin are attached a series of long flight feathers which make up most of the surface of the wing. When the bird is at rest the wing is folded against the side of the body and occupies little space, but when it is outstretched the distance from one wing tip to the other usually exceeds—in some cases very greatly—the length of the body.

The functions of the hind limb are mainly those of support and locomotion on the ground or in the water, it being used in perching, walking, running, climbing, or swimming. It terminates in a foot typically made up of four toes, three anterior and one posterior, these ending in curved claws. The thigh and more or less of the next joint are muscular

and are covered with feathers; the rest of that joint, called the shank, and the toes are naked and covered by horny epidermal scales. The bare portion of the leg is not muscular, containing only tendons passing from muscles in the upper part of the leg to the toes (Fig. 276). In some birds, as in the owls, however, feathers may even extend over the toes themselves. Birds walk only on their toes (Fig. 267).

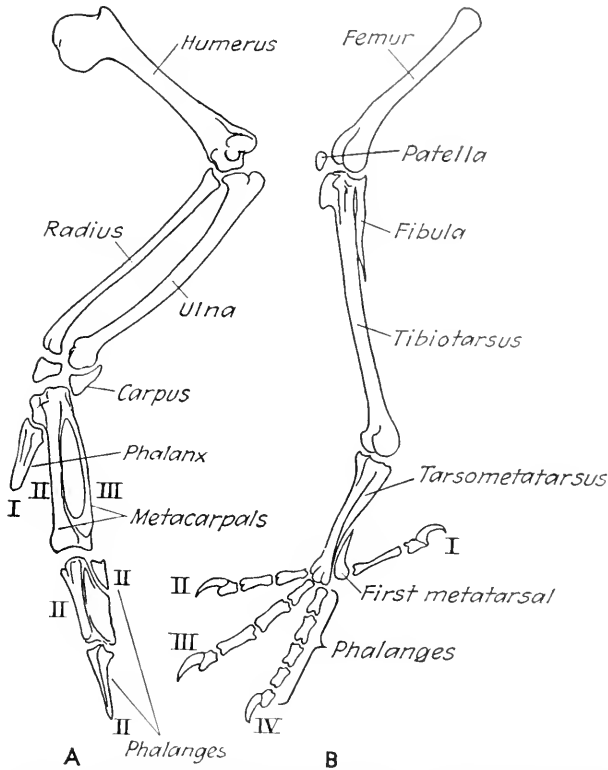

FIG. 267.—Leg and wing bones of a pigeon to show the homology between the two and the modification of each. A, wing; B, leg. From a specimen.

The fleshy part of the tail is small and is concealed by the feathers of the trunk. It bears a number of long tail feathers which when spread often present a considerable area. The tail serves as a rudder and an accessory organ of flight, though it is also used in balancing and in some birds in the support of the body when the bird is clinging to a vertical surface.

423. Feathers.—A typical feather is composed of a *quill* set into the skin and a continuation of the quill, the *shaft*, which bears slender *barbs* (Fig. 268). The barbs in turn bear still smaller and slenderer lateral projections known as *barbules*. When the barbs lie parallel and the barbules are hooked together so as to make of the whole a

practically continuous surface, the structure is known as a *vane*. When the barbs are not systematically arranged and form only a confused, fluffy mass, this is known as *down*.

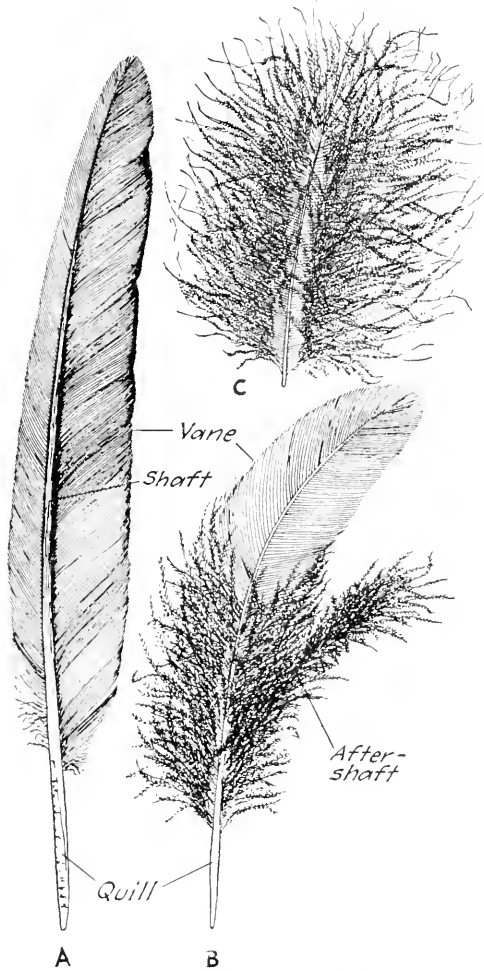

FIG. 268.—Types of feathers. A, flight feather. B, contour feather. C, down feather. From specimens. $\times 4\frac{1}{2}$.

Four types of feathers may be distinguished: (1) The typical feather, known as a *contour feather*, is downy near its base and toward the tip has a vane. The vanes overlap and provide a smooth outer plumage surface, while the down forms a heat-conserving layer under it. (2) *Flight feathers* differ from contour feathers in that they have practically no down and in that the vanes are greatly lengthened and stiffened. The flight feathers are set along the posterior margins of the forelimbs

and along the lateral margins of the tail. (3) *Down feathers*, consisting entirely of down, are inserted into the skin between the contour feathers and serve to increase the thickness of the down layer. (4) *Filoplumes*, or hair feathers, are feathers reduced to a slender, hairlike shaft with few or no barbs and remain when the bird is divested of the rest of its feathers.

The feathers are not distributed at random over the surface of the bird's body but are gathered together in certain tracts known as *feather tracts*; the form and arrangement of these vary among different species of birds, and thus they assist in determining relationships between them and aid in classification.

424. Internal Structure.—Throughout the internal anatomy of a bird are seen modifications which fit it for flight. The bird is of all animals that one most thoroughly and effectively modified for a particular type of locomotion.

The skeleton of the trunk is rigid, this rigidity being attained by fusion of the head bones and of the body vertebrae, by fusion of the ribs with the vertebral column and the sternum, and by an additional bracing at the sides due to processes of bone called *uncinate processes* passing from one rib backward over the next. The flexible neck and a joint at the base of the tail provide the only movement in the axial skeleton. The sternum in all flying birds has a pronounced crest or *keel* for the attachment of flight muscles. All of the bones of the skeleton are slender but very firm and in some cases are hollow. Lightness in bones is secured by a minimum of actual bone and strength by a general application in their internal structure of the engineering principles involved in the use of thin plates at right angles to one another as in an I-beam.

The muscles of the back are greatly reduced, while those of the breast are correspondingly developed, since they are the ones most used in flight. The muscles of the hind limbs are also well-developed.

In many types of birds there is an enlargement at the lower end of the esophagus forming a *crop* (Fig. 269). This is most highly developed in seed-eating birds, less so in insect eaters, and is practically absent in fish-eating birds. The stomach consists of two portions—an anterior glandular part called the *proventriculus*, which secretes the gastric juices, and a posterior muscular *gizzard*, which is used in grinding the food. Birds swallow pebbles and other hard objects which contribute to the grinding, the gizzard having a horny lining which protects its wall during this process. The alimentary canal opens into a cloaca.

The heart of a bird is relatively large and is composed of two entirely distinct ventricles and two thin-walled auricles. The systemic and pulmonary circulations are entirely separate. The one aortic arch corresponds to the right aortic arch of reptiles.

The lungs of birds are not capable of dilation since the thoracic skeleton forms a rigid framework. Breathing is allowed by the presence of a large number of *air sacs* (Fig. 269) lying among the muscles and about the viscera in various parts of the body and communicating with the bronchi of the lungs. Air is drawn into the windpipe, through the lungs, and on into the air sacs by the action of the muscles of the thorax

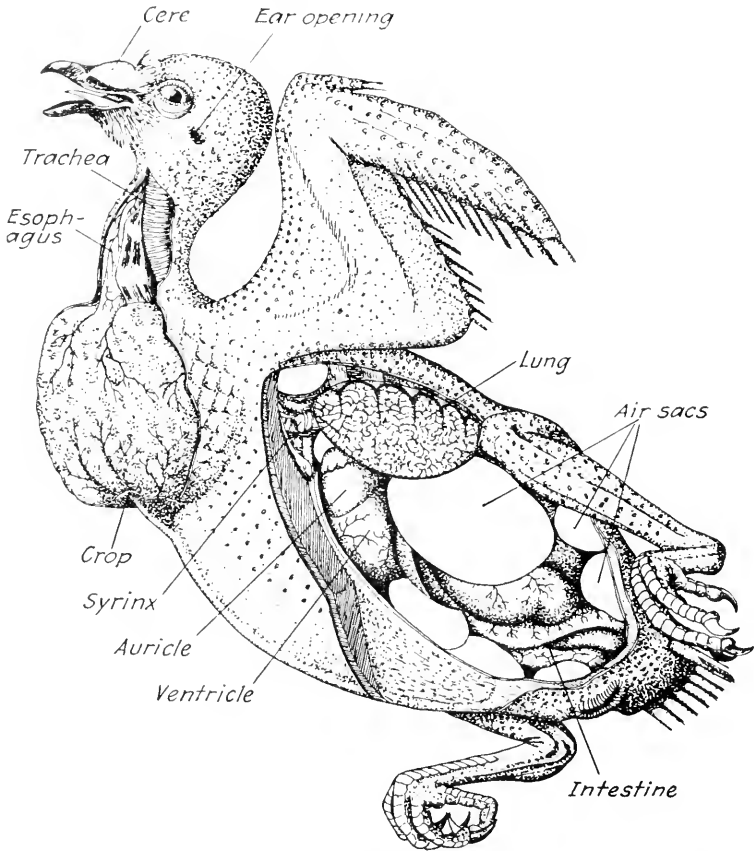

FIG. 269.—Dissection of a pigeon, *Columba livia* Linnaeus. (Based upon a Pichler chart, by the courtesy of Martinus Nijhoff.)

and abdomen. Thus the air in the lungs is practically entirely changed with each respiration, which results in a very perfect aeration of the blood and is responsible for the high temperature of the body. Birds maintain temperatures varying from 40.5°C. (105°F.) to as high as 46°C. (115°F.). While flying the movements of the wings contribute to respiration by compressing and dilating the air sacs, and thus the bird breathes more easily when in flight than at other times. The possession of air sacs is also shared with many reptiles, especially the lizards,

among which, however, they are not developed to the degree seen in birds.

The kidneys have a reduced renal-portal system. There is no urinary bladder and the urinary secretion passes directly out with the feces. The female bird has but a single ovary, the right one disappearing during development.

The brain of the bird is relatively short and broad (Fig. 270). The cerebral hemispheres are large, but the olfactory lobes are very small, indicating a poor development of the sense of smell. The large optic lobes correspond to the great development of the power of sight, and the very large and much convoluted cerebellum indicates the delicate

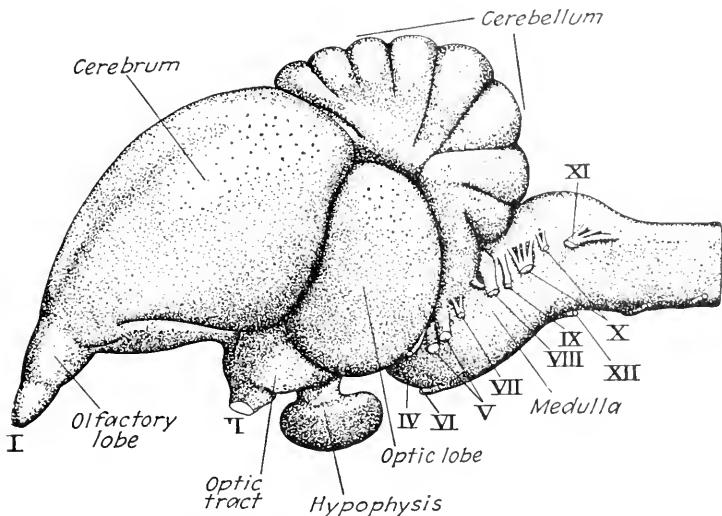

FIG. 270.—Brain of pigeon, viewed from the side. (From a Ziegler model, after Wiedersheim.) The roots of the cranial nerves are marked by roman numerals. The hypophysis is also called the pituitary body.

sense of equilibrium and the great power of muscular coordination belonging to birds.

Although the sense of taste is present it is not well-developed. The ear is more complex than that of reptiles and the sense of hearing relatively acute. The eyeball is large, is much elongated, and the cornea is very convex. Bony plates are developed in the sclerotic coat. There is also a peculiar structure known as the *pecten*, suspended in the vitreous body. The pecten is highly vascular, pigmented, and fan-shaped. Its function is not known, although it may have something to do with the nutrition of the eyeball—or, possibly, it assists in accommodation, which in birds is remarkably well-developed. Birds of prey, which plunge at high speed from great heights upon their quarry on the ground or which follow it through the branches of a woodland, need the maxi-

num of quickness and accuracy in accommodation. Birds possess a *nictitating membrane*, which is drawn across the eyeball from the inner angle of the eye outward.

425. Classification.—The classification of birds is a question about which there has been much difference of opinion. All classifications agree, however, in distinguishing between the ancient, reptile-like, fossil birds forming the subclass *Archaeornithes* (är kē ôr' nī thēz; G.,



FIG. 271.—Fossil remains of *Archaeopteryx siemensii* Daines, representing a specimen in the Berlin Museum. (From Steinmann-Döderlein, "Elemente der Palaeontologie.") $\times 27$.

archaios, ancient, and *ornithes*, birds) and represented by a single genus, *Archaeopteryx*, and a second subclass, the *Neornithes* (nē ôr' nī thēz; G., *neos*, new, and *ornithes*, birds), or modern birds, containing only a few extinct forms. *Archaeopteryx* (Fig. 271) was a bird about the size of the common crow, had teeth, three free fingers on the wing, flight feathers on the legs, and a long, lizard-like tail (Fig. 272). The caudal vertebrae were separate and the tail had flight feathers on both sides for its full length. The largest living bird is the African ostrich, which is 8 feet in height, but the *Aepyornis*, a bird which lived in Madagascar until about five centuries ago, attained a height of 10 feet. On the other hand, a

hummingbird found in Central America is only $1\frac{1}{2}$ inches long from the base of the bill to the base of the tail.

426. Origin of Birds and of Flight.—A former theory of the origin of birds was that they were derived from the flying reptiles, or pterodactyls. These reptiles, however, do not resemble birds structurally in the degree that some of the bipedal dinosaurs (Fig. 273) do. At the present time, therefore, the latter are usually looked upon as the ancestors of birds.

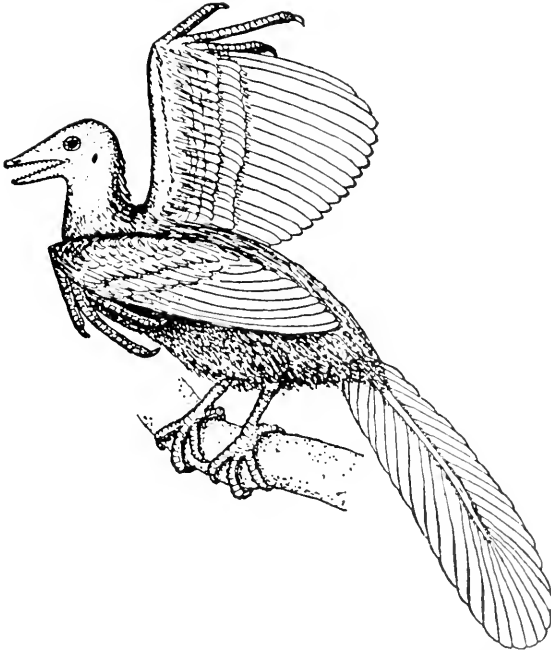

FIG. 272.—One conception of the appearance of *Archaeopteryx maerura* Owen, based upon a specimen in the British Museum. (From *Wieman, "General Zoology,"* after *Romanes*, by the courtesy of McGraw-Hill Book Company, Inc.) $\times 15$.

Different theories of the origin of flight have been proposed but the most probable theory seems to be the one which traces the development of wings to the broadening of the limbs and tail due to the increase in length of scales and their modification to form feathers. Apparently early birds had flight feathers both on their fore- and on their hind limbs and on both sides of the tail. Such a bird was capable of gliding through the air from a tree or elevated point, perhaps to a considerable distance. Gradually the forelimbs developed into wings, the feathers disappeared from the hind limbs, and the tail shortened and became modified into such a tail as birds possess today.

427. Flight.—In *sustained flying* the wings strike downward and forward and the bird rides over the air, which serves to buoy it up.

The tip of the wing traces a path in the air which is characterized by long downward and forward strokes, alternating with shorter upward and backward strokes. This action is modified in other modes of flight. After making several strokes, some birds hold their wings motionless and glide for a considerable distance before again making several more. Thus *gliding* is a second form of flight. In some cases before a high wind a bird will partly flex the wings and permit itself to be carried by the wind. This is a form of flight known as *flex gliding*. Another modification of flight is known as *soaring*, characterized by the bird, usually at a high elevation, describing great circles without any move-



FIG. 273.—Restoration of a bipedal dinosaur, *Ornithomimus*. (Redrawn from Barbour, "Reptiles and Amphibians.")

ments of the wings whatever. As it describes these circles it gradually works along with the wind. There is no doubt that soaring is usually due to the bird taking advantage of the upward rush of currents of air, though it may be that the bird can soar by taking advantage of a wind blowing horizontally. Still another form of flight is known as *hovering*, in which the bird remains poised in the air before a flower or above an object upon the ground, the tip of its wings apparently describing a figure eight.

428. The Bird as a Flying Animal.—A bird flies on the principle of an airplane, or heavier-than-air machine, rather than on that of a balloon, or lighter-than-air machine. Such a machine requires lightness and rigidity, which are secured by the character of the bird's skeleton.

Air sacs do not lighten the bird's body to any appreciable extent when the bird is in the air, as is often stated, though they do lighten it when the bird is swimming. Another requirement of an airplane is the possession of planes for support; in a bird the wings and tail furnish such planes, giving a broad surface for support and also being capable of adjustment

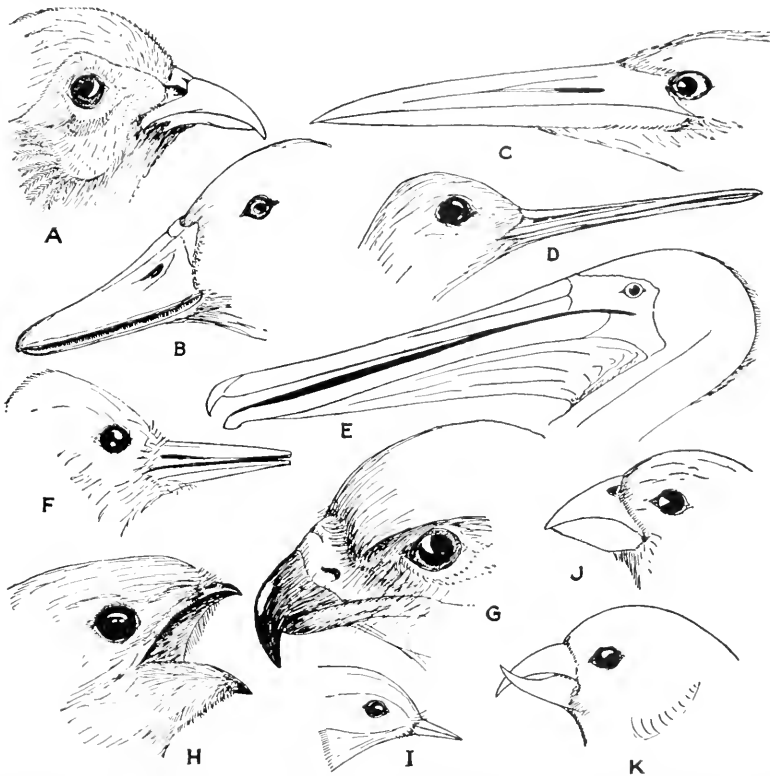

FIG. 274.—Beaks of birds. From mounted specimens. *A*, generalized beak of ring-necked pheasant. $\times 1_2$. *B*, straining beak of canvasback duck. $\times 2_5$. *C*, spearing beak of bittern. $\times 1_2$. *D*, probing beak of greater yellowlegs. $\times 1_2$. *E*, beak of brown pelican. $\times 1_6$. *F*, chisel-like beak of hairy woodpecker. $\times 2_3$. *G*, carnivorous beak of Swainson hawk. $\times 2_3$. *H*, insectivorous beak of nighthawk. $\times 2_3$. *I*, insectivorous beak of myrtle warbler. $\times 2_3$. *J*, granivorous beak of black-headed grosbeak. $\times 2_3$. *K*, beak of red crossbill. $\times 2_3$.

to variations in the direction and strength of the wind. A third necessity in such a machine is the development of a large amount of sustained power; this is secured by the great size of the flight muscles and by the very effective aeration of the blood, which results in rapid and continuous oxidation. The large size of the heart and the relatively great capacity of the blood vessels also contribute to the same end. Still other characteristics which contribute to the considerable and constant production of energy are the effectiveness of the processes of digestion and elimina-

tion. Steering and balancing are done by adjustments of the tail and wings. The feather covering insulates the body perfectly, prevents loss of heat and consequent chilling, and enables the bird to maintain under all conditions a practically constant temperature. In order to secure heat regulation and at the same time to guard against too high a tempera-

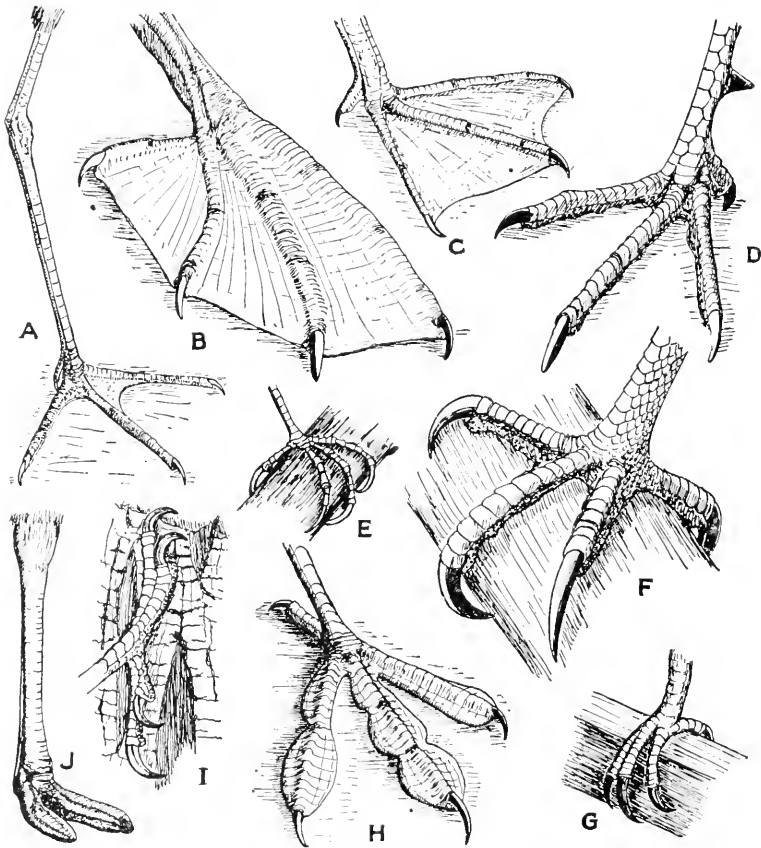

FIG. 275.—Feet of birds. From mounted specimens. Showing the inner side of the foot, except *J*. *A*, wading foot of greater yellowlegs. $\times \frac{1}{2}$. *B*, totipalmate foot of cormorant. $\times \frac{2}{5}$. *C*, swimming foot of blue-winged teal duck. $\times \frac{2}{3}$. *D*, generalized foot of ring-necked pheasant. $\times \frac{2}{3}$. *E*, perching foot of yellowthroat. About natural size. *F*, raptorial foot of Swainson hawk. $\times \frac{2}{3}$. *G*, syndactyl foot of kingfisher. $\times \frac{2}{3}$. *H*, lobate foot of coot. $\times \frac{2}{5}$. *I*, clinging foot of flicker. $\times \frac{2}{3}$. *J*, running foot of ostrich. $\times \frac{1}{15}$.

ture, the bird perspires into the air sacs. Thus during flight, when a great deal of heat is produced, the temperature is regulated by a very perfect internal cooling device. There are no skin glands in the bird except the oil gland at the base of the tail, the secretion of which is used in oiling and dressing the plumage.

429. Modifications of Birds.—Birds show less variation than any other class of vertebrates, but within narrow limits they exhibit a large

number of modifications. These involve (Fig. 274) connected with the kind of food and the manner of securing it. Examples of such are the flat, straining beaks of ducks; the powerful and sharply pointed spearing beaks of herons; the long, slender, probing beaks of snipes and sandpipers; the chisel-like beaks of the woodpeckers; the stout, hooked beaks of gulls, hawks, and owls; the small, slender, and sharply pointed beaks of the insectivorous birds; and the relatively larger, heavier beaks of the grain-eating song birds. The feet are also modified (Fig. 275) in accordance with the character of the environment and the manner of locomotion. These modifications are illustrated by the lobed feet of diving birds; the webbed feet of swimming birds; the long legs and long toes of wading birds; the possession of two toes in front and two behind by climbing birds; and the long, slender toes and curved claws of perching birds (Fig. 276). Other modifications involve the tail, which is practically absent in some diving and running birds and most highly developed in birds whose powers of flight are greatest. The wings are also variously developed in proportion to the power of flight and are much reduced in all running birds and in some diving birds which do not fly at all. In the diving birds the feet are carried back to the posterior end of the body where they serve effectively as propellers in underwater swimming.

430. Plumage.—The plumage of birds varies considerably, fitting them for various modes of living. Among the flightless birds are many which live in desert regions and the feathers of which are slender and do not overlap. The wings of penguins are covered with feathers which are scale-like. There are also numerous curious modifications of the feathers on the head, wings, and tail. Especially conspicuous among birds

modifications of the beak

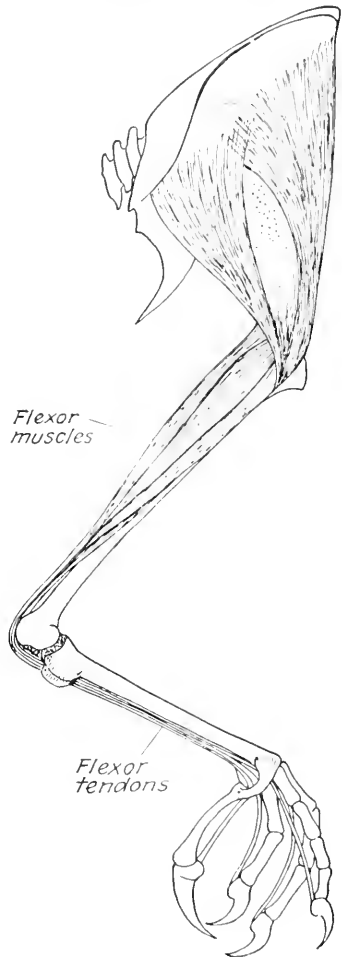

FIG. 276.—Mechanism of perching in birds. Preparation from a crow. The flexor muscles are shown ending in tendons which pass behind the joint between the tibia and the tarsometatarsus and under a bony arch near the upper end of the tarsometatarsus. Running under a ligament at the bases of the toes they are distributed to the individual digits. Because of this structure, when a bird flexes its legs and sits upon the perch the toes grasp the perch with a very powerful grip.

modifications of the feathers

whose wing feathers are highly developed are the birds of paradise; among those which have a highly modified tail are the peafowls, lyre birds, pheasants, and turkeys.

The *colors* of birds are in part due to pigment; such colors appear the same when seen under any condition. Other colors are produced by a combination of pigment colors with interference colors resulting from reflection and refraction of light, caused in part by ridges and furrows on the surface of the feather and in part by the internal feather structure. These colors are metallic and changeable.

Birds' feathers are shed and replaced at intervals, the process being known as *molting*. Some birds molt but once each year—early in the fall—while others also undergo a partial or complete molt in the spring. The spring molt is usually accompanied by the development of a highly colored breeding plumage. Some changes in the color of birds are due not to molting but to the wearing off of the feather tips, which are of a different color from the rest of the feathers.

431. Songs.—At the lower end of the trachea, or windpipe, where it branches into the two bronchi leading to the lungs, birds possess an organ known as a *syrix*, which is the organ of voice. Both the trachea and the bronchi are held open by cartilaginous rings. In the syrix these rings are variously modified and give attachment to stretched membranes the vibration of which produces tones.

432. Migration of Birds.—Among the most remarkable of the phenomena connected with bird life is migration. Many animals migrate but none to such distances and with such regularity as the birds. Their power of flight makes it possible for them to cover great distances in relatively short periods of time and their highly developed cerebellum, combined with their dependence upon flight, has endowed them with an ability to find their way which exceeds that possessed by any other animal and is difficult for man to comprehend. Not all birds migrate, and every gradation may be found between those which do not and those which cover thousands of miles in their migrations.

The greatest migration recorded for birds is that of the Arctic tern. Since the breeding range of the Arctic tern extends south to Labrador not all of the individuals of this species make a journey of the maximum length, but those do which nest far north on the shores of the Arctic Ocean, in a region of permanent ice and snow. As soon as the young of these birds are able to fly they start upon their southward journey, and moving at the rate of about 150 miles a day they cover in ten weeks a distance of over 10,000 miles. After spending the southern summer in the Antarctic, far removed from the northern winter, they return again through the same distance to spend the northern summer at their breeding grounds in the Arctic. Like all birds they nest in only one region and have only one breeding season. As a result of their migra-

tions, Arctic terns cover annually a distance of more than 20,000 miles. Another bird which takes a long journey is the golden plover, which nests in the barren grounds of the northern part of British America and winters in southern Brazil and Argentina. Its journey involves a round trip of more than 16,000 miles. This trip is taken also by a few other shore birds.

How birds find their way has never been satisfactorily determined. This faculty seems to rest upon a very accurate sense of location which enables them to fly practically in a straight line from one point to another, even though darkness or fog may hide any features that would guide them.

433. Reproduction.—Birds may mate either for the rearing of a single brood or for life. The nesting locality seems to be in most cases chosen by the male, though it is the female which determines the precise location of the nest. One or both members of a pair take part in its construction, which varies greatly among different types of birds. Some birds make no nest at all but lay their eggs directly upon the ground. Others make crude nests by scratching out hollows and then utilizing a few pebbles, twigs, or bits of grass. At the other extreme in nest building are the beautifully woven pendant nests of orioles, especially of certain tropical ones, which in many cases are several feet in length. Some birds do not rear their own young but deposit their eggs in the nests of others who become foster parents. This is true of the European cuckoo and of some American cowbirds. In these species mating of one bird with a single one of the opposite sex does not take place, for each female mates with many males, a phenomenon known as *polyandry*. On the other hand, as in the case of ostriches and of some fowls, one male may mate with several females, and this is known as *polygamy*.

Birds' eggs vary greatly in size, color, and number. The size of the egg bears a general relationship to the size of the bird, while the number is greatest in those birds whose nests are most exposed to destruction. The color of eggs is related somewhat to the place where they are laid. Those laid in cavities are usually white, or white with reddish spots; those upon the ground are usually streaked or mottled in such a way as to resemble the surroundings; and those in nests in trees and bushes are frequently blue or bluish white with markings of various patterns.

The *time of incubation* varies somewhat with the size of the bird, the cowbird having an incubation period of only about ten days; the ordinary song bird, about two weeks; fowls, three weeks; ducks, geese, and swans, from three to five weeks; the ostriches, from seven to eight and a half weeks; and the Australian emu, ten or eleven weeks. Usually the duty of incubation is assumed mainly by the female, and in other cases the two share in it. In a few instances, however, the male does all of the incubating. The last is true in the case of the American ostrich

and also in the case of a small sandpiper-like bird known as the phalarope. The female of the African ostrich participates very little in incubation.

Two types of young birds are recognized, depending upon the degree of development at the time of hatching. Some are known as *precocial* and form a group called *nidifugae* (nest-fleeing). They are covered with down at the time of hatching, have their eyes open, and run or swim as soon as their plumage is dried. Examples of this type of bird are the fowls, ducks, geese, and water birds generally. An extreme case is that of the brush turkeys of Australia and the East Indies. Neither parent incubates; the eggs are hatched by the heat of the sun, and when the young birds leave the eggs they are in full plumage and able to take care of themselves. Others are known as *altricial* and form the group *nidicolae* (nest-living). The young of these birds are naked and blind at birth and gradually acquire the down plumage, which is later replaced by a normal plumage before they are able to leave the nest. Our ordinary song birds all belong to this group.

434. Economic Importance.—Birds are economically of great importance because of their use in various ways and also because of the service they render as destroyers of injurious animals, particularly insects.

Both the flesh of birds and their eggs are used as food. The feathers of many species serve for adornment in a variety of ways and are also used in the manufacture of down quilts and pillows. On islands off the coast of Chile, where little rain falls and which are resorted to by sea birds for breeding, the feces accumulate in enormous quantities. These deposits, known as *guano*, are used as a source of fertilizers.

There are now large accumulations of data showing the great value of birds as insect destroyers or as destroyers of other injurious animals. Many hawks, owls, and other birds of prey, which are killed because of their occasional depredations in the poultry yard and their attacks upon game birds, should be considered beneficial because of the number of field mice, ground squirrels, and other injurious mammals which they destroy. It may be urged against birds that they destroy beneficial insects as well as injurious ones, so in the case of every bird it becomes a matter of striking a balance between the injuries done and the good accomplished. However, when such balance sheets are made up for birds, cases are very rare indeed in which a credit is not shown in favor of the bird.

The problem of bird protection resolves itself into a matter of the destruction of the very few relatively injurious types; the strict conservation of all which are of value for their service in the destruction of insect pests; and the restriction of the killing of game birds to such a degree as to permit the greatest number of persons to profit by hunting and at the same time prevent the destruction of the stock upon which the existence of future generations depends.

Several birds have been domesticated by man, some for many centuries. The very numerous cultivated varieties of the common domestic fowl were all probably derived from a jungle fowl of India. The domesticated pigeons are descended from a wild blue rock pigeon ranging from Europe to Central Asia, and here again a great variety of cultivated types have been developed. There are also to be included among domesticated birds the geese; ducks, most of which have come from the wild mallard; turkeys, which were natives of North America; and peafowls, which originally were found in Oriental countries. Many birds have been cultivated for their ability as singers, a conspicuous example being the canary; and others, such as parrots, parrakeets, and love birds, for their plumage.

CHAPTER LIX

CLASS MAMMALIA

The last and highest class of vertebrates is Mammalia. The mammals present without any question the dominant forms of animal life on the earth today, being supreme over land and sea. Not even man, however, has yet successfully questioned the dominance of birds in the air. Few people are familiar with the term mammals, some using the term animals in the same sense and others the word beasts.

435. External Characteristics.—Mammals are distinguished by the possession of hair, in connection with which they have developed sebaceous, or oil, glands. They also possess sweat glands and mammary glands and in some cases scent glands. Lips and cheeks are found in all except the whales, and there is a fleshy and cartilaginous lobe about the external opening of the ear known as a *pinna* (Fig. 221). The eyes are protected by lids, the upper of which is the movable one, in contrast with the birds, in which the lower lid is movable. The facial portion of the skull usually projects to form a muzzle, or snout. Typically, mammals possess four feet with five toes on each foot. Both the feet and toes are modified in a variety of ways.

436. Hair.—Hairs are lifeless epidermal structures arising from a living bulb which incloses a dermal pulp (Fig. 212). Since their development is initiated by an outgrowing of the dermis, hairs are not strictly homologous with the feathers and scales of birds and reptiles. The latter originate in a thickening of the epidermis. Sometimes hairs are replaced by overlapping dermal scales, while in the case of the armadillo the body is invested by an armor or carapace of bony dermal plates. On some aquatic mammals the hair covering is reduced to a few bristle-like hairs on the upper lip.

437. Internal Structure.—The skulls of mammals (Fig. 277) are compact and have fewer bones than those of the reptiles, although the various parts are not fused so completely as in the birds. Of the bones which in reptiles made up the lower jaw, part have united to form a single bone which articulates directly with the skull, and others have passed into the service of the ear (page 410). The lower jaws of the two sides are sometimes fused to form one mandible. Cartilaginous discs separate the bodies of the successive vertebrae. The ribs articulate both with the vertebrae and with the sternum and thus the expansion and contraction of the thoracic cavity are made possible.

The teeth of mammals generally are represented by two sets, a milk dentition and a permanent dentition. The teeth are set in sockets in the jaws and are generally differentiated into several types, known as *incisors*, *canines*, and *molars*. The character of the dentition shows a specialization corresponding to the character of the food and the

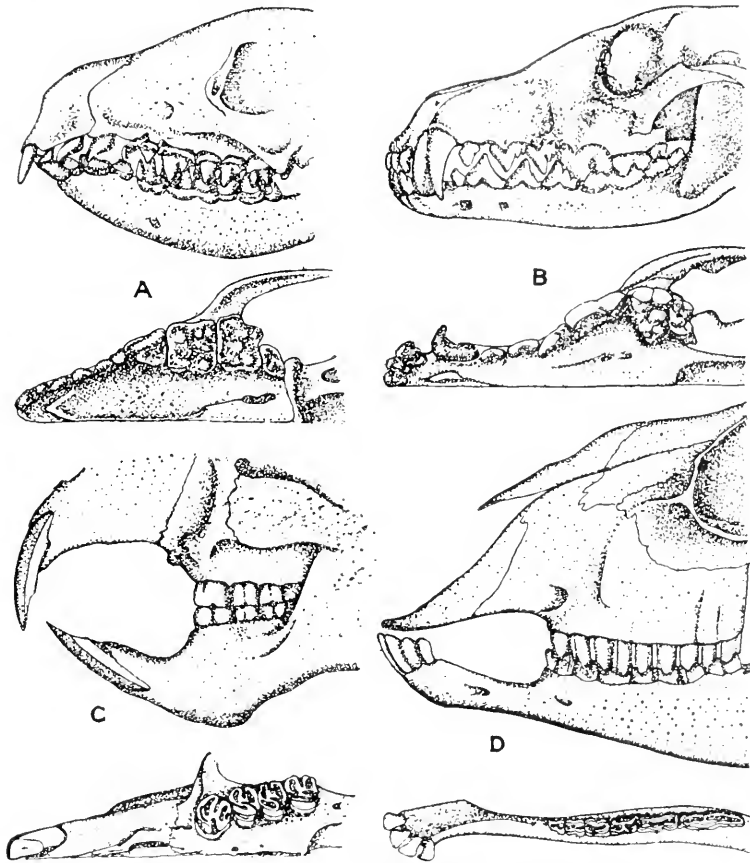

FIG. 277.—Types of mammalian skulls, showing character of dentition. From specimens. In each case the anterior part of the skull is shown from the side and one-half of the same part from below, with the lower jaw removed. *A*, European hedgehog, an insectivore. $\times 2_3$. *B*, coyote, or prairie wolf, a carnivore. $\times 1_3$. *C*, beaver, a rodent. $\times 2_3$. *D*, sheep, an ungulate. $\times 1_3$.

manner of securing it. Each tooth consists largely of *dentine* (Fig. 278), which is bony in character and derived from the dermis. The dentine is covered over the crown with a layer of *enamel*, which is derived from certain epithelial cells, and around the root by *cementum*, deposited by the dermis after the dentine has been formed. In the center of the tooth is a *pulp cavity* of soft connective tissue provided with blood vessels and nerves.

The alimentary canal shows several distinguishing characteristics. The mouth cavity is separated from the nasal chambers by a *hard palate*, which is a shelf of bone covered by soft tissues (Fig. 219). This is supplemented posteriorly by a fleshy *soft palate*. The passage from the mouth into the pharynx is known as the *fauces*, on each side of which lie the *tonsils*. The latter are masses of lymphoid tissue and their significance is not definitely known. The opening from the pharynx

into the windpipe is the *glottis*. It is protected from the entrance of food during swallowing by a fleshy and cartilaginous cover called the *epiglottis*. At the junction of the small and large intestines the latter is prolonged into a blind sac called the *caecum*, which is enlarged in herbivorous mammals, where its purpose seems to be to increase the capacity of the intestine. The contracted tip of this caecum is known in certain mammals, including man, as the *vermiform appendix*. Excepting in the egg-laying monotremes, there is no cloaca, the anal opening being at the surface of the body.

The lungs are contained in coelomic spaces called pleural cavities, which are the lateral portions of the thoracic cavity, the middle part of which is the pericardial cavity. The thoracic cavity is separated from the abdominal cavity by a thin, muscular *diaphragm*, which is convex anteriorly and concave posteriorly. The thoracic

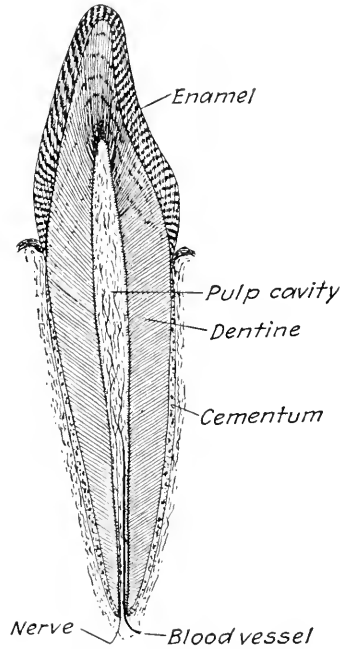

FIG. 278.—Canine tooth of a mammal, diagrammatic.

cavity is expanded in breathing by raising the ribs and flattening the diaphragm. Thus air is drawn into the lungs. By the relaxation of the muscles of the ribs and diaphragm and the resulting contraction of the thoracic cavity, air is forced out. At the upper end of the windpipe, or trachea, lies a *larynx*, or voice box.

Mammals are warm-blooded animals possessing a well-developed heat-regulatory mechanism. The heart is four-chambered and the systemic and pulmonary circulations are entirely separate (Fig. 279). There is a single aortic arch which turns to the left. A hepatic-portal system is present but there is no renal-portal system.

The brain of mammals (Fig. 280) shows a high development of the cerebrum and cerebellum, the latter always being convoluted but the former showing convolutions only in the higher forms. The size of the cerebellum of mammals is equal to that of birds, while the cerebrum far

exceeds in its development that of any other vertebrate type. The olfactory lobes are well-developed and each of the two optic lobes is divided, making four altogether.

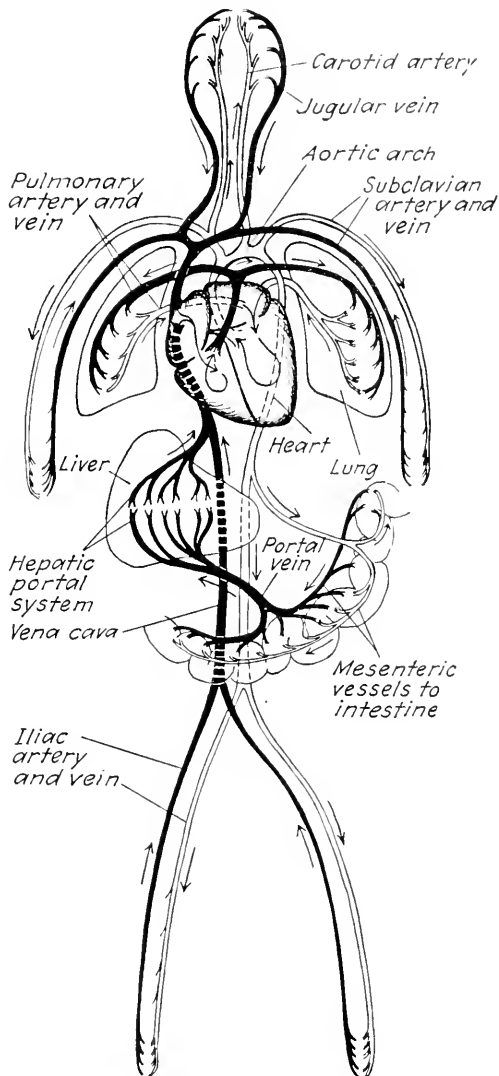

FIG. 279.—Diagram of mammalian circulation. Vessels carrying venous blood, black; arterial blood, white.

The eye is without a pecten, which was present in birds, and the nictitating membrane is reduced in size, varying in its degree of development among the different groups. A spiral coiling of the cochlea and the possession of a chain of three bones in the middle ear, together with

the pinna, characterize the ear of the mammals (Fig. 221). These bones are the *malleus*, *incus*, and *stapes*. Of these the malleus corresponds to the articular bone in the lower jaw of reptiles and birds and the incus to the quadrate, the stapes having been present from the amphibians onward. The sense of hearing is very acute. Mammals possess a

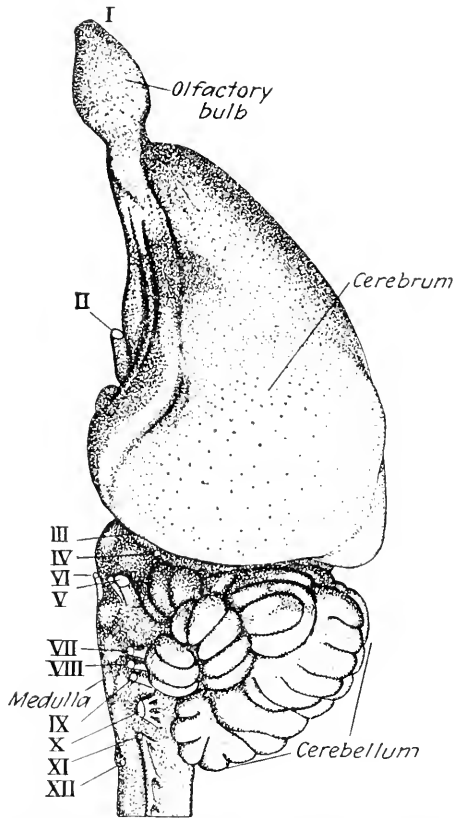

FIG. 280.—Brain of European rabbit, *Lepus cuniculus* Linnaeus, seen from the side. (From a Ziegler model, after Wiedersheim.) The roots of the cranial nerves are marked by roman numerals.

highly developed sense of smell, the sensory olfactory membrane being spread over the upper and lateral walls of the nasal chambers. The sense of taste is also well-developed, taste buds being collected in certain areas on the tongue.

438. Classification.—Mammalia may be subdivided as follows:

CLASS MAMMALIA

Subclass I. **Prototheria** (prō tō thē'rī ā; G., *protos*, first, and *therion*, mammal).—

Egg-laying mammals.

Order 1. Monotremata.

Subclass II. Eutheria (ū thē' rī ā; G., *eu*, true, and *therion*, mammal).—Viviparous forms, including all the rest of the mammals.

DIVISION I. DIDELPHIA (dī dēl' fī ā; G., *dis*, double, and *delphys*, uterus).—Form no true placenta and carry the young in a pouch.

Order 2. Marsupialia.

DIVISION II. MONDELPHIA (mōn ō dēl' fī ā; G., *monos*, single, and *delphys*, uterus).—Placental mammals, which form a true placenta by means of which the young are nourished and which never carry the young in a pouch.

Section I. Unguiculata (ūn gwīk ū lā' tā; L., *unguiculatus*, provided with claws).—Clawed mammals.

Orders 3 to 10. Include Insectivora, Chiroptera, Carnivora, Rodentia, and Edentata.

Section II. Primates (as a zoological group name, pī mā' tēz; L., *primatis*, one of the first in rank).—Contains mammals with nails on the fingers and toes.

Order 11. Primates.

Section III. Ungulata (ūn gū lā' tā; L., *ungulatus*, provided with hoofs).—Hoofed mammals.

Orders 12 to 16. Include, besides the typical hoofed forms, the Sirenia.

Section IV. Cetacea (sē tā' shē ā; G., *ctos*, whale).—Mammals without limbs.

Orders 17 to 18. Include whales and other similar types.

In this arrangement those mammals which are most primitive are placed first and those which are most highly modified last. This brings the primates and man in the middle of the series since they are neither the most primitive nor the most highly modified.

439. Origin of Mammals.—There are many resemblances between mammals and certain primitive reptiles known as cynodonts, the fossil remains of which have been found in South Africa. These resemblances point so clearly to relationship between the two groups that the cynodonts are now generally considered the ancestors of the mammals.

440. Monotremes.—The Monotremata (mōn ō trēm' ā tā; G., *monos*, single, and *trema*, hole) are found in Australia, New Guinea, and Tasmania. They are mammals which lay eggs resembling the eggs of reptiles and birds in being abundantly supplied with yolk and albumen and covered by a shell. Monotremes also resemble those animals in having a cloaca. In the case of the duckbills (Fig. 281) the egg is deposited in a nest constructed at the end of a subterranean tunnel in the bank of a river, the nest being above the water level and the outer end of the tunnel opening under the water. The egg is not incubated but it soon hatches and the young is fed from milk produced by milk glands. However, there are no teats, the milk being passed into two grooves on the ventral side of the mother's body. In nursing, the mother lies upon her back and the young animal laps the milk from the milk grooves. The Australian anteater, *Echidna*, possesses a temporary pouch in which the eggs are incubated.

441. Marsupials.—In the case of the Marsupialia (mār sū pī ā' lī ā; G., *marsypion*, pouch) the egg has a thin membrane and only a little

albumen. It is retained in the uterus, the young being nourished through the embryonic membranes, which are in contact with the uterine wall. Rarely a primitive allantoic placenta is developed. The young is born in an exceedingly immature condition and makes its way or is transferred by the mother to a brood pouch, or *marsupium*, on the ventral surface of her abdomen. Here it attaches itself to a teat, remaining so attached until it has become sufficiently developed to move about and resume its attachment when it wishes to feed.

The marsupials were distributed ages ago over both Europe and North America but now they are confined to Australia and neighboring islands, South America, and the southern portion of North America. In Australia, where they are the only native mammals, the marsupials

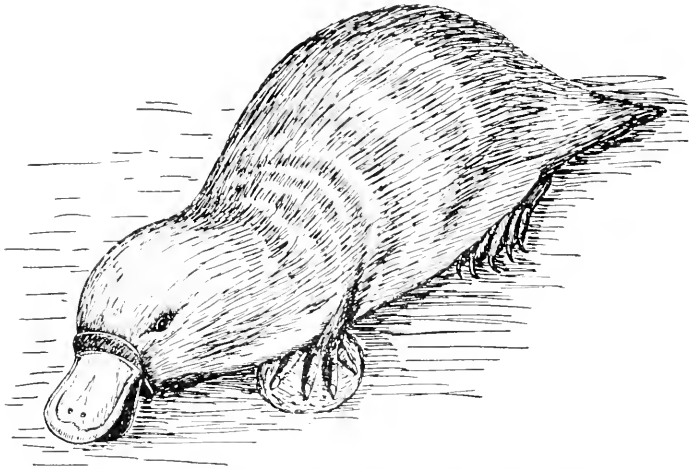

FIG. 281.—The Australian duckbill, *Ornithorhynchus anatinus* (Shaw). (Drawn from Lydekker, "Wild Life of the World," vol. II.) $\times 16$.

have adapted themselves to various modes of living, some of them having become carnivorous, and others molelike, shrewlike, or rodent-like. The phalangers are flying marsupials similar to the flying squirrels. The kangaroo has very large hind legs and a large tail, the former being used for leaping while the small forelegs serve merely for grasping food and handling the young (Fig. 282).

442. Unguiculata.—Insectivora (in sĕk tĭv' ō rā; L., *insectum*, insect, and *vorare*, to devour) includes the hedgehogs, moles, and shrews. They are probably the most primitive of placental mammals and are found everywhere except in Australia and a large part of South America. They are all insect eaters and are, generally speaking, beneficial.

The order Chiroptera (kĭ rŏp' tēr ā; G., *cheiros*, hand, and *pteron*, wing) includes the bats. These are the only true flying mammals, the wings being formed by membranes stretched between the greatly elon-

gated digits of the forelimbs and between those and the hind limbs and tail. They do not use their wings as gliding planes as do other flying mammals but fly with them in somewhat the same manner as do birds, though the flight of the bat is weaker and less direct. Bats are largely insectivorous and nocturnal in habits and are very widely distributed.

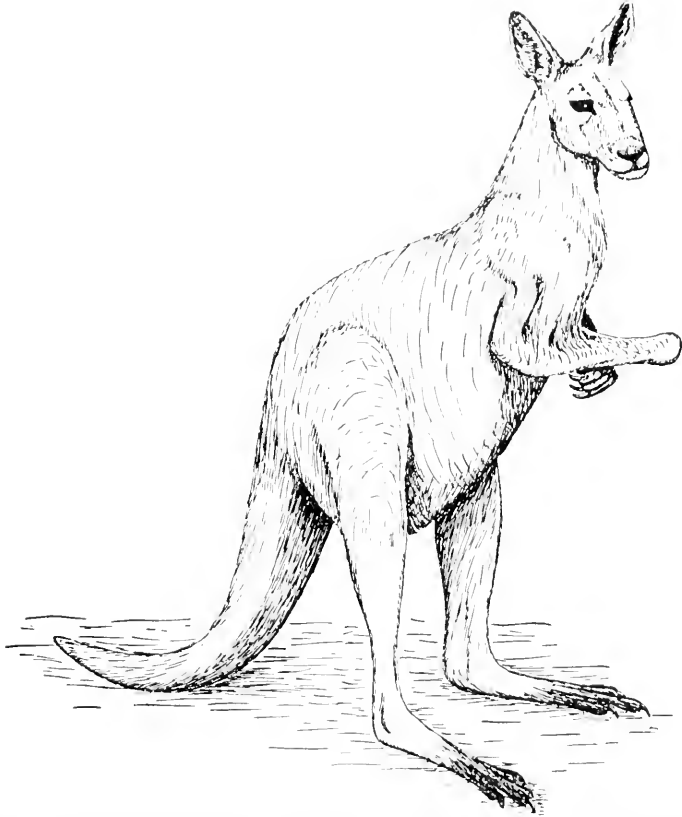

FIG. 282.—An Australian marsupial, the red kangaroo. *Macropus rufus* (Desmarest). (Drawn from Lydekker, "Wild Life of the World," vol. II.) Attains a total length of 9 feet.

Carnivora (kär nīv' ō rā; L., *carnivorus*, flesh-eating) are flesh-eating mammals characterized generally by their large size and predatory habits and by the fact that their incisor teeth are small while the canines are highly developed and the molars are of a cutting type. This order is divided into two great suborders. The first, Fissipedia (fīs ĭ pē' dī à; L., *fissus*, cleft, and *pedis*, foot), is made up of the terrestrial carnivores, whose feet are divided into toes armed with well-developed, curved claws (Fig. 283), and includes the cats, hyenas, dogs, wolves, foxes, raccoons, badgers, weasels, minks, skunks, otters, and bears. A large

number of these are valuable for their fur. The second suborder, Pinnipedia (pīn ĩ pē' dī ā; L., *pīnna*, feather, and *pedis*, foot), is made up of marine mammals in which both the fore- and hind limbs are modified to form finlike flippers. It includes such gregarious forms as the seals, walruses, and sea lions, which are often found collected in rookeries on

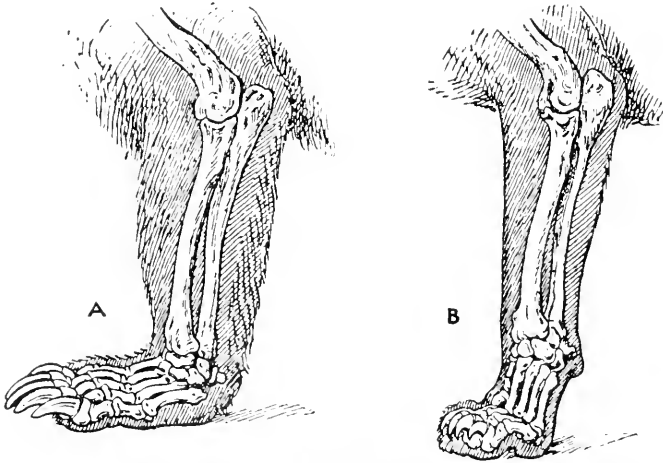

FIG. 283.—Feet of carnivores. A, plantigrade foot (foreleg) of a bear. B, digitigrade foot (foreleg) of a cat. (From Schmeil, "Text-book of Zoology," by the courtesy of A. and C. Black, and of Quette and Meyer.)

islands, particularly in the Arctic regions. The fur seal is very important commercially.

The order Rodentia (rō dēn' shī ā; L., *rodentis*, gnawing) contains mostly small animals characterized by the absence of canine teeth and

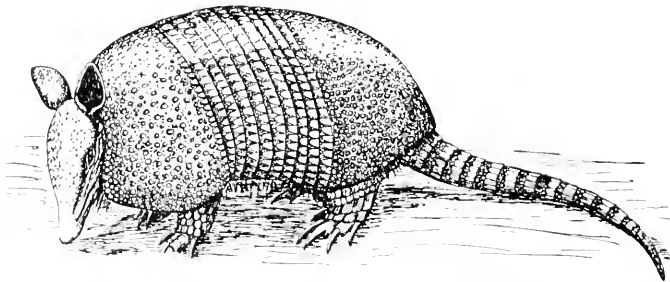

FIG. 284.—Nine-banded armadillo, *Dasypus novemcinctus* Linnaeus, found from Texas and southern New Mexico to Argentina. From a mounted specimen. $\times \frac{1}{5}$.

the great development of the incisors, which are used in gnawing. The incisors continue to grow throughout life and the wearing away of the soft dentine behind leaves the hard enamel at the front of the tooth constantly extended beyond the rest as a sharp, cutting edge. This order includes the hares, rabbits, squirrels, rats, mice, porcupines, and

beavers; it is very rich in species, these numbering about one-third of all of the species of mammals.

Edentata (*ē dĕn tā' tā*; L., *edentatus*, rendered toothless) includes the highly modified and decidedly archaic sloths, armadillos, and ant bears. They are found mostly in South America, although some species occur as far north as Texas. Ants form a large part of their diet. In spite of the name Edentata, ant bears alone are toothless; the others possess teeth, but these lack enamel and are absent in the front part of the jaws. The sloths are interesting because they are distinctly arboreal animals, having a habit of hanging from the underside of branches and following them in this position in locomotion. The arma-

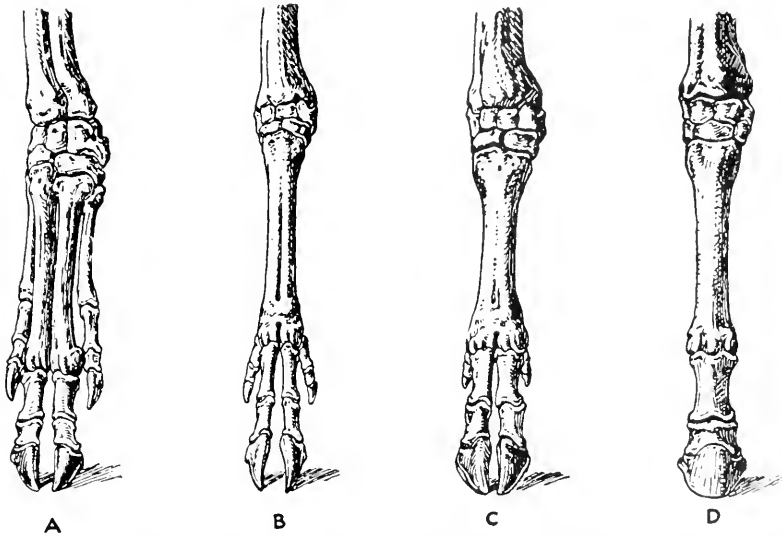

FIG. 285.—Bones of the foot in even- and odd-toed ungulates. A, pig; B, deer; C, ox; D, horse. (From Schmil, "Text-book of Zoology," by the courtesy of A. and C. Black, and of Quelle and Meyer.)

dillos (Fig. 284) have a well-developed dermal skeleton consisting of bony plates covered with horny scales in which hairs are embedded. When danger threatens, the animal curls itself up in its shell and thus protects itself.

443. Primates.—The lemurs, monkeys, apes, and man are primates. Of these the lemurs are the most primitive and least manlike, having many resemblances to the clawed mammals. In appearance they seem to be intermediate between squirrels and monkeys. They are found mostly in Madagascar but also in Africa and the Malay Archipelago. The monkeys are divided into two types. The New World monkeys are distinguished by a broad nasal septum, a small nonopposable thumb, and a long prehensile tail, which is used like a fifth hand. The Old World monkeys, on the other hand, have a narrow nasal septum with

the nostrils directed downward, an opposable thumb and great toe, and a shorter tail, which is nonprehensile and in many cases rudimentary. Among the Old World monkeys are the baboons, mandrills, macaques, and anthropoid apes. Man is most closely related to the last-named.

444. Ungulata.—The Artiodactyla (är tī ō dāk' tī lá; G., *artios*, even, and *dactylos*, digit), or even-toed ungulates (Fig. 285), include the swine, hippopotamuses, camels, deer, antelopes, cattle, sheep, and goats. They are animals with a hoof on each toe and are mostly two-toed, although the hippopotamus has four toes. Many of these ungulates are mud-loving and are restricted to the vicinity of water, while others, like the camel, are adapted to desert life. The latter adaptation involves particularly two features—the possession of cells connected with the stomach in which they carry a reserve water supply, thus

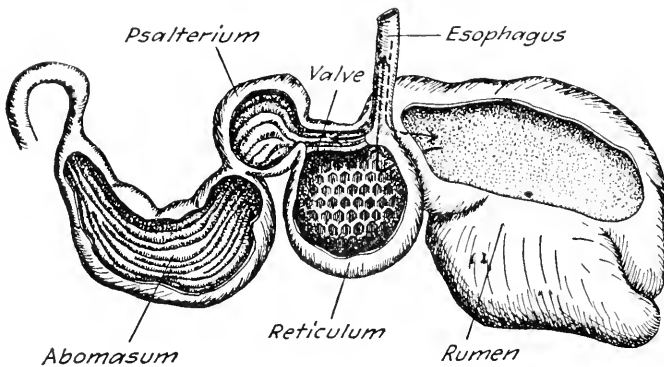

FIG. 286.—A ruminant stomach. The arrows show the direction of movement of the food. The balls of cud pass down the esophagus and into the rumen; then into the reticulum and back to the mouth; on the second swallowing the food enters a small passage in the upper part of the reticulum formed by the apposition of folds, or valves, and is directed into the psalterium. From several sources.

enabling them to go for long periods of time without needing to secure more; and the presence of fatty humps containing a store of food which may be drawn upon when they are forced to fast. Some of the ungulates have the stomach divided into chambers and the cattle, which are ruminants and chew their cud, have four chambers, known as *rumen*, *reticulum*, *psalterium*, or omasum, and *abomasum* (Fig. 286). The food when eaten is swallowed in the form of balls, which are accumulated in the rumen. Later, one by one, these are brought back into the mouth, thoroughly masticated, and swallowed again, passing into the reticulum and on through the other chambers, being digested in the meantime.

The odd-toed ungulates, or Perissodactyla (pě rīs ō dāk' tī lá; G., *perissos*, odd, and *dactylos*, digit), include those forms in which the middle digit of both the fore- and hind limbs is highly developed and carries most of the weight (Fig. 285). Aside from the horses the order includes tapirs and rhinoceroses.

Proboscidea (prō bō sīd' ē ā; G., *pro*, in front, and *boskein*, to feed) contains the elephants, which are the largest terrestrial mammals and which live to a great age, sometimes as much as two hundred years. The order Sirenia (sī rē' nī ā; G., *seiren*, a sea nymph) includes the manatees and dugongs, which are aquatic and herbivorous animals with several characteristics betraying a relationship to the elephants. The manatees are found in the fresh waters along the coasts of southern North America, northern South America, and Africa; the dugongs inhabit Oriental and Australian waters.

445. Cetacea.—In this section are the whalebone whales, sperm whales, porpoises, and dolphins. They have a single or double nostril in the median line at the end of the snout and when they rise to the surface expire forcibly, throwing a great column of water into the air, an act called “blowing.” They have to come frequently to the surface for the purpose of obtaining air and each time they come they “blow.” Among the whales are the largest animals that have ever lived, reaching a maximum length of 85 feet. The teeth of the whalebone whales are rudimentary and functionless and are replaced by whalebone, or *baleen*. Whalebone is a horny material developed from the epidermal lining of the mouth, which is arranged as a series of curtain-like plates to form a sieve. These whales feed on relatively small animals which occur in large numbers and which they strain from the water with this sieve.

446. Hibernation.—Hibernation has previously been noted as an adaptation to terrestrial life and was briefly discussed in connection with Amphibia (Sec. 403). Among the reptiles, turtles bury themselves during winter in the mud of the shores and bottoms of the bodies of water in which they live, and lizards and snakes hide in crevices in rock ledges or crawl into holes in the ground. No birds hibernate. While many mammals remain active in the winter, protected by their heat-conserving covering of fur and subcutaneous fat and find a sufficient supply of food to meet their needs, others hibernate during all or a part of that season.

In preparation for hibernation a mammal becomes very fat, storing up a supply of heat-producing food. During true hibernation the temperature of the animal falls, frequently to within a few degrees of freezing; respiration becomes very slow and shallow; the heart beats slowly, and the circulation is sluggish; in fact all metabolism is carried on at a very slow rate, and the temperature-regulating mechanism is temporarily suspended. In other words the organism becomes for the time cold-blooded. The muscles are rigid and the animal is unconscious. The mammals of this country that undergo true hibernation include jumping mice and pocket mice, the woodchuck, or ground hog, ground squirrels, and some of the bats.

Some mammals, such as the skunks, badgers, and raccoons, do not undergo a true hibernation but only spend the time in their winter

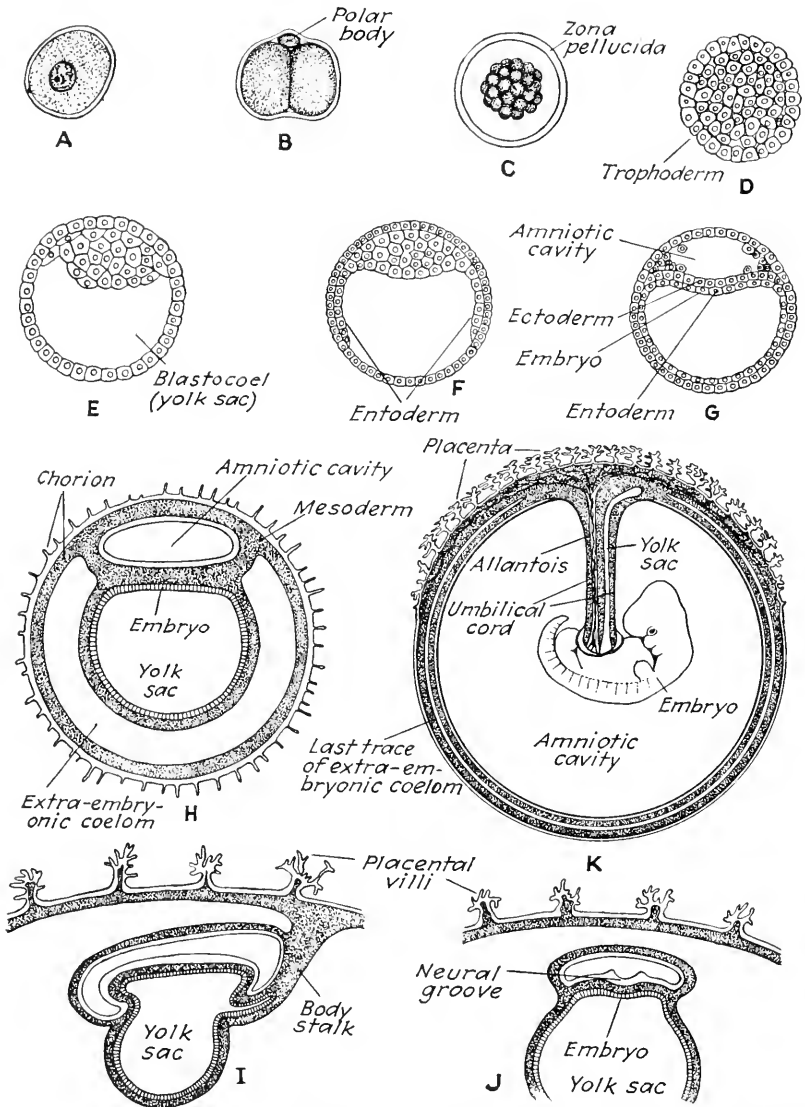

FIG. 287.—Diagrammatic representation of the stages in mammalian development. A, egg cell, in section. B, two-celled stage. C, morula. D, section of morula. E, blastula, in section. F, development of entoderm. G, formation of amniotic cavity, and separation of embryonic disc into entoderm and ectoderm. H, development of mesoderm and extra-embryonic coelom. I, formation of body stalk and beginning of placenta. J, cross section of same stage as I. K, embryo in amniotic cavity, the increase of size of which is about to obliterate the extra-embryonic coelom. In H to K, ectoderm is white, entoderm crosslined, and mesoderm stippled.

quarters in prolonged and profound sleep. Still others carry on various activities during that time. It is while in their winter dens that female bears bring forth their very small and partially developed young.

447. Reproduction.—In all mammals fertilization is internal, the sperm cells being introduced into the oviduct by copulation. The egg cell of the mammal is small and possesses only a limited amount of yolk. The development of the monotremes is essentially like that of reptiles and birds. The mammals of the next group, the marsupials, retain the embryo for a certain period of time within the uterus, though it does not become attached by a placenta such as is found in all higher mammals.

Cleavage is apparently total and approximately equal. The egg cell thus appears to be holoblastic although there are details in the development which seem to indicate that it has been modified from a meroblastic type. The egg cell divides first into two and then into four cells, equal in size and normally arranged (Fig. 287). As cleavage continues, however, the cells shift about and finally a structure is formed which consists of an outer layer of cells, called the *trophoderm*, and an *inner cell mass*. Gradually the trophoderm and the inner cell mass become separated by a cavity filled with fluid and corresponding to a blastula cavity, but the two remain in contact at one pole of the vesicle. The trophoderm becomes attached to the wall of the uterine cavity and from it finger-like projections or papillae grow into the uterine mucosa; these serve to anchor it firmly to the wall of the uterus.

From the inner cell mass is developed not only the entire embryo but also the amnion, chorion, allantois, and yolk sac. In what may be called a typical mammalian embryogeny the inner cell mass becomes separated into two portions. In the upper portion develops an amniotic cavity, while in the lower portion is formed an archenteron. The amniotic cavity is lined with ectoderm, the archenteron with entoderm, and from the cells between is formed the mesoderm. From the archenteron a *yolk sac* develops, which, however, does not contain yolk. Now the development of the embryo proceeds in much the same manner as in the development of a meroblastic egg cell. The entoderm together with the splanchnic mesoderm forms the wall of the yolk sac, which is connected with the enteron of the embryo by a slender *yolk stalk*. The ectoderm and somatic mesoderm grow around the wall of the blastodermic vesicle forming an *amnion*, which unites with the trophoderm to produce a *chorion*. The chorion of mammals is, therefore, not homologous with that of reptiles and birds (Sec. 409). Branching processes, larger and more complex than those which attached the trophoderm, extend from the chorion into the uterine tissues, which become thick and congested, the two masses together forming the *placenta*. Between the two layers of the mesoderm is the extra-embryonic coelom.

By the development of the amniotic cavity and the extra-embryonic coelom a considerable space is produced between the body of the embryo and the placenta, the two being connected only by a body stalk, which represents the original connection between the trophoderm and the inner cell mass. In some cases the *allantois* grows into this body stalk and assists in the formation of the placenta. Such a placenta, accordingly, is termed an allantoic placenta. If the allantois remains rudimentary and does not enter the placenta, the latter is called a chorionic

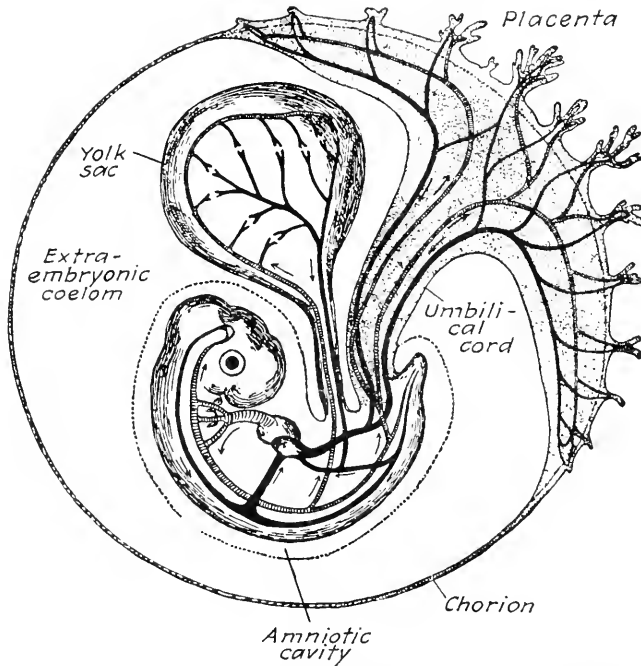

FIG. 288.—Diagram of the embryonic membranes and circulation of a mammal. Stage between *I* and *K* in Fig. 287. For comparison with Fig. 257. Arteries crosslined, veins black. Arrows show direction of blood flow. (From Wilder, "History of the Human Body," by the courtesy of Henry Holt & Company.)

placenta; in this case the mesodermal layer of the chorion becomes much thickened and very vascular. Whether the placenta is allantoic or chorionic the blood vessels of the mother come into intimate contact with those of the embryo, though the two sets of vessels never actually communicate. As a result of this condition a free interchange of substances in solution occurs. From the maternal blood oxygen and food are passed into the fetal circulation, while carbon dioxide and waste substances pass in the opposite direction. In the case of the human embryo and of other forms the amniotic cavity becomes very large, the extra-embryonic coelom becoming correspondingly reduced, or even eliminated, and the embryo comes to lie suspended in the amniotic cavity by the body stalk, which is called the *umbilical cord*. This amniotic

cavity is, of course, filled with amniotic fluid. When the young animal is born, the umbilical cord is either ruptured or is severed soon afterward. The placenta, which is called the afterbirth and often forms a mass of considerable size, is immediately passed out. Since in the birth of a human infant the umbilical cord is not ruptured, it has to be cut, the end attached to the infant being tied to prevent hemorrhage.

The process described above is subject to a variety of modifications in different groups of mammals. Sometimes the amnion is formed as a circular fold of ectoderm and mesoderm somewhat as in birds, the margins of the fold coming together to form the amniotic cavity. The placenta takes a variety of shapes in different mammalian types. Birth takes place in different groups with the young in various stages of development. In such animals as cattle and horses the young at birth are well-developed, have their eyes open, and are soon able to walk and run, needing the care of the mother only at the time of feeding. The young of various carnivores and rodents, however, are born naked, blind, and helpless and have to be cared for during a considerable period of time. The human child, while not blind at birth, is nevertheless quite helpless and demands parental care longer than the young of any other animal.

448. Economic Importance.—Mammals are economically important for many reasons. Among them are animals which for ages have served man for food, both their flesh and milk being used. Their hides have furnished leather and fur for the manufacture of clothing and for a variety of other purposes. Horses, asses, camels, cattle, and other mammals have been used as beasts of burden and have assisted man in his labor of cultivating the soil. Of all mammals perhaps the horse has played the largest part in the development of human civilization. Mammals have also been the pets and associates of man since early in his history. Many mammalian products have been important articles of commerce, including musk, which is the product of certain glands of ruminants; ivory, which is supplied mainly by the tusks of walrus and elephants; oil, which has been secured from the fat of sperm whales; and ambergris, a product of the intestinal canal of whales used as a base in the manufacture of fine perfumes. Formerly whalebone was an important article of commerce but its value has diminished in recent years.

Not only are many mammals valuable to man, but the group also includes some which are decidedly injurious. Among these are rodents, which destroy crops in the fields or commit ravages about houses and outbuildings. The rat is injurious not only for this reason but because it is also a carrier and distributor of the germs of disease. In some countries, particularly tropical ones, wild mammals are a menace to the lives of people, and everywhere carnivorous mammals are a constant threat to the safety of cattle and other domesticated animals.

CHAPTER LX

ANTHROPOID APES AND MAN

Excluding entirely from our estimate of man any thought of a spiritual nature or an ethical culture, he is physically an animal, although the mental development of civilized man (Fig. 289) so far exceeds that of any other animal as to make apparently a great gap between him and all animals below him. When one compares the higher apes, especially when they have been affected by human teaching, and the uncivilized human races, the gap does not appear so wide, although it still remains. However, the evidence furnished by geology as to the physical character and intellectual development of earlier races of mankind enables us to close the gap entirely. For this reason it is possible to discuss man and the higher apes in the same connection.

449. Manlike Apes.—The anthropoid apes include four genera represented by living species, these four containing respectively the gibbons, the orang-utans, the chimpanzees, and the gorillas. All these animals are tailless, all assume a semi-erect position, and all have opposable thumbs and great toes. With the exception of the gorilla they are pre-eminently arboreal. As compared with man the anthropoid apes have stronger jaws and teeth; they have a relatively low cranial capacity; the structure of the mouth is not such as to admit of articulate speech; the arms are long and, together with the scapulas, or shoulder blades, are developed in accordance with their use as organs of locomotion in trees; the feet as well as the hands are grasping appendages; and they cannot assume a fully erect posture.

When the different types are examined in detail they fall into a graded series, the gibbons being most strictly arboreal, the gorilla least so. It would appear that there has been a gradual tendency to change from an arboreal life to life on the ground.

A noteworthy characteristic of these apes is the specialization of the two pairs of limbs for entirely different modes of locomotion. The arms, adapted for grasping and for swinging from limb to limb, serve as locomotor organs in the trees, while the legs, though still showing some adjustment to tree life, as in the opposable character of the great toe, are more fitted for locomotion on the ground.

450. Erect Position.—In an animal going upon all fours the vertebral column forms an arch and the greatest degree of flexibility is at the base of the neck and at the base of the tail. With the assumption of the

erect position there come changes which are shown somewhat by the semi-erect apes but which are exhibited completely only by man. One of these changes is the appearance of curvatures in the spine needful in the balancing of the erect body. Thus the human spine comes to have a backward curvature in the thoracic and sacral regions and a forward curvature in the neck and lumbar regions. A second change is in the increasing development of the bodies of the vertebrae at the lower end of the trunk where the weight is transmitted to the legs.

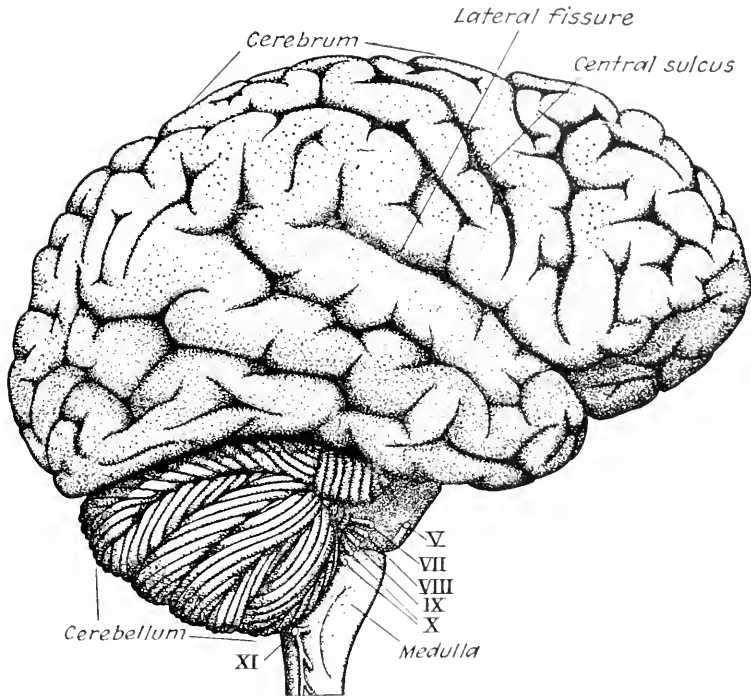

FIG. 289.—Human brain from the side. From a preserved specimen. The roots of the cranial nerves are indicated by roman numerals.

With the complete emancipation of the forelimbs from any part in locomotion and their specialization for other purposes, the pectoral girdle becomes lightened and less firmly connected to the axis of the body. On the other hand the pelvis remains strongly developed, is closely attached at right angles to the body axis, and is broadened for the support of the viscera. The leg bones also become straighter and the great toe ceases to be opposable. The foot becomes arched, which is an adaptation to permit it to take up the jar due to contact with the ground, which would otherwise be transmitted upward to the body.

451. Evidences in Man of Former Arboreal Life.—There are, however, still evidences in man of a former arboreal condition, these being

more evident in the child than in the adult. In the young child there are indications of opposability on the part of the great toe, and the position of the legs also reminds one of these appendages in the apes. Attention was called by Darwin to the grasping instinct of the child. Very young children show a tendency to grasp things in their hands and have a surprising strength in their arms, being able to support their weight by clinging to an object which they can grasp.

452. Intermediate Forms.—The remains of several primates have been found in Europe and Asia which seem to have characteristics of both man and apes but which are more clearly apelike. Evidences have recently been discovered in South Africa of an extinct type which also seems to be more apelike than manlike. In no case, however, are

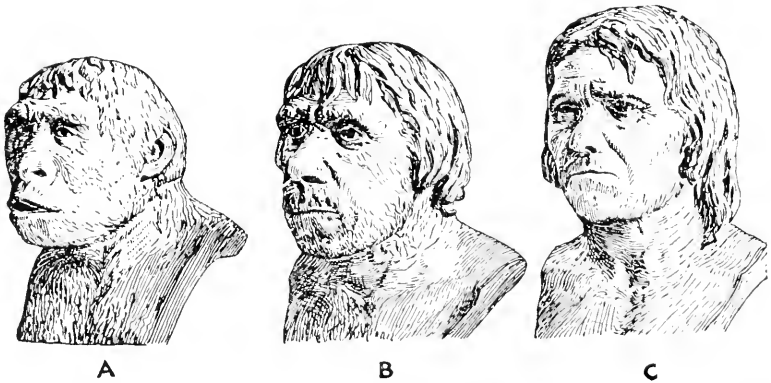

FIG. 290.—Races of men. A, the ape man, *Pithecanthropus*. B, the Neanderthal man. C, the Cro-Magnon man. (Pen sketches in *New York State Museum Handbook 9*, from original busts in the *American Museum of Natural History* by McGregor, by the courtesy of the *American Museum* and the *New York State Museum at Albany*.)

the parts of the body which have been found sufficient to justify a very accurate conception of the character of the animal of whose body they formed a part. Finally, in the island of Java parts of the skeleton of a prehistoric type have been found belonging to the genus *Pithecanthropus*, which has been called the Java ape man (Fig. 290A). This type is generally looked upon as being more like the apes than like man.

453. Fossil Men.—There are several extinct races whose fossilized bones seem clearly to indicate their human character and which, therefore, have all been placed in the genus *Homo*. The first of these is known as the Heidelberg man, since the bones were found near Heidelberg, Germany. In some ways the parts which have been found are quite different from those of modern man but the teeth are distinctly human. A second type is the Piltdown man, named for the locality in England near which the bones have been secured. This race combined both primitive and advanced characteristics. The jaw is apelike but the cranium is human in form, lacking the prominent ridges found on the

skull of the ape. With these remains have been found crudely shaped flints which indicate a primitive culture. A third primitive race has been found, known as the Neanderthal man (Fig. 290B). This race lived later than did the Piltdown man but in the character of the skull has a greater resemblance to the apes than has the latter. Also there is less curvature of the spine than in modern man, a fact which would seem to indicate a less erect position. The arms were powerful, the hands large, and the thigh bone was much curved. The Neanderthal man was a cave dweller and the bones of men of this race have been found in Europe accompanied by worked flints, bones of animals, and indications of the use of fire.

None of these races has been referred to the same species as modern man, *Homo sapiens* Linnaeus. The character of the skeletons of the Cro-Magnon race (Fig. 290C) has, however, led to its inclusion in this modern species, since physically and mentally it seems to have been the equal of primitive existing races of mankind. The Cro-Magnons, who probably lived in Europe not more than 20,000 years ago, are believed to have produced drawings and paintings now existing on the walls of European caverns. They worked flint and bone and seemed to have possessed weapons such as the spear and harpoon. The brain was large in comparison with the earlier races and compares favorably with that of modern man. The Cro-Magnons have been generally looked upon as the forerunners of the present human race.

454. Present-day Man.—Today man has spread throughout the world, having adjusted himself to practically every climatic condition. Three primary types have been generally distinguished: (1) The Negroid type is characterized by kinky hair; dark skin; a broad, flat nose; thick lips; prominent eyes; and large teeth. (2) The Mongolian type has coarse, straight hair; yellowish skin; a broad face with prominent cheek bones; a small nose; narrow, sunken eyes; and teeth of moderate size. (3) The Caucasian type has fine, soft, straight hair; light-colored skin; a well-developed beard; a prominent, narrow nose; small teeth; and is without prominent cheek bones.

The Negroid races are native in Africa, Australia, and the adjacent islands. The homes of the Mongolian races are in northern and central Asia. Northern and eastern Europe, the Arctic regions (the Eskimos), the East Indies (the Malays), many Pacific islands, and America (the American Indian). The original homes of the Caucasian races included southern and western Europe, northern Africa, and southern and southwestern Asia, but they have become the most widespread of all and are now distributed over most of the surface of the earth.

PART V
GENERAL CONSIDERATIONS

CHAPTER LXI

ANIMAL ORGANISMS

In the chapters which have preceded the phyla of the animal kingdom have been reviewed. In connection with some of these phyla general phenomena were described and certain principles presented. When the animal kingdom is viewed as a whole, however, many conceptions are at once suggested which are related to the more general divisions of zoology. In the chapters which follow these will be briefly discussed.

455. The Organism.—The word organism has been previously used but its meaning has nowhere been clearly stated. When reference is made to such a type as a colonial hydroid or a tapeworm (Fig. 78), and particularly to the Portuguese man-of-war (Fig. 64), the word animal is somewhat equivocal. What is apparently an animal is really an assemblage of many animals. Also during the regeneration of a fragment from which develops a complete organism it is a matter of opinion as to when the term animal should be first applied. Likewise, during the development of an egg cell it is a matter of judgment as to when the use of the word animal becomes proper. Since it is clear that the application of the word animal is attended with a considerable degree of uncertainty, it seems desirable to employ another term which may be so defined as to be capable of application to any living thing. No word seems more appropriate than organism.

456. Definition.—In the sense indicated above an *organism* may be defined as a mass of living matter capable of maintaining individual existence, and in which all parts contribute more or less to the activities of the whole. This definition covers the one-celled and many-celled animals, the colony, the regenerating fragment, and the individual animal in any stage of development from the egg to the adult. Referring to an organism as a mass of protoplasm need not cause confusion with the definition of a cell, for it should be remembered that if a cell carries on continued independent existence, it is also considered an organism. On the other hand a many-celled animal is a mass of protoplasm divided into cells. In the case of symbiotic forms, whether or not the term organism could be applied to the two taken together would depend upon the degree of cooperation. Thus the green hydra is an organism, though it is composed of an associated plant and animal. In the case of the white ant and a symbiotic protozoan which lives in its alimentary canal,

the degree of dependence of one upon the other is not sufficient to counter-balance the essential individuality of each and the two are considered as separate organisms.

457. Income and Outgo.—An organism is continually carrying on metabolic activity. When this reaches a low level and the animal is incapable of immediate action, it is said to be dormant; and when metabolism ceases entirely, death has occurred. It was pointed out long ago that life was essentially the result of combustion under complicated circumstances, and Mach has referred suggestively to a living organism as that which is able to “keep itself going, produce its own combustion temperature, bring neighboring bodies up to that temperature and thereby drag them into the process, assimilate and grow, expand and propagate itself.”

Metabolism involves the addition to the organism of matter and energy and also the giving off of both. The income and outgo of the organism may be expressed as follows:

Income.

1. Material income.
 - a. Food.
 - b. Oxygen.
2. Energy income.
 - a. Chemical energy, contained in the food.
 - b. Light energy, received naturally from the sun.
 - c. Heat energy, received from the sun and the earth

Outgo.

1. Material outgo.
 - a. Solid wastes, egested.
 - b. Liquid wastes, eliminated.
 - c. Gaseous wastes, expired.
2. Energy outgo.
 - a. Mechanical energy, evident in muscular activity.
 - b. Heat, produced as a result of chemical changes in the body.
 - c. A small amount of electrical energy, freed during these same changes.
 - d. A small amount of light in organisms which are luminescent

If the income exceeds the outgo, then the difference represents growth in substance and an increase of the potential energy contained in the body. If the reverse is true, both the size of the body and the energy contained in it diminish. Theoretically it should be possible, taking into account the condition of the organism at the beginning and end of a given period, to reach a perfect balance between income and outgo for that period. Some of the most recent and most successful experiments have approached such a balance within a fraction of one part in a thousand.

458. Differentiation.—It has been seen that *differentiation*, accompanied by *division of labor*, presents itself in organisms in several ways

(Secs. 111, 115, 116, 137, 175). One is the differentiation which exists within the individual cell; a second is that of cells in the many-celled organism, which results in the formation of tissues; a third is that of the individuals in a colonial organism, as in the Portuguese man-of-war. Division of labor may also appear in a society, as in social bees and ants, accompanied by polymorphism. Differentiation within individuals exists throughout the animal kingdom, but it is carried to the highest degree in the highest organisms.

459. Integration.—Parallel with differentiation occurs a process known as *integration*. Differentiation appears as the result of differences which develop in the parts of an organism. Integration is brought about by such an intimate coordination between these various parts as to result in unity of action and tends to increase the efficiency of the organism as a whole. Integration is shown in the association of tissues to form organs and of organs to form systems and in the coordination of all parts in the activities of the entire organism. Just as in the highest animals differentiation reaches its highest expression, so in the same animals integration is developed to the greatest degree. Two factors concerned in coordination are centralization in the nervous system and chemical control in other systems of the body.

460. Centralization.—Centralization, which involves the development of a central nervous system, has been traced through the different phyla and has been seen to culminate in the highly centralized nervous system of the vertebrates. In the higher organisms has been added *cephalization*, which is the setting apart of a head region containing the brain and many of the organs of special sense (Chap. XXXI and Secs. 264, 273, 280, 331, 335, 350).

461. Chemical Control.—The chemical control of one part of the body over another is exercised through the production of substances which may be included under the general term of hormones. A *hormone* may be defined as a substance of chemical nature produced in one part of the body which, when carried to another part, serves to stimulate it to activity. In this broad sense the term covers all internal secretions. The glands which produce these are often called the *endocrine glands*. The discovery of hormones is comparatively recent and our knowledge of them is far from complete. Nevertheless, certain facts may be definitely stated.

An example of a hormone is presented by the gastric *secretin*. The stomach is called into action by the stimulation of the vagus nerve. This effect soon wears off but the cells are caused to continue functioning by the gastric secretin which is formed by the cells themselves and passed into the blood. Similar substances are produced by the pancreas and liver. The ovary of a pregnant mammal produces a hormone which, carried through the blood to the mammary gland, stimulates the latter

and brings it into functional activity just at the time when the young animal requires food.

Not only are hormones agents by which coordination between different parts of the body may be secured and integration be brought about, but undoubtedly they are also active agents in differentiation. They stimulate the development of the characteristics which distinguish individuals, the result of their combined activities determining size and bodily configuration. Hormones produced in the sex organs stimulate the development of structures characteristic of either one sex or the other; those from the testis are active in the production in various parts of the body of characteristics that belong to the male; and those from the ovary, in the production of characteristics that belong to the female.

462. Individuality.—As a result of the processes associated with differentiation and integration organisms acquire the differences that characterize species, varieties, and races and also that which we call individuality, by which each individual is distinguished from others of its kind. It is probably true that no two individual organisms are ever precisely alike, though they may resemble each other very closely. This individuality is maintained throughout the life of the organism, even though in the process of metabolism the exact composition of the body is constantly changing. From this point of view an analogy has been drawn between an organism and a whirlpool in a stream. At no two successive moments of time is the whirlpool composed of the same material; water constantly enters it and constantly leaves, and yet the appearance of the whirlpool remains essentially the same. A living animal is continually taking in food and in that way bringing matter into its organization and also continually throwing off waste, yet it constantly maintains its individual character. It has been said that the body changes once in every seven years. This is a statement which is not exactly true, though it suggests a truth. Some materials in the body, such as bone, remain the same throughout all or a large part of the individual's life, while in other structures of the body, as in the cells of the skin, replacement is continually taking place.

463. Life Cycle in Birds and Mammals.—The life cycle of the highest vertebrates, including man, may be divided into three distinct periods, each of which is characterized by certain physical appearances and functional relationships. These three periods are adolescence, maturity, and senility (Sec. 69). The period of *adolescence* is the time during which the organism increases in size; metabolism is active and the chief energy of the body is directed toward the production of an organism with the adult stature, possessing the complete equipment of organs and endowed with the energy necessary to carry on life most effectively. In most cases the reproductive function does not become active until this period of the life cycle is well advanced. The period of *maturity*

is characterized by the maintenance of a generally uniform size, an approximate balance between income and outgo, and the regular carrying on of all activities, including reproduction. This period is usually not set off sharply from either of the two others. For a time in the early part of the period some growth still occurs, though it gradually ceases, and toward the end some wasting occurs, but it does not become prominent. In the period of *senility*, however, the katabolic processes exceed the anabolic, the body shrinks, the energy production falls, and the reproductive powers lessen or are lost altogether. These senescent changes appear gradually, become slowly accelerated, and culminate in the natural death of the organism.

Throughout the life cycle changes occur in the degree of activity of the various parts of the body which modify the factors concerned in the production of a balance exhibited by the body as a whole. Certain endocrine glands are active during youth. During maturity the activity of these glands gradually lessens and the hormones produced by them exert a lessened effect, while other glands reach full activity during this period. In the same way the period of senility shows a change in the relative activity of different parts of the body and in the hormone production of various organs. Thus the successive periods in the normal life cycle follow each other as the result of a perfectly natural succession of changes, and the body as a whole participates in them.

464. Other Life Cycles.—The life cycles of different types of animals vary greatly. Those of the malarial organism (Sec. 114), the sheep liver fluke (Sec. 200), the beef tapeworm (Sec. 201), several parasitic roundworms (Secs. 210 to 215), the fresh-water mussel (Sec. 255), the crayfish (Sec. 296), and the mosquito (Sec. 317) have been described at greater or less length, and certain aspects of the life cycle of many other forms have been mentioned. In protozoans there is a period of growth, but in many cases the cycle ends when full size is attained, the animal dividing by binary fission; under ideal conditions death does not occur. Many invertebrates, such as the insects, come to maturity, reproduce, and die. In other invertebrates and in many lower vertebrates growth never ceases but merely slows up as the animal ages; there is no period of senility. Generally speaking, few animals ever live to what could be called an advanced age, since as their powers diminish, those which have so far survived the struggle for existence fall prey to other more vigorous animals. The fierceness of the struggle for existence stands as a constant threat to the completion of a normal life cycle.

465. Practical Considerations.—Certain practical considerations applicable to man appear as a result of the study of the life cycle. Adolescence is a period of plasticity, of rapid change and ready adjustment; senility is accompanied by stability, slow change, and the inability of the organism to adapt itself easily or perfectly to changed conditions.

During adolescence the adverse effects of departures from the normal are minimized or overcome; during senility such effects tend to remain and to be accentuated. The curve of a normal life cycle possesses a certain symmetry; its span varies and is a part of the inheritance of the individual (Fig. 11). Normal living throughout life conduces to the fullest realization of this inheritance; departures from such living tend to shorten the cycle. Theoretically, senility should be a period as normal and accompanied by as perfect health as is either of the previous periods.

466. Organismal Concept.—The concept of the organism as a unit may be contrasted with the cell concept. The cell is the morphological unit, some organisms existing as single cells, others as many. In the first case all functions necessary to life are performed by the one cell; in the second these functions are apportioned to the different cells that make up the whole, and the individual cells become dependent upon their association for continued existence. Applying the organismal concept to a protozoan, it is seen to be comparable not to any one cell of a metazoan but to the whole metazoan body. It is, from a physiological standpoint, correspondingly complex.

The many-celled organism has possibilities greater than the sum total of the possibilities possessed by the cells taken one by one or even in groups. These larger activities are the result of interaction between cells. Thus such an organism is comparable to a community made up of individuals, having peculiar powers and activities which belong to it as an organized whole and capacities which it possesses by virtue of its organization.

CHAPTER LXII

STRUCTURE OF ORGANISMS

In the simplest types of one-celled organisms there is little distinction between the different parts of the cytoplasm, all being freely interchangeable and all being able to carry on the same activities. In the higher Protozoa, owing to intracellular differentiation, certain portions of the cytoplasm become set aside for the performance of particular functions (Fig. 31). Since they are thus analogous to the organs of higher animals, they have been designated by such names as cell organs and organelles.

467. Grades of Organization.—Differentiation has already been considered in Chaps. XIX, XX, and LXI, in which attention was called to the fact that tissues are formed as a result of intercellular differentiation. These become associated together to form organs, and organs become related to each other to form systems. Four types of tissues are generally recognized, and eight or nine systems of organs. It was also seen in Chap. XXX that this organization was first fully shown in the flatworms; in higher animals it has been found to reach a high degree of complexity. Generally speaking, an organism is said to be low in organization when its structure is comparatively simple and high in proportion to its complexity. Accordingly the various phyla show various grades of organization.

468. Germ Layers and Tissues.—In the development of a metazoan, as traced in Chap. XXV, it has been seen that differentiation first results in the formation of three *germ layers*. It has also been noted that as the organism develops, these germ layers each give rise to certain *definitive tissues*, which are mature tissues as contrasted with those found in embryos or young animals. The classification of tissues depends, however, not upon the germ layers from which they are derived but upon the character which they possess. Thus epithelia may come from any one of the three germ layers (Sec. 146); most muscle cells are mesodermal in origin but in certain cases they are derived from ectoderm or entoderm; and the supporting framework of nerve tissue, called in general neuroglia and ectodermal in origin, has the character and function of a connective tissue, a type of tissue which is usually mesodermal.

469. Relationship of Cells in Metazoans.—While the cells in a metazoan may be considered structural units, they should not be thought of as independent of one another. As a matter of fact many of the processes which result in the formation of cells do not go on to a complete separa-

tion of the cells formed. Thus there may be found multinucleated cells, such as the striated muscular fibers. There are also living meshworks made up of cells which have only incompletely separated and remain in structural continuity. A tissue of the latter type is called a *syncytium* (Fig. 291), or, in the case of nervous tissue, a *nerve net* (Fig. 57). There are protoplasmic bridges which connect the epidermal cells of vertebrates, while in other cases fibrils extend from one cell into an adjacent cell and serve to coordinate the activities of the two. In no metazoan do the individual cells all live as they would if they were alone, but each is affected more or less by the proximity of the others. This is part of the organismal concept. Nevertheless, cells furnish convenient units on which to base our conceptions of morphology.

470. Organs and Systems.—In Chap. XXI the different systems were enumerated and brief references were made to some of the organs

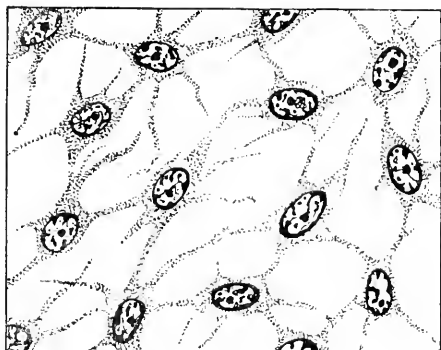

FIG. 291.—Semidiagrammatic representation of a syncytium, as seen in mesenchyme.

included within each. As each phylum has been taken up in turn, many facts have been given in regard to the development of various systems in it. Here, however, the phylogenetic development of these different systems will be reviewed but only in general terms. It is desirable to begin the discussion of each system with those structures which in lower types, in which the system does not exist, perform the corresponding functions.

471. Tegumentary System.—In the lower protozoans, it has been seen that no cell wall, properly speaking, exists. Many of these forms, however, secrete shells of one kind or another which serve for protection. In the higher protozoans there is a surface layer, or *pellicle*, which is really a wall secreted by the cell for the purpose of protection.

The epithelial cells of metazoans always have cell walls. In sponges the body is covered by a single layer of flat pavement cells called a dermal layer. In coelenterates and ctenophores there is no definite epithelium, but the body is covered by an ectoderm. In some cases, as in colonial hydroids, this ectoderm secretes a *perisarc*, and in the case of the corals

and related forms it deposits lime which is built up around the polyp. In flatworms a single-layered *epithelium* is found which in free-living forms is ciliated and attached to a basement membrane. In the adults of the parasitic flatworms the epithelium secretes a firm *cuticula*. In nemertines and in echinoderms, except the ophiuroids and crinoids, there is a simple ciliated epithelium.

In the mollusks the skin is made up of an epidermis composed of epithelial cells. This may secrete a cuticula. Under the epidermis is a connective tissue dermis which produces a limy *shell*. The shell is continually being extended at the margin as it grows and also thickened by addition from within. Brachiopods and bryozoans are similar to mollusks in this respect.

In the remaining non-chordate phyla the epidermis secretes a cuticula over the surface, which may be thin or thick and either flexible or not. The living cells beneath this cuticula are usually termed the *hypodermis* (Fig. 292). In the arthropods this cuticula contains a large amount of chitin, is thick, and tends to be quite rigid; in the crustacea it is still further hardened by the addition of lime.

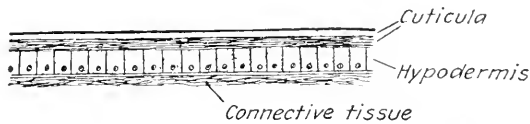

FIG. 292.—Diagrammatic section of an insect's skin.

The tegumentary system reaches its greatest development in the chordates, in which the *skin*, or *cuticle*, is made up of two layers, an epidermis which is ectodermal in origin, and a dermis, or corium, which is mesodermal and developed from mesenchyme. In the lower chordates and in the aquatic vertebrates it remains relatively simple. In the fishes scales are developed in the dermis, but in living amphibians they occur only in the form of scattered plates in the skin of the backs of a few exotic toads, and of rings of scales in cecilians. In the terrestrial vertebrates the epidermis becomes many-layered and from it are developed scales, hairs, and feathers; the dermis becomes thicker and also contains many structures, as indicated in Chap. L.

472. Skeletal System.—The skeleton, strictly speaking, is mesodermal in origin and develops in mesenchyme. In the vertebrates the skeletal parts produced in the mesenchyme of the dermis make up the exoskeleton, which is therefore tegumentary in relationship. To this are usually added the epidermal hard parts. The endoskeleton is formed in the mesenchyme lying deeper in the body.

A hard *endoskeleton* is present in only a small number of invertebrate types, though it is seen in some protozoans, where either a calcareous or siliceous framework may be developed in the animal, and in the sponges,

where spicules form a skeletal support for the body. In coelenterates and ctenophores the mesoglea furnishes some support. In other invertebrates generally the only internal support is formed by fibrous connective tissues, though in the case of cephalopods and arthropods cartilage is developed around the central nervous system. The chitinous shell of the squid, though developed from a tegumentary pocket, is actually internal. In the case of the cuttlefish lime is added to the shell, which becomes bony. The Aristotle's lantern of the sea urchin is an internal calcareous skeleton.

In chordates an internal skeleton is well-developed, represented first by a notochord, which later becomes replaced by a vertebral column, to which many other parts are added. In the lowest vertebrates this endoskeleton is membranous with only a little cartilage in some cases; in elasmobranchs it is cartilaginous; and from the bony fishes onward, more or less bony.

The axial skeleton presents a biogenetic series in that in the embryogenies of the highest forms there appears a continuous notochord surrounded by membranous sheaths, corresponding to the condition in the hag; this is replaced by a cartilaginous, segmented vertebral column, which corresponds to the condition in sharks. This in turn gives way to bony vertebrae, each consisting of several elements as in the bony fishes, amphibians, and reptiles; and in the final stage, seen in the adults of birds and mammals, each vertebra consists of a single bone.

In the absence of endoskeletons, exoskeletons are often highly developed among the invertebrates. They are in nearly all cases epithelial in origin and, therefore, belong to the tegumentary system. In the echinoderms, however, the plates are developed from the connective tissue below the epithelium and are, in the strict sense of the word, skeletal.

473. Digestive System.—The only structure concerned with digestion in protozoans and sponges is the *food vacuole*. In the coelenterates, ctenophores, and flatworms, however, digestion takes place in a *gastrovascular cavity*. Roundworms and all invertebrates above them possess an *alimentary canal*, which may be divided into three parts known respectively as the foregut, mid-gut, and hind-gut. The first of these is derived from the *stomodeum*, which is an infolding of the body wall that meets the anterior end of the archenteron and through which that cavity comes to open anteriorly. The foregut is lined with ectoderm. The hind-gut is derived in a similar fashion from an infolding that meets the posterior end of the archenteron, and is called the *proctodeum*. This region of the alimentary canal is also an ectodermal infolding. The mid-gut, which represents the archenteron, includes all of the rest of the alimentary canal and is lined with entoderm. The external opening of the stomodeum is the mouth opening; that of the proctodeum, the anal opening. There is considerable difference in the extent of the alimentary

canal comprised in these three regions. In some the foregut and hind-gut are relatively short and the mid-gut long, but in arthropods the mid-gut is only a short region between the stomach and intestine. In chordates the mid-gut is very long, the stomodeum giving rise to the mouth and the proctodeum to the posterior part of the rectum.

In the phyla possessing an alimentary canal has been observed the gradual appearance of specialization, shown by the setting aside and modification of particular regions for the performance of certain functions. For more effective functioning, various types of glands secreting different digestive enzymes have appeared. The absorptive surface has been increased by an increase in the length of the canal, by the formation of folds and villi, and by the production of blind sacs called caeca the cavities of which open into the lumen of the canal. A correspondence can generally be traced between the length of the canal and the character of the food, carnivorous forms having a short alimentary canal and herbivorous ones a longer and more capacious one. In the vertebrates this specialization of the canal reaches its highest development; the conditions there have been outlined in Chap. L.

474. Glands.—One of the functions of epithelial cells is the production of secretions or excretions. Epithelia of which this is the most prominent function are termed glandular. The secretion may be watery, in which case it is termed *serous*; or it may be thicker and contain mucin, when it is called *mucous*. The secretion may serve to moisten the surface of the body and prevent drying, as does that of the glands of the amphibian skin; it may prevent contact with water and the entrance of infectious organism, which is true of that of the skin glands of the fishes; or it may assist in temperature regulation, as in the case of perspiration in mammals. Other functions of such secretions are to lubricate internal surfaces or to aid in digestion, as in the cases of many glands connected with the digestive system.

One gland cell may function alone or many such cells may be grouped to form a *gland*. Glands are usually removed from the surface, and the secretion which is poured into the cavity, or *lumen*, of the gland reaches the surface through a tubular *duct*. In the case of oil glands and milk glands, the secretion is not passed out of the gland cell leaving the latter intact, as in most glands, but the cells themselves are broken down and passed into the lumen and out through the duct as part of the secretion, new cells appearing to take their places. Glands are classified, according to their shape, as tubular or alveolar and, according to the number of parts into which they are divided, as simple or compound (Fig. 293).

475. Respiratory System.—The respiratory system is one of the latest systems to appear. In protozoans respiration takes place through the surface of the cell and expiration is supposed to be aided, at least, by

the *contractile vacuole*. Respiration takes place through the general *body surface* in all metazoan forms up to and including the annelids, except in the brachiopods and bryozoans. In the case of the last two groups, as also in many of the annelids, respiration occurs through the surface of certain projecting *tentacles*. In the echinoderms a form of *skin gill* is developed, as described in Chap. XXXV. In mollusks *gills* are developed which are outfoldings of the surface of the body and into which is projected a network of blood vessels. In a few mollusks, however, gills are absent, and respiration takes place through the wall of a hollow sac, or lung, and also through the surface of the mantle. In crustaceans *external gills* are found; in the insects, a system of *tracheal tubes*; and in the arachnids, *book lungs*, or *book gills*. In all of these

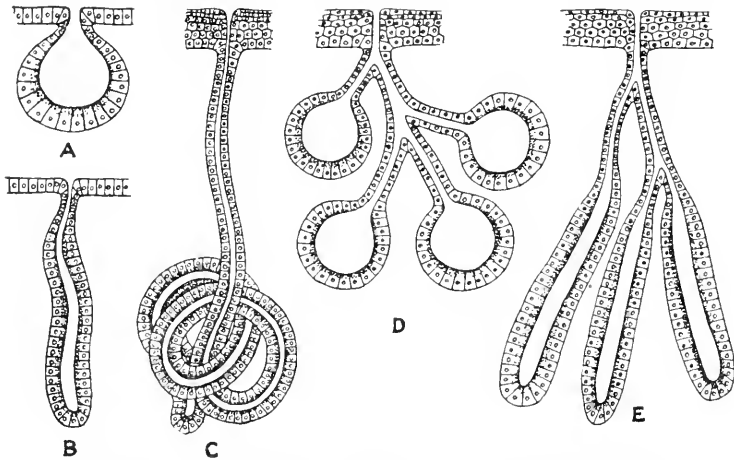

FIG. 293.—Diagrams showing types of glands. A, simple acinous gland. B, simple tubular gland. C, simple tubular gland showing coiling. D, compound acinous gland. E, compound tubular gland.

various types the blood is a medium of transport for the gases within the body, except in insects, where the circulatory system is poorly developed and where the gases are distributed by the complicated tracheal system.

In the lower chordates respiration takes place through the walls of *pharyngeal clefts*; and in the lower vertebrates, up to and including part of the amphibians, this is still the case, gills of different types being developed on the walls of those clefts. In the adults of most amphibians, however, it has been seen that the gills are replaced by *lungs*, while in higher vertebrates lungs are the only functional respiratory organs, reaching in the highest forms the greatest complexity and the largest amount of surface exposed (Fig. 294).

476. Circulatory System.—In the protozoans circulation takes place within the cell; in the lower Metazoa, up to and including the Platyhelminthes, from cell to cell. In the sponges it is aided by ameboid

cells; and in the other phyla, by canals or branches of the gastrovascular cavity. The circulatory system when it does appear is formed in the mesenchyme, both the cells of the walls of the vessels and the blood corpuscles being modified mesenchymal cells appropriately arranged. The vessels become lined with *endothelium*, a type of epithelium also derived from the mesenchyme, and to this is added connective tissue and nonstriated muscles, making up the wall of the vessel.

No true circulatory system appears in the nemathelminths or rotifers, but a blood-vascular system is found in nemertines, bryozoans, brachiopods, echinoderms, and higher forms. In the primitive stages of the blood-vascular system as it appears in the lower animals pulsations occur throughout the system. In the higher forms, however, the pulsa-

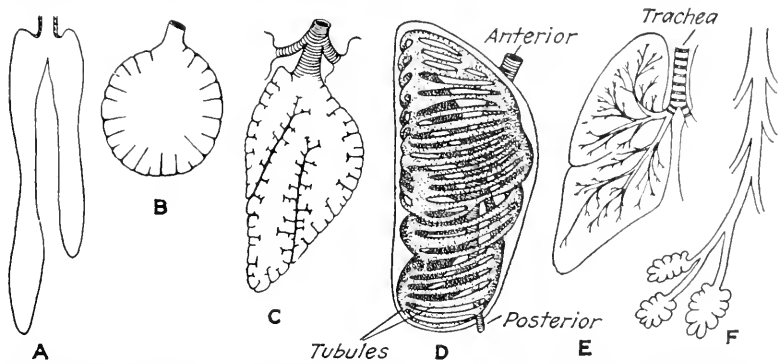

FIG. 294.—Diagrams illustrating the increase in the amount of surface exposed to the air in different types of lungs. A, lung of *Necturus*, without alveoli. B, lung of a frog, with simple alveoli. C, lung of a lizard, showing increasing complexity. D, lung of a bird, seen from the inner side, showing the bronchus entering anteriorly and the passage to the air sacs posteriorly; the passages in the lungs are seen to form a continuous system of tubules, none of which ends blindly. E, lung of a mammal showing the branching of the bronchi. F, a portion of the bronchi of a mammal, to show the ending in alveoli. (D from Loey and Larsell, *Amer. Jour. Anatomy*, vol. 20.)

tions become limited to certain structures called *hearts*, which are dilated chambers provided with a larger amount of muscular tissue than exists in vessels generally. A single heart is found in all arthropods, in mollusks, and in chordates with the exception of Hemichordata. In vertebrates there has been seen a gradual increase in the number of chambers in the heart.

There are two types of circulatory systems, one known as the *closed* type, where the blood is confined within a closed system of vessels; and the other the *open* type, where the blood circulates through sinuses which are hemocoelic. Nemertines and annelids have a closed system; in mollusks and arthropods the system is open; and in echinoderms and chordates it is again closed.

477. Excretory System.—In protozoans the only eliminative structure is the *contractile vacuole*. Sponges, coelenterates, and ctenophores

have no specialized cells for elimination, but in flatworms there is a simple type of excretory organ known as a *protonephridium*, represented by the flame cell of the planarian. Similar structures are present in nemathelminths, nemertines, and rotifers. In higher invertebrates a structure known as a *metanephridium*, representing a collection of protonephridia, is the excretory organ. In annelids these structures, which have been described as nephridia, are represented in nearly every metamere. Nephridia are also present in brachiopods, bryozoans, and mollusks, though there is only a limited number of pairs. In echinoderms excretory cells, the *amebocytes*, carry on elimination, while in myriapods, insects, and arachnids *malpighian tubules*, and in the crustaceans *green glands*, perform this function.

Nephridia or excretory cells also carry on elimination in the lower chordates but in vertebrates there is a higher type of structure known as a kidney, or *nephros*. This contains tubules originating in a certain number of body segments and is called, according to its position in the body, a pronephros, mesonephros, or metanephros (Sec. 349, Fig. 216). The pronephros is functional only in the myxinoids, while a mesonephros is the functional kidney in lampreys and in all forms up to and including amphibians. This is replaced by a metanephros in reptiles, birds, and mammals. The pronephros and mesonephros, however, appear in the embryonic stages of these higher forms and vestiges of them remain even in the adults.

478. Reproductive System.—In the least differentiated protozoans the individuals are all alike and reproduction is purely asexual. In the higher protozoans reproductive cells, which are essentially sexual organisms, are distinguishable as macrogametes and microgametes, and reproduction becomes, therefore, sexual. In the lower metazoans asexual reproduction still occurs; nevertheless, even in the lowest of the Metazoa reproduction by means of specialized sex cells becomes a prominent method of multiplication, and in higher forms it becomes the only type. In urochordates, however, asexual reproduction again appears.

In coelenterates the sex cells are derived from interstitial cells, and the mass of cells in which they are produced is either the *testis* or the *ovary*, though here these are not, strictly speaking, organs. In the flatworms not only do the testes and ovaries become organs but a whole system of accessory organs arises and in these animals the reproductive system is the most highly developed of all systems. In higher forms the number and variety of accessory organs vary considerably with the type of habitat and the conditions under which reproduction takes place.

In many of the lower Metazoa a *monocious* condition prevails, testes and ovaries being found in the same individual, though as a rule self-fertilization is avoided by structural conditions which prevent it or by

differences in the time of maturation of the two kinds of sex cells. In the higher metazoans the *diecious* condition is prevalent and is usually accompanied by a certain amount of *sexual dimorphism*. This involves differences between the two sexes and these in part are of such a nature that each sex is able more effectively to perform its part in reproduction. Dimorphism is one aspect of the general phenomenon of polymorphism. In some cases the male becomes degenerate and, rarely, even parasitic upon the body of the female. In still other cases *parthenogenesis* prevails; this may give way to sexual reproduction at times, but cases are known among rotifers where it is the only form of reproduction and males are not known to exist.

479. Muscular System.—The first contractile structure met with was the *myoneme* of the protozoan cell. In the sponges certain cells are set aside as *neuromuscular cells* in which both irritability and responsiveness are more highly developed than in other types of cells. In the coelenterates *contractile fibers* occur which are processes of epitheliomuscular cells, and in some forms *contractile cells* themselves are found. A more advanced condition is seen in the ctenophores in which *muscle cells* derived from the mesenchyme take the place of contractile fibrils associated with ectodermal cells or muscle cells derived from such cells. Muscle cells have already been distinguished as involuntary, or non-striated, and voluntary, or striated. Nonstriated fibers are of very wide distribution and are the only type present in the lower Metazoa; striated fibers are developed in mollusks, arthropods, and chordates.

In ctenophores, flatworms, and rotifers muscle fibers exist as isolated fibers or are associated in bands or sheets. In the higher forms, the voluntary muscles are in the form of definite organs known as *muscles*. In the highest form of such an organ as it occurs in the higher vertebrates may be distinguished a *belly*, or body, of the muscle and *tendons* at either one or both ends (Fig. 40). The attachment from which the muscle exerts its pull is called the *origin*; the attachment pulled upon, the *insertion*. In the most highly developed muscles of the vertebrates the muscle is not only enveloped in a connective tissue sheath but it may be separated into bundles, each with its own sheath, each fiber also being surrounded with connective tissue. In such a muscle the connective tissue sheaths are continuous from one end to the other and are brought together to form the tendons. Thus, while they do not interfere with the contraction of the muscle fibers themselves, they resist overstretching of the muscle and in that way serve to protect the soft, contractile fibers which they surround.

480. Nervous System.—In the more highly differentiated protozoan cells strands of cytoplasm are found (Fig. 31) which conduct the effects of stimulation, and there may be even structures analogous to nerve centers present. The sponges possess neuromuscular cells. In the

coelenterates *nerve cells* are met for the first time, and these exhibit more or less variety.

Generally speaking, in the coelenterates are found certain ectodermal or entodermal cells which receive stimuli and which may be called sense cells or *receptor cells*. These are connected to nerve cells lying deeper in the ectoderm or entoderm, which with their connecting and conducting fibers form a *nerve net*. This net is structurally continuous and is intimately connected to the contractile fibers. There is a tendency for these nerve cells to concentrate in one ring about the hypostome and in another about the basal disc (Fig. 295). In the flatworms this tendency toward centralization results in the development of central *ganglia* below the eyespots and a ganglionic cord on each side, and central and peripheral portions may be distinguished in a *nervous system* (Fig. 72C). This also leads to a type of *reflex action*.



FIG. 295.—A young hydra showing the nerve net, which tends to be condensed in one zone about the base and another about the hypostome. (From Hadzi, *Arbeiten aus der Zoolog.-Institut der Universität Wien*, vol. 17.)

A typical reflex act has been described in connection with the earthworm (Sec. 279). This results from the development of a *synaptic nervous system*. The unit of such a nervous system is the neuron, or nerve cell, and neurons are related to each other through synapses in which their fibers come into intimate contact. At first, reception of stimuli is by neurons lying upon the surface and called receptor neurons. As the nervous system becomes more highly developed the neurons are withdrawn from the surface and certain epithelial cells receive the stimulus and may be associated in groups in sense organs or *receptors*. These modified epithelial cells receive the stimulus and pass it over to the dendrites of the sensory neurons, which are lodged in ganglia within the body. In the vertebrates such neurons are found in the dorsal root ganglia of the spinal and cranial nerves (Fig. 218). In all cases, however, neurons are ectodermal in origin and are developed upon the surface early in embryonic life, later to sink deeper in the body and reach their ultimate location.

The types of nervous systems may be named as follows:

1. *Reticular Nervous System*.—This has also been called a diffuse nervous system. In its primitive form such a system consists of a nerve net; this is found only in the coelenterates. In some coelenterates, ctenophores, and echinoderms ganglion cells are added. In the flatworms and the phyla which follow them ganglia are present. Nerve nets persist in all higher forms and are found even in the walls of the blood vessels and alimentary canal in vertebrates.

2. *Ganglionic Synaptic Nervous System*.—Nervous systems of this type possess neurons the cell bodies of which are in ganglia. In the mollusks these ganglia are more or less scattered, but in the annelids and arthropods they are arranged segmentally along a double ventral nerve cord (Figs. 155 and 177).

3. *Tubular Synaptic Nervous System*.—This type of nervous system, characterized by a dorsal central nervous system which is tubular in shape, is characteristic of chordates and has been described in connection with them (See. 334).

In the tracing of the nervous systems of the various phyla two phenomena have been noted, centralization and cephalization. These have been referred to in Chap. LXI.

As epithelial cells become modified to form receptors, taking the place of receptor neurons which in lower types lie upon the surface of the body, they come to be specialized so that each group receives only a certain kind of stimulus. A great variety of accessory structures are added to the organs which increase their effectiveness. The sense organs of vertebrates, especially such organs as the eye and ear, become in this way exceedingly complex.

Those receptors which receive stimuli from without are known as *exteroceptors*. Such receptors are those associated with the chemical senses of taste and smell; those receiving contact stimuli, giving rise to sensations of touch, pressure, and pain; those receiving temperature stimuli, giving rise to sensations of heat and cold; and those stimulated by sound vibrations and by light. There are others which are known as *interoceptors*, stimulated by conditions within the digestive system and giving rise to sensations such as hunger, nausea, and visceral pain. There is also a third group, known as *proprioceptors*, which are stimulated by vital processes within the organism itself. Included in these are the pressure receptors of muscles, tendons, ligaments, and other internal organs, pain spots, and organs of position which give to the animal a sense of equilibrium.

481. Convergence and Divergence.—To the field of morphology belong the phenomena of analogy and homology, which were early defined. *Homology* may exist between organs or parts metamericly arranged in the same body; between those on the opposite sides of a bilaterally symmetrical animal; between the antimeres of a radially symmetrical animal; or between corresponding organs and parts of different individuals. *Analogy* involves no correspondence in manner of origin and only such correspondence in position as is mechanically necessary to the performance of a function. An illustration of the latter is seen in the case of wings, which have to possess a certain position with reference to the center of gravity of the organism, or of a locomotor fin, which has to be at the posterior end of the body. Phenomena which are,

in a way, related to homology and analogy are those of convergence and divergence. As a result of *convergence*, which occurs when dissimilar animals become adjusted to a common environment, animals very unlike in ancestry and different in structure have a close superficial resemblance

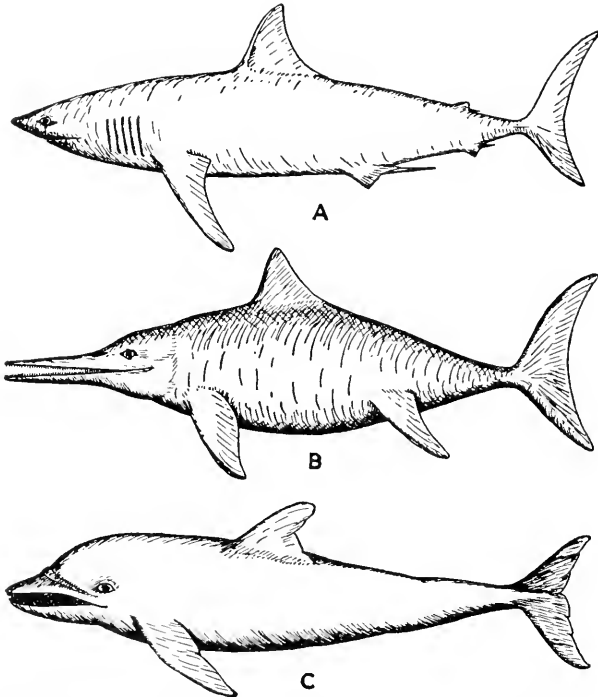

FIG. 296.—Figures to illustrate convergence. A, a mackerel-shark. (Based upon Jordan, "Guide to the Study of Fishes.") B, restoration of a fossil aquatic reptile, *Ichthyosaurus*. (Based upon Schuchert, "Historical Geology.") C, a dolphin. (Based upon Bruchm, "Thierleben.")

to each other, while as a result of *divergence* related animals, because of adaptation to dissimilar environments, become quite unlike. Convergence is well illustrated by aquatic types belonging to different classes of vertebrates, which are similar in the shape of their bodies and the character of their locomotor organs (Fig. 296). Divergence is shown very strikingly by mammals, which, derived from a cursorial ancestor, have become modified for fossorial, arboreal, volant, and aquatic life.

CHAPTER LXIII

DEVELOPMENT OF THE ORGANISM

EMBRYOLOGY

In Chap. X the subject of reproduction in animals was first presented and it was there stated that while in the most primitive of Protozoa reproduction occurs by simple division of the single cell which makes up the organism, in the higher types of Protozoa and in Metazoa certain cells known as gametes function as reproductive cells. The latter was spoken of as sexual reproduction. In Protozoa, however, a zygote so formed is a one-celled animal and so the process of reproduction does not involve the formation of an embryo. In the many-celled animals the zygote gives rise to the metazoan body only after repeated cell division, and the structures of the adult are gradually formed. During this time differentiation and integration occur and the organism passes through a series of developmental stages during which it is known as an *embryo*. The study of such stages provides the subject matter of embryology.

482. Germ Cells.—Strictly speaking, *embryogeny* begins with the zygote, but since many of the phenomena concerned with early embryonic development are directly traceable to those which attend the production and maturation of the germ cells, the development of these cells is usually taken as the starting point in this field. In Chap. XXIII has been considered the development of the germ cells, or gametogenesis, which includes both spermatogenesis and oogenesis.

483. Origin of Germ Cells.—The difference between the germ cells and somatic cells in animals may usually be detected early in the life of the individual. In the case of the arrow worm, *Sagitta*, the egg cell possesses a so-called *x*-body. In the 4-cell stage this body still remains in one of the cells and this continues until the 64-cell stage. The cell which then contains this *x*-body may be identified as the primordial germ cell; from the other cells are developed the somatic cells of the body. In *Ascaris* the primordial germ cell may be recognized as one of the cells in the four-cell stage. In certain insects the primordial germ cells have been recognized very early by their large size and peculiar structure. In vertebrates the primordial germ cells are not recognizable until considerably later, but still early in embryonic life cells lodged among those lining the digestive tract may be seen to migrate to a place in the wall of the coelom, where they accumulate and form the beginning of a reproductive organ. These cells are recognized as the primordial germ cells.

484. Maturation of the Germ Cells.—In the maturation of a sperm cell is involved its metamorphosis into a mature sperm cell in which a head, middle piece, and tail are recognizable. Egg cells exhibit no metamorphosis but merely accumulate a supply of yolk. This has been described in connection with the origin of the sex cells in Chap. XXIII. The steps there given are true of animals generally. There is, however, one modification known as *tetrad formation* to which no previous reference has been made. In synapsis it is sometimes true that not two chromosomes are seen but that a group of four appears. This has been shown to be due to a precocious division of the two chromosomes of a synaptic pair. In this case the four are known as a *tetrad*; and its division into two bodies, each composed of two chromosomes, one derived from one parent and one from the other, produces a *dyad*. This is equivalent to a mitosis, and chromosome reduction occurs when the two of the dyad become separated in the second maturation division.

485. Egg.—In the maturation of the egg cell is usually produced a protective cell membrane which, with the egg cell, forms the *egg*. In the higher vertebrates a variety of protective coverings may also be added, until in the case of the reptiles and birds an egg becomes composed of added material which may exceed in bulk the egg cell itself. In the case of the eggs of many invertebrates which possess a shell, particularly those of the arthropods, there is an opening in the shell known as a *micropyle* through which the sperm cell enters in fertilization. In the case of vertebrates, however, the protective envelopes which are added prevent the entrance of a sperm cell, so fertilization occurs before their addition. In the case of reptiles and birds, indeed, so much time elapses between fertilization and the laying of the egg that the egg, when it is laid, contains an embryo and not an egg cell.

486. Fertilization.—The time and place of fertilization vary in different animals. The egg may be fertilized while still within the body of the female, in which case fertilization may take place at any point along the oviduct; or it may not occur until after the egg is laid. In some cases the sperm cell enters the cytoplasm of the egg cell before maturation is complete, in which case the union of the two pronuclei (Sec. 139) is delayed until the formation of the second polar body. Sometimes, indeed, the entrance of the sperm cell is necessary to bring about the maturation of the egg cell.

487. Cleavage.—Soon after fertilization—in some cases within a few minutes—cleavage occurs and the development of an embryo is begun. In Chap. XXV attention was called to differences in the distribution of the yolk in homolecithal, telolecithal, and centrolecithal eggs. This yolk distribution also affects the cleavage. Homolecithal eggs are holoblastic and if there is only a small amount of yolk and it is quite evenly distributed, cleave totally and equally; if there is more yolk and it is not

evenly distributed, they cleave totally but unequally. Telolecithal eggs in some cases, as in that of the frog, are still holoblastic and show total and unequal cleavage; in other cases the excessive amount of yolk causes them to be meroblastic and the cleavage to be discoidal. Centrolecithal eggs are also meroblastic, but they cleave superficially. Generally speaking, the lower metazoans and the lower chordates exhibit total and equal cleavage. Many of the higher worms and mollusks, as well as the lamprey and frog among the vertebrates, possess total and unequal cleavage. The arthropods exhibit superficial cleavage, and the fishes and higher vertebrates generally show discoidal cleavage. In the mammals, however, pronounced and characteristic modifications in development occur. In eggs exhibiting total cleavage the blastomeres which are formed remain entirely distinct and each possesses a complete wall. In discoidal cleavage, however, the cells adjacent to the yolk remain for a considerable time without a wall on the side next the yolk. In superficial cleavage the first blastomeres formed have no cell wall next the yolk and even after they have migrated to the surface the cell wall next the yolk remains for some time incomplete.

488. Blastula.—In embryos produced by total and equal cleavage the first appearance of a blastocoel, or segmentation cavity, is the central cleft between the cells in the eight-cell stage, which is open to the outside by crevices between adjacent cells. As the cells multiply and press upon one another these crevices are closed, the central cleft becomes a cavity entirely surrounded by one or more layers of cells forming the blastoderm, and the embryo is a blastula. Thus there is no morula stage. In telolecithal eggs this segmentation cavity lies toward one side of the embryo and is produced by a splitting apart of the cells which earlier formed a solid morula.

489. Gastrulation.—In Chap. XXV were also noted certain modifications in the manner of gastrulation. In homolecithal eggs gastrulation takes place by *invagination*, but in some telolecithal and in centrolecithal eggs it is the result of a splitting apart of the cells, or *delamination*. In other telolecithal eggs gastrulation is accompanied by overgrowth, or *epibole*, as a result of which the cells at the animal pole grow around and envelop the vegetal pole of the egg, ultimately hiding it from view. This has been described in the development of the frog's egg (Sec. 400).

490. Mesoderm Formation.—In the chapter already referred to (Chap. XXV) were also described the formation of the germ layers and the fate of the embryonic cavities. In the sponges and in some coelenterates the wandering cells form a middle layer, which, for reasons previously stated (Sees. 148 and 183), is not considered to be a mesoderm. In the ctenophores for the first time a distinct mesoderm lying between the ectoderm and entoderm is encountered, although it is composed of few cells. From the flatworms onward, however, the mesoderm makes

up a large part of the mass of the body and as a result of differentiation forms a variety of tissues.

The mesoderm includes both *mesothelium* and *mesenchyme* (Sec. 144). The mesenchyme is derived from ectodermal or entodermal cells which are freed in the blastocoel and form a loose meshwork; this appeared for the first time in the etenophores and became well developed in the planarian. Cavities may appear in the mesenchyme; when these form spaces between the viscera and appear like portions of a body cavity but contain blood, they form what is known as a *hemocoel*. In the case of some forms the mesothelium is derived by a process of delamination from the entoderm; in other cases, however, it is produced by outpocketings of the wall of the archenteron which become cut off from that cavity and form what are known as *mesodermal pouches*. These pouches are metamERICALLY arranged in pairs. Each pouch extends upward and downward and becomes divided into three portions known respectively as the *epimere* dorsally, *mesomere* laterally, and *hypomere* ventrally. The hypomere is divided into the somatic and splanchnic layers, the space between these two layers being the true *coelom*.

491. Tissue Formation and Organogeny.—From the three germ layers develop all the tissues of the mature animal. Organogeny has been defined as the development of organs by the association of tissues and leads to the development of systems. Organogeny takes place in a variety of ways in the different phyla, and references in various places earlier in this text, especially in the preceding chapter, have indicated certain details in the development of the organs and organ systems.

492. Postembryonic Development.—In all the lower animals as long as the embryo remains within the egg it is spoken of simply as an embryo. In these forms when the organism escapes from the egg it is extremely simple, and a considerable degree of growth and development is necessary before it becomes mature. During this period it is known as a *larva*. In higher forms, however, the organism is much more complex when it is freed from the egg and may be quite similar to the adult, in which case it is simply recognized as young. In birds the young animal within the egg is given the same name as after it has hatched; an example is the chick. The young within the body of the mammal is called an embryo until about one-third of the time during which it is retained in the uterus has elapsed, after which it is called a *fetus*.

If pronounced changes take place during larval life, the phenomenon is known as *metamorphosis*. This has been noted in the discussion of the biogenetic law and in connection with the development of several types including the sheep liver fluke (Sec. 200), echinoderms (Sec. 239), insects (Sec. 313), tunicates (Sec. 338), and amphibians (Sec. 400). Metamorphosis may be varied in degree, but the terms complete and incomplete are applied only to metamorphosis in the insects, depending

upon whether development does or does not include a pupal stage. Sometimes more stages than those in complete metamorphosis are observed; this phenomenon is called *hypermetamorphosis*. Larval life may be accompanied by the development of characteristic larval organs which later disappear and are lacking in the adult. Such adaptations usually characterize individual types, are termed *cenogenetic*, and are to be distinguished from larval characteristics which are ancestral and phylogenetic in character.

493. Potential Immortality of Germ Cells.—Germ cells possess a potential immortality, since any germ cell has the capacity under proper conditions to take part in the production of another individual, and this may continue for an indefinite number of generations. Nevertheless, they perish in enormous numbers, since many eggs are never fertilized and a greater number of sperm cells never find an egg cell with which to unite. In contrast to germ cells, somatic cells present no possibility of life beyond the lifetime of the individual of which they are a part. The distinction between germ cells and somatic cells, or, more exactly, between germ plasma and somatoplasm, was emphasized by Weismann (Sec. 117). He also stressed the independence of the germ cells and likened the body, or soma, to a vehicle for the nourishment and transmission of germ cells. The hereditary units, which determine the possibilities open to the animal, are passed from generation to generation in the germ cells, while in the various types of somatic cell, under the environmental conditions which surround each, are realized and manifested such of these possibilities as, taken together, equip the individual with its characteristic features.

CHAPTER LXIV

ENERGY CHANGES IN ORGANISMS

From what has been stated previously it is clear that a living organism may be looked upon as representing a store of potential energy, while the organization which it possesses may be regarded as a system for the transformation of energy. During the carrying on of life activities energy is constantly being changed from potential to kinetic form. Kinetic energy is dissipated and thus the body will run down unless an additional amount of potential energy is continually being supplied to it. That additional amount is secured from the food for the most part, the small amount of kinetic energy received by the animal organism directly from the light and heat of the sun and the heat of the earth being quite insufficient to maintain life.

494. Chemical Changes in the Body.—For the most part the chemical changes which occur in the body are of the nature of oxidations. These occur in all tissues but to a greater degree in the more active ones. The food taken in is, after digestion, circulated to various parts of the body and built into the organization of the living cells. Oxygen also enters the body and is circulated so as to reach every cell. Then, within the cell, and under the influence of enzymes known as *oxidases*, the oxygen is caused to unite with the food, which has now become part of the protoplasm. Later, when the complex compound thus produced is broken down and simpler compounds are formed, kinetic energy is liberated. These simpler compounds, now waste products of the cells which produced them, have to be carried from these cells to some point where they can be eliminated from the body. It is probable that no food is oxidized in the body until after it has been added to the living matter. In some cases, as we have seen, the waste may temporarily serve some purpose in the body, in which case it is known as a secretion. Among such substances are the hormones and those which themselves stimulate other chemical changes, as, for instance, the digestive enzymes.

495. Organism Compared to a Fire.—Since life involves constant oxidation, it was pointed out nearly two centuries ago by the French chemist, Lavoisier, that life might be considered combustion taking place under certain peculiar and complicated circumstances. Fire is usually thought of as combustion, or oxidation, taking place rapidly with the appearance of flame, but slow burning involves exactly the same chemical changes and leads to the same result. The correspond-

ence between the slow burning which takes place in the body and any burning which takes place outside it seems to be very perfect when one considers several facts. Food and fuel are both converted into simpler chemical substances, and during this conversion a certain amount of potential energy is liberated as free energy, chiefly as heat and light. In both cases carbon dioxide and water are formed, and in both cases the unburned residue remains, forming the ashes of the fire or the feces passed out of the body. Chemical changes taking place outside the body liberate the same amount of energy as when these changes take place within the body, but the conditions within the body determine the speed of liberation and the manner in which the energy is expended.

496. Organism Compared to an Engine.—In certain respects the comparison between the body and the fire is inadequate. The fire liberates kinetic energy but this kinetic energy can be controlled and directed only in case there is added to the fire some form of apparatus by means of which this control is possible. Such an apparatus is an engine. The body may, therefore, be compared to the fire plus the engine which utilizes the energy and directs its expenditure. As a result of this control the organism is capable of doing a large amount of effective mechanical work.

497. Organism More Than a Machine.—An organism, though it may be compared to an engine, is, however, far more than any inorganic machine for the following reasons:

1. It possesses control from within. It is true that living organisms are constantly stimulated and caused to act by various forces in the environment, but it also seems to be true that the very organization of living matter, unstable as it is and prone to change, makes possible activities which are initiated from within the organism without any immediate stimulus from the outside.

2. It exhibits a degree of harmonious activity between structures which exceeds that shown by any nonliving assemblage of parts.

3. It has the capacity to regenerate itself. Changes taking place in inorganic masses lead to disintegration and are permanent unless the masses are again acted upon by an outside agent.

4. It has the power of reproduction, which implies the development of new individuals like the parent.

5. It possesses individuality, and this individuality is capable of being transmitted from parent to offspring through many generations.

498. Individuality.—Individuality, as has been indicated in a previous chapter (Sec. 462), is universal among animals. In reference to man it is what we call personality. Its source is in minute differences in the precise character of the organization and, therefore, in the exact functioning of the organism. It involves distinctions which we recognize as existing

between individuals and not between species. Such individual differences may be the material basis of evolution.

499. Rhythmicity.—All animal activities seem to be rhythmic in character. The nature of the organization seems to result in a gradual acceleration of metabolism to a maximum and then a recession, followed by another acceleration and recession. Regular periods of rest and sleep are very general phenomena among animals. The rhythms which accompany the function of reproduction are particularly evident, but other functions of the body exhibit rhythms which are less pronounced.

500. Uses of Foods.—As has been previously stated (Sec. 44), food is necessary to replace waste, provide material for growth, and furnish energy to the organism. It follows then that the food must be made up of the same substances of which the body is composed or else of substances readily transformable into them. The following summarizes the present views on the uses of food in the body of a higher vertebrate.

1. The protein of food replaces the protein of the body which is used up.

2. All of the protein is used as it is secured, none of it being stored. An excess is burned and the products of combustion eliminated. In this process a certain amount of heat is developed, but proteins are not an economical source of heat.

3. Carbohydrates are mainly used in the body as sources of muscular energy, being incorporated in the organization of muscles and then broken down during muscular activity.

4. The oxidation of carbohydrates also produces heat and more than does the oxidation of protein but not so much as is obtainable by the oxidation of fats.

5. Fats are the most economical sources of heat in the body.

6. The body maintains at all times in the liver a large store of carbohydrates, from which a constant supply is furnished to the blood for use by the muscles.

7. An excess of both carbohydrates and fats is changed to fat and stored as such. The fat taken into the body is not always stored in the same form as the fat which is taken in but is broken down in the process of digestion and recombined to form the various fats characteristic of the particular organism.

8. Salts are necessary elements in food because they serve to facilitate chemical changes, create conditions which determine the solubility of various substances, and, through the part they play in osmosis, participate in the transfer of water from one part of the body to another.

9. Water is important as a solvent, as a carrier of substances in solution, and as a regulator and distributor of heat. The last function is possible because of the high specific heat which water possesses.

10. Vitamins are essential elements in food, serving in some way to make possible the incorporation of foods into the living organization. In the absence of vitamins perfectly appropriate food may be brought to cells which need it, but these cells are unable to make use of it. As a result the body may be starved though it may contain an abundance of food.

It remains to be noted that the specific character of many substances affects their availability as food; for instance, vegetable fats are less readily assimilated and less serviceable in the animal organism than are animal fats.

501. Planes of Metabolism.—All animals do not live on the same metabolic plane, some animals demanding a high protein content in their food, others a high carbohydrate content. Not only is this true of different types, but the individual organism may at any time adjust itself to a metabolic plane different from that upon which it has previously lived and, it may be, different from that of other animals of its kind. This, of course, is true within certain limits, which, however, seem rather wide. Different types of animals are capable of adjusting themselves to great differences in the amount of water they require. An aquatic organism may demand constant immersion; on the other hand, a desert type may find all its needs satisfied by the dew which falls during the night or the little moisture which comes in the form of rain. The clothes moth can go through generations in a dry closet without apparently needing any moisture from without. It is believed that any animal can manufacture a certain amount of water in its body as a result of oxidation processes. In the case of the clothes moth this metabolic water is apparently sufficient in amount to meet the needs of the organism.

502. Body Heat.—Since all active organisms are constantly carrying on chemical changes which mainly involve oxidation, all produce heat, though the amount of heat produced varies greatly with the size and character of the organism. The most minute organisms produce an amount of heat so small as to be beyond the registering power of the most delicate instrument; larger organisms, however, produce a considerably greater amount. Many animals which singly produce an amount that is imperceptible to us may in large groups yield enough to produce a very distinct sensation. That is true, for example, of ants in an ant hill or bees in a hive. The amount of heat produced is determined by the plane of metabolism and the character of the food, as well as the degree of activity of the organism. The higher animals with their more efficient respiratory organs are capable of producing a relatively larger amount of heat than are the lower forms with their less efficient systems.

503. Heat Regulation.—Since the lower animals have no means of regulating the heat of their bodies, it is radiated as fast as it is produced.

Warm-blooded animals, however, possess methods of heat regulation which involve both structures and functions. Structures tending to regulate the heat produced by the body are body coverings, such as feathers and fur.

Functionally the body regulates heat through the nervous system by controlling the activities of the various parts, particularly the activity of the circulatory system. By increasing the speed of circulation oxygen may be more liberally supplied to the various parts of the body, and the amount of heat developed correspondingly increased. The opposite is true of a slowing up of the circulation. By changes in the caliber of the blood vessels, the distribution of heat in the body may also be modified; the blood may either be accumulated toward the center of the body, where the heat is conserved, or be carried to the periphery, where the heat is allowed to radiate freely.

Another factor in heat regulation is evaporation from the surface of the body. In many mammals the sweat glands provide a means by which the body surface may be cooled when the temperature becomes too high. Water, because of its high specific heat, absorbs a large amount of heat in passing from a liquid to a gaseous state. This heat has to come from the media with which the water is in contact, and so the evaporation of perspiration cools the surface of the body.

504. Warm-blooded and Cold-blooded Animals.—As a result of the varying amounts of heat produced by different animals and the varying efficiency of heat regulation, there is great diversity in the temperature maintained in the bodies of different forms. In the case of all but birds and mammals, however, this temperature approximates the temperature of the air or water in which the animal lives, being sometimes a little higher and sometimes a little lower but never departing far from it. In the case of birds and mammals, because of the amount of heat they produce, the presence of a heat-conserving body covering, and a heat regulatory mechanism, the organism is able to maintain a temperature independent of that of the surrounding medium and approximating a constant under all conditions. What this constant temperature shall be is determined by the individual type and varies considerably as between different species. Animals which can maintain a constant temperature are termed *homoiothermous*, though popularly they are known as warm-blooded; animals unable to do so are termed *poikilothermous*, or cold-blooded. In the case of mammals that go into true hibernation, which involves a state of lethargy and practical cessation of all activity, a warm-blooded animal may relinquish temporarily its power of heat regulation and become actually cold-blooded. Thus an active ground squirrel, which at different seasons and under different conditions possesses rectal temperatures of 30° to 39°C. (86° to 102°F.), may in hibernation exhibit a temperature of 5°C. (41°F.) or even less. The average temperature of

mammals is about 39°C. (102°F.) but that of the monotremes is only 25°C. (77°F.). The temperature of the monotremes is also more variable than in other mammals. Birds average about 5°C. (9°F.) higher than mammals.

505. Temperature of the Human Body.—The normal body temperature of man is 37°C. (98.6°F.), taken in the mouth or arm pit. The temperature of a healthy individual, however, varies somewhat during the day, being highest at the end of a day of activity and lowest at the close of a night of rest. It also varies in different parts of the body, in the liver rising to nearly 42°C. (107°F.) and in muscles varying from normal to 40.5°C. (105°F.), depending upon the degree of activity. In the skin the temperature approximates that of the surrounding air; thus at the one extreme it may approach freezing, while at the other it may rise to 34°C. (93°F.), though normally not higher, even on a hot day.

Below an air temperature of 60°F. the heat of our bodies is maintained by increasing the rate of heat production and by heat-conserving clothing. Between 60° and 70°F. regulation on the part of the body is accomplished largely by changes in the caliber of the peripheral blood vessels and control of radiation. From 70° to 98.6°F. the temperature is regulated by evaporation from the surface, combined with flushing of the skin. Above the normal body temperature maximum radiation and abundant perspiration are the most effective means of control, supplemented by modification of the diet and reduction of muscular activity.

From this discussion it is clear that excessively high summer temperatures, those from 100° to 105°F. or more, place a heavy burden on the heat regulatory mechanism of the body and that the strain increases as the temperature rises. It is also evident why excessive temperatures are more easily borne in dry climates or in dry weather, with rapid evaporation, than in humid climates or when there is a high degree of humidity in the air, tending to decrease evaporation.

CHAPTER LXV

FUNCTIONS OF ANIMAL ORGANISMS

GENERAL PHYSIOLOGY

The energy changes discussed in the preceding chapter have been seen to be intimately associated with the metabolic activities of the organism. These in turn cause or accompany the exercise of the various functions. It is logical, then, to consider next certain facts in regard to metabolism and to review the general physiology of animals.

506. Chemical Cycles.—In the carrying on of metabolism an animal takes certain foods into its body, breaks them down in dissimilation into simpler waste substances, and then eliminates these wastes, adding them to the air, the water, or the soil. These wastes, together with the bodies of dead organisms, are reduced to very simple substances by decomposition due to the action of bacteria. Plants take these substances, or in some cases the animal wastes, from the air, water, and soil and build up again from them the foods which the animal needs. Thus the elements which these various substances contain may be followed through cycles, partly related to the inorganic environment, partly to the life of plants, and partly to the life of animals. In that portion of the cycle occurring in plants and animals the element is involved in the chemical changes included in metabolism. Of the elements found in animal organisms certain ones which are of peculiar interest or importance may be cited as examples.

The *carbon cycle* (Fig. 297) may be begun with carbon dioxide which the plant takes from the air or water and by photosynthetic processes builds into proteins, fats, and carbohydrates. The animal uses these as foods in building up protoplasm and as sources of heat and muscular energy. Carbon dioxide is expired into the air. The carbon compounds in other waste products and in the bodies of dead animals are decomposed, yielding carbon dioxide, which is added to the air, to be used once more by plants. Of all chemical elements carbon is the one which enters into the greatest number and variety of combinations, such combinations being particularly characteristic of living things. Organic chemistry, and particularly that portion of it known as biochemistry, is the chemistry of carbon compounds.

Atmospheric *nitrogen* can be utilized only by nitrogen-fixing bacteria (Fig. 298). When thus fixed, however, the nitrogen is in the form of compounds with other elements which may be used by any plant and be

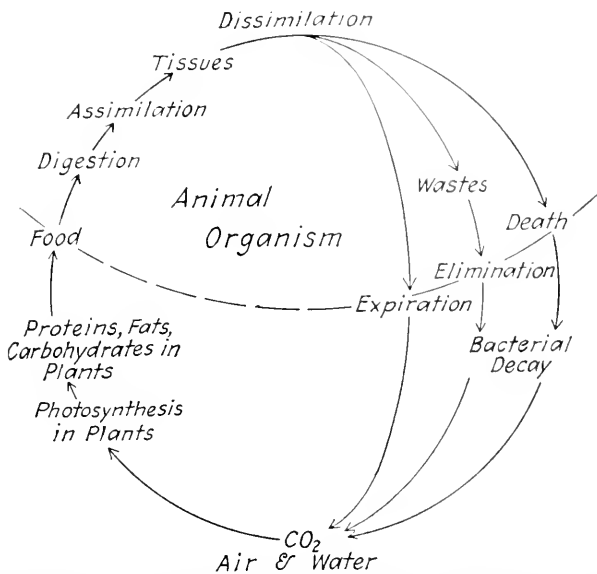

FIG. 297.—Diagrams to illustrate the carbon cycle in organisms. The steps above the line of dashes occur in the animal organism, those below outside of it and in part in plants.

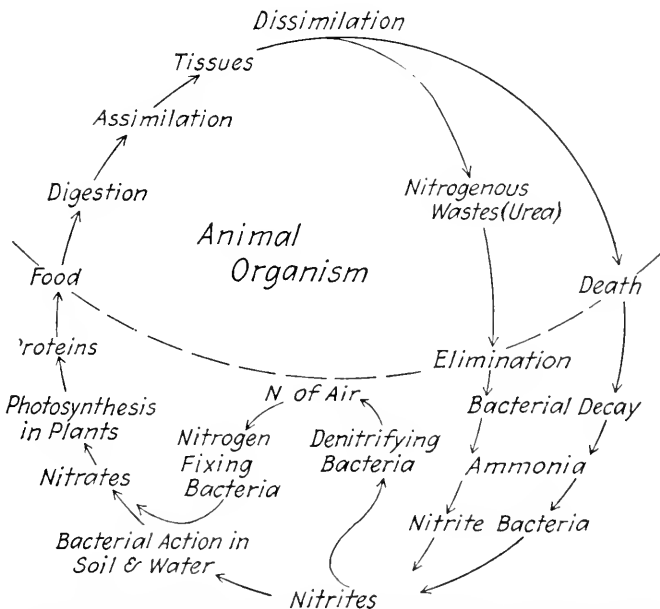

FIG. 298.—Diagram to illustrate the nitrogen cycle related to organisms and their activities. The steps above the line of dashes take place in animal organisms.

built into vegetable proteins. These vegetable proteins may be used by the animal organism which returns its nitrogenous wastes more or less directly to the soil and water, to be again utilized by plants. In contrast to carbon, nitrogen is one of the most inert of elements while in the animal organism.

Animals secure *oxygen* either directly from the air or from water in which it is in solution. After it is used in oxidation processes the organism returns the oxygen to the environment, largely in combination with carbon as carbon dioxide and with hydrogen as water. Carbon dioxide and water are in turn taken in by green plants which use the carbon and hydrogen and free the oxygen.

Phosphorus is an important element in animal cells, particularly in the nerve cells of higher forms. It occurs in the soil and water in the form of phosphoric oxides. Taken up by plants and built into certain proteins it is utilized by the animal, to be later returned either to the soil or to the water.

507. Water.—The constant need of every animal for water requires no demonstration. Water is important because of its various rôles in the metabolic cycle. It gives to living matter the proper consistency. It is the vehicle by which foodstuffs are brought to the cells of the body and by which wastes are removed; no substances enter or leave the cell except in the form of aqueous solutions. It enters into digestive processes involving hydration, such as the change of starch to sugar. These processes, however, are very limited when compared with the oxidations which occur in metabolism. Protoplasm contains a large amount of water, which makes up two-thirds of the human body by weight. The amount varies in different animals and in such an extreme case as jelly-fishes reaches 96 per cent.

For all aquatic organisms the water which bathes them is their environment. All natural waters contain salts in solution and the exact composition changes with a variety of factors, such as evaporation, rainfall, decomposition processes, and so on. Not only must an aquatic animal be adapted by the chemical composition of its body to the water in which it lives, but it must be capable of continual adjustment to these changes in composition. If an animal cannot so adjust itself, its only recourse is to encyst and await the return of favorable conditions or produce eggs or spores which can withstand the adverse conditions. Similar phenomena occur in response to extreme temperatures. To the cells in the metazoan body the fluids of the body are a comparable environment.

508. Digestion and Absorption.—Digestion in protozoans is intracellular and occurs in food vacuoles. In the ameboid forms these food vacuoles may be formed anywhere at the surface, but in more complex types a gullet admits the food to the body and the vacuoles are formed

at the end of it. In the sponges, too, digestion is intracellular. In coelenterates and ctenophores digestion is begun in the gastrovascular cavity and is, therefore, partly extracellular, but it is completed intracellularly; the same thing is true of flatworms, except in the case of cestodes, where a digestive system is entirely lacking. From the roundworms onward digestion takes place in the alimentary canal, is extracellular, and is caused by a variety of enzymes.

A number of the most important digestive enzymes have already been mentioned in connection with the different phyla. In the protozoans proteins form almost the exclusive food, though under certain conditions these organisms can utilize fats and starches. In passing gradually to the higher phyla the number of enzymes increases and the variety of foods which can be digested and absorbed also becomes greatly increased.

In mammals the stomach is largely mechanical in its function, though it also carries on digestion. It serves in many cases to hold a considerable supply of food, which is gradually reduced to liquid form, being changed to the consistency of thick pea soup, in which state it is known as *chyme*. The hydrochloric acid of the gastric juice serves to convert the pepsin-containing secretions of the gland cells to active pepsin, to create proper conditions for the activity of these secretions, and also to control the action of the sphincter muscle which guards the pylorus, the opening into the intestine, and which is normally in a state of tonic, or continuous, contraction. The acid inhibits the sphincter muscle, which dilates and permits a portion of the chyme to pass, after which the sphincter again closes and remains closed until the chyme in the intestine has become alkaline and that of the stomach has reached the necessary degree of acidity. Then the pylorus is again opened and another portion of the chyme is passed on.

In the intestine the chyme is slowly passed along by peristalsis. During the time that the chyme is in this part of the alimentary canal the amino acids and sugars are absorbed into the blood; the fatty acids and glycerin, into the lymphatics; and water, into both. The fatty acids and glycerin are recombined in the process of absorption, appearing in the lymphatics in the form of fats, changing the lymph to what is known as *chyle*.

It may be added here that the amino acids are taken up by the various cells of the body and are either used in growth or are immediately oxidized; the fats are also taken up by the cells and oxidized, releasing energy in the form of heat, or are stored; while the sugars are stored in the liver, to be passed into the blood and used, especially by the muscles, as needed.

509. Circulation.—Circulation takes place in protozoans only by currents within the cytoplasm. In sponges it is effected through the

middle layer, assisted by the wandering cells or by the passage of material from cell to cell. In coelenterates, etenophores, and flatworms the only circulation is that of food carried in the branches of the gastrovascular cavity and also passed from one cell to another. In the higher forms circulation is carried on by means of a blood-vascular system.

The circulating medium of lower animals up to and including the echinoderms is watery in character; in the annelids it is a *hemolymph* containing protein in solution; but in the mollusks, arthropods, and chordates it is *blood*, consisting of fluid plasma and corpuscles. In the blood of invertebrates and the lower chordates the cells in it are generally ameboid and are similar to the white corpuscles in the vertebrates. In the latter red corpuscles are also present. *Hemoglobin*, which is the main carrier of oxygen in the blood, is dissolved in the plasma of forms which do not have red blood corpuscles. In the mollusks and crustaceans there is another similar substance present known as *hemocyanin*. Instead of iron, which is an essential constituent of hemoglobin, copper is contained in hemocyanin. Some poisons produce their effects by dissolving the red blood corpuscles, a phenomenon known as *hemolysis*; this destroys most of the oxygen-carrying power of the blood.

The circulatory system is the transport system of the body, carrying food and oxygen, wastes of all kinds, and internal secretions from one point to another. The loss of the watery circulatory medium in lower animals is not serious, since replacement is easy, but injury to the blood vessels involving loss of blood is very serious to the higher types, in which replacement takes considerable time. They have, however, a safeguard in the *coagulation* of the blood. In the lowest animals which possess corpuscles this consists only of a massing together of the corpuscles at the point of injury, but later coagulation includes the formation of a clot which closes the injured vessels and stops the hemorrhage. The clot is composed of fibrin formed from fibrinogen, which is a protein in solution in the plasma. It is produced by the action of thrombin, which is in turn derived from the cellular elements in the blood. The precise nature of thrombin and the exact method of its origin are not known.

The pressure necessary to maintain the circulation in higher animals is due to the dilation of the arteries by blood forced into them by the heart, the elasticity and muscle tonus of the arterial walls, and the peripheral resistance due to the narrow capillaries. By *tonus* is meant that the muscle fibers are constantly slightly stretched and tense, which causes them to react more quickly when stimulated. This condition is partly nervous in origin.

510. Respiration.—Respiration is necessary to furnish the oxygen that the animal organism needs and to rid the body of waste carbon dioxide. The absorption of gases into the body and their passage outward both take place in obedience to the laws of diffusion of gases. Among

these is the *law of partial pressures*, which is that in a mixture of gases each gas exerts a pressure proportionate to the amount present and independently of the pressure exerted by any other gas which may be mixed with it. Since the oxygen pressure is higher in the air or water about the animal than in the body itself, oxygen enters the organism; and since the reverse is true in regard to carbon dioxide, this leaves the organism. Oxygen enters the animal body, as has already been noted, in a variety of ways. It may enter through the general body surface, as in the lower invertebrates; through respiratory papillae, or skin gills, and also through respiratory trees in the echinoderms; through gills in the higher aquatic invertebrates generally; through the tracheae in the insects; and through the lungs of terrestrial vertebrates.

The fact that most of the oxygen is transported by the blood in combination with hemoglobin as oxyhemoglobin has previously been noted (Sees. 270 and 348). It is also true that the greater part of the carbon dioxide is carried in combination with sodium oxide in the plasma as sodium carbonate.

It has been discovered that a large amount of carbon dioxide in the blood causes the oxyhemoglobin to break down more rapidly and thus liberate more oxygen in the capillaries for the use of tissues; while when the oxygen reaches a maximum, as in the lungs, the sodium carbonate is broken down more rapidly and carbon dioxide is set free at an increased rate, which hastens its expiration into the lung alveoli.

Under conditions where no oxygen is available many animals have been found to survive for a considerable length of time, apparently being adjusted to small oxygen consumption and being able to produce the necessary free oxygen from their own bodies. In the absence of oxygen about it an earthworm has been known to live one day; a planarian, from one to two days; leeches, four days; and an ascaris, from four to six days.

511. Secretion.—The secretions of various animal bodies are very numerous, are produced by a great variety of organs, and perform a large number of functions, both mechanical and chemical. Some secretions assume a solid form and furnish protection, connect structures, and give support to bodies; examples are bone, cartilage, connective-tissue fibers, chitin, and spongin. Others which become solid, such as silk and wax, are used by the animal in various ways, as in the spinning of cocoons by silkworms and the making of comb by bees. Watery secretions such as tears serve to moisten surfaces and prevent drying; in aquatic forms, as mucous skin secretions of fishes and amphibians, they prevent drying and infection by the spores which produce disease; or, as perspiration, they assist in temperature regulation. Some, such as digestive secretions, contain enzymes, and others, such as mammary secretions, provide nourishment for the young. The secretions of plant

lice are used as food by ants. Still other secretions contain scents which attract individuals of the opposite sex, repel enemies, and identify related individuals. Finally should be named the internal secretions, or hormones.

All animals produce secretions as the products of metabolism. These are in many cases accumulated in the cells as droplets or granules and are passed out when the cell receives the appropriate stimulus. Ferments may be thus stored in an inactive form, when they are called zymogen, and then be made active by some other substance; pepsinogen, for example, which is formed in the cells of gastric glands, is changed to active pepsin by the hydrochloric acid of the gastric juice.

512. Internal Secretions.—Among the metabolic activities of animals have been noted the production of a number of internal secretions, or *hormones*, which concern some of the most vital activities of the organism. It is presumable that these occur in a great variety of animals and are most numerous in the higher forms. They have been most studied in man and the higher vertebrates.

Among the organs which produce internal secretions in man (Fig. 299) is the *thymus gland*. This gland, which is situated anteriorly in the upper part of the thorax, produces a hormone which retards both development and differentiation. When the gland is overdeveloped the condition leads to a prolongation of immaturity and lessens the size of the organism. The *thyroid gland*, which usually consists of two lobes, one on each side of the trachea in the neck region, has an effect the opposite of that of the thymus. Its activity promotes growth and differentiation, resulting in large size and the early maturation of the organism. The secretion of the thyroid gland also stimulates the metabolic processes in the body and increases energy transformations. The secretion of the *adrenal organs*, above the kidneys and in contact with them, increases blood pressure and stimulates the body to more intense activity in cases of emergency. The *pituitary body*, lying at the base of the brain, is made up of two parts, the secretions from both influencing growth and differentiation. The secretion of the anterior portion increases particularly the growth of connective tissues and muscle, sensitizes the brain cells, stimulates the intellectual activities, and develops the memory. The secretion of the posterior part of the pituitary gland increases vascular tonus and magnifies the emotions. The *parathyroids* are glands situated at the sides of the thyroid or in some cases are included in it. The secretion of these glands increases calcium metabolism and has a regulating effect upon the irritability of the cells of the body. The pancreas is not only a gland secreting several digestive ferments but within it are masses of cells known as *islets of Langerhans*, the secretion of which controls carbohydrate metabolism in the body. The failure of these cells to function leads to a disease known as diabetes.

In addition to producing the sex cells the gonads are also organs of internal secretion, such secretions being produced by what are known as interstitial cells lying in the framework of the gland and not belonging to the germinal epithelium. The secretions of both the testis and the ovary influence the development of the respective sex characteristics; those of the testis affect sexual behavior in the male; and those of the ovary control the rhythm of sexual activity and are active in bringing

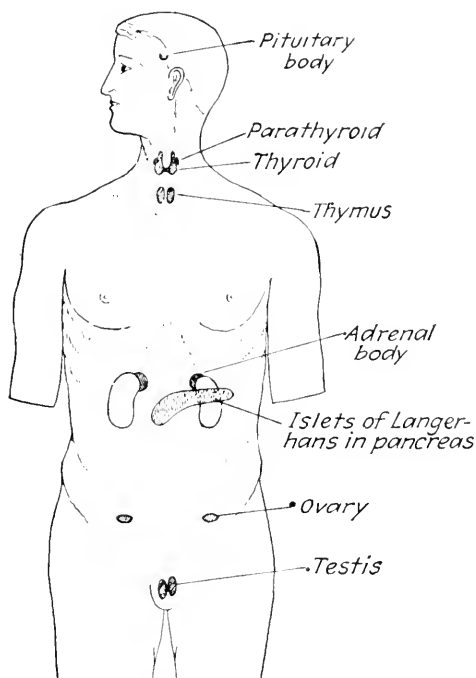

FIG. 299.—Diagram to indicate the location of the more prominent ductless glands in the human body.

about the attachment of the fertilized ovum to the wall of the maternal uterus.

Other glands produce internal secretions which affect *basal metabolism*. This term is applied to the metabolic processes that continue all the time in an animal, although it may be carrying on no digestive or voluntary muscular activity; they are involved in the circulation, maintenance of body temperature, and other vital processes.

513. Excretion and Elimination.—In the process of excretion liquid wastes are passed from all the cells of the body. The elimination of these wastes takes place directly from the cells which form them only in the lowest organisms; in higher organisms, as has been shown, organs and systems are set aside for this purpose.

In the protozoans excretion takes place in part into the *contractile vacuole*, whence the material is eliminated. In part, however, these wastes escape from the surface of the cell, in which case excretion and elimination are the same. Many protozoans also accumulate the wastes from metabolism in solid crystalline form in the protoplasm. The material that forms these crystals may be dissolved again and eliminated through the contractile vacuole or the wall of the cell. In the sponges and coelenterates excretion and elimination occur at the same time from the cells. In the echinoderms elimination is through membranes on the surface of the body or lining cavities within the body. There is also the curious form of elimination carried on by the amebocytes. In echinoderms, too, some excretions are stored as granules and crystals.

A variety of conditions has been seen in the worms. In the lower forms, such as the planarians, excretion takes place into the watery lymph between the cells and elimination, through the *flame cells*. In the higher worms, where a coelom is present, excretion takes place into the coelomic fluid and elimination is by means of *nephridia*, which are very varied in form and exhibit many degrees of complexity. There are also groups of cells in the coelomic epithelium which take up wastes, escape into the coelom, and then disintegrate, the wastes being passed out through the nephridial tubes. In the mollusks there are both nephridia, known as *pericardial glands*, and the cells formed from the coelomic epithelium. In the crustaceans are modified nephridia, forming what are known as *antennary*, or *green*, *glands*, opening on the basal segments of the antennae, and in some cases *shell glands*, opening on the bases of the second maxillae; elimination also occurs through the skin, the lining of the intestine, and the liver. In the insects the excretory organs are the *malpighian tubules*, which may be considered as being modified nephridia. In the vertebrates, however, three types of *kidneys* are found—pronephros, mesonephros, and metanephros—which have been previously described (Sec. 349).

514. Motor Functions.—Organisms can in most cases secure food only by moving about in search of it. Other conditions also necessitate locomotion, and so, even though many animals are sessile and some almost motionless, movement generally is a prominent feature in animal life. Movement has been seen to be of three general types—ameboid; ciliary, or flagellar; and muscular.

Ameboid movement, which has been noted in the rhizopods, results from a difference in consistency in different parts of the protoplasmic mass. The movements of *cilia* and *flagella*, which are similar, are the result of contractions of masses known as *basal granules* to which the cilia or flagella are attached. Since these granules are in pairs on opposite sides of the base of the cilium or flagellum, movement is produced in only two directions. In metazoans similar granules are connected to an inter-

cellular network of fibers which brings about coordinated movement among numbers of cilia or flagella. The reversal of ciliary movement is not understood. The existence of cilia in the early stages of the larvae of metazoans is of common occurrence and cilia are even retained as the locomotor organs in the adults of ctenophores, turbellarians, nemertines, and rotifers. In metazoans generally, however, since the increased size of the body makes ameboid movement impossible and ciliary movement ineffective, locomotion comes to be accomplished by movements of the whole body or by means of appendages developed for the purpose. At no time during life in nematodes and arthropods are locomotor cilia developed.

Muscular movement is the direct result of oxidation processes in the muscles. The oxidation, which takes place in a muscle after it has acted, is, however, a recovery process tending to build the organ up ready for the next contraction. This process involves the synthesis from carbohydrates of a complex and unstable compound which when the muscle is stimulated breaks down into simpler compounds. The result is to disturb the equilibrium in the cell to such a degree that there is a flow of cytoplasm and the contraction results. The protein part of the cell is not affected.

The contraction of a striated muscle fiber results from the sending in to the muscle of a number of stimuli close together. Such a contraction is termed tetanic, and its continuation gives rise to a condition known as *tetanus*. What is called tonic contraction and the condition already referred to as *tonus* (Secs. 240 and 509) is most marked in nonstriated muscles. No chemical changes take place in the muscle during tonus and therefore such a condition can be maintained without using up the resources of the cells. It is present particularly in the nonstriated muscle cells in the walls of the blood vessels and the alimentary canal. *Fatigue* of muscles is due in part to the accumulation of waste matters within the cell. A distinct nervous element is also involved.

There are in higher vertebrates both red and white striated muscles which seem to differ in several respects. The white muscles are more irritable and contract more quickly, while the red ones are less irritable, show a greater degree of contraction in tetanus, and maintain contraction longer.

515. Nervous Activities.—The basis of all nervous activity is the irritability and conductivity which characterize living matter as such. As has been noted in connection with the ameba, stimuli are varied in kind and the response due to each has received its own particular designation. The response may be positive or negative, maximal or minimal, or it may be given to an optimum degree of a stimulus. Among the Protozoa the functions of irritability and contractility are not separated, and the same cell both receives and responds to a stimulus. This is true

of the neuromuscular cells in the sponges, which are thus *independent effectors*. There are also muscle cells in higher animals which are independent effectors, responding directly to a stimulus. Such are the cells of the circular muscles of the iris the response of which is due to the presence of a light-sensitive pigment in the cells.

In the coelenterates have been noted simple *receptor-effector* mechanisms and the presence of a nerve net. The activity of these structures leads to responses which are nonspecific—that is, they do not differ with different stimuli. The responses follow no definite path, and the structures are autonomic—that is, independent, functioning when severed from the rest of the body. Such a mechanism does not show polarity, which is the property of transmitting impulses only in one direction, this being a property of a synaptic system made up of neurons.

The next step in the phylogenetic development of the nervous system is the development of ganglia, which results in the appearance of the *receptor-adjustor-effector* mechanism, or the reflex arc. Owing to the polarity which exists in neurons the character of any reflex act is predictable. At the same time there appear what are known as *conditioned reflexes* the result of which depends not only upon the appropriate stimulus but also upon a cerebral element, higher centers in the central nervous system either favoring or inhibiting the carrying out of the reflex act. At first the ganglia in different parts of the body are to a large degree independent of one another and only at certain times is their activity coordinated. As the nervous system becomes more highly developed in higher forms *centralization* appears, and then *cephalization*. Centralization and cephalization reach their highest development in the vertebrates, culminating in man.

Although centralization and cephalization have been carried to the highest extent in man, there still remain scattered over the human body a large number of centers controlling small groups of organs and governing certain acts which may take place independently of the will. Many of these acts, however, can with sufficient warning be controlled. Such centers, which are most numerous in the medulla, govern respiration, steady the beating of the heart, and control mastication, swallowing, sucking, the reflex secretion of the saliva and digestive juices, vomiting, coughing, sneezing, and winking. Numerous other similar centers are scattered up and down the cord and exist in outlying ganglia in the cerebral, spinal, and sympathetic nervous systems.

Sense organs, generally speaking, are known as receptors, but *sensations* are functions not of sense organs but of the central nervous system. The appropriate receptor, for instance, receives a chemical stimulus and sends an impulse to one or the other of two centers in the brain, which when stimulated gives rise to the sensation of taste in the case of one or of smell in the case of the other.

CHAPTER LXVI

BEHAVIOR OF ANIMAL ORGANISMS

Behavior, as already defined, is the sum total of an animal's movements. Reference has been made to various modes of behavior in connection with different phyla, but it is desirable to review the whole subject in one chapter. Before beginning the discussion, however, it may be said that no other subject in zoology invites so much speculation as does this and in no other is such a variety of opinions held.

516. Memory.—Memory is due to the persistence of some modification in a nerve cell resulting from its activity. Just what is the nature of such a modification is not known. In the lowest animal organisms the effect of a stimulus is exceedingly transitory, passing away in a short time. In a noncentralized nervous system, also, it does not persist for any great length of time, although it remains very much longer than in any one-celled organism. One of the characters of a centralized nervous system is a longer memory, and the development of the brain permits memory to last even throughout the lifetime of a long-lived animal. However, even in animals which possess a brain, the effects of stimulation may not remain long. What makes the difference is not exactly known, but one thing is clear and that is that the effect of a very marked stimulus remains for a greater length of time than that of one which is inconsiderable. It is also true that frequent repetition of the stimulus increases the duration of the effect. Association of ideas, too, tends to prolong memory. From what has been said it is evident that memory is the outgrowth of a property which, like irritability, conductivity, and contractility, belongs to all living matter, though it is only slightly developed in undifferentiated protoplasm. It plays a steadily increasing rôle in the different modes of behavior from the lowest to the highest.

517. Types of Animal Behavior.—The various types of animal behavior can be clearly interpreted only when studied in the light of the structure involved. When so studied six general modes of action may be recognized: direct response, simple reflex action, instinct, habit, intelligent behavior, and reasoning. These will be taken up in turn.

518. Direct Response.—This term has generally been applied to the type of behavior which involves action by the same cell that receives the stimulus. It is the mode of action of protozoans and sponges and is seen in the action of the endoblasts of the coelenterates, which are sometimes called independent effectors. All movement in the coelenterates,

generally speaking, is the result of direct response, since though the receptor and effector elements are distinct they are in direct connection. Coordination is through a nerve net and some localization of responses exists. In direct response there is to a considerable degree a correspondence between the strength of the stimulus and the vigor of the response, though this is subject to the effect of different physiological states—as, indeed, are all modes of behavior. Direct response is modifiable, the modifications depending upon the physiological state, antecedent stimulation, and attendant environmental conditions.

519. Simple Reflexes.—Simple reflexes may not be different in the general character of the action from a direct response but the mechanism

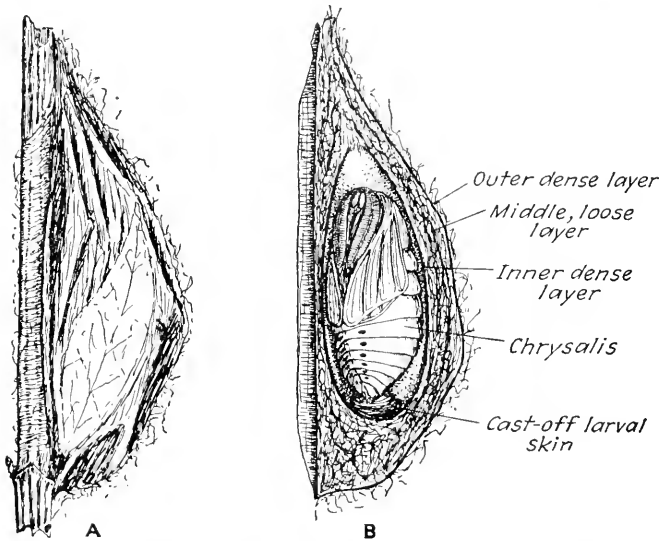

FIG. 300.—Cocoon of the silkworm, *Samia cecropia* (Linnaeus). A, external appearance. B, section to show construction. From a specimen.

involved is different, since receptors, adjustors, and effectors are all involved. The results differ in that the responses are distinctly more localized, and this adds definiteness and variety to the actions. This mode of behavior is first developed among the flatworms.

520. Instincts.—Instincts can best be defined as made up of associated and coordinated reflexes. It is clear from this definition that it is difficult to draw a sharp line between the simplest instinct and a simple reflex act, but in the most complex of instincts we have a very characteristic type of action.

The nature of an instinct may be well illustrated by a description of one which is very complicated, such as the spinning of a cocoon by a cecropia silkworm (Fig. 300). If one keeps a caterpillar of this species in a box, giving it fresh food daily, it is a very docile prisoner, eating voraciously and, so long as fresh food is regularly supplied, seeming to have

no desire to escape. As the time approaches for the spinning of the cocoon, however, there comes a day when the larva refuses to eat. It is now restless, traveling repeatedly around the box as if seeking some avenue of escape. At this period in the life history the caterpillars of many butterflies and moths show a change in color. The restlessness as well as the change in color indicate a change in physiological state. As if in response to this change the larva soon betrays a tendency to place itself in contact with as much surface as possible. It enters a mass of leaves or, in the absence of them, seeks a place where it can have a maximum of contact, as in the corner formed by three sides of the box. It then begins to spin, drawing the leaves close about its body and holding them in place by silken threads. This spinning continues until a layer of silk is formed which hides the larva from sight. Now the description must be finished from inferences drawn from the finished cocoon. When this outside layer is of a certain thickness something causes a change in the physiological condition of the organism, and, acting like a machine in which a lever has been operated, it suddenly ceases to add to the layer formed and begins to spin looser silk. Soon, however, another shift takes place and the caterpillar stops spinning this loose silk and begins to spin another dense layer of silk within. In this second dense layer the insect apparently uses all of its remaining supply of silk. This inner layer of the cocoon is then coated on the inside with a secretion which when it hardens makes the surface appear as if it had been shellacked. Its task done the caterpillar sheds its skin and becomes a chrysalis, protected by its cocoon until the time comes for it to emerge as a moth.

Examination of the cocoon brings to light several remarkable features. The outer layer of the cocoon seems to be a weather-resisting layer, though it is not waterproof; the loose layer seems to function in a way as a heat-conserving layer; while the inner dense coat appears as a second protective layer which is waterproofed within. Furthermore, the caterpillar has made provision for emerging, since at the end of the finished cocoon through which the moth will emerge each layer is loosely woven to provide an easy avenue of escape.

The spinning of the cecropia cocoon illustrates several of the salient facts in regard to instincts. (1) The instinct is manifested when a certain physiological state appears. (2) It is initiated in response to an outside stimulus. (3) It is an action involving many different reflex activities, all of which contribute to the one end. (4) It involves changes in action due to some internal change in the nervous system or to a changed physiological state in some part of the organism. (5) It involves time and space relations. (6) The capacity to exhibit the instinct is inherent and the instinct itself is clearly inherited.

Other facts about instincts are brought out by the spinning of this cocoon. One is the stereotyped character of the whole action. All

cocoons of this particular species are similar; they bear the stamp of the species just as clearly as does the adult insect. To one acquainted with silkworm cocoons that of each species is characteristic of the species to which it belongs. The caterpillar needs no teaching. The results are perfectly adjusted to the needs of the case. This adaptation of particular instincts to the particular conditions involved is so perfect that it has been likened to the relationship between the key and the lock which it fits. Yet it is clear that there can be no forethought or anticipation of results on the part of the animal. To many who are not students of animal behavior this perfect adjustment seems to prove the presence of intelligence.

Other striking instincts are concerned with the securing of food and with mating, nest-building, and other reproductive activities, especially of the arthropods.

From what has been stated it is clear that instincts are inherited and this inheritance seems to involve a certain structure in the nervous system. This structure has sometimes been referred to as an *action pattern*. It can be said that any particular animal inherits a certain action pattern which, when it is brought into play under proper conditions and by the appropriate stimulus, leads to results which are always the same for any individual belonging to the same species as the animal in question. Instincts as such are, therefore, not subject to modification unless they are involved in the process of evolution, for they have evolved in the same way as have the structural characteristics of the species and the other functions which depend upon these structures.

521. Habits.—Reference has been made to the development of habits in the starfish (Sec. 227) and in the frog (Sec. 399). To a certain degree a habit resembles an instinct and it is this resemblance which gave rise to the former impression that instincts are inherited habits and has suggested the idea that habits are lapsed instincts. The two, however, may be sharply separated in certain ways: (1) Habits are individual and not specific. (2) They are formed during the lifetime of the individual which possesses them. (3) They are not transmissible to the next generation.

A habit is acquired as a result of repeated action. This repetition may have to occur only a moderate number of times or it may need a considerable number. Nevertheless it is clearly the result of an action repeated many times under the same conditions, which has had such an effect upon the nervous system that, with the aid of memory, the action is again repeated when similar conditions arise. A habit may be gradually developed and gradually modified. It has some of the characteristics of an instinct in that it needs a certain stimulus to bring it out and that it frequently fits very perfectly certain conditions. At times habits will simulate instincts very closely but the two may be differentiated when other individuals of the same species are brought into comparison. The

individuality of the habit will then become apparent. Habits exhibited with instincts make it seem as if the instincts were subject to modification. However, the same test of comparison with other individuals may be applied to separate the habitual from the instinctive element when the two are combined.

522. Learning.—The fact that habit involves repetition and in this sense learning has led to its confusion with intelligence, but learning by repetition without an appreciation of cause and effect is not at all the same as the learning which accompanies intelligent activity.

523. Intelligence.—Intelligence on the part of an animal is the capacity to profit by previous experience. It is distinguishable from habit by requiring few if any repetitions for its development and by its free modifiability. Habits, though capable of modification, are modified slowly and by repetition, in the same manner as that by which they are formed. An intelligent animal, as opposed to one controlled by habit, changes its behavior quickly, adjusting it to the results of past experiences.

Intelligence is usually considered as involving (1) associative memory, (2) consciousness, and (3) ability to exhibit emotions and to feel pain and pleasure.

By *associative memory* is meant the ability to connect previous experiences with the results of such experiences—in other words, to appreciate cause and effect—and to profit by that ability. An insect acting only from instinct will persistently try to reach a certain opening even though beaten back time after time. An animal, like a dog, when guided by its intelligence, will, if beaten back, retire and endeavor to find another means of escape. *Consciousness* in the sense in which it is here used implies this awareness of cause and effect.

Emotions are somewhat difficult to define because different theories are held as to their nature. They are produced under certain conditions in the brain of intelligent animals, but they seem to be affected by conditions in other parts of the body. Especially is the production of certain emotions stimulated by the presence of particular hormones in the blood. The physiological state of the body predisposes the organism to anger or fear. Emotional conditions often have a controlling effect in the susceptibility of the body to pain, for an intelligent animal under great emotional excitement is insensible to injuries which under normal conditions would cause severe pain. This has often been noted in human experience. Three of the most primitive emotions are anger, fear, and love. These have their counterparts in instinctive activity, which frequently gives rise to confusion. We speak of the "angry bee" when undoubtedly the bee is actuated only by an instinct which leads it to defend itself or its home. An insect frequently flies as if trying to escape under the influence of fear, when it is only the instinct which is aroused by the sight of move-

ment. A spider defending its egg cocoon is actuated by an instinct and not by love.

Pain and pleasure do not seem to be felt by animals which have little or no intelligence. An injured dog will cry out in pain, loses its appetite, and in some cases seems to suffer as much from an injury as does a human being. Fish, however, after having been caught on a hook and then liberated with their mouths severely mutilated have been known to bite again immediately, as if feeling no pain from the wounds. Numbers of cases might be cited of similar insensibility to pain on the part of nonintelligent or slightly intelligent animals. In the same way pleasure seems to be associated with intelligence.

The only way to determine whether or not an animal is intelligent is to place it under experimental conditions. Then if it shows an ability freely to modify its behavior and this modification is in such a direction as to imply an appreciation of cause and effect, we may term the behavior intelligent. It is clear that intelligent behavior can never be stereotyped, and it is equally clear that intelligent acts cannot be inherited, although the quality of intelligence is.

524. Reasoning.—Theoretically it may be possible to draw a distinction between reasoning and intelligence, but practically such a distinction is difficult to apply. Perhaps the most obvious difference is that reasoning involves the ability on the part of an animal to form an abstract conception and be guided in action by it. An animal which after having had a certain experience successfully meets the same conditions when they occur again does not thereby evidence a power to reason; but if he so adjusts the results of a previous experience as to meet conditions somewhat different, this would seem to imply an ability to reason to the degree that differences exist between the two experiences. Reason enables an animal to meet conditions which it has never met before by the perception of analogies between them and conditions connected with previous experiences. Many stories are told of dogs, horses, and other mammals which seem to imply the ability to reason on their part. The capacity to dream may be taken as implying the ability to form abstract conceptions and as an evidence of the power to reason. Numerous instances of dreaming on the part of domestic animals have been recorded. Reasoning does not seem to have ever been attributed to animals other than the higher mammals, and in no other mammal is it so highly developed as it is in man. There is a tremendous gap between the reasoning capacity of the savage and that of the highly civilized man, but even the savage seems to be raised so far above other mammals by his capacity to reason that man as a type has been characterized as the reasoning animal.

525. Combinations of Modes of Behavior.—It is clear from what has been said that the actions of an animal may be the result of a combina-

tion of different types of behavior. A bird building a nest obeys a specific instinct and the nest is stamped by characteristics shared by all the nests of the species to which the bird belongs. At the same time, however, the bird may exhibit individual peculiarities in its construction which are the result of habit and may meet conditions that arise during its construction in such a manner as clearly to indicate the possession of some intelligence. Many published observations upon animals are confusing or inconclusive because to what degree different types of activity have entered into the act or the series of acts described has not been made apparent.

526. Behavior of Lower and of Higher Animals.—It is evident that the behavior of the lowest organisms is dictated by responses to stimuli received from the environment and it is equally clear that as the different phyla pass in review different modes of behavior appear. It is also true that as higher animals have acquired other modes of behavior they have not entirely laid aside those modes of behavior possessed by forms lower than they and that the progression from phylum to phylum up to the highest is a record of accumulation. Any higher animal may show all of the modes of behavior which the animals below it possess, as well, it may be, as a characteristic mode which sets it off as different from those which have preceded. Man, as the highest animal, exhibits all of the different modes. He shows direct response in the iris of the eye and simple reflexes in various parts of the body and exhibits a considerable number of instincts, which have by some been termed innate tendencies. He is also capable of acquiring habits, of using intelligence, and of exercising reason. A general principle is that higher modes of behavior are dominant over lower ones. An animal carrying out an instinct will fail to exhibit direct responses which have no relation to the instinct; intelligence enables an animal to control an instinct; and in man reason may dominate all.

527. Mind and Consciousness.—These terms are very often used but with varied significance, the application depending upon the point of view of the person using them. Mind and consciousness of a sort have by some persons been attributed even to inorganic matter and by others to plants as well as animals. Within the animal kingdom the line has been drawn at many levels. As has been seen, consciousness of a certain kind is associated with intelligence but it is clearly a question whether or not this is the beginning of consciousness. If one thinks of both consciousness and mind as attributes of life, then the conception of both as having been gradually evolved is a logical one. From that point of view both would culminate in man. As a matter of fact, when we compare the consciousness of the savage, who perhaps conceives of nothing beyond the mountain-enclosed valley which is his home and who entertains only

vague speculations as to physical phenomena, with the consciousness of the highly civilized individual, which not only encompasses the earth but reaches out to the limits of the universe, a gap exists which is greater than that between the savage and the animals below him. The consciousness of each individual human being expands with added knowledge and experience, and the same thing may be said of the mind.

CHAPTER LXVII

ANIMAL ORGANISMS IN RELATION TO THEIR ENVIRONMENT

ECOLOGY

That field of zoology which deals with the relations of organisms to their environment is called *ecology*. In other words, it is the study of the animal in its home. The field is not new, for it is practically equivalent to what has long been known as the natural history of animals, but the name is new and the exact methods of modern ecology are of very recent development.

528. Facts of Ecology.—Observation reveals a varied distribution of animal forms. In one locality with a certain character are found certain animals, while in another of a different character there is quite a different group. In fact there is no species of animal which is uniformly distributed. Not only is this true but it is a matter of common knowledge that the animals which are active at night are not those which are active in the daytime. The species of animals about us change from one season to another; birds come and go, and insects appear at their appropriate times. One who observes life from year to year finds differences both in the species to be found and in their relative numbers. The animals found associated in a certain type of locality, however, are usually associated together in any other locality of the same character, and so definite types of animal communities can be recognized. The study of the causes of these phenomena lies within the field of ecology.

529. Relations of Animals to Plants.—Early in this text (Sec. 68) the dependence of animals upon plants was emphasized. Directly or indirectly plants are the basis of all animal food and the capacity of any given region to support a large animal population depends upon the amount of plant food available. Plants, however, serve not only as food for animal organisms but also for shelter and concealment. For these reasons the plant life has a very important influence—and in many cases even a controlling one—over the animal life of a given area. It is difficult to study intelligently either plant or animal ecology without also studying the other, and for this reason the term *biota* is commonly employed in reference to all of the living organisms of a given area, including both plants and animals. Owing to the fact that few plants possess the power of locomotion, plant ecology presents fewer difficulties than does animal ecology and has not only preceded animal ecology in

time but has excelled it in the development of methods and in the definiteness and certainty of its conclusions.

530. Physiological Life Histories.—The life histories of animals have been referred to many times but always with particular reference to the structural changes which the animal passes through in its development. The life history of an animal may be viewed from another aspect, and that is as controlled by its physiological reactions. This aspect of an animal's life history belongs to ecology. Shelford has enumerated five types of physiological life histories. One is that in which the annual cycle and the life-history cycle agree and in which the life history occupies but one year. A second is that in which the development of the animal occupies two or more years and the adults are produced at such intervals. Usually broods of insects appear every year, but in some cases many years may elapse between broods in any particular locality. In the seventeen-year cicada, seventeen years intervene between the appearance of the adults of one generation and those of the next. In a third type the adult lives over a number of years and reproduces a number of times. This is generally true of higher forms. A fourth type includes those animals in which there are a number of generations in each year. The fifth and last type includes those which reproduce continuously and either at a uniform rate because of uniform conditions or at different rates under varying conditions. Included in this group are certain plankton organisms which live where conditions are nearly uniform throughout the year.

531. Habitat.—The particular locality in which any one species of animal is found is known as its *habitat*. Some animals are capable of occupying several habitats, affording, perhaps, a variety of conditions; others are very narrowly restricted in their choice. Perhaps the most narrowly restricted of all animals are parasites that can live only in a certain part of the body of a particular species of animal. There are, however, many free-living forms which can live only under a very precise set of conditions which are rarely found. Generally speaking, aquatic animals cannot adjust themselves to life outside the water, although there are those which make brief excursions outside their aquatic habitat or which can remain living for some time when deprived of water. Examples of such types are the animals living above low tide or the many animals of ponds and rivers which have to endure periods when the body of water in which they live becomes dry.

The inability of a plant to move, generally speaking, forces it either to live or to perish in the habitat in which the seed germinates. It is thus possible for botanists to study the reactions between plants in any given habitat and to define very exactly the composition of plant communities. However, the mobility of animals and the different reactions they display at different times in their physiological life histories present difficulties

in the precise definition of animal communities which zoologists have hitherto been unable to overcome. The seashore affords examples of rather definite and stable animal communities, but such communities are to a lesser degree characteristic of fresh water and are rarely found in terrestrial environments.

532. Ecological Factors.—The factors in the environment which affect animals most strongly may be enumerated under two heads: physical and biotic.

Among the *physical factors* are the presence and composition of water, temperature, light, and molar agents, such as wind and currents. The chemical composition of water involves salts which are more or less ionized (Sec. 17). This results in an increase in alkalinity or acidity. A measure of this ionization is the acidity corresponding to the number of hydrogen ions present in a given unit volume of a solution, indicated by the symbol pH (potential hydrogen). A pH concentration indicated by 7 corresponds to neutrality. Any concentration indicated by a larger number implies alkalinity; by a smaller number, acidity; and the amount of departure measures the degree of either alkalinity or acidity. It has been found in the case of certain organisms that the pH concentration of water is a very important factor, but in the case of others it seems to have little or no effect. The pH can be determined not only for bodies of water but also for soils containing water and for body fluids.

The *biotic factors* in the environment relate to plants and to animals of either the same or other species and affect the organism in such ways as through food supply, competition, mutual help, as in animal communities, and the relations of the sexes.

533. Reactions of the Animal.—In response to these various factors of the environment, reactions take place within the body of the animal which find expression in form, size, and color; in the physiological adjustments which the animal makes; in its behavior; in its mode of reproduction; and in its length of life. Ecology should concern itself fully as much with the reactions within the animal itself as with the conditions of the environment in which it lives and to which it reacts, though up to the present time investigations have dealt largely with the latter aspect.

534. Communities.—As has been stated above, animals present themselves in communities which may vary greatly in extent. A pond or lake is in a sense a great community of aquatic organisms, but within this environment are many lesser environments such as the shore, beds of aquatic vegetation, the surface, and the deeper portions. Each of these smaller parts of the whole has its peculiar animal types. The character of the vegetation, differing in different areas, may directly affect the character of the community of animals found in each. In bodies of water of any considerable depth, as well as in the vegetation in the case of terrestrial forms, there is the phenomenon of *stratification*. Certain

animals in forests are restricted to the ground; others, to the lower vegetation; others, to shrubs; while still others reach the tops of the tallest trees. These may be considered as separate communities. Thus the number of possible community relations becomes great and an animal may belong to a small community unit and at the same time be a member of several larger units differing in numbers and areas of distribution. The precise limitation of such communities, however, is made difficult by the freedom with which animals migrate from one place to another, since some animals may be members of different communities at different times of the day or year, under different weather conditions, or during the different periods of their lifetimes.

In any given animal community there is a *food cycle* or a food chain. We find a starting point in such a chain or cycle in the plant life upon which herbivorous animals feed. These in turn are devoured by carnivorous types, and through the metabolism of the animal or its ultimate death the materials of the body are returned to the environment, again to be used by plants. It is rarely, however, that food chains can be expressed in such simple terms. Thus in a pond the decaying organic matter is utilized by bacteria. These in turn are eaten by certain small protozoans which form the food of larger and more complex ones. The protozoans may be eaten by rotifers, crustaceans, and other animals, which in turn form the food of aquatic insects. The smaller fish feed upon these insects as well as upon other forms, and they in turn are eaten by the larger predatory fish. From these fish the food cycle may, within the body of water, return to the stage of decomposition and decay; but since these larger fishes are eaten by a variety of animals outside the water, the cycle may not be completed within the aquatic environment.

In nature a *balance* is often developed within a given environment which results in a very stable condition. Such a balance, however, does not long remain. Changes ensue which cause it to be disturbed, and so constant readjustments are necessary. Readjustment may result in a balance at a new level, but usually such changes are progressive, and thus the successive states of balance are not permanent but merely steps in a process which forms an orderly sequence and leads to a definite end.

535. Succession.—The series of readjustments which have just been referred to result in what has been termed *biotic succession*, which is a term applied to the progressive changes in the composition of a fauna and flora that ensue because of modifications in the environment. For instance, if an area of land is denuded of all vegetation certain pioneering plants will appear first in the process of restoration. These in turn will give place to others, and this will continue through a series of vegetative changes. The process ultimately leads to the establishment of a permanent grassland or forest. With the vegetation changes which have occurred there are corresponding changes in the character of the animal

life, especially involving the forms most dependent upon vegetation, and thus there follows a succession of animals represented by more or less clearly defined stages and ending in a practical balance.

The glacial lakes of the northern part of this country have exhibited a definite series of changes which may be likened to the periods in the life of an organism and permit us to speak of any particular one as a young

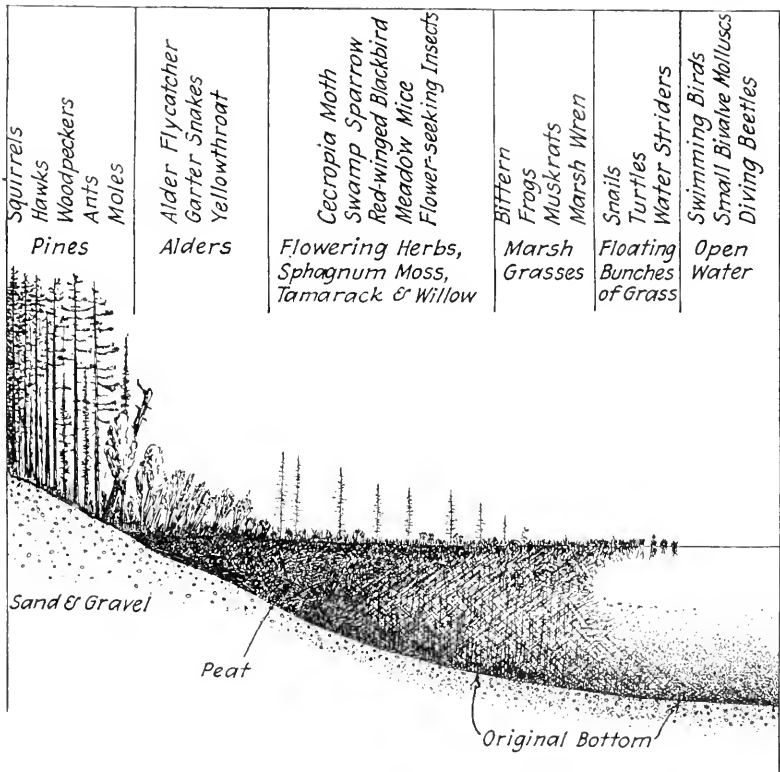

FIG. 301.—Diagram to illustrate succession in a bog lake which is advanced in the process of being filled in. The grading in the shading under the open water indicates the loose, flocculent deposit which at the top offers no resistance to penetration by a pole or other object, but which becomes more and more dense as the bottom is approached. The animals in each zone are represented by only a few types selected to show variety.

lake, a lake of middle age, or an old lake. At the beginning of this process the lake has clean sand and gravel bottom and shores. Later plants appear and by their growth, death, and decomposition, and by the washing of soil into the lake, there are gradually developed deposits of mud and vegetable mold on the bottom or in quiet places along the shore. Sand and gravel are then left exposed only on beaches where combined wind and ice action prevent the accumulation of either vegetation or mud. In time, however, there is built out from the shore a mass of vegetation which produces a bog or marsh; at the same time the lake

is filling up from the bottom. As the shores become firm the bog and marsh plants give way to shrubs and trees, and ultimately a forest may cover the area earlier occupied by the lake. In some cases grasses may become so firmly established that the forest is unable to enter, and then the lake is represented by a grassy area of flat prairie surrounded by forest. With all these changes it is inevitable that there should be a corresponding succession in the types of animal communities (Fig. 301). Corresponding periods may be observed in any permanent body of water.

In addition to such succession as has been referred to and which involves long periods of time there are annual, or seasonal changes, which take place at intervals during the year and are more or less dependent upon the season. In the tropics where conditions are very uniform there are no marked seasonal changes. In the polar regions, too, where conditions change with relative abruptness from winter to summer and back to winter again, there are no marked seasonal gradations. In the temperate zone, however, where the four seasons are of more nearly equal length and the transition from one to another is gradual, definite and orderly seasonal changes take place.

536. Rhythms.—Somewhat similar to succession are the rhythms that present themselves in animal communities, as a result of which many of the animals belonging to that community never meet. Among these rhythms is the night and day rhythm, as a result of which the animals which are active during the night form a group distinct from those active during the day. This is most strongly marked in deserts, where the conditions between night and day are most different. There is no night fauna in the polar regions because there the night is too cold to permit any activity. Night faunas are, on the other hand, exceedingly rich in the tropics where the heat of the day enforces quiet on animals and the night is the time of maximum activity. Other rhythms are those seen along the seashore and connected with tidal currents and those, in the case of terrestrial animals, involving dry and wet weather.

It has recently been recognized that the abundance of many animals varies over a period of years in a rhythmic manner, and these rhythms seem to be related to predatory enemies and disease producing organisms. As an animal increases in abundance its enemies also increase; when its numbers reach a maximum these enemies gather in maximum numbers, epidemics of disease develop, and the animal may be so reduced in numbers as to become scarce. This results in a reduction of the enemy forms, which affords the animal the opportunity again to increase. However, many years must pass before it can regain its former numbers. Then the process is repeated.

537. Marine Faunas.—When one takes up the subject of faunas he finds himself on a border line between ecology and zoogeography. The modifications and the adjustments which marine animals show to varying

environments within the sea are, properly speaking, ecological phenomena. A discussion of marine faunas (Fig. 302) in detail or of the animal communities of the sea is impossible here but a few statements may be made. The conditions met by animals living between high and low tide marks vary so that these animals find life very difficult and have to make many adjustments. Shifting beaches are unsuitable for many forms which are abundant on permanent rocky shores. The fauna of mud flats consists largely of burrowers. Pelagic forms show adaptations making it possible for them to float and swim, and these affect the form of the body, its structure, and the development of special organs. Such animals, particularly if they are plankton forms, are characterized by transparency and delicacy of color. The bottom forms of the sea exhibit

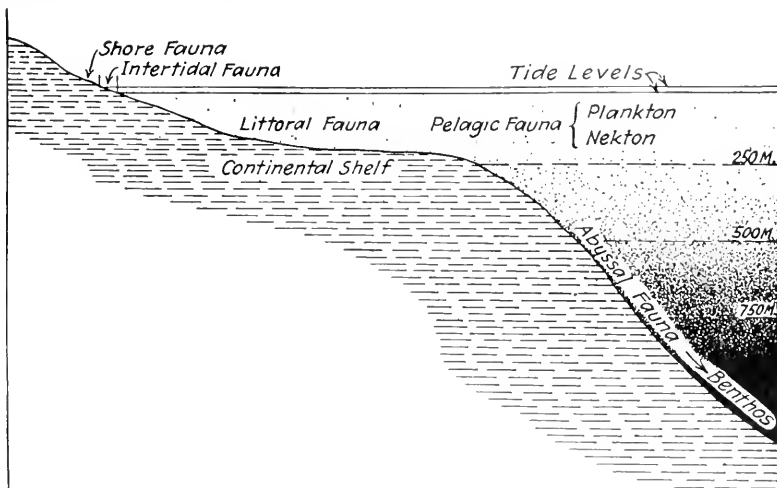

FIG. 302.—Diagram to show distribution of animal life in the seas. The light is shown fading out with increasing depth and ceasing entirely at 900 meters.

many adjustments, including the presence of stalks to raise the sessile forms above the mud, the development of long legs on the part of walking forms, the production of few and large eggs, and other adjustments permitting the parent to carry the young about and to protect them. Even such deep-sea animals as echinoderms carry their offspring about during development and until they are able to shift for themselves.

The fauna of the sea in general has been divided into (1) the littoral fauna, found along the shores, (2) the pelagic fauna, occupying the upper levels away from the shores, and (3) the abyssal fauna, living in the depths of the sea. The pelagic fauna is divided into the *nekton*, which includes all the larger forms, that are able to control their own movements, and the *plankton*, which includes the smaller forms, that are at the mercy of the currents and the movements of the waves. The bottom forms in the depths of the sea are called, collectively, the *benthos*.

538. Fresh-water Animals.—Fresh-water animals show a variety of adaptations to permit swimming and respiration in water and to meet periods of drying and freezing. Animals in rapidly flowing streams develop organs for attachment, including suckers and hooks on their legs, while the larvae are often protected by cases in which they live.

Lakes of considerable depth show in the winter a circulation involving all of the levels, but in the summer a body of cold, stagnant water remains below while above it is a surface stratum of water acted upon by wind and currents which produce a constant circulation (Fig. 303). The plane separating these two bodies is known as a *thermocline*. It is established in the spring and destroyed again in the fall when the surface stratum falls to a temperature less than that of the water below, in consequence of which an overturning and a thorough mingling of the two strata take place. The conditions below the thermocline, particu-

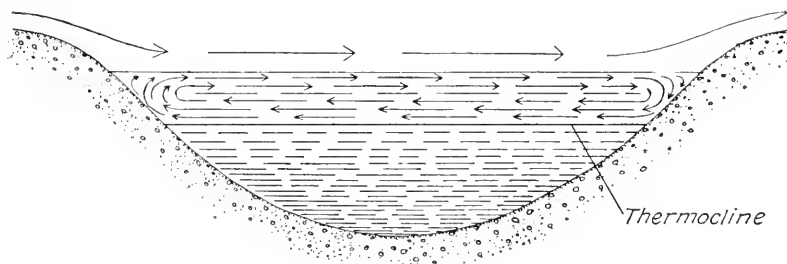

FIG. 303.—Diagram to illustrate the facts in regard to a thermocline. The arrows above the water show the direction of the wind; those in the lake above the thermocline show the circulation currents in the water. Below the thermocline the water is stagnant.

larly the low temperature and the small amount of oxygen, make possible the existence of only a limited fauna.

539. Terrestrial Faunas.—Owing to the great variety of conditions which exist, terrestrial faunas are more varied than those of either the sea or fresh water. Such faunas include subterranean forms which are influenced by temperature, moisture, degree of aeration, and the chemical composition of the soil. Certain types of animals are restricted to the surface of open ground or the floor of the forest. Still others live at various vegetational levels depending upon the character of the vegetation. Finally, there are the aerial types, which are capable of flight. In terrestrial faunas should be included the cave faunas, among the members of which there is a tendency toward the loss of eyes, color and organs of flight, while their senses of touch and hearing become very acute. Animals of desert faunas are active mostly at night, so as to escape the heat of the day; frequently develop the power of rapid locomotion; show numerous cases of adaptive coloration; pass off dry excretions so as to conserve water; and generally exhibit a low rate of reproduction.

540. Mimicry and Protective Resemblance.—What is essentially an ecological phenomenon, since it involves adjustment to the environment,

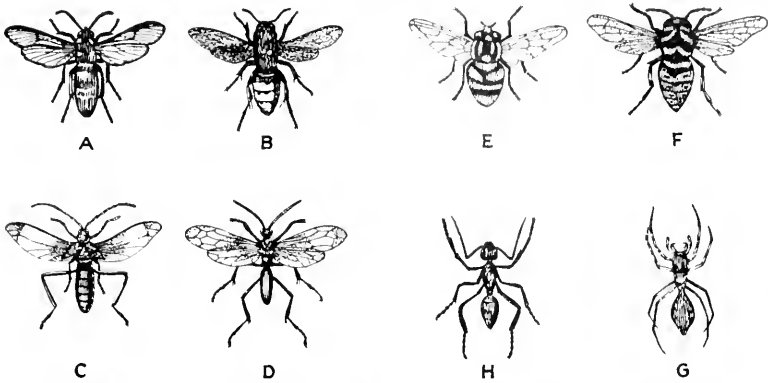

FIG. 304.—Mimicry. Several cases of resemblance between animals of different groups, one of which is said to mimic the other. *A*, a clear-winged moth which resembles a wasp, *B*. *C*, a beetle with very short elytra which resembles a wasp, *D*. *E*, a fly which resembles a wasp, *F*. *G*, a spider which resembles an ant, *H*.

is that of color and form in animals as related to surrounding objects. *Concealing coloration* is a color possessed by the animal which makes

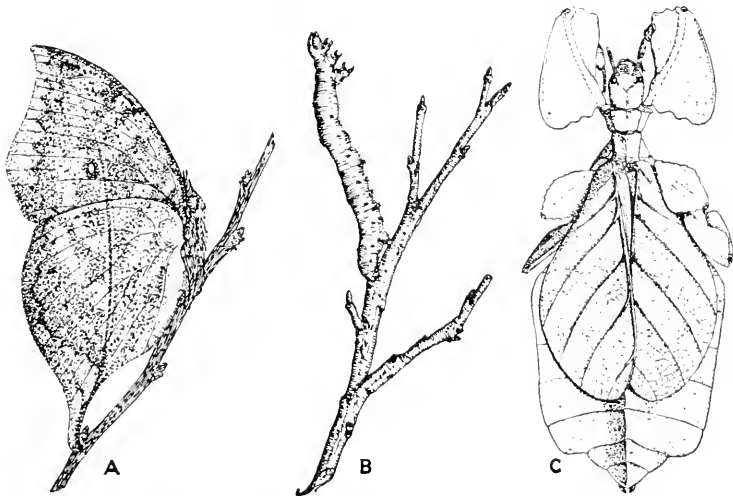

FIG. 305.—Protective resemblance. *A*, the leaf butterfly of India, *Kallima* sp., which when resting upon a twig resembles a dead leaf. *B*, a lepidopterous larva, which assumes a resting attitude in which it resembles a twig. *C*, a leaf insect of South America, *Phyllium* sp., which belongs to the walking sticks, and which resembles in form and color an assemblage of leaves. (*A* and *C* from specimens; *B* redrawn from Jordan, Kellogg, and Heath, "Animal Studies," by the courtesy of D. Appleton & Company.) All $\times 2_3$.

it invisible against the background of the environment. It is evident that concealing coloration would be useful both to a nonpredatory animal

seeking to escape its enemies and to a predatory animal seeking to approach its prey. *Warning coloration* is believed to be of value to the animal because of the immunity it affords from the attacks of enemies. *Recognition colors* are those possessed by an animal which enable it to be recognized by others of its race or by the other sex. *Mimicry* (Fig. 304) involves both color and form but the resemblance is to some other animal and not to features in the environment, which is termed *protective resemblance* (Fig. 305). Many edible insects are believed to mimic those which are inedible and in that way secure immunity from the attacks of enemies. Caution must be used, however, in the citation of cases of mimicry and protective resemblance and in the drawing of conclusions as to the significance of the resemblance.

CHAPTER LXVIII

ANIMAL ORGANISMS IN HEALTH AND DISEASE

A very practical application of animal biology is in the development of an understanding of health and disease. The principles involved are of general application to all animals, but since we are more concerned with health and disease in man and more is known of human diseases than of those of other animals, any discussion of this subject will inevitably have a strong human emphasis.

541. Definitions.—If an organism is in perfect adjustment to its external environment, and in case it is a metazoan, if the cells which compose the body are perfectly adjusted to the conditions within it, then theoretically the organism will be carrying on the activities of life with the maximum degree of ease and effectiveness. Such a condition could be referred to as one of *ideal health*. If, on the other hand, there is any departure from that condition so as to interfere with the carrying on of such activities even in slight degree, the condition might be termed one of *disease*. Perfect adjustment, however, either external or internal, is rarely if ever encountered. To all organisms life involves a constant struggle to reach an adjustment sufficient to avoid a serious interference with the performance of bodily functions. Therefore, for practical purposes *health* is defined as the existence of such a condition of the organism as permits it to carry on all functions in a normal fashion, though it may be not to a maximum of effectiveness. *Disease*, on the contrary, is the existence of a condition which interferes with such normal functional activity. With reference to ourselves, we ordinarily overlook little troubles in various parts of the body, such as mild headaches, slight disturbances of digestion, and other small ills which appear to us of little consequence, and consider ourselves well in spite of them.

542. Health in a Protozoan.—The protozoan, a frequent environment of which is the water in which it lives, needs for healthful living food of the right kind and in the necessary amount. It also needs to be perfectly adjusted to the environment about it so that there will be no interference with the interchange of material between itself and the water, including respiration and the prompt elimination of waste. Given these conditions the presumption is that normal metabolic activity will be carried on and that the protozoan will continue to live a healthful life. Most one-celled organisms also need a certain amount of light, have an

optimum temperature, and if not aquatic must have a certain amount of moisture, all of which conditions should be added to those which make for healthful living.

543. Comparison of Protozoan and Metazoan Cells.—The cells in the body of a metazoan are related to the body fluids in the same manner as are the one-celled organisms to an aqueous environment. Though there are cells on the surface which are not surrounded by these fluids they must be related in some way to them in case they are to remain living. The deeper cells of the human epidermis, for instance, are in contact with blood vessels and with lymph, but as they are carried toward the surface by the multiplication of cells below them, they lose this contact, become dead, change in form and composition, and are finally cast off. The surface cells of other animals are protected by a cuticula which they secrete, by slime, or in some other fashion. Within the body the health of the individual cell rests on much the same conditions as does the health of the one-celled organism. Each cell must be provided with the proper kinds of food and in the proper amounts, must be freely supplied with oxygen, and must have its waste quickly removed. Each cell must also have the proper environment maintained, including an appropriate temperature, especially in the case of warm-blooded animals. Light is a factor in the health of most animals, as are also a great variety of internal secretions, especially in the higher forms. Since the health of a metazoan is necessarily the resultant of the health of the different cells which make it up, anything that interferes with the health of any of the cells of the body produces a condition of disease, though it may be local in character.

544. Conditions of Health.—From what has just been stated it is clear that four conditions are necessary for the maintenance of health:

1. Proper kinds and amounts of *food*.
2. Maintenance of normal *metabolic activity*.
3. Prompt and complete *elimination of waste*.
4. A proper *physical environment*.

545. Causes of Disease.—The causes of disease are not alone the converse of the conditions of health, although this is true of the first cause here enumerated. These causes may be named as follows:

1. *Wrong Living Conditions.*—These conditions involve food, air, sleep, exercise, metabolism, elimination, and internal secretions.

2. *Inheritance.*—In certain cases a disease may be actually inherited; this is true of syphilis. In other cases, however, the inheritance involves not the passing on of the disease but the passing on of a weakened constitution which predisposes the individual of the next generation to that disease; this is true in the case of tuberculosis.

3. *Traumatism.*—In a popular sense traumatism is synonymous with the term accident, but it is, properly speaking, a somewhat more inclusive

term, since it would include the results of any overactivity or strain leading to abnormal conditions in the body.

4. *Infective Organisms*.—Infective organisms comprise both plant and animal parasites which cause disease either by depriving the organism of something which it needs or by the creation of wrong living conditions, including the development of poisons, in the body of the host.

546. Effect of Individuality.—The individual character of the organism has a decided effect upon the susceptibility to disease. Naturally this individuality may be a matter of inheritance but it also may be an acquired characteristic. Particularly is this seen in the way individuals react to articles of food. Some persons are unable to eat certain foods, as, for example, acid fruits and the yolk of eggs, although to most people the same foods are entirely innocuous. This individuality also affects the responses which the body gives to certain drugs, and the degree of toleration shown by different individuals toward drugs must be taken into consideration in the treatment of disease. Any such peculiar and individual responses to food or drugs are often known by physicians as *idiosyncrasy*. It may be a form of allergy (Sec. 551).

547. Self-regulatory Tendency in the Body.—A one-celled organism subjected to modifications of its environment changes in such a way as to adjust itself to the altered environment or, if it cannot meet the changes, protects itself against them by encystment. In the same way the cells of a many-celled organism tend to adjust themselves to changed conditions within the body or, if they cannot so adjust themselves, resort to certain means of protection from those conditions. These means sometimes involve such extreme measures as the dropping off of a portion of the body, or autotomy. A self-regulatory tendency is very fortunate for man as well as for other organisms, since through it an animal will of itself tend to regain its health when subjected to conditions that cause disease, even though no assistance is given from without.

548. Toxins and Antitoxins.—The living of one organism in the body of another may impose certain hardships upon the latter. In addition to its own wastes the body of the host must eliminate the wastes produced by the other organism. Of course, if the relationship is one of symbiosis the elimination of these wastes does not impose a hardship sufficient to counterbalance the advantage accruing from the relationship, but in the case of a parasite this may be a serious strain upon the host. Whenever these wastes act as a poison in the body of the host they are included under the general term of *toxins*. This term, however, also includes all other poisons which may be introduced into the body, whatever their source.

To any such poison, either elaborated within the body by some parasitic organism or introduced into the body in any manner, the body reacts by producing a substance which tends to neutralize the poison

and which is known as an antibody, or *antitoxin*. Such a substance is produced by the body in response to the presence of any foreign chemical substance and is part of the self-regulatory function of the body by which it can adjust or defend itself. By neutralizing the toxins, the antitoxins safeguard the body cells against injury and give time for the body to eliminate the cause of the disturbance. Since the response to each toxin is specific, a different antitoxin is produced for each one.

549. How the Body Fights Disease.—One method by which the body fights disease is, as has already been indicated, by the production of antitoxins. Another way is through the activity of the white blood corpuscles, or leucocytes. A leucocyte is an ameboid cell which shows a tendency to take into its body other organisms and other materials in the same fashion as an ameba takes in bits of food. Normal body cells are not attacked by the leucocytes, but cells in the body which become abnormal or which are injured, or foreign cells of any kind, are taken up by them and destroyed. When thus taking in other cells they are termed *phagocytes* (literally, eaters of cells). Phagocytes are active in the destruction of certain cells in the body when the absorption of tissue is desirable. For example, they play a part in the absorption of the tail of a tadpole when it changes into a frog. When injury results in the death and destruction of cells in the body, the phagocytes attack the dead and injured cells and by destroying them and clearing away cellular debris pave the way for normal regeneration and the return of a healthful condition. They are also active whenever disease-producing organisms enter the body. Attracted to the place of entrance of these infective organisms, apparently in response to the unusual chemical stimuli due to the invaders, the phagocytes ingest and destroy them. If the number of invading organisms is not great, the phagocytes may in this way safeguard the body against the onset of disease. If, however, the invading organisms are so numerous at the point of infection that the leucocytes are unable to cope with them, then enough tissue may be broken down to cause the formation of a pus cavity, or abscess, and the leucocytes become *pus cells*.

550. Immunity.—Immunity may be defined briefly as the absence of susceptibility to disease. It may be of three kinds: natural, acquired, and artificial. Acquired immunity may also be inherited.

Natural immunity is possessed by an animal because of the character of its body. Many animals are naturally immune to certain diseases to which others are susceptible. More or less immunity to some diseases is possessed by certain human races; for example, the Jewish race is very resistant to tuberculosis, while Negroes and the Irish are particularly susceptible to it. There is also age immunity, adults being generally free from so-called children's diseases.

Acquired immunity is the immunity which an animal enjoys by virtue of having had a disease and having built up such a power of resistance as makes it immune to succeeding attacks. To many infectious diseases the human body develops resistance by the formation of antitoxins at the time of the attack and by their continued formation afterward. Thus conditions in the body are made unsuitable for the development of the disease organisms should they again gain admission. This acquired immunity may last for only a certain time or it may persist throughout life.

In some cases individuals not naturally immune to a certain disease may become so and may pass this immunity on to succeeding generations. This may be termed *inherited immunity*. For instance, the child of a mother who has had smallpox during the time when she was carrying the child inherits the immunity acquired by the parent.

Artificial immunity is an immunity produced by artificial means; there are several ways in which such immunity may be secured. (1) One is by introducing into the body living but weakened cultures of the infective organism. A mild attack of the disease is produced which immunizes the body against a serious attack, which would result from the entrance of virulent organisms. An example of such an artificial immunity is that resulting from vaccination for smallpox. The reaction to the vaccination is ordinarily not serious and results in immunity to the disease itself. Immunity to rabies may also be produced in this way. (2) Another method is by the introduction of virulent cultures in small doses which the body can successfully withstand and as a result of which it will build up an immunity to more serious infection. This mode of securing artificial immunity has been practiced in the case of cholera and bubonic plague. (3) Immunity against typhoid fever is secured by the introduction into the body of extracts containing the dead bacteria. Responding to the presence of these extracts, the body builds up the appropriate antitoxin and thus safeguards itself against disease due to the introduction of virulent organisms of the same kind. This is the method now used in immunizing to plague and cholera. (4) Still another way of securing artificial immunity is by the introduction of an antitoxin developed in the body of another animal. The organism that causes diphtheria in man, when grown in an artificial culture, will produce a toxin. This may be introduced into the blood of a horse and the horse, in response to its presence there, will manufacture an antitoxin. The serum from the blood of the horse containing both the toxin and antitoxin may then be injected into the body of a person and will not only confer immunity but will tend to stop the disease if it has already been initiated. The same type of procedure is followed in the case of scarlet fever, but in tetanus the antitoxin alone is introduced.

Many other toxins as well as infective organisms may be combated in the body by the development of an appropriate antitoxin, which when

injected protects the body from the effect of such agents. *Autogenous vaccines* may be prepared from a person suffering from an infection and given to him to combat the infection.

551. Anaphylaxis and Allergy.—*Anaphylaxis* may be defined as an exaggerated irritability of the body with respect to some foreign substance. It may follow a case of mild poisoning by the substance concerned and is associated with the eating of a great many foods, particularly proteins and sea foods. A person may have eaten such a food freely and without evil effects until, under certain conditions, poisoning occurs. If thereafter, whenever the food is taken, the body shows a pronounced reaction, a case of anaphylaxis exists. *Allergy* is a similar exaggerated susceptibility to contact with dust, the pollen of plants, and hairs or other particles from the bodies of animals. Hay fever is such a condition. The word allergy is sometimes used in a more general sense to include anaphylaxis and immunity, thus referring to any altered response of the body to foreign substances of any kind.

552. Maintenance of Health in Human Beings.—Many of the conditions which are necessary to maintain the body in a state of health may be inferred from statements made earlier in this chapter. The field of investigation which deals with the effect of conditions within the body upon health is called *hygiene*; when conditions outside the body are involved, it is spoken of as *sanitation*. Preventive medicine covers in general both fields.

Always in considering the maintenance of health allowances must be made for the effect of routine. The body forms habits relating to all procedures connected with hygiene and these have the same control over the body, when once formed, as do all habits. In changing in any way his mode of living a person has to consider the adjustment which the body can make. This power of adjustment is great in youth but diminishes rapidly in old age, when changes of any kind have to be gradually brought about.

CHAPTER LXIX

RELATIONS BETWEEN ANIMAL ORGANISMS

From time to time, in reviewing the different phyla, relations between organisms have become apparent, and some of these have been indicated by name. It is, however, desirable to pass in review these relationships in such a manner that the logical connection between them will appear.

553. Solitary Life.—Solitary life is a possible mode of living only to those organisms which are able to play their part in reproduction without relation to any other individual. Examples would be the simpler protozoans, like the ameba, which reproduce by fission; and some metazoans, which reproduce by budding. It may also occur, as far as the individual is concerned, in the case of some sexual organisms, like clams and mussels, the males of which simply pass their sperm cells out into the water, chance alone determining their entrance into the female and the fertilization of the egg cells. Since, however, most animals, even though they may live alone at other times, come together at the time of breeding, a strictly solitary existence is a rare phenomenon.

554. Associations of Animals of the Same Species.—Associations of this type have their logical beginnings in the relation of animals as mates and also include families, colonies, and societies.

555. Mating.—Mating refers to the association of two individuals for purposes of reproduction, one taking the part of the male and the other that of the female. Such an association may be an exceedingly temporary one, ending as soon as the eggs have been fertilized, or, on the other hand, it may be a relationship which lasts throughout the lifetimes of the individuals concerned. As a general principle animals low in the scale of animal life exhibit a mating which is quite temporary, but in ascending the scale the relationship is found to be gradually prolonged. Especially is this true of animals in which the care of the parents is necessary for the successful rearing of the young. The mating of one male with several females is termed *polygamy*; and of one female with several males, *polyandry*.

556. Families.—If the offspring remain together and are accompanied by the parents, the relation is that of a family. This may persist only until the young are able to care for themselves, which is true of birds and mammals generally, or, on the other hand, it may last longer and lead to the next type of association.

557. Colonies.—When the parents and offspring remain in physical continuity, as in colonial hydroids, many anthozoan polyps, bryozoans, tunicates, and some other forms, what is known as a *colony* is produced. In such a colony there is often *division of labor* and dependence of one upon another. It may even result in the functioning of the whole as an organism made up of many individuals.

558. Societies.—If the offspring do not remain in physical contact but become separate individuals and yet these associate together, the group is termed a *society*. A society may, as in the case of various worms and barnacles, involve no dependence and no division of labor, but it is also possible to have division of labor and polymorphism within a society, such as in the case of ants and bees. Societies are not always the descendants of a single pair but may include unrelated individuals of the same species brought together by a social instinct.

559. Associations of Animals of Different Species.—Animals of different species are also found associated together. This involves relationships of various degrees of intimacy and with a varying distribution of benefits and injuries. The different terms which have been applied have been used in such varied senses that what they mean in any given place can be determined only by recourse to definitions or inferences from the facts presented. For this reason the examples of certain associations given here may be found elsewhere under different names. The terms used are aimed to bring out various degrees of relationship.

560. Gregariousness.—Gregariousness is a term applied to the tendency of animals to gather together in one place. If these are of the same species, a society may result; but it may involve different species and be due to the presence in that place of desirable conditions of existence, including food, shelter, moisture, and other environmental factors. Such a relationship is exhibited when in a marsh are gathered together a variety of marsh-loving organisms. It is also exhibited when birds of many species gather on an island in the ocean where they find conditions favorable for nesting and the rearing of young. In the highest animals, including those which possess intelligence, gregariousness may be the result of a desire for companionship, which also may be mingled with a feeling of safety in the presence of numbers, even though the individuals may be of different species. This safety may be a real factor if in the gregarious assemblage there are individuals which by their sounding of an alarm give warning of danger to the others.

561. Epizoid Associations.—The word epizoid implies the living of one animal upon another, not as a parasite but as it might live on any nonliving object. Colonial protozoans and hydroids which ordinarily attach themselves to rocks and other objects in the water may live upon the shells of mollusks, crustaceans, and other marine forms and thus

become epizoic, though the relationship means nothing to either animal.

562. Commensalism.—Epizoic associations merge into a type of association in which one organism benefits and the other is not injured. If, for instance, the accumulation of colonial hydroids upon the surface of a crustacean forms a covering sufficient to conceal the crustacean, which thereby secures benefit from the presence of the hydroids, the relationship may be considered one of *commensalism*. The word commensalism, however, means, literally, eating at the same table and was originally applied with the idea that one of the organisms secured food by utilizing the bits which the other dropped. It refers to other relationships than those concerned with food. The remora, or sucking fish (Fig. 306), fastens itself to the body of a shark and thus secures transportation. Certain small fish hide among the tentacles or within the bodies of coelenterates and gain security from their enemies.

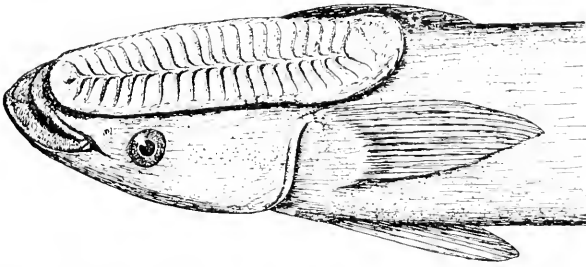

FIG. 306.—A remora, *Remora remora* (Linnaeus), cosmopolitan in warm seas. From a preserved specimen. $\times \frac{1}{2}$.

563. Mutualism.—Such an association, however, as has been indicated above under the name of commensalism merges into a third type which may be termed *mutualism* and which involves association between two animals of different species with benefits to each. Under this heading come many associations which have often been called commensalism. Such cases are, for instance, the association of a hermit crab and a sea anemone (Fig. 307) or a sponge, either of the latter two being attached to the shell which contains the former. In such a case the hermit crab profits by being protected either by the nematocysts of the sea anemone or by the inedibility of the sponge, and being a rather slovenly feeder it allows bits of food to escape which are utilized by the associated animal. Another similar association, described by Herodotus in the fifth century B. C., is that between the crocodile of the Nile and a small plover-like bird which enters the mouth of the reptile to pick leeches and insects of different kinds from crevices in the skin and morsels of food from the teeth. Mutualism not only merges into commensalism on the one hand, but it also is rather arbitrarily distinguished from symbiosis on the other.

564. Symbiosis.—If symbiosis is to be clearly separated from mutualism, the separation must be on the basis of maximum intimacy and the vital nature of the association. It is essentially an extreme form of mutualism. One case of symbiosis has been noted in the relationship which exists between a hydra and a green alga (Sec. 167), the cells of the alga living a symbiotic life in those of the animal organism and furnishing oxygen to the hydra in return for its own food. Other similar cases are known. Symbiosis is also shown by the termite and the protozoan *symbiont* which lives in its intestine (Sec. 317). It was long a matter of speculation as to how termites are able to digest the cellulose of the wood

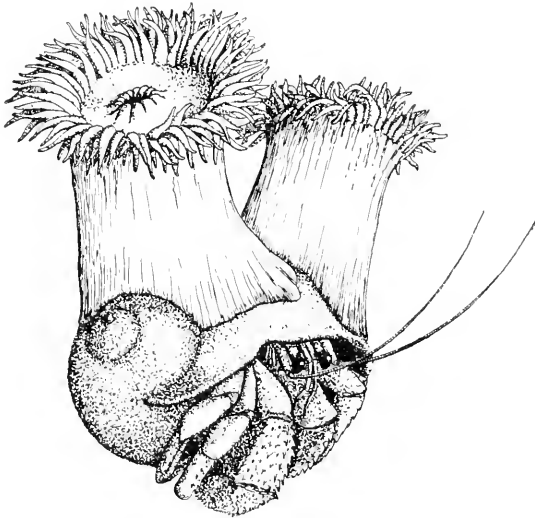

FIG. 307.—Hermit crab in a snail shell, which also bears two sea anemones. Considered by some as an illustration of commensalism, but referred to here as one of mutualism. From a preserved specimen. $\times \frac{2}{3}$.

on which they feed, since other insects are not known to have this ability. Cleveland has recently discovered that this is due to the presence in the intestine of the termite of a protozoan which prepares the wood for digestion and absorption by the insect. In the absence of the protozoan the termite is unable to use this food. On the other hand, the protozoan finds appropriate conditions for existence only in the intestine of the termite, and thus the association is vital to both.

565. Parasitism.—The associations of organisms of different species which have so far been defined all involve benefit to one or both but injury to neither. If injury is done to one, then the association becomes either one of parasitism or predatism.

Parasitism has already been defined as the association of two animals of different species in which one, termed the *parasite*, lives at the expense

of the other, called the *host* (Chap. XXXII). Parasitism might logically be made also to include the relation of two individuals of the same species when one lives at the expense of the other. Among worms are examples of one sex being carried about and nourished by the other, usually the male by the female. A similar phenomenon is presented in the case of certain fish. If, however, this association of the sexes is considered division of labor, then this is not true parasitism but the relationship of mates. It has been suggested that a young animal living within the body

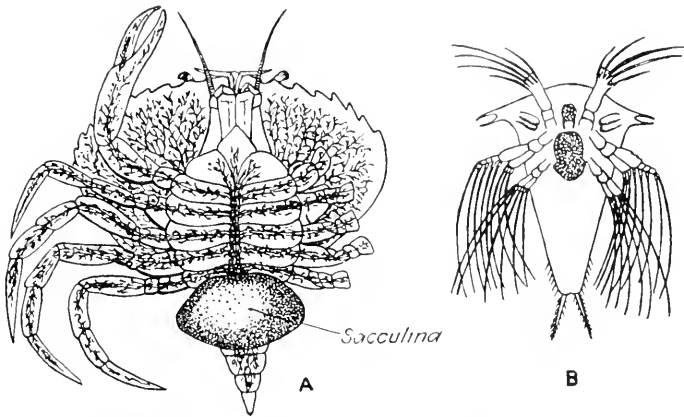

FIG. 308.—An extreme case of parasitism. *A*, semidiagrammatic representation of an individual of *Sacculina* sp. in the body of a crab and projecting from its ventral surface. *B*, nauplius larva of the parasite (compare with Fig. 164 *A*). The nauplius lives free in the water and changes to a form known as a cypris; this attaches itself to a seta on the body of a crab by its antennules and loses its thorax and abdomen with their appendages. The rest of its body undergoes degeneration and becomes a mass of cells. From the antennules rootlike filaments penetrate the body of the host and this mass of cells enters the body cavity of the crab and becomes attached to the ventral side of its intestine. The filaments of the parasite permeate the tissues of the host, and these tissues are in consequence partly absorbed. Ultimately the parasite develops a sac-like body containing reproductive organs and a ganglion, and this, pressing upon the skin of the ventral surface of the crab's abdomen, finally passes through the skin and shows itself as a tumor-like growth, shown in *A*. *Sacculina* belongs to the Cirripedia, or barnacles, and is therefore a distant relative of the crab which it parasitizes.

of the parent, especially if it receives nourishment directly from the parent, as in the case of mammals, should be considered a parasite. The nourishment of the young, however, seems to be one of the natural functions of the parent, and the relationship for that reason ought not to be considered one of parasitism. To extend the term parasitism to all these cases is to limit its significance and impair its usefulness and it seems best to limit its application to two animals of different species.

Internal parasites, such as intestinal worms and certain protozoans, are called *endoparasites*, while those which live on the surface of the host, such as fleas, mites, and lice, are called *ectoparasites*. Parasitism also may be either *temporary* or *permanent*. Instances of temporary

parasitism are afforded by lice which resort to the body of the host for but a brief time, as in the case of some lice which live in poultry houses and go upon the poultry for only a short time at night to feed; other examples are mosquitoes, sucking flies, leeches, and ticks, which are on the host only long enough to fill themselves with blood. Permanent parasites (Fig. 308) are such as the ascaris, which enters the body of the host in the form of an embryo within the egg and remains in that host throughout life. Parasitism may not involve intimate bodily contact at all, such as in the case of some ants which live a life of piracy in the hills of other ants larger in size. The parasites make small tunnels which open into the larger ones of the host ants. The former get their living by stealing food from their hosts, which are unable to follow them into the small tunnels to regain it.

566. Predatism.—Parasitism may in the end lead to the death of the host. This is not, however, to the interest of the parasite, which finds ease and safety in the relationship. If the death of the host does follow immediately after one animal attacks another, then the association is of the nature of predatism rather than parasitism, *predatism* being the eating up of one animal by another. Predatism is exhibited typically by those animals which we term predatory and which feed upon other animals by killing and devouring them. While the relationship of symbiosis is often considered as existing between animal and plant organisms and while that of parasitism may involve plants parasitic upon animals, the term parasitism is not often applied to animals living on plants as do lice or mites, nor predatism to the eating of a plant by an animal. So generally do plants form the food of animals that to recognize these as involving either parasitism or predatism would make the terms of distinctly less value.

CHAPTER LXX

DISTRIBUTION OF ANIMALS

ZOOGEOGRAPHY

The study of the geographical distribution of animals upon the surface of the earth and of the factors which have brought about such distribution forms the subject matter of a field of zoology which has generally been known as *zoogeography*. It is related on the one hand to paleontology, since present-day distribution depends in part upon past distribution; and on the other hand to ecology, in that the environment affects, and in many cases determines, the ability of individual animals to maintain themselves in any given locality.

567. Present Distribution.—The area occupied by any species of animal is usually termed its *range*. Generally speaking, throughout that area there must be, to a certain degree at least, similarity of conditions in so far as they are determining conditions in the life of the animal. Some animals, which are dependent apparently upon a very particular set of conditions, are confined to a limited range; others, able to adjust themselves to greater differences in conditions, possess a very extended range. Indeed there are a few which are cosmopolitan, being distributed practically throughout the world.

As a rule a particular species as well as related species occupy ranges which are continuous; but this is not always true, for there are many cases of *discontinuous distribution* when a given species or genus is represented in small areas far apart. This is rarely true of birds, because of their power of flight, but it is known of many mollusks and insects. The genus *Peripatus* offers an example of a type which has a very wide and at the same time discontinuous distribution (See. 305).

568. Past Distribution.—It is clear from the evidence furnished by the fossil remains of animals that their distribution over the earth has been very different in the past from what it is at the present time. An extreme instance of this fact is the occurrence of remains of animals which are now confined to the tropics as far north as the northern United States and the northern parts of Europe and Asia. Since the animals living on the earth today are descendants of those of the past, the facts of past distribution have a distinct bearing upon that of the present and may be the clue to discontinuous distribution. In order to explain some marked cases of such distribution, especially when it involves a number of different types, the existence of former land masses serving as bridges and

paths of migration have been assumed. An example of such a land mass is the hypothetical land named Lemuria, supposed formerly to have connected India and Madagascar; this would account for the fact that there are many types common to these two regions. The former existence of a continent connected to both Australia and South America, known as Antarctica, has also been suggested as a means by which related types now found on those continents may at one time have been distributed over a continuous area.

569. Place of Origin.—It is usually assumed that each species of animal must have originated in one particular place on the surface of the earth, from which locality it has been dispersed throughout its range. It is also generally assumed that closely related species have had a common origin and have been produced by modification of the type during its dispersal.

570. Dispersal of Animals.—Assuming a certain species or type of animal to have originated in a certain place, its dispersal, if it is successful, is inevitable; increasing numbers and the competition for food will of themselves cause the individuals to spread over a constantly widening area. Other factors which tend to cause animals to disperse are the search for favorable places in which to rear their young and the safety which isolation gives. Animals may, by changes in the environment which make it untenable, be forced to move from their original home. The following factors favor the wide dispersal of animals: (1) length of time during which dispersal has taken place; (2) uniformity of climatic conditions over a wide area; (3) continuity of habitat; (4) transportation by water currents, floating objects, and wind; (5) attachment to the bodies of other animals which move about; (6) human agencies. While a criterion to be applied with great caution, there are some grounds for the assumption that widely distributed types have had a long time during which to acquire wide dispersal and are, therefore, older types than those of a more restricted distribution. Most of the factors need no explanation. It may be related, however, as an example of dispersal by other animals, that on one occasion a blue-winged teal, shot near Lincoln, Nebraska, was found to have in a mass of mud on one foot five living crustaceans, *Hyallela dentata* (Say), two of which were females with eggs. The introduction of foreign types of animals into any region is being made constantly more easy by the development of international systems of transportation and the freedom of commercial intercourse. The dispersal of animals is sometimes called migration, though it should be carefully distinguished from periodic migration (Sec. 573).

571. Factors Hindering Dispersal.—Many conditions act as barriers to the dispersal of animals. (1) Geographic barriers, such as mountains, large bodies of water, and deserts, put a check to the dispersal of many types. Open areas are barriers to woodland forms, while the forest is a

barrier to forms adapted to life in the open. (2) Climatic conditions often form barriers. Though temperature, generally speaking, is not a serious barrier to many animals it may be an indirect factor in their distribution by limiting the growth of plants upon which they feed and by shortening their active season to such a degree that they cannot pass through their entire life history and thus reproduction cannot take place. Low humidity may be a barrier limiting the distribution of animals which cannot withstand the drying to which they are subjected. (3) Lack of proper food often forms an insuperable barrier for animals which feed upon certain types of vegetation and the area of distribution of which is strictly limited by the distribution of such plants. (4) Lack of locomotor ability is also a barrier to rapid dispersal, although over a long period of time it may not prevent the spread of animals into all areas suitable for their existence.

572. Modification of Types.—As animals have spread from their point of origin and have met varying environmental conditions they have become modified and adjusted to the conditions, and thus what was originally one form has been developed into a number of forms. These modifications may indeed be such as to permit their possessors to surmount barriers which otherwise would have prevented dispersal.

573. Periodic Migration.—Periodic migration may be defined as the repeated movement of animals from one place to another, at more or less regular intervals, participated in by all of a species or by all of those occupying a certain area. This excludes the movement of large numbers when it is not repeated, the gradual dispersal of species, and the chance wandering of individuals. In this restricted sense it is found throughout the animal kingdom, being confined to those organisms capable of locomotion and being exhibited by them in proportion to their power of movement. Migration is often associated with the search for food or for proper conditions for rearing young. In many animals it is the expression of an instinct, involving factors which initiate the movement and others which direct it. Among the initiatory factors are hunger, temperature, and light conditions; the functional activity of the reproductive organs; and a desire for home surroundings. Among the directive factors are relative temperatures, wind direction, water currents, and a sense of location. Reference has been made to the limited vertical migration of certain crustaceans (Sec. 301), which is shared by a large number of aquatic forms belonging to several phyla. The migration of birds has also been discussed (Sec. 432).

Among the invertebrates the most extensive and best known migrations are those of locusts, which have taken place in past times in Asia Minor, southern Africa, Argentina, and the western United States. These are due to lack of food in high barren regions and are directed toward lower and more fertile areas. They occur at irregular intervals.

In the northern part of this country the monarch butterfly migrates southward each fall and northward in the spring. Fish find in continuous bodies of water little to impede their movement and also make extensive migrations. Some fish live in the sea and migrate up rivers to lay their eggs; examples are the salmons, in the case of which the temperature of the water is probably a directing factor. Other fish, such as the eels, which live in rivers, migrate to the sea to spawn. European eels migrate to a region in the Atlantic Ocean southeast of the Bermudas. The adults of both the salmons and the eels die after spawning, so an individual makes but one round trip in its lifetime, but this may cover several

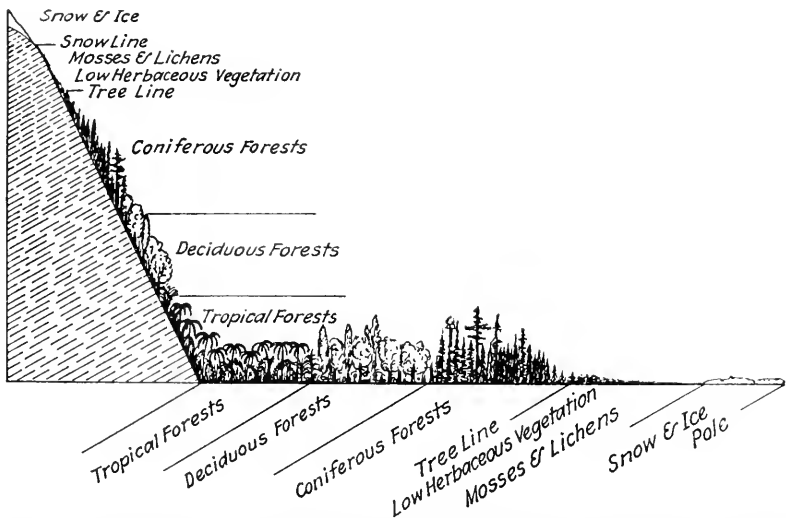

FIG. 309.—Diagram to show the correspondence between the vertical life zones met in ascending a tropical mountain with a permanent ice cap and the horizontal zones encountered in traveling from the base of the mountain to the pole.

thousands of miles. Other fish living in rivers migrate to the headwaters to spawn. Birds, with the ease of locomotion they possess, have the longest migration routes known. Among mammals may be noted the irregular migrations of the Scandinavian lemmings from the mountains to the lowlands near the coast, migrations which have been recorded since the beginning of historic times. Another example is the American bison, which formerly migrated regularly in the spring from the winter pasturage in western Texas and New Mexico to the summer pasturage and breeding grounds in the Dakotas and Montana, returning southward in the fall.

574. Altitude.—Altitude has a marked effect on animal distribution through the varying climatic conditions produced. Even in the tropics high mountains may exhibit vertically a series of climates corresponding to those found in passing from the tropics to the poles (Fig. 309). At the base of such mountains is a tropical climate with only the seasonal

variations involved in the existence of wet and dry seasons. Higher up is a zone which possesses a warm temperate climate, with summer and winter, but involving at no season a cessation of life activity. At a still higher level there is a cool, temperate climate with such a lowering of temperature in the winter as necessitates dormancy on the part of a number of living forms. The upper limit of this zone is the limit of tree growth. Above the tree line is a frigid zone, extending to the limit of all vegetation, and still above this an arctic zone. Thus vertical life zones occur on the mountains corresponding to the horizontal life zones at sea level; and just as seasonal changes occur in temperate regions farther north, so will they occur in temperate zones on the mountain in the tropics. Vertical migrations will also occur. In many cases particular species found on the upper parts of mountains are also found farther north where a similar climate exists. Such a fact is usually explained by assuming that in the past has occurred such a climatic change, affecting a widely distributed species, that the species has become extinct except on higher mountains southward and in areas farther north with a corresponding climate. Thus in both cases it has persisted in a region where the climate is suitable.

575. Oceanic Distribution.—The conditions at any particular location in the ocean are much more uniform than are those in fresh water or on land. This stability shows itself especially in temperature, salinity, and in the gaseous content of the water. At points widely separated in the ocean, however, there are marked differences in temperature and, to a certain extent, in the other factors mentioned, which affect the distribution of life. Another factor concerned in marine distribution is the existence of ocean currents, by means of which many species are dispersed. Vertical distribution in the ocean is affected by a variety of conditions, including pressure, which increases by 14 pounds to the square inch for every increase of 10 meters in depth. At a depth of 3660 meters, or about 12,000 feet, this is over $2\frac{1}{2}$ tons to each square inch of area. This great pressure does not affect animals living at great depths, since the pressure within their bodies is equal to that which is without, but it limits vertical movements. Light decreases by absorption and ceases to have any effect upon life at a depth of about 900 meters (3,000 feet). It is stated that all of the heat due to the rays of the sun is lost below about 275 meters (900 feet). In the Atlantic Ocean it has been found that with a surface temperature of 20°C . (68°F .) the temperature at 500 fathoms is about 3°C . (39°F .) and that at 1000 fathoms it is little less, decreasing very slowly to the bottom, where it is about freezing. The highest sea temperature known is in the Persian Gulf, where there is a surface temperature of 35°C . (95°F .), while in the polar seas surface temperatures of approximately -3.3°C . (26°F .) have been recorded. In the depths of the sea animals live under a condition of high pressure,

a temperature little above freezing, no light, and no movement of the water sufficient to produce a current.

576. Island Faunas.—The fauna of an island depends upon whether or not the island is what is known as a continental one, adjacent to a continent, with which in the past it may have been in communication,



FIG. 310A.—The zoogeographical regions of the western hemisphere.

or an oceanic island, lying at a distance from any continent and with no such past connection. Frequently the faunas of continental islands are similar to those of the adjacent mainland, even the same amphibians—which never occur in the ocean—being found, as well as mammals to which even a narrow channel would be a barrier. Often characteristic types are absent from such islands, as are snakes, for instance, from Ire-

land. Oceanic islands are characterized by a complete absence of mammals and amphibians. On many such islands there is a decided tendency toward the existence of wingless birds and insects. This has been explained by the fact that flying forms would be likely to be swept away by winds and thus destroyed.



FIG. 310B.—The zoogeographical regions of the eastern hemisphere.

New Zealand is an island which is peculiar in possessing some of the faunal characteristics of a continent. There are only two native mammals, a bat and a rat, both of small size. The birds of New Zealand have been in the past and are now very characteristic. Among them are the gigantic moas, now extinct, and the curious *Apteryx*, or kiwi, now becoming very scarce. Among the reptiles is the peculiar *Sphenodon* (Fig. 264). The amphibians are represented by a single species of frog.

577. Faunal Divisions of the Earth.—On the basis of the distribution of animal types the world has been divided into a number of different regions, those originally proposed by Sclater being most widely accepted (Fig. 310). These involve only land distribution and are based to a greater extent upon the distribution of the higher vertebrates than upon that of any other group. According to this plan the earth is divided into six regions. The first is the Australian, which includes Australia, New Zealand, part of the East Indies, and the South Pacific islands. The second, or Neotropical, includes South and Central America and part of Mexico, with the West Indies. The third, or Ethiopian, includes Africa south of the northern boundary of the Sahara, Arabia, and Madagascar. The island of Madagascar is in many respects quite different from the rest of this region and is sometimes called the Malagasy subregion. The fourth, or Oriental, includes Asia south of the Himalaya Mountains and west to the Persian Gulf, southern China, and a large part of the Malay Archipelago, including the Philippines, Borneo, and Java. The fifth, or Palearctic, includes Europe, that part of Asia north of the Himalaya Mountains, and Africa to the Sahara. The sixth, or Nearctic, includes North America south into Mexico.

Of the different regions the *Australian* is the most distinct. Here are found all the monotremes and most of the marsupials among the mammals and such characteristic birds as the birds of paradise, the honey-suckers, lyre birds, brush turkeys, cassowaries, emus, and, in New Zealand, the kiwi. Here are also the *Sphenodon*, peculiar tortoises, and the Australian lungfish.

In the *Neotropical* region are found the opossums, which are marsupials; many peculiar edentates, including sloths, armadillos, and anteaters; the American monkeys, marmosets, and vampire bats. There are also many peculiar birds, among the most remarkable of which are the toucans, the hoatzin, curassows, guans, and the rhea, or American ostrich. There are certain peculiar snakes, including the anacondas, and also electric eels.

In the *Ethiopian* region are the gorilla, the chimpanzees, the broad-nosed monkeys, the lion, the African elephant, rhinoceroses, hippopotamuses, the zebras, and many antelopes but no bears or any deer. Among the birds are the African ostrich, guinea fowls, and the secretary bird. Characteristic types of lungfishes are found here. There are no crayfishes. In Madagascar are found some lemurs and the flying foxes; the island lacks the rodents characteristic of Africa and once possessed a gigantic extinct bird, the *aepyornis*, which is not known to have occurred elsewhere.

In the *Oriental* region are found the orang-utan, gibbons, the macaques, the tiger, peculiar lemurs, some antelopes, the Indian elephant, the Malayan tapir, and rhinoceroses differing from those occurring in

Africa, as well as many characteristic birds, such as cuckoos, pheasants, babbling thrushes, and broadbills.

The *Palaearctic* and *Neartic* regions have not such rich faunas as the regions already mentioned and not so many characteristic forms. Common to these regions are deer, bisons, bears, wolves, beavers, and marmots. There are remains of the mammoth in Siberia and the hairy rhinoceros in Europe. Distinguishing the *Palaearctic* region are certain wild sheep, the ibex, the chamois, wild horses and asses, camels, and the tiger. The *Neartic* region, on the other hand, has a relative scarcity of hollow-horned ruminants, which are represented by the bighorn, the American bison, and the mountain goat and also possesses badgers, prairie dogs, and certain pouched rats.

There are some interesting analogies between regions in the existence of corresponding but unrelated forms. Such forms are the humming birds, the greatest number of which are in South America with some species extending into North America but which are entirely absent from the Old World, where their place is taken by the sunbirds. Other forms that illustrate such an analogy are the large-billed toucans of South America, to which the hornbills in Africa and southern Asia correspond.

578. North American Life Zones.—This continent has been divided by Merriam into regions and life zones based upon temperature, forming bands crossing the country from east to west, and carried southward along the mountains and northward along the central valleys by the effect of altitude. In the western part of the United States, where great differences of elevation, soil, and climate exist, there is great irregularity in distribution. Three regions were recognized by Merriam—the boreal region, which included most of Canada; the austral region, which included roughly the United States and northern and central Mexico; and the tropical region, which covered the southern tip of Florida, the West Indies, and the coasts of Mexico north to about 25 degrees latitude. This mapping of the continent has been severely criticized recently because of too great dependence upon temperature and the failure to recognize vegetation regions.

The vegetation regions of North America (Fig. 311) may be roughly outlined as follows: South of the frozen arctic region is a treeless area referred to in a general way as tundra. In the northern part of this area the ground thaws to a depth of but a few inches in summer and the surface supports a growth only of lichens and mosses. As one proceeds southward the depth to the frost line increases and grasses, low herbaceous vegetation, and even low shrubs appear. Finally the limit of trees is reached and one enters the northern coniferous forest, which is represented on the Pacific coast by western and northwest coniferous forests, extending down into California and along the Rocky Mountains into Arizona and New Mexico. Central United States in the east is

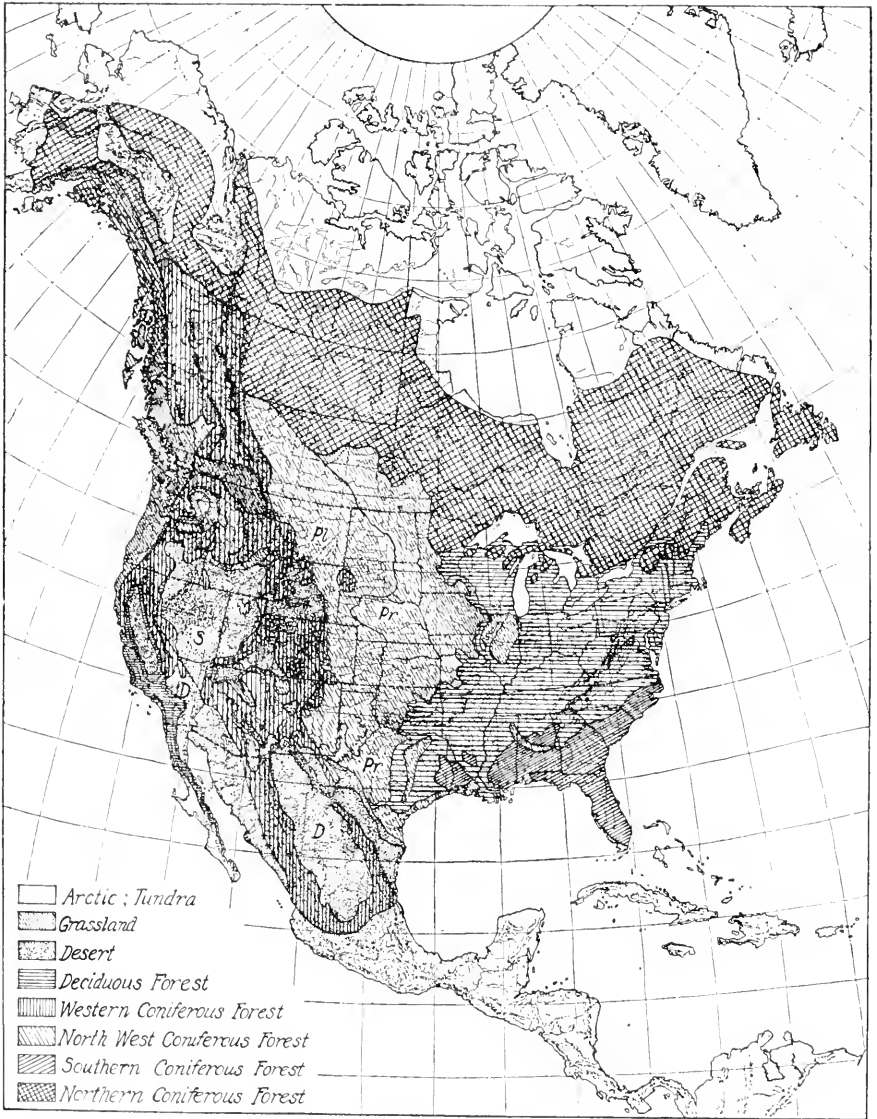

FIG. 311.—A diagrammatic map of North America showing the vegetation regions north of the tropical region. (Areas in the United States based upon Shantz and Zon, "Atlas of American Agriculture," Part I, Sec. E; those in British America upon Weaver and Clements, "Plant Ecology"; and those in Mexico upon both.) One line separates the prairie (Pr) from the plains (Pl), and a second the sagebrush area (S) from the southern desert region (D). The existence of elevated areas presenting conditions corresponding to the northern coniferous forest, the tundra, or the arctic zone in the Alleghenies and the western mountains is indicated by areas of black.

occupied by a deciduous forest, and southern and eastern United States by a coastal-plain forest, which includes both coniferous and deciduous trees. West of the forest region is the region of the prairies and plains, extending from Alberta to central Texas and the Great Basin; and the southern desert region, which occupies the interior basin between the Pacific coast states and the Rocky Mountains and extends southward far into Mexico. Finally, there is a tropical and subtropical forest region, which is the same as the tropical region of Merriam.

At present there is a strong tendency to bring the faunal regions into agreement with the floral regions just outlined. Each of these regions has characteristic animal types, some of which may be mentioned. The prairies and plains comprise the ranges of the pronghorn, the bison, several ground squirrels, prairie hares or jack rabbits, the prairie chicken, and the burrowing owl. The deciduous forest harbors the Virginia deer, the opossum, the gray fox, the fox squirrel, the cardinal, the Carolina wren, and the yellow-breasted chat. The northern coniferous forest has the moose, the snowshoe rabbit, the pine marten, the northern jumping mouse, the three-toed woodpecker, and the spruce grouse. The region of tundra and snow is the range of the musk ox and polar bear and in summer is the home of a host of water and shore birds.

CHAPTER LXXI

PAST DISTRIBUTION OF ANIMALS

PALEOZOLOGY

As suggested in the previous chapter (Sec. 568) the present distribution of animals on the earth is determined in part by their past distribution. Those of the present are the descendants of those of the past. Though a few living types are of relatively recent origin many have existed for many millions of years. The study of the organisms which have lived during the past ages is the field of paleontology, which may be divided into paleobotany and paleozoology, depending upon whether the organisms the remains of which are studied were plant or animal.

579. Fossils.—Fossils, which means literally objects dug up, are the remains of plants or animals, or records of their presence, preserved in the rocks or in soils. Aside from the fossils commonly found in rocks, they include mammoths, related to present-day elephants, frozen in the soils of northern Siberia; other mammals buried in peat bogs in different parts of the earth; animals found submerged in a lake of asphalt in southern California; and insects, scorpions, and spiders, preserved in amber, a fossil resin from the shores of the Baltic Sea.

580. Stages in Fossilization.—A dead animal is soon eaten by other animals or is destroyed by the processes of decay, even skeletal parts being subject to destruction. If buried in the soil, however, particularly if air cannot reach them, such remains are preserved for a much longer time. Bog waters are antiseptic and in them decay takes place very slowly. Animals are preserved for a long time in volcanic ashes or deposits of fine wind-blown soils. If dead organisms are quickly buried in the mud at the bottom of bodies of water and especially at the bottom of the sea, disintegration is exceedingly slow. Skeletal structures may be preserved for a very long time, and even soft parts may remain long enough to allow mineral matter to replace the organic matter and thus in its arrangement reflect the structure of the organism. Later as this mud becomes consolidated and forms rock, owing to the pressure of overlying strata and the cementing of the particles together through precipitation of mineral substances from solution, all the organic matter becomes replaced by mineral matter and the fossil is said to have become petrified. In this condition it will last until the rock containing it is broken up by changes in the earth's crust, reduced again to dust by erosion, or metamorphosed (Sec. 583) by the action of heat. Mud-

bearing animal tracks or the imprint of soft-bodied organisms may be buried by other deposits and the evidences be preserved as fossils.

These facts make it evident why fossils of marine animals are most abundant and why animals which are most likely to fall into rivers and

Eras	Periods	Length, millions of years	Dominant life	
Cenozoic	Quaternary: Recent (20,000- 50,000 years) Pleistocene, or Glacial	} 0.5 - 1	Age of man	
	Tertiary: Pliocene Miocene Oligocene Eocene		Age of mammals and modern flowering plants	
Mesozoic	Cretaceous	50	Age of reptiles and medieval floras	
	Jurassic	37.5		
	Triassic	22.5		
Paleozoic	Permian	30	Age of amphibians and ancient floras	
	Carboniferous: Pennsylvanian Mississippian	30 30		
	Devonian Silurian	45 30		
	Ordovician Cambrian	75 60	Age of higher invertebrates	
	Proterozoic	Keweenawan Huronian	250	Age of primitive marine invertebrates
	Archeozoic	Archean	300 (Total 1,000 ±)	Age of unicellular life
Pregeologic		?		

FIG. 312.—Geological time scale. Based upon data given in Schuchert's "Historical Geology."

be carried down to the sea and buried in mud are more likely to be represented in fossils than other terrestrial forms. Since decay in very dry climates is slow and animal remains may dry up before decaying, such remains may easily be covered by wind-blown deposits and thus be preserved, especially if the area is later covered by oceanic water, and the deposits converted into rocks.

581. Geological Ages.—Since the same conditions have been many times repeated in the history of the earth and the same minerals have been present at all times, it is impossible to determine the age of a stratum by its structure or composition. However, the study of fossils in strata which remain in the same order as that in which they were deposited shows that the forms of life have changed from time to time. Consequently, by critical study of the fossils and comparison of strata in different parts of the earth, geologists are enabled to recognize those strata belonging to the different ages and to relate them in a sequence which corresponds to the order of their deposition. From the thickness of the strata, in connection with their character, an estimate can be made as to the duration of past ages. This estimate may be confirmed or in some cases modified by the application of knowledge of chemical changes which involve a time factor capable of precise calculation. The last data have in general considerably increased the length of time formerly allotted to the different ages by geologists. Estimates of the duration of these ages still remain, however, very uncertain.

582. Geological Time Scale.—On the basis of the estimates referred to in the preceding section, geologists have prepared a time scale, which, as represented in North America, is shown in abbreviated form in Fig. 312.

583. Metamorphism.—The rocks of the Archean period are universally distributed over the earth, though to a great extent they are covered by more recent formations. (This is not true of the distribution of those of any other period.) They show evidences of sedimentary origin but are everywhere modified by metamorphism. Metamorphism occurs when stratified sedimentary rocks become buried deeply by overlying strata and are subjected to the internal heat of the earth. The rocks of the Huronian and Keweenawan periods are more decidedly sedimentary in character, but they still show much metamorphism. Those of the Cambrian and Ordovician are less generally metamorphosed; and the later periods show no such effect. The result of this metamorphism was to destroy all fossils and with them most of the evidences of the existence of life. In the Archean, beds of carbon in the form of graphite, of iron ore derived from carbonates, and of limestone of sedimentary origin are all indications of the presence of living organisms in that period. The few ill-preserved fossils found are all considered to be remains of algae. In the Proterozoic are found fossil calcareous algae, bacteria, radiolarians, sponges, fragments of crustaceans, and the tracks of marine annelids, but these fossils are exceedingly rare and scattered. Owing to the general metamorphism of rocks older than the Cambrian, therefore, geological records of earlier life have been almost entirely obliterated. Consequently, it is not surprising that in the oldest strata which contain fossils in any considerable numbers, most of the invertebrate phyla are represented. The result is, however, that there are no evidences from pale-

ozoology of the steps in the evolution of animal life on the earth until the process was far advanced.

584. Animals of the Past.—Of the Protozoa, only foraminiferans and radiolarians are found fossil, the latter in rocks of the Proterozoic era in France and those of later periods, the former from the Cambrian onward. Sponges are also known from the Proterozoic. Hydrozoans have been abundant since the Cambrian, when they were represented by a type known as graptolites. Scyphozoans, represented by impressions and molds, have existed since the Cambrian, as have also corals the skeletons of which are abundant and of great variety in the rocks of all periods since that time. Brachiopods appeared early in the Cambrian, and bryozoans are abundant from the Ordovician onward. There are over 6000 fossil species of brachiopods, but only 160 are known to be living now.

Starfishes and holothurians date from the Cambrian, and brittle stars and sea urchins from the Ordovician. Crinoid remains represented by stalk sections (Sec. 238) have been found in the Cambrian, and fragments of crinoids occur in beds of crinoidal limestone from the Ordovician to the Jurassic. Blastoids and cystoids existed throughout the Paleozoic era; they resembled crinoids in many ways but are more primitive.

Of the mollusks, chitons and scaphopods have existed since the Ordovician; and pelecypods, gastropods, and cephalopods since the Cambrian. Their fossil shells are found in abundance and are widely distributed. The nautiloids, represented today only by the chambered nautilus, were abundant in the Silurian; 2500 species have been described. Twice as many species of ammonoids (Fig. 313) are known; these were most abundant in the Mesozoic and are now extinct. The earliest forms resembling squids and cuttlefishes appeared in the Triassic.

Chaetopods are the only fossil annelids. They are found from the Cambrian onward, though worm tracks have been found in rocks of the Proterozoic era.

The earliest arthropods were branchiate and marine. Trilobites (Fig. 314) had their origin before the Cambrian, being abundant in the oldest fossil-bearing strata. They were a dominant type in the Cambrian period and disappeared before the end of the Paleozoic. Other crus-

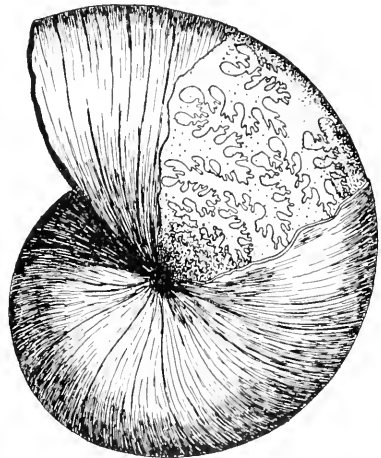

FIG. 313.—An ammonoid from the lower Jurassic period, resembling in form a chambered nautilus (Fig. 130), but showing a portion of the shell removed to bring into view the complexly folded septa that distinguished these forms.

taceans appeared during the Cambrian and Ordovician. Myriapods appeared in the Devonian, scorpions in the Silurian, and spiders in the Carboniferous. Eurypterids, which were scorpion-like but marine,

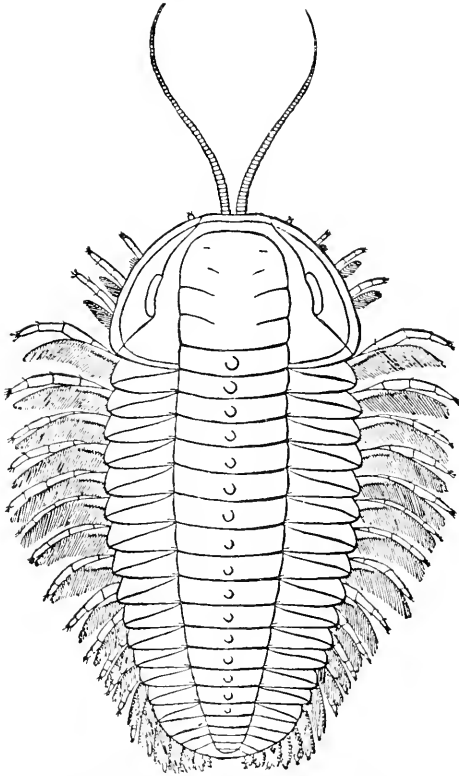

FIG. 314.—A trilobite, restored, showing limbs and antennae. Dorsal surface. (From LeConte, "Elements of Geology.")

lived throughout the Paleozoic. They have considerable resemblance to the king crabs, which appeared in the Triassic. Insects appeared first in the Carboniferous, and the largest insects that have ever lived were in

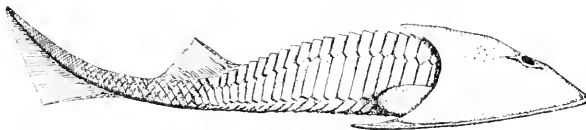

FIG. 315.—An ostracoderm, restored. (Based upon Schuchert, "Historical Geology," after Koken.)

the Pennsylvanian, a dragon fly from the coal deposits of Belgium measuring 29 inches across the wings.

Ostracoderms (Fig. 315), the first vertebrates, appeared in the Ordovician, and only they and primitive sharks are known from the Silurian,

but ganoids and lungfishes existed in great variety in the Devonian, which is known as the age of fishes. The more modern fishes, the teleosts, were not known until the Jurassic and are represented now by the greatest number and diversity of species they have ever possessed. A footprint from the Devonian is the earliest trace of an amphibian. There were giant armored amphibians, the Stegocephala, in the Pennsylvanian and Permian periods. These reached a maximum length of 15 to 20 feet in the Triassic, when they became extinct. The reptiles appeared about the time of the amphibians but did not become dominant until the Mesozoic, which was the age of reptiles; they reached their highest development during the Jurassic. The aquatic and marine types attained a length of 40 feet; a flying pterodaetyl had a wing spread of 25 feet; and the gigantic dinosaurs reached 100 feet in length. These giants suddenly became extinct in the Cretaceous.

Fossil remains of the earliest bird, *Archaeopteryx* (Fig. 271), have been found in the Jurassic slates of Bavaria, and a number of other birds are known from the Cretaceous. The earliest mammalian remains are from the upper Triassic, and many types are known from the Cretaceous. Mammals have been dominant since the beginning of the Cenozoic era. Human origins have already been discussed. Steps in the development of other mammalian types will be referred to in the next chapter, on evolution.

CHAPTER LXXII

EVOLUTION OF ANIMALS

Two conceptions of the universe in which we live have been held. One was that it is a static universe created some 6000 years ago, with the character it now has, and that it has remained in that condition ever since. This, however, is contrary to facts easily secured by careful observation and is untenable in the light of modern scientific knowledge. Changes are now seen to be taking place everywhere and there is ample evidence that this has always been the case. It is also clear that the history of the earth has involved unnumbered ages. Animals and plants no longer appear to us as organisms created in the beginning with exactly the same character they have today but as having the characters they now possess in consequence of gradual changes which have come about through the ages that have passed. So the second conception—that the universe is ever changing and progressing—now prevails. This progressive change is called *evolution*. Certain theories of the origin of life were stated early in the text, but organic evolution, which is the evolutionary conception applied to living things, concerns itself only with the changes which have ensued in living things since life first appeared.

585. History of Evolution.—For the beginnings of the concept of evolution it is necessary to go back to the time of the early Greek philosophers. In striving to explain the nature of the universe the idea of evolution suggested itself to them, though they had no data by which to test it. Anaximander (611–547 B.C.) presented the idea of an actual change in living organisms, including a change from aquatic to terrestrial life. He even included man in his theory. Empedocles (495–435 B.C.) has been called the father of evolution. He believed both in spontaneous generation and in the gradual development of different types of organisms. In a crude way he also expressed ideas of competition between organisms and of natural selection, or the survival of the most fit. Aristotle (384–322 B.C.) did not accept the idea of the survival of the fittest but he did believe in the development of organisms from a primordial living slime, and he suggested a sequence of animal types forecasting a phylogenetic series such as is accepted today. He also believed in heredity and recognized evidences of relationship in rudimentary organs.

Throughout the Dark Ages no progress was made, but even during this period there were theologians, including Augustine (353–430 A.D.)

and Thomas Aquinas (1225–1274), who upheld the evolutionary conception and expressed beliefs in the symbolic nature of the biblical story of creation.

The first of the modern zoologists to entertain clearly the evolutionary conception was Buffon (1701–1788) but he hesitated to urge his ideas. He was the first to believe in the direct modification of organisms by their environment. Erasmus Darwin (1731–1802), the grandfather of Charles Darwin, recognized the fact of a struggle for existence and also accepted the theory of the inheritance of acquired characters, believing that forces within the organism responding to environmental changes formed the basis for modifications in the organism. Lamarck (1744–1829) made valuable contributions to the field of biology, including the proposal of the term biology itself and the use of a tree of life to express phylogenetic relationships among organisms. His most noteworthy contribution was a definite theory of evolution based upon the *use and disuse* of organs. He believed that necessity in the organism might give rise to new organs and suggested that the use of any organ strengthens, develops, and enlarges it, while a lack of use causes a progressive degeneration and ultimate disappearance. He also believed that these changes were passed on by heredity—that is, he believed in the inheritance of acquired characters.

The most famous name in this field is that of Charles Darwin (Fig. 316), who lived from 1809 to 1882. His preeminence is indicated by the fact that popularly darwinism has come to be looked upon as synonymous with evolution, though at the present time many of the ideas which Darwin advocated are no longer accepted. Darwin's great work was the "Origin of Species," published in 1859, in which he presented his theory of *natural selection*. This same theory was arrived at independently by Wallace (1822–1913) who, however, had not such a wealth of observational data to support it as had Darwin. For this reason, though he joined with Darwin in first presenting the theory, he stood aside and permitted Darwin to publish it alone. The publication of Darwin's work excited violent controversy, but since neither he nor Wallace was fitted by disposition effectively to defend the theory in public, that task fell to Huxley (1825–1895) who successfully championed the cause of evolution.

Since the time of Darwin a flood of contributions has appeared which involve a great many avenues of approach to the subject of evolution. Weismann (1834–1914) supported Darwin's conception of evolution by emphasizing the distinction between germ plasm and somatoplasm and the part played in inheritance by the germ cells. The discovery of chromosomes and the development of the field of genetics have provided a physical basis for evolutionary changes. Many of these modern theories will be referred to in discussing the causes and method of evolution.

586. Evidences of Evolution.—Among the evidences which support the evolutionary conception is the fact that *variation* is seen everywhere among organisms and that many of these variations are clearly transmissible to succeeding generations. Other evidences are that it is possible under cultivation to modify animals in certain definite directions which are advantageous, and that under experimental conditions in the laboratory animals have been caused to undergo changes which have been inherited.

The facts that all *protoplasm* is practically the same in character, that metabolism is carried on by all living organisms, that such phenomena as

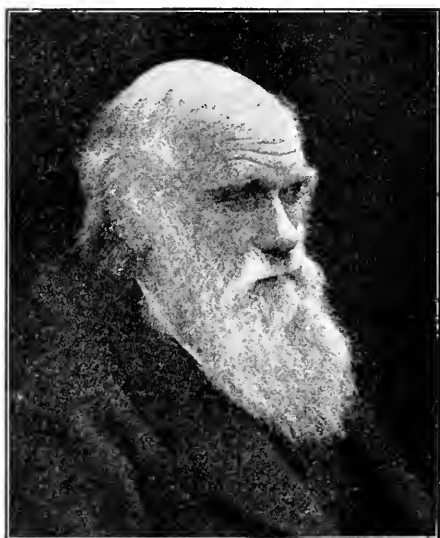

FIG. 316.—Charles Darwin, 1809–1882. (From Shull, "Principles of Animal Biology." Photo by Leonard Darwin in *University Magazine*. By the courtesy of McGraw-Hill Book Company, Inc.)

mitosis, gametogenesis, and embryogeny are phenomena which, in general, always occur in a similar fashion are all further evidences of relationship due to common origin.

Comparative anatomy furnishes numerous evidences of evolution, many of which can be summed up under the general head of homology. The existence of homologous structures, which is very prevalent among animals, indicates relationship and a common ancestry. Some particular examples are the homologies which exist in the series of vertebrate skulls from fish to man, the uniformity of plan in the vertebrate limb, and the common plan of structure which shows itself in the brains of vertebrates. Another evidence derived from comparative anatomy is the existence in certain animals of vestigial parts and organs (Fig. 317), together with the fact that in other animals which from their general structure are appar-

ently either ancestral to those which possess the vestiges or are related to such ancestors these parts and organs are fully developed. Among the vestigial structures in man are the existence of supernumerary mammary glands; the persistence of hair on the body; the presence in rare cases of vestiges of a tail; the existence of a third eyelid, or nictitating membrane; the presence of vestigial muscles, particularly in connection with the ears; and the possession of a vermiform appendix. The last, in

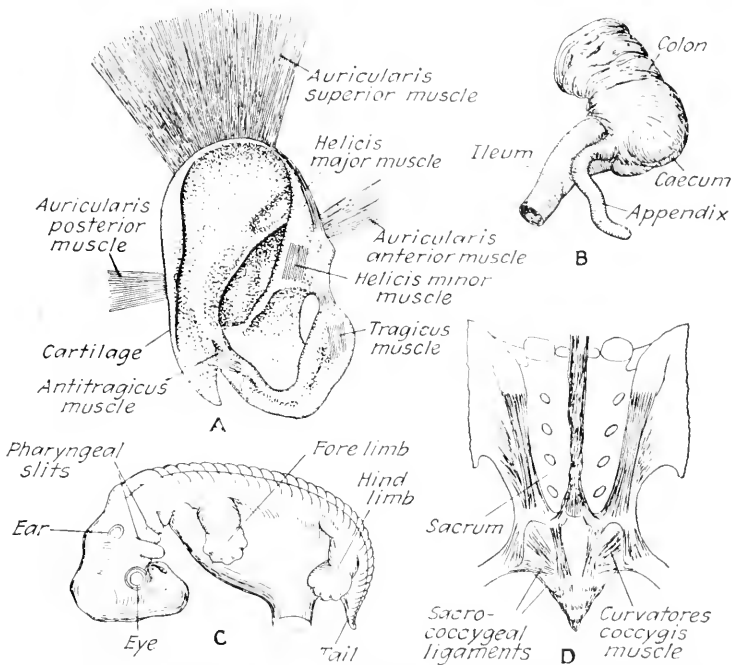

FIG. 317.—Vestigial structures in man. A, the muscles of the ear, displayed by removal of the superficial tissues. B, appendix, seen from behind. C, embryo, showing the tail. D, abnormal persistence of tail muscles in adult, seen from behind. (Figs. B, C, and D from Romanes, "Darwin and After Darwin," part I, by the courtesy of The Open Court Publishing Company; Fig. A compiled from works on human anatomy.)

many mammals, is a functional part of the intestine, adding to its capacity; especially is this true of herbivorous forms.

Many facts from *comparative embryology* also support the idea of evolution. Prominent among them are the examples of the biogenetic law to which references have been made previously. The embryos of different classes of vertebrates resemble each other very closely in early stages, and differences begin to appear at points which may be assumed to be where ancestral lines have diverged (Fig. 318). Among the most striking of such differences are those which mark the separation of terrestrial from aquatic vertebrates. Other evidences are the stages in the evolution of the circulatory system, including the changes in the branchial

arches (Fig. 245), the gradual development of the vertebral column to replace the primitive notochord, and the development of the different types of excretory system (Fig. 216), all of which have been previously noted.

Paleozoology offers very many evidences that animal life has gradually changed. Apparently no rock strata exist which show traces of the

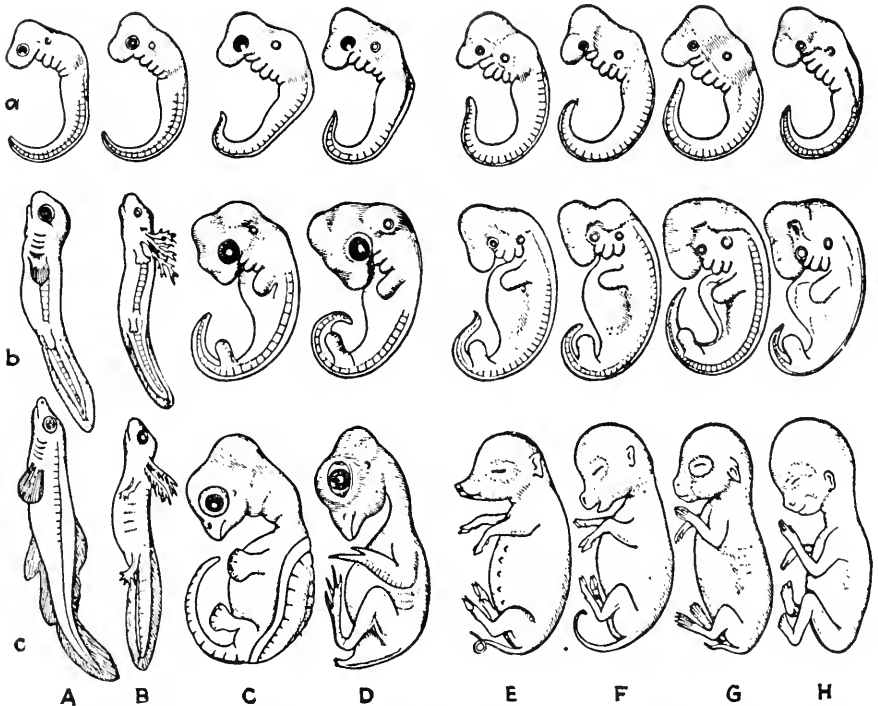

FIG. 318.—Parallel stages in the development of several vertebrates. A, fish; B, salamander; C, turtle; D, chick; E, pig; F, calf; G, rabbit; H, man. In each series, *a* is an early stage, showing the pharyngeal slits; *b*, a later stage, in which the first two have developed gills and the last six show the pharyngeal slits disappearing and limbs and tails developing; *c*, a still later stage, in which the differences between the reptile and bird on the one hand and the mammals on the other have become pronounced, marked resemblances between those of each group persisting. (From Guyer, "Animal Biology," after Haeckel, through Romanes.)

earliest life. This is due to metamorphism (Sec. 583). The older rocks give only indirect evidence of the existence of life on this earth. The earliest of the sedimentary rocks to contain an abundance of fossil types belong to the Cambrian period. Since that time strata deposited, one after another in order of time, show the appearance of many types which have gradually increased in numbers and variety, have reached a climax, then have declined, and finally have become extinct. Others have been able to maintain themselves to the present. But there has been a steady

advance in the character of the highest forms from age to age. In the oldest strata the highest types are invertebrates; from the Ordovician through the Silurian, the fishes; from the Devonian to the Triassic, the amphibians and reptiles; and from the Triassic and Jurassic to the present time, the mammals and birds, the more modern forms being the highest.

Many facts of *geographical distribution* are explainable only on the assumption of the truth of the evolutionary conception. The marsupials are evidently very primitive mammals, represented both in Australia and in South America. Though fundamentally alike, the marsupials of South America and Australia are nevertheless quite distinct. These facts are best explained by assuming a common origin of these animals and later modification after separation.

587. Causes of Evolution.—The causes of evolution are not well-understood at the present time. Neither the inheritance of acquired characters nor the effect of use and disuse as direct causes of evolution is accepted today. On the contrary, the causes are sought in certain changes taking place in the chromosomes. Hereditary units in the chromosomes, according to the present theories, must register every transmissible modification. How they may be modified and thus cause changes to occur is unknown; it is, however, possible that there is an innate tendency for the genes to change, which results in evolution, and it is also possible that hormones or other substances in the blood may affect them. Recent work on the effect of X-rays upon the gametes have shown that by their application structural modifications may be brought about in the fruit fly, *Drosophila*, and that these changes are heritable. Whether or not such rays are a factor in natural evolution is yet to be determined.

The appearance of a characteristic is often referred to as if it were a response to a need or as if it had appeared for the purpose of adapting the animal to a condition. When used by modern writers, however, such expressions should be recognized as figures of speech. Of course no structure appears because it is needed, neither is necessity a cause of evolution; but if a structure does appear and is advantageous to its possessor, it contributes both to its own persistence and to the perpetuation of the race.

588. Methods of Evolution.—Various theories have been put forth as to the method by which evolution is brought about. The first modern theory to be presented is that of *natural selection*, which was the one put forward by Darwin and Wallace. This may be summarized as follows: (1) All organisms produce a greater number of young than can survive. (2) This results in competition for the necessities of life and a struggle for existence. (3) All organisms tend to vary; some variations are advantageous, others harmful, and still others of no moment. (4) As a result of the struggle for existence favorable variations would tend to be

preserved and harmful ones eliminated. (5) Such changes are passed on from generation to generation and result in a gradual change in the character of the species. (6) If upon being dispersed into other regions individuals can escape the effect of the struggle for existence or exist under altered conditions, they may develop characteristics different from those they have previously possessed and this may result in the production of a new species. Such species usually show definitely their relationship to the parent species. Natural selection seems to be without doubt one means by which changes may be passed on. Though it is not the only method it is the one which is supported by the most extensive evidence from observation and may be supplemental to any of the others.

A second method of evolution is *mutation*. Mutation may be defined as a sudden change in the appearance of an animal type; the term was originally applied especially to those changes which were striking, but any evident change is a mutation. Slight mutations are not clearly distinguishable from the continuous variations which are assumed in the theory of natural selection. Support for the theory of mutation as a method of evolution is seen in the appearance in nature of so-called sports—new types which have suddenly appeared and which have transmitted their characters to succeeding generations. Many cases of mutation in the fruit fly are known, which involve eye color, the shape and size of wings, body color, additional bristles, and other less obvious characteristics. DeVries, who was the author of the theory that evolution was due to mutation, based it upon experimental work with evening primroses. The suggestion has been made that he was dealing with hybrids and not with pure forms and that thus the types which he produced did not, at least in part, represent true mutations. Nevertheless this does not explain all of his results, and numerous examples of mutation are now known in both plants and animals.

Another method of evolution was suggested by Lotsy. He believed that since all animals are from the genetic standpoint impure, new types may be developed constantly as a result of *hybridization*, not in the sense of crossing two species but in the sense of crossing genetic characters.

Still another method is that known as *orthogenesis*. Paleontologists have been very active in urging the importance of this as a method and the evidence to support it comes largely from fossil types. According to the theory of natural selection, when a characteristic becomes harmful to an animal it should disappear, but there is paleontological evidence to the effect that in the past many types that have specialized in certain directions have gone on developing in that direction, even when overspecialization has resulted in harm and has ultimately led to the extinction of the animal. An example of such a type is the saber-toothed tiger (Fig. 319); its upper canines developed until they became exceedingly effective both in the securing of prey and in defense, but they seem to

have gone on developing until they became a handicap and perhaps were ultimately a factor in its extinction. Another animal often given as an example of overspecialization is the Irish elk the antlers of which were greatly developed; at first this was to the advantage of the animal but later they reached such a size as to impede its progress in the forests and place it at a disadvantage in escaping from enemies. To explain such cases as this it has been suggested that the development of a character is due to a hereditary tendency accompanying a progressive change in the genes, which causes the animal to develop constantly in a certain direction. If the result is to make the animal more effective, natural selection tends to perpetuate the type, but when overdevelopment and disadvantage follow, the hereditary tendencies cannot be reversed and the result is extinction.

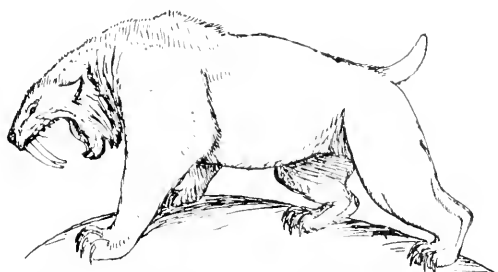

FIG. 319.—Saber-toothed tiger; restoration. (Redrawn from Scott, "History of Land Mammals in the Western Hemisphere," by the courtesy of The Macmillan Company.)

589. Evolutionary Series.—Several evolutionary series exist the best known of which are those of the elephants, horses, and camels.

The earliest known elephant, known as *Moeritherium*, is found in the upper Eocene deposits in northeastern Africa. This animal somewhat resembled a hog in form, with a projecting snout, and was of only moderate size, being between 3 and 4 feet in length. From Eocene time to the present many types have appeared (Fig. 320) which show, in general, an increase in size, the production of a trunk, or proboscis, the development of tusks, and changes in the molar teeth. Present-day elephants are not the largest in the series, which culminated in a type 14 feet high; the largest exact measurement recorded for a modern elephant is 11 feet, though 13 feet has been reported. The trunk, or proboscis, representing an elongation of the nose and upper lip, is at a maximum in the modern types. It is a powerful but delicate prehensile organ used in gathering food and in taking up water, which is then passed into the mouth. In the evolution of the elephants tusks were developed from both the lower and the upper jaws, but in the more recent types those in the lower jaw have been suppressed while those in the upper have been retained and

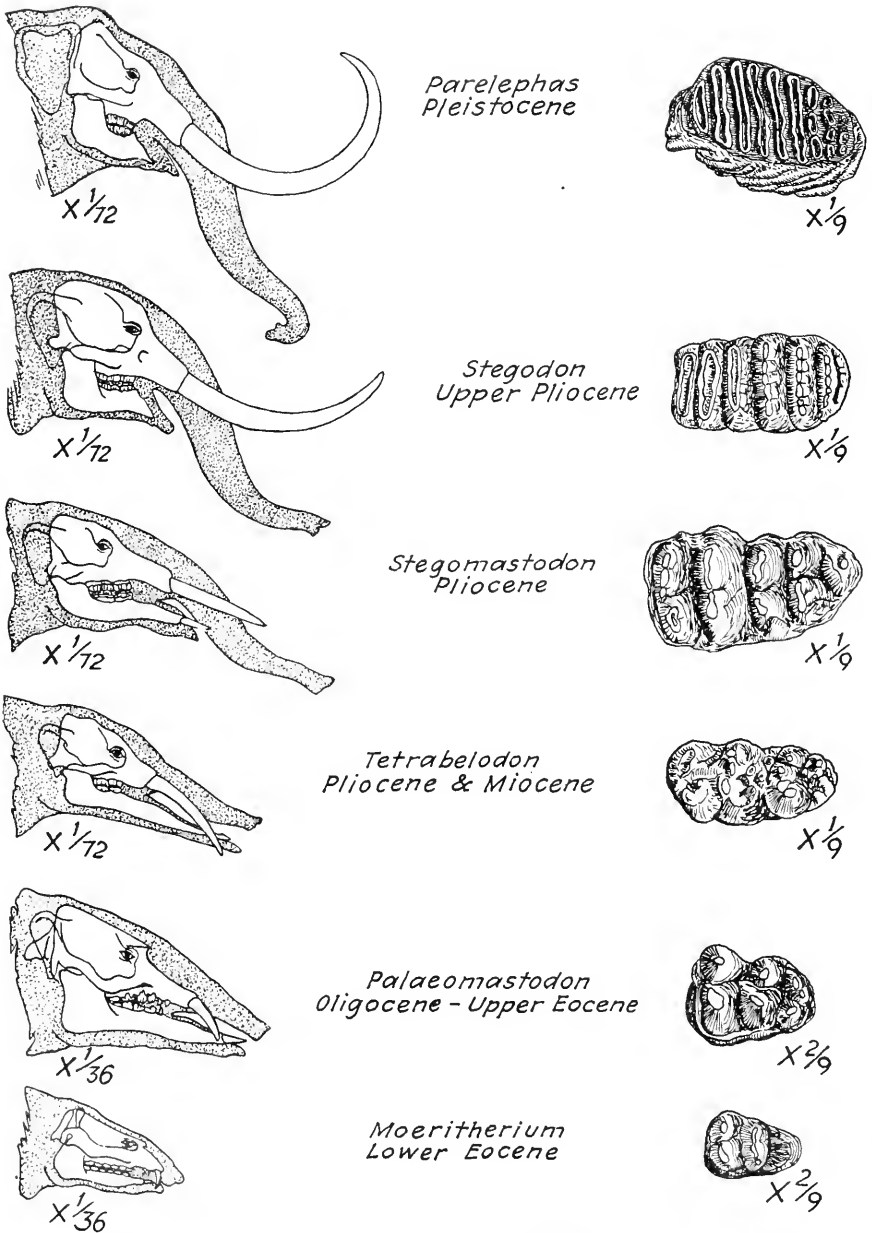

FIG. 320.—A series illustrating several types of extinct elephant-like mammals, and showing on the left the skulls and hypothetical outlines of the heads and probosces, and on the right the grinding surfaces of the corresponding last lower molar teeth. While arranged in a series, beginning with the earliest known form, *Moeritherium*, the types above probably do not represent a single line of descent; *Parelephas* is an extinct cousin of the modern *Elephas* and not an ancestor. *Moeritherium* and *Palaeomastodon* are found only in the Old World, the others in North America. The magnification is indicated for each figure. (From several sources, in general after Lull.)

developed. The length of the tusks possessed by the modern elephants is far exceeded, however, by the tusks of some of the extinct types. This is perhaps an example of excessive specialization. The skull has become very high, a fact which makes it easier for the animal to carry the weight of the large tusks. The molar teeth have become greatly developed and reduced in number, not more than eight being functional at the same time. These teeth, as in all herbivorous animals, are fitted for grinding the food.

The most ancient horses, that from Europe known as *Hyracotherium* and that from western North America as *Eohippus*, also belong to the Eocene period. *Eohippus* (Fig. 321) was an animal about the size of a small dog, standing only about 12 inches high. The head was elongated, the legs and neck only moderately long, and there were four digits on the forelimbs and three on the hind ones. There was little resemblance to a modern horse but the geological record fills in the gaps in the series.

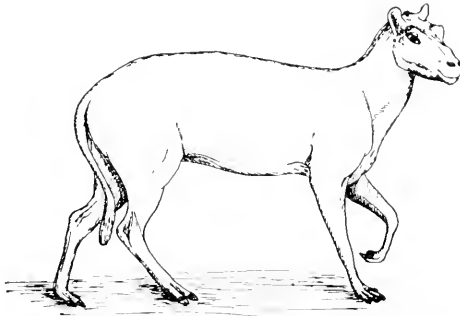

FIG. 321.—A restoration of *Eohippus*. (From a model prepared by the American Museum of Natural History, with permission.)

In the intermediate forms, which lived on open plains, is shown a gradual reduction in the number of toes leading to the one highly developed middle toe which the modern horse possesses. There has also been an increase in size and particularly an increase in length of the limbs and the neck, fitting the animal for speed and for reaching the ground when grazing. The teeth have also become larger and better fitted for grinding and the premolars have become like the molars.

The camels present a third series which parallels that of the horses and apparently illustrates adaptation to similar conditions. The Eocene *Protylopus*, which was about the size of a jack rabbit, had two accessory toes as well as the two toes which exist in present-day types. Its home was in North America. Evolution in this group has been accompanied by reduction in the number of toes; increased length of the limbs, particularly those parts of the limbs representing the hand and foot; an increase in size of both the animal and its skull; and modification of the teeth for grinding. Other adaptations which are prominent in

the modern camels are the development of water storage cavities in connection with the stomach and the development of humps in which fat is stored.

A fourth evolutionary series is that represented by the anthropoid apes and man, but this has been discussed in a previous chapter (Chap. LX).

CHAPTER LXVIII

INHERITANCE IN ORGANISMS

GENETICS

It is a fact old in human experience that resemblances appear between parents and children, and it is to this fact that the adage "like father, like son" refers. Unscientific man overlooked the differences since they did not seem to him significant, but it has been learned that heredity involves inheritance of both resemblances and differences. The science which deals with inheritance is known as genetics.

590. Organisms from the Genetic Viewpoint.—An organism exhibits a number of inherited physical *characteristics* involving size, form, color, character of body covering, structure of internal parts, and so on. In higher animals these become very numerous. It is found, however, that organisms may inherit and may pass on potential characteristics which do not appear in the individual. It has been found that some visible characteristics correspond to one factor in inheritance, some represent two, and still others are the resultant of three or more. Every somatic cell of a metazoan possesses potentially all of the characteristics which belong to the organism, but some cells display certain of these, other cells others of them, and all combined comprise the characteristics of the animal. These characteristics may be other than physical, such as abilities, modes of behavior, and even particular instincts, but these are all based upon structure which is inherited.

591. Determiners or Genes.—In Chap. XI it was noted that the splitting of the chromosomes in cell division had been interpreted as implying the equal division of units arranged in a longitudinal manner along the chromosome thread, these units corresponding to the characteristics of the organism. This interpretation has been supported by many subsequent observations, and it is now accepted as a fact that the split chromosome consists of two series of units, those of one daughter chromosome being opposite those of the other, and each pair resulting from the division of one unit in the chromosome of the parent cell. Thus for each unit in one of the daughter chromosomes there is a similar unit in the other. These hypothetical units are known as determiners, factors, or *genes*, and these form the physical basis for the visible characteristics, which are known as *characters*. There is considerable difference of usage with respect to these terms—determiner, gene, character, and

factor. By some writers all are used synonymously; by others the word character is used in the sense just given.

592. Behavior of Chromosomes in Maturation and Fertilization.—In Chap. XXIII it was stated that synapsis occurred in the growth period of both oogenesis and spermatogenesis. In the next chapter synapsis was explained as being the temporary union of like chromosomes from each of the two parents. It was followed by reduction.

In fertilization (Chap. XXIV) the entrance of the sperm nucleus into the egg cell was described and the statement was made that even after the two pronuclei united the maternal and paternal chromosomes retained their individuality. In each succeeding cell generation in the individual produced from the fertilized egg these maternal and paternal chromosomes appear separate and distinct. In the maturation of the sex cells of this individual, however, synapsis and reduction again take place.

593. Effect of Chromosome Reduction.—In chromosome reduction the two of each pair of chromosomes separate and go to opposite poles of the meiotic spindle of either the spermatocyte or oocyte, as the case may be. Since it is a matter of chance as to which of the two chromosomes will go to either of the two poles, the resulting sperm cells or egg cells may differ from each other in the assortment of maternal and paternal chromosomes which they receive. During synapsis the two chromosomes of each pair may twist about one another and fuse more or less so that when separation occurs the two chromosomes which result may each represent portions of both of the chromosomes which were united. Thus it is apparent that different offspring from the same parents may inherit different combinations of parental characteristics.

594. Allelomorphs.—In fertilization the zygote receives chromosomes from both parents; when the sex cells mature in the individual which develops from this zygote the corresponding chromosomes from the two parents unite in synapsis and hence are called synaptic mates. Corresponding genes exist in such synaptic mates. If the genes for any pair of characters are alike, the individual is said to be *homozygous* for that pair of characters; if not, it is said to be *heterozygous*. The unlike genes of a heterozygous individual are known as *allelomorphs*. Of course the presence of both cannot be shown in visible characters and one will be evident and the other repressed or concealed. The one which is shown is called *dominant*, the other *recessive*. The term *genotype* refers to the whole combination of inherited genes which any individual possesses; *phenotype*, to the assemblage of characters which manifest themselves. If, for example, both genes for hair color in a mammal were alike, the animal would be homozygous and have the common color; if one gene was for red and the other for black, the animal would be heterozygous for this pair of characters and might appear either black or red, depending

upon which showed itself. The one which appeared would be a phenotypic character.

595. Mendel.—The first scientific explanation of the manner in which inherited characters are passed on was given by Johann Gregor Mendel (Fig. 322), an Austrian peasant boy who became a monk and abbot in the monastery at Brünn and who lived from 1822 to 1884. In the monastery garden he experimented with the inheritance of characters in garden peas and formulated laws of inheritance which have come to be known by the term *mendelism*. He published the results of his work in



FIG. 322.—Gregor Johann Mendel, 1822-1884. (From Shull, "Principles of Animal Biology," after Report of the Royal Horticultural Society Conference on Genetics, 1906, and by the courtesy of McGraw-Hill Book Company, Inc.)

1866, but, owing to the fact that his contribution was in an obscure publication and that men's minds were occupied at the time with the subject of evolution and the work of Darwin, which had appeared seven years before, Mendel's contribution remained unknown to scientists until the beginning of the present century. Mendel's work was done before chromosomes were discovered but all that has been learned since has served only to justify his conclusions.

596. Mendelism.—Mendelism involves particularly three principles or laws which may be stated as follows:

1. There is in each individual a pair of hereditary units corresponding to each character which the individual possesses (law of paired units). These we now know as genes, one coming from each parent.

2. When the two hereditary units are unlike, the one which shows its presence by a visible character may be called dominant and the other recessive (law of dominance).

3. In breeding individuals heterozygous for any pair of characters, three kinds of offspring will be produced—those which are homozygous and possess the dominant character; those which are homozygous and possess the recessive character; and those which are heterozygous and show the dominant character (law of segregation).

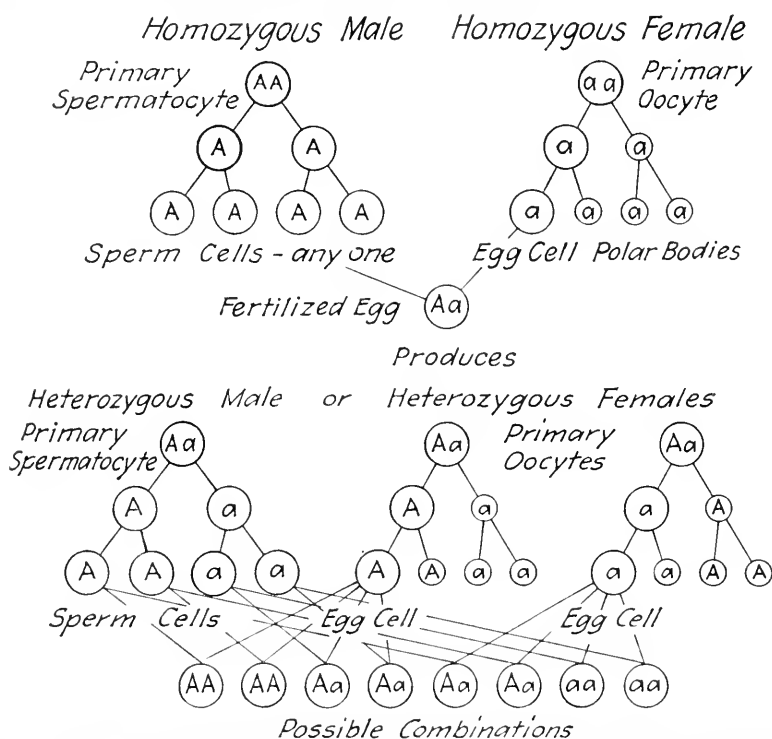

FIG. 323.—Diagram showing the inheritance of unlike characters by a hybrid between two homozygous but unlike parents and the results of interbreeding these hybrids.

597. Hybrids.—In Chap. XXII reference was made to cross-fertilization and hybridization. A hybrid in the sense in which the term was there used referred to the production of an offspring by two individuals belonging to different species. It is evident from what has just been stated that we may also use the term hybrid in reference to heterozygous individuals belonging to the same species. An animal may be a hybrid for certain characteristics and yet be pure-blooded so far as the species or variety is concerned, the characteristics which it possesses being recognized as varying within the species.

598. Distribution of Characteristics in Hybrids.—In crossing two individuals homozygous for the same pair of characters it is evident that

since the genes are similar all progeny will be alike and will resemble both parents. If two parents, both homozygous but for different characters, are crossed, the offspring will all be hybrid and will exhibit the character which is dominant. In crossing these hybrid or heterozygous individuals it is clear that different genes may be distributed to the different sex cells which the individuals develop and that thus when these unite with other cells, varying combinations of genes will occur. For instance, considering only one pair of genes, if the dominant gene received from one parent is indicated by *A* and the recessive gene received from the other parent, by *a*, some of the sex cells will possess *A* and others *a*. In

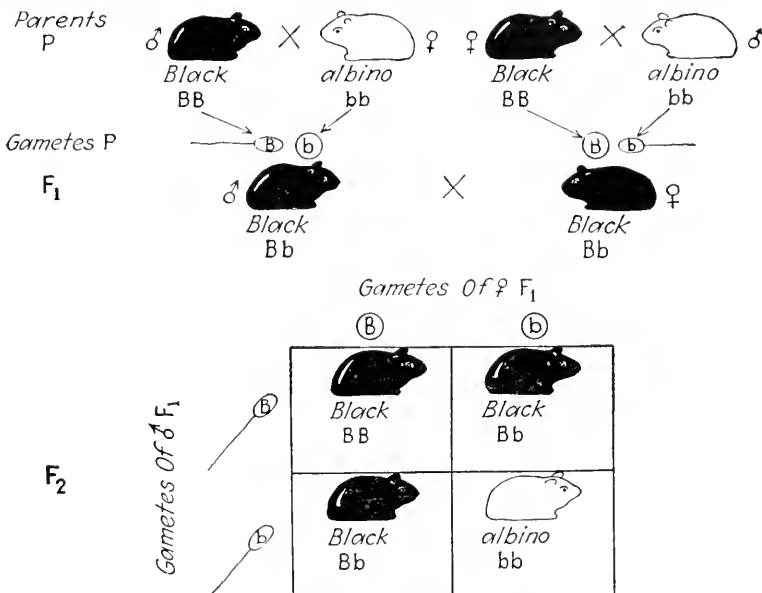

FIG. 324.—Diagram showing the results of crossing two guinea pigs differing by one character and each homozygous for that character, and the checkerboard showing the results in the F₂ generation. (From sketches by D. D. Whitney.)

the union of sex cells two *A*'s may be brought together, or two *a*'s, or an *A* may be united with an *a*. The individuals with two *A*'s and those with two *a*'s are homozygous, while those with *A* and *a* are heterozygous or hybrid for this pair of characters and will show the dominant character. These symbols being placed in circles corresponding to the cells, the facts may be fitted into diagrams showing oogenesis, spermatogenesis, and fertilization in successive generations as indicated in the accompanying schemes (Fig. 323). From these schemes it is apparent how segregation, which is the development of homozygous individuals by the breeding together of hybrids, is brought about. In the discussion of these successive generations it is usual to refer to the generation which forms the starting point as the *P* (parental) generation; the first generation pro-

duced by the union of the sex cells from these parents is the F_1 (first filial) generation; the second is the F_2 (second filial) generation; and other generations are labeled correspondingly.

599. Checkerboard Diagrams.—The possibilities in the breeding of hybrids may also be indicated in a diagram resembling a checkerboard, which shows the gene constitution of sperm cells and egg cells and the

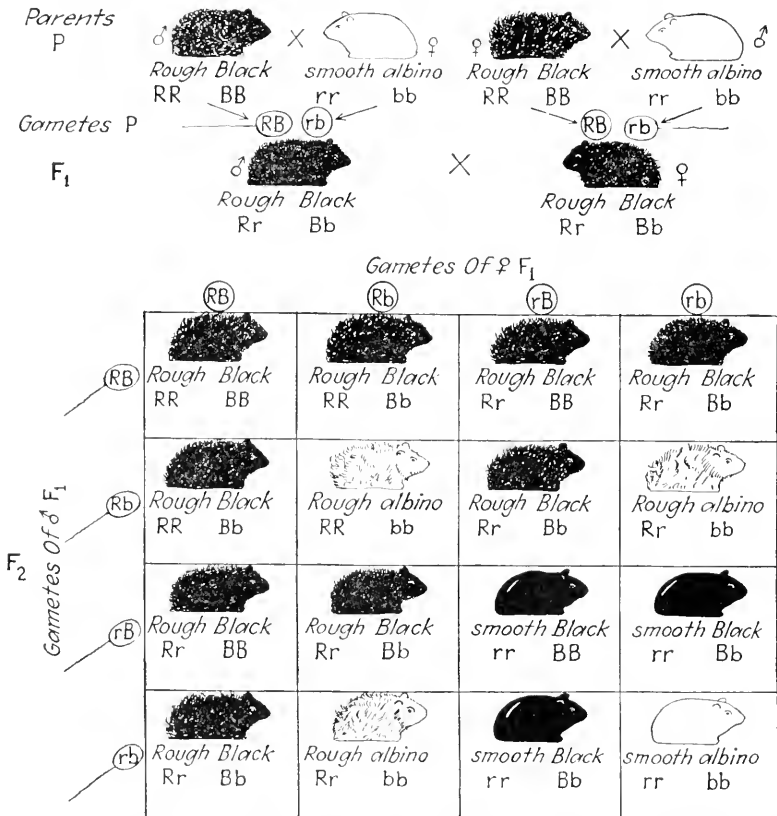

FIG. 325.—Diagram showing the results of crossing guinea pigs differing by two characters, for each of which they are homozygous. The genotypic ratio in the F_2 generation is 4:2:2:2:2:1:1:1:1:1; the phenotypic, 9:3:3:1. (From sketches by D. D. Whitney.)

resulting possible combinations in the offspring. The accompanying diagram (Fig. 324) would illustrate what would happen if the sex cells differed in reference to a single pair of characters, black and albino, represented by B and b . It is clear that in this case the result could be expressed by a ratio 1:2:1, in which the first 1 is an individual homozygous for the dominant character; the second 1 is an individual homozygous for the recessive character; and the 2 is for the two individuals which are heterozygous or hybrid for these characters. This is the genotypic ratio; the phenotypic ratio would be 3:1, since three individuals, including the

homozygous and dominant and the two heterozygous individuals, would show the dominant character, while the other, which is homozygous and recessive, would exhibit the recessive character.

600. Multiple Hybrids.—So far we have considered individuals heterozygous for only a single pair of characters. Such individuals are termed *monohybrids*. Since every individual is a combination of large numbers of characters, however, it is clear that an individual is likely to be a hybrid not for one characteristic but for more. If hybrid for two, the individual may be termed a *dihybrid*; if for three, a *trihybrid*; and if for more, it is usually called a *multiple hybrid*. In these cases the variety of sex cells produced would be greater and the number of possible combinations in the offspring would be very much greater. A checkerboard diagram for a dihybrid cross in which the characters are represented by *R*, *r*, *B*, and *b*—for rough and smooth, black and albino—would appear as in the diagram (Fig. 325).

There would be four types of sperm cells and four types of egg cells. The phenotypic ratio would be 9:3:3:1, in which 9 represents individuals that show both dominant characters; 3 are dominant for the first pair of characters but recessive for the second; 3 are recessive for the first pair but dominant for the second; and 1 is recessive for both pairs. The genotypic ratio would include nine types of individuals as indicated by the diagram.

A corresponding phenotypic ratio for a trihybrid cross in which there are eight types of sperm cells and eight of egg cells would be 27:9:9:9:3:3:3:1. In this case 27 would show all three dominant characters and only 1 would show all three recessive characters, the others being varying combinations of dominants and recessives. There are here 27 different genotypes.

601. Actual Cases.—Certain cases may be given to illustrate the actual results of crossings. It should be observed that since these ratios are based on chance they may not hold good in individual cases where small numbers are involved. The larger the numbers the closer they are likely to be approached. Mendel crossed tall pea plants with short pea plants, where tallness is a dominant character and shortness a recessive one. The hybrids were all tall. He found that in breeding these hybrids three-fourths of the offspring were tall and one-fourth short but that of the three-fourths which were tall one-third were pure for this character and two-thirds were hybrid. Mendel actually obtained in the second filial generation from original parents, one of which was tall and the other short, 787 tall plants and 277 short ones, when, if the results had been mathematically exact, he should have had 798 tall and 266 short ones. Other experiments have resulted in ratios more nearly mathematically exact, and the departure has not been considered sufficient to invalidate the principle involved.

If two pairs of characters, one pair for curly hair and straight hair, curly being dominant, and the other pair for dark color and light color, dark being dominant, are represented in the breeding of hybrid individuals, then nine of the phenotypes will have dark, curly hair; three will have dark, straight hair; three will have light, curly hair; and one will have hair which is both light and straight.

The result when three pairs of characters are involved is illustrated by the work of Castle on guinea pigs. When a short-haired, dark-colored, and smooth-coated guinea pig is crossed with one which is long-haired, white, and rough-coated, all of the F_1 generation will belong to one phenotype and will be short-haired, dark-colored, and rough-coated, since these are the dominant characters. When these individuals are bred together, however, they will produce eight different phenotypes. Twenty-seven will have hair which is short, dark, and rough; nine will have hair which is short, white, and rough; nine, hair which is long, dark, and rough; nine, hair which is short, dark, and smooth; three, hair which is long, white, and rough; three, hair which is short, white, and smooth; three, hair which is long, dark, and smooth; and one, hair which is long, white, and smooth.

602. Breeding the Test for Characters.—In determining the genetic constitution of an animal the test applied is that of breeding. If individuals bred generation after generation show only one character, then they must be homozygous for that character; if they are hybrid, breeding will betray the fact. The genetic constitution of an animal the genotypic character of which is unknown may be determined by breeding it with other animals the genotypic character of which is known.

603. Variations in Inheritance.—The result of an enormous amount of experimental work has shown that while there are certain characters in plants and animals that behave exactly according to Mendel's principles, others do not. This has been explained in some cases by assuming that there are unpaired genes but in more cases by assuming that interactions occur between genes. It has also been found that genes may change, causing the characters to vary. A heritable change appearing in a line of descent which cannot be traced to any ancestor is known as a *mutation*. A *mutant* is an animal which shows such a change.

With respect to the *absence of a gene* it is evident that dwarfness might be due to a gene for dwarfness or to the absence of a gene for tallness. The first alternative could be indicated graphically by the use of the letters T and D , T being dominant; the second by using T and t , t showing the absence of T . A pure recessive would be either DD or tt .

An example of the *interaction of genes* is what is known as *blending inheritance*, in which case the F_1 generation differs from both parents and is intermediate with respect to a certain pair of characters, but in the F_2

generation there are individuals like both grandparents as well as intermediates. This occurs in the case of plants called four-o'clocks; plants with red flowers crossed with those with white flowers produce hybrids with pink flowers, and when these pink hybrids are crossed the result is a ratio of one red dominant, two pink hybrids, and one white recessive. Another case of blending inheritance is that of the blue Andalusian fowl (Fig. 326), which is a hybrid between a black individual and an individual which is white splashed with black. When these blue Andalusians

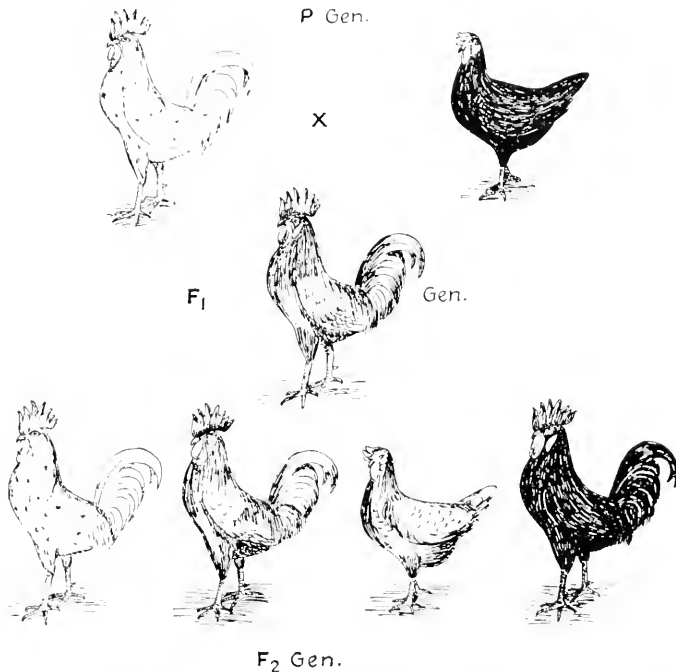

FIG. 326.—Blending inheritance, as illustrated by the blue Andalusian fowl. The P generation is splashed white and black, the F_1 generation all blue, and the F_2 generation, one splashed white, two blue, and one black.

are bred, there is in the F_2 generation a ratio of one splashed white, one black, and two blue individuals.

Another variation is that due to the cumulative effect of *duplicate genes*. This is observed in mulattoes, whose skin color may vary from very dark to very light. It has been found that there are *lethal genes* which when present in pairs cause the death of the organism. In some cases a character is believed to result from the interaction of two genes, neither one of which when alone shows itself. These are called *complemental genes*.

It has recently been demonstrated that radiations, particularly X-rays, are capable of bringing about gene mutations (See. 587).

604. Breeding for Certain Characteristics.—In both animal and plant breeding the end sought is the bringing together of desirable characters and the development of stock which will breed true for those characters. This involves the careful selection of breeding animals and the elimination of all progeny which are not homozygous for each pair of characters desired. In this way, and by persistent inbreeding, a line can gradually be developed which not only possesses the desired characters but also has them in pure form or, in other words, is homozygous for them. The final result is an artificial variety or strain which can be maintained by the exercise of sufficient care. If only one character is sought which is a pure mendelian character, this is not a long process, but since characters may be in view which are the result of interaction between genes, considerable experimentation and judicious selection are often required to arrive at the desired result.

605. Inbreeding and Crossbreeding.—Inbreeding is the breeding of closely related individuals; crossbreeding, the breeding of those not so related. There are genes in man which correspond to certain defects such as deafness, certain types of insanity, feeble-mindedness, and a tendency to excessive bleeding known as hemophilia. These defects are usually recessive. Since they are usually recessive, when present and paired with a normal character they do not appear; if not so paired the defect becomes apparent. For this reason inbreeding is likely to bring out these defects to a much greater degree than crossbreeding, in which the chances are great that the other individual will be normal with respect to the defect which the one may have. If there are no defects in the inheritance, inbreeding has no ill effects; on the contrary if the inheritance contains many valuable qualities the result may be to produce superior individuals.

Crossbreeding has been found in some cases to result in increased vigor, called heterosis. That is true in the breeding of mules. This is, however, often accompanied by sterility.

606. Inheritance of Acquired Characters.—From what has been said it is evident that since the characters of an animal are determined by its inheritance, any somatic character acquired during the lifetime of the individual cannot be passed on unless it is accompanied by a germinal modification. Since zoologists define acquired characters as purely somatic modifications, it is not possible for them as such to be passed on. Whether or not these somatic modifications can so affect the germ cells as to produce a germinal modification which can be transmitted is not known. No convincing proof, however, has ever been presented of this having occurred, and so at the present time the possibility of the inheritance of acquired characters in any fashion is not generally accepted, though it is recognized by many as conceivable.

607. Inheritance of Disease and Abnormalities.—In Chap. LXVIII reference was made to the inheritance of disease. Abnormalities, such

as extra digits, which are not an evidence of disease, are also heritable. Disease inheritance may be due in certain cases to the actual passing on of disease-producing organisms from parent to offspring; but it is also clear that diseases and abnormalities due to defective genes may be inherited. Most of these defective genes, as has been stated above, are recessive, but a few are dominant. Among the latter are those for diabetes insipidus, a disease characterized by an insatiable thirst and the production of an excessive amount of urine; hereditary night blindness; congenital cataract; and the presence of extra digits or of short digits on either hands or feet. Among the recessive defects, aside from feeble-mindedness, are those of dwarfness and certain types of nerve degeneration causing paralysis.

608. Sex Determination.—In all that has hitherto been said of chromosomes reference has been made only to what are called ordinary chromosomes, or *autosomes*, which exist in pairs. There are, however, odd chromosomes, which, because of their connection with the determination of sex, are known as *sex chromosomes*.

In the males of certain insects there are two sex chromosomes, recognized as the *x*-chromosome and the *y*-chromosome, the latter being the smaller; but in the males of other animals there may be only one sex chromosome and this an *x*-chromosome. In both cases in the female there are two *x*-chromosomes. Experiments have shown that it is the *x*-chromosome which in some way determines sex.

Since in chromosome reduction these odd chromosomes must go to either one sex cell or the other (Fig. 327), it follows that in cases in which the male has one *x*-chromosome, only half the sperm cells will contain such a chromosome, while, since the female has two, all of the egg cells will contain one. If a sperm cell which contains an *x*-chromosome unites with the egg cell, then the zygote will contain two *x*-chromosomes and from it will develop a female; if, on the other hand, the sperm cell without an *x*-chromosome unites with an egg cell, the zygote will contain only one *x*-chromosome and will be male. In case the male possesses both an *x*-chromosome and a *y*-chromosome, then the *x*-chromosome goes one way and the *y*-chromosome the other, and the result is that there are again two types of sperm cells. If the sperm cell containing the *x*-chromosome unites with the egg cell also containing an *x*-chromosome, a female is produced; but if the sperm cell containing the *y*-chromosome unites with an egg cell, then a male is produced, with both an *x*-chromosome and a *y*-chromosome.

In other cases instead of there being two kinds of sperm cells there are two kinds of egg cells. In fowls and in moths females have either one *x*-chromosome or both an *x*-chromosome and a *y*-chromosome, while the males have the two *x*-chromosomes. In this case it is the type of egg cell which is fertilized that determines sex.

In man, and perhaps in all mammals, there are an x -chromosome and a y -chromosome in the male and two x -chromosomes in the female. Man also has 46 autosomes. The formulae for the two sexes may be written: $\sigma = 46 + x + y$; $\text{♀} = 46 + 2x$. The sex cells are $23 + x$ or $23 + y$.

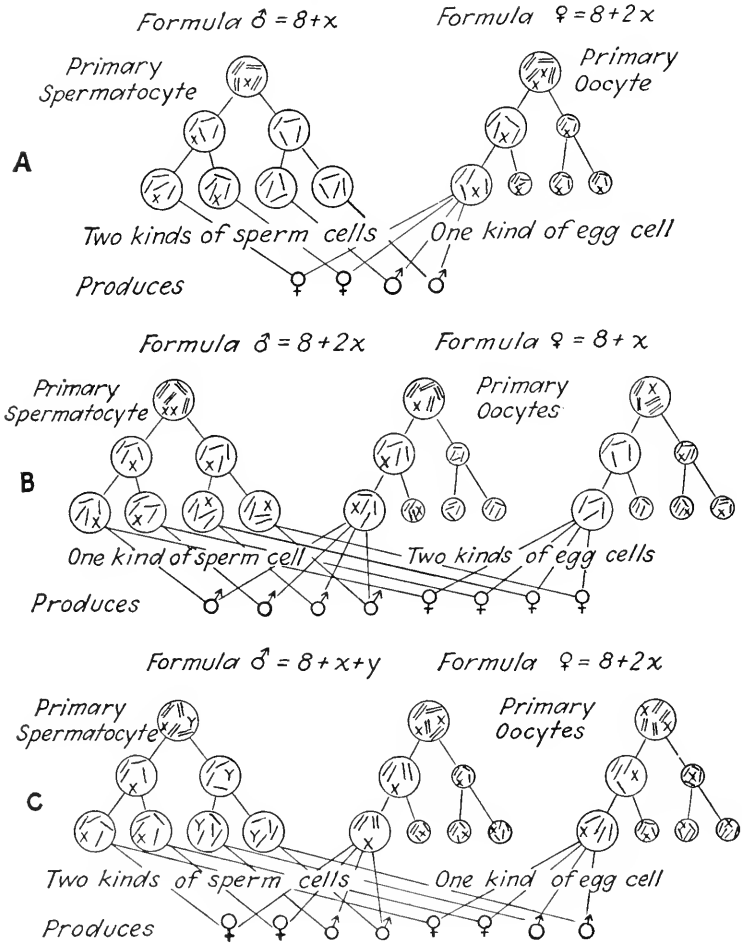

This may be reversed as in the case of A and B

FIG. 327.—Diagrams illustrating sex determination in three different cases.

609. Twins.—The production of twins may be mentioned in connection with sex. There are two types, known respectively as identical and fraternal twins. *Identical twins* agree precisely in their characteristics and are always of the same sex. For this reason it is assumed that they are due to the separation of blastomeres developed from a single zygote, each group of blastomeres developing into a complete individual. In the case of the nine-banded armadillo it has been found that the four

young usually produced are identical quadruplets resulting from the development of a single zygote and possessing a common placenta. On the other hand *fraternal twins*, being produced from two zygotes, may differ in sex and in other characteristics to the same extent that two offspring produced by the same parents at different times may differ.

610. Determination of Sex in Parthenogenesis.—It appears from what has just been stated that sex is determined at the time of fertilization. This suggests the question of sex in parthenogenesis, but there is little precise knowledge of the sex chromosomes in parthenogenetic types. In all cases the parthenogenetic females have the diploid number of chromosomes and when they produce another female generation no reduction division occurs and the diploid number is preserved. At certain times males are produced and since reduction does occur in this case they have the haploid number. They produce two kinds of sperm cells. The development of those of one kind is arrested at some stage; they are non-functional and die without uniting with an egg cell. Those of the other kind do fertilize egg cells, which of course have the haploid number, and from these zygotes females develop which have the diploid number of chromosomes and which may initiate other lines of parthenogenetic female generations. It is known that in the case of the honeybee a fertilized egg produces a female, with the diploid number of chromosomes, and an unfertilized egg a male, with the haploid number. It has been suggested that the male may have one sex chromosome and that all the functional sperm cells possess one, those with none not developing. The female would have two sex chromosomes and all unfertilized egg cells would have one. This would explain the uniform development of females from fertilized egg cells. In the rotifers two kinds of eggs are produced, those of one kind undergoing no reduction and therefore developing females, while those of the other kind undergo reduction and develop into females or males, depending on whether or not they are fertilized.

In the case of parthenogenetic types it has been shown that feeding has an effect upon sex. Whitney has found that when rotifers are fed an abundance of green flagellates the number of males in the F_2 generation is increased, while if colorless flagellates are fed, the reverse is the case. The effect may be exerted through modifying the tendency to chromosome reduction.

611. Sex-linked Characters.—The sex chromosomes not only determine the sex but also carry genes for many other characters. It thus follows that these characters will be determined when sex is determined and will be associated with one sex or the other. In the case of color blindness in man the defect is carried in the x -chromosome in the male and is recessive, while normal vision, which is dominant, is carried in the x -chromosome in the female. The sex chromosome carrying the defect may be indicated by x . A color-blind father (xy) and a normal mother

(xr) will have no color-blind children, since the zygotes will be either xy or xr . In the F_2 generation, however, one-half the grandsons and one-half the granddaughters are free from this defect and the other half of the granddaughters carry the gene for color blindness as a recessive. A normal father with a color-blind mother will have only color-blind sons while the daughters will be normal. Also one-half the grandsons and one-half the granddaughters will be color-blind. There are many such sex-linked characters. These should not be confused with other characters which distinguish one sex from the other, since the corresponding genes are carried in autosomes and the characters are developed under the influence of hormones produced in either the ovary or the testis.

612. Linkage and Crossing Over.—It is evident that many characters not associated with sex may be linked in inheritance because of the fact that the genes are carried in the same chromosome. In particular cases, however, it is found that such *linkage* is broken. This can be explained only by assuming that when two chromosomes unite in synapsis there is fusion at certain points and that when they separate portions of the two are exchanged. This is called *crossing over*. The existence of such linked characters and of crossing over has been seized upon as a means of determining the position of genes in the chromosomes. In the fruit fly, *Drosophila*, where a number of such characters occur, it has been found that by comparing cases of variation in linkage the chances of such crossing over vary. It may be assumed that when genes are far apart the chances are greater than when they are close together. As a result of thousands of experiments by Morgan and his students it has been found possible in the case of the fruit fly to locate the genes concerned in the production of a large number of characters not only in particular chromosomes but also at particular points in those chromosomes.

613. Eugenics.—The application of the principles of genetics to the production of human offspring with the aim of developing a superior race has been strongly urged. This field of investigation and social endeavor is known as *eugenics*. There are many individuals and organizations seeking to develop an intelligent eugenic program, to secure its adoption, and through it to improve the human race. The adoption of such a program, however, can be brought about only as a result of long-continued agitation and the gradual education of the public.

CHAPTER LXXIV

CLASSIFICATION OF ANIMALS

TAXONOMY

Taxonomy is that field of zoology which deals with the classification and nomenclature of animals. It has often been referred to, especially in the past, as systematic zoology. A number of matters properly belonging



FIG. 328.—Carolus Linnaeus, 1707–1778, at the age of forty. (From Shull, "*Principles of Animal Biology*," by courtesy of the New York Botanical Garden, and of McGraw-Hill Book Company, Inc.)

to this field were considered in Chap. XIV, and while they should be reviewed in connection with this subject they will not be repeated here.

614. History.—The first known systematic arrangement of animals is that of Aristotle, who divided the animal kingdom into the Enaema, or blood-holding animals, which included forms with red blood; and the Anaema, or bloodless animals, which included all the rest. Each of these categories contained four groups, all of which were founded on superficial characteristics. Following the revival of learning and the era of discovery at the end of the Dark Ages, an enormous number of new species of animals from all corners of the earth became known. Aristotle's

system was inadequate and so there was great confusion in the classification and naming of animals. A step forward, however, was taken by Ray (1628–1705), who first fixed a definite conception of a species and also used anatomical facts in the discrimination of the larger groups. His work paved the way for that of Linnaeus (1707–1778). Linnaeus (Fig. 328) believed in the fixity of species and his classification was distinctly artificial, but it is so simple in theory, so clear, and so plastic that it has furnished the basis of all the work in this field which has been done since. He divided animals into six classes (four of which were vertebrate groups), 32 orders, and a large number of genera and species. He also gave a brief characterization in Latin of each higher group and of each species. While they were sufficient for the limited number of groups and species recognized then, these characterizations are not sufficiently detailed or exact in the light of our present knowledge; however, they served as models for those who followed him. It is to be observed, moreover, that his groups were of much higher rank than the groups given the same names today, his classes being equivalent to present-day phyla, his orders to what are now classes, and his genera to orders as now recognized. While we use his generic names we have greatly limited the extent of his genera. Linnaeus believed in the possibility of arranging animals in a single series. To Lamarek (1744–1829) is to be given credit for first recognizing the fact that there are different lines of descent in the animal kingdom and for representing this in the form of what has since been known as a genealogical, or phylogenetic, tree. The effect of the general acceptance of the evolutionary conception was to cause a change toward a more natural system of classification. In 1866, Haeckel presented the first really modern classification.

615. Species.—While to most people a species seems to be a very definite conception, insuperable difficulties are immediately encountered when an attempt is made to define it. Although many criteria have been used in the definition of species, it is still a matter of opinion as to whether a species is a natural entity or an artificial assemblage of individuals and as to what terms shall be used in the definition of the word. An assemblage of individuals which to one zoologist appears clearly separable into a number of species may be considered by another as simply representing the variations possible in one. The extent of any taxonomic group is to a considerable degree a matter of opinion. Generally speaking, the differences between species are qualitative. If the differences between two forms are only quantitative, such as differences in size and shade of color, the usual conclusion is that they are only forms of one species. Some species are very conservative, exhibiting little variation throughout their range; others are radical, varying with every change in the environment.

616. Polymorphism.—When the variation within a species is marked, when the different forms are not connected by intermediate gradations, and when they can be correlated with some other factor or condition, then the species is called polymorphic and is said to exhibit *polymorphism*. If there are but two types, dimorphic and dimorphism are usually the terms used. Sexual dimorphism is present in the large majority of animals, the male and female being recognizable by characteristic features. What might be called sex-linked polymorphism is shown by some butterflies, the males of which are all alike, the females being of different types; in other animals the males may be polymorphic. Polymorphism may also be geographical, climatic, seasonal, or social. Many widely distributed animals are represented by so-called subspecies, varieties, or geographical races, which are often also directly related to climatic conditions and represent geographical and climatic polymorphism. Insects which have several broods in a year may exhibit seasonal variation; and ants and bees are examples of social polymorphism, accompanied by division of labor. Some tropical butterflies show several color variations which may all appear together at the same time and place.

617. Basis of Classification.—The basis of classification is, of course, the resemblances and differences which exist between animal types. It has been seen, however, that resemblances may be of two kinds, homologous and analogous. It has also been shown that resemblances may be due to convergence, which, of course, means analogy, and that differences may be due to degeneration and retrogression. All of these tend to interfere with a recognition of natural relationships among animals. The biogenetic law has a bearing here, and it is usual to consider evidence from early stages in the life of an animal as very important in revealing its real affinities. All of these things have to be carefully considered in arriving at a truly natural classification.

618. Basis of Nomenclature.—Our nomenclature is based upon a proposal made by Linnaeus that the name of each animal shall be composed of two parts: the name of the genus and of the species to which it belongs. This is what is known as *binomial nomenclature*. In recent years there has been a tendency, especially in connection with certain groups of animals, to add to these scientific names a third, or subspecific, name, and even in some cases a fourth, or varietal, name. If this practice becomes general, our nomenclature will become either trinomial or quadrinomial. At present it remains distinctly binomial. The method of citation of a species was described in Chap. XIV.

619. Rules of Nomenclature.—It has been stated that Linnaeus knew only a limited number of species. His work proved such a stimulus to systematic zoology that the number of these rapidly multiplied. Contributions were published in all parts of the world and in all civilized languages, and the number of species became so great as to cause much

	Germ layers	Symmetry	Divisions of body	Digestive mechanism	Anus	Coelom	Nervous mechanism	Peculiar structures
III. Coelenterata.....	Diploblastic	Radial	A n e v e n number of antimeres	Simple gastrovascular cavity	No	No	Scattered nerve cells and fibers, in higher forms collected into nerves and sense organs	Nematocysts
IV. Ctenophora.....	Triploblastic	Radial and bilateral	Eight antimeres	Gastrovascular cavity with canals	No	No	About same; aboral sense organ	Paddle plates
V. Platyhelminthes.	Triploblastic	Bilateral	Not divided into parts	Branched gastrovascular cavity	No	No	Central ganglion and nerves	Flat body; parasitic forms much modified
VI. Nemertinea.....	Triploblastic	Bilateral	Not divided into parts	Simple alimentary canal	Yes	Doubtful	Similar to preceding	First blood-vascular system. Peculiar proboscis
VII. Nematelminthes	Triploblastic	Bilateral	Not divided into parts	Simple alimentary canal	Yes	A body cavity but not a true coelom	Pharyngeal ring and dorsal and ventral nerve cords	Cylindrical body. No blood-vascular system
VIII. Chaetognatha...	Triploblastic	Bilateral	Not divided into parts	Simple alimentary canal	Yes	Yes	Dorsal and ventral ganglia	No blood-vascular system
IX. Rotifera.....	Triploblastic	Bilateral	Not divided into parts	Canal divided into regions	Yes	Similar to Nematelminthes	Similar to Platyhelminthes	Ciliated discs. Cement glands. No blood-vascular system
X. Bryozoa.....	Triploblastic	Bilateral	Not divided into parts	Simpler than preceding	Yes	Yes	Similar to Platyhelminthes	Mostly colonial. Lophophore. No blood-vascular system
XI. Brachiopoda.....	Triploblastic	Bilateral	Not divided into parts	Similar to preceding	Yes (exceptions)	Yes	Similar to Nematelminthes. Dorsal and ventral ganglia	Dorso-ventral shell and peduncle. Lophophore. A blood-vascular system

	Germ layers	Symmetry	Divisions of body	Digestive mechanism	Anus	Coelom	Nervous mechanism	Peculiar structures
XII. Echinodermata	Triploblastic	Radial (secondary)	Odd number of antimeres	Tends to go back to gastrovascular cavity	Tends to disappear	Yes	Scattered nerve cells, oral nerve ring, and radial nerves	Spines, plates, and water-vascular system. Show retrogression
XIII. Mollusca.....	Triploblastic	Bilateral	Not divided into parts	Alimentary canal varying from simple to very complex	Yes	Yes	Scattered ganglia and nerves. Highly centralized in cephalopods	Mantle, shell, and ventral muscular foot (modified in cephalopods)
XIV. Annelida.....	Triploblastic	Bilateral	Similar metameres	Alimentary canal divided into regions	Yes	Yes	Ventral, gangliated cord	Setae or suckers. In some parapodia. Blood-vascular system from now on
XV. Arthropoda....	Triploblastic	Bilateral	Metameres dissimilar	Becomes highly specialized	Yes	Yes	Ventral gangliated cord and true brain	Chitinous exoskeleton and paired jointed appendages
XVI. Chordata ...	Triploblastic	Bilateral	Metameres tend to become obscured	Highly specialized	Yes	Yes	Dorsal, tubular central nervous system	Notochord (or vertebral column). Pharyngeal slits at some time in life

FIG. 329. Table showing certain characteristics of the phyla of the Enterozoa. Protozoa and Porifera, being not comparable to these phyla, are omitted from the table.

confusion as to the correct names of animals. As a consequence somewhat more than a half century ago a very strong demand arose for the formulation of a system of rules by which confusion could be avoided. Out of the agitation has developed an International Commission on Zoological Nomenclature the work of which is represented both in a code of rules and in a long series of decisions, involving particular cases, which have been officially promulgated by the Commission.

According to these rules a family name is made by adding *-idae* to the stem of the name of a genus selected as the type. Thus the type genus of the cats is *Felis* and so the family name is *Felidae*. The name of a subfamily is made in the same way by adding *-inae*. Whenever for any reason the type genus is changed then the name of the family must be changed accordingly. Generic names must be single words written with a capital letter and specific names either a single or compound word written with a small letter. The generic name is nominative singular in form and the specific name is an adjective in grammatical agreement with it. The author of a name is the first person who definitely attached that name to the particular species. There has, however, been a considerable amount of confusion in literature in regard to who first described a given species and also as to whether or not certain species are actually distinct. This makes necessary a decision as to priority and in connection with this matter of priority most of the decisions of the International Commission have been rendered. The best usage in the description of a new species is to designate a particular specimen as a type and to state exactly where the type is to be found and how it is to be recognized. Recognition is usually by some particular number. The commission has not undertaken to make any pronouncement in regard to the names of groups higher than families, and, therefore, the names of the higher groups that any particular writer adopts are evidences of individual opinion.

620. Phyla.—In earlier chapters of this text the various phyla have been briefly reviewed and the characteristics and advances shown by each noted. It may be well at this point to present a table (Fig. 329) comparing the characteristics of the different ones. However, two phyla, the Protozoa and the Porifera, are omitted because their plan of structure is so different from that of the rest that they cannot be brought directly into comparison with them. Reading vertically down the columns of this table will furnish an indication of the trends in development of particular characteristics, while reading horizontally will give briefly the characteristics of the individual phylum.

621. Phylogenetic Tree.—Various diagrams representing a phylogenetic tree have been presented, reflecting different ideas of the interrelationships of animal groups. One of the defects of many of these diagrams has been that in spite of the fact that the animal kingdom

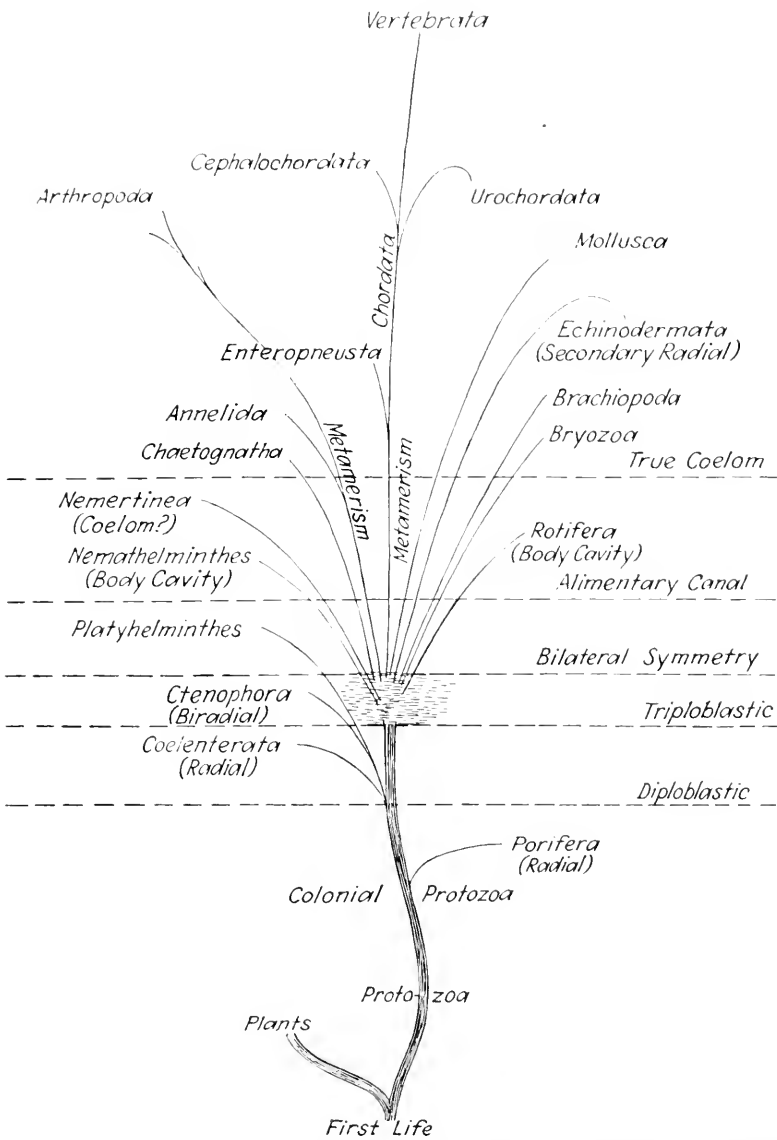

FIG. 330.—Diagram of a phylogenetic tree illustrating one conception of the relationship of the animal phyla, and also suggesting the uncertainty attending the relationship of most of the different phyla above the Coelenterata. Levels of organization are indicated by horizontal lines of dashes. Retrogression is suggested by the branch turning downward. Enteropneusta is a class of Hemichordata which includes Balanoglossus.

represents not one line of descent but many, the diagrams have represented it as possessed of one main trunk with all of the branches springing from it. The relationship between the various phyla above the coelenterates is so uncertain that in the present state of our knowledge it seems impossible to present exact continuity here. In interpreting such a diagram the fact should also be borne in mind that no existing type is ancestral to any other existing type but that if the two are related this relationship is through a common ancestor, now extinct. With these facts in mind the accompanying scheme (Fig. 330) is presented.

CHAPTER LXXV

HISTORY OF ZOOLOGY

The field of medicine, and in connection with it certain aspects of zoology, was developed to a considerable extent by the early Egyptians, a medical papyrus translated by Ebers dating from as early as the fifteenth

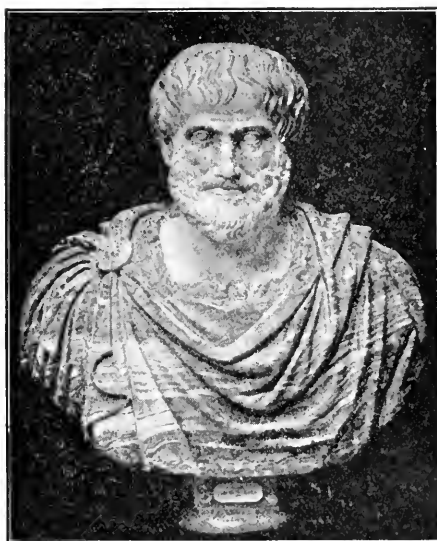

FIG. 331.—Aristotle, 384–322 B.C. (From Shull, "Principles of Animal Biology," after Hekler, "Greek and Roman Portraits," and by the courtesy of McGraw-Hill Book Company, Inc.)

century before Christ. The beginnings of modern science, however, must be sought in the writings of the Greeks.

622. Greeks.—The history of zoology in Greece may be begun with the name of Thales (624–548 B.C.), who had a theory that the ocean mothered all life. Empedocles and others have been referred to in the chapter on evolution. Hippocrates (460–370 B.C.), who placed medicine on a scientific basis, has been called the father of medicine. The work of the early Greeks was largely of a philosophical nature and was not based upon exact observation. Aristotle (Fig. 331), however, to whom we owe the scientific method, the basis of which is the gathering of facts from direct observation, used that method in his work and thus reached scientific conclusions. In addition to inherited wealth, social position, and excellent education, he had the advantage of the first endowment for

zoological research of which we have any record. By his royal patron, Alexander the Great, he was given a grant of 800 talents, which is equivalent to about \$1,150,000 of our money but with a purchasing value corresponding to \$4,000,000 today (Durant). With this assistance Aristotle gathered extensive collections and made many very precise observations. He knew that some sharks are viviparous and that an attachment is formed between the young and the wall of the uterus of the female. He also observed the development of the chick and viewed that of animals in general as a process of the gradual building of complex structures from a



FIG. 332.—Andreas Vesalius, 1514–1564. (From Shull, "Principles of Animal Biology," after Garrison, "History of Medicine," and by the courtesy of McGraw-Hill Book Company, Inc.)

simple beginning. Although many of his ideas were erroneous, Aristotle's work was the beginning of scientific zoology, and consequently he has been known as the father of zoology. He also furnished the first classification of animals. That his work was not the first is evident from his reference to facts gleaned from "the ancients," but those facts were inconsiderable in value compared to those which he accumulated. The Greeks who followed him added little. Galen (131–201 A.D.) was a physician and an anatomist whose contributions were based largely on actual observations of animals and who in his work brought together all the anatomical knowledge of his time.

623. Dark Ages.—From the decay of Greek civilization to the revival of learning in the sixteenth century little advance was made. Pliny

(23-79 A.D.), a Roman general, compiled a great work of 37 volumes in which he undertook to bring together all of the knowledge of the time, but in this work facts were so inextricably confused with legendary matter and superstitions of all sorts that it was practically worthless. Throughout this period authority reigned supreme and curious conceptions held sway, including the belief that man had one less rib than a woman, since, according to the biblical account, one rib had been taken from Adam to create Eve. Another curious belief was in a resurrection bone which was believed to be the foundation from which the new body was to be developed after resurrection from the dead. Scientific observation had



FIG. 333.—William Harvey, 1578-1657. (From Shull, "Principles of Animal Biology," after Garrison, "History of Medicine," and by the courtesy of McGraw-Hill Book Company, Inc.)

given way to speculation. It is interesting to note, however, that during this time the evolutionary conception was kept alive through the influence of members of the church, although it was, at the same time, the influence of the church which led to this overemphasis on authority.

624. Vesalius.—The first name that stands out during the Renaissance is that of Vesalius (1514-1564), a Belgian anatomist (Fig. 332) who defied authority and grounded his human anatomy on the dissection of the human body. He thus effected a great reform in anatomical teaching, which up to that time had been based entirely upon the works of Galen. Vesalius gave a detailed description, with illustrations, of the veins and arteries and knew that they came close together peripherally but considered each separate from the other. He believed that in each there

was an ebb and a flow of the blood. His classical work on the structure of the human body was published in 1543.

625. Harvey.—Harvey (1578–1657), an English physician (Fig. 333), revived the experimental method in physiology. His most noteworthy contribution was the proof of the circulation of the blood. Aristotle believed that the blood was elaborated from the food in the liver, was conducted to the heart and then out from the heart through the veins. He and others who followed him thought that the arteries contained no blood but that they carried the vital spirits, or *pneuma*. Galen discovered that the arteries did contain blood; he distinguished nerves from tendons, which look much like them, and believed the former carried the *pneuma*. Vesalius proved that the two sides of the human heart were completely separated, and Servetus (1511–1553) outlined the circulation in the lungs. Jacobus Sylvius (1478–1555) described valves in the veins. The complete circulation was first discovered and definitely described by Harvey. He used no microscope, however, and neither saw the capillaries nor demonstrated their existence; this work remained for Malpighi and Leeuwenhoek.

626. Microscopists.—The actual discovery of the microscope is unknown, though by many its discovery is attributed to Galileo. With the improvement of this instrument an era of discoveries began which was to affect the whole future of biology. The earliest of the microscopists and perhaps the most eminent was Malpighi (1628–1694), an Italian, whose greatest work was done on the anatomy of the silkworm but who among other observations saw the flow of the blood in the lungs and mesenteries of the frog. Swammerdam (1637–1680) and Leeuwenhoek (1632–1723) were Hollanders. The former, who was a physician and naturalist, made extensive researches in the structure and life histories of animals, mostly insects. He championed the preformation theory (Sec. 630). The latter, who was a microscope maker, discovered red blood corpuscles and observed the connections of capillaries with veins and arteries in the tail of a tadpole; he first observed rotifers and a great many minute organisms, including protozoans and bacteria. Hooke (1635–1703), an English physicist and microscopist, discovered the cell. The work of these men was followed by that of many others who unfolded a wealth of detail in regard to minute anatomy and the smaller living organisms.

627. Comparative Anatomy.—To Cuvier (1769–1832) is ascribed the founding of the science of comparative anatomy. He was the son of a French army officer and early in his life showed a pronounced liking for paleontology and zoology. Most of his life was spent in Paris, where he occupied a commanding position in science. He was given a title, devoted considerable time to public education, and was appointed chancellor of the Imperial University by Napoleon. His great work was “Le Règne

Animal," published in 1817, which influenced classification for some time. He did not accept the classification outlined by Linnaeus but presented one dividing the animal kingdom into four branches, Vertebrata, Mollusca, Articulata, and Radiata. Cuvier (Fig. 334) believed in the theory of special creation and explained the existence of dissimilar fossils in different rock strata as evidence of a series of creations, the life arising from each past creation being destroyed completely by some great catastrophe. This theory is known as catastrophism; the opposite view—that geological succession has been a continuous process—is known as



FIG. 334.—Georges Cuvier, 1769–1832. (From Shull, "Principles of Animal Biology," after Loey, "Biology and Its Makers," and by the courtesy of McGraw-Hill Book Company, Inc.)

uniformitarianism. Cuvier was followed by Owen (1804–1892), a great English physician and anatomist, to whom we owe the ideas of homology and analogy. The founder of the modern science of histology was Bichât (1771–1802), a French anatomist and physiologist.

628. Physiology.—The Greeks believed in spirits and humors in the body and in the existence of the *pneuma* which, taken into Latin became *spiritus*, equivalent to vital force. Harvey contributed to physiology by applying to it the experimental method. During the sixteenth and seventeenth centuries two schools of physiologists arose, one seeking to put the subject on a chemical foundation, the other to base it on physics. Johannes Müller (1801–1858), a German, for the first time brought to bear on physiology not only the facts of chemistry and physics but also

those of human and comparative anatomy. For that reason he is usually credited with having founded modern physiology.

629. Cell Theory.—This has been reviewed in one of the early chapters (Sec. 42) in which was described the work of Hooke, Dujardin (1801–1860), Von Mohl (1805–1872), Schleiden (1804–1881), Schwann (1810–1882), and Schultze (1825–1874).

630. Embryology.—It has already been stated that Aristotle studied the embryology of the chick and its gradual development. Harvey analyzed development in a critical manner, and Malpighi gave a very complete description of the development of the hen's egg. Just before the time of Caspar Wolff (1733–1794), however, a theory of *preformation* had become dominant; this theory was to the effect that existent in the egg was a miniature adult which needed only the stimulation of the sperm cell to develop. Others thought that this *homunculus* existed in the sperm cell and that the egg cell was simply a bed of nourishment for it. The proponents of this theory were driven logically to the assumption that succeeding generations were also represented in some way one within the other. Wolff successfully championed the antagonistic theory of *epigenesis*, which was that the structures of the adult were gradually developed from an egg cell and that each generation began anew with another such cell. The modern science of embryology, however, dates from the time of Von Baer (1792–1876), who established the facts in regard to the germ layers and put the subject on a comparative basis. He was the author of the biogenetic law, which has also been called Von Baer's law.

631. Taxonomy.—The names of those most prominently connected with the development of taxonomy have been given in the preceding chapter and will not be repeated here.

632. Evolution and Genetics.—Theories of spontaneous generation have been treated earlier in this text, where the work of Redi (1626–1697), Pasteur (1822–1895), and Tyndall (1820–1893) was discussed. The steps in the development of the evolutionary conception have been taken up in a separate chapter (Chap. LXXII), and statements made there need not be repeated. The greatest name, and the one which marks the beginning of precise knowledge in the field of genetics, is that of Mendel.

633. Pasteur.—Louis Pasteur (Fig. 335) was a chemist who made noteworthy contributions in the fields of microbiology and preventive and curative medicine. He pursued extensive investigations on fermentation and discovered that the bacteria in milk could be killed by raising it to a temperature much below boiling point and keeping it there for a time, a process now known as *pasteurization*. He discovered the micro-organism causing a disease in silkworms known as *pébrine* and thus saved the silk industry in France when the silkworm was threatened with extinction by this disease. He also discovered a method of inocula-

tion which prevents the development of hydrophobia if used promptly after the bite of a rabid dog. This followed previous similar work on anthrax and chicken cholera.

634. Recent Advances.—No attempt will be made to follow the course of recent investigations in any of the fields of zoology, though



FIG. 335.—Louis Pasteur, 1822–1895. (From Shull, "Principles of Animal Biology," after Garrison, "History of Medicine," and by the courtesy of McGraw-Hill Book Company, Inc.)

since the beginning of the present century tremendous advances have been made and knowledge is now so extensive and progress so rapid that only the specialist in any field can hope to keep fully abreast with the discoveries in that field.



GLOSSARY

The words included are selected from those occurring in the text and are those of more general significance or most likely to be mispronounced. Some of the more frequent roots from Greek and Latin are inserted. The names of all persons referred to in the text—and these only—are also included. Pronunciation and definitions, generally, are based upon the last edition of Webster's International Dictionary (1933).

The vowel sounds are indicated by the following symbols:

ā as in may	ō as in dot
ã as in mat	ô as in for
â as in care	ô as in obey
ä as in far	ö = o + e
á as in sofa	öö as in boot
ē as in be	öö as in foot
ě as in met	ū as in mute
ĕ as in fertile	ŭ as in but
ê as in event	û as in fur
ī as in line	û as in unite
ı as in bin	ü = u + e
ō as in old	

Certain consonant sounds are indicated in the following manner:

soft c = s	soft g = j
hard c = k	hard th = th
hard ch = k	z = as n in anger

The word Greek is abbreviated to G., and Latin to L., in indicating roots from those languages. Roots used only as prefixes are followed by a hyphen and those only as suffixes preceded by one.

A-, or **an-** (ã, ãn). G.; not, without.

ab- (ãb). L.; away from.

abdomen (ãb dõ' mën). The posterior region of the body proper with the axis horizontal, the lower, with the axis vertical; adj., **abdominal** (ãb dõm' I nãl).

abiogenesis (ãb I õ jën' ê sıs). The conception that living organisms can arise from nonliving matter at any time when favorable conditions exist; the same as spontaneous generation.

aboral (ãb õ' rãl). Opposite the mouth.

absorption (ãb sõrp' shũn). The entrance of substances in solution into the body of an organism.

acantho (ã kãn' thõ). G.; thorn.

accommodation (ã kõm õ dã' shũn). The adjustment of the eye to distinct vision at different distances.

acetabulum (ãs ê tãb' û hũm). The socket on each side of the pelvis which receives the head of the femur.

achromatic figure (ãk rõ mãt' ik). All of the mitotic figure except the chromosomes.

acquired character. A character in an organism developed by the action of the environment upon the somatic cells.

actin (ãk' tın). G.; ray.

- action pattern.** The structural and functional relationships in an organism which determine the character of its behavior.
- ad-** (äd). L.; to, toward.
- adaptation** (äd äp tä' shün). The fitness of an organism for a certain environment; the process of adjustment involved; or a characteristic which so adjusts an animal.
- adductor** (ä dük' tēr). A muscle acting so as to draw a part toward a median line.
- adipose** (äd' ip ōs). Pertaining to fat.
- adjustor neuron.** A neuron in a nerve center by which an impulse is passed from the receptor neuron to the effector cell in a reflex act.
- adolescence** (äd ō lēs' čns). The period of life between childhood and maturity.
- adrenal** (äd rē' näl). A ductless gland near the kidney; in man, often called suprarenal; the hormone produced is **adrenalin** (äd rēn' ä lln).
- aeri** (ä' ēr i). L.; air. **aero** (ä' ēr ō). G.; air.
- afferent** (äf' ēr čnt). Incoming, toward a center.
- ala** (ä' lä). L.; a wing.
- albinism** (äl' bī nIz'm). Lack of pigment when normally it is present; in higher vertebrates shows itself in the lack of color in skin, hair or feathers, and iris.
- alimentary** (äl i mčn' tä rī). Pertaining to food.
- allantois** (ä län' tō Is). An embryonic membrane in land vertebrates, primarily for respiration; adj., **allantoic** (ä län tō' ik).
- allelomorph** (ä lē' lō mōrf). One of a pair of corresponding genes in homologous chromosomes, when the characters are different.
- allergy** (äl' čr jī). In a broad sense, a modification of the reaction of the body to a substance after having been once subjected to the action of that substance, including both immunity and anaphylaxis; in a narrow sense, natural acute sensitiveness to a substance which does not act like a poison by causing the development of an antitoxin.
- alternation of generations.** Metagenesis.
- altricial** (äl trīsh' äl). Pertaining to birds hatched in a naked, blind, and weak condition.
- alveolar** (äl vč' ō lār). Pertaining to an alveolus, which is a small cavity, or pit.
- ambergris** (äm' bčr grčs). A substance produced in the stomach of a sperm whale and used in the manufacture of perfumes.
- ambulacral** (äm bū lā' kräl). Pertaining to the tube feet of an echinoderm.
- ameboid** (ä mč' boid). Like an ameba; putting out pseudopodia.
- amitosis** (äm i tō' sīs). Direct nuclear division, neither spindle nor asters being formed.
- amnion** (äm' nī ōn). An embryonic membrane in land vertebrates serving for the protection of the embryo; adj., **amniotic** (äm nī ōt' ik).
- amphi-** (äm' fī). G.; on both sides, of both kinds.
- amphiaster** (äm' fī äs tēr). The mitotic figure at its fullest development.
- amphibious** (äm fīb' i ūs). Capable of living both in water and outside it.
- amphimixis** (äm fī mīk' sīs). The union of a sperm cell and an egg cell.
- ampulla** (äm pūl' ä). A flasklike dilatation.
- amylopsin** (äm i löp' sīn). An enzyme produced by the pancreas, which changes starches to sugars.
- ana-** (än' ä). G.; up, back, or again.
- anabolism** (än äb' ō līz'm). The building-up steps in metabolism, from ingestion to assimilation, inclusive.
- analogy** (ä näl' ō jī). Resemblance involving function but not structural plan.
- anaphase** (än' ä fāz). The phase in mitosis during which the chromosomes migrate from the equator of the spindle to the poles.

- anaphylaxis** (än ä fi läk' sîs). The acute susceptibility of the body to an albuminous substance which acts as a poison; or increased susceptibility to a toxin after recovery from poisoning by that toxin.
- Anaximander** (än äk sî mân' dêr). Greek philosopher; 611-547 B.C.
- animal pole.** That pole of an egg cell toward which the protoplasm is accumulated.
- ante-** (än' tē). L.; before.
- antenna** (än tēn' ä). A sensory appendage on the head of an arthropod, the functions of which do not include sight; adj., **antennal**.
- anterior** (än tē' rî êr). In front; in a bilaterally symmetrical animal with the axis horizontal, toward the head.
- anthropoid** (än' thrô poid). Manlike.
- anti-** (än' tî). G.; against.
- antimer** (än' tî mēr). One of the similar parts into which a radially symmetrical animal may be divided.
- antitoxin** (än tî tōk' sîn). A substance in the body which neutralizes a poison, or toxin.
- aorta** (ä ôr' tâ). A large artery arising from the heart of vertebrates, the blood in which is sent over the body; branches which pass around the pharynx and reunite to form a dorsal aorta are called **aortic arches**.
- appendage** (ä pēn' dāj). A projecting part on a metazoan body that is movable and has an active function.
- Aquinas** (ä kwî' nās), **Thomas**. Italian scholastic; 1225?-1274?
- arboreal** (är bō' ré ä). Pertaining to life in trees.
- arch-** (ärk). G.; first, beginning.
- archenteron** (är kēn' tēr ōn). The gastrular cavity in metazoan embryos which serves as a primitive digestive cavity; adj., **archenteric** (är kēn tēr' îk).
- Aristotle** (är' îs tōt' l). Greek philosopher; 384-322 B. C.
- artery** (är' tēr î). A vessel carrying blood away from the heart; adj., **arterial** (är tēr' rî ä).
- arthr** (är' thr). G.; joint.
- asexual** (ä sēk' shū ä). Not related to sex, or having no sex.
- assimilation** (ä sîm î lä' shūn). The incorporation of food into the living protoplasm; adj., **assimilative** (ä sîm' î lä tiv).
- associative memory.** Memory involving the relating of previous experiences.
- aster** (äs' tēr). G.; star. A term applied to the rays which surround the centrosomes in a mitotic figure.
- asymmetry** (ä sîm' ê trî). Lack of symmetry.
- atoll** (ät' òl). A circular coral island inclosing a lagoon.
- atriopore** (ä' trî ô pōr). The external opening of an atrial cavity in one of the lower chordates.
- atrium** (ä' trî ūm). A cavity on the outside of the body of lower chordates, also called atrial cavity; an auricle in the heart; adj., **atrial**.
- Augustine, Saint** (sânt ô gūs' tîm). Bishop of Hippo; 354-430.
- auricle** (ô' rî k' l). A chamber in the heart which receives blood, also called atrium; an earlike projection on the side of the head; adj., **auricular** (ô rîk' ū lâr).
- auto** (ô' tō). G.; self.
- autonomic** (ô tō uōm' îk). Having powers of its own; applied to the sympathetic nervous system.
- autosome** (ô' tō sōm). Any chromosome except a sex chromosome.
- autotomy** (ô tōt' ô mî). The automatic breaking off of a part by an animal.
- axolotl** (äk' sō lōt' l). A salamander larva which has acquired sexual maturity, or a sexually mature salamander which preserves the larval form.
- axon** (äk' sōn). A nerve fiber which conducts impulses away from the body of the cell of which it is a part.

- Baker, Frank C.** American zoologist, at University of Illinois; 1867- .
- basement membrane.** A thin connective tissue membrane to which epithelial cells are attached.
- behavior.** The sum total of an animal's movements in response to changing environmental conditions or to changes within the organism.
- benthos** (běn' thōs). The life of the sea bottom, especially of the deep seas; it does not properly apply to the littoral fauna of shallow water; adj., **benthal**.
- bi-** (bi). L.; two, or twice.
- Bichât** (bē shā'), **Marie F. X.** French anatomist and physiologist; 1771-1802.
- bilateral symmetry.** Symmetry which involves the possibility of dividing a body into two parts, which are mirror images of each other.
- bile.** The secretion of the liver in vertebrates.
- binary** (bi' nā ri) **fission.** The division of an organism into two similar organisms.
- binomial** (bi nō' mī āl). Consisting of two names; in the accepted nomenclature these are the names of the genus and the species.
- bio** (bi' ō). G.; life, related to life.
- biogenesis** (bi ō jēn' ē sis). The conception that since the beginning of life living things have arisen only from preexisting living things.
- biogenetic** (bi ō jē nēt' ik) **law.** The doctrine that in the embryogeny of any higher animal there appear stages or conditions similar to those which were present in the adults of lower types ancestral to it.
- biota** (bi ō' tā). A collective term for the animals and plants of a given area; adj., **biotic** (bi ōt' ik).
- biparental.** Involving two parents.
- biradial symmetry.** A combination of radial and bilateral symmetry.
- biramous** (bi rā' mūs). Having two branches.
- bivalent** (bi vā' lēnt). Having the value of two.
- bladder.** A membranous sac; the air bladder contains gases, the gall bladder serves for the temporary storage of bile, and the urinary bladder serves for the accumulation of urine.
- blast** (blāst). G.; germ, relating to the early stages of the embryo.
- blastocoel** (blās' tō sēl). The cavity of a blastula; the cleavage, or segmentation, cavity.
- blastoderm** (blās' tō dūrm). The sheet of cells surrounding the cleavage cavity in a blastula; adj., **blastodermic** (blās tō dūr' mīk) or **blastodermal**.
- blastomere** (blās' tō mēr). A cell of the blastoderm.
- blastopore.** The opening into the archenteron.
- blastula** (blās' tū lā). An embryo in the stage when it is composed of a blastoderm inclosing a blastocoel, like a hollow ball of cells; adj., **blastular**.
- blepharoplast** (blēf' ā rō plāst). A granule in a cell from which a flagellum or cilium arises.
- brachio** (brāk' i ō). G.; arm.
- brachy** (brāk' i). G.; short.
- branchi** (brān' kī). L.; gill. **Branchial** (brān' kī āl). Pertaining to gills.
- breathing.** The passage of air into and out of a cavity in an animal body leading to the interchange of gases through the wall of the cavity, an interchange which is respiration.
- bronchus** (brōn' kūs). An air passage within a lung.
- Brown, Robert.** Scottish botanist; 1773-1858.
- Bruner** (brōō' nēr), **Lawrence.** American entomologist; 1856- .
- buccal** (būk' āl). Pertaining to the mouth.
- budding.** The production of a young animal from the body of a parent and its separation, while still small, from the parent, after which it is able to live independently.

Buffon, de (dē bū fōn'), **Georges L. L.** French naturalist; 1707–1788.

byssus (bīs' ūs). A tough thread or a group of threads attaching a mussel to a solid object.

Caecum (sē' kūm). A blind outpocketing of the intestine; adj., **caecal**.

calc (kălk). L.; lime. **Calcareous** (kăl kă' rē ūs). Limy.

capillary (kăp' ū lă rī). A fine tube, such as a blood or bile capillary.

carapace (kăr' ā pās). A hard dorsal covering of a body, such as that of a turtle or a crayfish.

carbohydrates (kăr bō hī' drăts). Organic compounds, including starches, sugars, and cellulose, composed of carbon, hydrogen, and oxygen, the number of atoms of hydrogen and oxygen being usually as 2:1.

cardio (kăr' dt ō). G.; heart. **Cardiac**. Pertaining to the heart.

carnivorous (kăr nīv' ō rūs). Flesh-eating; a flesh-eating animal is known as a **carnivore** (kăr' nī vōr).

carpus (kăr' pūs). The wrist bones; adj., **carpal**.

Castle, William E. American zoologist, at Harvard University; 1867–.

catalysis (kă tăl' ū sīs). The acceleration of a chemical reaction by a substance—an enzyme—known as a catalyst or catalyzer, which is not changed in the process; adj., **catalytic** (kăt ā lit' ūk).

caudal. Pertaining to the tail.

cell. A mass of protoplasm containing a nucleus; cells may exist as individual organisms or may be parts of many-celled organisms.

cell membrane. A protoplasmic layer surrounding a cell; the plasma membrane.

cell theory. The theory that all plants and animals are composed of cells; now so well-established as to have become the **cell doctrine**.

cellulose (sēl' ū lōs). A carbohydrate which usually makes up the walls of plant cells; found in animals only in the tunicates.

cell wall. A nonliving wall about a cell, secreted by the cell itself.

central body. A clear mass in a cell, near the nucleus, containing one or two centrioles; also called centrosome, centrosphere, or attraction sphere.

centralization. The development of a central nervous system.

central nervous system. That part of the nervous system which receives afferent impulses and sends out efferent ones; it may consist of a pair of ganglia and two ganglionic nerve cords, as in the planarian; a chain of connected ganglia, as in the annelids and arthropods; or the brain and spinal cord of vertebrates.

centriole (sēn' trī ōl). A minute granule contained in the central body or seen at the center of the aster in mitosis; also called centrosome.

centrolecithal (sēn trō lēs' ū thăl). Adjective applied to an egg cell with the yolk mass toward the center.

centrosome (sēn' trō sōm). A name which has been used in different senses; has been applied to both the central body and centriole; adj., **centrosomal** (sēn trō sō' mäl).

cephalo (sēf' ā lō). G.; head. **Cephalic**. Pertaining to head.

cephalization (sēf ā lī ză' shūn). The development of a head containing a brain.

cephalothorax (sēf ā lō thō' răks). A part of the body composed of the fused head and thorax.

cercaria (sūr kă' rī ā). A stage in the development of a fluke.

cerebellum (sēr ē bēl' ūm). The fourth part of the brain in vertebrates; contains the centers for muscular coordination; adj., **cerebellar**.

cerebrum (sēr' ē brūm). The anterior division of the brain in vertebrates; in higher forms it is the center of intelligence and reason; adj., **cerebral**, which also may be used in reference to any brain.

cervical (sūr' vī kăl). Pertaining to the neck.

- chaet** (kēt). G.; bristle. **Chaeta** (kē' tā). A bristle set in the body wall and forming the locomotor organ in many annelids.
- character**. A heritable and visible characteristic in an animal connected with the presence or absence of a gene, or the interaction of two or more genes.
- chelicera** (kē līs' ēr à). One of the anterior pair of appendages of an arachnid.
- cheliped** (kē' lī pēd). The first walking leg of a crayfish.
- chemotropism** (kē mōt' rō piz'm). The response by an organism to chemical stimulation; adj., **chemotropic** (kēm ò trōp' ik).
- Child, Charles M.** American zoologist, at University of Chicago; 1869-.
- chitin** (kī' tīm). A substance that gives hardness to the cuticula of many invertebrates.
- chlorophyll** (klō' rō fil). The green coloring matter contained in the chloroplasts of cells and carrying on photosynthesis.
- chondrin** (kōn' drīn). The substance which forms cartilage.
- chord** (kōrd). G.; a string.
- chordate** (kōr' dāt). An animal belonging to the phylum Chordata and possessing a notochord at some time during its life.
- chorion** (kō' rī ōn). The outer embryonic membrane of land vertebrates; the same name is also applied to the shells of insect eggs; adj., **chorionic** (kō rī ōn' ik).
- choroid** (kō' roid). The vascular middle coat of the vertebrate eye; adj., **choroidal** (kō roi' dāl).
- chromatin** (krō' mā tīm). The deeply staining substance in the nucleus of cells; adj., **chromatic** (krō māt' ik).
- chromatophore** (krō' mā tō fōr). A cell containing pigment.
- chromidia** (krō mīd' i à). Masses of chromatin scattered through the cytoplasm of a protozoan cell which represent a "distributed" nucleus.
- chromomere** (krō' mō mēr). An individual chromatin granule in a chromosome.
- chromosome** (krō' mō sōm). A characteristic mass of chromatin developed from the chromatin network in a nucleus during mitosis; adj., **chromosomal** (krō mō sō' māl).
- chyle** (kīl). That part of the food, consisting largely of emulsified fats, which is absorbed through the walls of the small intestine and collected by the lymphatic vessels.
- chyme** (kīm). Food reduced to liquid form.
- cilium** (sīl' i ūm). One of many minute, hairlike, vibratile structures on the surface of a cell; also the eyelashes; adj. **ciliary**, referring to either of the above or to many structures in the vertebrate eye.
- cirrus** (sīr' rūs). A slender, usually flexible, and often branched appendage having one of many functions, such as copulation in trematodes and mollusks, respiration in some annelids, and touch in many animals; also one of the legs of barnacles.
- cleavage**. The division of the egg cell and of the blastomeres in the early stages of embryogeny.
- Cleveland, Lemuel R.** American parasitologist, at Harvard Medical School; 1892-.
- cloaca** (klō à' kà). A common passageway to the outside of the body for the digestive, excretory, and reproductive systems; adj., **cloacal**.
- cnidoblast** (nī' dō blāst). A cell in a coelenterate in which develops a nematocyst.
- cocoon** (kō kōōn'). A protective covering for a larva, a pupa, a mass of eggs, or even one formed about an adult animal.
- coel** (sēl). G.; a hollow chamber.
- coelom** (sē' lōm). A body cavity inclosed by mesoderm; in embryogeny the gonads arise from its wall and into it the inner ends of the excretory ducts open; adj., **coelomic** (sē lōm' ik).
- colloid** (kōl' oid). A substance of glue-like or jelly-like consistency which in solution, or suspension, will not pass through an organic membrane; adj., **colloidal** (kō loi' dāl).

- colony.** An association of individuals descended from a common ancestor and remaining in organic connection.
- com-** (kõm). L.; with, together.
- commensalism** (kõ mën' sāl' iz'm). An association of two animals of different species in which one is benefited and the other not affected.
- commissure** (kõm' i shōōr). A bundle of nerve fibers connecting two nerve centers and crossing the median line.
- Comstock** (kũm' stõk), **John H.** American entomologist; 1849-1931.
- conditioned reflex.** A reflex act which is modified by impulses arising in a "higher" nerve center, one which dominates the center in which the adjustor neurons involved in the reflex are located.
- conductivity.** The property of protoplasm which enables it to transmit the effect of a stimulus from one point to another.
- congenital** (kõn jën' i täl). Existing at birth.
- conjugation** (kõn jōō gā' shũn). A temporary union of two cells resulting in an exchange of material.
- connective.** A bundle of nerve fibers uniting two ganglia on the same side of the body.
- contractile vacuole** (kõn trāk' til vāk' ū õl). A vacuole in a protozoan which alternately fills and empties.
- convergence** (kõn vŭr' jëns). Resemblance between two unrelated types because of living under similar conditions.
- copulation** (kõp ũ lā' shũn). Temporary union of a male and female animal involving the passage of sperm cells from the former to the latter.
- corium** (kõ' rī ũm). The dermis, or connective tissue layer, in the skin of vertebrates.
- corn** (kõrn). L.; horn.
- cornea** (kõr' nē ā). A sheet of transparent epithelial tissue admitting light to an eye; adj., **corneal**.
- corp** (kõrp). L.; body.
- cortex** (kõr' tēks). An outer layer; the outer dorsal layer of the cerebrum and cerebellum of higher vertebrates when it is organized into layers and areas; adj., **cortical**.
- cranium** (krā' nī ũm). The cartilaginous or bony box surrounding the brain of vertebrates; adj., **cranial**.
- crop.** An enlargement of an anterior part of the alimentary canal serving for the temporary storage of food.
- cross-fertilization.** The fertilization of the egg cell of one animal by the sperm cell of another.
- crossing over.** The transfer of genes from one chromosome to another during synapsis.
- cutaneous** (kũ tā' nē ũs). Pertaining to the skin.
- cuticle** (kũ' tī k' l). The epidermal layer of the skin of a vertebrate; also the firm outer layer of a protozoan; sometimes used in the same sense as cuticula; adj., **cuticular** (kũ tīk' ũ lār).
- cuticula** (kũ tīk' ũ lār). A hard covering on an animal body secreted by the epithelium.
- Cuvier** (kũ vyā'), **Georges L. C. F. D.** French naturalist; 1769-1832.
- cyclosis** (sī klō' sis). A continued regular movement of endoplasm within a cell.
- cyst** (sīst). A hard covering secreted around a mass of living matter; adj., **cystic**.
- cysticercus** (sis tī sŭr' kŭs). The encysted stage in the development of a tapeworm.
- cyt** (sīt). G.; a hollow vessel; in biology, a cell.
- cytoplasm** (sī' tō plāz'm). The protoplasm of a cell outside the nucleus; adj., **cytoplasmic** (sī tō plāz' mīk).

- Dactyl** (dǎk' tŭl). G.; finger.
- Darwin, Charles R.** English naturalist; 1809–1882.
- Darwin, Erasmus.** English physiologist; 1731–1802.
- de-** (dē). L.; down, from, off.
- degeneration** (dē jĕn ĕr ā' shŭn). The simplification or loss of structure or function in an animal organism.
- delamination** (dē lām ĩ nā' shŭn). The splitting off of a layer of cells.
- dendrite** (dĕn' drĭt). A branched fiber from a nerve cell which carries impulses toward the cell body; same as **dendron**; adj., **dendritic** (dĕn drĭt' ĩk).
- dent** (dĕnt). L.; tooth.
- derm** (dĕrm). G.; skin.
- dermis** (dĕr' mĭs). The inner connective tissue layer of the vertebrate skin; adj., **dermal**.
- desiccation** (dĕs ĩ kā' shŭn). Drying up.
- De Vries** (dē vrĕs'), **Hugo.** Dutch botanist; 1848–.
- di-** (dĭ). G.; two, double.
- dia-** (dĭ' à). G.; through, apart.
- dialysis** (dĭ āl' ĩ sĭs). The separation of substances in solution or suspension into colloids and crystalloids by means of a permeable membrane.
- diaphragm** (dĭ' à frām). The partition between the thoracic and abdominal cavities of a mammal.
- diastase** (dĭ' à stās). An enzyme which changes starches to sugars.
- diecious** (dĭ ĕ' shŭs). A species of animal in which the male and female organs are in different individuals.
- diencephalon** (dĭ ĕn sĕf' à lŏn). The second region of the vertebrate brain, including the optic thalami, optic tracts, and pineal and pituitary bodies; also called thalamencephalon.
- differentiation.** The process by which parts differing in structure and function are produced from a whole which originally was all alike.
- digestion** (dĭ jĕs' chŭn). The changing of food to a liquid and absorbable form; adj., **digestive**.
- dihybrid** (dĭ hĭ' brĭd). The offspring of parents differing by two characters.
- dimorphism** (dĭ mŏr' fiz'm). The appearance of a species of animal in two forms; adj., **dimorphic**.
- diplo** (dĭp' lô). G.; double.
- diploblastic** (dĭp lô blās' tĭk). Composed of two germ layers.
- diploid** (dĭp' lŏid). A term applied to the full number of chromosomes found in somatic cells.
- discoidal cleavage.** Cleavage in which the blastomeres form a disc at the animal pole of the egg cell.
- dissimilation** (dĭ sĭm ĩ lā' shŭn). The breaking-down processes in a cell by means of which chemical compounds are reduced to simpler form and energy is set free; adj., **dissimilative** (dĭ sĭm' ĩ lā tĭv).
- divergence** (dĭ vŭr' jĕns). The acquirement of different characteristics by related forms when placed under different environmental conditions.
- division of labor.** The distribution of specific functions to separate parts.
- dominance** (dŏm' ĩ nāns). The suppression of one character by a contrasted character when the genes which correspond to the two are both present; also the exercise of control by one part of the body over another.
- Dujardin** (dŭ zhār dŭu'), **Félix.** French zoologist; 1801–1860.
- duodenum** (dŭ ō dĕ' nŭm). The first part of the small intestine in mammals; adj., **duodenal** (dŭ ō dĕ' nāl).
- Durant** (dŭ rānt'), **William J.** American author; 1885–.
- dyad.** A chromosomal mass formed by the division of a tetrad

- Ebers** (ā' bērs), **Georg M.** German Egyptologist; 1837-1898.
- ecdysis** (ĕk dī' sīs). The shedding of the cuticula of an arthropod or of the horny scales of a snake or lizard.
- economic** (ĕ kō nōm' ik). Pertaining to utilitarian values, either positive or negative.
- ect-** (ĕkt). G.; without, outside.
- ectoderm** (ĕk' tō dŭrm). The outer germ layer in embryogeny; adj., **ectodermal** (ĕk tō dŭr' māl).
- ectoplasm** (ĕk' tō plāz'm). The outer part of the cytoplasm of a protozoan; adj., **ectoplasmic** (ĕk tō plāz' mīk).
- effector** (ĕf fĕk' tēr). A term applied to either a cell or an organ that completes a reflex act.
- effluent** (ĕf fŕ ĕnt). Outgoing, from a center.
- egestion** (ĕ jĕs' ĕhŭn). The passing out of feces.
- egg**. An egg cell with its protective coverings.
- egg cell**. The female reproductive cell.
- electrotropism** (ĕ lĕk trōt' rō plāz'm). Response to an electrical stimulus; adj., **electrotropic** (ĕ lĕk trō trōp' ik).
- elimination** (ĕ līm I nā' shŭn). The passage out of the body of liquid waste; adj., **eliminative** (ĕ līm' I nā tlv).
- embryo** (ĕm' brī ō). An animal in the early stages of its development; adj., **embryonic** (ĕm brī ōn' ik).
- embryogeny** (ĕm brī ōj' ĕ nī). The stages in the embryonic development of an animal.
- Empedocles** (ĕm pĕd' ō klĕz). Greek philosopher; about 500-430 B.C.
- en-** (ĕn). G.; in.
- encephalon** (ĕn sĕf' ā lōn). The brain of a vertebrate.
- encystment** (ĕn sīst' mĕnt). The formation of a hard covering, or cyst, about an organism.
- endo-** (ĕn' dō), or **ento-** (ĕn' tō). G.; within.
- endocrine** (ĕn' dō crīn). Pertaining to internal secretions or ductless glands.
- endomixis** (ĕn dō mīk' sīs). A process of reorganization of the nuclear material in a protozoan cell.
- endoplasm** (ĕn' dō plāz'm). The inner portion of the cytoplasm of a protozoan cell; adj., **endoplasmic** (ĕn dō plāz' mīk).
- endoskeleton** (ĕn dō skĕl' ĕ tŭm). An internal skeleton; adj., **endoskeletal**.
- endothelium** (ĕn dō thĕ' lī ūm). An epithelium of mesodermal origin lining coelomic cavities, serous spaces, and blood and lymph vessels; adj., **endothelial**.
- enteron** (ĕn' tēr ōn). A digestive cavity; adj., **enteric** (ĕn tĕr' ik).
- entoderm** (ĕn' tō dŭrm). The inner germ layer; also called endoderm; adj. **entodermal** (ĕn tō dŭr' māl).
- entozoic** (ĕn tō zō' ik). Living within an animal body.
- enzyme** (ĕn' zīm). A catalytic ferment.
- epi-** (ĕp' I). G.; upon.
- epibole** (ĕp' I b' ō lĕ). The growth of a fold of the blastoderm over the surface of the embryo, leaving an archenteron between the two.
- epidermis** (ĕp' I dŭr' mīs). The outer epithelial layer of the skin of vertebrates; adj. **epidermal** (ĕp' I dŭr' māl).
- epigenesis** (ĕp' I jĕn' ĕ sīs). The conception that the parts of an organism arise from an undifferentiated germ cell, in contrast to the idea of preformation.
- epithelium** (ĕp' I thĕ' lī ūm). A tissue covering a free surface; adj., **epithelial**.
- epizoic** (ĕp' I zō' ik). Living upon the surface of an animal.
- equatorial** (ĕ kwā tō' rī āl) **plate**. The group of chromosomes lying in the equatorial plane of the spindle in mitosis.

- esophagus** (ĕ sŏf' à gŭs). That part of the alimentary canal lying between the pharynx and stomach; adj., **esophageal** (ĕ sŏ fáj' ĕ ál).
- estivation** (ĕs tí vā' shŭn). The assumption of a dormant condition by an animal during summer.
- eu-** (ŭ). G.; true.
- eustachian** (ŭ stā' kí ĩn) **tube**. A tube connecting the pharynx and middle ear.
- evagination** (ĕ vāj í nā' shŭn). The protrusion by eversion of an internal surface.
- evolution** (ĕv ō lŭ' shŭn). Progressive development; adj., **evolutionary**.
- ex-** (ĕks). G.; out of, off from, without.
- excretion** (ĕks krē' shŭn). The passing out from a cell of a substance produced in it, this substance being waste to the cell and of no value to the body of which it is a part; also the substance itself; **excretory** (ĕks' krē tŏ rĭ), pertaining to excretion.
- exhalation** (ĕks há lā' shŭn). The passage of gases outward from the lungs.
- exoskeleton** (ĕk sŏ skĕl' ĕ tŭm). An outer skeleton; adj., **exoskeletal**.
- expiration** (ĕk spĭ rā' shŭn). The escape of carbon dioxide from the organism; or its passage from the tissues into the blood.
- exteroceptor** (ĕks tŭr ō sĕp' tŭr). Sense organs for the reception of external stimuli.
- extra-** (ĕks'-trā). L.; beyond, outside.
- eye**. An organ for vision.
- eyespot**. A mass of pigment or a pigment-containing organ for the perception of light rays but not giving vision.
- F₁, F₂, F₃**, etc. Abbreviations used in genetics and referring to successive filial generations.
- family**. Parents and their offspring; also a taxonomic group ranking between genus and order.
- fat**. An organic compound made up of a fatty acid and glycerin and containing carbon, hydrogen, and oxygen, with a relatively small number of oxygen atoms.
- fauna** (fŏ' ná). A collective term for the animals of a certain region; adj., **faunal**.
- feces** (fĕ' sĕz). The indigestible portion of the food which is passed through the alimentary canal and out of the body; adj., **fecal**.
- fer** (fĕr). L.; bearer, carrier.
- fertilization** (fŭr tí lí zā' shŭn). The union of an egg cell and a sperm cell.
- fetus** (fĕ' tŭs). A young mammal after about one third of the time from the beginning of development to birth has elapsed; in the case of man, after the end of the third month; adj., **fetal**.
- fibril** (fĭ' brĭl). A slender fiber; or a component part of a cross-striated muscle fiber.
- fibrin** (fĭ' brĭn). The fibrous material in a blood clot; derived from the fibrinogen in the blood.
- fil** (fĭl). L.; a thread.
- fission** (fĭsh' ũn). The division of an organism into parts approximately equal in size, each part being a young organism.
- flagellum** (flá jĕl' ũn). A long whiplike structure attached to a cell; adj., **flagellar**.
- flame cell**. A hollow cell containing a mass of vibratile cilia which carries on excretion in planarians and rotifers.
- fossorial** (fŏ sŏ' rĭ ál). Fitted for digging.
- fragmentation**. An asexual method of reproduction in lower Metazoa in which the body divides into a number of parts each of which becomes an individual.
- fraternal twins**. Twins produced from two egg cells.
- Galen** (gā' lĕn), **Claudius**. Greek physician; 130–200?
- Galilei** (gā lĕ lā' ĕ), **Galileo**. Italian astronomer; 1564–1642.
- gam** (gām). G., marriage. **Gamet** (gām' ĕt). G., husband or wife.

- gamete** (gām' ēt). A germ cell; adj., **gametic** (gā mēt' ik).
- gametogenesis** (gām ē tō jēn' ē sis). The stages in the development of a germ cell, or reproductive cell.
- ganglion** (gān' glī ōn). A circumscribed group of nerve-cell bodies; adj., **ganglionic** (gān glī ōn' ik).
- gastr** (gās' t'r). G.; stomach. **Gastral**. Stomach-like. **Gastric**. Pertaining to the stomach.
- gastrovascular** (gās trō vās' kû lār) **cavity**. A cavity in the lower Metazoa which serves for both digestion and distribution of food.
- gastrula** (gās' trōō lā). A stage in embryogeny when the embryo has two layers and contains a cavity called the archenteron; adj., **gastrular**.
- gastrulation** (gās trōō lā' shūn). The development of a gastrula from a blastula.
- gemmation** (jēm ā' shūn). Reproduction by budding.
- gemmule** (jēm' ūl). A bud of a fresh-water sponge, produced internally and inclosed in a cyst, which lives over winter and develops in the spring.
- gen** (jēn). G.; producing, causing; **gener** (jēn' ēr), born.
- gene** (jēn). That in the chromatin of a germ cell which by interaction with other genes and the cytoplasm determines the production of a character in the individual developed from the cell; the unit of inheritance.
- gener** (jēn' ēr). L.; race, kind.
- genotype** (jēn' ō tīp). An organism considered with reference to its total genetic constitution; adj., **genotypic** (jēn ō tīp' ik).
- geotropism** (jē ōt' rō pīz'm). The response of an organism to the force of gravity; adj., **geotropic** (jē ō trōp' ik).
- germ cell**. A cell concerned with reproduction; adj., **germinal** (jūr' mīnāl).
- germ layers**. Cell layers formed early in embryogeny from which the definitive tissues are developed.
- germplasm** (jūrm' plāz'm). The portion of the protoplasm of a germ cell which transmits the hereditary characters.
- gill**. An organ for respiration under water.
- gizzard**. A portion of the alimentary canal in annelids and birds the function of which is to grind the food.
- gland**. An organ which produces a secretion; adj., **glandular** (glān' dū lār).
- glochidium** (glō kīd' I ūm). The larva of a fresh-water mussel.
- glomerulus** (glō mēr' ōō lūs). A mass of tissue containing a knot of blood capillaries inclosed by the end of a kidney tubule of the mesonephroi and metanepthroi of vertebrates.
- glottis** (glōt' is). A slitlike opening from the pharynx into the larynx or trachea in the higher vertebrates.
- glycogen** (glī' kō jēn). The form in which carbohydrate food is stored in the liver and other tissues; also called animal starch.
- gnath** (nāth). G.; jaw.
- gon** (gōn). G.; seed, referring to reproduction.
- gonad** (gōn' ād). An organ which produces egg cells or sperm cells.
- Grassi** (grās' ē), **Giovanni B.** Italian zoologist; 1854-1925.
- gregariousness** (grē gā' rī ūs nēs). As used in this text, the tendency of animals of different species to gather together.
- gustatory** (gūs' tā tō rī). Pertaining to the sense of taste.

Habit. A mode of action, or an act which when first performed has no relation to an action pattern, but in connection with the continued repetition of which an action pattern is developed, and which comes to control the animal in the same manner as does an instinct.

- habitat** (hăb' i tăt). The area in which a species of animal or a group of animals lives.
- Haeckel** (hĕk' ěl), **Ernst H.** German biologist; 1834-1919.
- haplo** (hăp' lô). G.; simple.
- haploid** (hăp' loid). The reduced number of chromosomes.
- Harvey, William.** English anatomist and physician; 1578-1657.
- head.** An anterior region of the body containing the dominant part of the nervous system and the chief sense organs.
- Helmholtz, von, Hermann L. F.** German physicist; 1821-1894.
- hem, haem** (hēm). G.; blood.
- hemi-** (hĕm' ĩ). G.; half.
- hemocoel** (hĕ' mō sĕl). Coelom-like spaces devoted to the circulation of the blood.
- hemoglobin** (hĕ mō glō' bĭn). A protein found in the blood which by combining with oxygen increases the amount of the gas which can be distributed over the body.
- hemolysis** (hĕ mōl' ĩ sĭs). Solution of the red blood corpuscles.
- hepatic** (hĕ păt' ĩk). Pertaining to the liver.
- herbivorous** (hĕr bĭv' ō rūs). Plant-eating; a plant-eating animal is known as a **herbivore** (hŭr' bĭ vŏr).
- hermaphrodite** (hĕr măf' rŏ dĭt). An animal containing both male and female gonads; adj., **hermaphroditic** (hĕr măf rŏ dĭt' ĩk).
- Herodotus** (hĕ rŏd' ō tŭs). Greek historian; 484?-425 B. C.
- hetero** (hĕt' ĕr ō). G.; other, different.
- heteronomous** (hĕt ĕr ōn' ō mŭs) **metamerism.** A type of metamerism involving unlike metameres.
- heterosis** (hĕt ĕr ō' sĭs). Increased vigor due to hybridity.
- heterozygote** (hĕt ĕr ō zĭ' gŏt). An organism in which two corresponding genes or characters are unlike; adj., **heterozygous.**
- hibernation** (hĭ bŭr nă' shŭn). Dormancy during winter.
- Hippocrates** (hĭ pŏk' ră tĕz). Greek physician; 460-377 B. C.
- holo** (hŏl' ō). G.; whole.
- holoblastic** (hŏl ō blăs' tik). A term applied to egg cells possessing total cleavage, involving the whole cell.
- holophytic** (hŏl ō fit' ĩk). Plantlike as to type of nutrition, involving the utilization of inorganic substances and the carrying on of photosynthesis.
- holozoic** (hŏl ō zŏ' ĩk). Animal-like as to type of nutrition, involving the ingestion of organic food.
- hom** (hŏm). G.; the same.
- homolecithal** (hŏ mŏ lĕs' ĩ thăl). A term applied to an egg cell with the yolk uniformly distributed.
- homology** (hŏ mŏl' ō jĭ). Structural similarity due to common origin, both evolutionary and embryonic; adj., **homologous** (hŏ mŏl' ō gŭs).
- homonomous** (hŏ mŏn' ō mŭs) **metamerism.** A type of metamerism involving like metameres.
- homozygote** (hŏ mŏ zĭ' gŏt). An organism in which the corresponding genes or characters are alike; adj., **homozygous.**
- Hooke, Robert.** English mathematician and microscopist; 1635-1703.
- hormone** (hŏr' mŏn). An internal secretion which, carried by the blood from the organ which produces it, influences other organs or growth processes.
- host.** An organism that harbors a parasite.
- Huxley, Thomas H.** English biologist; 1825-1895.
- hybrid** (hĭ' brĭd). The offspring of parents differing in species or in genetic constitution; the production of such is **hybridization.**
- hydr** (hĭ' d'r). G.; water.

- hydrostatic** (hī drō stāt' ik). A term applied to an organ which regulates the specific gravity of an aquatic animal, like a fish, in relation to that of water.
- hyp-** (hīp). G.; under, less.
- hyper-** (hī' pēr). G.; above, beyond, over.
- hypermetamorphosis** (hī pēr mēt ā mōr' fō sts). A metamorphosis in insects involving more than the stages of egg, larva, pupa, and adult.
- hypodermis** (hī pō dūr' mīs). A layer of epithelial cells under a superficial cuticula.
- hypostome** (hī' pō stōm). A conical projection in coelenterates at the tip of which is the mouth.
- Identical twins.** Twins which are alike and which presumably come from a single egg cell.
- ileum** (il' ē ūm). The last and longest of three divisions of the small intestine of mammals.
- ilium** (il' i ūm). The dorsal bone of the pelvis in Amphibia and higher vertebrates; adj., **iliac**.
- imago** (i mā' gō). The adult of insects; adj., **imaginal** (i māj' i nāl).
- immunity** (i mū' nī tī). The absence of susceptibility to disease.
- inbreeding.** The production of young by two closely related individuals.
- individuality.** That which belongs to one individual organism as distinct from all others.
- ingestion** (in jĕst' chŭn). The taking of food into the digestive cavity and its preparation for digestion.
- inhalation** (in hā lā' shŭn). The taking of air into the lungs.
- inhibit** (in hīb' it). To check or restrain.
- insectivorous** (in sĕk tīv' ō rūś). Insect-eating; an insect-eating animal is known as an **insectivore** (in sĕk' tī vōr).
- inspiration** (in spī rā' shŭn). The taking of oxygen into an animal organism; or its passage from the blood into the tissues.
- instar** (in' stār). A period between molts in an insect larva.
- instinct** (in' stīnkt). A mode of action determined by an inherited action pattern which under appropriate conditions and when brought into play by the proper stimulus causes a series of associated reflex acts leading to a definite end; adj., **instinctive** (in stīnk' tīv).
- integration** (in tē grā' shŭn). The development of unity in an organism.
- intelligence.** A mode of action freely modified by previous experience.
- inter-** (in' tēr). L.; between, among.
- intercellular.** Between cells.
- internal secretion.** A secretion passed into the blood instead of into the lumen of a gland or out upon a surface.
- interoceptor** (in tēr ō sĕp' tōr). A sense organ stimulated by some agent from within the body.
- intestine** (in tēs' tīn). That part of the alimentary canal in which absorption takes place; in mammals it is divided into the small and the large intestine; adj., **intestinal**.
- intra-** (in' trā). L.; within.
- intracellular.** Within a cell.
- intussusception** (in tŭs sŭ sĕp' shŭn). The introduction of new particles between those already related in a mass.
- invagination** (in vāj i nā' shŭn). The infolding of a sheet of cells or membrane to form a cavity.
- ion** (i' ōn). A free atom or radical in a solution, which bears an electrical charge.
- irritability.** The capacity to respond to a stimulus.

- Jejunum** (jê joo' nûm). The second region of the small intestine in mammals.
- Jennings, Herbert S.** American zoologist, at Johns Hopkins University; 1868-.
- Kary** (kâr' I). G.; a nut; in biology, a nucleus.
- karyokinesis** (kâr' I ô kî nê' sis). Mitosis.
- karyosome** (kâr' I ô sôm). A nucleolus composed of chromatin.
- katabolism** (kâ tâb' ô lîz'm). The processes in metabolism concerned with the breaking down of protoplasm and with getting rid of waste; adj., **katabolic** (kât â bôl' ik).
- Kelvin** (kêl' vîn), **Baron; William Thomson.** Scottish physicist; 1824-1907.
- keratin** (kêr' â tîn). A nitrogenous substance forming the chemical basis of horn, hair, nails, feathers, and epidermal scales.
- kidney.** The organ of elimination in vertebrates.
- King, Albert F. A.** American physician; 1841-1914.
- Labium** (lâ' bí ūm). An exoskeletal mass, composed of several pieces, which forms the posterior boundary of the mouth in insects; adj., **labial**.
- labrum** (lâ' brŭm). An exoskeletal mass which forms the anterior boundary of the mouth in insects.
- lachrymal** (lâk' rî mâl). Pertaining to the tears.
- lact** (lâkt). L.; milk.
- lacteal** (lâk' tê âl). As a noun, a lymph vessel in the wall of the small intestine into which fats are absorbed; as an adjective, pertaining to milk.
- Lamarck, de** (dê lâ mâr' k'), **Jean B. P. A. de M.** French zoologist; 1744-1829.
- lamella** (lâ mêl' â). A thin layer or plate; adj., **lamellar**.
- larva.** The young of an animal which undergoes metamorphosis after it has hatched from the egg; usually an active stage characterized by rapid growth; adj., **larval**.
- larynx** (lâr' I nks). In vertebrates the enlarged anterior end of the trachea containing the vocal cords; adj., **laryngeal** (lâr' in' jê âl).
- Laveran** (lâv râ' n), **Charles L. A.** French physician; 1845-1922.
- Lavoisier** (lâ vâ' zyâ'). **Antoine L.** French chemist; 1743-1794.
- Leeuwenhoek, van** (vân lâ' vên hœök), **Anton.** Dutch naturalist; 1632-1723.
- lens.** A transparent body in the eyes of animals which focuses the rays of light; adj., **lenticular** (lên tîe' ū lâr).
- leucocyte** (lŭ' kô sît). A white blood corpuscle.
- ligament** (lîg' â mên't). A band of fibrous tissue connecting structures in the body other than muscles; adj., **ligamentous** (lîg' â mên' tŭs).
- Light, Sol F.** American zoologist, at the University of California; 1886-.
- linin** (lî' nîn). The delicate reticulum in the nucleus upon which are the granules of chromatin.
- linkage** (lînk' âj). The constant association of certain genes in particular chromosomes.
- Linnaeus** (lî nê' ūs), **Carolus.** Swedish naturalist; 1707-1778.
- lipase** (lîp' âs). A fat-decomposing enzyme.
- lipoid** (lîp' oîd). Like a fat.
- Loeb** (lôb), **Jacques.** German-American biologist; 1859-1924.
- Lotsy** (lôt' sî), **Jan P.** Dutch botanist; 1867-1931.
- lumen** (lŭ' mên). The cavity in a tubular gland, duct, canal, or vessel.
- lung.** A respiratory organ of the air-breathing vertebrates.
- lymph** (lîmf). The blood plasma, together with white corpuscles, in the lymph vessels or in the tissues.
- lymphatic** (lîm fât' ik). A vessel conveying lymph; found in vertebrates. As an adjective, pertaining to lymph.

- MacBride, Ernest W.** English biologist; 1866-.
- Mach** (mäkh), **Ernst.** Austrian physicist; 1838-1916.
- macro** (mäk' rô). G.; large.
- macrogamete** (mäk rô gâ mēt'). A female sex cell, or egg cell.
- macronucleus** (mäk rô nü' klē ūs). The larger of two nuclei in the cells of infusoria.
- Malpighi** (mäl pē' gē), **Marcello.** Italian anatomist; 1628-1694.
- mandible** (män' dī b'l). In invertebrates, a mouth part for chewing; in vertebrates, the lower jaw; adj., **mandibular** (män dīb' ū lâr).
- mandibulate** (män dīb' ū lât). Having mandibles.
- mantle.** A fold of the body wall which more or less envelops the body; in most mollusks it secretes a shell.
- marsupium** (mär sū' pī ūm). An external pouch for carrying the young; in the fresh-water mussels, a part of the gills.
- Mast, Samuel O.** American biologist, at Johns Hopkins University; 1871-.
- maturation** (mät ū rā' shūn). As applied to germ cells, the final stages in gametogenesis, involving chromosome reduction.
- maxilla** (mäk sī' lā). In invertebrates, an accessory mouth part situated just back of the mandible and used for handling food; in vertebrates, the upper jaw; adj., **maxillary** (mäk' sī lā rī).
- mechanism** (mēk' ā nīz'm). The view that life phenomena are to be interpreted in terms of the same chemical and physical laws that govern the phenomena of inorganic nature.
- medulla** (mē dūl' ā). The posterior region of the vertebrate brain, also called medulla oblongata; also the soft central part of a gland or other organ; adj., **medullary** (mēd' ū lā rī).
- medullary.** In a particular sense pertaining to the embryonic structure from which the nervous system of chordates develops, as the medullary groove or tube.
- medullated** (mēd' ū lāt ēd). Term applied to a nerve fiber which possesses a fatty sheath.
- medusa** (mē dū' sū). A jelly fish, which is a free-swimming individual coelenterate.
- meiosis** (mī ō' sīs). The reduction division in the maturation of germ cells; adj., **meiotic** (mī ōt' ik).
- membrane** (mēm' brān). A thin sheet of tissue; also a thin sheet of matter secreted by cells or in a cell; adj., **membranous** (mēm' brā nūs).
- Mendel, Gregor J.** Austrian monk and botanist; 1822-1884.
- mer** (mēr). G.; part.
- meridional** (mē rīd' i ō nāl). Applied to lines or planes running from pole to pole.
- meroblastic** (mēr ō blās' tik). The term applied to an egg cell which in cleavage is only partly divided into blastomeres.
- Merriam, C. Hart.** American biologist; 1855-.
- mes** (mēs). G.; middle.
- mesencephalon** (mēs ēn sēf' ā lōn). The third region, or midbrain, of vertebrates, including the optic lobes.
- mesenchyme** (mēs' ēn kīm). A mesodermal mass of branched, irregular cells in the embryo from which arise the connective tissues generally; also written **mesenchyma** (mēs ēn' kī mā), a term which is also applied to the mass of connective tissue that occupies the center of the body in some lower forms, such as the planarians.
- mesentery** (mēs' ēn tēr ī). A double sheet of tissue attaching the alimentary canal to the body wall in vertebrates; or thin sheets of tissue connecting the stomodaeum to the body wall in sea anemones; adj., **mesenteric** (mēs ēn tēr' ik).
- mesoderm** (mēs' ō dūrm). The middle germ layer in embryogeny; adj., **mesodermal** (mēs ō dūr' māl).

- mesoglea** (měs ô glĕ' á). A layer, mostly noncellular, between the ectoderm and entoderm in coelenterates; if it contains scattered cells, these do not have the character of a mesoderm.
- mesonephros** (měs ô něf' rös). The kidney of the lower vertebrates, from the lamprey to the amphibians; adj., **mesonephric**.
- mesothelium** (měs ô thĕ' lĕ' ūm). A mesodermal sheet of cells in the embryo from which arise particularly the epithelia lining coelomic cavities and the striated muscles; adj., **mesothelial**.
- meta-** (mĕt' á). G.; after, behind.
- metabolism** (mĕ táb' ô lz'm). The sum of the chemical changes in a living organism, accompanied also by physical changes; adj., **metabolic** (mĕt á bö' lk).
- metagenesis** (mĕt á jĕn' ě sĭs). The regular alternation of sexual and asexual types of reproduction in a given species of animal.
- metamere** (mĕt' á mĕr). One of a lineal series of sections into which the bodies of the higher invertebrates and the vertebrates are divided; adj., **metameric** (mĕt á mĕr' lk).
- metamerism** (mĕ tām' ěr lz'm). The existence of metameres in the body of an animal.
- metamorphosis** (mĕt á mór' fō sĭs). A pronounced change in appearance during the development of an animal.
- metanephros** (mĕt á něf' rös). The kidney of reptiles, birds, and mammals; adj., **metanephric**.
- metaphase** (mĕt' á fāz). That period in mitosis when the chromosomes, having become lined up on the equator of the spindle, are divided into two, or, if splitting has previously occurred, when they become so arranged.
- metaplasm** (mĕt' á plāz'm). Nonliving matter in the cytoplasm of a cell.
- metencephalon** (mĕt ěn sĕf' á lōn). The fourth region of the vertebrate brain, including the cerebellum and pons.
- micro** (mĭ' erō). G.; small.
- microgamete** (mĭ krō gá mĕt'). A male sex cell, or sperm cell.
- micronucleus** (mĭ krō nū' klĕ ūs). The smaller of two nuclei in an infusorian.
- micropyle** (mĭ' krō pĭl). The minute opening in the covering of an egg of any one of certain types of animals through which a sperm cell enters.
- migration** (mĭ grā' shĭn), **periodic**. A periodic movement shared by all animals of a species, or all of those occupying a certain area, from that area to another on the earth's surface.
- milt**. The spermatid fluid of a male fish.
- mimicry** (mĭm' lk rĭ). A resemblance of one organism to another organism of a very different character.
- miracidium** (mĭr á sĭd' lĕ ūm). The first larval stage in flukes.
- mit** (mĭt). G.; thread.
- mitochondria** (mĭt ô kōn' drĭ á). Structures in a cell which seem to be normally present but the significance of which is unknown.
- mitosis** (mĭ tō' sĭs). Normal cell division; adj., **mitotic** (mĭ tōt' lk).
- molt**. To cast off an outer covering, such as a cuticula, scales, or feathers.
- mon-** (mōn). G.; single.
- monocious** (mō nĕ' shŭs). A species of animal having both male and female gonads in the same individual.
- monoblastic** (mōn ô blās' tik). Having one germ layer—the blastoderm.
- monohybrid** (mōn ô hĭ' brĭd). An offspring of parents differing by one character.
- Morgan, Thomas H.** American zoologist, at California Institute of Technology; 1866-.
- morph** (mōrf). G.; form, structure.

- morula** (mör' ōō lá). An embryo in an early stage when composed of a solid mass of cells.
- mucosa** (mū kō' sū). A membrane containing glands by which is formed a mucous secretion.
- mucus** (mū' kūs). A slimy secretion containing **mucin** (mū' sūn); adj., **mucous** (mū' kūs).
- Müller, Johannes P.** German physiologist and anatomist; 1801–1858.
- mutation** (mū tā' shūn). A sudden, heritable change in a character possessed by an organism due to a change in one or more genes.
- mutualism** (mū' tū āl Iz'm). An association of two animals of different species which is of advantage to both.
- myelencephalon** (mī ě lēn sēf' á lōn). The fifth, and most posterior, region of the vertebrate brain, including the medulla oblongata.
- myo** (mī' ō). G.; muscle.
- myoneme** (mī' ō nēm). A contractile strand in the cytoplasm of a protozoan.
- myria** (mīr' I á). G.; myriad, literally ten thousand.
- myx** (mks). G.; slime.
- Naiad** (nā' yād). A larva of an aquatic insect with incomplete metamorphosis.
- nares** (nā' rēz). The openings into the nasal chamber in vertebrates; the anterior nares open externally and the posterior nares open into the mouth or pharynx.
- nasal** (nā' zāl). Pertaining to the nose.
- natural selection.** The process in nature by which the types best fitted for their particular environment survive while those least fitted are eliminated.
- nauplius** (nó' plī ūs). The larva of certain of the Crustacea.
- negative response.** A response to a stimulus in which the organism turns or moves away from the stimulus.
- nekton** (nēk' tōn). That part of a pelagic aquatic fauna which is independent of the action of winds and waves.
- nemato** (nēm' á tō). G.; thread.
- nematocyst** (nēm' á tō síst). One of the stinging bodies found in coelenterates.
- neo-** (nē' ō). G.; new, recent.
- neoteny** (nē ōt' ē nī). The indefinite prolongation of the immature condition of an animal; in tailed amphibians it results in the production of axolotls, and in termites it is shown in the development of reserve females which take the place of lost queens.
- nephridium** (nē frīd' I ūm). An excretory organ found in certain invertebrates.
- nephros** (nēf' rōs). A vertebrate kidney.
- nerve.** A collection of nerve fibers inclosed in a sheath.
- nervous.** Pertaining to the nervous system or to any of its functions.
- nervous impulse.** The effect of stimulation transmitted along a nerve fiber.
- nervure** (nūr' vūr). A stiffening riblike structure in the wing of an insect.
- neural.** Pertaining to a nerve or to the nervous system.
- neurilemma** (nū rī lēm' á). The delicate membrane covering a nerve fiber.
- neuron** (nū' rōn). A nerve cell, including the cell body and all the branches, or fibers.
- nid** (nīd). L.; nest.
- noct** (nōkt). L.; night.
- nomenclature** (nō' mēn klā tyūr). A system of naming objects or concepts.
- noto** (nō' tō). G.; the back.
- notochord** (nō' tō kōrd). A rod of cells, derived from the entoderm, in the chordates lying in the median line below the spinal cord; it disappears as the vertebral column is developed; also called **chorda dorsalis**, or simply **chorda**.

- nuclear sap.** The more fluid part of a nucleus; also called **karyolymph**.
- nucleolus** (nū klē' ō lūs). In the nucleus a sharply defined body the nature and function of which vary in different nuclei and in many cases are unknown.
- nucleoplasm** (nū' klē' ō plāz'm). The protoplasm contained in the nucleus, as distinguished from cytoplasm.
- nucleus** (nū' klē' ūs). A portion of the protoplasm of a cell which is set off by a membrane and which contains the chromatin and also produces enzymes that stimulate the activities of the cytoplasm; adj., **nuclear**.
- nurse cell.** An egg cell which contributes its substance to another egg cell, which is developing, and therefore does not itself produce an embryo.
- nymph** (nūmf). The larva of an insect which undergoes incomplete metamorphosis; also the resting stage in the development of certain other invertebrates, coming in between the larva and the adult, as in certain mites; adj., **nympal**.
- Ocellus** (ō sēl' ūs). A simple eye, as in an insect.
- oid.** G.; like, resembling.
- olfactory** (ōl fāk' tō rī). Pertaining to the sense of smell.
- ommatidium** (ōm ā tid' ī ūm). A rodlike unit in a compound eye.
- ont** (ōnt). G.; a being.
- ontogeny** (ōn tōj' ē nī). The development of the individual from the egg cell to the adult condition; adj., **ontogenetic** (ōn tō jē nēt' īk).
- oo** (ō' ō). G.; egg.
- oocyte** (ō' ō sīt). An egg cell during the maturation period in oogenesis.
- oogenesis** (ō ō jēn' ē sīs). The development of a female germ cell from the primordial sex cell to the mature egg cell.
- oogonium** (ō ō gō' nī ūm). The female sex cell during the multiplication and growth periods in oogenesis.
- operculum** (ō pūr' kū lūm). A fold of skin covering the gills of an amphibian larva; a similar fold, containing scales, covering the gills of fishes; a horny or limy plate closing the opening of a snail shell; and other structures which are lidlike.
- optic** (ōp' tīk). Pertaining to the eye.
- optimum** (ōp' tī mūm). The most favorable condition; adj., **optimal**.
- oral.** Pertaining to the mouth.
- organ.** An assemblage of tissues all contributing to the performance of some function.
- organic** (ōr gān' īk). That which relates to living things, or has been so related.
- organism** (ōr' gān' īz'm). A mass of living matter capable of maintaining independent existence and all parts of which contribute more or less to the activities of the whole.
- organogeny** (ōr gā nōj' ē nī). The development of organs in embryogeny.
- ortho-** (ōr' thō). G.; straight.
- orthogenesis** (ōr thō jēn' ē sīs). The theory that animals tend to develop along lines leading constantly in the same direction and which are determined by internal factors.
- Osborn, Henry F.** American paleontologist, at American Museum of Natural History, New York; 1857-.
- osmosis** (ōs mō' sīs). The passage of two miscible fluids through a semipermeable membrane, like an animal membrane, which separates them.
- osmotic** (ōs mōt' īk) **pressure.** The unbalanced pressure due to differences of concentration in solutions which are on opposite sides of a semipermeable membrane.
- ossicle** (ōs' ī k'l). A small bone.
- oste** (ōs' tē). G.; bone.
- oto** (ō' tō). G.; referring to the ear; adj., **otic** (ō' tīk).

- otocyst** (ō'tōsĭst). An organ supposed to be one of hearing found in many invertebrates.
- ovary** (ō' vā rĭ). An organ which produces egg cells; adj., **ovarian** (ō vā' rĭ ān).
- oviduct** (ō' vĭ dŭkt). The duct leading from the ovary either to the outside of the body or to a cavity opening externally.
- oviparity** (ō vĭ pār' ĩ tĭ). The condition which involves the laying of eggs; adj., **oviparous** (ō vĭp' ā rŭs).
- ovipositor** (ō vĭ pōz' ĩ tēr). An organ which functions in the deposition of eggs, especially in insects.
- ovo** (ō' vō). L.; egg.
- ovoviviparity** (ō vō vĭv ĩ pār' ĩ tĭ). The condition which involves the laying of an egg that contains a living embryo.
- ovum**. An egg cell; also an egg, including the egg cell and its protective coverings.
- Owen, Richard**. English zoologist; 1804-1892.
- oxidase** (ōk' sĭ dās). An enzyme which promotes oxidation.
- oxidation** (ōk sĭ dā' shŭn). A chemical reaction involving the addition of oxygen in chemical combination.
- Pale-, palae-** (pā' lē). G.; old, ancient.
- palpus** (pāl' pŭs). An appendage, particularly in an arthropod, bearing organs for touch and taste; adj., **palpal**.
- pancreas** (pān' krē ās). A gland in vertebrates producing a variety of digestive secretions which are passed into the small intestine; adj., **pancreatic** (pān krē-āt' ĩk).
- papilla** (pā plĭ' ā). A small nipple-like projection, either from a surface or of one tissue into another; a papilla may contain a sense organ.
- para-** (pār' ā). G.; beside.
- parasite** (pār' ā sĭt). An animal which lives in or upon another animal, to the injury of the latter but normally without causing its death. The phenomenon is **parasitism** (pār' ā sĭt ĩz'm), and the adj., **parasitic** (pār' ā sĭt' ĩk).
- parenchyma** (pā rēn' kĭ mā). A loose mesodermal tissue contained in the bodies of some lower invertebrates, or the essential tissue which forms the mass of an organ.
- Parker, George H.** American zoologist, at Harvard University; 1864-.
- parthen** (pār' thēn). G.; virgin.
- parthenogenesis** (pār thē nō jēn' ē sĭs). The production of an offspring from an unfertilized egg cell; adj., **parthenogenetic** (pār thē nō jēn ēt' ĩk).
- Pasteur** (pās tūr'), **Louis**. French chemist, 1822-1895.
- pathogenic** (pāth ō jēn' ĩk). Disease-producing.
- pectoral** (pēk' tō rāl). Pertaining to the region of the body opposite the fore limbs.
- ped** (pēd). L.; foot. **Pedal** (pē' dāl). Pertaining to the foot.
- pedo-, paedo-** (pē' dō). G.; child.
- pedogenesis** (pē dō jēn' ē sĭs). The production of young by an immature animal.
- pelagic** (pē lāj' ĩk). Pertaining to the open water in an aquatic environment.
- pelvic** (pēl' vĭk). Pertaining to the region of the vertebrate body opposite the hind limbs; a bone or bones in this region articulating with the vertebral column and giving attachment to the hind limbs forms a **pelvis** (pēl' vĭs).
- penis** (pē' nĭs). A male copulatory organ.
- pepsin** (pēp' sĭn). An enzyme produced in the stomachs of vertebrates which changes proteins to peptones.
- peri-** (pēr' ĩ). G.; around.
- pericardium** (pēr ĩ kār' dĭ ūm). A coelomic or hemocoelic cavity in many invertebrates containing the heart; in vertebrates, a membranous sac inclosing a cavity which contains the heart; adj., **pericardial**.

- periosteum** (pěr I ős' tē ūm). A fibrous membrane covering a bone; adj., **periosteal**.
- peristalsis** (pěr I stäl' sīs). A succession of rhythmical contractions of the wall of the intestine, or other muscular tubes, which drives the contents onward; adj., **peristaltic**.
- peritoneum** (pěr I tō nē' ūm). The membrane lining the coelomic cavity; in mammals limited to the abdominal cavity; adj., **peritoneal**.
- Pfänger, Eduard**. German physiologist; 1829-1910.
- phag** (fāj). G.; eat.
- phagocyte** (fäg' ō sīt). A leucocyte when engaged in the engulfing and destruction of other cells or various foreign objects.
- pharynx** (fär' ĩnks). A region of the alimentary canal between the mouth cavity and the esophagus; adj., **pharyngeal** (fä rĩn' jē āl).
- phenotype** (fē' nō tĭp). A type of organism considered as a complex of visible characters; adj., **phenotypic** (fē nō tĭp' ĩk).
- phore** (fōr). G.; bearer.
- photo** (fō' tō). G.; light. **Photic** (fō' tĭk). Pertaining to light.
- photosynthesis** (fō tō sĭn' thē sīs). The production of carbohydrates from carbon dioxide and water by chlorophyll, using the energy of sunlight.
- phototropism** (fō tōt' rō pĭz'm). The response of an organism to light; adj., **phototropic** (fō tō trōp' ĩk).
- phyl** (fil). G.; race, or tribe.
- phylogeny** (fi löj' ē nĭ). The series of stages passed through in the evolution of a group of animals; adj., **phylogenetic** (fi lö jĕn' ĩk) or **phylogenetic**.
- physiological state**. A condition of an organism at any given time which is the resultant of the metabolic processes that have preceded and which determines the manner in which the organism will respond to stimulation.
- phyt** (fĭt). G.; plant.
- pia mater** (pĭ' ā mā' tēr). A delicate connective tissue membrane closely adherent to the spinal cord and brain of vertebrates.
- pineal** (pĭn' ē āl) **body**. A dorsal outgrowth of the diencephalon in vertebrates; it probably served as an eye in primitive vertebrates now extinct and remains as a rudimentary structure in living forms, in some of which it may function as an endocrine gland. Also called **pineal eye** and **pineal gland**.
- pituitary** (pĭ tū' ĩ tā rĭ) **body**. A ventral outgrowth of the diencephalon in vertebrates, to which is added tissue from a dorsal outgrowth of the mouth cavity; it functions in many forms as an endocrine gland.
- placenta** (plā sĕn' tā). An organ by which the young of a mammal becomes attached to the wall of the maternal uterus and through which it receives food and oxygen and disposes of waste; it is derived in part from the chorion of the embryo, in some cases including the allantois, and in part from the uterine wall; adj., **placental**.
- plankton** (plānk' tōn). That part of a pelagic fauna made up of small and weak organisms which are at the mercy of winds and waves.
- plano** (plā' nō). L.; flat.
- plasm** (plāz'm). G.; anything formed; in biology, living matter.
- plasma** (plāz' mā). The liquid part of the blood.
- plasma membrane**. A living membrane on a cell, as distinguished from a nonliving cell wall.
- plasmosome** (plāz' mō sōm). A nucleolus not composed of chromatin.
- plast** (plāst). G.; an organized particle or granule, including a cell.
- plastid** (plās' tĭd). A body in the cytoplasm of a cell carrying on some constructive chemical process, as the chlorophyll bodies, or chloroplasts.
- platy** (plā' tĭ). G.; flat, broad.

- pleural cavity.** That part of the coelom in mammals which contains the lungs; the lining membrane is the **pleura**.
- plexus.** A network of nerves.
- Pliny** (plĭn' ū); **Caius Plinius Secundus, the Elder.** Roman naturalist; 23-79.
- pneumo** (nū' mō). G.; air, breath, consequently soul or spirit.
- pod** (pōd). G.; foot.
- polar body.** A nonfunctional cell produced in the maturation divisions of an egg cell.
- polarity** (pō lār' ū tī). That condition in a body connected with the dominance of one part over another, or in a conducting substance that which determines the direction in which conduction will take place.
- poly** (pōl' ū). G.; many.
- polyandry** (pōl ū ān' drī). The mating of one female with several males.
- polygamy** (pō lġ' ā mī). The mating of several females with one male.
- polymorphism** (pōl ū mōr' fīz'm). The existence of more than one form of the same species; adj., **polymorphic**; if there are only two forms, the condition is spoken of as **dimorphism**.
- polyp** (pōl' ū p). An attached coelenterate.
- portal system.** A capillary system interposed in the course of a vein; when used without qualification it is that part of the venous system which passes blood through the liver.
- positive response.** A response in which an organism turns or moves toward the stimulus.
- post-** (pōst). L.; after, behind.
- posterior** (pōs tē' rī ēr). Behind; in a bilaterally symmetrical animal with the axis horizontal, away from the head.
- precocial** (prē kō' shāl). Term applied to a bird the young of which have down, leave the nest, and are active as soon as they have hatched.
- predaceous** (prē dā' shūs). Preying on other animals; the condition is known as **predatism** (prēd' ā tīz'm).
- preformation** (prē fōr mā' shūn). The conception formerly held that the parts of an organism were preformed in the germ cell.
- primates** (prī' māt). Animals belonging to the mammalian order Primates (prī-mā' tēz).
- primordial** (prī mōr' dī āl). The first in order, original.
- pro-** (prō). G.; before.
- proboscis** (prō bōs' ūs). A forward extension of the head, especially of the snout in mammals.
- proctodeum** (prōk tō dē' ūm). An invagination of the surface of an embryo which meets the posterior end of the archenteron and forms that portion of the alimentary canal just before the anus.
- proglottid** (prō glōt' ūd). One of the individuals in a tapeworm colony.
- pronephros** (prō nēf' rōs). A primitive vertebrate kidney, functional only in the hag; adj., **pronephric**.
- pronucleus** (prō nū' klē ūs). The nucleus of a sperm cell after it has entered an egg cell and also that of the egg cell itself before the two have united in fertilization; they are termed, respectively, male and female pronuclei.
- prophase** (prō' fāz). The first phase in mitosis, lasting until the chromosomes are lined up in the equator of the spindle.
- proprioceptor** (prō prī ō sēp' tūr). A receptor contained within the tissues of the body and stimulated by conditions in the tissues themselves.
- prostate** (prōs' tāt) **gland.** A gland connected with the male reproductive system which produces a secretion that stimulates the sperm cells to activity.

- prostomium** (prō stō' mī ūm). A lobe overhanging the mouth of an earthworm which functions as a lip; it is not considered a metamere; adj., **prostomial**.
- protective resemblance**. A resemblance of an animal to its environment which tends to make it inconspicuous.
- protein** (prō' tē in). An organic compound, containing carbon, hydrogen, oxygen, and nitrogen, and which is an essential constituent of protoplasm.
- proto-** (prō' tō). G.; first, primary.
- protoplasm** (prō' tō plāz'm). The living substance; of very complex composition; adj., **protoplasmic** (prō tō plāz' mīk).
- protrusible** (prō trōō' sī b'l). Capable of being put out or protruded.
- proventriculus** (prō vēn trīk' ū lūs). The anterior glandular portion of the stomach, or a dilation of the alimentary canal in front of the gizzard.
- pseudo-** (sū' dō). G.; false.
- pseudopodium** (sū dō pō' dī ūm). A temporary locomotor protrusion from the surface of a cell.
- pter** (tēr). G.; wing.
- ptyalin** (tī' ā līn). The enzyme in the saliva that changes starches to sugars.
- pulmonary** (pūl' mō nā rī). Pertaining to the lungs.
- pulmonate** (pūl' mō nāt). Possessing lungs.
- pupa** (pū' pā). The quiescent stage between larva and adult in insects with complete metamorphosis; adj., **pupal**.
- Purkinje** (pūr kīn' yč), **Johannes E.** Czechish biologist; 1787-1869.
- pylorus** (pī lō' rūs). The opening from the stomach into the intestine; adj., **pyloric** (pī lōr' ik).

- Radial** (rā' dī āl) **symmetry**. Applied to an organism in which the body can be divided into a number of parts separated by radial planes.
- Ray, John**. English biologist; 1628-1705.
- re-** (rē). L.; again.
- reaction** (rē āk' shūn). The response which follows the application of a stimulus to a living organism.
- reason**. As a basis for behavior, the ability to analyze previous experiences, perceive analogies, and by a logical process arrive at an abstract conception which may determine subsequent action.
- recapitulation** (rē kā pīt yū lā' shūn) **theory**. The conception that stages passed through in the evolution of the race to which an animal belongs are repeated in the development of the individual.
- receptor** (rē sēp' tōr). A sense organ serving for the reception of stimuli; also a solitary cell acting in the same fashion.
- recessive** (rē sēs' iv). One of a pair of allelomorphic characters which does not appear because of the dominance of the gene corresponding to the other of the pair.
- rect** (rēkt). L.; straight.
- rectum**. The terminal portion of the large intestine in higher vertebrates and also in some invertebrates; adj., **rectal**.
- Redi** (rā' dē), **Francesco**. Italian naturalist; 1626?-1697.
- redia** (rē' dī ā). A stage in the development of a fluke; rediae are produced parthenogenetically in the sporocyst.
- reduction**. The halving of the number of chromosomes in the maturation period of gametogenesis.
- Reese, Albert M.** American zoologist, at University of West Virginia; 1872- .
- reflex arc**. A chain of cells which in the simplest form of the arc are three in number—a receptor neuron on the surface which receives a stimulus and passes the effect as an impulse to an adjustor neuron; this in turn passes it on to an effector cell that performs an appropriate act.

- reflex action.** An action involving one or more reflex arcs.
- regeneration** (rě jěn ěr ā' shūn). The replacement of lost parts.
- renal** (rě' nāl). Pertaining to the kidney.
- rennin** (rěn' ĩn). An enzyme produced in the stomach of mammals which coagulates the proteins in milk.
- reproduction** (rě prō dūk' shūn). The production of a new organism by an older one.
- respiration** (rěs pī rā' shūn). The exchange of oxygen and carbon dioxide between an organism and its environment, or between the blood and different tissues.
- response** (rě spōns'). An action on the part of an organism caused by a stimulus.
- resting cell.** A cell not undergoing division.
- rete** (rě' tē). A network, diminutive **reticulum** (rě tik' ũ lūm); adj., **reticular**.
- retina** (rět' I nā). The receptor cells of the eye; adj., **retinal**.
- retractile** (rě trāk' tīl). Capable of being withdrawn.
- retro-** (rět' rō). L.; backward.
- retrogression** (rět rō grěsh' ũn). The going backward by an animal during its development to a condition characterizing animals lower in the scale of life.
- reversion** (rě vūr' shūn). The reappearance of an ancestral character after a lapse of several generations.
- rhabd** (rābd). G.; rod.
- rheotropism** (rě ōt' rō pīz'm). A response by an organism to stimulation by a current of air or water; adj., **rheotropic** (rě ō trōp' ik).
- rhiz** (rīz). G.; root.
- rhyncho** (rīn' kō). G.; snout.
- rhythmicity** (rīth mīs' I tī). Variations repeated at regular intervals.
- roe.** The eggs of fishes.
- Ross, Sir Ronald.** English physician; 1857-1932.
- rota** (rō' tā). L.; wheel.

- Saliva** (sā lī' vā). The secretion of the salivary glands.
- sapro** (sāp' rō). G.; decayed, rotten.
- saprophytic** (sāp rō fit' ik). Securing nourishment from the products of organic decomposition.
- sarco** (sār' kō). G.; flesh.
- sarcode** (sār' kōd). The term first applied to protoplasm by Dujardin.
- sarcolemma** (sār kō lēm' á). The delicate membrane about a cross-striated muscle fiber.
- sarcoplasm** (sār' kō plāz'm). The protoplasm of a striated muscle fiber outside the **sarcostyles** (sār' kō stils), or longitudinal fibrils.
- scaph** (skāf). G.; something hollow, boat.
- Schleiden** (shlī' dēn), **Matthias J.** German botanist; 1804-1881.
- Schultze** (shōōl' tsē), **Max J. S.** German biologist; 1825-1874.
- Schwann** (shvān), **Theodor.** German zoologist; 1810-1882.
- Sclater** (sklā' tēr), **Philip L.** English zoologist, 1829-1913.
- scler** (sklēr). G.; hard.
- sclerotic** (sklēr ōt' ik). The outer dense fibrous coat of the vertebrate eye.
- scolex** (skō' lēks). The oldest, and attaching, individual in a tapeworm colony.
- scut** (skūt). L.; shield.
- scute** (skūt). A ventral scale of a snake which is placed transversely and extends from one side of the body to the other.
- scyph** (skīf). G.; cup.
- scyphistoma** (sī fīs' tō má). An attached polyp-like stage in a scyphozoan.
- sebaceous** (sē bā' shūs). A term applied to oil glands connected with the hairs of mammals.

- secondary sexual characters.** Characters of an animal associated with the sex but not connected with the reproductive system.
- secretion** (sě krě' shŭn). The passage from a cell of waste matter which can be utilized by the body; also the substance itself **secretory** (sě' krě' tō rĭ), pertaining to secretion.
- Sedgwick, Adam.** English zoologist; 1854-1913.
- segregation** (sěg rě gā' shŭn). The separation of paired genes during the maturation of the sex cells, which thereby pass on only one gene and are "pure" for the corresponding character.
- self-fertilization.** The fertilization of an egg cell by a sperm cell produced in the same individual.
- semi-** (sēm' i). L.; half.
- seminal receptacle** (sēm' i nāl rě sěp' ta k'l). A sac in the body of a female animal in which the sperm cells are stored until used.
- seminal vesicle** (vēs' i k'l). A sac in the body of a male animal in which sperm cells are stored until transferred to the female.
- semipermeable membrane.** A membrane permitting the passage of solvents but not of substances in solution unless they can be dissolved in the membrane.
- senescence** (sē nēs' čns). The period during which the organism is growing old.
- sensation.** The effect of a stimulus when registered in a center of consciousness in the brain.
- sense organ.** An organ for the reception of stimuli.
- serosa** (sě rō' sà). A membrane which secretes a watery fluid; the secretion is termed **serous** (sě' rūš).
- serum** (sě' rūm). The plasma of the blood from which the clot has been separated.
- Servetus** (sēr vė' tūs), **Michael.** Spanish author; 1511-1553.
- sessile** (sēs' il). Attached and not capable of locomotion.
- seta** (sě' tá). A fine bristle or spine; used in the annelids as a locomotor structure.
- sex.** The sum of the characters that distinguish male and female individuals; adj., **sexual** (sěk' shŭ ál).
- sex chromosome.** A chromosome the presence or absence of which in a sex cell is an important factor in determining whether the animal produced will be a male or female.
- sex-linked.** A term applied to a character which is associated with sex, the gene corresponding to it being in the sex chromosome.
- Shelford, Victor E.** American zoologist, at the University of Illinois; 1877-.
- skeleton** (skěl' ē tŭn). The firm supporting parts of an animal body; adj., **skeletal**.
- skull.** The bones of the head in a vertebrate.
- society.** An association of animals of the same species.
- som** (sōm). G.; body.
- somatic** (sō māt' ik). Referring to the body cells as distinguished from the germ cells; or to the wall of the body as distinguished from the viscera contained in it.
- somatoplasm** (sō' mā tō plāz'm). The protoplasm of the body as distinguished from the germ plasm.
- somite** (sō' mīt). A metamere.
- special creation.** The conception that each species of animal is the result of a particular creative act.
- specialization.** The distribution of functions to certain organs or parts, which become adapted to the performance of the respective functions.
- species** (spē' shēz). A distinct kind of animal; adj., **specific** (spē sĭf' ik).
- sperm, sperm cell, or spermatozoon** (spŭr mā tō zō' ōn). The male sex cell.
- spermary.** A gonad producing sperm cells.

- spermatid** (spûr' mâ tîd). A male sex cell after the second maturation division in spermatogenesis, before its metamorphosis into a sperm cell.
- spermatocyte** (spûr' mâ tō sî). A male sex cell during the period of maturation in spermatogenesis.
- spermatogenesis** (spûr' mâ tō jën' ě sîs). The production of sperm cells from primordial germ cells.
- spermatogonium** (spûr' mâ tō gō' nî ūm). A male sex cell during the periods of multiplication and growth in spermatogenesis.
- spermatophore** (spûr' mâ tō fōr). A mass of sperm cells, usually inclosed in a membrane or capsule.
- sphincter** (sfînk' tēr). A muscle surrounding an opening which, by its contraction, it closes.
- spicule** (spîk' ūl). A minute limy or siliceous crystal-like object embedded in the tissues of an animal which serves to stiffen or support the body or part.
- spinal cord**. Of vertebrates the central nervous system exclusive of the brain.
- spinal column**. The bony column, or vertebral column, which incloses the spinal cord.
- spindle, mitotic**. The portion of a cell in mitosis lying between the centrosomes, having the shape of a spindle and appearing in a microscopical preparation as if containing a framework of fibers.
- spiracle** (spîr' á k'l). In insects, one of the openings into the tracheal tubes; in sharks, a modified and usually non-functional gill slit opening internally into the cavity of the pharynx and externally upon the surface of the head; in amphibians, the external opening of a chamber on the inner wall of which are the external openings of the gill slits.
- spiral cleavage**. Cleavage in which the blastomeres are spirally arranged.
- spireme** (spî' rēm). A thread of chromatin appearing early in the prophase of mitosis which later breaks transversely into chromosomes.
- splanchno** (splānk' nô). G.; viscera; adj., **splanchnic** (splānk' nîk), pertaining to the viscera.
- spongin** (spûn' jîn). The horny substance which forms the fibers of fibrous sponges.
- spontaneous generation**. Same as abiogenesis.
- spore** (spōr). A minute reproductive cell produced by a protozoan, either sexually or asexually, and usually contained in a shell, though in some cases motile.
- sporocyst** (spō' rō sîst). A stage in the development of the liver fluke following the encystment of the miracidium.
- sporulation** (spōr ōō lā' shŭn). The production of spores by a protozoan.
- squam** (skwām). L.; a scale; adj., **squamous** (skwā' mŭs).
- stato** (stāt' ō). G.; standing, fixed.
- statoblast** (stāt' ō blāst). An asexual winter bud of a bryozoan, which is inclosed in a chitinous shell.
- statocyst** (stāt' ō sîst). An organ of equilibrium and orientation in many invertebrates.
- steapsin** (stē āp' sîn). The enzyme in the pancreatic secretion which changes fats to fatty acids and glycerin.
- stigma** (stîg' mâ). An eyespot in protozoans; also the same as a spiracle in an insect.
- stimulus** (stîm' ū lŭs). Any condition either external or internal to the body which causes a response in a living organism.
- stom** (stōm). G.; mouth.
- stomach** (stŭm' ūk). An enlarged portion of the alimentary canal in which the food is accumulated and in which it also may be reduced to fine particles and partly digested.
- stomodeum** (stō mō dē' ūm). An invagination of the surface of an embryo which meets the anterior end of the archenteron and forms the mouth cavity.

stratum (strā' tūm). One of a series of layers; **stratified** (strāt' fīd), arranged in layers. In ecology, **stratification** refers to vertical distribution at a particular location.

striated (stri' āt ēd). As applied to muscle fibers, cross-banded.

strobila (strō bī' lā). A chain of individuals produced by budding from the scyphistoma of a scyphozoan; also now being applied to a tapeworm colony.

sub- (sūb). L.; under, below.

succession (sūk sēs' h' ūn). The successive occupation of a given area by different types of animals; adj., **successional**.

super- (sū' pēr). L.; over, above.

superficial (sū pēr fish' āl) **cleavage**. Cleavage which results in a layer of blastomeres surrounding a central mass of yolk.

supra- (sū' prā). L.; over, above.

suture (sū' tyūr). A line of junction.

Swammerdam (swām' ēr dām), **Jan.** Dutch zoologist; 1637–1680.

Sylvius (sil' vī ūs), **Jacobus.** French anatomist; 1478–1555.

symbiosis (sīm bī ō' sīs). An intimate association of two organisms of different species, neither of which can flourish in the absence of the other; adj., **symbiotic** (sīm bī ōt' ik).

symbols. Selected symbols in common use in zoology are:

♂ signifies male.

♀ signifies female.

♁ signifies neuter.

μ signifies micron (¹/₁₀₀₀ millimeter).

μμ signifies millimicron (¹/₁₀₀₀ micron).

× signifies crossed with; also magnified by.

= signifies a synonym.

? signifies doubt.

! signifies affirmation.

symmetry (sīm' mē trī). Regularity of form, or balance between parts; adj., **symmetrical** (sī mēt' rī kāl).

syn- (sīn). G.; together (**syn-** becomes **sym-** before **b**, **m**, and **p** and **syl-** before **l**).

synapse (sī nāps'). The area of contact of two nerve fibers from different neurons.

synapsis (sī nāp' sīs). The union of two similar chromosomes, one from each parent, in the growth period of gametogenesis; adj., **synaptic**.

syncytium (sīn sīsh' y ūm). A mass of protoplasm containing many nuclei but not divided into separate cells; adj., **syncytial**.

syngamy (sīn' gā mī). The union of two sex cells to form a zygote.

system (sīs' tēm), **anatomical.** An association of organs for the performance of some general activity of the body.

systemic (sīs tēm' ik). Applying to the body generally.

Tact (tākt). L.; touch; **tactile** (tāk' tīl), pertaining to touch.

tarsus (tār' sūs). The ankle bones in vertebrates; the distal segments of the legs in insects and spiders; adj., **tarsal**.

taste bud. A group of gustatory cells with supporting cells forming an organ of taste.

tax (tāks). G.; an arranging, or arrangement.

tegumentary (tēg ū mēn' tā rī). Pertaining to the skin, or integument.

tele (tēl' ē). G.; far, far off.

telencephalon (tēl ēn sēf' ā lōn). The most anterior region of the vertebrate brain, including the cerebral hemispheres and olfactory lobes.

- telo** (tél' ô). G.; end.
- telolecithal** (tél ô lēs' I thāl). A term applied to an egg cell with the yolk massed at one pole.
- telophase** (tél' ô fāz). The last stages in mitosis, in which the cytoplasm is divided and the nucleus returns to the condition seen in a resting cell.
- tendon** (tēn' dūn). A mass of white fibrous connective tissue fibers forming an attachment for a muscle; adj., **tendinous**.
- tentacle** (tēn' tā k'l). A soft elongated, nonarticulated appendage found in a great variety of invertebrates and serving a great variety of functions; a tentacle may be used as a grasping organ, or it may bear sense organs; adj., **tentacular** (tēn tāk' ũ lār).
- terrestrial** (tēr rēs' trī šl). Living on or in the ground; used in distinction from aquatic.
- testis** (tēs' tīs). The male reproductive organ, in which sperm cells are produced.
- tetanus** (tēt' ā nūs). A state of continued contraction in a muscle fiber due to constantly repeated stimulation; adj., **tetanic** (tē tān' lk).
- tetrad** (tēt' rād). A chromatic body divided into four parts representing the halves of each of two chromosomes which have united in synapsis and have been precociously divided.
- Thales** (thā' lēz). Greek philosopher; seventh and sixth centuries B.C.
- therm** (thūrn). G.; heat.
- thermocline** (thūr' mō klīn). A horizontal plane appearing in a deep lake in summer below which the water is stagnant and above which frequent circulation is caused by wind and other agencies.
- thermotropism** (thēr mōt' rō plz'm). The response of an organism to a heat stimulus; adj., **thermotropic** (thūr mō trōp' lk).
- thigmo** (thīg' mō). G.; touch.
- thigmotropism** (thīg mōt' rō plz'm). The response of an organism to a contact stimulus; adj., **thigmotropic** (thīg mō trōp' lk).
- thorax** (thō' rāks). A portion of the body of many animals lying between the head, or head and neck, and the abdomen; adj., **thoracic** (thō rās' lk).
- tissue** (tīsh' ũ). A mass of similarly differentiated cells.
- tome** (tōm). G.; cut.
- tonsil** (tōn' sil). A mass of lymphoid tissue located, in man, one on each side of the passage from the mouth to the pharynx; adj., **tonsillar**.
- tonus** (tō' nūs). A state of continual moderate contraction in a nonstriated muscle fiber; adj., **tonic** (tōn' lk).
- toxin** (tōk' sūn). Any substance that acts as a poison in an animal body; adj., **toxic**.
- trachea** (trā' kē à). A tube conveying air into the body for the purpose of respiration; found in many arthropods and in all lunged vertebrates; adj., **tracheal**.
- traumatism** (trō' mā tīz'm). A condition in the body due to a physical injury.
- Trembley, Abraham**. Swiss naturalist; 1700-1784.
- trial and error**. A method of finding the most favorable condition or environment; in animals possessing intelligence it is done by conscious experimentation, in lower animals by automatic responses to stimuli due to random sampling.
- trich** (trīk). G.; hair.
- trichocyst** (trīk' ô sīst). One of many minute elongated sacs in the ectoplasm of a paramecium and similar protozoans, set at a right angle to the surface, the contents of which when thrown out form rodlike bodies used as weapons of defense and perhaps of offense.
- trihybrid** (trī hī' brīd). An offspring of parents differing by three characters.
- triploblastic** (trīp lō blās' tk). Having three germ layers.
- trocho** (trōk' ô). G.; a wheel.

- trope (trōp). G.; a turning.
- trophy (trō' fī). G.; nutrition.
- tropism (trō' pīz'm). The automatic response of an organism to a stimulus; adj., **tropic** (trō' pīk).
- trypsin (trīp' sīn). An enzyme which changes proteins to amino acids and is produced by the pancreas.
- tundra (tōōn' drā). A level, or gently undulating, treeless plain characteristic of the arctic regions of both hemispheres.
- tympanum (tīm' pā nūm). In vertebrate anatomy, the cavity of the middle ear; in zoology, the term is generally applied to any organ for the reception of sound waves and frequently to a membrane having that function; adj., **tympanic** (tīm pān' īk).
- Tyndall (tīn' dāl), **John**. English physicist; 1820-1893.
- Umbilical** (ūm bīl' ī kāl) **cord**. The cord that unites a mammalian fetus to the placenta.
- umbilicus** (ūm bīl' ī kūs). The point of attachment of the umbilical cord to the young animal.
- uncinate** (ūn' sīn āt). Hooked.
- unguiculate** (ūn gwīk' ū lāt). Clawed.
- uniparental** (ū nī pā rēn' tāl). Sexual reproduction involving only one parent.
- unit character**. A hereditary character that behaves as a unit in its transmission to offspring.
- urea** (ū rē' ā). The substance which contains most of the nitrogenous waste of the animal body; adj., **uric** (ūr' rīk).
- ureter** (ūr rē' tēr). The duct leading from the kidney and conveying the urine either to a urinary bladder or to the outside.
- urethra** (ūr rē' thrā). The duct from the urinary bladder to the external surface; adj., **urethral**.
- uterus** (ūr tēr ūs). A dilated portion of the oviduct in which egg cells are retained while undergoing more or less of their development; adj., **uterine** (ūr tēr īn).
- Vaccine** (vāk' sēn). Any substance introduced into the animal body to protect it from infection.
- vacuole** (vāk' ū ōl). A space in the cytoplasm of a cell usually filled with liquid and containing food or collecting liquid wastes to be eliminated.
- vagina** (vā jī' nā). The passage found in the female of many animals leading from the uterus to the outside; adj., **vaginal** (vāj' ī nāl).
- vas** (vās). L.; vessel.
- vascular** (vās' kū lār). Pertaining to vessels, especially blood vessels.
- vas deferens** (vās dēf' ēr ēnz). The duct leading from the testis to the outside; plural, **vasa deferentia** (vā' sā dēf' ēr ēn' shī ā).
- vas efferens** (vās ēf' ēr ēnz). One of a number of small ducts interposed between the testis and the vas deferens; plural, **vasa efferentia** (vā' sā ēf' ēr ēn' shī ā).
- vein**. A vessel conveying blood toward the heart; adj., **venous** (vē' nūs).
- ventricle** (vēn' trī k'l). A chamber in a heart from which blood is sent out; also a chamber in the vertebrate brain.
- ventro** (vēn' trō). L.; belly. Adj., **ventral**.
- verm** (vūrm). L.; worm.
- vermiform appendix**. The contracted end of the caecum in primates.
- vertebra** (vūr' tē brā). One of the bones of the vertebral column, or backbone, in vertebrates; adj., **vertebral** (vūr' tē brāl).
- Vesalius** (vē sāl' ī ūs), **Andreas**. Belgian anatomist; 1514-1564.

- vesicle** (vĕs' 1k'l). A small sac, especially one filled with fluid.
- vestigial** (vĕs' tĭj' 1 ä1). Existing only as a remnant of a former condition.
- villus** (vĭl' ũs). One of numerous, minute, vascular, finger-like projections on a surface, as on the surface of the small intestine or of the chorion in mammals.
- Virchow** (fĕr' kō), **Rudolph**. German pathologist; 1821-1902.
- viscera** (vĭs' ĕr ä). The soft organs contained in a coelom; adj., **visceral**; the application is often extended to cover the whole length of the alimentary canal, as in the case of pharyngeal arches and the visceral portion of the skull.
- vision**. The perception of an image derived from nervous impulses originating in an eye; a mental picture of objects external to the body.
- vitalism** (vĭ' täl 1z'm). The conception of a **vital force**, neither chemical nor physical, back of all life phenomena; adj., **vitalistic** (vĭ' täl 1s' tĭk).
- vitamin** (vĭt' ä mĭn). In certain foods a substance which plays a vital rôle in assimilation.
- vitreous** (vĭt' rĕ ũs). Glassy.
- viviparity** (vĭv 1pär' 1 tĭ). The condition which makes possible the producing of living young; adj., **viviparous** (vĭv 1p' ä rŭs).
- volant** (vō' länt). Capable of flying.
- Von Baer** (fōn bär') **Karl E.** Russian naturalist; 1792-1876.
- Von Mohl** (fōn mōl'), **Hugo**. German botanist; 1805-1872.
- Wallace, Alfred R.** English naturalist; 1823-1913.
- wandering cell**. A leucocyte moving about in the tissues of the body.
- Weismann** (vĭs' män), **August**. German biologist; 1834-1914.
- Whitney, David D.** American zoologist, at University of Nebraska; 1878-.
- Wilson, Henry V.** American zoologist, at University of North Carolina; 1863-.
- Wolff** (vōlf), **Caspar F.** German naturalist; 1733-1794.
- Woodruff, Lorande L.** American zoologist, at Yale University; 1879-.
- X-chromosome**. A chromosome occurring single or paired, the presence of which apparently determines sex.
- Y-chromosome**. An unpaired chromosome present in the cells of certain animals and also associated with sex.
- Yerkes, Robert M.** American psychologist, at Yale University, 1876-.
- yolk** (yōk). Nutritive matter stored in an egg cell; included under the term metaplasm.
- yolk gland**. A gland producing yolk.
- yolk stalk**. The connection of the yolk sac to the embryo in amniotic vertebrates.
- Zoo** (zō' ō). G.; an animal.
- zooid** (zō' oid). In a colony a small animal which has been produced by asexual reproduction.
- zygo** (zĭg' ō). G.; yoke, pair.
- zygote** (zĭ' gōt). The united sperm cell and egg cell.
- zymogen** (zĭ' mō jĕn). A substance which is developed in a gland cell and which may be changed to an enzyme.

INDEX

Note.—References to pages on which a figure appears are in **bold face type**. However, if a reference covers two or more pages, no indication of figures is given. Any outstanding reference in the text, when occurring among several, is in *italics*. If two or more references to the same page exist the page number is not duplicated.

A

- Abalone, 220
- Abdomen, crayfish, 250, **251**
 insect, **272**, 275
 spider, **296**
- Abdominal cavity, 317
- Abiogenesis, 265
- Abnormalities, inheritance of, 536
- Abomasum, **416**
- Abscess, 490
- Absorption, 32-34, 65, 102, 131, 138, 161, 167,
 168, 177, 196, 230, 246, 311, 323, 339, 439, 461
- Abundance rhythms, 482
- Acanthias*, 338
- Acanthocephala, 177, 181
- Accommodation, 332-333, 395
- Accretion, 17
- Acetabulum, **321**
- Acidity, 187, 479
- Acids, 8
- Acinous glands, **440**
- Acipenser rubicundus*, **345**
- Aconitia, **145**, 146
- Acquired characters, inheritance of, 517, 521,
536
- Acquired immunity, 491
- Acropora*, **152**
- Actinosphaerium eichhorni*, **81**
- Action pattern, 472
- Adambulacral plate, **193**
- Adaptation and adaptations, 166, 170, 201, 337,
 347, 357, 359-362, 375-377, 382, 393, 398,
 401, 416, 417, 455, 460, 463, 472, 479, 483,
 484, 487, 489, 490, 492, 501, 525
- Adelochorda, 308
- Adhesive papillae, tunicate, **312**
- Adjustment (*see* Adaptation)
- Adjustor, 163, 238, **239**, **327**, 468, 470
- Adolescence, **43**, **44**, 432-434
- Adrenal bodies, 367, 464, **465**
- Aedes*, **287**
- Aeolosoma*, 244, 248
- Aepyornis, 396, 506
- Aerial types, 484
- Aeronautic spiders, 299
- Afferent fiber, **239**
- Afferent impulse, 163
- Afferent path, 238
- Afterbirth, 421
- Aftershaft, **392**
- Age immunity, 490
- Ages, geological, 512
- Air bladder, 344, 346, *348-349*
- Air sacs, 276, **394**, 399
- Albumen, egg, **376**
- Alder flycatcher, 481
- Alimentary canal, 103, 175-179, 182, 183, 185-
 188, **195**, 200, **205**, **210**, 212, **219**, 230, **232**,
 242, 245-246, **253**, 254, **276**, **277**, **297**, 298,
304, 310, **311**, **314**, **317**, 321-323, 339, 350-351,
 372, 393, **394**, 408, 416, 438-439, 460-461,
 544-545, 547
- Alkalinity, 479
- Allantoic cavity, **377**
- Allantoic placenta, 412, 420
- Allantoic stalk, 377
- Allantoic vessels, **378**
- Allantois, 375, 377-378, 418-420
- Allelomorphs, 528
- Allergy, 489, *492*
 brain, **381**
- Alligator gar, **345**
- Alligator mississippiensis*, 387
- Alligators, 380, 387-389
- Alligators brain, **381**
- Alternation of generations, 106, *150-151*, 313
- Altitude, effect on distribution, 502-503
- Altricial young, 404
- Alveolar connective tissue, **99**
- Alveolar structure of protoplasm, **22**
- Alveoli, lung, 364, **441**
- Amber, fossils, 510
- Ambergris, 421
- Ambulacral groove, **192**
- Ambulacral plates, **193**, **203**
- Ambulacral pores, **193**
- Ambystoma*, 374
- Ambystoma tigrinum*, **365**
- Ameba, 63-68, 82, 86, 493
 fission, **67**
 locomotion, **66**
 metabolism, **32**
 sporulation, **67**
- Amebic dysentery, 87
- Amebocytes, 196, 442, 466
- Ameboid cells, 131, 324, 350, **368**, 440, 462, 490
- Ameboid movement, 466
- Ametabola, 278, **279**
- Amino acids, 461; absorption, **34**
- Amitosis, 49
- Ammocoetes, 336

- Ammonoids, 225, **513**
 Amnion, 375-378, 419, 421
 Amniotic cavity, **377, 378, 418, 419**
 Amniotic fluid, 376
 Amniotic fold, **377**
 Amniotic sac, 376
Amoeba, 63
Amoeba proteus, 63, **64, 67**
 Amphiasier, **47**
 Amphiasier stage, 47
 Amphibia, 334, 364
 Amphibians, 308, 334, 359-374, 417, 437-440, 442, 463, 504, 505, 511, 515
 (See also Cecilians; Frogs; Salamanders; Toads)
Amphibolips confluentis, gall, **286**
 Amphicoelous vertebrae, 350
 Amphineura, 217-218
 Amphioxus, 308, 309, **313, 314-315**
 development, **122, 307**
 section, **313**
 Amphipods, 262
 Ampullae, ear, **330, 331**
 echinoderms, **193, 194, 204, 205**
 Amylopsin, 323
Anableps, 354
Anableps dowii, **354**
 Anabolism, 37
 Anacondas, 385, 505
 Anaemia, 541
 Anal ciliated cells, 226
 Anal fin, **346, 348**
 Anal gland, **277**
 Anal opening (see Anus)
 Anal spot, 71
 Analogy, **53, 445, 543**
 Anaphase, **47, 48**
 Anaphylaxis, 492
 Anatomy, 5, 550-553
 Anaximander, 516
 Andalusian fowl, inheritance, **535**
 Anger, 473
 Angler fish, 358
 Angleworm (see Earthworm)
 Animal biology, 6
 Animal pole, 118, 371
 Animal husbandry, 6
 Animals, 406
 in absence of oxygen, 463
 classification, 57-58, 541-548
 compared and contrasted with plants 40, 41
 distribution, 4, 499-509
 evolution, 516-526
 forms, 51
 groups, 57
 limit of size, 44
 number, 3
 relation to environment, 4, 477-486
 to plants, 4, 477
 relations, 4
 variety, 3
 Annelida, 241, 242, 545, 547
 Annelids, 113, 229, 241-249, 268, 440-442, 445, 462, 512, 513
 Annual changes, 477, 482
 Annular cartilage, **336**
Anodonta grandis, **208, 209**
 Anodontas, 215, 216
Auopheles, 89, 287
 Ant bears, 415
 Ant lions, **290**
 Antarctica, 500
 Anteaters, 506
 Australian, 411
Antedon, **207**
 Antelopes, 416, 506
 Antennae, 186, 250-253, 256, **261, 269, 271-273, 277, 304, 305, 466**
 Antennary glands, 466
 Antennata, 305
 Antennules, 250-253, 256, **261, 497**
 Anterior chamber, eye, 332, **333**
 Anthozoa, 143-146, 494
 Anthrax, 555
 Anthropoid apes, 416, 422
 Anthropology, 5
 Antibodies (see Antitoxins)
 Antimeres, 51, 544
 Antitoxins, 490, 491
 Antrum, **329**
 Ants, 282, 284, 289, 291, **294, 295, 431, 455, 464, 481, 485, 494, 498, 543**
 white (see Termites)
Anuraphis maidiradicis, **284**
 Anus, 71, **85, 138, 175, 176, 178, 179, 183, 185, 188, 189, 192, 195, 197, 200, 204, 205, 210, 212, 218, 219, 222, 229, 230, 241, 245, 262, 263, 296, 297, 301, 304, 311-314, 316, 321, 323, 367, 408, 438, 544, 545**
 Aorta, **313, 360**
 dorsal, **317, 336, 339, 340, 360, 379**
 ventral, **339, 340, 360**
 Aortic arch, **360, 361, 379, 380, 393, 408, 409**
 Ape man, **424**
 Apes, 415, 422
 anthropoid, 416, 422
 Aphids, **284**
 Aphis lions, 290
 Apical plate, **226**
 Apiculture, 6
Apis mellifica, 291-293
 Apoda, 364, 367
 Appendages, 53, 250, 251, 260, 265, 297, 300, **304, 316, 320, 335, 348, 361, 363, 467, 545**
 (See also Fins; Legs; Wings; Tails; Antennae; etc.)
 Appendicular skeleton, 318
 Appendix vermiformis, **322, 408, 519**
Apteryx, **505**
 Aquatic environment, 460
 Aquatic habitat, 478
 Aqueous humor, **223, 332**
 Aquiculture, 6
 Aquinas, Thomas, 517
 Arachnida, 296, 305
 (See also Spiders)
 Arachnoidea, 305
Arbacia, **203**
 Arboreal life, 382, 415, 422, 423
 Arch, foot, 423
Archaeopteryx, 515

- Archaeopteryx macrura*, **397**
Archaeopteryx siemensi, **396**
 Archaeornithes, 396
 Archean period, 511, 512
 Archenteron, 119, 123, **372**, 419, 438
 Archannelida, 242
 Arctic tern, 402
Argonauta argo, **224**
 Aristotle, 25, 358, 516, 541, **549**, 552, 554
 Aristotle's lantern, 203, **204**, 438
 Armadillos, 406, 415, 505
 nine-banded, **414**, 538
 Arms, 316, 424
 Army worm, 285
 Arrow worm, 185
 Arteries, 297, 324, 551, 552
 Arthropoda, 260, 268, 271, 296, 304-305, 545, 547
 Arthropods, 250-305, 437-439, 441, 443, 445,
 449, 462, 467, 472, 513
 Articular cartilage, 104
 Artificial classification, 57
 Artificial immunity, 491
 Artificial parthenogenesis, 112-113
 Artiodactyla, 416
 foot bones, **415**
Ascaris, 175-176, 463, 498
Ascaris, 113, 114, 447
Ascaris lumbricoides, **175**
 Ascidians, 310-311
 Aseon, 129, **130**
 Asexual cycle, **88**
 Asexual reproduction, 45, 86, 105, 106, 132,
 134, **135**, 140, 149-151, 161, 168, 174, 189,
 225, 236, **248**, **249**, 313-314
 Asexual spore, **88**
 Asexual zooid, 248, **249**
 Asphalt lake, fossils, 510
 Asses, 421
 wild, 507
 Assimilation, **32**, **33**, 35, 42, 65, 71, 168
 Association fibers, 239
 Associations of animals, 493-498
 Associative memory, 473
Astacus, 253
Astacus fluviatilis, section, **253**
 Asteroidea, 201
 Asters, 46, **47**, **112**, **113**
 Astral rays, 46, **47**
 Asymmetry, 51, **70**
 Atoll, 152
 Atom, 8
 Atrial cavity, 311-314
 Atrial funnel, **310**, **311**
 Atriopore, 311, **313**, 314
 Atrium, **314**
 genital, 160-162
 of heart, 340
 (See also Auricle)
 Auditory meatus, **330**
 Auditory nerve, **330**
 Auditory organ (see Ear)
 Augustine, 516
Augelia, life history, **149**
 Auricle, **210**, **339**, 340, 361, **379**, 380, 393
 Auricularia, 206
 Australian region, **505**, 506
 Australian lady beetle, **289**
 Author's names, 59, 546
 Autogenous vaccines, 492
 Autonomic nervous system, 327
 Autonomic centers, 468
 Autosomes, 537
 Autotomy, 184, **198**, 202, 205, 258, 281, 489
 Aves, 334, 390, 396
 Avicularia, **188**, 189
 Avoiding reaction, **72**
 Axial gradient, **163**, **237**
 Axial skeleton, 318
 Axis cylinder process (see Axon)
 Axolotl, **365**, 374
 Axon, **100**, 101, 238
B
- Babbling thrushes, 507
 Baboons, 416
 Back swimmers, 284
 Bacteria, 27, 458, 512, 552
 in chemical cycles, **459**
 in food cycle, 458, 480
 Bacterial action, 458, **459**
 Bacterial theory, 26
 Badgers, 413, 417, 507
 Bailer, 250
 Baker, F. C., 219
 Balance, animal life, 480
 in body, 433
 income and outgo, 430
 Balancers, **275**
Balanoglossus, 309-310, 547
 Balantidial dysentery, 87
Balantidium, 87
Balantidium coli, **84**
Balanus hameri, **264**
Balanus tintinnabulum, **264**
 Balen, 417
 Ballooning spiders, 299
 Bandworms, 183, 184
 Barbels, 330
 Barbs, 391
 Barbules, 391
 Barnacles, 263-264, 494, 497
 Barriers to dispersal, 500-501
 Basal disc, 134, **135**, 139
 Basal granules, 466
 Basal metabolism, 465
 Basal plate, 146
 Basement membrane, **97**, **254**, **255**, 437
 Bases, 8
 Basket stars, 202
 Bats, 412-413, 417, 505, 506
 wing, **52**
 Beach fleas, 262
 Beaks, 379, 390, **399**, 401
 Bears, 413, 419, 506, 507, 509
 foot, **414**
 Beasts, 406
 Beavers, 415, 507
 skull, **407**
 Bêche-de-mer, 207

- Bedbug, 284
 Bee milk, 292
 Beebread, 292
 Bees, 291-295, 431, 455, 463, 473, 494, 543
 proboscis, 273
 Beetles, 275, 285, 289, 291, 485
 Behavior, 54-56, 66-67, 72-74, 131-132, 139-140,
 149, 155-156, 162-163, 174, 197-198, 206,
 213, 215-216, 225, 234-235, 256-257, 264,
 268-270, 290-293, 295, 298-299, 305, 315, 336,
 348, 354-355, 358, 369-371, 397-398, 402-
 403, 417-418, 469-476, 479, 493-498, 501-503
 Belly, muscle, 443
 Benthos, 483
 Bible, 25
 Bichat, 553
 Bighorn, 507
 Bilateral symmetry, 51, 164, 544-545, **547**
 Bile, 323
 Bile duct, **317**
 Binary division, 67
 Binomial nomenclature, 58-59, 543, 546
 Biogenesis, 265
 Biogenetic law, 265, 543, 554
 Biogenetic series, 265-267, 319, 325-327, **360**,
 438, 519-520
 Biology, 6, 40-41
 origin of word, 517
 Biota, 477
 Biotic factors, 479
 Biotic succession, 480-482
 Biparental reproduction, 105
 Bipinnaria, **197**, 198, 206
 Biradial symmetry, 155, 544, 547
 Biramous appendages, 251, 260
 Birds, 111, 289, 308, 334, 375-378, 390-405, 432,
 438, 442, 448, 450, 456, 457, 475, 493, 495,
 502, 505-507, 509, 515, 537
 branchial arches, **360**
 lung, **441**
 wing, **52**
 Birds of paradise, 402, 506
 Birth, 421
 Bisexuality, 105
 (See also Diecious)
 Bisons, 507
 American, 502, 507, 509
 Biting lice, 283
 Bittern, 481
 beak, **399**
 Bivium, 200
 Bladder, air, 344, 346, 348-349
 gall, 323
 swim, 348
 urinary, **317**, 325
 Bladder worm, 173
 Blastocoel, 119-123, 140, 371, **418**, 449
 Blastoderm, 119, **120**, 123, 140, 162, 258, **355**, 356,
 376, 449
 Blastoids, 513
 Blastomeres, 118-122, **149**, **150**, 162, **214**, **355**,
 372, **418**, 449, 538
 Blastopore, 119, **120**, **122**, 371
 Blastula, 119-123, 140, **149**, **150**, 198, 214, 236,
 372, **418**, 449
 Blending inheritance, 534, **535**
 Blepharoplast, 79
 Blind spot, **333**
 Blind worms, 367
 Blister beetles, 282
 Blood, 99, 212, 230, 231, 276, 324, 462, 491
 Blood corpuscles, **29**, 231, 316, 324, 462, 552
 Blood plasma, 231, 316, 324, 462
 Blood platelets, 324
 Blood pressure, 462, 464
 Blood serum, 324, 491
 Blood-vascular system, 441, 462
 nematines, 183
 (See also Circulatory system)
 Blowing of whales, 417
 Body, fighting disease, 490
 self-regulation, 489
 Body cavity, **176**, **177**, **182**, 185, 317, 547
 (See also Coelom; Hemocoel)
 Body changes, 432
 Body coverings, 378, 456
 Body divisions, 544-545
 Body heat, 455
 Body mass, **210**, 211
 Body plan, 316, **317**
 Body regions, 304
 Body stalk, **418**, 420
 Body surface in respiration, 440
 Bone, 98, **99**, 320, 463
 corpuscle, **29**
 Bones, 103, **104**, 318-320
 (See also Skeleton)
 Bony fishes, 344
 Bony ganoids, 344, 345
 Bony labyrinth, 330
 Book gills, **302**, 303, 440
 Book lungs, **297**, 298, 300, 440
 Borers, 285
 Bottom forms, 483
 Bouton, **273**
 Bowfin, 345
 Bowman's capsule, **326**
 Brachiolaria, 206
 Brachiopoda, 189, 544, 547
 Brachiopods, 189-190, 437, 440-442, 513
 Brain, 225, 240, **276**, 277, 307, **312**, 314-317, 328,
 336, **337**, **340**, 341, **351**, 352, 368, **370**, 380,
 381, **395**, 408, **410**, **423**, 464, 518, 545
 Branchial arches, **360**, 361, 519
 Branchial arteries, **339**, 340, **360**, 361
 Branchial pouch, 373
 Branchiata, 305
 Branchiostegal membrane, **352**, 353
 Branchiostegal rays, **346**
 Breaking point, 258
 Breathing, **352**, 353, 408
 Breeding, 534, 536
 Bridges, 499
 Brittle stars, 201, **202**, 513
 Broadbills, 507
 Bromine, 19
 Bronchi, **441**
 Brood pouch, **263**, 264
 Brown, Robert, 31
 Bruner, L., 282

- Brush turkey, 404, 506
 Bryozoa, 187, 544, 547
 Bryozoans, 187-189, 437, 440-442, 513
 Bubonic plague, 289, 491
 Buccal cavity, 230, **232**, **233**, 321
 (See also Mouth)
 Buccal tentacles, **313**, 315, **336**
 Budding, **86**, 105, 132, **134**, **135**, 140, 149-151, 189, 493
 Buffon, 517
 Bug, 284
Bugula avicularia, **188**
 Bulbus arteriosus, 341
 Bull snake, head, **383**
 Bullhead, 330
 Bumble bees, 293
 Burrowing insects, leg, **274**
 Burrowing owl, 509
 Bursa, **179**, **182**
 Burying beetles, 290
 Butterflies, 273, **281**, 285, 543
 wing, **53**
 Butterfly snails, 220
 Byssus, 221
- C
- Caducibranchs, 364, 365
 Caeca, **193**, **195**, 277, **297**, 408, 439, **519**
 Cake urchins, 203
 Calcarea, 128, 129
 Calciferous glands, **232**
 Calcium, 18
 Calcium metabolism, 464
 Cali, embryo, **520**
Callinectes sapidus, **261**
Calosoma scrutator, leg, **274**
Cambarus, 253
 section, **252**
Cambarus diogenes, **251**
Cambarus obesus, **251**
Cambarus virilis, **252**
 Cambrian period, 511-514, 520
 Camels, 416, 421, 507, 525
Campodea staphylinus, **279**
 Canal systems, ctenophores, **154**
 sponges, 129, **130**
 Canaliculi, **99**, 320
 Canary, 405
 Canine teeth, 407, **408**
Canis familiaris, 58
 Cankerworm, 285
 Capillaries, 324
 Capsule, joint, **104**
 Carapace, 250
 Carbohydrates, 19-20, 38, 454, 464
 absorption, **34**
 Carbon, 18, 458
 cycle, 458, **459**
 Carbon dioxide, 35, 36, 42, 324, 458-460, 463
 Carboniferous period, 511, 514
 Cardiac muscle (see Heart muscle)
 Cardiac opening, **322**
 Cardinal, 509
 Cardinal vein, **317**, **339**
 Carnivora, 411, 413
 Carnivores, 421, 439
 Carolina wren, 509
 Carotid artery, **339**, **360**, 361, **379**, **409**
 Carpals, 319
 Carpet beetle, 285
Carpocapsa pomonella, 286
 Carpas, **321**, 362, **391**
 Carrion beetles, 290
 Cartilage, 98, **99**, 463
 bone, 319
 of ear, **519**
 Cartilages, 103, **336**
 Cartilaginous ganoids, 344, 345
 Cassowaries, 506
 Castle, W. E., 534
 Catalysis, 13
 Catalysts, 13
 Cataract, congenital, 537
 Catastrophism, 553
 Caterpillar, 279
 Catfishes, 330, 348
 Cats, 413
 foot, **414**
 Cattle, 416, 421
 (See also Ox)
 Cattle fever tick, 301
 Caucasian type, 425
 Caudal artery, **339**
 Caudal cirrus, **183**
 Caudal fins, 185, **346**, 348, **349**
 Caudal gland, **178**
 Caudal vein, **339**
 Caudal vertebrae, 320
 Cave faunas, 484
 Caviar, 358
 Caymans, 388
 Cecidology, 288
 Cecilians, 364, 367
 scales, 437
 Cecropia silkworm, 470, **481**
 Cell, 28-31, 40, 41
 division (see Mitosis)
 doctrine, 31
 of insect wing, 275
 organs, 85
 theory, 31, 554
 Cells (see different types by name)
 Cellulose, 41, 310
 Cement gland, 185, **186**, 544
 Cementum, 318, 407, **408**
 Cenogenetic adaptations, 451
 Cenozoic era, 511
 Centipedes, 269-270
 Central body, 30, **31**, 46, **47**, **112**, **113**
 Central nervous system, 233, 277, 327, 444, **445**, 468
 Central sulcus, **423**
 Centralization, 164, 277, **278**, 431, 445, 468
 Centriole, **30**, 31
 Centrolecithal egg cells, 117-119, 264, 449
 Centrosome, 30
 Centrum, vertebra, **317**
Centrus, 300
 Cephalization, 277, **278**, 304, 431, 445, 468

- Cephalochordata, 308, 314, 547
 Cephalopoda, 217, 221, 438, 513
 Cephalothorax, 250, **251**, **296**, 299, **302**
 Cercaria, **171**, 172
 Cere, **394**
 Cerebellum, 328, 336, **337**, **340**, 341, **351**, 352,
 368-370, 380, **381**, **395**, 408, **410**, **423**
 Cerebral cortex, 380
 Cerebral hemispheres, 328
 (See also Cerebrum)
 Cerebral vesicle, 315
Cerebratulus, **183**
Cerebratulus lacteus, 183
 Cerebropleural ganglia, **210**, 213
 Cerebrosides, 19
 Cerebrospinal system, 327, 369
 Cerebrum, **337**, **340**, **351**, 352, 368-370, 380, **381**,
395, 408, **410**, **423**
 Cervical groove, 251
 Cervical vertebrae, **319**, 320
 Cestoda, 165-167
 Cetacea, 411, 417
Chaetoderma nitidulum, **218**
 Chaetognatha, 185, 544, 547
 Chaetopoda, 242-244, 513
 Chalaza, **376**
 Chalcid flies, 291
Chalina oculata, **129**
 Chalk, 82
 Chambered nautilus, **224**
 Chambers, eye, 332, **333**
Chameleo vulgaris, **382**
 Chameleons, 379-382
 Chamois, 507
 Characteristics, 527
 Characters, 527, 528, 536
 acquired, 517, 521, 536
 dominant, 528
 recessive, 528
 sex-linked, 539
 tests, 534
 Chat, yellow-breasted, 509
 Checkerboard diagrams, 531-533
 Cheeks, 406
 Chela, 250, **251**, **253**, 256
 Chelicera, **296**, **297**, **300**
 Cheliped, 250
 Chemical changes in body, 452
 Chemical control, 431-432
 Chemical cycles, 458-460
 Chemical energy, 14, 430
 Chemistry, 7
 Chemotropism, 55, 67, 72, 131, 139, 162, 234, 257
 Chick, 116, 450, **520**, 550
 Chicken cholera, 555
 Chigger, **301**
 Child, C. M., 163
 Chimpanzee, 422, 506
 Chinch bug, 284
 Chiroptera, 411, 412
 Chitin, 98, 437, 463
 Chitons, 217-218, 513
 Chloragogue cells, **231**
 Chlorophyll, 31
 Cholera, 491
 Cholesterol, 19
 Chondrin, 98
 Chondriosomes, 30
 Chondrostei, 345
 Chorda dorsalis (see Notochord)
 Chordata, 306, 545, 547
 Chordates in general, 306-308, 437-442, 449, 462
 Chorion, 377, **418**, 419
 Choroid layer, eye, 332, **333**
 Chromatin, 29, **30**, **47**, 48
 Chromatophores, **79**, 350, 368, **369**, 382
 Chromidia, 84
 Chromosomal fibers, 48
 Chromosomes, 46-48, 107-110, 112-115, 448,
 517, 521, 527, 528, 537
 Chrysalis, 279, 471
Chrysaora hyoseella, 145
 Chyle, 461
 Chyme, 461
 Cicadas, 278, 285, 478
 Cilia, 69-71, 79, **84**, **85**, 96, **149**, **150**, 154, 157,
159, 162, 164, 166, **171**, 172, 184-186, 197,
 212, 225, **226**, 231, 233, 243, 326, 372, 437,
 466, 467
 Ciliary body, **223**, **333**
 Ciliary muscle, **333**
 Ciliata, 79
 Ciliated bands, **197**, 225, **226**
 Ciliated epithelium, 96, **97**, 437
 Circulation, 32-34, 65, 71, 138, 161, 168, 177, 196,
 212, 230, 246, 275, 276, 298, 311, 315, 324,
 340, 361, **378**, 393, **420**, 440-441, 456, 461-
 462, 465, 552
 Circulatory system, 102, 103, 183, 185, 189, 190,
 205, 212-213, 230-231, **253**, 254, 276, 297-
 298, 311, 315, 324, 339-341, 351, 360, 361,
 378-380, 393, **394**, 408, 409, 420, 440-441,
 462, 519, 544, 545
 Circumesophageal connectives, **254**
 Circumpharyngeal connectives, **233**
 Cirri, 83
 Cirripedia, 263-264, 497
 Cirrus, **160**, 161, **168**, **183**
Cistulo lutaria, skeleton, **388**
 Cladocera, 262
 Clams, 221, 226, 493
 Claspers, 338
 Classes, 58, 542
 Classification, 57-58, 541-543, 544-548
 of Cuvier, 553
 Clavicle, **319**, **321**
 Claws, 318
 Clear-winged moth, **485**
 Cleavage, 116-123, 140, 155, 162, 198, 214, 225,
 236, 258, 264, 278, 315, **355**, 356, 371, 376,
 419, 448-449
 cavity (see Blastocoel)
 planes, 118
 Cleveland, L. R., 496
 Climbing birds, 401
 Climbing perch, 358
 Clitellum, 229, **230**
 Cloaca, 179, 185, **186**, **210**, **212**, **317**, 323, 333,
 364, 366, 371, 372, 379, 389, 393, 408, 411
Clonorchis sinensis, 165, **166**

- Closed circulatory system, 441
 Clothes moth, 285, 455
 Clotting, blood, 324, 462
 Clypeus, **272**
 Cnidoblast, 136, **137**, 469
 Cnidocil, 136, **137**
 Coagulation (*see* Clotting)
 Cobras, 385
 Coccidia, 83
 Cochineal insect, 282
 Cochlea, **330**, **331**, 409
 Cockroaches, 283, 289
 Cocoon, 162, **236**, 246, 287, 298, 299, 463, 470-471
 Colling moth, 285, **286**
 Coelenterata, 143, 544, 547
 Coelenterates, *134-153*, 436, 438, 441-444, 449, 461, 462, 466, 468, 469, 495
 Coeliac artery, **339**
 Coelom, 123, 184, 185, 187, 189, 190, **193**, 195, 229-231, 246, 253, **307**, **313**, 316, **317**, **326**, 376, **377**, 408, 450, 466, 544, 545, 547
 (*See also* Extra-embryonic coelom)
 Cold sensations, 445
 Cold-bloodedness, 456
 Coleoptera, 285
 Collar, 222
 Collar cells, **127**
 Collateral, **100**
 Colloblasts, 155
 Colloidal emulsions, 12
 Colloids, 11, 12
 Colon, **322**, **519**
 Colonial hydroids, 143, **144**, 146, 147, 149, **150**, 494
 Colonies, 132, 143, **144**, 146-150, 187-189, 248, 264, 312, 313, 494
 Color, 134, 146-147, 155, 165, 206, 221, 243, 244, 260, 269, 350, 368, **369**, 382, 402
 Coloration, concealing, 485
 recognition, 486
 warning, 486
 Color-blindness, inheritance, 539
Columba livia, anatomy, **394**
 Columella, 331, 362
 Columnar epithelium, 96, **97**
 Comb, 292, 463
 Comb jellies, **154**
 Combustion, 452
 Commensalism, 495
 Commissure, 159
 Common names, 59
 Communities, animal, 479-480
 Comparative anatomy, 518, 552
 Comparative embryology, 519
 Competition, 500, 516
 Complementary genes, 535
 Complete metamorphosis, 279, 450
 Compound eye, 255-256
 Compounds, 7, 8, 19
 Comstock, J. H., 293
 Concealing coloration, 485
 Conchology, 5
 Conditioned reflexes, 468
 Conductivity, 55, 467
 Condyle, 375
 Conjugation, 74-75
 Conjunctiva, **333**
 Connective tissues, 98, **99**
 fibers, 463
 Connectives, 159
 Consciousness, 473, 475
 Conservation of energy, 15
 of mass, 15
 Continental islands, 504
 Continuity, cell life, 49
 chromatin, 49
 germ plasm, 94
 Continuous fibers, 48
 Continuous phase, 12
 Continuous stimulus, 54
 Contour feathers, **392**
 Contractile cells, 443
 Contractile fibers, 136, 137, 443
 Contractile fibril, **100**
 Contractile vacuole, **64**, 65, **70**, **79**, **85**, **86**, 440, 441, 446
 Contractility, 17, 467
 Contrast, living and nonliving matter, 16-17
 Conus arteriosus, **339**, 340
 Convergence, **446**, 543
 Coot, foot, 400
 Copepoda, 262
 Copper, 19
 Copperhead, 386
 Copulation, 162, 235-236, 257, 276, 298
 Copulatory appendages, 250-251, **253**
 Coracoid, **321**, **388**
 Coral, 143, 146, *151-152*, 513
 Coral reefs, 152, **153**
 Coral rock, 153
 Coral snakes, 385
 Coralline bryozoa, 187
 Corium, 318, 437
Coriira, **274**
 Cormorant, foot, **400**
 Corn bollworm, 285
 Corn root aphid, **284**
 Cornea, **223**, 247, **254**, **255**, 332, **333**
 Corpuscles, blood (*see* Blood corpuscles)
 Cortex, cerebral, 370, 380
 paramerium, 70
 Cosmopolitan animals, 499
 Costal plate, **388**
 Cotton worm, 285
 Coughing, 468
 Cowbird, 403
 Coxal glands, 298
 Coyote, skull, **407**
 Crabs, *260-261*, 265, 495-497
 Crane-fly, **275**
 Cranial nerves, 328
 Cranium, **319**, 320, **386**, 424-425
 Crawdads, 250
 Crawfish, 250
 Crayfish, 51, 114, *250-260*, 442, 506
 Creation of life, 25-27, 40
 Cretaceous period, 511, 515
 Crickets, 273, 283, 289

- Crinoidea, 201, 205–206, 513
 Crocodiles, 334, 380, 388–389, 495
 heart, **379**
 Crocodilia, 380, 388
 Cro-Magnon race, **424**, 425
 Crop, 230, **232**, 246, **277**, 322, 393, **394**
 Crossbill, beak, **399**
 Crossbreeding, 536
 Cross-fertilization, 106, 141, 162, 219, 246, 311
 Crossing over, 540
 Crossopterygii, 344, 362
Crotalus confluens, skull, **386**
 Crustacea, 260, 304, 305
 Crustaceans, 250–267, 437, 440, 462, 466, 480,
 494, 495, 512, 513
Cryptobranchus, 365
Cryptosaras couesi, **357**
 Crystalline cone, **255**
 Crystalline style, 221
 Crystalloids, 12
 Ctenoid scales, **347**, 348
 Ctenophora, 154, 544, 547
 Ctenophores, 154–156, 436, 438, 441, 443, 444,
 449, 450, 461, 462, 467
 Cuckoos, 403, 507
Cucumaria planici, **205**
Culex, 89, **287**
 Cultivation, modifications, 518
 Curassows, 506
 Currents, 55, 479, 500
 Cutaneous artery, 361
 Cutaneous sense organs, 328–330
 Cuticle, 69, 79, 85, **135**, 136
 (See also Skin)
 Cuticula, 98, 164, 165, 185, 229, **231**, 268, 304, **437**
 Cuttlefish, 222, 223, 438, 513
 eye, **223**
 Cutworms, 289
 Cuvier, 552, **553**
 Cuvierian organs, **205**
 Cyanogen theory, 26
 Cycles, chemical, 458–460
 food, 480
 life, 43–44, 432–433
 Cycloid scales, **347**, 348
Cyclops, **263**
 Cyclostomata, 334, 335
 Cyclostomes, 335–337
 Cynodonts, 411
Cypris, **263**
 Cypris, 497
Cypselurus, tail, **349**
 Cysticercus, 173–174
 Cystoids, 513
 Cytoplasm, 28, **30**, 48, 49, 63, 68–70, 84, 100,
 109, 110, 113, 114, 117–119
- D
- Daddy longlegs, 303
 Damsel flies, 289
Danaus archippus, **281**
Daphnia pulex, **263**
 Darwin, Charles, 237, 424, 517, **518**, 521, 529
 Darwin, Erasmus, 517
 Darwinism, 517
Dasyppus novemcinctus, **414**
 Day and night rhythms, 482
 Deafness, heredity, 536
 Dealted ant, **294**
 Dealted termite, **283**
 Death, 23, 430
 Decapods, 260
 Deep-sea fishes, **357**
 Deer, 416, 506, 507
 foot bones, **415**
 Virginia, 509
 Defective genes, 536, 537
 Degeneration, 186, 200, 312, 314, 543
 Delamination, 449
 Demospongiae, 128
 Dendrites, **100**, 101, 235
 Dendron, 101
 (See also Dendrite)
Dendrostoma alataecum, **247**
Dentulium pretiosum, **221**
 Dentine, 318, 407, **408**
 Dentition, 407
 Dermal gills (see Dermobranchiae)
 Dermal layer, 130, 436
 Dermal scales, 367, 406
 Dermis, **318**, **359**, 406, 437
 Dermobranchiae, **193**, 196
 Desert faunas, 482, 484
 Desiccation, 187
Desmognathus, 365
 Determination of sex, 537–539
 Determiners, 527
 Development, ascaris, 178–179
 butterfly, 281
 fish, 355–356
 frog, 371–374
 Gordius, 181
 hookworm, 179–180
 locust, 280
 mammal, 418–421
 mosquito, 288
 reptiles and birds, 376–378
 shrimp, 265–266
 Trichinella, 180
 tunicate, 311–312
 (See also Life history)
 Devil fish, 222, **223**
 Devonian period, 344, 362, 511, 515
 DeVries, Hugo, 522
 Diabetes, 464
 inheritance, 537
 Dialysis, 12
 Dialyzers, 12
 Diaphragm, **322**, 389, 408
Diastrophus nebulosus, gall, **286**
 Didelphia, 411
 Diecious animals, 105, 178, 186, 189, 195, 213,
 219, 225, 243, 264, 270, 315, 333, 443
 Dienecephalon, 328, **337**, **340**, **370**, 387
 Differentiation, **85**, 93, 128, 430, 432, 447, 464
Difflugia urecolata, **81**
 Diffuse nervous system, 414

- Digestion, 32-34, **42**, 65, 71, 102, 131, 138, 161, 168, 177, 196, 230, 246, 322, 323, 399, 469-461
- Digestive enzymes, 13, 65, 86, 97, 131, 138, 230, 321, 323, 439, 461
- Digestive system, 102, 103, 158, 165, 190, **195**, **204**, **205**, **210**, 212, **232**, 242, 245-246, **253**, **276**, **277**, **297**, **311**, **314**, **317**, 321-323, 339, 350-351, 393, **394**, 438-439, 544-545
(See also Alimentary canal)
- Digitigrade foot, **414**
- Dihybrids, **532**, 533
- Dimorphism, 443, 543
- Dinophilus*, 243
- Dinosaurs, 390, 397, **398**, 515
- Diphtheria, 491
- Diphycercal tail, **349**
- Diploblastic condition, 128, 142, 544, 547
- Diploblastic embryo, 121
- Diplodinium caudatum*, **85**
- Diploid number, **108**, **109**
- Dipnoi, 344, 346
- Diptera, 287, 288
- Direct response, 54, 469-470
- Disc, basal, 134-136
starfish, **191**, 192
- Discoidal cleavage, **117**, 118, 355, 356, 376, 449
- Discontinuous distribution, 499
- Discontinuous stimulus, 54, 467
- Disease, 289, 421, 487, 488, 537
- Dispersal, animals, 187, 216, 500-501
- Disperse phase, 12
- Dispersion medium, 12
- Dissimilation, **32**, **33**, 35, 37, **42**, 65, 71, 168
- Dissociation, 11
- Distribution, discontinuous, 499
geographic, 5, 499-509
past, 510-515
- Diurnal rhythms, 482
- Divergence, 446, 543
- Diving beetles, 481
- Diving birds, 401
- Division of labor, 93, 111, 292, 295, 430, 494
- Dogfish, fresh-water, 345
- Dogfish sharks, **338**, **347**
- Dogs, 58, 413, 474
- Dolichoglossus kowalevskii*, **309**
- Dolphins, 417, **446**
- Domesticated birds, 405
- Dominance, 295, 475, 530
- Dominant genes, 528, 530-532, 537
- Dormancy, 23, 430
- Dorsal aorta (see Aorta, dorsal)
- Dorsal blood vessel, **231**, **232**
- Dorsal fins, **346**, 348
- Dorsal line, **176**
- Dorsal nerve cord, **176**
- Dorsal pores, 229
- Dorsal root, **327**, **328**
- Dorsal vessels, **231**, **232**, 253
- Double circulation, 361
- Down, 392
feathers, **392**, 393
- Dragon flies, 289, 514
- Dreaming, 474
- Drones, 291, **292**, 539
- Drosophila*, 114, 521, 522, 540
- Dryophantes lanata*, gall, **286**
- Duckbill, 411, **412**
- Ducks, 401, 403-405, 500
beak, **399**
foot, **400**
- Duct, 439
- Ductless glands, 366-367, 464-465
- Dugong, 417
- Dujardin, 18, 31, 554
- Duplicate genes, 535
- Dura mater, 369
- Durant, W. J., 550
- Dwarfness, 537
- Dyad, 448
- Dysentery, 87
- Dytiscus*, leg, **274**
- E
- Ear, 339-332, 336, 341, 354, 362, 369, 379, 380, 383, 394, 395, 409-410, 445, 519
muscles, man, **519**
- Ears, planarian, 157
- Earthworm, 51, 229-240, 463
- Earwigs, 289
- Ebers, George, 549
- Ecdysis, 258
(See also Molting)
- Echinua*, 411
- Echinococcus granulosus*, 169
- Echinodermata, 200, 545, 547
- Echinoderms, 113, 191-207, 437, 438, 441, 442, 444, 462, 463, 466, 483
- Echinoidea, 201, 202
- Echinopluteus, 206
- Echiurus pallasi*, **247**
- Ecology, 5, 477-486
- Economic relations, 69, 80-83, 87-90, 132-133, 153, 156, 169-174, 178-182, 198-199, 207, 226-228, 237, 248-249, 258-259, 265, 270, 281-295, 299, 301-302, 315, 337, 342-343, 358, 374, 389, 404-405, 421
- Ectoderm, 119-123, 127, 128, 135-137, 140, **142**, 155, **184**, **193**, 307, **418**, 419, 449
- Ectoparasites, 497
- Ectoplasm, 63-65, **66**, **70**, 85
- Ectopterygoid, **386**
- Edentata, 411, 415
- Eel, 335
electric, 505
migration, 502
- Eelworm, 175
- Effectors, 163, 238, 239, 327, 468, 470
- Efferent impulse, 163
- Efferent path, 239
- Egestion, **32**, **33**, 36, 37, 41, 42, 65, 71, 102, 138, 161, 168, 177, 196
- Egg cells, 44, 45, 105-107, 109-114, 116-118, 120, 121, 132, **135**, 140, 149, 151, 161, 162, 167, 172, **173**, **178**, 198, 214, **235**, 236, 334, 419, 448, 493, 528, **530**, 532, 537-539, 554

- Eggs, 106, 107, 111, 112, 171-173, 178, 179, 181, 186-187, 189, 198, **214**, 216, 225, 246, 257, 258, 263, 264, 270, 278, **281**, 285, **287**, **288**, 290-293, 298, 311, 315, 341, **355**, 356, 365-368, 371, 375, **376**, 378, 383, 385, 389, **403**, 404, 411, 448, 483, 493, 530, 539
- Egyptians, medicine, 549
- Eimeria stiedae*, **82**
- Elasmobranchii, 334, 338
- Elasmobranchs, 338-343
- Elastic fibers, **99**
- Electric eels, 505
- Electric organs, 341
- Electric rays, 341
- Electrical energy, 37, 430
- Electrolysis, 11
- Electrolytes, 11
- Electrons, 8
- Electrotropism, 55, 72
- Elements, 8, 18
- Elephantiasis, 181
- Elephants, 417, 421, 506, 523-525
- Elephas*, 524
- Elimination, **32**, **33**, 36, 37 **42**, 65, 71, 102, 138, 159, 161, 168, 178, 196, 213, 233, 246, 298, 315, 323, 325, 399, 441-442, 465-466, 487, 488
- Elk, Irish, 523
- Elytra, 275
- Emaciation, 43
- Embryo, 106, 116, 132, 140, 149, 161, 167, 171, **173**, 178, 198, 237, 258, **355**, 356, 371, 376, 377, 419, 447-450, 519, 520
- Embryogeny, 116-123, 518
(See also Life history)
- Embryology, 5, 116, 447, 554
- Emotions, 464, 473
- Empedocles, 25, 516, 549
- Emu, 403, 506
- Emulsion, 11
- Enaema, 541
- Enamel, 98, 318, 348, 407, **408**
- Encephalon, 328
- Encystment, 68, 489
- Endocrine glands, 366-367, 387, 431, 433, 464-465
- Endoderm (see Entoderm)
- Endolymphatic duct, **330**, 331
- Endomixis, **76**, 77
- Endoparasites, 497
- Endoplasm, 63, **64**, **70**, **85**
- Endoskeleton, 316, 318, 437-438
- Endostyle, 311-314
- Endothelium, 441
- Energy, 14, 15, 37, 430, 452, 453, 464
conservation, 15
- Engine, and body, 453
- Engraver beetle, work, **285**
- Enteron, 135, 138, 142, 143-145, **158**, 165, **166**, **171**, 172, 177, 318
(See also Alimentary canal; Gastrovascular cavity)
- Enteropneusta, 547
- Enterozoa, 128
- Entoderm, 119, **120**, **122**, 123, 127, 128, 135-137, **142**, 155, 306, 307, **418**, 419, 449
- Entomology, 5
- Entomostraca, 262, 263
- Entozoic, 80
- Entropy, 15
- Enzymes, 13, 97
(See also Digestive enzymes; Ferments)
- Eocene period, 511
- Eohippus*, **525**
- Ephelota gemmipara*, **86**
- Ephydatia fluviatilis*, **129**, 132
- Ephyra, **149**, 150
- Epibole, 121, 371, **372**, 449
- Epidermis, 158, 164, 193, 210, **318**, **359**, 406, 436, 437
- Epigenesis, 554
- Epiglottis, 408
- Epigynum, 297
- Epimere, 450
- Epipharynx, **273**
- Epithelia, *96-98*, 102, 122, 123, 130, 158, 159, 161, 318, 324, 329, 369, 436, 437, 439
(See also Skin)
- Epitheliomuscular cells, 136
- Epizoid associations, 494
- Equal cleavage, **116**, 118, 140, 198, 315, 419, 448, 449
- Equatorial plate, 47
- Equilibrium, sense, 256, 331, 341, 354, 369, 395, 445
- Erect posture, 422
- Erector muscle of hair, **318**
- Esophageal pouch, **232**
- Esophagus, 195, **210**, 212, 230, **232**, **253**, 254, **277**, **322**, **336**, 350, 393, **416**
- Esor lucius*, scale, **347**
- Estivation, 374
- Ethiopian region, **505**, 506
- Ethmoidal cells, **329**
- Engenies, 540
- Euglena*, **79**
- Eunice viridis*, **249**
- Euplectella*, 129
- Eupomatus gibbosus*, mouth, **352**
- Eurosta solidaginis*, gall, **286**
- Eurypterids, 514
- Eustachian tube, 329-331, 362
- Eutheria, 411
- Evaporation, heat regulation, 456
- Evening primroses, mutation, 522
- Evolution, 5, 516-526
- Evolutionary series, 523
- Excretion, **32**, **33**, 36, 131, 138, 168, 246, 465-466
- Excretions, 36, 65, 71, 102, 133, 159, 439
- Excretory system, 102, 103, **158**, 159, **168**, 175, **176**, **186**, 189, 213, **231**, 233, 254, 298, 315, 324-327, 336, 351-352, 395, 441-442, 466, 520
- Excretory pore, **158**, **166**, **175**
- Excretory tubes, **158**, **166**
- Excretory tubule, **159**
- Exoskeleton, 318, 364, 437, 438
- Expiration, 35-37, **42**, 71, 439
(See also Respiration)
- External gills, 372, 373, 440
- Exteroceptors, 445
- Extra digits, inheritance, 537

- Extracellular digestion, 138
 Extra-embryonic coelom, **418**, 419
 Eyeball, 332
 Eyelids, 362, 364, 369, **383**, 406
 Eyes, **184**, 218, **219**, 221-225, 247, **251**, 253-256, **261**, 271-273, **276**, 277, **297**, **300**, **302**, **304**, **312**, *332-333*, 341, 353-354, 357, 362, 367, 369, 379, **382**, 385, 388, 395-396, 409, 519
 Eyespots, **79**, **157**, 162, 165, 166, **171**, 185, 186, **195**, 223, 241-243, 245, 247, **314**, 315
- F
- F₁*, *F₂*, etc., generations, 531-535
 Factors, 527
 Family, 58, 546
 Family association, 493
 Family name, 58, 546
 Fangs, snakes, **386**, 387
Fasciola hepatica, 170, **171**
 Fat tissue, 98, **99**
 Fatigue, 467
 Fats, 19, **34**, 38, 65, 86, 131, 195, 230, 318, 366, 454, 455, 461
 Fauces, 408
 Faunal divisions, 504-509
 Faunas, cave, 484
 desert, 484
 forest, 484
 fresh-water, 484
 island, 504
 marine, 482, 483, 502
 stream, 484
 terrestrial, 484, 504-509
 Fear, 473
 Feather stars, 201, 206, **207**
 Feather tracts, 393
 Feathers, 318, 390-392, **404**
 Feces, 36, **42**, 65, 171, 173, 177-179, 212, 230, 311
 Feeble-mindedness, inheritance, 536
 Feeding and sex determination, 539
 Felidae, 546
Felis, 546
 Female, 44, 89, 104, 105, 161, **178**, **179**, **186**, 213, **224**, 257, **258**, **261**, **263**, 272, **283**, 288, 291-294, **297**, 298, **317**, 325, 333, 355, 366, 395, 403, 404, 443, 448, 493, 537, 538, 539
 Femur, **272**, **319**, **321**, **388**, **391**
 Fenestra ovalis, **330**, 331
 Fenestra rotunda, **330**, 331
 Fermentation, 13, 554
 Ferments, 13, 27, 102, 464
 (*See also* Enzymes)
 Fertilization, 86, 106, *111-115*, 132, 140, 141, **149**, **150**, 162, 167, 171, 178, 189, 198, 214, 216, 235, 236, 258, 263, 278, 298, 311, 315, 334, 341, 355, 443, 493, 528
 Fetal circulation, **420**
 Fetus, 116, 450
 Fibrillar structure, protoplasm, 22
 Fibrin, 462
 Fibrinogen, 462
 Fibrous tissue, 98
 Fibula, **319**, **321**, **388**, **391**
Filaria, 181
 Filial generations (*see F₁*, *F₂*, etc.)
 Filoplumes, 393
 Fin rays, **314**, **317**, **361**
 Final host, 170
 Fingers, 396
 Fins, **185**, **222**, **313**, **314**, **317**, **346**, 348, **349**, 361, 445
 Fire and body compared, 452
 Fireflies, 278
 Fishes, 113, 308, *335-358*, 359, 360, 437, 439, 449, 463, 474, 480, 497, 502, 511, 514, 515, 520
 Fission, 67-68, 74, 86, 105, 140, 161, **248**, 493
 Fissipedia, 413
 Flagella, 78-80, 131, 466
 Flagellata, 78
 Flagellated cells, **135**
 Flagellated chambers, **130**
 Flame cells, 159, 171, 442, 456
 Flatworms, *175-174*, 438, 442-444, 449, 461, 462, 470
 Fleas, 288, 497
 Flex gliding, 398
 Flexor muscles, bird, **401**
 Flicker, foot, **400**
 Flies, **275**, **278**, 282, **287**, 288, **485**, 498
 foot, **274**
 Flight, 397-400, 413
 Flight feathers, **392**
 Flint, 83
 Fluid, 9
 Flukes, 165-166, 170-172, 174
 Fluorine, 19
 Flying dragon, 383
 Flying fish, 350
 tail, **349**
 Flying foxes, 506
 Flying spiders, 299
 Folliee mites, 302
 Food, 32-38, 41, **42**, 65, 71, 86, 131, 133, 138, 148, 156, 161, 164, 176, 177, 184, 196, 201, 203, 205, 212, 225, 226, 228, 230, 246, 250, 256, 258-259, 269, 270, 277, 282, 288, 289, 292-293, 298, 300, 311, 315, 321, 322, 352, 354, 358, 368, 373, 376, 382-384, 389, 393, 401, 404, 407, 415, 416, 430, 452, 454, 461, 488
 Food chains, 480
 Food vacuoles, *64*, 70, 71, 438, 460
 Foot, 208-211, 213, 217-221, **227**, **274**, 288, **319**, 362, 366, 382, **383**, 390-391, **400**, 401, 406, 413-415, 422, 423, 537, 545
 Foramen, 82, 190
 Foraminifera, 82, 513
 Forebrain, 328
 Foregut, 438
 Forest faunas, 484
 Fossilization, 510
 Four-o'clocks, inheritance, 535
 Fovea centralis, **333**
 Fowls, domestic, 111, 403-405, 537
 Foxes, 413, 506, 509
 Fragmentation, 105, 168
 Fraternal twins, 539
 Fresh-water faunas, 484
 Frog, 113, 334, 359, 366, 374, 441, 449, 481, 505
 Frontal sinus, **329**

- Fruit fly (*see Drosophila*)
 Fry, 356
Fungia, **162**
 Funiculus, **188**
- G**
- Galen, 550-552
 Galileo, 552
 Gall bladder, **322, 323**
 Gall flies, 287
 Gall gnats, 106
 Gall mites, 302
 Gall wasps, 287
 Galls, **286, 288**
 Gametes, 44, 86, **88, 140, 447, 531, 532**
 Gametocytes, **88**
 Gametogenesis, 107, 111, 140, 518
 Ganglia, **158, 159, 219, 239, 241, 297, 327, 444, 468**
 Ganglionic synaptic nervous system, 445
 Ganoid scales, **347, 348**
 Ganoids, 334, 344, 345, 515
 Ganoin, 348
 Gar pikes, 345
 Gars, 345
 Garter snakes, 481
 Gases, 9, 463, 503
 Gastraea, 267
 Gastral cavity, 128, **130**
 Gastral layer, 130
 Gastric gland cells, 136, 277
 Gastropoda, 217, 218, 513
Gastrostomus bairdii, **357**
 Gastrovascular cavity, 135, **142, 158, 164, 438, 544, 545**
 Gastrula, 119-123, 140, **149, 150, 198, 214, 236, 315**
 Gastrulation, 119-122, 371, 449
 Gavials, 388
 Geckos, **383**
 Geese, 403-405
 Gel, 12, **13**
 Gemmation, **86**
 Gemmules, **132**
 Gene mutations, 535
 Geneological tree (*see Phylogenetic tree*)
 Generic names, 58, 546
 Genes, 527-529, 531, 532, 534-537, 540
 Genesis, 25
 Genetics, 5, 517, 527-540, 554
 Genital atrium, **160, 161**
 Genital duct, **210, 212**
 Genital opening, **219**
 Genital pore, **157, 160, 161, 166, 168**
 Genotype, 528
 Genotypic ratio, **532, 533**
 Genus, 58, 59, 542
 Geographical distribution, 5, 499-509, 521
 Geological ages, 512
 Geological time scale, **511, 512**
 Geotropism, 55, 72, 74
 Gephyrea, 242, 246
 Germ cells, 94, 95, 107-111, 149, **171, 448, 451, 517**
 Germ layers, **120, 121, 376, 435, 544-545**
 (*See also Ectoderm; Entoderm; Mesoderm*)
 Germ plasm, 94, 451, 517
 Germinal area, **376**
 Germinal disc, **355, 356**
 Germinal epithelium, 96
 Giant fibers, 239
Giardia, 80
Giardia lamblia, **80**
 Gibbons, 422, 506
 Gila monster, 384, 389
 Gill arches, **313**
 Gill chambers, **252, 253**
 Gill filaments, 211, 351
 Gill rakers, 351
 Gill slits, **313, 317, 323, 336, 338, 352, 353, 373**
 Gills, 210-212, **252, 253, 275, 351, 361, 372, 373, 440**
 Girdles, 319
 Gizzard, 230, **232, 277, 393**
 Glacial lakes, succession, **481**
 Gland cells, **135, 136, 439**
 Glands, 439, **440, 466**
 (*See also Endocrine glands*)
 Glandular epithelium, 96, 97, 439
 Glass snake, 383
 Glenoid cavity, **321**
 Gliding, 398
 Globigerina ooze, 82
 Glochidium, **214**
 Glomerulus, **326**
 Glomus, **326**
 Glottis, 384, 408
 Glowworms, 278
 Glue cells, 155
 Glycerin, 34
 Glycogen, 323
 Gnathostomata, 335
 Goats, 416, 507
 Gobies, 354, 358
 Goblet cells, 97, **98**
 Golden plover, 403
 Goldfish, 358
 Golgi bodies, **30**
 Gonads, 106, 140, 148-150, 155, **210, 311, 313, 317, 339, 366, 465**
 Gonangia, **150, 151**
 Gordiacea, 177, 181
Gordius, 181
Gorgonia, **147**
 Gorilla, 422, 506
 Grafting, 163, 237
 Grain moth, 285
Grantia ciliata, **129**
 Granular structure, protoplasm, **22**
 Graptolites, 513
 Grassi, 90
 Gray matter, **327, 328**
 Grayfish, 343
 Great Barrier Reef, 152, **153**
 Greeks, 549
 Green glands, 252-254, 442, 466
Gregarina blattarum, **82**
Gregarina poly morpha, **82**
 Gregarines, 83
 Gregariousness, 494
 Grosbeak, beak, **399**

- Ground beetles, **274**, 289
 Ground hog, 417
 Ground squirrels, 417, 456, 509
 Groups, animal, 57
 Grouse, spruce, 509
 Growth, 16, 17, 43, 50, 65, 164
 cycles, **43**
 in plants and animals, 41
 period, 107-110
 Grub, white, 182, 279
Gryllotalpa hecatactyla, **274**
 Guanin, 350, 358, 368
 Guano, 404
 Guans, 506
 Guinea fowls, 506
 Guinea pigs, 531, 532, 534
 Gullet, **69**, 70, 79, 144
 Gulls, 401
 Gustatory cells, **329**
 Gypsy moth, 285
- II
- Habit, 198, 257, 299, 355, 371, 472-473, **475**
 Habitat, 478
 Baerckel, 40, 542
 Hag fishes, 333-335
 Hair, 53, **318**, 406, 519, 534
 Hair feathers, 393
 Hair worms, 181
 Halteres, **275**
 Hand, **319**
 Haploid number, **108**, **109**
 Hares, 414, 509
 Harvest flies, 285
 Harvestmen, 303
 Harvey, 551-554
 Haversian canals, **99**
 Hawks, 401, 481
 beak, **399**
 foot, **400**
 Hay fever, 492
 Head, 157, 218, 243, 316
 Health, 487, 488, 492
 Hearing, 277, 331, 380, 385, 395, 410, 445
 Heart, 212, 231, **232**, 252-254, 276, **297**, **311**, **312**,
 316, **317**, 324, 361, **379**, 380, 393, **394**, **409**,
 441, 552
 muscle, **100**
 Heat, 37, 430, 445, 455-457, 468
 (See also Temperature)
 Hedgehogs, 412
 skull, **407**
 Heidelberg man, 424
Heliosphaera incermis, **81**
 Heliozoa, 83
Helix pomatia, **219**
 Hellbender, 365
 Helmholtz, 26
 Helminthology, 5
 Hemichordata, 308, 309, 441, 547
 Hemimetabola, 279, **280**
 Hemiptera, 284
 Hemocoel, 254, 268, 276, 450
 Hemocyanin, 462
 Hemoglobin, 231, 316, 462
 Hemogregarine, **82**
 Hemolymph, 462
 Hemolysis, 462
 Hemophilia, inheritance, 536
 Hen, egg, **376**
 Hepatic artery, **339**
 Hepatic caeca, 195
 Hepatic portal system, **339**, 340, 364, 380, 408, **409**
 Hepatic vein, **339**
 Herbivores, 439
 Hereditary units, 95, 521, 527, 529
 (See also Genes)
 Hermaphroditism, 105
 Hermit crab, 261
 and sea anemone, 495, **496**
 Herodotus, 495
 Herons, 401
 Herpetology, 5
 Heterocercal tail, 338, **349**
 Heterometabola, 279
 Heteronomous metamerism, 51
 Heterosis, 536
 Heterozygous condition, 528, 530-532
 Hexactinellida, 128
 Hibernation, 374, 417
 Hind-brain, 328
 Hind-gut, **276**, 438
 Hinge ligament, **208-210**
 Hinge teeth, **209**
 Hippocrates, 549
 Hippopotamus, 416, 506
 Hirudinea, 242, 245
Hirudo medicinalis, **245**
 Histology, 5, 553
 History of zoology, 549, 555
 Hoatzin, 505
 Holoblastic egg cell, 118, 225, 236, 345, 371, 448,
 449
 Holometabola, 279, **281**
 Holophytic, 79
 Holostei, 344, 345
 Holothuriodea, 201, 204, 513
 Holozoic, 79
 Homing instinct, 501
Homo, 424
Homo sapiens, 425
 Homocercal tail fin, **349**, 350
 Homiothermous animals, 456
 Homolecithal egg cell, 116-119, 448
 Homology, **52**, 53, 260, 320, **321**, 445, 518, 543
 Homonomous metamerism, 51
 Homoptera, 284
 Homozygous condition, 528, 530-532
 Homunculus, 554
 Honey, 282
 Honey sac, **276**
 Honey suckers, 506
 Honey tube, **284**
 Honeybee, **276**, 282, 291-293, 539
 head, **273**
 Honeydew, 285
 Hoofs, 318
 Hooke, 31, 552, 554
 Hooks, tapeworm, **168**

- Hookworm, **179**
 Hormones, 431, 433, 452, 464, 473, 521
 Horn, 98
 Hornbills, 507
 Horned toads, 384
 Hornets, 295
 Horns, 53
 Horse, 416, 421, 474, 507, 525
 foot bones, **415**
 foreleg, **52**
 Horsehair snake, 181
 Horseshoe crab, 303
 Host, 170, 497
 House centipede, 269-270
 House fly, **288**
 foot, **274**
 Hovering, 398
 Human parasites, 169, 170, 172, 175, 179-181,
 246, 281, 283, 284, 288, 301
 Human skeleton, **319**
 Humerus, **319, 321, 361, 388, 391**
 Humidity, 501
 Hummingbirds, 397, 507
 Hundred-legged worms, **269**
 Hunger, 445, 501
 Huronian period, 511, 512
 Huxley, 517
Hyallela, 262
Hyallela dentata, 262, 500
 Hybridization, 106, 522, **531**
 Hybrids, 530, **531, 533**
 Hydatid cysts, 169
 Hydra, 111, *134-141*, 143, 151, 429, 444, 496
Hydra oligactis, 138
Hydra viridissima, **134, 141**
 Hydranths, **150**
 Hydration, 460
 Hydrochloric acid, 65, 322, 461
 Hydrogen, 18
 Hydrogen-ion concentration, 479
 Hydroids, 143, 144, 146, **150, 151**, 261, 404, 495,
 513
 Hydrophobia, 555
 Hydrozoa, 143
 Hyenas, 413
 Hygiene, 6, 492
Hyla versicolor, **367**
 Hymenoptera, 287, 291
 Hydroid arch, 375
 Hypermetamorphosis, 281, 451
 Hypodermis, **231, 437**
 Hypomere, 450
 Hypopharynx, **273**
 Hypophysis, **311, 395**
 Hypostome, 134, **135**
Hyacotherium, 525
- I
- I-beam principle, 393
 Ibex, 507
 Ice fish, 356
Icerya purchasi, **289**
 Ichneumon flies, **291**
 Ichthyology, 5
Ichthyophis, **367**
Ichthyosaurus, **446**
 Identical twins, 538
Idiacanthus ferox, **357**
 Idiosyncrasy, 489
 Iguanas, 384
 Ileum, **322, 519**
 Iliac artery, **339, 409**
 Iliac vein, **339, 409**
 Ilium, **321, 388**
 Imago, 281
 Immunity, 490-492
 Impulse, nervous, 101
 Inbreeding, 536
 Incisors, 407
 Incone and outgo, organism, 430
 Incomplete metamorphosis, 279, **280, 450**
 Incubation, 403
 Incurrent canals, 129, **130**
 Incus, **330, 331, 410**
 Independent effectors, 468, 469
 Indirect response, 56
 Individuality, 130, 432, 453, 489
 Infection, 489-492
 Infusoria, 79, 83-84, 87
 Ingestion, 32-34, 39, 65, 71, 102, 131, 138, 148,
 161, 168, 177, 196, 230, 246, 298, 311, 312,
 321, 336, 352-353, 368, 382, 384
 Inheritance, abnormalities, 536
 acquired characters, 517, 536
 disease, 488, 537
 (See also Genetics)
 Inherited immunity, 491
 Ink sac, **222**
 Inner cell mass, 419
 Inner chamber, eye, 332, **333**
 Inner ear, *330-331*, 341, 354
 Inorganic matter, 16
 Insanity, inheritance, 536
 Insect powders, 289
 Insecta, 271, 305
 Insectivora, 411, 412
 Insects, 111, 118, *271-295*, 304, 433, 440, 442,
 447, 463, 466, 473, 478, 480, 481, 499, 504,
 510, 514, 537, 539, 540, 552
 Insertion, muscle, 443
 Inspiration, **32, 33, 35, 71, 463**
 (See also Respiration)
 Instars, 279
 Instinct, 257, 299, 305, 355, 369, *470-472*, 475
 Integration, 431, 447
 Integument, 318
 (See also Skin)
 Intelligence, 299, 305, 355, 370, 371, 472-475
 Interaction of genes, 534
 Interambulaeal plates, **203**
 Intercellular differentiation, 93
 Interlamellar junctions, 211
 Intermediate hosts, 170
 Internal gills, 373
 Internal secretions, 366, 431, 464
 Internal skeleton, 307, 316
 International Commission on Zoological Nomen-
 clature, 546
 Interoceptors, 445

- Interradial septum, **195**
 Interradii, 192
 Interstitial cells, 136, 140, 442
 Intertidal fauna, **483**
 Intestinal worms, 166, 169, 175, 178-180, 497
 Intestine, **176, 210**, 212, 230, **231**, 253, 277, 317, 339, 461
 (See also Alimentary canal)
 Intracellular differentiation, **85, 93**
 Intussusception, 17
 Invagination, 119, 236, 315, 449
 Invertebrates, 117, 511
 Involuntary muscle tissue, 100
 Involuntary muscles, 321
 Iodine, 19
 Ionization, 11, 479
 Ions, 11
 Iris, **223**, 332, **333**, 468
 Irish elk, 523
 Iron, 18, 19
 Irritability, 17, 467
 Ischium, **321, 388**
Ischnochiton, **218**
 Island faunas, 504
 Islets of Langerhans, 464, 465
 Isolation, 500
 Isopods, 261, **262**
 Itch mite, **301, 302**
 Ivory, 421
- J**
- Java ape man, **424**
 Jaws, 242, 245, 335, 338, 350, 364, 384, 386-387, 406, **407**, 415, 422
 Jelly fishes, 143-145, 147, **149, 150**, 460
 Jennings, H. S., 197
 Jugular vein, **339, 409**
 Jumping mice, 417, 509
 Jungle fowl, 405
 Jurassic period, 225, 511, 513, 515
- K**
- Kallima*, **485**
 Kangaroo, 412, **413**
 Karyokinesis, 48
 Karyosome, 29, **30**
 Katabolism, 37
 Katydid, 278, 283
 Keel, sternum, 393
 Kelvin, 26
 Keratin, 98
 Keweenaw period, 511, 512
 Kidney, **210**, 213, 325, 326, 442, 466
 (See also Excretory organs; Mesonephros; Metanephros; Pronephros)
 Kinetic energy, 14, 15, 452
 (See also Heat; Light; Movement, etc.)
 King, A. F. A., 90
 King crabs, 302, 303, 514
 King of the herrings, 358
 Kingfisher, foot, **400**
 Kiwi, 504, 505
- Labial palps, **212**
 Labium, **272, 273**
 Labrum, **272, 273**
 Labyrinth, ear, 330
 Lace-winged flies, 290
 Lachrymal glands, 333, 362
 Lacunae, bone, **99, 320**
 Ladybird beetles, **289**
 Lake communities, 479
 Lamarck, 517, 542
 Lamellae, branchial, 211
 Lamellibranchiata, 221
 Lamp shells, 190
 Lamprey, 334-337, 442, 449
Lampsilis ligamentina, 214
Lampsilis lateola, 216
 Lancelet, 314
 Langerhans, islets of, 464, **465**
 Large intestine, **322, 323**
 Larvae, 116, 131, 132, **149, 150**, 172, 173, 178-181, 184, 189, 198, 206, 214, 225, 258, 263-266, 270, 278-281, **283**, 286-292, 310, 311, 315, 336, **345**, 355, 356, 367, 368, 450, **485**, 497
 Larval organs, 451
 Larval thread, **214**
 Larynx, **322, 324**, 408
Lasius niger americanus, 284
 Lateral canals, **193, 194**
 Lateral fissure, **423**
 Lateral line, **176, 346**, 353
 Lateral vein, **317, 339**
Latrodectus mactans, 299
 Laurer's canal, **166, 167**
 Laveran, 90
 Lavoisier, 452
 Leaf beetle, 285
 Leaf butterfly, **485**
 Leaf insect, **485**
 Learning, 473
 Lecithin, 19
 Leeches, 245-246, 249, 463, 498
 Leeuwenhoek, 552
 Legs, 250-253, 257, 258, 260-263, 268-270, 272-274, 281, 296, 297, 304, 316, 366, 396, **401**, 412, 422, 423, 483, 484
 (See also Limbs)
 bones, **391**
 Lemming, 502
 Lemuria, 500
 Lemurs, 415, 506
 Lens, eye, **223**, 247, 332, **333**, 362, 369
 Lepidoptera, 285, 291
Lepisosteus, tail, **349**
Lepisosteus osseus, scales, **347**
Lepisosteus tristoechus, **345**
Lepus cuniculus, brain, 410
 Lethal genes, 535
 Leucocytes, **99**, 131, 324, 490
 Lice, 283, 289, 497, 498
 Lids, eye, **333**, 369
 Life, 17, 23-27, 452
 Life cycle, 43, 432-434
 (See also Life histories)

- Life history, *Aurelia*, 149-150
 liver fluke, 171-172
 malarial parasite, 87-89
 mussel, 213-215
Obelia, 151-152
 physiological, 478
 tapeworm, 172-174
 (See also Development)
- Life zones, 507-509
- Ligaments, 98, **99**, 320
- Light, 14, 37, 55, 67, 72, 139, 162, 234, 255-256, 332, 353, 357, 430, 445, 479, 501, 503
- Light, C. F., 315
- Limbs, 316, 320, **321**, 361-364, 373, 379, 382, 384, 389, 390, 397, 411, 413, 414, 416, 422, 518, 519, 525
- Limpets, 220
- Limulus polyphemus*, **302**
- Linckia guildingii*, **198**
- Lines of growth, **208**, 209
- Lingula*, 190
- Linin, 29, **30**, **47**, 48
- Linkage, 540
- Linnaeus, 59, 541-543
- Lion, 506
- Lipoids, 19
- Lips, 406
- Liquid, 9
- Littoral fauna, **483**
- Liver, **210**, 212, **252**, 298, **313**, **317**, **322**, 323, **339**, **409**, 431
- Living conditions and disease, 488
- Lizards, 334, 379, 380, *382-384*, 389, 417, 441
- Lobate foot, **400**
- Lobe-finned ganoids, 344, **345**
- Lobsters, 260, 265
- Localization, 137
- Localized stimulus, 139
- Location, sense of, 403, 501
- Lock and key relationship, 472
- Locomotion, 54, 65-66, 71-72, 81, 139, 155, 162, 185, 194-195, 203, 209, 218, 219, 222, 224, 233, 245, 257, 348, 361-362, 384-385, 397-400, 466-467
- Locusts, 271-273, 278, **280**, 283, 501
- Loeb, J., 112
- Lophophore, 187, **188**, **190**, 544
- Lotsy, J. P., 522
- Love, 473
- Love birds, 405
- Lumbar vertebrae, **319**, 320
- Lumbricus terrestris*, 229, **230**
- Lumen, gland, 439
- Luminescence, 37, 82, 147, 278, 430
- Luminescent organs, 357, 358
- Lung books, 300
- Lung fishes, 334, 344, 346, **347**, 362, 506, 515
- Lungs, 307, **317**, **322**, 324, 360, 364, 375, 380, **394**, **408**, **409**, 440, **441**
- Lymnaea humilis*, **171**
- Lymph, 324
- Lymph glands, 324
- Lymph nodes, 324
- Lymphatic vessels, 324
- Lyre birds, 402, 506
- Macaques, 416, 506
- MacBride, E. W., 196
- Mach, E., 430
- Machine, and body, 453
- Mackerel shark, **446**
- Macrogametes, 44, 86, **88**, 89, 442
- Macrogametocytes, **88**, 89
- Macromeres, 371
- Macronucleus, **70**, 71, 74-77, **85**
- Macrospira rufus*, **413**
- Madreporite, **191**, 192, **194**, **198**, 201, 203-205, **207**
- Magellania lenticularis*, **190**
- Maggot, 279, 282
- Magnesium, 18
- Malacobdella*, 184
- Malacostraca, 260
- Malagassy region, 506
- Malaria, 87-90
- Male, 44, 89, 104, 105, 161, **175**, **179**, 186, 213, **252**, **253**, **261**, 263, 272, **283**, 288, 291-294, 298, 325, 333, 355, 366, **367**, 403, 443, 493, 537-539
- Mallard, 405
- Malleus, **330**, 331, 410
- Malpighi, 552, 554
- Malpighian tubules, 269, **276**, **277**, **297**, 442, 466
- Mammalia, 334, 406, 410
- Mammalogy, 5
- Mammals, 111, 117, 118, 121, 308, 334, **360**, *406-425*, 432, **441**, 442, 449, 456, 457, 493, 502, 504, 511, 515, 538
- Mammary glands, 318, 406, 431, 463, 519
- Mammoth, 507, 510
- Man, 114, 415, 421, *422-425*, 457, 474, 475, 511, **518**, **519**, 538
 arm, **52**
 life cycle, **43**
 (See also Human parasites)
- Manatees, 417
- Mandibles, 250, **253**, **272**, **273**, **319**, 406
- Mandibulate insects, 272, 277, 289
- Mandrills, 416
- Manganese, 19
- Mantids, **274**, 283
- Mantle, **190**, **210**, 211, **311**, 312, 545
- Mantle cavity, 211, 219
- Mantle fibers, 48
- Manubrium, **142**, 143
- Margaropus annulatus*, **301**
- Marginal canal, **142**, 143
- Marginal lappets, 144
- Marginal spines, **192**, **193**
- Marine faunas, 482, **483**
- Marine distribution, 503
- Marmosets, 505
- Marmots, 507
- Marrow, **104**, 320
- Marsh associations, 494
- Marsh wren, 481
- Marsupialia, 411
- Marsupials, 411-412, 419, 504, 521
- Marsupium, 214, 412
- Marten, pine, 509

- Mass, 7, 15
 conservation, **15**
 Mast, S. O., 65
 Mast cell, **99**
 Mastax, **186**
 Mastication, 468
 Mastigophora, 78, 79, **80**, 87
 Mating, 493
 Matter, 7-13
 living and non-living, 16-17
 Maturation, egg cell, **109**, 110
 Maturation period, 107-110
 Maturity, **43**, 432, 433
 Maxillae, 250, **272**, **273**, **386**, 466
 Maxillipeds, 250, **252**, 269
 Meadow nice, 481
Meandrina meandrites, **152**
Meandrina sinuosa, **152**
 Mechanical energy, 37, 38, 430
 Mechanism, 24
 Medicinal leech, **245**, 249
 Medicine, 6, 492, 549, 554
 Medulla, 328, **337**, **340**, 368-370, **381**, **395**, **410**,
 423
 Medullary groove, 371, **372**
 Medullary sheath, **100**
 Medullary tube, **307**, 372
 Medusae, 142-145, 147-150
 Megalops, 264
Megarhysa lunator, **291**
 Meiosis, **108**, **109**
Melanoplus femur-rubrum, **280**
 Membrane of Reissner, **331**
 Membrane bones, 319
 Membranellae, **85**
 Membranes, 11, 12
 basement, **97**, **254**, **255**, 437
 cell, 28, 69
 nuclear, 29, **30**, 46-48
 plasma, 28, **30**
 semipermeable, 12, 21, 28
 undulating, 71
 vestibular, **331**
 Membranous labyrinth, 330
 Memory, 464, 469
 Mendel, **529**, 533, 554
 Mendelism, 529
 Meridional canals, **154**, 155
 Meroblastic egg cells, 118, 375, 376, 419, 449
 Merriam, C. H., 507
 Mesencephalon, 328
 Mesenchyme, 98, **120**, **436**, 441, 450
 Mesenchyme cells, **184**
 Mesenteric artery, **339**, **409**
 Mesenteric vein, **409**
 Mesenteries, 144, 145-146, **317**
 Mesoderm, **120**, **122**, 123, 127, 128, 146, 155, 157,
 164, 307, **418**, 419, 449-450
 Mesodermal pouches, 450
 Mesoglea, **135**, 136, **142**, 438
 Mesomere, 450
 Mesonephric duct, **317**, **325**, **326**
 Mesonephric tubules, **325**, **326**
 Mesonephros, **317**, **325**, 326, 341, 351, 364, 442
 Mesonotum, 271
 Mesopterygium, **361**
 Mesosoma, 299, **300**
 Mesothelium, 120, 450
 Mesothorax, 271, **272**
 Mesozoic era, 511, 513, 515
 Metabolic gradient, 163, 237
 water, 455
 Metabolism, 16, 17, 21, 32-39, 40, 41, **42**, 65, 71,
 131, 138, 148, 161, 167-168, 177-178, 196,
 212, 225, 230, 245-246, 298, 455, 460-466,
 487, 488, 518
 Metacarpals, **319**, **321**, **391**
 Metagenesis, 106, 150-151, 174, 313
 Metals, 8
 Metameres, 51, 229, **230**, **232**, **233**, 237, 241, 243,
 245, 246, 250, **251**, **252**, 268, 269, 271, **272**,
 273, 307, 325-326, 545
 Metamerism, 51, 241, 304, 308, 366, 545, 547
 Metamorphism, 512
 Metamorphosis, **171**, 172, 198, 206, 264, 265-267,
 278-279, **280**, **281**, 286-290, **292**, 312, 313,
 314, 337, 356, 373-374, 450
 Metanephric tubules, **325**, **326**
 Metanephridium, 442
 Metanephros, 326, 375, 442
 Metanotum, 271
 Metaphase, **47**, 48
 Metaplast, **30**
 Metapleural folds, **313**, 314
 Metapterygium, **361**
 Metasoma, 299, **300**
 Metatarsals, **319**, **321**, **391**
 Metathorax, 271, **272**
 Metazoa, 40, 78, 93-95, 105-106, 127, 128, 435,
 440, 442, 449, 466, 488
 Metencephalon, 328
 Meteoritic theory, 26
Metridium dianthus, 145
 Mice, 414
 Microgametes, 44, 86, **88**, 89, 442
 Microgametocytes, **88**, 89
 Micromeres, 371
 Micronucleus, **70**, 71, 74, 75-77, **85**
 Micropyle, 448
 Microscope, 552
 Microscopists, 552
 Mid-brain, 328, 369
 Middle ear, 330, 331, 362, 364
 Middle layer, 130
 Midges, 106
 Mid-gut, 438
 Migration, 264, 354, 402-403, 501-502
 Milk dentition, 407
 Milk glands (*see* Mammary glands)
Millipora, **151**
 Millipedes, **270**
 Milt, 355
 Mimiery, **485**, 486
 Mind, 475
 Minks, 413
 Miracidium, **171**, 172
 Mites, 300-302, 497
 Mitochondria, **30**
 Mitosis, 46-50, 518
 Mixtures, 10

- Moas, 505
 Modification of types, 501
 under cultivation, 518
Moerithrium, 523, **524**
 Molars, 407, **524**, 525
 Mole cricket, **274**
 Molecule, 7
 Moles, 412, 481
 Mollusca, 208, 217, 545, 547
 Molluscoidea, 189
 Mollusks, 113, 208-228, 437, 440-442, 449, 462, 466, 481, 494, 513
 Molting, 179, 258, 279, 385, 402
 Monarch butterfly, **281**, 502
 Monaxon spicules, 130, **131**
 Monocious animals, 105, 155, 162, 189, 219, 225, 235, 246, 264, 310, 311, 333, 442
 Mongolian type, 425
Monhystera sentiens, **178**
 Monitors, 384
 Monkeys, 415, 506
 Monoblastic embryo, 120
 Monodelphia, 411
 Monohybrid, **531**, 533
 Monotremata, 410, 411
 Monotremes, 408, 411, 419, 457, 506
 Moose, 509
 Morgan, T. H., 540
 Morphological differentiation, 93
 Morphology, 4
 Morula, 119, **120**, 121, **418**, 449
 Mosaic image, 255
 Mosaic theory of creation, 25
 Mosquitoes, 89, 90, 181, **287**, 288, 498
 proboscis, **273**
 Moss animals, 187
 Mother-of-pearl, 210
 Moths, 273, 285, 537
 Motion, 54
 Motor end plate, **100**
 Motor fibers, **327**
 Motor functions, 466-467
 Mountain, faunal zones, 502-503
 Mountain goat, 507
 Mouse, northern jumping, 509
 Mouth, 69, **70**, **79**, 134, **135**, 142, 144, 145, **157**, **158**, 175, **178**, **179**, **183**, **185**, **186**, **188**, **190**, **192**, **195**, 196, 201, 202-204, **207**, **210**, **212**, **218**, **219**, **222**, **226**, 229, **232**, **233**, **241**, 243, 245, **253**, 269, 272-273, **297**, 298, **309**, **310**, **312**, 314, **317**, 321, 335, **336**, 338, 342, 350, **352**, 353, 357, 367, 368, 379, 384, 438
 Movement, 41, 466
 Mucous canals, 341
 Mucous glands, 318, 321, **359**
 secretion, 321, 335, 439, 463
 Mud flat faunas, 483
 Mud puppy, 364, **365**
 Mulattoes, 535
 Mules, 536
 Müller, Johannes, 553
 Multiple hybrid, 533
 Multiplication period, 107-110
Murex, eye, **223**
Musa domestica, **288**
 Muscle cells, **29**, 99, **100**, **176**, **177**, 435, 443
 Muscle contraction, 467
 Muscle fibers, 193
 Muscle tissue, 99, **100**, 159, 321, 443
 Muscles, 103, **104**, **182**, **186**, **188** 203-205, **209**, **210**, 213, **231**, 233, **239**, **252**, 343, 401, 443, 467
 ear, **519**
 eye, **333**
 Muscular coordination, 395
 Muscular energy, 454
 Muscular movement, 467
 Muscular system, 320-321, **443**
 Musk, 421
 ox, 509
 Muskrats, 481
 Mussels, 208-216, 221, 228
 Mutant, 534
 Mutation, 522, 534
 Mutualism, 495
 Muzzle, 406
 Myelencephalon, 328
 Myonemes, **85**, 443
Myrianiida, **248**
 Myriapoda, 269, 304, 305
 Myriapods, 269-270, 442, **514**
Myrmelcon, **290**
 Mysis, 265, 266
Mysis, 266
 Myxinoidea, 335
 Myxinioids, 335-336, 442

N

 Nacre, 210
 Naiad, 279
 Nails, 318
 Naked snails, 220
 Nares, **329**
 Nasal chamber, **322**
 Natural classification, 57
 Natural immunity, 490
 Natural selection, 516, 517, 521, 522
 Nauplius, **265**, **266**, **497**
 Nausea, 445
 Nautiloids, fossil, 513
 Nautiluses, 217
 types, 224
 Neanderthal man, **424**, 425
 Nearctic region, **504**, 507
Necator americanus, **179**
 Necessity, 517, 521
 Neck, 218, 316, 379, 390
 Nectar, 292
Necturus, 364
Necturus maculosus, **365**
 lung, **441**
 Negative response, **55**
 Negroid type, 425
 Nekton, 483
 Nemas, 177
 Nemathelminthes, 175, 177, 544, 547
 Nemathelminths, 175-182, 438, 442, 461
 Nematocysts, 135-137, 146, 148, 544
 Nematoda, 177

- Nematodes, free-living, 177, **178**, 467
 Nemertinea, 183, 544, 547
 Nemertines, 183-184, 437, 441, 442, 467
 Neornithes, 376
 Neoteny, 374
 Neotropical region, **504**, 506
 Nephridia, **190**, **231**, **232**, 268, **313**, 315, 442, 466
 Nephridiopore, **231**, **232**, **245**
 Nephros, 442
 Nephrostome, **231**, **232**, **326**
Nereis, 243
Nereis virens, **242**
 Nerve, 104, **158**, 159
 cells, **29**, **100**, 101, 136, 137, 444
 center, **166**
 cord, **122**, **158**, **193**, 197, **304**, 312-315, 377
 endings, **318**
 fibers, **100**, 101, 136
 net, **138**, 436, **444**, 468, 470
 ring, **178**, **179**, 197
 Nerves, **313**
 Nervous activities, 238, 467
 Nervous impulse, 101, 238
 Nervous stimulus, 238
 Nervous system, 56, 103, 104, 158-160, 167, 175-176, 184, 186, 189, 197, 213, 218-220, 222, 225, 233-234, **254**, 276-278, 298, 304, 307, 311, 312, 327-328, 341, 352, 368-369, 380, 395, 408-409, 443-445, 467-468, 472, 544, 545
 Nervous tissues, 101, 121
 Nervures, 274
 Nests, birds, 403, 475
 Neural arch, **317**
 Neural groove, **355**, 356, **418**
 Neural tube, **317**, 356, 372
 Neurilemma, **100**
 Neurocoel, 307
 (See also Neural tube)
 Neuroglia, 435
 Neuromotor center, **85**
 Neuromuscular cells, 131, 443
 Neuromuscular mechanism, 136
 Neurons, 238, 444
 Neuroptera, 290
 Newts, 364-366
 Nictitating membrane, 369, 396, 409, 519
 Nidicolae, 404
 Nidifugae, 404
 Night blindness, 537
 Nighthawk, beak, **399**
 Nitrogen, 18
 cycle, 458, **459**
Noctiluca, 81
Noctiluca scintillans, **80**
 Nomenclature, 58-59, 543, 546
 Nonmetals, 8
 Nostrils, 364, 379, **383**
 Notochord (chorda), **122**, 306, 310, **312** **314**, 316, **317**, 336, **372**, **377**, 438, 545
 Nuclear membrane, 29, **30**
 Nuclear sap, **30**
 Nucleolus, 29, 30
 Nucleoplasm, 28
 Nucleus, 29, **30**, 31, 46, **47**, **64**, **79**, **84**, **86**, **100**, **112**, **113**, 116-119, 127
 Nudibranchs, 221
 Nurse cells, 111, 162, 237
 Nymphs, 279

O

 Oarfish, 358
Ophelia, **150**
 Obstretical frog, 366
 Oceanic distribution, 503
 Ocelli, **272**, **273**, 277
 Octopus, 217, 222, **223**, 225
Oculina, **152**
 Odonata, 289
 Oecium, **188**, 189
 Oil, 421
 gland, 98, 318, 400, 439
 (See also Sebaceous gland)
 Old age, 433
 Olfactory bulb, **340**, **410**
 Olfactory cells, 149
 Olfactory lobes, 328, **337**, **340**, 341, **351**, 368-370, **381**, **395**, 409
 Olfactory membrane, **329**, 410
 Olfactory organ, 222, 272, 277, **329**, 333
 Olfactory sac, **336**, 341, 353
 Olfactory tentacles, 218, **219**
 Olfactory tract, **340**
 Oligochaeta, 243
 Oligochaets, 229-240, 243, 244
 Omasum, **416**
 Ommatidium, **254**, **255**
Oniscus asellus, **262**
 Ontogeny, 116, 267
 Onychophora, 268-269, 304, 305
 Oocyst, **88**
 Oocytes, 107, **109**, 110, **530**, **538**
 Oogenesis, 107, **109**, 110
 Oogonium, 107, **109**
 Ookinete, **88**
Opalina, 83
Opalina ranarum, **84**
 Operculum, 220, 244, 344, **346**, 351, **352**, 373
Ophioderma, **202**
 Ophiopluteus, 206
 Ophiuroidea, 201-202
 (See also Brittle stars)
 Opossums, 505, 509
 Optic lobes, 328, **337**, **340**, 341, **351**, 368, **370**, **381**, **395**, 409
 Optic nerves, **223**, **254**, 255, **333**
 Optic tract, 395
 Optimum, 55, 79
 Oral funnel, **310**, **311**
 Oral groove, 69, **70**
 Oral hood, **314**, 315
 Oral ring, **314**
 Oral sucker, **166**, **373**
 Oral tentacles, **205**
 Oral valves, **352**
 Orang-utan, 422, 506
 Order, 58
 Ordovician period, 511-514
 Organelles, 85, 435
 Organic matter, 16

- Organismal concept, 434
 Organisms, 16, 429, 434
 Organization, 16, 20, 22, 23, 27, 164
 Organogeny, 120, 121, 450
 Organs, 102-104, 120, 121, 158-161, 164, 435, 436
 Organs of Corti, **331**
 Oriental region, **505**, 506
 Origin, muscle, 443
 Orioles, 403
 Ornithology, 5
Ornithomimus, **398**
Ornithorhynchus anatinus, 412
 Orthogenesis, 522
 Orthoptera, 283
 Osborn, H. F., 26, 27
 Oscula, 128-130
 Osmosis, 12
 Osmotic pressure, 12
 Osphradium, 213
 Ossicles, 193, 203, 332
 (See also Ear, 410)
 Ostia, 128-130, 144, **145**
 Ostracoda, 262
 Ostracoderms, **514**
 Ostriches, 396, 403, 404, 506
 foot, **400**
 Otocyst, 312
 Otter, 413
 Outer chamber, eye, 332, **333**
 Outer ear, 330, 331-332, 380, 409
 Ovary, 135, 140, **160**, 161, 166-168, **176**, **235**, **297**,
317, **325**, 430, 432, 442, 465
 Oviduct, **160**, 161, **167**, **235**, **297**, **317**, **325**
 Oviparity, 106
 Oviposition, **280**
 Ovipositor, **272**
 Ovum, **29**, 107
 Owen, 553
 Owls, 401
 burrowing, 509
 Ox, foot bones, **415**
 musk, 509
 Oxidases, 452
 Oxidations in body, 38, 452, 457
 Oxygen, 18, 430, 452, 463
 cycle, 460
 Oxyhemoglobin, 231, 324, 463
 Oyster drill, 225
 Oysters, 221, 226
- P
- P* generation, 531, **532**, **535**
 Paddle plates, **154**, 544
 Pain, 445, 473, 474
 receptors, 328
 spots, 445
 Paired characters, 528
 Paired units, 529
Palaeomastodon, **524**
 Palate, 329
 hard, 408
 soft, 322, 408
 Palatine bone, **386**
 Palearctic region, 505-507
 Paleontology, 510
 Paleozoic era, 511, 513, 514
 Paleozoology, 5, 510-515, 520
 Pallial line, **209**, 210
 Pallium, 210
 Palolo, **249**
 Palpi, insects, **272**, **273**
 Palps, **210**, **212**, **242**, **243**
 Pancreas, 97, **98**, **317**, 323, **339**, 431, 464
 Paper nautilus, **224**
 Paralysis, 537
 Paramecium, 69-77, 83
Paramecium aurilia, 77
Paramecium caudatum, 69, **70**, 76, 77
 Parapodia, **242**, 243, 248, 545
 Parasites, 170, 174, 478, 496
 (See also Human parasites, and individual types)
 Parasitism, 166, 167, 170-174, 357, 496-498
 Parasitology, 5
 Parathyroids, 464, **465**
 Parazoa, 128
Parelephas, **524**
 Parenchyma, 158
 Parental generation (see *P* generation)
 Parker, G. H., 329
 Parotoid gland, 366
 Parrakeets, 405
 Parrots, 405
 Parthenogenesis, 105, 263, 285, 443, 539
 artificial, 112-113
 Parthenogonidia, 86
 Partial cleavage, **117**, 118
 Partial pressures, law, 463
 Pasteur, 26, 83, 554, **555**
 Pasteurization, 554
 Patella, **319**, **391**
Patella, eyespot, **223**
 trochophore, **226**
 Pathogenic protozoans, 87
 Pathology, 5
 Pavement epithelium, 96, **97**
 Pea fowls, 402, 405
 Pear leaf blister mite, 302
 Pearl button industry, 226
 Pearl essence, 358
 Pearls, 228, 358
 Pearly nautilus, 224
 Peas, Mendel's work, **533**
 Peat bog fossils, 510
 Pébrine, 83, 554
 Pecten, 395
 Pectine, **300**
 Pectoral arch, **361**
 Pectoral fins, 316, 338, **346**, 348, **361**
 Pectoral girdle, 320, 423
 Pedal ganglion, **210**, 213
 Pedicellariae, 192, **193**, 197, 203
 Pedipalpus, **296**, **297**, **300**
 Pedogenesis, 106, 172, 374
 Peduncle, 190, 296, 544
 Pelagic fauna, **483**
 Pelecypoda, 217, 221, 513
 Pelican, beak, **399**
 Pellicle, 69, **70**, 436
 Pelvic fins, 316, 338, 345, **346**, 348
 Pelvic girdle, 320, 344, 350

- Pelvic region, 316
 Pelvis, 319-321, 423
 Pen, squid, **222**
Penaeus, 265, 266
Penaeus semisulcatus, **266**
 Penguins, 401
 Penis, 160, 161
Pennaria, **144**
 Pennsylvanian period, 511, 514, 515
 Pepsin, 322, 461, 464
 Pepsinogen, 464
 Peptones, 323
Perca flavescens, **346**
 scale, **347**
 Perch, **346**
 climbing, 358
 scale, **347**
 Perching birds, 401
 Perching mechanism, **401**
 Perennibranchs, 364
 Peribranchial vesicle, **312**
 Pericardial cavity, **210**, 212, **297**, **317**, 408
 Pericardial glands, 466
 Pericardial sinus, 254
 Pericardium, 252
 Perioral membrane, 192
 Periosteum, 104, 320
 Periostacrum, **209**, 210
Peripatus, **268**, 499
 Peripheral nervous system, 233, 327
 Perisarc, 436
 Perissodactyla, 416
 Peristalsis, 231, 461
 Peristomal tentacles, **242**
 Peristome, 69, 192
 Peristomium, **242**, 243
 Peritoneum, **193**, 195, 230, **317**
 Permian period, 511, 515
 Personality, 453
 Perspiration, 439, 456, 463
 Petrification, 510
Petromyzon marinus, **335**
 Petromyzontia, 335
 Pfleger, 26
 Phagocytes, 490
 Phalangers, 412
 Phalanges, **321**, **391**
 Phalarope, 404
 Pharyngeal clefts, 440
 Pharyngeal slits, 306, 308, **311**, **313**, **314**, **372**, 440,
 520, 545
 Pharynx, **158**, **166**, 230, **232**, **233**, **276**, 277, 311-
 314, **317**, **322**
 Pheasants, 402, 507
 ring-necked, beak, **399**
 foot, **400**
Pheidole instabilis, **294**
 Phenotype, 528
 Phenotypic ratios, **532**, 533
Philodina roseola, **186**
 Phosphorus, 18, 19
 cycle, 460
Photostomias guernei, **357**
 Photosynthesis, 41, 42
 Phototropism, **55**, 67, 139, 234, 360
 Phyla, 58, 542, 546, 547
 table, 544-545
Phyllium, **485**
 Phylogenetic series, 516
 Phylogenetic tree, 517, 542, 546, **547**
 Phylogeny, 267
Physalia pelagica, **148**
 Physical environment, 488
 Physical factors, 479
 Physics, 7
 Physiological differentiation, 93
 Physiological life histories, 478
 Physiological state, 56, 74, 140, 163, 234, 471, 473
 Physiology, 4, 5, 553-554
 Pia mater, 369
 Pig, embryo, **520**
 foot bones, **415**
 Pigeons, 405
 anatomy, 394
 limb skeletons, 391
 Pigment cells, 350, **359**
 (See also Chromatophores and Eyespots)
 Pigment layer, eye, 332, **333**
 Pigment spots, 149, 197, **314**
 Pike, scale, **347**
 Pilidium, **184**
 Pill bugs, 262
 Piltown man, 424
 Pincer, 250
 Pine marten, 509
 Pineal body, eye, or gland, **337**, **340**, **351**, **370**, 387
 Pinna, **330**, 406
 Pinnipedia, 414
 Pisces, 334, 344
 (See also Fishes)
 Pit vipers, 386
Pithecanthropus, **424**
 Pituitary body or gland, **395**, 464, **465**
Pituophis sayi, head, **383**
 Place of origin, 500
 Placenta, 412, 418-421
 Placoid scale, 338, 339, **347**, 348
Planaria maculata, **157**
 Planarians, 157-165, 450, 463, 466
 Planes of metabolism, 455
 Plankton, 352, 478, 483
 Plant lice, 105, **284**, 285, 463
 Plantigrade foot, **414**
 Plants, compared with animals, 40
 contrasted with animals, 41
 relations to animals, 477
 Planula, **149**, **150**
 Plasma, 231, 324
 membrane, 28, **30**
 Plasmagel, 65, **66**
 Plasmalemma, 63, 65, **66**
 Plasmasol, **66**
Plasmodium, 90
Plasmodium vivax, 90
 Plasmosome, 29, **30**
 Plastids, **30**, 31
 Plastron, **388**, 389
 Platyhelminthes, 164, 544, 547
 Platyhelminths (see Flatworms)

- Pleasure, 473, 474
Plestiodon septentrionalis, head, **383**
 Pleural cavity, 408
Pleurobrachia baehcki, **154**
 Pliny, 550
 Ploughshare bone, 390
 Plover, and crocodile, **495**
 golden, 403
 Plumage, 401
Plumatella, **188**, 189
Plumatella repens, **188**
 Pneuma, 552, 553
 Pocket mice, 417
Podophrya, **84**
 Poikilothermous animals, 456
 Poison claws, 269, **300**
 Poison glands, **297**, 387
 Polar bear, 509
 Polar bodies, **109**, 110, **112**, **113**, 418
 Polarity, 117, 238, 468
 Poles, egg cell, 118, 371
 Polian vesicles, **194**, **196**, **205**
Polistotrema stouti, **335**
 Pollen, 292
 Polyandry, 403, 493
 Polyaxon spicules, 130, **131**
Polyelis, 165
 Polychaeta, 243
 Polygamy, 403, 493
Polygordius, **241**, 242
 Polymorphism, 147, **148**, **150**, 292-295, 431, 543
 Polyps, 142-148, **150**, 151
Polypterus, 344
Polypterus senegalus, **345**
Polyppus bimaculatus, **223**
 Pond communities, 479
 Porcupines, 414
 Porifera, 127, 545, 546, 547
 (See also Sponges)
Porospora, 84
 Porpoises, 417
 Portal systems, 340
 Portal vein, **409**
 Portuguese man-of-war, 143, **148**, 431
 Position, organs of, 445
 Positive response, **55**
 Postembryonic development, 450
 Posterior chamber, eye, 332, **333**
 Potassium, 18
 Potato beetle, 285
 Potential energy, 14, 37, 430, 452, 453
 Potential immortality, 452
 Prairie chicken, 509
 Prairie dogs, 507
 Precaval vein, **339**
 Precocial young, 404
 Predatism, 498
 Preformation theory, 552, 554
 Pressure sensations, 445
Priapulys caudatus, **247**
 Primates, 411, 415
 Primordial germ cells, 107-110, 447
 Priority, 59, 546
 Prismatic layer, 210
 Proboscidea, 417
 Proboscis, **157**, **158**, **182**, **183**, 273, 523, **524**, 544
 Proceracoid, **388**
 Proctodeum, 371, 372, 438
 Proglottid, 165, 166, **168**
 Pronephric duct, **317**, 325, 326
 Pronephric tubules, **325**, **326**
 Pronephros, **325**, 326, 336, 442
 Pronghorn, 509
 Pronotum, 271
 Pronuclei, **112**, **113**
 Prophase, **47**, 48
 Proprioceptors, 445
 Propterygium, **361**
 Prosoma, 299, **300**
 Prostate gland, **160**, 161, **182**
 Prostonium, 229, **230**, **232**, **242**, 243
 Protective epithelium, 96
 Prote-tive resemblance, **485**, 486
 Proteins, 19, **34**, 38, 454
Proterospongia, 80, 127
Proterospongia haeckeli, **80**
 Proterozoic era, 511, 512, 513
 Prothorax, **271**, **272**
 Protista, 40
 Protocerebral tail, **349**
 Protonephridium, **241**, 242
 Protons, 8
 Protoplasm, 16, 18-23, 28, 40, 84, 429, 518
Protopterus, tail, **349**
Protopterus annectens, **347**
 Prototheria, 410
 Protozoa, 78, 545, 547
 Protozoaea, 265, **266**
 Protozoans (in general), 40, 63-90, 433-443, 460,
 461, 466, 467, 469, 480, 487, 488, 494, 496,
 497, 513, 552
 Protozoology, 5
 Protracheata, 305
Protylopus, 525
 Proventriculus, 230, **277**, 393
 Psalterium, **416**
 Pseudopodia, 63-66, 78
 Pseudopodiospores, 68
 Pseudoscorpions, **302**, 303
 Psychology, 5
 Pterodactyls, 397, 515
 Pterygium, **361**
 Pterygoid, **386**
Ptilosarcus quadrangularis, **147**
 Ptyalin, 321
 Pubis, **321**, **388**
 Pulmonary artery, **360**, 361, **379**, **409**
 Pulmonary chamber, 219
 Pulmonary vein, **409**
 Pulp cavity, 407, **408**
 Pulsating vacuoles, **64**
 Pulvillus, 274
 Pupa, 279, **281**, 286-289, **292**
 Pupil, eye, 332, **333**
 Purkinje, 18
 Pus cells, 490
 Pygostyle, 390
 Pyloric caeca, **193**, **195**, 350
 Pyloric opening, **322**
 Pyloric sac, 195

- Pyloric valve, 323
 Pylorus, **195**, 461
 Pyorrhoea, 87
 Python, 385
Pyura aurantium, **310**
- Q
- Quadrate bone, 375, **386**, 410
 Quadrinomial, 543
 Queen ant, 295
 Queen bees, 291-293
 Queen termite, **283**
 Quill, 391, **392**
- R
- Rabbit, 414, 509
 brain, 410
 embryo, 520
 Rabies, 491, 554
 Raccoon, 413, 417
 Races, 58, 543
 Racial immunity, 490
 Radial canal, 129, **130**, **142**, 144, 193, 195
 Radial nerve cord, **193**
 Radial septum, **146**
 Radial symmetry, 51, 544, 545, 547
 Radiata, 200
 Radiations, 535
 Radii, 192
 Radiolaria, 83, 512, 513
 Radiolarian ooze, 83
 Radius, **319**, **321**, **361**, **388**, **391**
 Radula, 219, 222, 225
Raja erinacea, 342
Rana pipiens, **373**
 Range, 499
 Rat, 414, 421, 504
 pouched, 507
 Rattlesnakes, 386
 skull, **386**
 Ray, 542
 Rays, 334, 339, 341
 echinoderms, 191-196, **198**, 201, **202**, 205
 Reactions, 17, 21, 66-67, 72-73, 174, 311
 (See also Responses)
 Reactiveness, 17
 Reasoning, 474
 Recapitulation, law, 266
 Recent advances, 555
 Receptor-effector mechanism, 468
 Receptor-effector-adjustor mechanism, 468
 Receptors, 163, 238, **239**, **327**, 328, 444, 468, 470
 Recessiveness, 528, **531**, **532**, 536
 Recognition colors, 486
 Rectal caeca, **195**
 Rectal glands, **276**
 Rectum, **322**, 323
 Red blood corpuscles, **29**, 316, 324, 552
 Red gland, 349
 Red spider, 302
 Red-winged blackbird, 481
 Redi, 25, 554
 Rediae, **171**, 172
 Reduction, 108-110, 114, 448, 528
 division, **108**, **109**
 Reese, 265
 Reflex act, 163, **239**, 444
 Reflex action, 163, 238-240
 Reflex arc, **239**, **327**, 328, 444, 468
 Reflex centers, 468
 Regeneration, 141, 163, 184, **198**, 202, 205, 226,
 237, 248, 258, 281, 374, 382, 383
 Remora, 495
Remora remora, **495**
 Renal artery, **339**
 Renal-portal system, **339**, 340, 361, 380, 395
 Renal vein, **339**
 Rennin, 322
 Reproduction, 17, 44-45, 67-68, 74, 103, 105-123,
 132, 140, 141, 149-151, 161-162, 168, 170-
 174, 178-181, 186-187, 189, 198, 206, 213-
 215, 219, 225-226, 235-236, 246, 248,
 257-258, 263, 264, 270, 278-281, 298, 311-
 315, 333-334, 341, 355-356, 367, 368, 371-
 378, 383, 385, 389, 403-404, 411, 419-421,
 442-443, 447-451, 453, 493
 (See also Asexual and Sexual reproduction)
 Reproductive epithelium, 96
 Reproductive system, 160-161, 235, 333-334, 395
 (See also Reproduction)
 Reptiles, 308, 375-389, 511, 515
 Reptilia, 334, 379
 Reservoir, **79**
 Respiration, 11, 35-37, 41, **42**, 65, 71, 102, 131,
 138, 161, 196, 203, 204, 211, 219, 220, 231,
 246, 275, 276, 288, 300, 311, 323, **352**, 353,
 360, 377-378, 384, 389, 420, 439-440, 462-
 463, 468, 487
 (See also Respiratory system)
 Respiratory system, 276, 298, 323, 351, 408, 439-
 440, **441**
 (See also Respiration)
 Respiratory tree, **204**, **205**
 Responses, 54-56, 131, 139, 149, 162, 197, 206,
 234, 257, 264, 467
 (See also Reactions)
 Resting cell, **47**
 Resurrection bone, 551
 Reticular nervous system, 441
 Reticular structure of protoplasm, **22**
Reticulitermes flavipes, **283**
 Reticulum, 416
 Retina, **223**, 247
 (See also Eye)
 Retinal layer, 332, **333**
 Retinula, **255**
 Retrogression, 200, 313, 543, 545, 547
 Reversibility, 13
 Rhabdites, 164, 165
 Rhabdom, **255**
Rhabdophaga strobiloides, gall, **286**
 Rhagon canal system, **130**
 Rhea, 505
 Rheotropism, 55, 72
 Rhinoceroses, 416, 506, 507
Rhizocerinus lofotensis, **206**
 Rhizopoda, 78, 466
 (See also Sarcodina)

- Rhizostoma pulmo*, **145**
Rhodites rosae, gall, **286**
 Rhynchocephalia, **380, 387**
 Rhythmicity, **74, 454**
 Rhythms, **482**
 Ribs, **317-320, 406, 551**
 Ring canal, **194, 205**
 Rodentia, **411, 414**
 Rodents, **421**
Rodolia cardinalis, **289**
 Rods, **247**
 Roe, **355**
 Ross, Ronald, **90**
 Rostellum, **166, 168**
 Rostrum, **250, 251, 253**
Rotalia freyeri, **81**
 Rotifera, **185, 544, 547**
 Rotifers, **105, 185-187, 442, 443, 467, 480, 539, 552**
 Roundmouths, **334**
 Roundworms (see Nematelminths)
 Routine, **492**
 Royal jelly, **293**
 Rudimentary organs, **516**
 Rumens, **416**
 Ruminants, **416, 421**
 stomach, **416**
 Running birds, **401**
 Running insects, **273**
- S
- Sabellids, **243, 244**
 Saber-toothed tiger, **522, 523**
Sacculina, **497**
 Sacculus, **330, 331**
 Sacral vertebrae, **320**
 Sacrum, **319, 519**
Sagitta, **185, 447**
Sagitta hexaptera, **185**
 Salamanders, **114, 334, 359, 364, 365, 368**
 embryo, **520**
 Salientia, **364, 366**
 Salinity, **503**
 Saliva, **321**
 Salivary glands, **97, 98, 321, 468**
 Salmon, **355, 356, 502**
 brain, **351**
 tail, **349**
 Salts, **8, 19, 20, 38, 454**
 Sand dollars, **201, 203**
 Sandpipers, **401**
 Sandworm, **242, 243**
 Sanitation, **492**
 Saprophytic types, **80**
 Sarcocoe, **18**
 Sarcodina, **78, 79, 82, 87**
 (See also Rhizopoda)
 Sarcocoe, **104**
 Sarcoplasm, **100, 177**
Sarcoptes scabiei, **301**
 Sauropsida, **375**
 Sawfish, **341**
 Scabies, **302**
 Scab mites, **302**
 Scala tympani, **330, 331**
 Scala vestibuli, **330, 331**
 Scale insect, **289**
 Scale lice, **289, 290**
 Scales, **53, 318, 344-348, 367, 378, 379, 384, 415**
 Scallops, **221, 226**
 Scaphognathite, **250, 253**
 Scaphopoda, **217, 221, 513**
 Seapula, **319, 321, 388**
 Scarlet fever, **491**
 Scent glands, **406**
 Scents, animal, **464**
Schistocerca americana, **271**
 Schleiden, **31, 554**
 Schwann, **31, 554**
 Schultze, Max, **18, 31, 554**
 Selater, **504**
 Scleroblasts, **130**
 Sclerotic layer, **332, 333**
 Scolex, **165, 166, 168**
Scelopendra, **269**
 Scolytid beetle, work, **285**
 Scorpions, **299-300, 510, 514**
 Scutes, **383, 384**
Scutigera, **269**
Scyllium canicula, brain, **340**
 Scyphistoma, **149, 150**
 Scyphozoa, **143, 144, 145, 513**
 Sea anemones, **143-145, 261, 495, 496**
 Sea angels, **220**
 Sea cucumbers, **201, 204-207**
 Sea fans, **143, 146, 147**
 Sea lilies, **201, 205, 206**
 Sea lions, **414**
 Sea mats, **187**
 Sea moss, **187**
 Sea pens, **143, 146, 147**
 Sea slugs, **221**
 Sea snakes, **385**
 Sea squirts, **311**
 Sea urchins, **111, 112, 201-204, 438, 513**
 Seals, **414**
 Seasonal changes, **477, 482**
 Sebaceous glands, **98, 318, 406**
 Secretary bird, **506**
 Secretin, **431**
 Secretion, **32-35, 65, 97, 102, 138, 168, 322, 323, 333, 335, 376, 393, 411, 463-464**
 Secretions, **28, 35-36, 65, 97, 98, 102, 161, 171, 235, 236, 268, 287, 298, 311, 321, 323, 335, 359, 366, 368, 382, 395, 400, 439, 452, 463-464, 468, 471**
 Sedgwick, Adam, **267**
 Segmentation, **120**
 cavity, **119, 120, 123**
 (See also Blastocoele)
 Segments, **51**
 Segregation, **530-535**
 Self-fertilization, **106, 141, 162, 219, 442**
 Self-regulatory tendency, **489**
 Semicircular canals, **330, 331, 336, 341, 369**
 Semilunar ganglion, **328**
 Seminal groove, **230**
 Seminal receptacles, **166, 167, 235, 258, 297**
 Seminal vesicles, **160, 161, 235**
 Semipermeable membrane, **12**
 Senescence, **43, 44**

- Senility, 433, 434
- Sensations, 331, 332, 468
- Sense organs, 104, 149, 155, 186, 197, 213, 219, 222, 243, 255-256, 271, 272, 277-278, 299, 328-333, 341, 353-354, 369, 380, 395-396, 409-410, 445, 468
- Sensory cells, 136, 137
- Sensory epithelium, 96
- Sensory fibers, **327**
- Sensory papillae, **245**
- Sepia*, eye, **223**
- Serous secretion, 439
- Serpent stars, 201
- Serpula vermicularis*, **244**
- Sertularia*, 144
- Serum, 324
- Servetus, 552
- Setae, 229, **231**, 254, 545
- Sex, 40
 - cells, 44, 45, 86, 94, 107, 111, 132, 136, 137, 149, 155, 195, 248, 442, 448, 531, 532, 538
 - chromosomes, 537, 539
 - determination, 537, **538**
 - hormones, 465
 - linked character, 539
 - organs, 167, 235
- Sexual cycle, **88**
- Sexual dimorphism, 443, 543
- Sexual reproduction, 45, 86, 105, 132, 135, 140, 149, 162, 189, 248, 311-312, 442-443
(See also Reproduction)
- Sexual spores, **88**
- Sexual zooids, 248, **249**
- Shaft, 391, **392**
- Shank, 391
- Sharks, 334, 338-343, 495, 514, 550
- Sheep, 416, 507
 - liver fluke, 170-172, 174
 - skull, **407**
- Shelford, 478
- Shell, **189, 190, 208**, 209-211, 214, **215**, 217-224, 226-228, 389, **513**, 544, 545
 - glands, 166-168, 466
- Shipworm, 221, **227**, 228
- Shore faunas, **483**
- Short digits, 537
- Shrews, 412
- Shrimps, 260, 265-267
- Sight, 219, 222, 225, 255-256, 277, 296-297, 299, 332-333, 353-354, 369, 380, 382, 385, 395-396, 445
- Silicou, 19
- Silk, 282, 297-299, 301, 463, 471
- Silkworms, 83, 273, 282, 463, 471-472, 554
- Silurian period, 190, 225, 511, 513, 514
- Sinuses, 254, 298, **329**
- Sinus venosus, **339**, 340
- Siphons, **204**, 208-210, **212**, **222**, 223
- Siphuncle, **224**
- Sipunculid, **247**
- Sirenia, 411, 417
- Size limit, 44
- Skates, 334, 341, **342**
- Skeletal lamina, 85
- Skeletal muscle, **100**
- Skeletal system, 102, 103, 437
(See also Skeleton)
- Skeleton, 130, 203, 306, 307, 316, 318-321, 335, 339, 344, 345, 350, 362, 364, **388**, 393, 398, 406, 422-423, 487-488
- Skin, 103, **318**, 335, 339, 359-360, 364, 366, 368, 400, 437, 439, 463
 - gills (see Dermobranchiae)
- Skull, 318, **319**, 336, 350, 406-407, 518
- Skunks, 413, 417
- Sleeping sickness, 87
- Sliths, 415, 506
- Slugs, 220
- Small intestine, **322**, 323
- Smallpox, 491
- Smell, 225, 277, 328-330, 341, 353, 380, 385, 395, 410, 445, 468
(See also Olfactory organs)
- Snails, 10, 217, 218-220, 226, **481**
- Snakes, 334, 379-381, 383-387, 389, **417**, 504
- Sneezing, 468
- Snipe, 401
- Snout, 406
- Soaring, 398
- Societies, 291-295, 494
- Sociology, 5
- Sodium carbonate, 18, 463
- Sol, 12, **13**
- Soldier ant, **294**
- Soldier termite, **283**
- Solid, 9
- Solitary bees, 293
- Solitary life, 493
- Solute, 11
- Solutions, 11
- Solvent, 11
- Soma, 451
- Somatic cells, 94, 95, 451
- Somatic mesoderm, 123, **307**, 376
- Somatoplasm, 94, 451, 517
- Somatopleure, 376
- Song birds, 401, 403, 404
- Songs, bird, 402
- Sounds, insects, 277
- Sow bugs, 262
- Special creation, 25, 553
- Specialization, 201, 242, 295, 304, 439
(See also Adaptation)
- Species, 3, 58, 59, 522, 542
- Sperm, 44, 107, 315
 - cells, **29**, 44, 45, 105-114, 132, **135**, 140, **150**, 151, 161, 162, 167, 172, **173**, **178**, 214, **235**, 236, 246, 257, 258, 298, 334, 355, 371, 419, 448, 493, 528, **530**, 532, 537, **538**, 539, 554
 - whale, 417, 421
- Spermaries, hydra, **135**, 140, 141
- Spermatids, 107, **108**
- Spermatocytes, 107, **108**, 538
- Spermatogenesis, 107, 109
- Spermatogonia, 107, **108**, 140
- Spermatophores, 161, 246
- Spermatozoon, 107
- Sphenodon*, 505, 506
- Sphenodon punctatum*, **387**
- Sphenoidal sinus, **329**

- Spherical symmetry, 51
 Sphincters, 131, 461
 Spicules, 128, 130, **131, 175**
 Spider crabs, 261
 Spiders, 296–299, 440, 442, 473, **485**, 510, 514
 Spinal cord, 307, **317, 327**, 328, 336
 Spinal curvature, 423
 Spinal nerves, **327**, 328
 Spindle, 46, **47**
 Spines, 53, 191–193, **195, 202**, 203
 Spinnerets, **296, 297**
 Spinning, 298, 470
 Spiny-headed worms, 181
 Spiracle, **272, 275, 296, 297, 300, 338, 362, 373**
 Spiral cleavage, 121
 Spiral valve, 338, **339**
 Spireme, 46, **47**
 Spiritus, 553
Spirobohus, **270**
 Spirochaetes, 87
 Splanchnic mesoderm, 123, **307, 376**
 Splanchnopleure, 376
 Spleen, **317, 322, 324, 339, 366**
 Sponges, 127–133, 261, 436–438, **440, 441, 443, 449, 461, 466, 468, 469, 495, 512, 513**
Spongilla lacustris, **127**
 Spongin, 130, 463
 Spongoblasts, 130
 Spontaneous generation, 25, 516
 Sporoblast, **88**
 Sporocyst, **171, 172**
 Sporozoa, 78, **82, 83, 87**
 Sporozoites, 86
 Sports, 522
 Sporulation, **67, 68, 88**
Squalus, 338
Squalus acanthias, **338, 339, 342, 347**
 Squamata, 379, 380
 Squamous epithelium (*see* Pavement epithelium)
 Squash bug, 284
 Squids, 217, **222, 224–226, 438**
 Squirrels, 414, 481, 509
Stagmomantis carolina, **274**
 Stapes, **330, 331, 362, 410**
 Starfishes, 112, 191–199, 201, 206, 207, 513
 Statoblast, **189**
 Statocysts, 149, **154, 155, 213, 219, 222, 256**
 Statoliths, 213, 256
 Steapsin, 323
 Stegocephala, 515
Stegodon, **524**
Stegomastodon, **524**
Stentor, 83
Stentor polymorphus, **84**
 Stercoral pocket, **297**
 Sternal artery, **252, 253**
 Sternum, **319**
 Sterols, 19
 Stigma, **79**
 Stimuli, 54, 56, 101, 131, 139, 238, 328, 444, 445, 467–471
 Sting ray, 341
 Stomach, **184, 186, 188, 190, 195, 196, 197, 204, 210, 212, 222, 246, 253, 254, 276, 277, 297, 311, 312, 317, 322–323, 339, 350, 393, 416, 431, 439, 461**
 Stomodaeum, 144–146, **154, 371, 372, 438**
 Stone canal, **194**
 Storage, food, 38
 Strainer, 254
 Stratification, 479
 Stratified epithelium, 96, **97**
 Stream fauna, 484
 Strobila, **149, 150, 167**
 Strobilation, **149**
Strongylocentrotus drobachiensis, **202**
 Struggle for existence, 517, 521
 Sturgeons, **345, 349**
 tail, 358
Stylonychia, 83
Stylonychia mytilus, **84**
 Subclavian artery, **339, 360, 379, 409**
 Subclavian vein, **339, 409**
 Subdermal cavity, **130**
 Subesophageal ganglion, **254, 276, 277**
 Subimago, 281
 Subneural gland, **311**
 Subperitoneal rib, **317**
 Subpharyngeal ganglia, **233**
 Subspecies, 58, 543
 Subterranean fauna, 484
 Succession, 480, **481**
 Suckers, flukes, **166, 171**
 leeches, **245**
 tapeworm, **168**
 tube feet, **194**
 Sucking, 468
 discs, 221
 fish, **495**
 flies, 498
 lice, 283
 Suctoria, 79, 83
 Suctorial insects, 273, 289
 Sugar, 34, 461
 Sulphur, 18
 Summation of stimuli, 74
 Sunbirds, 507
 Sunfish, mouth, **352**
 Superficial cleavage, **117, 119, 258, 264, 278, 449**
 Supporting lamella, 136
 Supporting tissues, 98, **99**
 Suprabranchial chambers, 210–212
 Supraesophageal ganglion, **253, 254, 276, 277**
 Suprapharyngeal ganglia, **232, 233**
 Surface films, **10**
 Surinam toad, 366
 Survival of fittest, 516
 Suspensions, 11
 Suspensory ligament, **333**
 Swallowing, 468
 Swammerdam, 552
 Swamp sparrow, 481
 Swans, 403
 Swarming, 293
 Sweat glands, **318, 406, 456**
 Swim bladder, 348
 Swimmerets, 251–253, **258**

- Swimming birds, 401, 481
 Swimming insects, 273
 Swine, 416
 (See also Pig)
- Sycon, 129, **130**
Sycotypus, 225
 Sylvius, 552
 Symbiont, 496
 Symbiosis, 141, 429-430, 489, 496
 Symmetry, 51, 544, 545, 547
 Sympathetic nervous system, 327
 Synapses, 238, **239**, 444
 Synapsis, 107-110, 115, 448, 528, 540
 Synaptic mates, 528
 Synaptic nervous systems, 444, 445
 Syncytium, **436**
 Syndactyl foot, **400**
 Syngamy, 45
 Syphilis, 87, 488
 Syrinx, **394**, 402
 Systems, 102-104, 158-161, 436-445
 (See also individual systems)
 Systematic zoology, 541
 Syzygy, **82**
- T
- Tactile cells, 149
 Tactile corpuscle, **318**
 Tactile organs, 183, 197, 243, 247, 255, 277, 299,
 315, 318, 329, 353, 367, 380, 445
 Tadpoles, 116, 312, 344-346, **373**, 490, 552
Taenia saginata, **168**, 172-174
Taenia solium, 168
 Tail, 53, 316, 362, 382, 383, 391, **519**
 Tail fin, 349-350
 Tapeworms, 166-168, 174
 Tapirs, 416, 506
 Tarpon, 358
 Tarsus, **272**, **319**, **321**, **362**
 Taste, 328, 330, 353, 380, 385, 395, 410, 445, 468
 buds, **329**, 330, 410
 organs, 277, 353, 380, 410
 Taxonomy, 5, 541-548, 554
 Tears, 463
 Teeth, 335, **336**, 338, 350, 353, 364, 366, 368, 379,
 384, 388, 390, 407, **408**, 414, 415, 417
 Tegmina, **271**, 275
 Tegumentary system, 102, 103, 436-437
 Telencephalon, 328
 Teleostei, 344, 346
 Teleostomi, 344
 Teleosts, 334, 344, **346**, **351**, **352**, 355-356, 515
 Telolecithal egg cell, **117**, 118, 356, 449
 Telophase, **47**, 48
 Telson, 251-253
 Temperature, body, 394, 400, 417, 455-457
 external, 67, 72, 172, 479, 501, 503
 receptors, 328, 445
 Tendons, 98, **99**, **104**, 320, 443
 Tentacles, 53, **134**, **136**, **142**, **145**, 146, 154, 155,
 196, 205, 218, **219**, 221, **222**, **242**, 243, **314**,
 440
Terebratella transversa, **189**
Teredo navalis, **227**, 228
- Termites, 278, 282, **283**, 291, 429, 496
 Terrestrial faunas, 359, 362
 Testes, 104, **135**, **160**, 161, 166, **168**, 195, **235**, **253**,
 325, 333, 432, 442, 465
 Testudinata, 380, 389
 Tetanic contraction, 54, 467
 Tetanus, 467
Tetrahodon, **524**
 Tetrad, 448
 Tetraxon spicules, 130, **131**
 Texas cattle fever, 301
 Thales, 549
 Theca, 146
 Thermotropism, 55, 67, 72, 139, 162, 370
 Thermocline, **484**
 Thigmotropism, 55, 66, 72, 139, 162, 234, 370
 Thoracic basket, 320, 375
 Thoracic cavity, 317
 Thoracic ganglia, **276**, 277
 Thoracic region, 316
 Thoracic vertebrae, **319**, 320
 Thousand-legged worms, **260**
 Threadworms (see Nematelminths)
 Threshold, 55
 Thrombin, 462
 Thymus glands, 367, 464, **465**
 Thyroid glands, 367, 464, **465**
 Tibia, **272**, **319**, **321**, **388**
 Tibiotarsus, **391**
 Ticks, 300, **301**, 498
 Tiedemann's bodies, 196
 Tigers, 506, 507, 522, **523**
 Tiger beetles, 289
 Tiger salamander, **365**
 Time and area, 500
 Tissues, 96-101, 120-122, 435
 Toads, 334, 359, 366-368, 374, 437
 horned, 384
 Toes, **186**, **367**, 382, 383, 391, 406, 415, 416, 422-
 424
 Toleration, 489
 Tongue, **322**, **382**, **383**, 389
 cartilage, **336**
 Tonic contraction, 467
 Tonsils, 408
 Tonus, 206, 462, 464, 467
 Tooth, **408**
 (See also Teeth)
 Tornaria, **310**
 Tortoises, 389, 505
 (See also Turtles)
 Tortal cleavage, **116**, 118, 140, 198, 214, 315, 419,
 448, 449
 Toucans, 506, 507
 Touch (see Tactile organs)
 Toxins, 489
 Trachea, **322**, 324, **394**
 Tracheae, 268, 269, 275, **276**, **297**, 298, 440
 Tracheal gills, 275
 Tracheata, 305
 Traction fibers, 48
 Traumatism, 488
 Tree frogs, 367
 Tree toads, 367
 Trematoda, 164-166

- Trembley, 141
Tremex columba, 291
 Trepang, 207
 Trial and error, 73-74
 Triassic period, 511, 514, 515
 Triaxon spicules, 130, **131**
Trichinella, 178, 180
Trichinella spiralis, **180**
 Trichinosis, 180
 Trichocysts, **70**, 74
 Trihybrids, 533
 Trilobites, 303, 513, **514**
 Trinomials, 543
 Triploblastic condition, 121, 155, 164, 544, 545, 547
 Triradial spicules, 130, **131**
 Trivium, 200
 Trochelminthes, 185
 Trochophore, 225, **226**, **241**, 248
 Trochozoan, 226
Trombicula irritans, **301**
 Trophoderm, **418**, 419
 Trophozoite, 86
 Tropisms, 54, 55
 (See individual tropisms)
 Trunk fishes, 348
Trypanosoma gambiense, **80**
 Trypanosomes, 87
 Trypanosomiasis, 87
 Trypsin, 323
 Tsetse fly, 87
 Tuatara, **387**
 Tube-dwelling worms, 184, 243, **244**
 Tube feet, 192-197, 201-204, 206
 Tuberculosis, 288, 488, 490
Tubipora, **152**
 Tubular nervous system, 306, 308, 445
 Tundra, 507-509
 Tunic, 310
 Tunicates, 308-314, 442
 Turbellaria, 164, 165, 467
 Turbinate bones, **329**
 Turkeys, 402, 405
 Turtles, 334, 380, **388**, **389**, 417, 481, 520
 heart, **379**
 Tusk shells, 217, **221**
 Tusks, 523
 Tussock moth, 285
 Tween-brain, 328
 Twins, 538-539
 Tympanic membrane, 278, **330**, 331, 362, 364
 Tympanum, **272**, 278, **330**, 331
 Tyndall, 26, 554
 Types, 546
 Typhoid fever, 288, 491
- U
- Ulna, **319**, **321**, **361**, **388**, **391**
 Umbilical cord, **418**, 420, 421
 Umbo, **208**, **209**
 Uncinate process, 393
 Undulating membrane, 71, 83
 Unequal cleavage, **116**, 118, **214**, 225, 236, 371, 449
 Unguiculate, 411, 412
 Ungulate, 411, 416
 Uniformitarianism, 553
Unio complanatus, **214**
 Unios, 214-216
 Uniparental reproduction, 105
 Units, hereditary, 527, 529
 Universal symmetry, 51
 Unpaired genes, 534
 Urea, 36, 323
 Ureters, **210**, 213, 317, **325**, **326**
 Urethra, 325
 Urinary bladder, **317**, 325
 Urinogenital sinus, 352
 Urochordata, 308, 310, 547
 Urodela, 364, **365**
Uroglena, 81
Uroglenopsis americana, **80**
 Uropods, **251**, **252**
Urosalpinx, 225
 Use and disuse, 517, 521
 Uses of foods, 38, 454-455
 Uterus, **160**, 161-168, **176**, **325**, 341, 371, 419
 Utriculus, **330**, 331
- V
- Vaccination, 491
 Vaccines, 491-492
 Vacuoles, **30**, **64**, 65, **67**, **70**, 71, **79**, 85, **86**, **127**, 460
 Vagina, **160**, 161
 Vagus nerves, 431
 Valves, blood vessels, 231, 254, 552
 oral, **352**, 353
 spiral, 338, **339**
 Vampire bats, 505
 Vane, **392**
 Variation, 518, 521
 Varieties, 58, 543
 Vas deferens, **160**, 161, **166**, **168**, 213, **235**, **252**, **253**, 333
 Vasa efferentia, **160**, 161, **166**, 235, **325**
 Vascular systems, air-vascular (see Tracheae)
 blood-vascular (see Circulatory system)
 gastro-vascular (see Gastro-vascular cavity)
 water-vascular (see Water-vascular system)
 Vegetal pole, 118, 371
 Vegetation regions, 507-509
 Veins, 274, 298, 324, 551, 552
 Velum, 143, **150**, **226**, **311**, **313**, **314**
 Velvet mites, 302
 Vena cava, **210**, 213, **409**
 Venomous snakes, 385-387
 Ventral aorta, 340
 Ventral fins, 348
 Ventral line, **176**
 Ventral nerve cord, **176**, **231**, 233, 252, 254, **276**, 277
 Ventral root, **327**, 328
 Ventral sucker, 371, 372, **373**
 Ventral vessel, **231**
 Ventricle, **210**, **339**, 340, 361, **379**, 380
 Ventriculus, **277**
 Venus' flower basket, **129**
 Venus' girdle, 155
 Vernes, 183

- Vermiform appendix, **322**, 408, **519**
 Vertebrae, 316, 320, 423
 Vertebral column, 306, 316, 318, 320, 438, 520
 Vertebral discs, 406
 Vertebrata, 308, 316, 334, 547
 Vertebrates, 117, 316-425, 440, 441, 442, 444, 449, 463, 466, 518, 520
 Vertical distribution, 503
 Vertical life zones, 502-503
 Vertical migration, 503
 Vesalius, **550**, 551
 Vestigial structures, 518, **519**
 Villi, **34**, 323, 439
 placental, **418**
 Vipers, 386
 Virchow, 49
 Visceral ganglion, **210**, 213
 Visceral mass, 211, 219
 Visceral muscle, **100**
 Visceral pain, 445
 Visceral part of skull, 320
 Visceral sensations, 445
 Viscosity, 9
 Vision (*see* Sight)
 Vital activities, 21
 Vital force, 24, 553
 Vitalism, 24
 Vitamins, 37, 455
 Vitelline membrane, **376**
 Vitrella, **255**
 Vitreous body, **223**, 332
 Viviparity, 106
Volvox, 81, 93
Volvox aureus, **80**
 Vomiting, 468
 Von Baer, 265, 554
 Von Mohl, 18, 554
Forticella, 83, **84**
- W
- Wading birds, 401
 Walking legs, 250, **251**, **253**
 Walking sticks, 274, 283, **485**
 Wallace, 517, 521
 Walruses, 414, 421
 Wandering cells, 131
 (*See also* Leucocytes)
 Warbler, beak, **399**
 Warm-bloodedness, 408, 456
 Warning coloration, 486
 Warts, 366
 Wasps, 291, 295, **485**
 Water, 19, 20, 38, 454, 455, 460, 479, 501
 beetle, **274**, **278**
 birds, 404
 boatmen, **274**, 284
 fleas, 105, 262
 moccasin, 386
 striders, 10, 284, 481
 tubes, 211, **212**
 vacuoles, **64**
 vascular system, 194-195, 201, 545
 Wax, 282, 463
 Wensels, 413
 Webs, spiders, 299
 Webworm, 285
 Weevils, 285
 Weismann, 94, 451, 517
 Whalebone, 417, 421
 Whales, 411, 417, 421
 White body, **223**
 White fibers, **99**
 White matter, **327**, 328
 Whitney, D. D., 539
 Wilson, H. V., 130
 Wind, 479, 501
 Wings, **52**, **53**, 273-275, 316, 390, 396-401, 412-413, 445
 bones, 391
 Winking, 468
 Wireworms, 285
 Wolff, Caspar, 554
 Wolves, 413, 507
 Woodchuck, 417
 Woodpeckers, 401, 481, 509
 beak, **399**
 Woodruff, L. L., 76
 Worker ants, **294**
 Worker bees, 291, **292**
 Worm lizards, 383
 Worms, 449, 466, 494, 497
 (*See* various types by name)
 Wrigglers, 288
Wuchereria bancrofti, 181
- X
- X-body, 447
 X-chromosomes, 537, 539-540
 X-rays, 521, 535
- Y
- Y-chromosomes, 537, 539-540
 Yellowlegs, beak, **399**
 foot, **400**
 Yellowthroat, 481
 foot, **400**
 Yerkes, 371
 Yolk, **109**, 110, 116-119, 162, 171, 172, 178, **376**
 cells, 162, **171**
 circulation, **378**
 ducts, **166**, **167**
 glands, **160**, 161, **166**, **168**, 171, **186**
 plug, 371, **372**
 sac, **355**, **418**, 419
 stalk, **378**, 419
- Z
- Zebra, 506
 Zinc, 19
 Zoaea, 265, **266**
Zona pellucida, **418**
Zoocidium, 187, **188**
 Zoogeography, 5, 499-509
 Zoology (general), 3-6
 Zoophytes, 143
 Zygote, 45, **88**, 89, **94**, 447, 528, 537-539
 Zymogen, 97, **98**, 464

