





ANNUAL REPORT

OF THE

BOARD OF REGENTS

OF THE

SMITHSONIAN INSTITUTION,

SHOWING

THE OPERATIONS, EXPENDITURES, AND CONDITION
OF THE INSTITUTION

TO

JULY, 1894.



WASHINGTON:
GOVERNMENT PRINTING OFFICE.
1896.

LETTER

FROM THE

SECRETARY OF THE SMITHSONIAN INSTITUTION,

ACCOMPANYING

The annual report of the Board of Regents of the Institution for the year ending June 30, 1894.

SMITHSONIAN INSTITUTION,

Washington, D. C., July 1, 1894.

To the Congress of the United States :

In accordance with section 5593 of the Revised Statutes of the United States, I have the honor, in behalf of the Board of Regents, to submit to Congress the annual report of the operations, expenditures, and condition of the Smithsonian Institution for the year ending June 30, 1894.

I have the honor to be, very respectfully, your obedient servant,

S. P. LANGLEY,

Secretary of Smithsonian Institution.

Hon. ADLAI E. STEVENSON,

President of the Senate.

Hon. CHARLES F. CRISP,

Speaker of the House of Representatives.

ANNUAL REPORT OF THE SMITHSONIAN INSTITUTION FOR THE
YEAR ENDING JUNE 30, 1894.

SUBJECTS.

1. Proceedings of the Board of Regents for the session of January, 1894.

2. Report of the Executive Committee, exhibiting the financial affairs of the Institution, including a statement of the Smithsonian fund, and receipts and expenditures for the year ending June 30, 1894.

3. Annual report of the Secretary, giving an account of the operations and condition of the Institution for the year ending June 30, 1894, with statistics of exchanges, etc.

4. General appendix, comprising a selection of miscellaneous memoirs of interest to collaborators and correspondents of the Institution, teachers, and others engaged in the promotion of knowledge. These memoirs relate chiefly to the calendar year 1894.

CONTENTS.

	Page.
Letter from the Secretary, submitting the Annual Report of the Regents to Congress	III
General subjects of the Annual Report	IV
Contents of the Report	V
List of illustrations.....	VIII
Members <i>ex officio</i> of the Establishment.....	IX
Regents of the Smithsonian Institution	X
JOURNAL OF THE PROCEEDINGS OF THE BOARD OF REGENTS	XI
Stated meeting January 24, 1894	XI
REPORT OF THE EXECUTIVE COMMITTEE for the year ending June 30, 1894.	XV
Condition of the fund July 1, 1894	XV
Receipts for the year.....	XVI
Expenditures for the year.....	XVI
Sales and repayments	XVI
Appropriation for International Exchanges.....	XVII
Details of expenditures of same.....	XVII
Appropriations for North American Ethnology	XVIII
Details of expenditures of same.....	XVIII
Appropriation for the National Museum	XIX
Details of expenditures of same.....	XIX
Appropriation for repairs of Smithsonian building	XXVIII
Details of expenditures of same	XXVIII
Appropriation for Astrophysical Observatory.....	XXIX
Details of expenditures of same	XXIX
Appropriations for the National Zoological Park.....	XXX
Details of expenditures of same.....	XXX
General summary.....	XXXII
Income available for ensuing year.....	XXXIII
ACTS AND RESOLUTIONS OF CONGRESS relative to the Smithsonian Institution, National Museum, etc., Fifty-second Congress, second session	XXXV

REPORT OF THE SECRETARY.

THE SMITHSONIAN INSTITUTION.....	1
The Establishment.....	1
The Board of Regents	2
Administration	2
Finances	3
Buildings.....	4
Repairs to Smithsonian building	5
Research	7
Explorations	8
Publications.....	8

THE SMITHSONIAN INSTITUTION—Continued.	Page.
Library	11
Hodgkins fund	12
Correspondence	16
MISCELLANEOUS:	
Naples table	17
Seal of the Institution	18
World's Columbian Exposition	18
Delegates to universities and learned societies	19
Woodcuts, etc	19
Archives	20
Assignment of rooms	20
Toner lecture fund	20
The Hamilton fund	20
Statue of Professor Baird	21
American Historical Association	21
United States National Museum	21
Bureau of American Ethnology	28
International exchanges	32
United States National Zoological Park	34
Astro-physical Observatory	39
Appendixes:	
Appendix I. The United States National Museum	41
II. Report of the Director of the Bureau of Ethnology	44
III. Report of the Curator of Exchanges	58
IV. Report of the Superintendent of the National Zoological Park	68
V. Report upon the Astro-physical Observatory	75
VI. Report of the Librarian	79
VII. Report of the Editor	83

GENERAL APPENDIX.

On the Magnitude of the Solar System, by William Harkness	93
Schiaparelli's latest views regarding Mars, by William H. Pickering	113
Light and Electricity, according to Maxwell and Hertz, by M. Poincaré	129
The Henry, by T. C. Mendenhall	141
The Age of Electricity, by M. Mascart	153
Terrestrial Magnetism, by Prof. A. W. Rucker	173
Photographic Photometry, by M. J. Janssen	191
The Splash of a Drop and Allied Phenomena, by Prof. A. M. Worthington	197
The Waste and Conservation of Plant Food, by Harvey W. Wiley	213
Four Days' Observations at the Summit of Mont Blanc, by M. J. Janssen	237
Weather Making, Ancient and Modern, by Mark W. Harrington	249
Variation of Latitude, by J. K. Rees	271
The Development of the Cartography of America up to the Year 1570, by Dr. Sophus Ruge	281
Antarctica: A Vanished Austral Land, by Henry O. Forbes	297
The Promotion of Further Discovery in the Arctic and the Antarctic Regions, by Clements R. Markham	317
The Physical Condition of the Ocean, by Capt. W. J. L. Wharton, R. N.	343
The Origin of the Oldest Fossils and the Discovery of the Bottom of the Ocean, by W. K. Brooks	359
The Relations of Physiology to Chemistry and Morphology, by Giulio Fano ..	377

	Page.
The work of the Physiological Station at Paris, by E. J. Marey.....	391
The method of Organic Evolution, by Alfred R. Wallace.....	413
The Part Played by Electricity in the Phenomena of Animal Life, by M. Ernest Solvay.....	437
The Influence of Certain Agents in Destroying the Vitality of the Typhoid and of the Colon Bacillus, by John S. Billings and Adelaide Ward Peckham.....	451
Modern Developments of Harvey's Work in the Treatment of Diseases of the Heart and Circulation, by T. Lauder Brunton.....	459
Ants' Nests, by Dr. August Forel.....	479
The Evolution of Modern Society in its Historical Aspects, by R. D. Melville..	507
Migration and the Food Quest, by Otis Tufton Mason.....	523
The Guanches: The Ancient Inhabitants of Canary, by Capt. J. W. Gambier, R. N.....	541
Psychology of Prestidigitation, by Alfred Binet.....	555
A Discovery of Greek Horizontal Curves in the Maison Carrée at Nimes, by Wm. Henry Goodyear.....	573
The Methods of Archaeological Research, by Sir Henry Howorth.....	589
The Art of Casting Bronze in Japan, by W. Gowland.....	609
Study and Research, by Rudolph Virchow.....	653
Scientific Problems of the Future, Lieut. Col. H. Elsdale.....	667
The Founding of the Berlin University and the Transition from the Philosophic to the Scientific Age, by Rudolph Virchow.....	681
The Institute of France in 1894, by M. Loewy.....	697
Hermann von Helmholtz, by Arthur W. Rucker, F. R. S.....	709
Sketch of Heinrich Hertz, by Helene Bonfort.....	719

LIST OF ILLUSTRATIONS.

	Page.		Page.
SECRETARY'S REPORT:		THE WORK OF THE PHYSIOLOGICAL	
Map of correspondents (plate) ..	32	STATION AT PARIS—Continued.	
Area of zoological parks (plate).	36	Fig. 1.....	404
Deer house (plate).....	68	Fig. 2.....	404
Infra red spectrum (plate).....	76	Fig. 3.....	405
Bolographs (text fig.).....	76	ANTS' NESTS:	
SCHIAPARELLI'S LATEST VIEWS RE-		Plate LV.....	506
GARDING MARS:		Plate LVI.....	506
Plate I.....	114	MIGRATION AND THE FOOD QUEST:	
LIGHT AND ELECTRICITY:		Plate LVII.....	528
Fig. 1.....	134	THE GUANCHES:	
THE SPLASH OF A DROP AND ALLIED		Fig. 1.....	542
PHENOMENA:		Figs. 2, 3.....	543
Fig. 1.....	199	Fig. 4.....	544
Fig. 2.....	200	Fig. 5.....	545
Plate II.....	200	Figs. 6, 7.....	546
Plate III.....	202	Figs. 8, 9, 10.....	547
Plate IV.....	204	Fig. 11.....	551
Plate V.....	206	Figs. 12, 13, 14.....	552
Plate VI.....	208	Fig. 15.....	553
Plate VII.....	208	GREEK HORIZONTAL CURVES IN THE	
Plate VIII.....	208	MAISON CARRÉE AT NIMES:	
Plate IX.....	210	Plate LVIII.....	574
Plate X.....	210	Plate LIX.....	576
Plate XI.....	212	Plate LX.....	578
Plate XII.....	212	Plate LXI.....	580
Plate XIII.....	212	Plate LXII.....	582
Plate XIV.....	212	Fig. 1.....	583
Plate XV.....	212	Plate LXIII.....	584
Plate XVI.....	212	Fig. 2.....	585
THE DEVELOPMENT OF CARTOGRA-		Fig. 3.....	586
PHY OF AMERICA:		ART OF CASTING BRONZE IN JAPAN:	
Plates XVII-XLV.....	296	Plate LXIV.....	612
THE WORK OF THE PHYSIOLOGICAL		Fig. 1.....	619
STATION AT PARIS:		Plates LXV, LXVI.....	620
Plate XLVI.....	392	Plate LXVII.....	622
Plate XLVII.....	398	Plates LXVIII, LXIX.....	624
Plate XLVIII.....	398	Fig. 2.....	630
Plate XLIX.....	400	Plate LXX.....	632
Plate L.....	404	Fig. 3.....	633
Plate LI.....	404	Fig. 4.....	635
Plate LII.....	404	Fig. 5.....	636
Plate LIII.....	404	Fig. 6.....	637
Plate LIV.....	404	Fig. 7.....	638

THE SMITHSONIAN INSTITUTION.

MEMBERS EX OFFICIO OF THE "ESTABLISHMENT."

(January, 1894.)

GROVER CLEVELAND, President of the United States.
ADLAI E. STEVENSON, Vice-President of the United States.
MELVILLE W. FULLER, Chief Justice of the Supreme Court of the United States.
WALTER Q. GRESHAM, Secretary of State.
JOHN G. CARLISLE, Secretary of the Treasury.
DANIEL S. LAMONT, Secretary of War.
RICHARD OLNEY, Attorney-General.
WILSON S. BISSELL, Postmaster-General.
HILARY A. HERBERT, Secretary of the Navy.
HOKE SMITH, Secretary of the Interior.
J. STERLING MORTON, Secretary of Agriculture.

REGENTS OF THE INSTITUTION.

(List given on the following page.)

OFFICERS OF THE INSTITUTION.

SAMUEL P. LANGLEY, *Secretary,*
Director of the Institution and of the U. S. National Museum.
G. BROWN GOODE, *Assistant Secretary.*

REGENTS OF THE SMITHSONIAN INSTITUTION.

By the organizing act approved August 10, 1846 (Revised Statutes, Title LXXIII, section 5580), and amended March 12, 1894, "The business of the Institution shall be conducted at the city of Washington by a Board of Regents, named the Regents of the Smithsonian Institution, to be composed of the Vice-President, the Chief-Justice of the United States, three members of the Senate, and three members of the House of Representatives, together with six other persons, other than Members of Congress, two of whom shall be resident in the city of Washington and the other four shall be inhabitants of some State, but no two of the same State."

REGENTS FOR THE YEAR 1894.

The Chief-Justice of the United States:

MELVILLE W. FULLER, elected Chancellor and President of the Board January 9, 1889.

The Vice-President of the United States:

ADLAI E. STEVENSON.

United States Senators:

JUSTIN S. MORRILL (appointed Feb. 21, 1883, and Dec. 15, 1891).....	Term expires. Mar. 3, 1897.
SHELBY M. CULLOM (appointed Mar. 23, 1885, and Mar. 28, 1889).....	Mar. 3, 1895.
GEORGE GRAY (appointed Dec. 20, 1892, and Mar. 20, 1893).....	Mar. 3, 1899.

Members of the House of Representatives:

JOSEPH WHEELER (appointed Jan. 5, 1888, Jan. 15, 1892, and Jan. 4, 1894).....	Dec. 25, 1895.
ROBERT R. HITT (appointed Aug. 11, 1893, and Jan. 4, 1894).....	Dec. 25, 1895.
W. C. P. BRECKINRIDGE (appointed Jan. 15, 1892, and Jan. 4, 1894).....	Dec. 25, 1895.

Citizens of a State:

HENRY COPPÉE, of Pennsylvania (first appointed Jan. 19, 1874).....	Jan. 26, 1898.
JAMES B. ANGELL, of Michigan (appointed Jan. 19, 1887; reappointed Jan. 9, 1893).....	Jan. 19, 1899.
ANDREW D. WHITE, of New York (first appointed Feb. 15, 1888; reappointed Mar. 19, 1894).....	Mar. 19, 1900.
WILLIAM P. JOHNSTON, of Louisiana (appointed Jan. 26, 1892).....	Jan. 26, 1898.

Citizens of Washington:

JAMES C. WELLING (first appointed May 13, 1884).....	May 22, 1896.
JOHN B. HENDERSON (appointed Jan. 26, 1892).....	Jan. 26, 1898.

Executive Committee of the Board of Regents

JAMES C. WELLING, *Chairman.*

HENRY COPPÉE.

J. B. HENDERSON.

JOURNAL OF PROCEEDINGS OF THE BOARD OF REGENTS OF THE SMITHSONIAN INSTITUTION.

ANNUAL MEETING OF THE BOARD OF REGENTS.

JANUARY 24, 1890

In accordance with a resolution of the Board of Regents adopted January 8, 1890, by which its stated annual meeting occurs on the fourth Wednesday of January, the Board met to-day at 10 o'clock a. m.

Present: The Chancellor (the Hon. M. W. Fuller), in the chair; the Vice-President (the Hon. A. E. Stevenson), the Hon. J. S. Morrill, the Hon. S. M. Cullom, the Hon. George Gray, the Hon. Joseph Wheeler, the Hon. W. C. P. Breckinridge, the Hon. R. R. Hitt, Dr. James C. Welling, Dr. James B. Angell, and the Secretary, Mr. S. P. Langley.

Excuses for nonattendance were read from Dr. William Preston Johnston and the Hon. J. B. Henderson, on account of illness, and from Dr. Henry Coppée, on account of pressing business engagements.

At the Chancellor's suggestion, the Secretary read in abstract the minutes of the last meeting, which were approved.

The Secretary then announced the following changes in the Board of Regents since the last meeting:

The term of Senator George Gray having expired, he was on March 20, 1893, reappointed Regent by the Vice-President.

Representative R. R. Hitt, who was on August 11, 1893, appointed by the Speaker of the House of Representatives to fill the vacancy occasioned by the resignation of Mr. Lodge, was on January 4, 1894, reappointed. The terms of Representative Breckinridge, of Kentucky, and Wheeler, of Alabama, having expired, they also were reappointed Regents by the Speaker on January 4, 1894.

The Secretary presented his annual report to the Board of Regents for the year ending June 30, 1893, with a few remarks concerning the increase in the activities of the Institution, during which he called attention to its recent contributions to science, made in its Astrophysical Observatory; and also to the present large number of correspondents, of which there were nearly 24,000, scattered throughout the whole globe.

On motion the report was accepted.

Dr. Welling, on behalf of his colleagues, presented the report of the executive committee for the year ending June 30, 1893, explaining that

the committee had examined every account and found them in each instance correct.

On motion the report was adopted.

Dr. Welling, in behalf of his colleagues, submitted a resolution relative to income and expenditures, placing the income of the Institution in the hands of the Secretary for his administration. Dr. Welling called the attention of the Regents to a change in the usual wording of the resolution, by the omission of some words liable to an interpretation which might tend to prejudicially limit the activities of the Institution.

The resolution (which had been passed in nearly the form now recommended during earlier years) had since 1888 been framed in the following words:

Resolved, That the income of the Institution for the fiscal year ending June 30, —, be appropriated for the service of the Institution, to be expended by the Secretary with the advice of the executive committee upon the basis of the operations described in the last annual report of said committee, with full discretion on the part of the Secretary as to items of expenditures properly falling under each of the heads embraced in the established conduct of the Institution.

This language was a departure from the form previously in use, and for the reasons stated (among which were that the words "upon the basis of the operations described in the last annual report of said committee" might seem to restrict the Secretary in the discharge of his scientific trusts) the committee offered the following resolution, the propriety of which must be apparent:

Resolved, That the income of the Institution for the fiscal year ending June 30, 1895, be appropriated for the service of the Institution, to be expended by the Secretary, with the advice of the executive committee, with full discretion on the part of the Secretary as to items.

On motion the resolution was unanimously adopted.

A modification of the act of Congress organizing the Institution, with special reference to the constitution of the Establishment, was discussed at some length in connection with bills introduced in the Senate bearing upon the subject by Senators Morrill and Cullom.

The Secretary stated that his attention had been called to the fact that a gentleman, a resident of Washington, Mr. Robert Stanton Avery, intended to make the Smithsonian Institution his residuary legatee, and had prepared the form of a will, which was submitted.

The Secretary had satisfied himself that Mr. Avery had had this purpose before him for years, and that the will of which he had just spoken was not an embodiment of any lately entertained or suddenly conceived idea, but the expression of a long-matured purpose. He further stated that Mr. Avery was desirous of knowing whether the Regents were likely to accept his bequest.

After some discussion the matter was, on motion of Mr. Breckinridge, referred to the executive committee with instructions to write to Mr. Avery acknowledging the receipt of the proposed will, thanking him

for it, declaring that the Board will accept, and expressing its appreciation.

The Secretary recalled the attention of the Board to the fact that at the last meeting he had stated that he had been informally advised by Dr. Chambers, the executor of Mr. Hodgkins's estate, that the latter had placed in the hands of a New York trust company certain bonds to be contributed after Mr. Hodgkins's death to the unrestricted portion of his donation to the institution; and that the Regents, with this understanding, had authorized the Secretary to add to this certain accrued interest and to deposit the same with the other funds of the institution in the Treasury, making the Hodgkins donation thus placed in the Treasury \$250,000, of which the income of \$100,000 was for the special purpose of the increase and diffusion of knowledge respecting the properties of atmospheric air as beneficial to man, and \$150,000 without restriction.

The Secretary had to state that, while he had received the bonds, he had not thought himself justified in making this deposit in the Treasury without further instructions from the Regents; and for this reason, that it appeared that the executor had been misinformed as to the conditions under which they were left, for when the Secretary was called upon by the trust company to actually receipt for the bonds it was found that Mr. Hodgkins had given them to form a portion not of the unrestricted, but of the restricted part of his gift.

The Secretary read a communication from the surrogate of the court of Suffolk County, N. Y., giving a statement of the condition of the Hodgkins property, and he read also a statement submitted by the executor concerning the residuary estate, and he asked instructions of the Regents as to whether, under existing circumstances, he should deposit the amounts referred to in the Treasury, or should continue to hold the bonds, or whether he should take other action.

After some further discussion, Dr. Angell read the following resolutions:

Resolved, That the executive committee and the Secretary are hereby constituted a permanent committee, with authority to accept for the Institution any property, real, personal, or mixed, that may be given to it for its purposes, "the increase and diffusion of knowledge among men," with power to sell or to convert such property, and to invest the proceeds in such manner as may appear to them for the interests of the Institution: *Provided*, That no deposit be made of such proceeds with the permanent fund in the United States Treasury other than by special resolution of the Regents.

Resolved, That the income derived from the property administered by the committee constituted by the preceding resolution be appropriated for the service of the Institution, to be expended by the Secretary under the conditions of the resolution relative to income and expenditures adopted by the Board of Regents.

Resolved, That the Secretary is authorized to deposit in the United States Treasury, at 6 per cent interest, under the terms of section 5591 of Title LXXIII of the Revised Statutes of the United States, such sums of money as may be placed unrestrictedly at the disposition of the Institution not exceeding \$97,000.

On motion of Senator Gray the resolutions were adopted.

The Secretary said that he had hoped that Congress would pass an act providing for the erection of a statue of his eminent predecessor, Secretary Baird, as it had done in the case of Secretary Henry. Efforts in this direction in the past had, however, failed, but though he had foregone neither the hope nor the intention, the present time was evidently not opportune to secure such legislation. There was now no altogether satisfactory likeness of Secretary Baird. The Secretary desired to submit to the Board of Regents the propriety of authorizing the execution of an oil portrait of the late Secretary, which, as in the case of the one of Secretary Henry, might be placed in the Regents' Room in perpetual remembrance of him.

Senator Morrill then read the following resolution, which was adopted:

Resolved, That the Secretary be requested to have a life-size portrait of the late Secretary of the Institution (Spencer F. Baird) painted by some competent artist, which, when finished, may be preserved in the room occupied by the Regents for their meetings.

The Secretary then stated to the Board that, under its resolution to provide a new seal for the Institution, he had consulted Mr. Augustus St. Gaudens, the eminent sculptor, who had taken interest in the matter, giving his personal supervision to the preparation and arrangement of the lettering. [The Secretary here exhibited an impression of a seal executed from Mr. St. Gaudens's design.] Mr. St. Gaudens had, when asked to render a bill, replied that he did not desire to submit an account. The Secretary therefore thought that some action of the Regents would be appropriate.

Senator Gray submitted the following resolution:

Resolved, That the Secretary be requested to convey, in fitting terms, the thanks of the Board of Regents to Mr. Augustus St. Gaudens for his design for a new seal for the Institution.

On motion the resolution was adopted.

The Secretary brought to the attention of the Board of Regents the fact that the late Chinese minister had presented to it an ancient and specially rare bronze vase, the receipt of which had been noted only by the ordinary form of acknowledgment at the time, and he therefore thought that the Regents might like to authorize him to give, even at this late day, some more formal expression of their thanks.

Thereupon Mr. Gray submitted the following resolution:

Resolved, That the Secretary is requested to convey, in fitting terms, the thanks of the Board of Regents to his excellency Chang Yen Hoon, member of the ministry of the Tsung Li Yamen, for the gift of a valuable ancient vase, presented by him to the Smithsonian Institution (in June, 1889).

On motion the resolution was unanimously adopted.

There being no further business to come before the Board, on motion it adjourned.

REPORT OF THE EXECUTIVE COMMITTEE OF THE BOARD OF REGENTS OF THE SMITHSONIAN INSTITUTION

FOR THE YEAR ENDING JUNE 30, 1894.

To the Board of Regents of the Smithsonian Institution :

Your executive committee respectfully submits the following report in relation to the funds of the Institution, the appropriations by Congress, and the receipts and expenditures for the Smithsonian Institution, the U. S. National Museum, the International Exchanges, the Bureau of Ethnology, the National Zoological Park, and the Astrophysical Observatory for the year ending June 30, 1894, and the balances of former years:

SMITHSONIAN INSTITUTION.

Condition of the fund July 1, 1894.

The amount of the bequest of James Smithson deposited in the Treasury of the United States, according to act of Congress of August 10, 1846, was \$515,169. To this was added, by authority of Congress, February 8, 1867, the residuary legacy of Smithson, savings from income and other sources, to the amount of \$134,831.

To this also have been added a bequest from James Hamilton, of Pennsylvania, of \$1,000; a bequest of Dr. Simeon Habel, of New York, of \$500; the proceeds of the sale of Virginia bonds, \$51,500; a gift from Thomas G. Hodgkins, of New York, of \$200,000 and \$8,000, being a portion of the residuary legacy of Thomas G. Hodgkins, making in all, as the permanent fund, \$911,000.

The Institution also holds the additional sum of \$42,000, received upon the death of Thomas G. Hodgkins, in registered West Shore Railroad 4 per cent bonds, which were, by order of this committee, under date of May 18, 1894, placed in the hands of the Secretary of the Institution, to be held by him subject to the conditions of said order, to which the attention of the Board is called.

Statement of the receipts and expenditures from July 1, 1893, to June 30, 1894.

RECEIPTS.		
Cash on hand July 1, 1893		\$57,092.82
Interest on fund July 1, 1893.....	\$27,090.00	
Interest on fund January 1, 1894	27,090.00	
	51,180.00	
Interest to January 1, 1894, on West Shore bonds.....	1,767.91	
Cash, portion of residuary legacy of Thomas G. Hodgkins...	8,000.00	
	\$121,040.73	
Cash from sales of publications	333.12	
Cash from repayments, freight, etc.....	5,686.03	
	6,019.15	
Total receipts.....		127,059.88
EXPENDITURES.		
Building:		
Repairs, care, and improvements.....	\$4,079.91	
Furniture and fixtures	1,879.87	
	\$5,959.78	
General expenses:		
Meetings	250.50	
Postage and telegraph	333.20	
Stationery	821.83	
General printing	383.85	
Incidentals (fuel, gas, etc.).....	4,794.75	
Library (books, periodicals).....	2,097.21	
Salaries *	21,133.15	
	29,814.49	
Publications and researches:		
Smithsonian contributions	793.62	
Miscellaneous collections.....	4,030.42	
Reports.....	1,717.30	
Researches.....	6,062.17	
Apparatus	613.03	
Museum	2,500.00	
Hodgkins fund.....	4,860.26	
	20,576.80	
Literary and scientific exchanges	3,110.31	
Increase of fund	8,000.00	
	\$67,461.38	
Balance unexpended June 30, 1894.....		59,598.50

The cash received from the sale of publications, from repayments for freights, etc., is to be credited to the items of expenditure as follows:

Smithsonian contributions.....	\$165.64	
Miscellaneous collections.....	130.73	
Reports	36.75	
	\$333.12	
Researches.....		9.52
Museum		3,413.46
Exchanges		2,165.95
Services		80.00
General printing.....		17.00
		6,019.15

* In addition to the above \$21,133.15, paid for salaries under general expenses, \$8,133.50 were paid for services, viz, \$1,500 charged to building account, \$1,259.93 to Hodgkins fund account, \$700.08 to library account, and \$4,673.49 to researches account.

The net expenditures of the Institution for the year ending June 30, 1894, were therefore \$61,442.23, or \$6,019.15 less than the gross expenditures, \$67,461.38, as above stated.

All moneys received by the Smithsonian Institution from interest, sales, refunding of moneys temporarily advanced, or otherwise, are deposited with the Treasurer of the United States to the credit of the Secretary of the Institution, and all payments are made by his checks on the Treasurer of the United States.

Your committee also presents the following statements in regard to appropriations and expenditures for objects intrusted by Congress to the care of the Smithsonian Institution:

INTERNATIONAL EXCHANGES.

Receipts.

Appropriated by Congress for the fiscal year ending June 30, 1894, "for expenses of the system of international exchanges between the United States and foreign countries, under the direction of the Smithsonian Institution, including salaries or compensation of all necessary employees (sundry civil act, March 3, 1893)..... \$14,500.00

Expenditures from July 1, 1893, to June 30, 1894.

Salaries or compensation:

1 curator, 12 months, at \$225	\$2,700.00
1 clerk, 12 months, at \$160	1,920.00
1 clerk, 12 months, at \$120	1,440.00
1 clerk, 1 month, at \$90	90.00
1 clerk, 12 months, at \$85	1,020.00
1 clerk, 2 months, at \$83.33	166.66
1 clerk, 12 months, at \$80	960.00
1 clerk, 12 months, at \$75	900.00
1 clerk, 12 months, at \$75	900.00
1 clerk, 12 months, at \$65	780.00
1 clerk, 1½ months, at \$45	67.50
1 messenger, 2 months, at \$20	40.00
1 packer, 12 months, at \$50	600.00
1 laborer, 313 days, at \$1.50	469.50
1 agent, 6 months, at \$83.33½	500.00
1 agent, 6 months, at \$50	300.00

Total salaries or compensation

\$12,853.66

General expenses:

Freight	1,138.60
Packing boxes	333.00
Printing and binding	12.00
Postage	60.00
Stationery and supplies	77.32

1,620.92

Total expenditure from July 1, 1893, to June 30, 1894.....

\$14,474.58

Balance July 1, 1894, to meet outstanding liabilities.....

25.42

INTERNATIONAL EXCHANGES, 1893.

Balance as per last report, July 1, 1893.....

\$1,262.23

Expenditures to June 30, 1894.

Freight	\$267.24	
Printing and binding.....	19.25	
Stationery and supplies.....	175.30	
Services	800.00	
		\$1, 261.79
Balance July 1, 1894.....		.44

NORTH AMERICAN ETHNOLOGY.

Appropriation by Congress for the fiscal year ending June 30, 1894, "for continuing ethnological researches among the American Indians, under the direction of the Smithsonian Institution, including salaries or compensation of necessary employees, \$10,000, of which sum not exceeding \$1,000 may be used for rent of building" (sundry civil act, March 3, 1893)	\$10,000.00
Balance July 1, 1893, as per last report	10,509.29
	50,509.29

The actual conduct of these investigations has been continued by the Secretary in the hands of Maj. J. W. Powell, Director of the U. S. Geological Survey.

Expenditures July 1, 1893, to June 30, 1894.

Salaries or compensation:

1 ethnologist, 6 months, at \$200; 6 months, at \$125	\$1,950.00
3 ethnologists, 12 months, at \$150	5,400.00
1 ethnologist, 12 months, at \$166.66	1,999.92
1 ethnologist, 12 months, at \$133.33	1,599.96
1 ethnologist, 12 months, at \$250	3,000.00
1 ethnologist, 12 months, at \$275	3,300.00
1 ethnologist, 12 months, at \$200	2,400.00
1 assistant ethnologist, 6 months, at \$116.66	699.96
2 assistant ethnologists, 12 months, at \$100	2,400.00
1 archaeologist, 11 months, at \$216.66	2,383.26
1 archaeologist, 12 months, at \$133.33	1,599.96
1 assistant archaeologist, 4 months, at \$100	400.00
1 clerk, 7 months, at \$60; 1 clerk, 5 months, at \$75	795.00
1 clerk, 2 months, at \$90	180.00
1 clerk, 4 months, at \$115	460.00
1 clerk, 12 months, at \$70	840.00
2 clerks, 12 months, at \$100	2,400.00
1 clerk, 12 months, at \$60	720.00
1 stenographer, 12 months, at \$133.33	1,599.96
1 stenographer, 1 month, at \$60	60.00
1 copyist, 5 months, at \$50	250.00
1 copyist, 5 months, 29 days, at \$40	238.70
1 modeler, 12 months, at \$60	720.00
1 messenger, 1 month, at \$50	50.00
1 messenger, 1 month, 16 days, at \$50	75.80
1 messenger, 11 months, at \$50	550.00
1 laborer, 5 months, at \$50	250.00
1 laborer, 4 months, 10 days, at \$40	174.28
1 laborer, 11 months, 16 days, at \$40	461.94
Total salaries or compensation.....	36,958.74

Miscellaneous:

Drawings.....	\$1,026.40	
Field expenses.....	175.39	
Field material.....	259.07	
Freight.....	294.30	
Miscellaneous.....	1,080.05	
Office rental.....	916.63	
Publications.....	457.42	
Specimens.....	945.25	
Stationery.....	288.72	
Supplies.....	491.16	
Traveling expenses.....	2,362.38	
		\$8,296.77
Total expenditure to June 30, 1894.....		45,255.51
Balance July 1, 1894.....		5,253.78

NATIONAL MUSEUM.

PRESERVATION OF COLLECTIONS, JULY 1, 1893, TO JUNE 30, 1894.

Receipts.

Appropriation by Congress for the fiscal year ending June 30, 1894, "for continuing the preservation, exhibition, and increase of the collections from the surveying and exploring expeditions of the Government, and from other sources, including salaries or compensation of all necessary employees (sundry civil act, March 3, 1893).....	\$132,500.00
--	--------------

Expenditures.

Salaries or compensation:

DIRECTION.

1 assistant secretary of the Smithsonian Institution, in charge of United States National Museum, 12 months, at \$333.33.....	\$3,999.96
---	------------

SCIENTIFIC STAFF.

1 curator (in charge), 12 months, at \$225.....	\$2,700.00
3 curators, 12 months, at \$200.....	7,200.00
1 curator, 12 months, at \$175.....	2,100.00
1 curator, 7 months 8 days, at \$155.....	1,129.29
1 curator (acting), 12 months, at \$140.....	1,680.00
1 curator, 11 months, at \$100.....	1,100.00
1 assistant curator, 12 months, at \$166.66.....	1,999.92
1 assistant curator, 12 months, at \$150.....	1,800.00
1 assistant curator, 12 months, at \$125.....	1,500.00
1 assistant curator, 10 months 16 days, at \$120.....	1,267.32
1 assistant curator, 6 months, at \$100.....	600.00
1 assistant, 2 months 15 days, at \$80.....	200.00
1 aid, 12 months, at \$100.....	1,200.00
1 aid, 12 months, at \$80.....	960.00
1 aid, 3 months 15 days, at \$80.....	278.71
1 aid, 5 months 24 days, at \$75.....	433.06
1 aid, 4 months, at \$60; 6 months 15 days, at \$50.....	564.19
1 aid, 9 months 18 days, at \$50.....	480.00
1 aid, 9 months, at \$50; 3 months, at \$40.....	570.00
1 aid, 1 month 5 days, at \$40.....	46.45

27,808.91

CLERICAL STAFF.

Salaries or compensation—Cont'd.

1 chief clerk, 12 months, at \$187.50	\$2,250.00
1 chief of division, 4 months, at \$185; 8 months, at \$180.	2,180.00
1 registrar, 12 months, at \$158.33	1,899.96
1 disbursing clerk, 12 months, at \$100.....	1,200.00
1 assistant librarian, 12 months, at \$100	1,200.00
1 stenographer, 12 months, at \$85.....	1,020.00
1 stenographer, 12 months, at \$50.....	600.00
1 clerk, 12 months, at \$125.....	1,500.00
2 clerks, 12 months, at \$115	2,760.00
2 clerks, 12 months, at \$100	2,400.00
2 clerks, 12 months, at \$90	2,160.00
1 clerk, 5 months, at \$90; 3 months, at \$70.....	660.00
1 clerk, 12 months, at \$83.33.....	999.96
1 clerk, 7 months, at \$75; 5 months, at \$50.....	775.00
2 clerks, 12 months, at \$70	1,680.00
3 clerks, 12 months, at \$60	2,160.00
1 clerk, 14 days, at \$60 per month	27.10
2 clerks, 12 months, at \$55	1,320.00
1 clerk, 28 days, at \$55, \$49.68; 23 days, at \$55, \$42.17; 9 months, at \$55, \$495.....	586.85
1 clerk, 25 days, at \$55, \$45.83; 25 days, at \$55, \$45.83; 14 days, at \$55, \$27.50; 5 months, at \$55, \$275	394.16
4 clerks, 12 months, at \$50	2,400.00
1 clerk, 3 months, at \$50	150.00
1 typewriter, 12 months, at \$50.....	600.00
1 typewriter, 12 months, at \$0.03.....	360.00
1 copyist, 12 months, at \$55.....	660.00
2 copyists, 12 months, at \$50.....	1,200.00
1 copyist, 3 months, at \$50	150.00
1 copyist, 12 months, at \$45	540.00
5 copyists, 12 months, at \$40	2,400.00
1 copyist, 1 month, at \$40	40.00
2 copyists, 12 months, at \$35	840.00
1 copyist, 7 months, at \$35	245.00
1 copyist, 1 month 7 days, at \$35	42.90
2 copyists, 12 months, at \$30	720.00
1 copyist, 12 months, at \$20	240.00

 \$38,360.93

PREPARATORS.

1 preparator, 4 months, at \$120; 5 months, at \$90	930.00
3 preparators, 12 months, at \$80	2,880.00
1 preparator, 16 days, at \$60, \$30.97; 16 days, at \$60, \$30.97; 5 months, at \$60, \$300	361.94
1 preparator, 28 days, at \$60, \$54.19; 16 days, at \$60, \$30.97; 10 days, at \$60, \$20; 5 months, at \$60, \$300	405.16
1 preparator, 4 months, at \$60; 208 days, at \$1.50.....	552.00
1 preparator, 1 month 19 days, at \$40	64.52
1 artist, 12 months, at \$110.....	1,320.00
1 photographer, 12 months, at \$158.33	1,899.96
1 taxidermist, 12 months, at \$100.....	1,200.00
1 taxidermist, 8 months, 15 days, at \$100.....	850.00
1 taxidermist, 4 months, at \$90; 1,664 hours, at 45 cents..	1,108.80
1 taxidermist, 18 days, at \$75, \$43.55; 18 days, at \$75, \$43.55; 10 months, at \$75, \$750	837.10

Salaries or compensation—Continued.

1 taxidermist, 12 months, at \$60.....	\$720.00	
1 taxidermist, 3 months, at \$60.....	180.00	
1 assistant taxidermist, 3 months, at \$40.....	120.00	
		\$13,429.48

BUILDINGS AND LABOR.

1 superintendent, 12 months, at \$137.50.....	1,650.00
1 assistant superintendent, 12 months, at \$100.....	1,200.00
1 chief of watch, 12 months, at \$65.....	780.00
1 chief of watch, 11 months, 26 days, at \$65.....	769.52
1 watchman, 12 months, at \$65.....	780.00
10 watchmen, 12 months, at \$50.....	6,000.00
1 watchman, 11 months 29 days, at \$50.....	598.33
1 watchman, 5 months 26 days, at \$50; 5 months, at \$45..	566.94
1 watchman, 5 months, at \$50.....	250.00
1 watchman, 23 days, at \$50, \$37.10; 25 days, at \$50, \$40.32; 10 months, at \$50, \$500.....	577.42
1 watchman, 23 days, at \$50, \$37.10; 25 days, at \$50, \$40.32; 20 days, at \$50, \$33.33; 2 months, at \$50, \$100.....	210.75
2 watchmen, 12 months, at \$45.....	1,080.00
1 watchman, 11 months 26 days, at \$45.....	532.74
1 watchman, 6 months 15½ days, at \$45.....	292.50
1 watchman, 9 months 19 days, at \$45.....	433.50
1 watchman, 5 months 17 days, at \$45.....	249.68
1 watchman, 11 months 30 days, at \$40.....	478.71
1 watchman, 11 months 26 days, at \$40.....	473.55
1 watchman, 8 days, at \$40, \$10.67; 28 days, at \$40, \$36.13; 8 months, at \$40, \$320.....	366.80
1 watchman, 6 months 19 days, at \$40.....	264.52
1 watchman, 18 days, at \$40, \$23.23; 30 days, at \$40, \$38.71; 5 months, at \$40, \$200.....	261.94
1 watchman, 1 month 27 days, at \$40.....	76.00
1 skilled laborer, 11 months 29 days, at \$60.....	716.13
1 skilled laborer, 12 months, at \$52.....	624.00
1 skilled laborer, 1 month, at \$46.50; 7 months 14 days, at \$45.....	384.00
1 skilled laborer, 16 days, at \$45.....	23.23
1 laborer, 1 month, at \$52.50; 2 months, at \$51; 1 month, at \$49.50; 2 months, at \$48; 3 months, at \$46.50; 3 months, at \$45.....	571.50
1 laborer, 2 months, at \$47.50; 4 months, at \$46.....	279.00
1 laborer, 1 month, at \$47.50; 1 month, at \$46; 1 month at \$41.50; 9 months, at \$40.....	495.00
1 laborer, 1 month, at \$46.50; 253 days, at \$1.50.....	426.00
1 laborer, 1 month, at \$45; 273 days, at \$1.50.....	454.50
1 laborer, 1 month, at \$43.50; 3 months, at \$40; 11 days, at \$1.50.....	180.00
6 laborers, 12 months, at \$40.....	2,880.00
1 laborer, 11 months 26 days, at \$40.....	474.67
1 laborer, 66 days, at \$1.50.....	99.00
1 laborer, 310 days, at \$1.50.....	465.00
1 laborer, 188 days, at \$1.50.....	282.00
1 laborer, 313 days, at \$1.50.....	469.50
1 laborer, 76 days, at \$1.50.....	114.00
1 laborer, 67 days, at \$1.50.....	100.50
1 laborer, 52 days, at \$1.50.....	78.00

Salaries or compensation—Continued.

1 laborer, 286 days, at \$1.50	\$429.00
1 laborer, 265½ days, at \$1.50.....	398.25
1 laborer, 36 days, at \$1.50	54.00
1 laborer, 39 days, at \$1.50	58.50
1 laborer, 4¾ days, at \$1.50	7.13
1 laborer, 311 days, at \$1.50	466.50
1 laborer, 322½ days, at \$1.50	483.75
1 laborer, 156 days, at \$1.50	234.00
1 laborer, 79 days, at \$1.50.....	118.50
1 laborer, 78 days, at \$1.50; 42 days, at \$1.25.....	169.50
1 laborer, 66 days, at \$1.50.....	99.00
1 messenger, 12 months, at \$45.....	540.00
2 messengers, 12 months, at \$30.....	720.00
1 messenger, 12 months, at \$25.....	300.00
1 messenger, 12 months, at \$20.....	240.00
1 messenger, 3 months 25 days, at \$20.....	76.13
1 messenger, 3 months 20 days, at \$20.....	72.90
1 messenger, 1 month, at \$20.....	20.00
1 messenger, 7 months 30 days, at \$20.....	160.00
1 messenger, 8 months 30 days, at \$15.....	134.52
1 messenger, 23 days, at \$15, \$11.13; 15 days, at \$15, \$7.50; 1 month, at \$15, \$15	33.63
1 attendant, 12 months, at \$40.....	480.00
1 attendant, 6 months, at \$40; 6 months, at \$30	420.00
3 cleaners, 12 months, at \$30.....	1,080.00
1 cleaner, 3 months 19 days, at \$30.....	108.39
1 cleaner, 313 days, at \$1	313.00
1 cleaner, 313 days, at \$1.....	313.00
1 cleaner, 101 days, at \$1.....	101.00
	<hr/>
	\$34,642.63
Total for services.....	118,241.94
Special services by job or contract.....	1,753.11
	<hr/>
Total services.....	119,995.05

Summary: Preservation of collections. 1894.

EXPENDITURES.

Salaries or compensation:

Direction.....	\$3,999.96
Scientific staff.....	27,808.94
Clerical staff.....	38,360.93
Preparators.....	13,429.48
Buildings and labor.....	34,642.63
Special or contract work.....	1,753.11
	<hr/>
Total salaries or compensation	\$119,995.05

Miscellaneous:

Supplies.....	1,395.78
Stationery.....	363.27
Specimens.....	3,054.55
Books and periodicals.....	641.72
Travel.....	449.88
Freight and cartage.....	2,419.55
	<hr/>
	8,324.75

Total expenditures to June 30, 1894 (preservation, 1894).....	128,319.80
Balance July 1, 1894, to meet outstanding liabilities.....	4,180.20

National Museum: Furniture and fixtures, July 1, 1893, to June 30, 1894.

RECEIPTS.

Appropriation by Congress for the fiscal year ending June 30, 1894, "for cases, furniture, fixtures, and appliances required for the exhibition and safe-keeping of the collections of the National Museum, including salaries or compensation of all necessary employees" (sundry civil act, March 3, 1893)	\$10,000.00
--	-------------

EXPENDITURES.

Salaries or compensation:

1 carpenter, 313 days, at \$3	\$939.00
1 carpenter, 73 days, at \$3	219.00
1 carpenter, 66 days, at \$3	198.00
1 carpenter, 53 days, at \$3	159.00
1 carpenter, 47 days, at \$3	141.00
1 carpenter, 43 days, at \$3	129.00
1 carpenter, 41 days, at \$3	123.00
1 carpenter, 35 days, at \$3	105.00
1 carpenter, 26 days, at \$3	78.00
1 carpenter, 24 days, at \$3	72.00
1 carpenter, 13 days, at \$3	39.00
1 cabinet maker, 313 days, at \$3	939.00
1 painter, 6 months 15 days, at \$65 per month	422.50
1 skilled laborer, 12 months, at \$50 per month	600.00
1 skilled laborer, 202 $\frac{1}{2}$ days, at \$2	405.50
1 skilled laborer, 26 days, at \$2	52.00
1 skilled laborer, 235 days, at \$1.75	411.25
1 laborer, 1 month, at \$46; 1 month, at \$44.50; 2 months, at \$41.50; 8 months, at \$40	493.50

Total	5,525.75
Special service by job or contract	29.25

Total expenditure for salaries

\$5,555.00

Miscellaneous:

Drawings	9.25
Drawers, trays, boxes	321.50
Frames, stands	58.98
Glass	103.82
Hardware	495.19
Tools	32.13
Cloth, cotton, etc	54.27
Glass jars	501.81
Lumber	826.91
Paints, oil, etc	551.83
Furniture	209.95
Metals	64.88
Rubber and leather	17.28
Apparatus	46.24
Slate, brick, etc	201.50
Iron brackets	143.42

3,641.76

Total expenditure to June 30, 1894 (furniture and fixtures)..... 9,196.76

Balance July 1, 1894, to meet outstanding liabilities

803.24

National Museum: Heating, lighting, electric and telephonic service, July 1, 1893, to June 30, 1894.

RECEIPTS.

Appropriation by Congress for the fiscal year ending June 30, 1894, "for expense of heating, lighting, electrical, telegraphic, and telephonic service for the National Museum" (sundry civil act, March 3, 1893)..... \$11,000.00

EXPENDITURES.

Salaries or compensation:

1 engineer, 12 months, at \$115.....	\$1,380.00
2 firemen, 12 months, at \$50.....	1,200.00
1 fireman, 11 months, 30 days, at \$50.....	598.39
1 telephone clerk, 12 months, at \$35.....	420.00
1 skilled laborer, 16 days, at \$60, \$30.97; 26 days, at \$60, \$52; 25 days, at \$60, \$48.39; 9 months, at \$60, \$540.....	671.36
1 laborer, 1 month, at \$46; 1 month, at \$43; 1 month, at \$42.25; 3 months, at \$40.....	251.25
1 laborer, 225½ days, at \$1.50.....	338.25
1 laborer, 53 days, at \$1.50.....	79.50
1 laborer, 53 days, at \$1.50.....	79.50
1 laborer, 11 days, at \$1.50.....	16.50
Total salaries.....	5,034.75
Special services by job or contract.....	61.50
Total expenditure for salaries.....	5,096.25

General expenses:

Coal and wood.....	\$2,671.80
Gas.....	1,367.76
Telephones.....	522.12
Electric supplies.....	112.56
Rental of call boxes.....	100.00
Heating supplies.....	393.21
Heating repairs.....	12.00
	5,179.45

Total expenditure July 1, 1893, to June 30, 1894 (heating, lighting, etc)..... \$10,275.70

Balance July 1, 1894, to meet outstanding liabilities..... 724.30

National Museum: Postage, July 1, 1893, to June 30, 1894.

RECEIPTS.

Appropriation by Congress for the fiscal year ending June 30, 1894, "for postage stamps and foreign postal cards for the National Museum" (sundry civil act, March 3, 1893)..... \$500.00

EXPENDITURES.

City post-office for postage stamps and postal cards (appropriation all expended July 1, 1894)..... \$500.00

National Museum: Printing, July 1, 1893, to June 30, 1894.

RECEIPTS.

Appropriation by Congress for the fiscal year ending June 30, 1894, "for the Smithsonian Institution for printing labels and blanks, and for the 'Bulletins' and annual volumes of the 'Proceedings' of the National Museum" (sundry civil act March 3, 1893).....	\$12,000.00
--	-------------

EXPENDITURES.

Bulletins National Museum, Nos. 43, 44, 45, 46, 47.....	\$5,033.06
Proceedings National Museum, Vols. XIV, XVI, XVII.....	4,080.85
Reports National Museum, extras.....	1,149.31
Labels for specimens.....	949.02
Letter heads, pads, and envelopes.....	193.87
Blanks.....	306.43
Binding books.....	175.66
Congressional Records.....	68.00
	<hr/>
	\$11,956.18
Balance July 1, 1894.....	43.82

National Museum: Rent of workshops and transfer from armory.

RECEIPTS.

Appropriation by Congress, "under Smithsonian Institution," for rent for workshops for the National Museum, and for expenses of transfer from the so-called Armory building, one thousand dollars, or so much thereof as may be necessary" (urgency deficiency act, March 12, 1894).....	\$1,000.00
--	------------

EXPENDITURES.

Services:	
1 carpenter, 25 days, at \$3.....	\$75.00
1 carpenter, 3 days, at \$3.....	9.00
1 laborer, 25 days, at \$1.50.....	37.50
1 laborer, 24 days, at \$1.50.....	36.00
1 laborer, 11 days, at \$1.50.....	16.50
6 laborers, 12 days, at \$1.50.....	108.00
4 laborers, 8 days, at \$1.50.....	60.00
Hauling, 3 days, at \$4.....	12.00
Rent, 2 months 16 days, at \$75.....	188.71
	<hr/>
Total.....	\$542.71
Balance July 1, 1894.....	457.29

Other Museum appropriations: Preservation of collections, 1892.

Balances as per last report, July 1, 1893.....	\$17.05
Expenditures to June 30, 1894:	
Supplies.....	12.82
	<hr/>
Balance carried, under the provisions of the Revised Statutes, section 3090, by the Treasury Department to the credit of the surplus fund, June 30, 1894.....	4.23

Total expenditures of the appropriation for preservation of collections, 1892.

	From July 1, 1891, to June 30, 1893.	From July 1, 1893, to June 30, 1894.	Total.
Salaries.....	\$123,521.54	\$123,521.54
Supplies.....	2,376.26	\$12.82	2,389.08
Stationery.....	1,218.59	1,218.59
Specimens.....	12,560.35	12,560.35
Travel.....	1,664.50	1,664.50
Freight.....	2,774.25	2,774.25
Books.....	867.46	867.46
Total.....	144,982.95	12.82	144,995.77
Balance.....	17.05	4.23	4.23

Preservation of collections, 1893.

Balance, as per last report, July 1, 1893..... \$7,414.53

EXPENDITURES.

Salaries.....	\$57.50	
Special services.....	568.95	
		\$626.45
Supplies.....		1,312.65
Stationery.....		994.04
Specimens.....		2,509.54
Travel.....		299.59
Freight.....		465.98
Books.....		888.26
Total expenditure.....		\$7,096.51
Balance July 1, 1894.....		318.02

Total expenditure of the appropriation for preservation of collections, 1893.

	From July 1, 1892, to June 30, 1893.	From July 1, 1893, to June 30, 1894.	Total.
Salaries.....	\$118,401.98	\$626.45	\$119,028.43
Supplies.....	1,888.31	1,312.65	3,200.96
Stationery.....	723.25	994.04	1,717.29
Specimens.....	3,630.02	2,509.54	6,139.56
Travel.....	407.88	299.59	707.47
Freight.....	1,889.75	465.98	2,355.73
Books.....	144.28	888.26	1,032.54
Total.....	127,085.47	7,096.51	134,181.98
Balance.....	7,414.53	318.02	318.02

Furniture and fixtures, National Museum, 1892.

Balance July 1, 1893, as per last annual report.....	\$27.78
Expenditures to June 30, 1894:	
Hardware.....	24.00
Balance carried under the provisions of Revised Statutes, section 3090, by the Treasury Department to the credit of the surplus fund, June 30, 1894.....	3.78

National Museum : Furniture and fixtures, 1893.

Balance of appropriation, as per last report, July 1, 1893..... \$2,940.09

EXPENDITURES.

Salaries and special services.....	\$4.25
Miscellaneous:	
Cases.....	1,222.00
Drawings.....	11.25
Drawers, trays, boxes.....	10.00
Frames, stands, etc.....	45.70
Hardware.....	291.35
Tools.....	189.32
Cloth, cotton, etc.....	66.24
Glass jars.....	2.74
Lumber.....	197.65
Paints, oils, etc.....	80.40
Furniture.....	249.50
Metals.....	46.99
Rubber and leather.....	432.79
Apparatus.....	89.75
 Total.....	 \$2,939.93
Balance July 1, 1894.....	.16

Total expenditure of the appropriation for furniture and fixtures, 1893

	From July 1, 1892, to June 30, 1893.	From July 1, 1893, to June 30, 1894.	Total.
Salaries.....	\$7,994.69	\$4.25	\$7,998.94
Cases.....	556.53	1,222.00	1,778.53
Drawings.....	34.50	11.25	45.75
Drawers, trays, boxes.....	252.60	10.00	262.60
Frames, stands, etc.....	16.00	45.70	61.70
Glass.....	774.92	-----	774.92
Hardware.....	649.50	291.35	940.85
Tools.....	25.08	189.32	214.40
Cloth, cotton, etc.....	47.53	66.24	113.77
Glass jars.....	438.10	2.74	440.84
Lumber.....	501.44	197.65	699.09
Paints, oils, etc.....	383.35	80.40	463.75
Furniture.....	48.22	249.50	297.72
Metals.....	30.89	46.99	77.88
Rubber and leather.....	21.86	432.79	454.65
Apparatus.....	118.20	89.75	207.95
Slate, brick, etc.....	6.50	-----	6.50
Skylights.....	160.00	-----	160.00
Total.....	12,059.91	2,939.93	14,999.84
Balance.....	2,940.09	.16	.16

Heating, lighting, etc., 1893.

Balance of appropriation, as per last report, July 1, 1893..... \$840.03

EXPENDITURES.

Gas.....	\$111.50
Telephones.....	150.00
Electric work.....	30.00
Electric supplies.....	324.25
Rental of call boxes.....	20.00
Heating repairs.....	123.75
Heating supplies.....	69.43
Total expenditure.....	\$828.93

Balance July 1, 1894..... 11.10

Total expenditure of the appropriation for heating, lighting, etc., 1893.

	From July 1, 1892, to June 30, 1893.	From July 1, 1893, to June 30, 1894.	Total.
Salaries.....	\$4,783.00		\$4,783.00
Coal and wood.....	5,003.04		5,003.04
Gas.....	1,253.64	\$111.50	1,365.14
Telephones.....	730.09	150.30	880.09
Electric work.....		30.00	30.00
Electric supplies.....	67.73	324.25	391.98
Rental of call boxes.....	100.00	20.00	120.00
Heating repairs.....		123.75	123.75
Heating supplies.....	222.47	69.43	291.90
Total.....	12,159.97	828.93	12,988.90
Balance.....	840.03	11.10	11.10

Heating, lighting, etc., 1892.

Balance as per last report, July 1, 1893..... \$1.88

Carried, under the provisions of Revised Statutes, section 3090, by the Treasury Department to the credit of the surplus fund, June 30, 1894.

Smithsonian Institution building: Repairs.

RECEIPTS.

Balance July 1, 1893, as per last annual report..... \$8,086.62

EXPENDITURES FROM JULY 1, 1893, TO JUNE 30, 1894.

Building material, lime, cement, etc.....	\$120.85
Carting.....	54.50
Floor lights.....	319.37
Glass.....	10.25
Hardware.....	55.87
Heating supplies, etc.....	460.49
Ironwork.....	110.00
Lumber, sash, doors, etc.....	707.27
Miscellaneous.....	73.76
Paints, oils, etc.....	150.38
Pipes and gutters.....	263.40
Plastering.....	604.44
Services.....	2,947.30

Sewerage and drainage, water-closets.....	\$964.93	
Skylights.....	475.00	
Stonework.....	366.30	
Tin roofing.....	401.37	
		<u>\$8,085.48</u>
Balance July 1, 1894.....		1.14

ASTROPHYSICAL OBSERVATORY; SMITHSONIAN INSTITUTION, 1894.

RECEIPTS.

Appropriation by Congress "for maintenance of the Astrophysical Observatory, under the direction of the Smithsonian Institution, including salaries of assistants, apparatus, and miscellaneous expenses" (sundry civil act, March 3, 1893).....	\$9,000.00
--	------------

EXPENDITURES FROM JULY 1, 1893, TO JUNE 30, 1894.

Salaries or compensation:

1 senior assistant, 11 months, at \$200.....	\$2,200.00
1 assistant, 1 month, at \$116.66.....	116.66
1 second assistant, 4½ months, at \$83.33, \$374.98; 4½ months, at \$83.33, \$374.98; 1 month, at \$125, \$125.....	874.96
1 junior assistant, 1 month, at \$66.66.....	66.66
1 instrument maker, 1½ days, at \$83.33, \$4.16; 3 days, at \$83.33, \$8.06; 8 days, at \$83.33, \$21.50; 8½ days, \$83.33, \$22.84.....	56.56
1 instrument maker, 81½ days, at \$3.50.....	285.25
1 assistant instrument maker, 12 months, at \$60.....	720.00
1 photographer, 14 days, at \$50, \$22.50; 16 days, at \$50, \$25.80.....	43.38
1 clerk, 1 month, at \$90.....	90.00
1 clerk, 12 months, at \$60.....	720.00
1 carpenter, 70½ days, at \$3.....	212.25
1 carpenter, 43 days, at \$3.....	129.00
1 bricklayer, 1½ days, at \$4.....	6.00
1 laborer, 6 days, at \$50.....	10.00
1 laborer, 3½ days, at \$1.75.....	5.69
1 skilled laborer, 1¾ days, at \$2.50.....	4.38
Special services, 19 days, at \$6.50.....	123.50
Total salaries or compensation.....	<u>\$5,669.29</u>

General expenses:

Apparatus and appliances.....	2,059.13
Books and binding.....	43.40
Castings.....	60.42
Drawings and enlargements.....	30.37
Freight.....	14.00
Furniture.....	40.80
Lumber.....	68.30
Stationery.....	16.79
Supplies.....	887.10
Traveling expenses.....	34.50
	<u>3,254.81</u>

Total expenditure, July 1, 1893, to June 30, 1894..... \$8,924.10

Balance July 1, 1894, to meet outstanding liabilities..... 75.90

ASTROPHYSICAL OBSERVATORY, 1893.

Balance as per last report, July 1, 1893		\$266.96
EXPENDITURES JULY 1, 1893, TO JUNE 30, 1894.		
Apparatus.....	\$148.05	
Castings.....	2.17	
Freight.....	3.89	
Lumber.....	14.10	
Supplies.....	38.74	
Total expenditure, July 1, 1893, to June 30, 1894.....		\$266.95
Balance July 1, 189401

ASTROPHYSICAL OBSERVATORY, 1892.

Balance as per last report, July 1, 1893.....	\$37.03
Balance carried, under the provisions of Revised Statutes, section 3090, by the Treasury Department to the credit of the surplus fund June 30, 1894.	

NATIONAL ZOOLOGICAL PARK, 1894.

Appropriation by Congress "for continuing the construction of roads, walks, bridges, water supply, sewerage and drainage, and for grading, planting, and otherwise improving the grounds, erecting and repairing buildings and inclosures for animals, and for administrative purposes, care, subsistence, and transportation of animals, including salaries or compensation of all necessary employees and general incidental expenses not otherwise provided for, \$50,000, one-half of which sum shall be paid from the revenues of the District of Columbia and the other half from the Treasury of the United States. A report in detail of the expenses on account of the National Zoological Park shall be made to Congress at the beginning of each regular session" (sundry civil act, March 3, 1893).....	\$50,000.00
---	-------------

EXPENDITURES FROM JULY 1, 1893, TO JUNE 30, 1894.

Building material, lime, stone, and cement	\$929.01
Business wagon.....	300.00
Freight.....	979.25
Food for animals.....	5,100.84
Fuel.....	699.64
Granolithic pavement.....	400.00
Iron, steel, piping, fencing, and hardware	2,084.54
Lumber.....	1,657.78
Machinery	280.00
Miscellaneous supplies	492.11
Paints, oils, etc	212.36
Postage, telephone, and telegraph.....	178.35
Stationery, printing, etc	106.18
Surveying, plans, etc.....	596.90
Traveling expenses	85.50
Tools and implements.....	140.56
Trees, plants, fertilizers, etc	591.46
Water supply.....	850.09
Salaries or compensation.....	20,658.08
Wages of mechanics and laborers; hire of teams in constructing roads, walks, buildings, etc.; planting and otherwise improving the grounds	12,119.94
Total expenditures.....	\$48,462.59
Balance July 1, 1894, to meet outstanding liabilities	1,537.41

NATIONAL ZOOLOGICAL PARK, 1893.

Balance July 1, 1893, as per last annual report..... \$2, 198. 98

EXPENDITURES FROM JULY 1, 1893, TO JUNE 30, 1894.

Apparatus	\$238. 45
Books and binding	6. 75
Copper cornice	199. 20
Food for animals	203. 18
Freight	176. 61
Lumber	60. 73
Paints, oils, etc	32. 39
Granolithic pavement	557. 64
Supplies	16. 61
Services	46. 78
Telephones	47. 50
Roofing tiling	565. 98
Water supply	47. 14

Total expenditure July 1, 1893, to June 30, 1894..... \$2, 198. 96

Balance July 1, 1894

.02

NATIONAL ZOOLOGICAL PARK: ORGANIZATION, IMPROVEMENT, MAINTENANCE.

Balance July 1, 1893, as per last report

\$843. 73

EXPENDITURES FROM JULY 1, 1893, TO JUNE 30, 1894.

Current expenses

\$710. 00

Balance carried, under the provisions of the Revised Statutes, section 3090, by the Treasury Department to the credit of the surplus fund, June 30, 1894.....

133. 73

Statement of the total expenditures of the appropriation for the Zoological Park, act of April 30, 1890.

	From April 30, 1890, to June 30, 1892.	From July 1, 1892, to June 30, 1894.	Total to June 30, 1894.
Shelter of animals	\$14, 925. 21		\$14, 925. 21
Shelter barns, cages, fences, etc	8, 956. 06		8, 956. 06
Repairs to Holt mansion, etc	2, 000. 00		2, 000. 00
Artificial ponds, etc	1, 089. 14	\$910. 86	2, 000. 00
Water supply, sewerage and drainage	7, 000. 00		7, 000. 00
Roads, walks, and bridges	15, 000. 00		15, 000. 00
Miscellaneous supplies	5, 000. 00		5, 000. 00
Current expenses	36, 251. 25	733. 75	36, 985. 00
Total	90, 221. 66	1, 644. 61	91, 866. 27
Balance	1, 778. 34	133. 73	133. 73

NATIONAL ZOOLOGICAL PARK: IMPROVEMENTS, 1892.

Balance as per last report, July 1, 1893

\$5. 00

Carried, under the Revised Statutes, section 3090, by the Treasury Department to the credit of the surplus fund, June 30, 1894.

RECAPITULATION.

The total amount of funds administered by the Institution during the year ending June 30, 1894, appears from the foregoing statements and the account books to have been as follows:

Smithsonian Institution.

From balance of last year, July 1, 1893.....	\$57, 092. 82	
(Including cash from executors of Dr. J. H. Kidder) \$5, 000. 00		
(Including cash gift of Alex. Graham Bell).....	5, 000. 00	
	<hr/>	
	10, 000. 00	
From interest on Smithsonian fund for the year.....	54, 180. 00	
From sales of publications.....	333. 12	
From repayments of freight, etc.....	5, 686. 03	
Interest on West Shore bonds.....	1, 767. 91	
Portion of legacy of Thomas G. Hodgkins.....	8, 000. 00	
	<hr/>	
		\$127, 059. 88

Appropriations committed by Congress to the care of the Institution

International exchanges—Smithsonian Institution:		
From balance of last year, July 1, 1893.....	\$1, 262. 23	
From appropriation for 1893-94.....	14, 500. 00	
	<hr/>	\$15, 762. 23
North American Ethnology:		
From balance of last year, July 1, 1893.....	10, 509. 29	
From appropriation for 1893-94.....	40, 000. 00	
	<hr/>	50, 509. 29
Preservation of collections—Museum:		
From balance of 1891-92.....	17. 05	
From balance of 1892-93.....	7, 414. 53	
From appropriation for 1893-94.....	132, 500. 00	
	<hr/>	139, 931. 58
Printing—Museum:		
From balance of 1892-93.....	358. 15	
From appropriation for 1893-94.....	12, 000. 00	
	<hr/>	12, 358. 15
Furniture and fixtures—Museum:		
From balance of 1891-92.....	27. 78	
From balance of 1892-93.....	2, 940. 09	
From appropriation for 1893-94.....	10, 000. 00	
	<hr/>	12, 967. 87
Heating and lighting, etc.—Museum:		
From balance of 1891-92.....	1. 88	
From balance of 1892-93.....	840. 03	
From appropriation for 1893-94.....	11, 000. 00	
	<hr/>	11, 841. 91
Smithsonian Institution building, repairs.....		8, 086. 62
Rent of workshops, etc.—Museum.....		1, 000. 00
Postage—Museum:		
From appropriation for 1893-94.....		500. 00
National Zoological Park:		
From balance of 1889-90.....	843. 73	
From improvements, 1892.....	5. 00	
From balance for 1892-93.....	2, 198. 98	
From appropriation for 1893-94.....	50, 000. 00	
	<hr/>	53, 047. 71

Astrophysical Observatory—Smithsonian Institution:

From balance 1891-92	\$37. 03	
From balance of 1892-93	266. 96	
From appropriation for 1893-94.....	9, 000. 00	
		\$9, 303. 99

Summary:

Smithsonian Institution.....	127, 059. 88	
Exchanges	15, 762. 23	
Ethnology	50, 509. 29	
Preservation of collections	139, 931. 58	
Printing	12, 358. 15	
Furniture and fixtures	12, 967. 87	
Heating and lighting	11, 841. 91	
Rent of workshops.....	1, 000. 00	
Postage.....	500. 00	
Smithsonian Institution building, repairs.....	8, 086. 62	
National Zoological Park.....	53, 047. 71	
Astrophysical Observatory	9, 303. 99	
		442, 369. 23

The committee has examined the vouchers for payment from the Smithsonian income during the year ending June 30, 1894, each of which bears the approval of the Secretary, or, in his absence, of the Acting Secretary, and a certificate that the materials and services charged were applied to the purposes of the Institution.

The committee has also examined the accounts of the several appropriations committed by Congress to the Institution, and finds that the balances hereinbefore given correspond with the certificates of the disbursing clerk of the Smithsonian Institution, whose appointment as such disbursing officer has been accepted and his bonds approved by the Secretary of the Treasury.

The quarterly accounts-current, the vouchers, and journals have been examined and found correct.

Statement of regular income from the Smithsonian fund available for use in the year ending June 30, 1895.

Balance on hand June 30, 1894.....	\$59, 598. 50
(Including cash from executors of J. H. Kidder)	\$5, 000. 00
(Including cash from Dr. Alex. Graham Bell).....	5, 000. 00
	<u>10, 000. 00</u>
Interest due and receivable July 1, 1894.....	27, 143. 92
Interest due and receivable January 1, 1895.....	27, 330. 00
Interest, West Shore Railroad bonds, due July 1, 1894.....	840. 00
Interest, West Shore Railroad bonds, due January 1, 1895.....	840. 00
	<u>56, 153. 92</u>
Total available for year ending June 30, 1895.....	115, 752. 42

Respectfully submitted.

HENRY COPPÉE,
J. B. HENDERSON,
Executive Committee.

WASHINGTON, D. C., December 14, 1894.

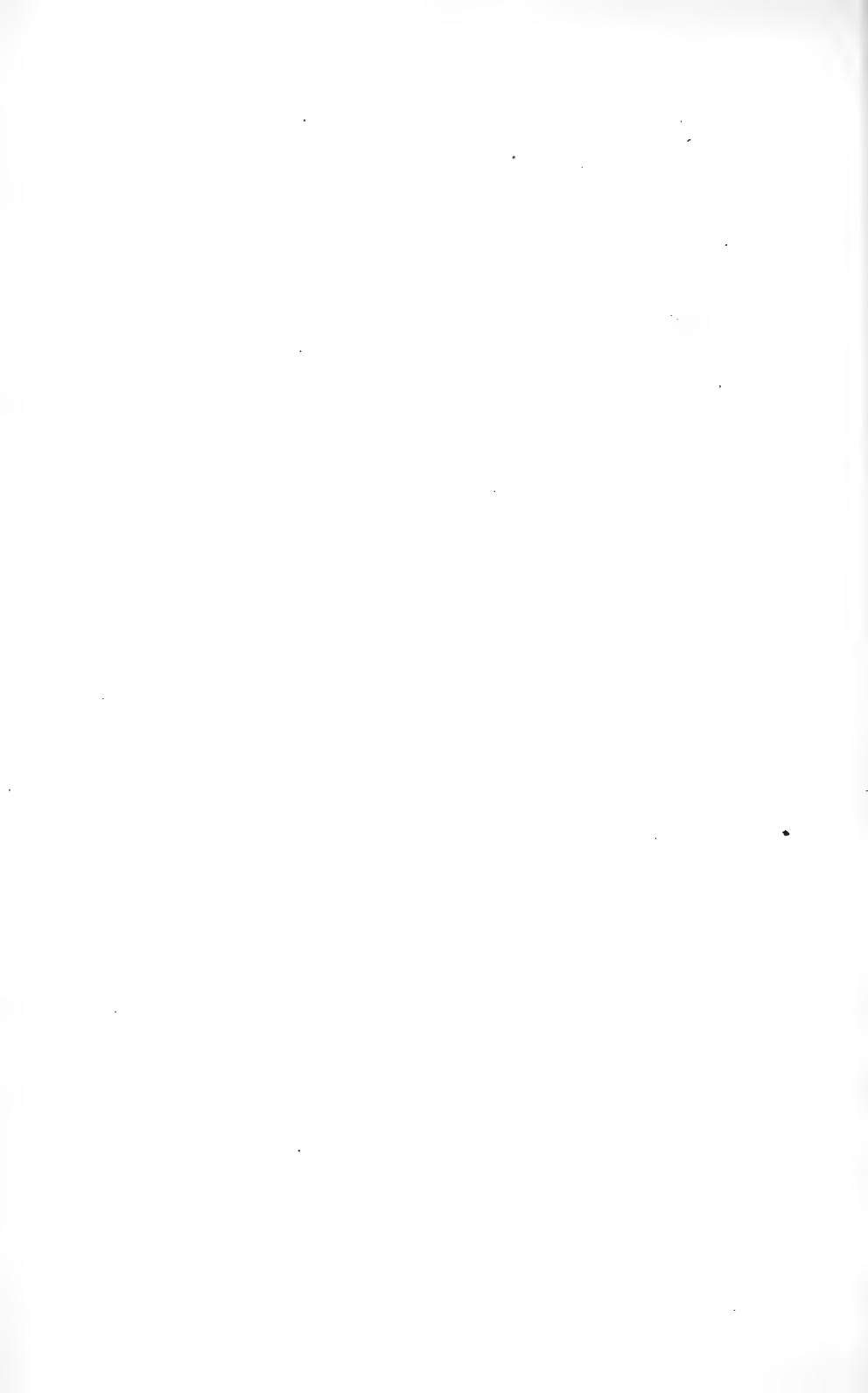

ACTS AND RESOLUTIONS OF CONGRESS RELATIVE TO THE SMITHSONIAN INSTITUTION, NATIONAL MUSEUM, ETC.

(In continuation from previous reports.)

• [Fifty-third Congress, first and second sessions.]

SMITHSONIAN INSTITUTION.

Be it enacted by the Senate and House of Representatives of the United States of America in Congress assembled, That the Revised Statutes, title seventy-three, being a reenactment of "An act to establish the Smithsonian Institution for the increase and diffusion of knowledge among men," approved August tenth, eighteen hundred and forty-six, be, and the same is hereby, amended so that section fifty-five hundred and seventy-nine shall read as follows:

"SEC. 5579. That the President, the Vice-President, the Chief Justice, and the heads of Executive Departments are hereby constituted an establishment by the name of the Smithsonian Institution for the increase and diffusion of knowledge among men, and by that name shall be known and have perpetual succession, with the powers, limitations, and restrictions hereinafter contained, and no other."

And be further amended by striking out of section fifty-five hundred and eighty the words "the governor of the District of Columbia."

And be further amended by adding to section fifty-five hundred and ninety-one as follows:

"*Provided,* That this shall not operate as a limitation on the power of the Smithsonian Institution to receive money or other property by gift, bequest, or devise, and to hold and dispose of the same in promotion of the purposes thereof." Approved March 12, 1894. (Second session Fifty-third Congress; Statutes at Large, vol. 28, p. 41.)

Resolved by the Senate and House of Representatives of the United States of America in Congress assembled, That the vacancy in the Board of Regents of the Smithsonian Institution, of the class other than Members of Congress, shall be filled by the reappointment of Andrew D. White, of New York, whose term of office expires on February fifteenth, eighteen hundred and ninety-four. Approved March 19, 1894. (Second session Fifty-third Congress; Statutes at Large, vol. 28, p. 579.)

ADVERTISEMENT FOR PROPOSALS.

Be it enacted by the Senate and House of Representatives of the United States of America in Congress assembled, That section thirty-seven hundred and nine of the Revised Statutes is amended by adding thereto the following:

And the advertisement for such proposals shall be made by all the Executive Departments, including the Department of Labor, the United States Fish Commission, the Interstate Commerce Commission, the Smithsonian Institution, the Government Printing Office, the government of the District of Columbia, and the superintendent of the State, War, and Navy building, except for paper and materials for use of the Government Printing Office and materials used in the work of the

Bureau of Engraving and Printing, which shall continue to be advertised for and purchased as now provided by law, on the same days, and shall each designate two o'clock past meridian of such days for the opening of all such proposals in each Department and other Government establishment in the city of Washington; and the Secretary of the Treasury shall designate the day or days in each year for the opening of such proposals and give due notice thereof to the other Departments and Government establishments. Such proposals shall be opened in the usual way and schedules thereof duly prepared and, together with the statement of the proposed action of each Department and Government establishment thereon, shall be submitted to a board, consisting of one of the Assistant Secretaries of the Treasury and Interior Departments and one of the Assistant Postmasters-General, who shall be designated by the heads of said Departments and the Postmaster-General, respectively, at a meeting to be called by the official of the Treasury Department, who shall be chairman thereof; and said board shall carefully examine and compare all the proposals so submitted and recommend the acceptance or rejection of any or all of said proposals. And if any or all of such proposals shall be rejected, advertisements for proposals shall again be invited and proceeded with in the same manner. Approved January 27, 1894. (Second session Fifty-third Congress; United States Statutes at Large, vol. 28, p. 33.)

JOINT RESOLUTION TO PROVIDE TEMPORARILY FOR THE EXPENDITURES OF THE GOVERNMENT.

Resolved by the Senate and House of Representatives of the United States of America in Congress assembled, That all appropriations for the necessary operations of the Government and of the District of Columbia and for the payment of pensions, under existing laws, which shall remain unprovided for on the thirtieth day of June, eighteen hundred and ninety-four, be, and they are hereby, continued and made available for a period of thirty days from and after that date, unless the regular appropriations provided therefor in bills now pending in Congress shall have been previously made for the service of the fiscal year ending June thirtieth, eighteen hundred and ninety-five; and a sufficient amount is hereby appropriated, out of any money in the Treasury not otherwise appropriated, to carry on the same: *Provided,* That no greater amount shall be expended for such operations than will be in the same proportion to the appropriations for the fiscal year eighteen hundred and ninety-four as thirty days' time bears to the whole of said year: *Provided further,* That the total expenditures for the whole of the fiscal year eighteen hundred and ninety-five, under the several appropriations hereby continued, and under the several appropriation bills now pending, shall not exceed in the aggregate the amounts finally appropriated therefor in the several bills now pending, except in cases where a change is made in the annual, monthly, or per diem compensation, or in the number of officers, clerks, or other persons authorized to be employed by the several appropriations hereby continued, in which cases the amounts authorized to be expended shall equal thirty-three hundred and sixty-fifths of the appropriations for the fiscal year eighteen hundred and ninety-four, and three hundred and thirty-five three hundred and sixty-fifths of the appropriations contained in the several bills now pending, when the same shall have been finally passed, unless the salary or compensation of any office shall be increased or diminished without changing the grade or the duties thereof, in which case such salary or compensation shall relate to the entire fiscal year and

run from the beginning thereof: *Provided further*, That the session employees of the Senate and House of Representatives now authorized by law shall be continued upon the rolls until the end of the present session of Congress and paid at the rate per diem or month at which they are now paid; and a sufficient amount is hereby appropriated, out of any money in the Treasury not otherwise appropriated, to pay the same: *Provided further*, That there be, and is hereby, appropriated, out of any money in the Treasury not otherwise appropriated, a sum sufficient to enable the Clerk of the House to pay to Members and Delegates the amount which they certify they have paid or agreed to pay for clerk hire necessarily employed by them in the discharge of their official and representative duties, as provided in the joint resolution approved March third, eighteen hundred and ninety-three, until the end of the present session of Congress. Approved June 29, 1894. (Joint resolution No. 32, second session Fifty-third Congress: Statutes at Large, vol. 28, p. 585.)

INTERNATIONAL EXCHANGES.

For expenses of the system of international exchanges between the United States and foreign countries, under the direction of the Smithsonian Institution, including salaries or compensation of all necessary employees, seventeen thousand dollars. (Sundry civil appropriation act, approved August 18, 1894; Statutes at Large, vol. 28, p. 384.)

Naval Observatory.—For repairs to buildings, fixtures, and fences, furniture, gas, chemicals, and stationery; freight (including transmission of public documents through the Smithsonian exchange), foreign postage and expressage, plants, fertilizers, and all contingent expenses, two thousand five hundred dollars. (Legislative, executive, and judicial act, approved July 31, 1894; Statutes at Large, vol. 28, p. 192.)

Department of the Interior, United States Geological Survey.—For the purchase of necessary books for the library and the payment for the transmission of public documents through the Smithsonian exchange, two thousand dollars. (Sundry civil appropriation act, approved August 18, 1894; Statutes at Large, vol. 28, p. 398.)

War Department.—For the transportation of reports and maps to foreign countries through the Smithsonian Institution, one hundred dollars. (Sundry civil appropriation act, approved August 18, 1894; vol. 28, p. 405.)

NATIONAL MUSEUM.

For continuing the preservation, exhibition, and increase of the collections from the surveying and exploring expeditions of the Government, and from other sources, including salaries or compensation of all necessary employees, one hundred and forty-three thousand dollars.

For cases, furniture, fixtures, and appliances required for the exhibition and safe keeping of the collections of the National Museum, including salaries or compensation of all necessary employees, ten thousand dollars.

For expense of heating, lighting, electrical, telegraphic, and telephone service for the National Museum, thirteen thousand dollars.

For postage stamps and foreign postal cards for the National Museum, five hundred dollars.

For tearing down and rebuilding the brick walls of the steam boilers, providing tie-rods and buck staves and grates for the same; removing, replacing, and resetting the fronts, and replacing worn-out boiler tubes, and for covering heating pipes with fireproof material, including all necessary labor and material, four thousand dollars.

For rent of workshops for the National Museum, six hundred dollars.

(Sundry civil appropriation act, approved August 18, 1894; Statutes at Large, vol. 28, p. 383.)

For the Smithsonian Institution, for printing labels and blanks, and for the "Bulletins" and annual volumes of "Proceedings of the National Museum, eleven thousand dollars. (Sundry civil appropriation act, approved August 18, 1894; Statutes at Large, vol. 28, p. 420.)

For rent for workshops for the National Museum and for expenses of transfer from the so-called Armory building, one thousand dollars, or so much thereof as may be necessary. (Urgent deficiency act, approved March 12, 1894, second session Fifty-third Congress; Statutes at Large, vol. 28, p. 43.)

For preservation of collections, National Museum, except for service over Pacific railroads, nineteen dollars and sixty-two cents. (Deficiency appropriation act, approved August 23, 1894; Statutes at Large, vol. 28, p. 477.)

United States Commission of Fish and Fisheries.—For supporting roof, strengthening of floors, and general repairs to the so-called Armory building, now occupied jointly by the United States Commission of Fish and Fisheries and the United States National Museum, including reconstructing elevator and for standpipes and fire escapes, the work to be done under the supervision and direction of the Architect of the Capitol, seven thousand one hundred dollars. (Urgent deficiency act, approved December 21, 1893, second session Fifty-third Congress; United States Statutes at Large, vol. 28, p. 17.)

NORTH AMERICAN ETHNOLOGY.

For continuing ethnological researches among the American Indians, under the direction of the Smithsonian Institution, including salaries or compensation of all necessary employees, forty thousand dollars, of which sum not exceeding one thousand dollars may be used for rent of building. (Sundry civil appropriation act, approved August 18, 1894; Statutes at Large, vol. 28, p. 384.)

ASTROPHYSICAL OBSERVATORY.

For maintenance of Astrophysical Observatory, under the direction of the Smithsonian Institution, including salaries of assistants, apparatus, and miscellaneous expenses, nine thousand dollars. (Sundry civil appropriation act, approved August 18, 1894; Statutes at Large, vol. 28, p. 384.)

NATIONAL ZOOLOGICAL PARK.

For continuing the construction of roads, walks, bridges, water supply, sewerage, and drainage; and for grading, planting, and otherwise improving the grounds; erecting and repairing buildings and inclosures for animals; and for administrative purposes, care, subsistence, and transportation of animals, including salaries or compensation of all necessary employees, and general incidental expenses not otherwise provided for, fifty thousand dollars; one-half of which sum shall be paid from the revenues of the District of Columbia and the other half from the Treasury of the United States; and hereafter a report in detail of the expenses on account of the National Zoological Park shall be made to Congress at the beginning of each regular session. (Sundry civil appropriation act, approved August 18, 1894; Statutes at Large, vol. 28, p. 383.)

For amount necessary to pay the bill of V. Baldwin Johnson for coal furnished by him for the National Zoological Park, the certificate of

inspection required by section thirty-seven hundred and eleven. Revised Statutes, being hereby waived, four dollars and seventy-five cents. (Deficiency appropriation act, approved August 23, 1894; Statutes at Large, vol. 28, p. 430.)

District of Columbia—streets.—For opening entrance into Zoological Park from Woodley Lane road, and opening driveway into Zoological Park from said entrance along the west bank of Rock Creek, two thousand five hundred dollars, to be paid wholly from the revenues of the District of Columbia. (District of Columbia appropriation act, approved August 7, 1894; Statutes at Large, vol. 28, p. 251.)

District of Columbia—sewers.—For continuing the construction of the Rock Creek intercepting sewer, twenty thousand dollars: *Provided*, That the Commissioners of the District of Columbia are authorized to enter into contract for said work at a cost not to exceed eighty thousand dollars, to be paid for from time to time as appropriations may be made by law; and the said Commissioners are authorized to construct said sewer, when necessary, across lands belonging to the United States: *Provided*, That after the construction of said sewer the excavated portions of said lands shall be restored to their original condition from the appropriation herein provided for. (District of Columbia appropriation act, approved August 7, 1894; Statutes at Large, vol. 28, p. 249.)

COTTON STATES AND INTERNATIONAL EXPOSITION AT ATLANTA GEORGIA.

For an exhibit by the Government of the United States of such articles and materials as illustrate the function and administrative faculty of the Government, to be made at the Cotton States and International Exposition, to be held at Atlanta, Georgia, in the year eighteen hundred and ninety-five, and for the employment of proper persons as officers and assistants by the board of management hereinafter created, and for the maintenance of the building hereinafter provided for, and for other contingent expenses incidental to the Government exhibit, to be approved by the chairman of the board of management and by the Secretary of the Treasury upon itemized accounts and vouchers, one hundred and fifty thousand dollars, or so much thereof as may be necessary, to be disbursed by the board of management, of which not exceeding ten thousand dollars shall be expended for clerical services. And to secure a complete and harmonious arrangement of said Government exhibit a board of management shall be created, to be charged with the selection, purchase, preparation, transportation, arrangement, safe-keeping, exhibition, and return of such articles and materials as the heads of the Executive Departments, the Smithsonian Institution and National Museum, and the United States Fish Commission may respectively decide shall be embraced in said Government exhibit. The President may also designate additional articles for exhibition. Such board shall be composed of one member to be detailed by the head of each Executive Department, one by the head of the Smithsonian Institution and National Museum, and one by the head of the United States Fish Commission, and the President shall name one of said members as chairman.

But the United States shall not, in any manner nor under any circumstances, be liable for any of the acts, doings, proceedings, or representations of the said Cotton States and International Exposition, organized under the laws of the State of Georgia, its officers, agents, servants, or employees, or any of them, or for the service, salaries, labor,

or wages of said officers, agents, servants, or employees, or any of them, or for any subscriptions to the capital stock, or for any certificates of stock, bonds, mortgages, or obligations of any kind issued by said corporation, or for any debts, liabilities, or expenses incidental to the exposition: *Provided, however,* That all articles which shall be imported from foreign countries for the sole purpose of exhibition at said exposition, upon which there shall be a tariff or customs duty, shall be admitted free of duty, customs fees, or charges, under such regulation as the Secretary of the Treasury shall prescribe; but it shall be lawful at any time during the exposition to sell, for delivery at the close of the exposition, any goods or property imported for and actually on exhibition, in the exposition buildings or on its grounds, subject to such regulation for the security of the revenue and for the collection of the import duties as the Secretary of the Treasury shall prescribe; and all such articles, when sold or withdrawn for consumption in the United States, shall be subject to the duty, if any, imposed upon such article by the revenue laws in force at the date of importation, and all penalties prescribed by law shall be applied and enforced against such articles and against the persons who may be guilty of any illegal sale or withdrawal: *And provided further,* That medals, with appropriate devices, emblems, and inscriptions commemorative of said Cotton States and International Exposition, and of the awards to be made to exhibitors thereat, be prepared at some mint of the United States for the board of directors thereof, subject to the provisions of the fifty-second section of the coinage act of eighteen hundred and seventy-three, upon the payment of a sum not less than the cost thereof; and all the provisions, whether penal or otherwise, of said coinage act against the counterfeiting or imitating of coins of the United States shall apply to the medals struck and issued under this section.

For taking down the Government main building erected for the Government exhibit at the World's Columbian Exposition and its transportation, or so much of the material thereof as may be available, and its reerection upon the site selected for the said Cotton States and International Exposition, including the purchase of such new materials as may be found necessary, fifty thousand dollars, or so much thereof as may be necessary, to be disbursed by the Secretary of the Treasury: *Provided,* That if it be found impracticable to take down, transport, and reerect said building for the sum herein appropriated, then the Secretary of the Treasury shall cause a new building to be erected upon said site of the Cotton States and International Exposition for the Government exhibit, at a cost not to exceed fifty thousand dollars, for which purpose the amount herein appropriated is hereby made available: *Provided always,* That the United States shall in no manner, and under no circumstances, be liable for any bond, debt, contract, expenditure, expense, or liability of any kind whatever of the said Cotton States and International Exposition, its officers, agents, servants, or employees, or incident to or growing out of said exposition, nor for any amount whatever in excess of the one hundred and fifty thousand dollars and of the fifty thousand dollars herein authorized; and the heads of the Executive Departments, the Smithsonian Institution and National Museum, and the United States Fish Commission, and the board of management herein authorized, their officers, agents, servants, or employees shall in no manner and under no circumstances expend, or create any liability of any kind for, any sum in excess of the appropriations herein made, or create any deficiency. (Sundry civil appropriation act, approved August 18, 1894; Statutes at Large, vol. 28, p. 420.)

REPORT OF S. P. LANGLEY,
SECRETARY OF THE SMITHSONIAN INSTITUTION,
FOR THE YEAR ENDING JUNE 30, 1894.

To the Board of Regents of the Smithsonian Institution.

GENTLEMEN: I have the honor to submit herewith a report of the operations of the Smithsonian Institution for the year ending June 30, 1894, including the work placed by Congress under its supervision in the National Museum, the Bureau of Ethnology, the Bureau of International Exchanges, the National Zoological Park, and the Astrophysical Observatory.

In the body of the report I have given briefly a general account of the affairs of the Institution and of its bureaus for the year, reserving for the appendix the more detailed and statistical reports from the officers in charge of the different branches of work.

The full report upon the National Museum by the assistant secretary, Dr. G. Brown Goode, occupies a separate volume. (Report of the Smithsonian Institution, National Museum, 1894.)

THE SMITHSONIAN INSTITUTION.

THE ESTABLISHMENT.

By act of Congress, approved by the President March 4, 1894, section 5579 of the Revised Statutes was amended to read as follows:

That the President, the Vice-President, the Chief Justice, and the heads of Executive Departments are hereby constituted an establishment by the name of the Smithsonian Institution for the increase and diffusion of knowledge among men, and by that name shall be known and have perpetual succession with the powers, limitations, and restrictions hereinafter contained, and no other.

As now organized the Smithsonian Establishment consists of the following ex officio members:

GROVER CLEVELAND, PRESIDENT OF THE UNITED STATES.

ADLAI E. STEVENSON, *Vice-President of the United States.*

MELVILLE W. FULLER, *Chief Justice of the Supreme Court of the United States.*

WALTER Q. GRESHAM, *Secretary of State.*

JOHN G. CARLISLE, *Secretary of the Treasury.*

DANIEL S. LAMONT, *Secretary of War.*

RICHARD OLNEY, *Attorney-General.*

WILSON S. BISSELL, *Postmaster-General.*

HILARY A. HERBERT, *Secretary of the Navy.*

HOKE SMITH, *Secretary of the Interior.*

J. STERLING MORTON, *Secretary of Agriculture.*

THE BOARD OF REGENTS.

In accordance with a resolution of the Board of Regents adopted January 8, 1890, by which its annual meeting occurs on the fourth Wednesday of each year, the Board met on January 24, 1894, at 10 o'clock a. m. The journal of its proceedings will be found, as hitherto, in the annual report of the Board to Congress, though reference is made later on in this report to several matters upon which action was taken at that meeting.

There has been no change in the personnel of the Board during the year, the Regents whose terms have expired having been reappointed, as follows:

Dr. Andrew D. White, reappointed by joint resolution of Congress approved by the President, March 19, 1894.

The Honorable Joseph Wheeler, the Honorable W. C. P. Breckinridge, and the Honorable Robert R. Hitt, reappointed by the Speaker of the House of Representatives on January 4, 1894.

ADMINISTRATION.

I desire to repeat the recommendation contained in my last report that Congress be asked to make an appropriation to cover the expenses incurred by the Institution incident to the administration of its Government trusts. These expenses are not specifically provided for by any of the present appropriations, since they belong not singly to the National Museum, or to the Bureau of Ethnology, or to the International Exchange Service, or the like, but to expenditures common to all of them, and which are not arranged for by the terms of the appropriations for any one. I repeat that, in the words of a previous report, it is in the interests of economy that this expenditure should be met from some common source, owing to the limited size of the establishments in question, some of which are rather assimilable to divisions than to bureaus. It is evident, for instance, that an appropriation of \$17,000 for international exchanges, or an appropriation of \$10,000 for an observatory, can not each so well bear the separate provision of a disbursing officer, a stenographer, and the other like employees, as in the case of larger bureaus, but that their limited needs can be better and more economically managed by not duplicating such offices. There is, however, no practicable way of arranging this in compliance with the present terms of the appropriations, which may be said to tacitly assume that each of these bureaus or divisions is thus completely provided for. It is in some cases impossible that it should be so without the expenditure of greatly more than the appropriated sum, and the terms of the appropriations should, in the interest of economy, either recognize the propriety of meeting each bureau's share of these common expenses out of each one's appropriation or else out of a special appropriation made in their common interest.

FINANCES.

The permanent funds of the Institution are as follows:

Bequest of Smithson, 1816.....	\$515, 169. 00
Residuary legacy of Smithson, 1867	26, 210. 63
Deposits from savings of income, 1867.....	108, 620. 37
Bequest of James Hamilton, 1875.....	1, 000. 00
Bequest of Simeon Habel, 1880	500. 00
Deposits from proceeds of sale of bonds, 1881.....	51, 500. 00
Gift of Thomas G. Hodgkins, 1891.....	200, 000. 00
Portion of residuary legacy, Thomas G. Hodgkins, 1894.....	8, 000. 00
Total permanent fund.....	911, 000. 00

By act of Congress approved by the President March 12, 1894, an amendment was made to section 5591 of the Revised Statutes, as follows:

The Secretary of the Treasury is authorized and directed to receive into the Treasury, on the same terms as the original bequest of James Smithson, such sums as the Regents may, from time to time, see fit to deposit, not exceeding, with the original bequest, the sum of \$1,000,000.

Provided, That this shall not operate as a limitation on the power of the Smithsonian Institution to receive money or other property by gift, bequest, or devise, and to hold and dispose of the same in promotion of the purposes thereof.

The above specified permanent fund is deposited, under section 5591, of the Revised Statutes, modified as above noted, in the Treasury of the United States, bearing interest at 6 per cent per annum, the interest alone being used in carrying out the aims of the Institution.

At the beginning of the fiscal year, July 1, 1893, the unexpended balance from the income and from other sources, as stated in my report for last year, was \$57,092.82. Interest on the permanent fund, amounting to \$54,180, was received during the year, which, together with a sum of \$7,787.06, received from the sale of publications and from miscellaneous sources, and \$8,000 received as a portion of the residuary legacy from the estate of Mr. Thomas G. Hodgkins, made the total receipts \$69,967.06.

The entire expenditures during the year, including the \$8,000 mentioned above, which was added to the permanent fund, amounted to \$67,461.38, for the details of which reference is made to the report of the executive committee. On June 30, 1894, the balance in the Treasury of the United States to the credit of the Secretary for the expenses of the Institution was \$59,598.50, which includes the sum of \$10,000 referred to in previous reports, \$5,000 received from the estate of Dr. J. H. Kidder, and a like sum from Dr. Alexander Graham Bell, the latter a gift made personally to the Secretary to promote certain physical researches. This latter sum was, with the donor's consent, deposited by the Secretary to the credit of the current funds of the Institution.

The Regents also hold the sum of \$42,000, received upon the death

of Mr. Thomas G. Hodgkins, in approved railroad bonds, and forming a part of the fund established by him for investigations, etc., of the properties of atmospheric air.

This balance also includes the interest accumulated on the Hodgkins donation, which is held against certain contingent obligations, and interest on the Hamilton fund, besides relatively considerable sums held to meet obligations which may be expected to mature as the result of different scientific investigations or publications in progress.

The Institution has been charged with the disbursement, during the fiscal year 1893-94, of the following appropriations:

For international exchanges	\$14, 500
For North American Ethnology	40, 000
For United States National Museum:	
Preservation of collections.....	132, 500
Furniture and fixtures	10, 000
Heating and lighting	11, 000
Postage	500
For National Zoological Park	50, 000
For Astro-physical Observatory	9, 000

All vouchers and checks for the disbursements have been examined by the executive committee, and the expenditures will be found reported in accordance with the provisions of the sundry civil acts of October 2, 1888, and August 5, 1892, in a letter addressed to the Speaker of the House of Representatives.

The vouchers for all the expenditures from the Smithsonian fund proper have been likewise examined and their correctness certified to by the executive committee, whose statement will be published, together with the accounts of the funds appropriated by Congress, in that committee's report.

The estimates for the fiscal year ending June 30, 1895, for carrying on the Government interests under the charge of the Smithsonian Institution, and forwarded as usual to the Secretary of the Treasury, were as follows:

International exchange	\$23, 000
North American Ethnology	50, 000
National Museum:	
Preservation of collections.....	180, 000
Heating and lighting	15, 000
Furniture and fixtures	20, 000
Postage	500
Galleries.....	8, 000
Steam boilers	4, 000
National Zoological Park.....	75, 000
Astro-physical Observatory	10, 000

BUILDINGS.

The crowding of objects, belonging to the nation, in the halls of the Institution and the Museum building, and in their workrooms, which should be devoted to other purposes, has already been spoken of by me in

previous reports. This condition, which seems to have almost reached a limit of evil from the impossibility of further storage of such objects, was brought to the especial attention of the last Congress, when it became necessary to vacate the storage rooms occupied by the National Museum in the old Armory building on account of intended changes authorized by Congress for the benefit of the Fish Commission.

At this time a small building in the city several squares distant was rented, under authority from Congress, for the storage of the materials, and for the workshops removed from the Armory building, but this made no provision for the articles returned from the Chicago Exposition.

At the request of the Secretary of Agriculture, the Institution, which has been made by Congress the depository of all such objects, felt obliged to resume the care of an immense collection of plants, constituting the National Herbarium, which had previously been placed by the Institution in the charge of that Department, and which it had now, in fact, no room for. The collection was stored, under the charge of the Department of Agriculture, in a building which was not fireproof, and this fact was stated by the Department as influencing it in its request that the Institution should resume charge of them, but the Institution itself has no place to put them, except in sheds more insecure than those from which they came. It is true that room has been made for them within the fireproof portion of the building, but only by the transfer of a large mass of other objects to the wooden sheds, which are in a condition of extreme danger. I can give a no more definite idea of the alarming condition here than by saying that it is such that no insurance company would place risks on the sheds except at very high rates.

The congestion in question has compelled the use not only of rooms belonging to the Museum building proper, for the accommodation of objects like those which came from the Chicago Exposition, but of those of the Institution intended for other purposes, such as the "Chapel," whose lofty vaulted roof was made fireproof by Congress three years ago with quite another destination than the actual use which necessity has imposed for the time.

It seems almost superfluous, after what has just been said, for me to recall in other terms the need of more adequate accommodations for the national collections, but I may again refer to what has been set forth at length on this subject in my previous reports, more especially in that for 1892.

REPAIRS TO THE SMITHSONIAN BUILDING.

In the contemplation of the first architect, the Smithsonian building was intended to produce the effect of a Norman castle, and its tall towers, narrow embrasures, and like features do attain, if not archaeological correctness, at any rate a certain admitted attractiveness of exterior. This has been reached, however, as is well known, not only

at a disproportionate outlay of money from the limited Smithsonian fund (which was here, in fact, expended largely for the benefit of the city in furnishing it with such a picturesque building), but at a cost of an amount of permanent discomfort to the inmates which those who are not there employed can hardly appreciate.

In particular, the narrow windows and the small diamond panes of glass admit so little light that in winter days some of the rooms where clerical work is carried on, need to be artificially lighted, and in all cases the occupants lose the advantage of what ought to be abundant light considering their open surroundings in the middle of a park. I think it well to state that while I should have made many more changes in the interest of the comfort and health of the clerical occupants of the building if I had had the means to do so, I have never felt at liberty to alter the external appearance of the building when alteration could possibly be avoided, and I have therefore never authorized the enlargement of any of the apertures in the stone work, or made any changes of this kind which could be understood as modifying the structural features (except in improving the sanitary conditions of the basement), and when any change is mentioned here it will always be understood that it is essentially the work of the carpenter in providing for larger inside frames and larger lights in the sashes, and in like alterations.

Thus in the east wing of the building, in the fourth story, a room for containing the archives of the Institution has been provided, which is well lighted by one of the few large windows the building possesses, and which has been fitted for more convenient reference to the records of the Institution. The second floor has been made brighter by repainting and by some additional floor lights in the third floor, and the windows in the room especially set apart for the safe-keeping of the engravings and books of art belonging to the Institution have been thus enlarged, while some of the rooms on the second floor have been improved by slight alterations in the window frames. On the first floor additional quarters were provided for the library in the rooms which were vacated by the transfer of the exchange department to the lower floor.

I have been enabled to make the above small changes at the expense of the Smithsonian fund, but a restrictive clause contained in the appropriation act of August 30, 1890, for repairs to the Smithsonian Institution, having been removed by a clause in the sundry civil act for the year ending June 30, 1894, I have, with a portion of the unexpended amount of this appropriation, been also able to transform a suite of dark and damp rooms in the basement on the south side into well-lighted and comfortable, though too limited offices, in which every attention has been paid to sanitation. The exchange bureau continues to occupy these, but they were barely sufficient at first, and, through the constant increase of the demand of the Government service, addi-

tional room for these exchanges will soon be called for, while the storage facilities of the Institution are now otherwise severely taxed.

RESEARCHII.

As I have elsewhere remarked, it appears to be an essential portion of the original scheme of the government of the Institution that its Secretary should be expected to advance knowledge, whether in letters or in science, by personal research; and resolutions of the Regents formally request the Secretary to continue his investigations in physical science, and to present their results for publication in the Smithsonian "Contributions."

The advancement of science through original research at the hands of those eminent men, Henry and Baird, the former Secretaries of this Institution, is known to all, but though the Secretary may be still expected to personally contribute to the advancement of science, or art, or letters, by his individual efforts, it is certain that the increasing demands of time for labors of administration had greatly limited the possibility of this, even in the time of Henry, and that at the present day administrative duties, and especially those connected with the care of Government interests, constitute a barrier to such investigations, which is all but impassable.

I have, however, given such limited time as could be spared from administrative duties largely to the continuation of the researches upon the solar spectrum mentioned in my last report. This work, carried on in the Astro-physical Observatory, is believed to be of more than common importance, and is referred to at more length in connection with the observatory report of this year.

The investigations, referred to in previous reports, upon aerodynamics have been continued intermittently. They are not complete, but they appear to point to conclusions of general and unusual interest.

Mention may also be made here of a grant of \$50 in December, 1893, to the director of the Lick Observatory, Prof. E. S. Holden, for experiments in solar photography, and of a grant of a like amount in May, 1894, to Dr. A. G. Webster, of Clark University, for certain researches in the velocity of electrodynamic disturbances in wires.

Mr. W. A. Eddy was likewise aided to the amount of \$50 in certain experiments in the study of the electrical and other conditions of the upper atmosphere by means of kites.

Investigations aided by the Hodgkins fund, and special researches carried on in the Astro-physical Observatory are mentioned on another page.

The researches referred to above are connected altogether with the physical sciences, since aid to original research in the biological sciences has been largely, though indirectly, provided through the Institution's connection with the National Museum and otherwise.

The subscription has been continued for twenty copies of the Astro-

nomical Journal as a slight aid to its publication, the separate numbers of the journal being sent regularly to foreign libraries and observatories as exchanges of the Institution.

EXPLORATIONS.

The explorations of the Institution during the year have been carried on chiefly through the National Museum and the Bureau of Ethnology. Natural history and ethnological explorations and studies were made in Kashmir, India, the Seychelles and adjacent islands, by Dr. William L. Abbott; by Professor Cook, in Liberia; by Consul-General Crawford, in Finland, and by other collaborators of the Institution in Central and South America and the West Indies, resulting in very valuable additions to the Museum collection. In New Mexico and Arizona, as also in several localities in the Eastern States, archaeological explorations by the Bureau of Ethnology have added much to our knowledge of the habits and customs of the aborigines. The San Juan Valley and the Canyon de Chelly were found to be rich in remains of ancient American structures, indicating a numerous population. Some of the aboriginal songs of the Kiowa, Arapahoe, and Cheyenne Indians were preserved with the aid of the graphophone. I have on other pages reviewed some of these explorations more in detail.

A brief abstract of Mr. Rockhill's explorations in Mongolia and Tibet, in 1891 and 1892, made partly under the auspices of the Institution, was published in the Annual Report for 1892. The detailed diary of his journey is now in the hands of the printer, and will form an octavo volume of about 400 pages, with numerous illustrations. This book is believed to be of particular interest at the present time.

PUBLICATIONS.

One of the most important functions of the Institution is the diffusion of knowledge by means of publications, and in this branch of work the past year has been an active one. Since my last report there have been published by the Smithsonian and its bureaus twelve volumes and eighty-two pamphlets or parts of volumes, aggregating 5,854 printed pages, covering practically every branch of natural and physical science.

The publications of the Institution itself include three principal series—Contributions to Knowledge, the Miscellaneous Collections, and the Annual Reports. The first two are printed at the expense of the Smithsonian fund, while the reports are Government documents.

Contributions to Knowledge.—The Contributions to Knowledge are in quarto form, and are the most important of the series. They include only memoirs of extended original investigations and researches, advancing what are believed to be new truths, and constituting, therefore, positive additions to human knowledge. Twenty-seven volumes of these have been completed since the Institution was founded, including 125 memoirs pertaining to all branches of knowledge.

It is the present practice to publish occasionally memoirs from the Contributions in separate form, to be afterwards combined in a volume when enough have been completed. Only one such memoir of Contributions has been prepared during the year, which is a communication by the Secretary under the title of *The Internal Work of the Wind*.

A volume of the Contributions is now passing through the press, and, though its full description belongs more properly to a later report, it may be stated here that its subject is oceanic ichthyology, that it is prepared by Dr. G. Brown Goode and Dr. Tarleton H. Bean, and that the work, which will be a joint publication of the Institution and the National Museum, is an exhaustive dissertation on the fishes of the ocean depths and particularly those of the North Atlantic Basin.

As another memoir of Contributions, I had hoped to complete the publication of the photographic volume on the moon, to which I have called attention in previous reports, but the science of photography has not yet progressed sufficiently to meet the requirements of the work.

Other memoirs are in preparation, to which attention will be called in my next report.

Miscellaneous Collections.—The Smithsonian Miscellaneous Collections is an octavo series intended to include works of scientific value, but of less original importance than the Contributions to Knowledge.

Thirty-five complete volumes of Collections have been issued since the Institution was founded, and four additional volumes are now in preparation, parts of volumes 35 to 38 having already been published.

Volume xxxv of the Collections will include the Smithsonian Meteorological, Geographical, and Physical Tables. These tables are intended to replace in modernized form and with newer knowledge the Guyot Meteorological and Physical Tables, first published in 1852, and which has since been a standard work of reference for investigators. The first part of the volume, the Meteorological Tables, was published last year. The Geographical Tables, prepared by Professor Woodward, have been put in type during this year, but not yet issued; these tables make a volume of 288 pages. The Physical Tables are now being prepared by Prof. Thomas Gray, and may be expected to be completed in 1895.

Volume xxxvi is a single work, a very comprehensive Select Bibliography of Chemistry, covering the four hundred years from 1492 to 1892, prepared by Dr. H. Carrington Bolton. This volume was published in 1893, but the first edition was soon exhausted, and it became necessary to issue a second edition during the present year.

There is now in progress the preparation of a supplement to this Bibliography of Chemistry, to include titles of works down to 1895, as well as some additions to the first volume. It is expected that the supplement will number about 5,000 titles.

This bibliography actually aims to include everything that is of

importance in the literature of chemistry, the word "Select" being only added as an indication that the work does not profess absolute completeness. It represents the labors of a lifetime on the part of a most industrious student of the bibliography of chemistry, and is a work of reference of such value that it is believed it will be a necessity to every chemical investigator.

Volume XXXVII of the Collections is a very complete Index to the genera and species of the Foraminifera, by Prof. C. Davies Sherborn, of London. The technical character of this work has rendered prompt publication impracticable. The first part of the volume, "A to non," was issued during the year, and the second part is in progress.

Volume XXXVIII of the Collections is also in progress and consists of several short papers, including "Principles and method of classification of varieties of the human species;" "Bibliography of Aceto-Acetic Ester;" "Indexes to literatures of Cerium and Lanthanum," and "Index to literature of Didymium." These indexes to chemical literature are published in continuation of the series begun some years ago under the recommendation of the American Association for the Advancement of Science.

A special octavo volume, now in press, consists of the Diary of a Journey through Mongolia and Tibet, by Mr. W. W. Rockhill. This expedition was carried on in part under the auspices of the Institution, and the diary is, in the main, a description of the characteristic geographical and ethnological features of those countries, so seldom visited by Europeans. A large map, on a scale of 32 miles to the inch, shows the route traversed by Mr. Rockhill, and is in itself a valuable contribution to our knowledge of the region.

Following the usual custom, the several papers comprised in the general appendix of the annual report have been issued separately in pamphlet form; about sixty of these pamphlets were issued during this year, as enumerated in the editor's report.

Smithsonian annual reports.—The delayed annual reports of the Institution for the years 1891 and 1892 have been received and distributed, as also the annual reports of the United States National Museum for those years.

The Secretary's report for 1893 was issued in January in pamphlet form. The manuscript of the general appendix to the report of the Institution for 1893 was sent to the printer on March 31, and the entire volume was stereotyped and press work in progress early in June, thus bringing the work up to date, and avoiding the tedious delays of previous years.

Reports of the Bureau of Ethnology.—The ninth and the tenth annual reports of the Bureau of Ethnology to the Secretary of the Institution have both been received during the year. These volumes fully maintain the character established for the series, and are gradually bringing

up the arrearage of the work. The eleventh and twelfth annual reports are in the hands of the printer and will soon be completed. Several papers in the Bulletin series were issued during the year.

Proceedings and Bulletins of the National Museum.—The publications of the Museum are mentioned on another page under the general head of "The National Museum."

LIBRARY.

In my report for 1887–88 I detailed a plan for increasing the library by exchanges. Lists of periodicals were secured from the British Museum, several universities, and a great number of leading specialists, and these lists were carefully revised in the former year and correspondence then entered upon with each society and journal represented on them. This work has now been completed, after nearly seven years of labor. Since 1887, 5,831 letters have been written, resulting in the addition of 1,853 new periodicals to the list of those received, and entire or partial completion of 1,042 defective series. It is already time to recommence this labor, which ought to be never ending if the periodical collections of the Institution are to continue to be what they are believed to be to-day—the completest in the world. Accordingly it is my intention to have new lists prepared and to continue this special feature of the work of adding to the library by exchange during the coming year.

Through the provision of new quarters for the Bureau of International Exchanges I have been enabled to assign two additional rooms for the use of the library, the one for a collection of books required for reference, and the other as an office for the librarian, to the very great advantage of the service. A room has also been set apart for the collection of prints belonging to the Institution.

The reading room of the Institution is no longer adequate for the large collection of scientific periodicals received and for the persons desiring to consult them. As it is not possible to assign any additional room for the library at present, I am considering a plan for some modifications in the present reading room which will render it more suitable to its purpose.

The total number of publications of every kind received during the past year reached 39,826, an increase of nearly 9,000 over the previous year.

THE HODGKINS FUND.

The many responses to the large number of circulars announcing the terms of the Hodgkins competition, and the numerous requests for further information, have shown that a widespread interest in the subject has been awakened. In February, 1894, a second edition of the circulars announcing the prizes became necessary, which was issued

in English, French, and German, and widely distributed. In answer to numerous inquiries the following supplementary circular, descriptive of the general character and work of the Institution, and making mention of the Hodgkins fund, was also prepared and translated into French and German, and through the courtesy of the Department of State a number of copies were sent to several of the American embassies in Europe for their general use, in answering questions concerning the Smithsonian Institution:

SMITHSONIAN INSTITUTION,

Washington, ———, 189 .

SIR: In answer to your inquiry I am authorized to furnish the following information:

The SMITHSONIAN INSTITUTION was originally constituted by an Act of the National Legislature, to administer a bequest made to the Government of the United States in the early years of the present century. The purpose of the bequest was declared to be "The increase and diffusion of knowledge among men," and its acceptance by the nation is the only instance of such an action in its history. The Institution, then, occupies a peculiar relation to the Government. It is composed as follows:

MEMBERS OF THE INSTITUTION.

PRESIDING OFFICER (*ex-officio*): The PRESIDENT OF THE UNITED STATES.

Chancellor: The Chief Justice of the United States.

The Vice-President of the United States.

The Secretary of State.

The Secretary of the Treasury.

The Secretary of War.

The Secretary of the Navy.

The Postmaster-General.

The Attorney-General.

The Secretary of the Interior.

The Secretary of Agriculture.

The high functionaries above mentioned are its members *ex officio*, with the exception of the chancellor, who is elected. The law also creates a secretary of the above body, whom it calls "the Secretary of the Institution."

ADMINISTRATION.

The law further directs that the business of the Institution shall be managed by a Board of Regents, composed of the Vice-President and the Chief Justice of the United States, three Senators, three members of the House of Representatives, and six other eminent persons nominated by a joint resolution of the Senate and the House of Representatives.

The Secretary of the Institution is also the Secretary of the Board of Regents and their principal executive officer. His duties in this regard are analogous to those of a Director. All correspondence should be addressed to him.

It will be observed that the immediate and primary object of the Smithsonian Institution, as above constituted, is to administer a

certain fund, of which the United States has accepted the custody, for the especial purpose of "the increase and diffusion of knowledge among men," so that its purpose in its most general sense is not limited to the people of the United States of America, but extends to all mankind. This has been interpreted as indicating such a direction of the activities of the Institution as shall result—

(1) In the increase of knowledge by original investigation and study, either in science or literature.

(2) In the diffusion of this knowledge by publication, not only through the United States, but everywhere, and especially by promoting an interchange of thought among those prominent in learning among all nations, through its correspondents. These embrace institutions or societies conspicuous in art, science, or literature throughout the world.

Its publications are in three principal issues, namely: The "Contributions to Knowledge," the "Miscellaneous Collections," and the "Annual Report." Numerous works are published annually by it, under one of these forms, and distributed to its principal correspondents, while there is also published, at the expense of the Government, an edition of the Report of the Board of Regents, containing an account of the operations of the Institution during each year, which is distributed throughout the country by the Congress.

The Institution has been authorized by law to deposit its original fund in the Treasury of the United States, and it has further been authorized to accept certain special bequests made by individuals, where these have been such as to promote its general purpose, "The increase and diffusion of knowledge among men." Thus, for example, the Institution has accepted and administered a fund which, under the name of the donor, is called "The Hodgkins fund," and which is given for the especial purpose of "The increase and diffusion of more exact knowledge in regard to the nature and properties of atmospheric air in connection with the welfare of man;" this fund is also deposited in the Treasury of the United States. Other donations have been received and are administered for other specific purposes.

The seat of the Institution is at Washington, but its activities reach throughout the world in various ways, and principally through the system of correspondence already referred to. The present number of correspondents is about 24,000, and by means of this system the Institution not only gives, but receives, communications from men of learning in all countries.

In this and other ways it has gathered at Washington a special library of books bearing upon the history of arts, sciences, discoveries, and inventions. The library now includes 300,000 titles, the greater proportion of which is by permission of Congress deposited in the same building and accessible with the National Library.

Besides the above activities, which are carried on with the special fund already referred to, of which the nation has consented to act as the guardian, there are certain bureaus or divisions of the Government which the legislature has placed in its especial charge, and for the cost of which Congress has, at different times, made special appropriations. In this way it has placed under the charge of the Institution the United States National Museum, the Bureau of International Exchanges, the Bureau of Ethnology, the National Zoological Park, and the Astrophysical Observatory. These also are administered by the Secretary,

under the direction of the Board of Regents. The present Secretary of the Institution is S. P. Langley, to whom all communications should be addressed, at Washington.*

Assistant in Charge of Office.

In spite of the persistent effort to reach all who might be interested, or who might wish to contribute to the competition, it was found that in so wide a distribution the circulars had, in various instances, failed to reach those for whom they were intended. This fact led to the extension of the competition from July 1 to December 31, 1894. A circular letter announcing this change of date, and offering to return, at the expense of the Institution, papers which had been already submitted, was issued in June, 1894, and mailed to all competitors, besides

* This circular was also printed in French as follows:

MONSIEUR: J'ai eu l'honneur de recevoir votre lettre et je suis autorisé à vous donner les renseignements qui suivent:

L'INSTITUT SMITHSONIEN a été, à l'origine, créé par une loi du Parlement Fédéral dans le but de gérer un legs fait au Gouvernement des États-Unis dans les premières années de ce siècle. L'objet du legs, d'après la déclaration qui en était faite, était "le développement et la propagation du savoir parmi les hommes," et lorsque la Nation l'accepta, elle donna le seul exemple de ce genre qui se puisse trouver dans son histoire. Les relations de l'Institut avec le Gouvernement sont donc d'une nature toute spéciale.

Il est constitué de la façon suivante:

MEMBRES DE L'INSTITUT.

PRÉSIDENT (*d'office*) LE PRÉSIDENT DES ÉTATS-UNIS.
 Chancelier: Le Président de la Cour Suprême des États-Unis.
 Le Vice-Président des États-Unis.
 Le Secrétaire d'État.
 Le Secrétaire du Trésor.
 Le Secrétaire de la Guerre.
 Le Secrétaire de la Marine.
 Le Ministre des Postes.
 Le Ministre de la Justice.
 Le Secrétaire de l'Intérieur.
 Le Secrétaire de l'Agriculture.

Les hauts fonctionnaires susnommés sont membres d'office de l'Institut, à l'exception du Chancelier qui est élu.

La loi pourvoit l'Institut d'un Secrétaire Perpétuel; il a le titre de "Secretary of the Institution."

ADMINISTRATION.

La loi dispose en outre que les affaires de l'Institut seront gérées par un Conseil d'Administration dont font partie le Vice-Président des États-Unis, le Président de la Cour Suprême, trois Sénateurs, trois membres de la Chambre des Députés, et six autres personnes éminentes, nommées par un ordre du jour voté conjointement par les deux Chambres.

Le Secrétaire Perpétuel de l'Institut est également Secrétaire du Conseil d'Administration, dont il est le principal représentant exécutif. Ses fonctions à cet égard sont analogues à celles de Directeur-Général. C'est à lui que doit être adressée toute la correspondance.

Comme on le voit, l'objet immédiat de l'Institut Smithsonian, constitué ainsi qu'il vient d'être dit, est de gérer un certain fonds dont les États-Unis ont accepté la garde et qui doit être spécialement appliqué "au développement et à la propagation du savoir parmi les hommes," de sorte que cette destination, prise dans son sens le plus général, n'est pas réduite au public des États-Unis mais s'étend au monde entier.

L'interprétation qui lui a été donnée est que l'Institut doit poursuivre ses efforts dans telle direction qui produirait comme résultat:

1. Le développement des connaissances humaines, soit dans les sciences ou dans les lettres, par des travaux originaux de recherches et d'études.
2. La propagation de ces connaissances par des publications répandues non seulement dans les États-Unis, mais en tous lieux, et surtout en encourageant parmi les savants de marque dans toutes les nations, un échange intellectuel, par l'intermédiaire de ses correspondants qui se comptent parmi les institutions ou sociétés principales dans les arts, les sciences ou les lettres, dans le monde.

Ses publications affectent trois formes principales, à savoir: "The Contributions to Knowledge" (Les Apports au Savoir), les "Miscellaneous Collections" (Collections Variées) et l'"Annual Report" (le Compte Rendu Annuel). Sous une de ces trois formes, l'Institut publie chaque année de nombreux ouvrages qu'il distribue à ses principaux correspondants. Cependant, une édition du Rapport du Conseil d'Administration, donnant un compte rendu des opérations de l'Institut dans le courant de chaque année, est aussi publiée aux frais du Gouvernement et répandue dans le pays par les soins du Congrès.

L'Institut a reçu de la loi l'autorisation de déposer le fonds originel au Trésor des États-Unis et il a été en outre autorisé à accepter certains legs spéciaux, faits par des personnes privées, lorsque ces

being published in several of the leading scientific journals of this country and Europe.*

Up to June 30, 1894, 259 memoirs, printed and manuscript, have been received in connection with the competition, representing correspondents in the United States, Mexico, England, Scotland, Norway, Denmark, Russia (including Finland), France, Belgium, Germany, Austria-Hungary, Servia, Italy, and British India.

legs sont de nature à l'aider dans sa mission générale: "le développement et la propagation du savoir parmi les hommes." C'est ainsi, par exemple, que l'Institut a accepté et géré un fonds qui, du nom de son donateur, est appelé "le fonds Hodgkins" et qui a été donné expressément pour favoriser "le développement et la propagation d'une connaissance plus précise sur le sujet de la nature et des propriétés de l'air atmosphérique par rapport au bien être humain," somme qui est également déposée au Trésor. D'autres dons ont été acceptés et sont gérés pour être affectés à d'autres objets spécifiques.

Le siège de l'Institut est à Washington, mais sa sphère d'action s'étend en dehors des États-Unis de diverses façons, et surtout au moyen du système de correspondance, dont il a été parlé plus haut. Le nombre des correspondants s'élève actuellement à 24,000 environ et lui permet non seulement de donner, mais encore de recevoir des communications des hommes de savoir de tous les pays.

Par ce moyen et par d'autres encore, l'Institut a réuni à Washington, une bibliothèque spéciale de livres traitant de l'histoire des arts, des sciences, des découvertes et des inventions. Elle comprend 300,000 ouvrages, dont la plus grande partie a été, par permission du Congrès, déposée à la Bibliothèque Nationale, où ils peuvent être consultés avec les autres richesses de la Bibliothèque.

En dehors de cette sphère d'action dont les moyens lui sont fournis par les fonds particuliers en question et dont le Gouvernement a bien voulu assumer la tutelle, l'Institut a été spécialement commis par la Législature à la charge de certains départements ou certaines divisions du Gouvernement, pour le maintien desquels le Congrès a, de temps à autre, voté des crédits spéciaux. C'est ainsi qu'ont été placés sous la direction de l'Institut, le Musée des États-Unis, le Département des Échanges Internationaux, le Département d'Ethnologie, le Parc National de Zoologie, et l'Observatoire Astro-physique.

Tous ces établissements sont dirigés par le Secrétaire Perpétuel sous le contrôle du Conseil d'Administration. Le Secrétaire actuel est Mr. S. P. Langley, à qui devront être adressées, à Washington, toutes communications.

* SMITHSONIAN INSTITUTION.

HODGKINS PRIZES.

WASHINGTON, —, 1894.

DEAR SIR: I beg leave to inform you that the time within which papers may be submitted in competition for the Hodgkins fund prizes of the Smithsonian Institution, for essays in regard to the nature or properties of atmospheric air, has been extended from July 1 to December 31, 1894. This action has been taken for the reason that many of the circulars seem to have failed to reach the persons for whom they were intended.

In order that all competitors may have the advantage of this extension of time, the Institution will, upon request, take pleasure in returning papers already submitted; all papers being subject to the general condition requiring delivery in Washington City before January 1, 1895.

It is preferred that the name and address of each competitor be attached to the manuscript; it is permitted, however, that anyone who desires it may send his name and address in such a form that they can be detached from the manuscript, which he may identify by means of a motto.

The manuscripts of unsuccessful candidates will be returned, if desired; but the proprietorship of papers to which one of the prizes has been awarded will rest with the Institution, which only desires to give them a wide publicity; and no copyright privileges are in this case to be expected by the author.

Papers which have been already published will not be accepted in competition for the prizes, but may be eligible for the medal. This medal will be awarded in the same way that medals are usually awarded by the principal scientific societies, the medalists being chosen from all investigators known to the committee of award and not necessarily from those alone who have submitted papers.

It is requested that all packages, manuscript or printed, intended for competition be marked "Hodgkins competition" upon the outside of the wrapper, and be addressed to Mr. S. P. Langley, Secretary of the Smithsonian Institution, Washington City, U. S. A.

Very respectfully,

S. P. LANGLEY,
Secretary.

The work of the advisory committee has been going on systematically during the year; papers have been read and passed upon, and many applications for grants considered.

Prof. E. W. Morley's work on the determinations of the density of oxygen and hydrogen, referred to in previous reports as aided by special apparatus provided by the Institution, is approaching completion.

The investigations undertaken by Dr. J. S. Billings and Dr. S. Weir Mitchell into the nature of the peculiar substances of organic origin contained in the air expired by human beings, to which reference was made in my last report, is still continued under a grant from the Hodgkins fund, as also are the researches by Dr. O. Lummer and Dr. E. Pringsheim, of Berlin University, on the determination of an exact measure of the cooling of gases while expanding, with a view to revising the value of that most important constant which is technically termed the "gamma" function.

The limitations of the fund have, however, rendered it necessary, with slight exceptions, to postpone further action in this direction for the present, although it is hoped that it will prove practicable at a later date to aid certain important researches to which attention has been invited.

CORRESPONDENCE.

It is difficult to convey an adequate idea of the diversity of the nature of the correspondence carried on immediately in the Secretary's office. Without reference to the voluminous correspondence of the National Museum, or the special correspondence of the Bureau of Ethnology, the Zoological Park, and the Bureau of Exchanges, constant inquiries are received from all parts of the country for information on almost every conceivable topic, and requests for statistics and for information on the most varying scientific subjects. This correspondence all receives careful attention, and, as a part of the aim of the Institution in the "diffusion of knowledge," an effort is made to give a full reply to all such inquiries, often involving an amount of labor on the part of the curators, as well as of those more immediately occupied with the correspondence of the Institution, out of proportion to the merits of the case.

I desire to remark that this increase of correspondence, even if that upon the business of subordinate Government bureaus alone is considered, calls constantly for more clerical aid and other expenses which there is no appropriation for, and which practically form an added burden on the limited Smithsonian fund, which it ought not to bear, and to refer in this connection to what is said under "Administration."

The entries in the registry book of letters received during the year number 3,652, but these are only the relatively important letters.

The general card index to all the correspondence in the Secretary's office, which was begun on January 1, 1893, is kept up constantly to date,

and has been extended back to include all letters written or received since January 1, 1892.

All correspondence prior to this current correspondence file has been placed in the archives, and the letters that have been received between 1882 and 1890 have recently been bound and indexed, completing the series of indexes to correspondence.

Reports, memoranda, and data collected on various subjects not properly belonging to the correspondence are preserved in a miscellaneous file and properly indexed.

MISCELLANEOUS.

The Naples table.—The anticipations in regard to the Naples table, which, as I have stated in the report for 1893, has been leased for a period of three years upon the petition of the biologists and universities of the United States, have been apparently justified.

Numerous applications for the occupancy of the table have been received and considered. The following, being favorably reported by the advisory committee, were approved by me for the present year:

Mr. D. G. Fairchild, United States Department of Agriculture, received the appointment for October, November, and December, 1893.

Dr. W. M. Wheeler, University of Chicago, was appointed for January, February, and March, 1894.

Dr. H. C. Bumpus, Brown University, appointed for February, March, and April, 1894.

Prof. Lewis Murbach received an assignment of three months, beginning June 20, 1894.

Desiring to give to all investigators an equal opportunity to avail themselves of the advantage of a seat at the Smithsonian table, it has been decided that final action upon an application may not be taken more than six months in advance of the date for which the table is desired, and that should more than one application be filed for the same period, in cases of presumably equal merit, the assignment shall be made according to priority of application. It has also been determined that no appointment shall be made for a period of more than six months, although an occupant may apply for extension of time or for reappointment at some future date.

Students who are appointed to the table for the full term of six months are desired to report to me at the close of each three months of their occupancy; those appointed for a shorter period are expected to make such report at the close of their assignment.

In several instances the time desired by an applicant overlaps that of another, as is the case in February and March of 1894, but through the ready courtesy of Dr. Dohrn, director of the station, who kindly offered to arrange for the accommodation of more than one occupant of the table at the same time, it has thus far been found possible to make the appointments without disappointing a student on this account.

With a view to profiting by the judgment of our representative biologists in administering the affairs of the Naples table, I requested, at an early date, the president of the National Academy of Sciences, the president of the Society of American Naturalists, the president of the American Morphological Society, and the president of the Association of American Anatomists to nominate each one member of an advisory committee, the personnel of which is as follows, I having designated Doctor Billings, as chairman, and Doctor Stiles, as secretary of the committee:

Advisory committee, Naples table.—Dr. J. S. Billings, U. S. A., director of the United States Army Medical Museum, chairman; Dr. E. B. Wilson, professor of zoology, Columbia University; Dr. J. A. Ryder, professor of embryology, University of Pennsylvania; Dr. C. W. Stiles, zoologist, United States Department of Agriculture, secretary.

I am indebted to this committee for valuable aid in examining the testimonials accompanying applications for the occupancy of the table and for recommendations with regard to appointments, as well as for the consideration of the various questions in connection with the assignment of the table, to which I have asked attention. The contract giving to the Institution the tenure of the Naples table for the term of three years was given in full in my last year's report.

Seal of the Institution.—A suitable steel die has been prepared for the new seal of the Institution, designed by Augustus St. Gaudens, and formally adopted by the Board of Regents at their meeting of January 25, 1893, and the new seal has been affixed, when required, to formal papers since February, 1894, though the first use of the design was upon the circulars concerning the Hodgkins prizes, issued under date of March 31, 1893.

The World's Columbian Exposition.—The display made by the Smithsonian Institution, including the National Museum and the Bureau of Ethnology, embraced collections prepared by the following departments of the Museum: Ethnology, physical geology, mammals, birds, reptiles, fishes, insects, marine invertebrates, comparative anatomy, minerals, prehistoric anthropology, historical collections, a collection of objects illustrating religious ceremonial, graphic arts, musical instruments, animal products, and a special exhibit of domesticated animals. In addition, an exhibit illustrating methods of aboriginal quarrying was prepared by Mr. William H. Holmes, a display of Japanese potteries was installed by Mr. Hieromich Shugio, and an exhibit of early electrical apparatus, employed by Prof. Joseph Henry in his experiments which led to the discovery of the electric telegraph, was also prepared. Complete sets of the publications of the Smithsonian Institution and of the National Museum were exhibited, together with those of the American Historical Association.

These collections are fully described in the report for 1893 of the

Assistant Secretary, who acted as the representative of the Institution upon that occasion. It is only necessary to add here that the exhibit proved exceedingly attractive to the visitors, as evidenced by the crowding of the space from the opening to the closing day, and by the numerous favorable notices published in the newspapers and periodicals of the country.

A considerable number of the staff of the Institution served as judges of award in connection with the several scientific juries of the Exposition.

The Exposition closed on October 31, and the reshipment of the exhibits to Washington was immediately commenced.

At the close of the Exposition several interesting collections were presented to the Institution by foreign Governments and by individuals which it has been difficult to provide room for.

In this connection I desire to call especial attention to the regrettable fact that many exhibits that might have been secured for the National Museum, without expense to the Government, went elsewhere, as no provision could be made here for their exhibition in the already overcrowded condition of the Museum building.

Delegates to universities and learned societies.—The Smithsonian Institution is not infrequently invited to send representatives to special celebrations instituted by learned societies or universities with which it is in correspondence, both in this country and abroad. Whenever practicable, special delegates have been designated by the Secretary to represent the Institution on such occasions.

Dr. Paul Haupt, of Johns Hopkins University and curator of oriental antiquities in the National Museum, was appointed as Smithsonian representative at the Tenth International Congress of Orientalists to be held in Geneva, September 3 to 12, 1894.

Woodcuts, etc.—A room on the third floor of the Smithsonian building has been set apart for the storage of several thousand original woodcuts, copperplates, and photo engraved blocks used in illustration of the publications of the Institution and National Museum. These blocks, which have now been marked and catalogued and arranged for ready reference, are frequently asked for by publishers, and it has been the policy of the Institution to allow their use for reproduction and publication at the mere cost of electrotyping.

The expense of handling and storage of the collection of stereotype plates of the different series of publications has become so great, and the plates are so rarely called for, that it has been determined to discontinue the preparation of the plates except when their future use can be distinctly foreseen. From past experience it is thought that the saving of the original cost of electrotyping will more than meet the expense of reproducing any papers for which the future may bring special demands,

Archives.—A room on the fourth floor, about 20 by 22 feet, in the east wing of the Smithsonian building, has been specially fitted up for the arrangement of the valuable and somewhat voluminous archives of the Institution, in a form where they can be most readily consulted. Twenty-nine cases of shelves and sets of drawers are already largely filled with volumes of letters received and press copies of letters sent, with indexes, drawings, diagrams, photographs, and plans of the buildings and grounds, original records of proceedings of the Board of Regents, a full set of the publications of the Institution, copies of original papers by the Secretaries of the Institution, etc., and space has been provided for the anticipated wants of several years to come.

Considerable progress has been made in the classification and indexing of these papers under the new arrangement.

Assignment of rooms.—A room in the basement of the east wing, which has been specially fitted up with piers for pendulum experiments, and connected by telegraph, through the Western Union Telegraph Company's office, with the United States Naval Observatory, is still reserved for the occasional use of the officers of the United States Coast and Geodetic Survey.

Toner lecture fund.—In 1872 Dr. J. M. Toner, of Washington, conveyed about \$3,000 in real and personal property to five trustees, consisting of the Secretary of the Smithsonian Institution, the Surgeon-General of the United States Army, the Surgeon-General of the Navy, the president of the Medical Society of the District of Columbia, instituting thereby "The Toner lecture fund." Ninety per cent of the interest of the fund is to be applied for at least two annual memoirs or essays by different individuals relative to some branch of medical science, to be read in the city of Washington, under the name of "The Toner lectures, each of these memoirs or lectures to contain some new truth fully established by experiment or observation."

As these lectures are intended to increase and diffuse knowledge, several of them have been accepted for publication in the Smithsonian Miscellaneous Collections. The first of the course was by Dr. J. J. Woodward, "On the structure of cancerous tumors," and was printed in 1873. Nine other lectures, by Dr. C. E. Brown-Sequard, Dr. J. M. Da Costa, Dr. W. Adams, Dr. E. O. Shakespeare, Dr. G. E. Waring, jr., Dr. C. K. Mills, and Dr. Harrison Allen, have since been published by the Institution, the last having appeared in 1890.

The Hamilton fund.—In 1874 the Institution received \$1,000 from the estate of James Hamilton, esq., of Carlisle, Pa., bequeathed in the following clause of his will:

I give \$1,000 to the Board of Regents of the Smithsonian Institution, located at Washington, D. C., to be invested by said Regents in some safe fund, and the interest to be appropriated biennially by the secretaries, either in money or a medal, for such contribution, paper, or lecture on any scientific or useful subject, as said secretaries may approve,

Under resolution of the Regents the bequest was deposited in the Treasury on the same terms as the original Smithsonian bequest. In administering the trust the income has thus far been only partially used, but allowed to accumulate, the annual interest not being yet sufficient to bear the expense attendant on the designing and striking of a proper medal.

Statue of Secretary Baird.—In my report for 1892 I called attention to a bill introduced in the Senate by Mr. Morrill to provide for the erection of a bronze statue of Professor Baird in the grounds of the Institution. The failure of the passage of this bill was a disappointment to the friends of the Institution, and I sincerely hope that Congress may consent to make an appropriation suitable for such a memorial.

American Historical Association.—The manuscript of the annual report of the American Historical Association for the year 1893 was transmitted to Congress on March 3, 1894. This is the fifth annual report and consists chiefly of papers read at the Historical Congress at Chicago in July, 1893. The association has no official relation to the Institution further than that its annual reports are transmitted to Congress through the Secretary of the Smithsonian Institution, as required by its incorporation act. The reports are Congressional documents, and the Institution has no control of their distribution. The association prints a special edition of the reports at its own expense and distributes them to the State historical societies and to a number of foreign institutions and libraries. Under authority granted by Congress in the act approved January 4, 1889, a storage room has been assigned in the National Museum for the publications of the association, and in the fire-proof vaults of the Institution the association has temporarily deposited a valuable collection of manuscript records pertaining to the early history of the telegraph.

THE NATIONAL MUSEUM.

In previous reports I have felt called upon to insist upon three things in regard to the Museum: First, that the collections are increasing so rapidly that unless additional space is provided for their proper administration and exhibition its efficiency will be greatly impaired; secondly, that the collections, although growing rapidly in certain directions, are not increasing as symmetrically and consistently as is manifestly desirable.

The third point which I desire to emphasize, and to introduce before the others, has reference to the most undesirable and dangerous necessity of storing collections, which can not, for lack of space, be placed on exhibition, in the wooden sheds south of the Smithsonian building and in the basement of the building itself. The storage sheds them-

selves are merely temporary structures, neither fireproof nor entirely safe in other particulars, and these are not only so crowded that they can hold no more, but their use has thus been perverted from the purposes for which they were built, i. e., for temporary workshops, and as packing and unpacking rooms. So great, however, has been the necessity of economizing all available space, and of finding some place for the storage of specimens preserved in dilute alcohol, that the Museum has been compelled to use the sheds for inflammable material for which there is no room elsewhere. In the basement of the building itself are large alcoholic collections in bottles containing, in the bulk, many thousands of gallons of alcohol. These last specimens are not on exhibition, but for want of space are stored immediately under the large exhibition halls of the Smithsonian building.

I have the assurance of experts that a fire communicated to these rooms would sweep through the entire length of the building, and although the building itself is fireproof as against any ordinary danger, it may well be doubted whether any of the collections therein exhibited can be regarded as safe, if the rooms immediately below should be exposed to so peculiarly severe a conflagration as would be caused by the ignition of these large quantities of inflammable material. Besides this, these wooden sheds, which (as I have already intimated) are used not only for storerooms, but for workshops, for the preservation of specimens, and also as sheds for the carpenters, are likewise liable to cause serious losses, should a fire be kindled in any of them, and all of these, I repeat, are immediately under the windows of the Smithsonian building.

In a report recently submitted by one of the inspectors of the Association of Fire Underwriters, in response to a request from me for a statement as to what insurance rates would be fixed upon the sheds in question, the Smithsonian building is referred to as an undesirable risk, owing solely to the presence of all this inflammable material underneath and in the adjoining sheds, on which latter insurance can not be placed for less than \$40 per \$1,000. This is, I am informed, nearly ten times the rate which would be charged on an ordinary warehouse. The chief danger, however, is not to the sheds themselves or their contents, but to the adjoining collections which, without reference to their scientific interest but merely to their intrinsic value, represent a very large sum of money.

I repeat that this condition of affairs is one which urgently demands immediate relief, and with this unreserved expression of my opinion it seems to me that I have said all that I can.

Apart from the dangers incurred by the storage of inflammable material in and adjoining the Smithsonian building, the Museum is still confronted with the problem of caring for the numerous collections which can not be now exhibited, and which, as I have shown, are at

the present time massed together in sheds and basements. During the past year the disadvantages to the Museum, which have grown out of this state of affairs, have been especially apparent. Very many valuable collections which were brought to Chicago by foreign governments for exhibition at the World's Fair would have been offered to the National Museum had not the fact been so generally known that they could not be properly accommodated in Washington. The few collections which were acquired by the Museum at the close of the Exposition, though not of very great bulk, were exceedingly valuable, but it must be said that the care of even these has largely increased the congestion and has been the cause of considerable additional embarrassment. I may add that everything that it is possible to do has already been done in the way of rearranging the collections, with a view to economizing space, and of withdrawing from the exhibition series objects which could best be spared from the halls.

I now recur to the other topics of importance connected with the Museum.

The Museum in its present condition is by no means advantageously arranged, with regard either to the general interests of the Institution or to its own importance, owing in part to the fact that some of the collections, under the pressure of overcrowded conditions, now occupy halls which were intended for quite other purposes, such as the so-called "Chapel" in the Smithsonian building, or which are unsuitable for the exhibition of specimens, as is indeed the whole of the lower hall in the Smithsonian building. Still more unfortunate is it that it is impossible to install different departments in halls by themselves. In the Museum building, in many instances, widely distinct collections are of necessity exhibited in the same hall, and an appearance of confusion and lack of system, which is much to be deprecated, results.

There is probably no museum in the world in which so small a proportion of the objects worthy of exhibition are visible to the public, and in which the objects exhibited are crowded together so closely. This crowding, indeed, has of necessity been carried to such an extent in many of the halls that there is no space to pass between the cases, except along a few principal aisles, and the storage rooms already contain, mounted and labeled for exhibition, enough material to fill several halls more. It is no exaggeration to say that if there were another building as large as the present one it could within a very short time be filled with specimens already here, and that the two buildings together would seem as fully occupied as do now the buildings of most other museums.

I earnestly call attention to the proper inference from these statements, which is, not that one building can be made, or is being made, to do the work of two, but that the one building in question is almost ceasing to fulfill its proper function, and tends more and more to the condition of a warehouse, to the detriment of its proper museum uses,

In order to relieve in some slight degree this increasing crowding of of the halls, I have for some years asked for an appropriation for the erection of galleries in two or more of the halls in the Museum building. Such galleries were provided for in the original plan of the building, and they may be supported in such a manner as not to detract from the appearance of the halls or to interfere with the installation of the collections. They would afford very material relief in the matter of exhibition and indirectly in that of storage.

There has been but little effort to increase the bulk of the collections although, as in previous years, no opportunity has been spared to increase the completeness and scientific value of the series in several departments by the addition of special desiderata. Notwithstanding this fact, the increment from legitimate sources, especially from the various Departments of the Government, which are required by law to deposit their accumulations here, has been more than 171,000 specimens. This total, although double that of the previous year, was far below that for 1892, when 260,000 specimens were added to the collections, and not very much greater than that for 1891. The falling off in 1893 was due to the fact that the entire activities of the Museum staff were devoted to preparations for the World's Fair, and that a large number of the correspondents of the Institution, as well as other persons to whom the annual increase is ordinarily due, were also occupied in the same way. A certain proportion of the accessions in 1894 were acquired at the close of the World's Fair in Chicago. These were almost without exception collections which had been prepared by foreign exhibitors with the Smithsonian Institution in mind as the ultimate place of deposit, and which were sent here at the close of the exposition.

It would have been possible to have obtained an immense number of specimens on this occasion, but it was deemed proper to refrain from efforts in this direction, not only because of the considerations just referred to, but also on account of the desire of the people of Chicago to retain such objects in their own city as a beginning toward a great civic museum which might serve as a permanent memorial of the World's Columbian Exposition. It has always been the policy of the Smithsonian Institution to encourage the development of such institutions throughout the United States, and to assist in developing them, and on this account many proffers of specimens were declined, with the recommendation that they be offered to the Chicago Museum, and so far as it was possible to do so, the attention of exhibitors who had collections to dispose of, was directed toward that institution.

A careful approximation of the number of specimens now contained in the various departments of the Museum shows that the total is about three and one-quarter millions, almost all of which have been acquired by gift, in exchange for other specimens, or as an equivalent for publications.

Notwithstanding the unsymmetrical growth of the Museum, to which I have already alluded, there are some very encouraging features in connection with the increase of the collections. Every day numerous specimens are contributed by persons who have either visited the Museum and wish to testify their sympathy with its work, or have become interested through its publications or by correspondence.

Not a few collections of great value have been given at various times, such as the George Catlin Indian Gallery, the Lea Collection of Minerals and Shells, the Bendire and Ralph Collections of Birds' Eggs, the Lacoë Collection of Fossil Plants, and the Collection of the American Institute of Mining Engineers, which latter was transferred at the close of the Philadelphia Centennial Exhibition.

Since the accessions are almost entirely gifts, it is manifestly impossible that the Museum collections should grow symmetrically. A large proportion of the annual accessions are not sufficiently valuable to be added to either the study or exhibition series. They are all useful, however, in connection with the preparation of duplicate sets for distribution to educational institutions. The distribution of duplicate material has been continued, and more than twenty-seven thousand specimens, consisting principally of marine invertebrates, rocks, minerals, fishes, and casts of prehistoric implements, have been transmitted during the year to other museums, colleges, and normal schools.

The report of the Assistant Secretary, in charge of the National Museum, contains a list by groups of the material distributed, as well as a geographical statement of the institutions supplied. The same report also includes a list of the distributions of material made during the last thirty-five years.

I have found it quite impossible to comply with all the applications for specimens from universities, colleges, and other museums; nor can this be done until Congress shall appropriate a sum of money sufficient to render possible the employment of competent persons who, under the supervision of the curators, can devote their time to separating the duplicates in the various collections, and arranging them into sets for distribution.

I may assume that it is the intention of Congress that the National Museum of the United States shall be, so far as a museum can be, a worthy exponent of the natural resources and scientific achievements of the nation; that it shall be worthy the attention of visitors to the capital; that it shall perform its proper functions as one of the scientific departments of the Government, and shall also promote the scientific and educational interests of the country at large.

It seems worthy of note, then, that while in almost all the largest cities of Europe, including London, Paris, Berlin, St. Petersburg, Vienna, and Florence, the national collections are exhibited in groups of buildings, here in Washington all similar collections are brought together under the roofs of the Smithsonian and National Museum

buildings and the Army Medical Museum building. The practice which has so largely obtained abroad in this respect is for many reasons unfortunate, since much labor is duplicated and collections of similar character are found growing up in different parts of the same city. It has, however, its advantages, for where the national collections are exhibited in a group of museums, each would have its own space, and there would be employed in each building a staff as large as that which is here concerned in the administration of the whole.

The National Museum will surely in time at least equal in size and importance the museums of similar character in any of the national capitals in Europe. Now is the time for obtaining many kinds of objects such as it will be impossible to obtain after the country has become more thoroughly settled, when its natural features and its large animals will have been destroyed, and its aboriginal inhabitants deprived of their race characteristics. The time is rapidly approaching when many desirable objects can no longer be obtained, and it is a matter of deep regret that valuable collections are being constantly exported to the Old World museums, which are able to pay for them prices absolutely beyond the reach of any American institution, and I repeat my statement of the regrettable fact that not only the American student must leave America to study some important branches of the history of native American races, but that the national collections are relatively falling still further backward in this regard, as compared with those of many other nations.

It is not advisable, therefore, to check the current of accessions, for each year a very large number of objects are procured without cost, which in a few years can not be secured at any price.

The fact that the Museum is embarrassed for lack of space and for lack of means to secure a more symmetrical development of the collections, renders it all the more necessary that an efficient staff of curators should be constantly at work, in order to preserve the material already here and that which is constantly coming in—this, indeed, being their first duty. It is also desirable that they should continue, by scientific study and by publication, to develop the facts which are essential to the correct understanding of the material, and that the collections should be arranged and classified in such a manner as to be immediately accessible to the students of science from all parts of the country and from abroad, who are constantly visiting Washington for the purpose of consulting these collections in connection with their own scientific studies.

The scientific staff is, in my judgment, as effective a one as can possibly be expected under its present condition. It is unfortunate, however, that so many of the men in charge of the departments should be volunteers, without compensation, a system which is found advantageous to a limited extent only. With only this aid from specialists, not even connected with the Museum, it is impossible for the curators

and their assistants to perform the urgent work of their departments. In a degree, this is attributable to the growing frequency of the demand of educational institutions and the outside public upon the staff for information and aid. For the safe-keeping of the collections, whose increase in value has rendered the responsibility of custody much greater, the force of watchmen should also be increased, while to insure proper cleanliness of the floors and cases, a larger number of laborers and cleaners should be employed than is possible with the appropriation of the present year. It is hoped, then, that the appropriation for the preservation of collections may be restored to at least the amount at which it stood when the reduction was made in 1893; though even this sum, as I have attempted to show in my letters year by year accompanying the estimates, is far below what is needed for efficient work.

It is also hoped that the appropriation for furniture and fixtures, which has been considerably decreased of late years, may be made larger, since the crowding of the exhibition halls renders it necessary to reconstruct many old cases and to build new ones in places hitherto unoccupied, because they have been thought hardly suitable for exhibition, but to the use of which the administration is now driven.

It should be borne in mind also that there is constant expense for the repair and renovation of the cases already on hand, which yearly suffer considerable damage from the throngs of visitors. The necessity for repair and renovation of the building is yearly becoming greater as it grows older, and there being no special provision to meet such expense, its cost is of necessity, and by direction of the Treasury authorities, paid from the appropriation for "cases, furniture, fixtures, and appliances required for the exhibition and safe-keeping of the collections."

The necessity of a more liberal allowance by Congress for printing the publications of the Museum still increases. The editions are far too small to admit of placing complete sets in the libraries of each college, university, scientific school, normal school, and scientific society in the United States—which I deem of the highest importance—as well as in every State library, and every local library of importance, as indicated upon the provisional list which was published as Appendix D in the report of the assistant secretary for 1889. In addition to these institutions it is desired to send our publications to every national library abroad, as well as to every great library, university, or academy of sciences which has a center of scientific activity. In return for the publications distributed to foreign libraries there is obtained in exchange for the Museum library a large number of scientific publications of the greatest value, many of which it is impossible to buy, and which, if purchasable, would require annually a large expenditure of money. On account of the present small editions, the Museum is unfortunately unable to send sets to many scientific institutions from which it might otherwise obtain many valuable publications for its library.

Notwithstanding these serious drawbacks, the publications of the Museum (Proceedings and Bulletin) are distributed to about 2,200 libraries at home and abroad, and more than twice this number receive the annual report. Specialists are previously supplied with the papers emanating from the Museum in the form of extras which pertain to their special studies; and on the mailing lists of the Museum are probably not less than 3,000 names of persons thus supplied. It is believed, however, that in order to comply with all applications, editions twice as large as at present would be necessary.

The reprinting of some of the earlier volumes of the proceedings and bulletins is also much to be desired. This would enable the Museum to complete the sets of its publications in libraries which have been only partially supplied. The first four volumes of the proceedings and the first sixteen bulletins were reprinted by the Smithsonian Institution in the Miscellaneous Collections, and in this form only libraries were supplied. But it eventually became necessary to cease this method of enlarging the editions, owing to the drain which it made on the fund of the Smithsonian Institution.

Many libraries, therefore, which were supplied with the volumes thus reprinted have received none subsequently, and their desiderata are being carefully noted with a view to supplying them from new editions, if Congress will appropriate the money necessary to defray the cost of reprinting. It is also to be hoped that Congress will see fit to restore the former extent of the edition of the annual report. The Museum, having no fund for the purchase of specimens, relies upon its reports in a large measure for securing accessions to the collections, and already, on account of the decrease in the edition, it has become necessary to restrict the mailing list of individuals to those who have done the Museum some actual service. This restrictive policy will undoubtedly result in an increased demand for these volumes on members of the Congressional bodies, for whose personal use a large proportion of the edition is reserved.

During the past year the Museum has received much valuable assistance and many courtesies at the hands of the Executive Departments and Bureaus of the Government, for which acknowledgments are hereby tendered. Several officers of the United States Geological Survey, the Department of Agriculture, and the Fish Commission have served, as in previous years, in the capacity of honorary curators of the collections.

BUREAU OF AMERICAN ETHNOLOGY.

The work of investigating the languages, habits, customs, and classification of the North American Indians was commenced in 1872 at the request of Gen. F. A. Walker, Commissioner of Indian Affairs, who had called upon the Secretary of the Smithsonian Institution for advice as to some scientific method of grouping the Indians on their reservations.

The Institution was at that time in possession of a large collection of vocabularies and manuscripts, as yet unpublished, which were placed in the hands of Maj. J. W. Powell, who had been previously studying the tribes of Utah, Arizona, Colorado, and New Mexico, and who had himself collected many vocabularies, and he was requested to report upon their availability for the purpose in question. Major Powell made a report upon these, showing to what extent they would bear upon the subject and what was necessary to complete the work. Soon after, the task was put in his charge, and it has been in progress since that time.

In carrying on this work it was essential that all the languages of the United States should be studied. It was not known at that time how numerous these languages were, but since then a large number of vocabularies have been collected in addition to those previously obtained. It has been found by Major Powell that these vocabularies may be grouped into about sixty classes, each representing a distinct family of languages.

The linguistic investigation has always had for its object to group the Indians by their affinities or their languages, and to determine what tribes may be thrown together on reservations. This linguistic study has been continued to the present time, and constantly, month by month, and year by year, Major Powell has been in communication with the Indian Office, furnishing the facts necessary to group Indian tribes upon reservations.

At the request of Major Powell an appropriation of \$20,000 was made for this work in 1879. The work previously done, including the collection of vocabularies, was without expense, by missionaries, teachers, and Army officers, and various students of American ethnology have been employed without remuneration.

When this new appropriation was made, it was further asked that the scope of the research be enlarged so as to embrace the habits and customs of the Indians, and especially their methods of tribal organization and government, and the system of tribal laws in vogue among the tribes. With that understanding the appropriation was made, and it was soon afterwards somewhat increased, and has remained the same amount, about \$40,000, except that one year \$50,000 was given, so that Major Powell might retire from the Geological Survey and devote himself exclusively to the Bureau of Ethnology. Circumstances prevented this at the time, but recently he has severed all connection with the Geological Survey, and is devoting himself entirely to the ethnological work of the Institution.

The prosecution of investigations relating to the ethnology of the American Indians has been carried forward during the year in accordance with law under the efficient control of Maj. J. W. Powell, the director, aided by Mr. W. J. McGee, ethnologist in charge, as executive officers. These researches of the Bureau of American Ethnology embrace the subjects of archæology, descriptive ethnology, sociology,

pictography and sign language, linguistics, mythology, psychology, and bibliography, and the results obtained during the year have never been exceeded in value.

Exploratory work has been carried on in the western part of the continent by several parties. The most extended exploration was made in connection with an archaeological survey of portions of New Mexico and Arizona, where a party examined the valleys of the Little Colorado and San Juan rivers, as well as Canyon de Chelly and the vicinity of San Francisco "wash." In the first-named valley but few relics of the aborigines were found, and reason was disclosed for believing that this poverty in relics was due to the high velocity of the stream and the ruggedness of its channel and valley bottom, by which irrigation was rendered impracticable. Certain ruins of considerable interest were, however, located and surveyed. In Canyon de Chelly more than 60 ruins were examined and ground plans of many of them were made, while a large series of photographs were taken. The San Juan Valley also was found rich in remains of structures of the general type found in Canyon de Chelly and elsewhere in the arid southwestern region. The relative abundance of ruins, indicating a numerous ancient population in Canyon de Chelly and San Juan Valley, is ascribed by the archaeologist to the facility with which the respective rivers may be controlled for irrigation purposes, and abundant remains of the irrigation works were found.

Another party spent several months in Indian Territory and Oklahoma collecting information concerning the habits and customs of the Kiowa, Arapahoe, and Cheyenne Indians, as well as material objects illustrating their arts and modes of life. This party was provided with a graphophone, by means of which a number of aboriginal songs, both with and without instrumental accompaniment, were recorded. Other collaborators of the Bureau visited the Indians of northern Wisconsin and northeastern Minnesota and the Kwapa Reservation in Indian Territory, where they were able to collect valuable material relating to the habits, customs, social organization, myths, traditions, and languages of the aborigines.

The archaeological investigations already begun in eastern United States were continued in New Jersey and Pennsylvania, Maryland, Virginia, central Ohio, and Tennessee. The researches in Delaware Valley, in New Jersey and Pennsylvania, are considered by the officers of the Bureau as of special interest in their bearing on questions concerning the arts of the prehistoric peoples of eastern North America, while the investigations in Virginia are regarded as throwing useful light on the arts of the aborigines at a time more immediately anterior to the white invasion. Several reports on different archaeological subjects were prepared for publication during the year. The director notes with regret that Prof. W. H. Holmes, who has for some years been in charge of this archaeological work, has severed his connection

with the Bureau in order to accept an important position in the Field Columbian Museum, at Chicago.

The study of Maya and other Mexican codices and inscriptions has been continued during the year. Some of the ancient inscriptions have been deciphered and appear to indicate that the calendar systems of the prehistoric people of the Western Hemisphere were elaborate and of considerable accuracy.

One of the lines of work in the Bureau since its institution is the systematic arrangement of scattered information relating to the tribal names and characteristics of the Indians found on this continent by early explorers and travelers. This work, which involves extended literary research, together with correspondence and conference with travelers, missionaries, and others, has been carried forward during the year, and the data collected are arranged on cards, forming a tribal dictionary, which is now quite voluminous. The information relating to several tribes is now considered sufficiently complete to warrant publication, and plans have been formulated in the Bureau for printing the work in a series of bulletins.

Several years ago the Bureau began the task of collecting the rude rock inscriptions made by the Indians on bowlders, cliffs, canyon walls, and the sides or roofs of caves in many parts of the country. As shown in the earlier published reports, these inscriptions are in some cases connected with symbolic or heraldic paintings on skins or other substances, and in some degree with the gesture speech or sign language so commonly employed among certain Indian tribes. The researches have been continued, chiefly by Colonel Mallery, and are now substantially completed. A monograph on pictography was published during the year in the tenth annual report of the Director, while an accompanying monograph on gesture speech is nearly ready for publication. Although the work in sign language is not unique, the information brought together is voluminous and exact, and the work is regarded as especially interesting and useful to students of primitive modes of expression in this and other countries.

One of the chief lines of research in the Bureau relates to the languages of the aborigines. The collection of texts, vocabularies, and grammatic material has been continued, and reports on the subject have been published. It is thought that the primitive languages of this continent, which are remarkable for number and diversity, give unexcelled opportunities for the study of linguistic development, and with this view a large body of more or less complete manuscript material has been brought together for purposes of comparative study, as well as for immediate publication. The linguistic manuscripts are stored in fireproof vaults, where they are kept accessible to philologists and other students. It is believed that the manuscript and other linguistic material in the possession of the Bureau is richer than any other body of linguistic records of primitive men.

The American Indians, like other primitive peoples, were largely influenced in their modes of life and relations among each other and with the white pioneers by their myths and beliefs. During the past year, as during preceding years, the collection of typical myths has been continued, and progress has been made in the discussion and arrangement of this material in such manner as to indicate Indian modes of thought and the motives by which primitive men are actuated. Progress has been made in preparing material relating to this subject for publication, and several of the reports issued during the year relate in greater or less measure to Indian mythology.

The publication, in the form of a series of bulletins, of a bibliography of Indian languages has been continued. This work is made as nearly as possible exhaustive, and the basis of classification is such that nearly all the more important literature relating to the American Indians is included. Two bulletins on the subject were published during the year, covering respectively the literature pertaining to the Indians of the Salishan and Wakashan stocks.

During the past year publication has kept pace with research in the Bureau, and a larger number of pages of ethnologic material have been put in type than during any previous year in the history of the organization. Two annual reports and four bulletins were distributed, while several other reports, monographs, and bulletins were also completed at the close of the year. Partly by reason of the distribution of publications, the accessions of the library through gift or exchange have been unusually rich.

A detailed statement by the director of the Bureau of the work accomplished under his direction accompanies this report as Appendix II.

THE SMITHSONIAN INTERNATIONAL EXCHANGE SERVICE.

The Smithsonian Exchange Service was inaugurated nearly half a century ago, with the object of carrying out one of the purposes of the founder of the Institution in the diffusion of that knowledge which the Institution itself helped to create.

For this purpose it established correspondence with learned men all over the world, until there is no civilized country or people, however remote, upon the surface of the planet, so far as is known, where the Institution is not thus represented. These correspondents have grown in numbers until at the present time those external to the country alone number nearly 17,000.

An attempt is made to convey, though imperfectly, in the accompanying map, an idea of the wide distribution of the Institution's correspondents. In Western Europe and in the eastern part of the United States but a small percentage of the actual numbers can be separately shown upon this small scale, and it must therefore be understood the map is not to be regarded as strictly statistical.

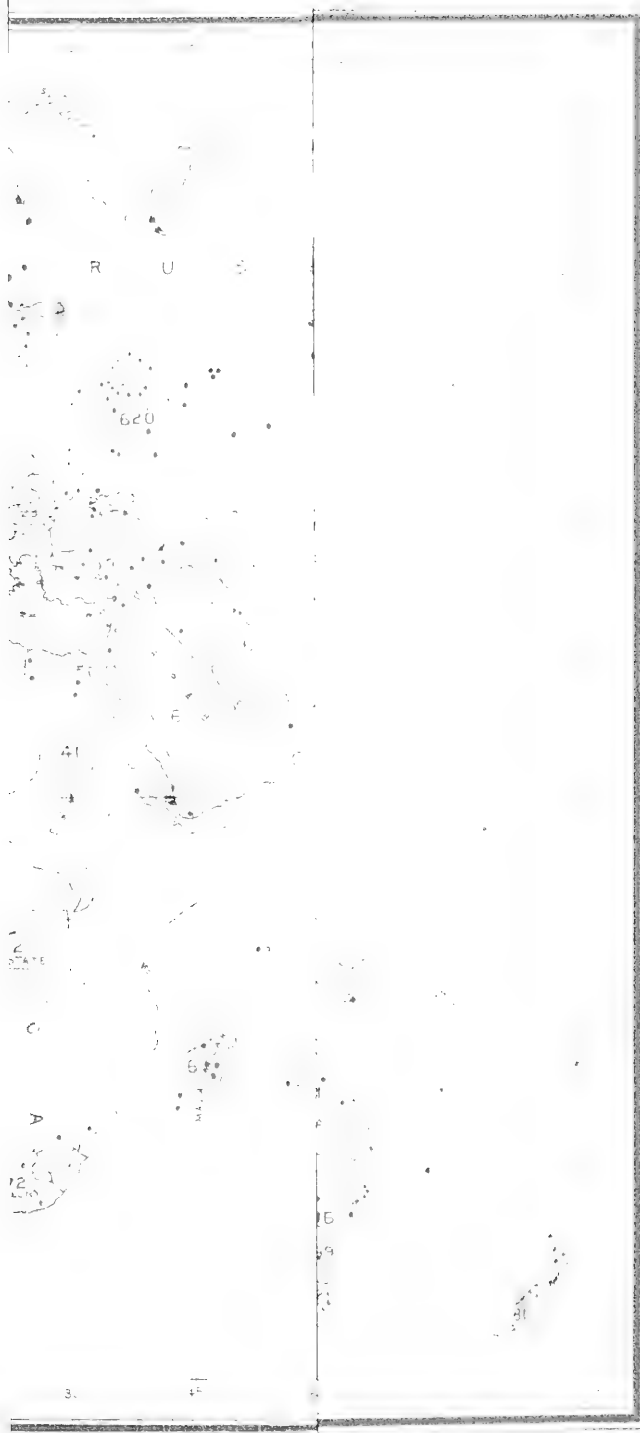

ORRESPONDENTS

I desire here, however, to call attention not so much to the extension of this system of correspondence as to the existing relations of the Smithsonian Institution and of the National Government to this Exchange Service.

The service was, as I have stated, inaugurated nearly a half century since, and at that time, in the absence of pecuniary means other than its own little fund, the Institution appealed to the generosity of the ocean and other large transportation companies to aid it in its unselfish work of diffusing knowledge by carrying, free, cases containing the communications between learned societies and others in their respective countries. Foreign governments have always recognized the peculiar service of the Institution by allowing its exchange cases free passage through their customs services, and in our own country past Secretaries of the Treasury have given special instructions to like effect.

In later years a most important change in this respect, and one whose importance is still increasing, comes from the fact that the facilities of the Exchange Service of the Institution are now made use of by all branches of the Government service, and the cases carried by these companies contain chiefly Government publications, such, for instance, as the Congressional Record and others.

I again call attention to the fact that, though transportation charges are now paid over many lines, it is only through the continuance of this peculiar privilege of free freight over other lines, granted originally in view of quite other conditions¹ that it is possible for the Institution to continue the transportation of these documents under the present appropriations, and efficiency and promptness can not be demanded of the unpaid service upon which the Institution relies. It has happened, for instance, that exchange boxes have been delayed seven months at the seaport awaiting a convenient opportunity of shipment.

Congress has never made appropriations sufficient to meet the entire expense of the exchange as conducted under the above partly gratuitous ocean service, even in taking into account the repayment to the Institution of money advanced to certain Government bureaus for the distribution of their exchanges and the amounts received from other bureaus under the ruling of the Regents referred to. An examination of the records shows that the Institution has in past years expended of its own fund over \$38,000 in the transportation of Congressional documents alone.²

The office has been laboring under the disadvantage of reduced appropriations, and it has been necessary to curtail expenses in every direction. Toward the close of the year, a deficiency estimate having failed to receive favorable action, it became necessary to restrict greatly the shipments and to notify many correspondents that transmissions would

¹The exchange of Government documents is about 70 per cent of the entire exchange work.

²Report of the Board of Regents of the Smithsonian Institution, 1890, p. 18.



be delayed. A great number of packages for shipment have therefore accumulated at the end of June, including about 7,000 copies of Congressional documents, and the work has fallen in arrears in other respects in spite of the special exertions of an insufficient clerical force to keep it up to date. The funds available for the exchange service have been also reduced through the inability of some of the Government bureaus to meet their proportionate share of the expenses involved in the transmission of their documents abroad.

Referring to the report of the curator in charge of the exchange office, it will be seen that over 100 tons of books passed through the exchange office during the fiscal year 1893-94.

The disbursements for the year were \$17,584.89, of which \$14,474.58 were paid from the appropriation of \$14,500 by Congress; \$1,729.22 were paid by Government bureaus, and \$436.73 by institutions, societies, and others, leaving a deficiency of \$944.36.

The amount which was estimated as necessary for the expense of the service for the fiscal year 1894-95 was \$23,000, a sum which it was hoped would render it unnecessary to call upon the different Government bureaus to reimburse the Institution for a part of the expense accompanying the transmission of their publications abroad, and would also give effect to a second treaty entered into at Brussels, and proclaimed in 1889, for the immediate exchange of parliamentary documents between the contracting countries, a treaty which has been inoperative on the part of the United States on account of the lack of appropriations for the purpose, Congress having appropriated only \$17,000 as explained elsewhere.

The Smithsonian Institution, through the International Exchange Service, is brought into close contact with all of the most important libraries, scientific societies, and institutions of learning in the United States, and the valuable services it has rendered to them in procuring foreign publications has always been cordially recognized, but to continue the service in the condition of efficiency it reached a few years ago, and to keep pace with the ever-increasing demands upon it, for the transportation of Government documents, a larger appropriation is indispensably necessary.

Many and just complaints of delays in the transmission of exchanges have recently been received, and without adequate means for the support of the service, these Government documents as well as others, which are reaching the Institution in increasing numbers, must be allowed to accumulate until even room for their reception and storage will be lacking.

NATIONAL ZOOLOGICAL PARK.

It is now five years since Congress made an appropriation for the purchase of land for a national zoological park. In this time the land then purchased has greatly increased in value.

When Congress was asked to appropriate funds for this park it was for a simpler and larger purpose than that of the present establishment, since it was meant to found it rather in national than in local interests and largely in view of the fact that many North American animals, constituting a part of the national wealth and formerly occupying a large portion of its domain, were threatened with speedy extinction.

The actual extinction of the buffalo, of which herds consisting of literally millions of individuals roamed the prairies less than a generation ago, is a subject of knowledge and comment throughout the world. The beaver, the wapiti, the moose, and many other species useful to man, which within the memory of those now living had their haunts and were found in abundance east of the Mississippi, are each year becoming more and more rare. It was urged upon Congress that unless steps were speedily taken to preserve the remaining few, and to bring them under observation, these races must perish, as other extinct species have done, and that with the disappearance of the last individual all hope of their renewal would be lost.

The reservation of the Yellowstone National Park as a great game preserve had been a first and very important movement toward their preservation, but the very immensity of the reservation threatened to defeat the plan, for as regards the rarer animals, these naturally kept to the wilder and more remote regions of the park, where they could not be protected from the marauding hunter, nor (what is not unimportant) be observed by the naturalist. To retard their extinction (since so long as a single pair exists and bears offspring the renewal of the race in countless individuals is at least possible), and to provide opportunity for their careful study, was the intention of those who first advocated the establishment of a preserve near Washington large enough to keep the animals as close to natural conditions as is possible, and yet not so large but that they could always be protected and under observation.

The Smithsonian Institution had for some years received frequent gifts of animals, but no suitable accommodations existed, and it seemed desirable that some provision should be made for the numerous specimens which came by donations or from Government reservations, and which were of necessity killed for scientific study or given away to zoological gardens in other cities.

The act of Congress making provision for a park, entailed responsibilities of a different character from those first contemplated, for instead of creating a purely national institution for a national purpose, one-half of the cost of purchase and maintenance was placed upon the taxpayers of the District. The indirect but quite evident tendency of this local taxation was to divert a large share of the appropriation to meet the demands of the local taxpayer, and the Regents of the Smithsonian, under whom the park was placed, were directed to "administer the park for the advancement of science and the instruction and recreation of the people."

When the land was bought it was thought desirable to include as great a length of Rock Creek as possible with sufficient width of ground to afford large, retired paddocks.

The park has an area of nearly 167 acres, with an ample supply of water for lakes, ponds, and inclosures, while the varied and picturesque character of the banks of the creek affords a variety of exposure and of effect delightful to all lovers of natural landscape.

There are as yet but four permanent buildings and the animals number 510, of which 200 are of the larger size.

Comparing this with similar establishments at other capitals, it may be noted that the Gardens of the Zoological Society, in Regent's Park, London, established about 68 years ago, cover about 36 acres of mere open common, crowded with buildings, and that the magnificent collection of animals, some 2,300 in number, is housed in a fairly comfortable manner.

In Paris the portion of the Jardin des Plantes assigned to animals is a plat of ground some 17 acres in extent, laid out tastefully, with all the resources of the landscape gardener, but necessarily crowded with its 900 animals.

In Berlin the portion of the Thiergarten appropriated for animals occupies about 60 acres. The buildings are ornamental and substantial. Fifteen hundred animals are accommodated and, necessarily, much overcrowded. The landscape features are almost wholly subordinated.

In the United States the principal collections are in Philadelphia, where the grounds occupy about 40 acres and the collection comprises 881 animals; in Cincinnati, where 36 acres are occupied with about 800 animals; and in New York, where the city maintains about 700 animals in Central Park, occupying an area of approximately 10 acres. In none of these collections are the grounds of sufficient size to give any extensive range for the animals.

The accompanying diagram shows the size of the National Zoological Park compared with those of London, Paris, and Berlin.

I ought not to close these remarks without calling attention to the evidence of the use of these gardens by the public. Even in their present inchoate condition they have received as many as 30,000 visitors in a single day. The ground constitutes a park so adjacent to the city as to be accessible on foot to all, and an expression which has been used elsewhere may be applied with no less justness here in describing this park as the lungs of the city.

The natural advantages possessed by the National Zoological Park are unrivaled. I am not aware that any city has a zoological park of such extent, so picturesquely situated, and so easily accessible. It is possible here to provide almost any exposure which animals may require, to give them large paddocks with abundant shade and seclusion, or to furnish for waterfowl and other aquatic animals lakes, ponds, and long reaches of water, where they can live in almost perfect natu-

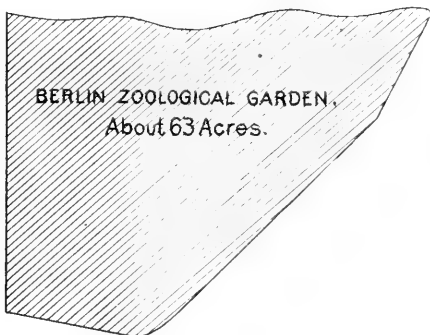
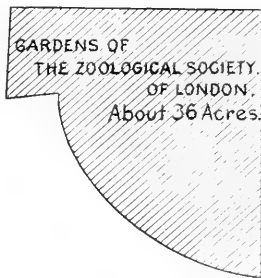
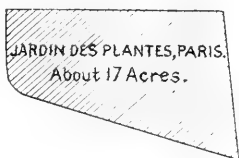
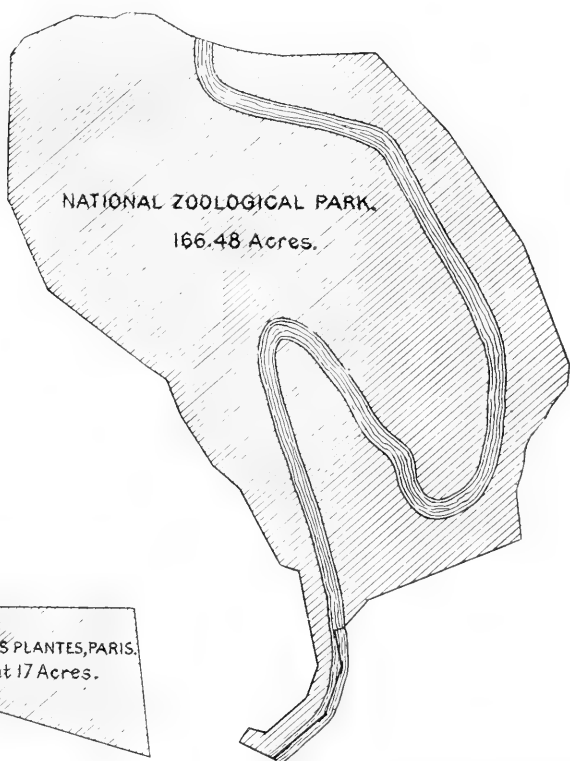

AREAS OF ZOOLOGICAL PARKS.



ral conditions. These desiderata for the animals may be combined with landscape effects; with stretches of meadow and wooded hillsides, with overhanging cliffs and running water, with dense shade and sunny slopes; such as can not fail to prove a lasting advantage and pleasure to the public.

It is obvious that care should be taken to develop this park along the lines which the natural conditions so clearly indicate, and that it would be a mistake to mar its beauty by huddling the buildings together, and by crowding the animals into small and uncomfortable quarters.

Having always in mind that the original object of the park was the preservation of American animals, it is intended to make that a principal matter of consideration; yet it must be remembered that even in the interest of North American zoology, comparative studies can not be properly carried on without a certain proportion of animals belonging to the Old World. It is to be expected, therefore, that a certain number of foreign animals will be included in the collection when they can be advantageously obtained.

The Yellowstone National Park has always been regarded as an important preserve, from which supplies could be drawn for the National Zoological Park. Its distance and the cost of transportation have prevented its use to so great an extent as could be wished; yet there have been received from it during the year a total of 28 animals, among which were a fine herd of young elk. In order to properly utilize the resources of the Yellowstone Park, it will probably be necessary to construct there a corral of considerable extent, into which wild animals can be driven, inclosed, fed, and, at the proper time, secured for shipment. Projects for a structure of this kind have been considered, but the lack of funds has thus far prevented their accomplishment.

It seems necessary to again refer to the desirability of changing the appropriation act so as to permit the occasional purchase of animals. Several times during the past year rare native animals have been offered for sale at extremely low prices—indeed, for less than the cost of transportation from the regions where they were obtained. Among such are the Rocky Mountain Goat and the Mountain Sheep. This goat has never before been seen in captivity, as far as I am aware, and the sheep is extremely rare.

In October, 1893, the proprietor of the large menagerie which in 1890 presented the park with an elephant, offered to make a temporary deposit of a number of animals without charge. In consideration of the words of the fundamental act, "For the instruction and recreation of the people," it was decided to accept the offer, such arrangements being customary in zoological gardens. It was stipulated that any animals born should become the property of the United States. The experiment was satisfactory, affording to the public an opportunity of seeing and studying at leisure, a number of interesting specimens, such as the park could not hope to possess for many years to come.

The appropriation made for the park for the fiscal year ending June 30, 1894, was in the following terms:

For continuing the construction of roads, walks, bridges, water supply, sewerage and drainage, and for grading, planting, and otherwise improving the grounds, erecting and repairing buildings and inclosures for the animals, and for administrative purposes, care, subsistence, and transportation of animals, including salaries and compensation of all necessary employees, and general incidental expenses not otherwise provided for, fifty thousand dollars, one-half of which sum shall be paid from the revenues of the District of Columbia and the other half from the Treasury of the United States; and a report in detail of the expenses of the National Zoological Park shall be made to Congress at the beginning of each regular session.

By far the greater portion of this appropriation was expended for food for the maintenance of the animals, and for keeping in proper care and condition the buildings and accessories. The sum remaining, being insufficient for new work of any great extent, has been expended in necessary improvements, and in building roads and paths to the different buildings and shelters.

The bridge near the Quarry-Road entrance has been somewhat improved by the addition of footways and copings. This structure is, however, far from satisfactory, having been built from a limited appropriation at a time when it was absolutely necessary to cross the stream to reach the central portion of the park.

Certain questions involving the access of the public to the park, are still pending and are connected with the plan of the suburban roads now under consideration by the Commissioners of the District of Columbia. The street railways are by no means convenient, as the Fourteenth street line is over half a mile distant from the park, and the Rock Creek Railway, although passing by the western gate of the park, delivers its passengers at a distance almost as great from the buildings where the animals are kept. The plan for the extension of the streets of the District, includes a carriage road outside the park from the point where the Adams Mill Road leaves it to Kennesaw Avenue. When this is once established the strip of ground between it and the park boundary should be purchased and added to the park. This will be of advantage in many ways, first, for seclusion by preventing private property from abutting upon the park and second, as making more secure the cliff in the vicinity of the bear pits, which has always been a menace and a serious disadvantage because of its proximity to the park line, and the impossibility of properly treating it.

Further steps will probably be soon taken toward establishing entrances at the southern end of the park. If this be done it will probably be necessary to improve the old Adams Mill Road, and to build a second bridge crossing from the promontory where the office now stands to the meadow near the animal house.

ASTRO-PHYSICAL OBSERVATORY.

I am gratified to state that the researches conducted here have continued to fulfill the expectations held out in previous reports. I believe that the results attained may be stated to be the most important which have ever been reached in regard to that region of the spectrum of which so little is known, and which includes the greater portion of all those energies of the sun which, through its heat, affect climate and the crops, and are thus related not only to questions of abstract interest but to utilities of national importance. The interest aroused by these researches among men of science has been very gratifying, and it is hoped that it may be found that no money granted by the Government for scientific investigation has been more profitably employed than this, even in the restricted point of view of the merely utilitarian advantages which may be hoped from it.

For a more particular account of these recent results I refer to the report of the Observatory.

Mr. R. C. Child was appointed aid in the Observatory on September 1, 1893, and Mr. F. E. Fowle, jr., as photographer, on June 1, 1894. Mr. F. L. O. Wadsworth resigned the position of senior assistant in the Observatory on June 1, 1894.

Respectfully submitted.

S. P. LANGLEY,
Secretary of the Smithsonian Institution.

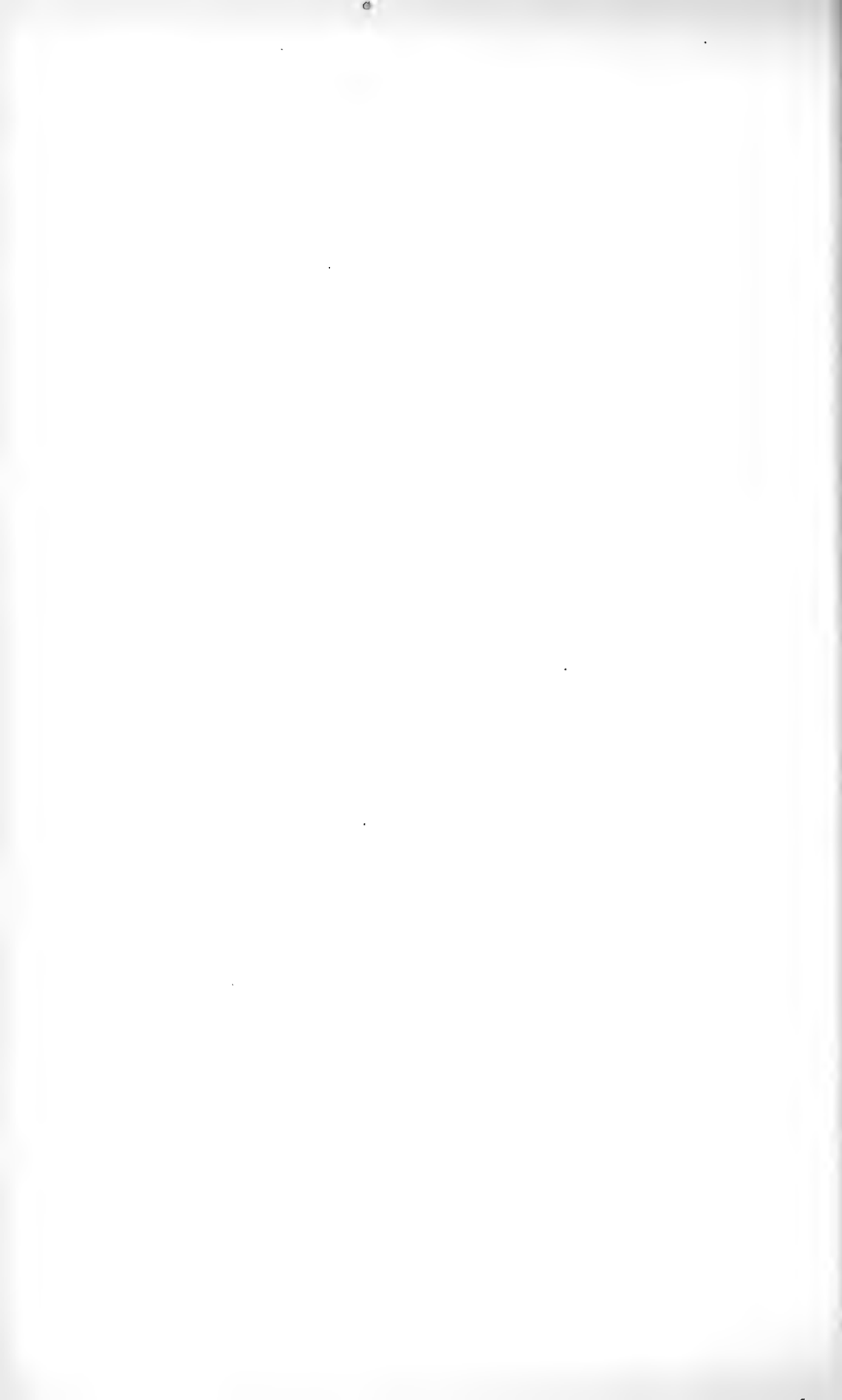

APPENDIX TO THE SECRETARY'S REPORT.

APPENDIX I.

THE NATIONAL MUSEUM.

SIR: In accordance with the provision of Congress, the Report of the National Museum is published as the second volume of the Smithsonian Report. I shall here refer briefly to only a few of the most important features of the operations of the Museum during the year.

Accessions.—More than 171,000 specimens have been added to the collections. This is more than double the total for last year, a gratifying result, in view of the fact that very little direct effort was made to increase the collections.

Important collections have been received, as in past years, from the Geological Survey, the Fish Commission, the Bureau of Ethnology, and other Bureaus of the Government. Several valuable collections have been received from private sources, and some very interesting material was presented by representatives of foreign Governments to the National Museum at the close of the World's Columbian Exposition.

The detailed report for the year will contain a statistical statement showing the number of specimens added during the year to each department, and for each year since the opening of the Museum building.

The scientific staff.—The scientific staff is substantially the same as last year. A few changes and additions have occurred in the curatorships. Having, as Assistant Secretary, resumed the active direction of the affairs of the Museum, the designation of Mr. True was on May 9 changed from Curator-in-charge to Executive Curator, with special duties of administration. The Executive Curator may at times be called upon to take general charge in my absence. On July 15, Dr. C. H. White, U. S. N., was recalled from his custodianship of the materia medica collections by the Secretary of the Navy. Dr. C. U. Gravatt was detailed in his place, and served until January 22, when he was relieved by Dr. R. A. Marmion, who was succeeded on June 15 by Medical Inspector Daniel McMurtrie, the present incumbent. Mr. Charles Schuchert, of the United States Geological Survey, was on May 7 appointed honorary aid in the Department of Paleozoic Fossils. Dr. C. W. Stiles, of the Department of Agriculture, was on March 17 appointed honorary curator of the helminthological collections.

Dr. Frank Baker resigned his position as honorary curator of the Department of Comparative Anatomy in order to devote his entire time to his duties as Superintendent of the National Zoological Park, and Mr. Frederick A. Lucas, assistant curator of that department, was on November 21 appointed curator. Dr. Baker is now recognized as associate curator. On January 1 Mr. Wirt Tassin was appointed assistant curator in the Department of Minerals, filling the vacancy caused by the resignation of Mr. William S. Yeates.

Distribution of specimens.—Following the custom of previous years, the transmission of duplicate specimens to educational establishments has been continued, and it is

gratifying to note that, in comparison with last year, more than double the number of specimens has been thus distributed. Of the 27,168 specimens thus disposed of, a large proportion represent invertebrate forms of marine life. Several sets of rocks and ores, minerals, and casts of prehistoric objects, as well as a few special collections of insects, fishes, birds, mollusks, and other material, were included. In addition, 1,448 specimens were lent to investigators for special study.

It has for many years been the intention of the Museum to make up a number of duplicate sets in all the departments of the Museum, to be used in supplying educational institutions. Applications for specimens are received almost every day. That valuable service could be rendered to colleges and schools in this way does not admit of doubt, but it is impossible to carry out such a plan until the curators can be supplied with the services of competent assistants to relieve them of the work of sorting out the duplicates and arranging them into sets for distribution. And this can not be arranged until Congress sees fit to make a large increase in the Museum appropriation.

In order to give an idea of the extent to which this branch of the Museum work has been carried on, even with the very limited facilities now at hand, it may be stated that since 1871 about 370,000 specimens have thus been distributed.

Visitors.—The total number of visitors to the Smithsonian building during the year was 103,910, and to the Museum building 195,748.

Publications.—The report of the Museum for 1891 was published during the year, and also, in the form of separates, a limited edition of each paper in the appendix. The report for 1892 is nearly ready for delivery, and the separate editions of the papers in the appendix have already been issued. Volumes 15 and 16 of the Proceedings have appeared in bound form, and a few papers included in volume 17 have been published as separates. Of the Bulletin, the following numbers have been published: No. 43, A Monograph of the Bats of North America, by Harrison Allen, M. D.; No. 44, Catalogue of the Lepidopterous Superfamily Noctuidæ found in Boreal America, by John B. Smith; No. 45, The Myriapoda of North America, by Charles Harvey Bollman; No. 46, Monograph of the North American Proctotrypidæ, by William H. Ashmead.

Special Bulletin No. 2, Oceanic Ichthyology, by the writer and Tarleton H. Bean, is in type. This work constitutes a monograph of the deep-sea and pelagic fishes of the world. The material for No. 3 of this series is in course of preparation by Maj. Charles Bendire. It will be a continuation of the subject of No. 1, Life Histories of North American Birds, and will treat of the cuckoos, woodpeckers, goat suckers, swifts, humming birds, flycatchers, horned larks, crows, jays, magpies, blackbirds, orioles, and grackles.

I have elsewhere referred to the pressing necessity of an increase in the appropriation for printing.

Specimens transmitted to the Museum for identification.—During the year 478 lots of specimens were received for determination. Very little of this material can be advantageously incorporated with the collections, and therefore the Museum receives but little actual gain from this work, which occupies a large proportion of the time of several of the curators, notably in the Department of Geology. Requests for examination and report are, however, invariably complied with. Quantitative analyses, however, can not be undertaken.

Foreign exchanges.—A number of exchanges have been effected with museums and individuals in different parts of the world, and the National Museum has in this manner acquired much valuable material. Among the institutions with which these transactions have proved most advantageous to the Museum are the Australian Museum, Sydney; Queensland Museum; Technological Museum of New South Wales; National Museum of Costa Rica; Museum of Natural History, Paris; Imperial Royal Museum of Vienna.

Explorations.—The further explorations of Dr. William L. Abbott, in Kashmir, India, the Seychelles and adjacent islands in the Indian Ocean, have resulted in additional important collections for the Museum. Several papers describing his collections have been published in the Proceedings of the National Museum.

Prof. O. F. Cook, of Huntington, N. Y., who is now traveling in Liberia, has transmitted a large collection of ethnological objects and natural history specimens from that country.

The researches in Finland of Hon. John M. Crawford, United States consul-general at St. Petersburg, Russia, have resulted in the transmission of a most valuable collection of ethnological objects. The collection was accompanied by a descriptive list, minutely setting forth their uses.

Mr. J. B. Henderson, jr., of Washington City, and Mr. Charles T. Simpson, of the National Museum, during an exploring trip in the West Indies obtained for the Museum a collection of Miocene marl and land shells.

The Intercontinental Railway Commission has presented to the Museum a large collection of natural history specimens, obtained in Central America by Dr. W. C. Shannon, U. S. A.

Mr. Mark B. Kerr, of New York City, has, in connection with his explorations in Ecuador, forwarded an interesting collection of natural history specimens from that country.

A collection of reptiles and fishes, obtained by Dr. Einar Lönnberg, of Upsala, Sweden, while engaged in an exploration of the coast of Florida, has been added to the Museum collections.

Large and varied collections have resulted from the explorations of Dr. Edgar A. Mearns, U. S. A., who is still engaged in the work of the International Boundary Commission.

Respectfully submitted.

G. BROWN GOODE,

Assistant Secretary in charge of the U. S. National Museum.

MR. S. P. LANGLEY,

Secretary of the Smithsonian Institution.

APPENDIX II.

REPORT OF THE DIRECTOR OF THE BUREAU OF AMERICAN ETHNOLOGY FOR THE YEAR ENDING JUNE 30, 1894.

SIR: Ethnologic researches have been carried forward during the year in accordance with act of Congress making provision "for continuing researches relating to the American Indians, under the direction of the Smithsonian Institution."

The primary classification of the work is topical, and the researches pertaining to each subject are divided between field studies and office work as circumstances require. The chief lines of activity relate to (1) archaeology, (2) descriptive ethnology, (3) sociology, (4) pictography and sign language, (5) linguistics, (6) mythology, (7) psychology, and (8) bibliography, together with (9) publication, and the ancillary exploratory and miscellaneous work.

The classification of the work is more definite than the assignment of the personnel, since circumstances from time to time require the concentration of a large part of the energies of the Bureau on one or a few subjects, and thus special assignments are made with advantage to the work and, it is believed, without injury, and indeed commonly with benefit, to the workers.

EXPLORATION.

The most extended exploratory work of the year was that of Mr. Cosmos Mindeleff in connection with archaeological surveys in the Pueblo country of New Mexico and Arizona. He left Washington early in July, 1893, and, outfitting at Holbrook, Ariz., proceeded to the Hopi villages of Tusayan, and toward the end of August to the valley of the Little Colorado, which he explored in some detail. Contrary to expectations this region was found to be poor in relics of the aborigines; only a few small and unimportant ruins are scattered over the valley, and the sites were apparently occupied for short periods only. It is noteworthy, that according to Hopi tradition, it was along a valley tributary to the Little Colorado that the large timbers used in the construction of the Spanish churches and mission buildings prior to 1680 were transported on the backs of Indians from San Francisco Mountains, nearly 100 miles away, and that this tradition appears to find corroboration in Mr. Mindeleff's observation of a party of Tusayan Indians transporting poles from the foothills of the same mountains over the same route by the use of burros. The reason for the dearth of ruins gradually became apparent as the explorations were continued; the topography about the Little Colorado and the character of the stream itself are such that its waters could not be controlled for purposes of irrigation by any means at the command of ancient pueblo builders; even modern engineering skill has thus far failed to control the stream, although many efforts in this direction have been made.

Only at intervals are there flood plain lands suitable for primitive cultivation and within easy reach of irrigation devices, and in such places ruins are usually found. This is notably the case near the old Sunset crossing, where, perched on the hills overlooking the flood plain, can be seen the ruins of ten or more villages, the largest of which would have accommodated a population of 200. The ground plan of this village shows a number of rectangular rooms, the whole bearing a strong resemblance to the plan of ruins found near the Tusayan villages. Tradition recites that

this village (or possibly a neighboring one) was called Homalobi, and was occupied by the Water gens, the last to reach Tusayan. The indications are that the period of occupancy was short.

Mr. Mindeleff found the river at Mormon crossing or "the Crossing of the Fathers" too high for fording, and his party proceeded with difficulty along the northern bank to the old Sunset crossing near Winslow. After fording at this point, the party proceeded to Camp Verde, crossing the Mogollon Mountains by way of Sunset and Chavez passes. At Camp Verde an old field outfit was taken up and the party returned by way of Flagstaff, reaching Little Colorado River at the mouth of San Francisco wash. This region was formerly a favorite hunting ground of the Tusayan, large parties leaving the villages to hunt antelope and other game so recently as ten years ago; but the game has nearly disappeared, and the annual hunting parties of the Tusayan Indians are now but a memory. From San Francisco wash the party followed the southern branch of the river to Winslow, and the northern side thence to Holbrook.

Leaving Holbrook early in October, Mr. Mindeleff proceeded northward toward Canyon de Chelly. Advantage was taken of the opportunity to examine the locality of a supposed ruin some 35 miles north of Holbrook, concerning which rumors have been current for several years, and the supposed ruin was found to be a natural dike rising from the summit of a low hill as a wall of black basalt over 100 feet long, generally less than 2 feet thick, and sometimes 18 feet high. Near its western end the remains of a habitation consisting of one or two rooms was found, the ground being strewn with potsherds. So striking is this dike that the Navajo guide insisted, even when standing before it, that it is artificial; yet examination leaves no doubt as to its real character. Canyon de Chelly was reached about the middle of October, and detailed examination of its cliff ruins was begun at once and continued nearly to the end of December. More than sixty ruins were examined, and ground plans of many of them were made and a large series of photographs were taken. The results of this survey, which is summarized elsewhere, are of great interest.

Leaving Canyon de Chelly in December, the party proceeded by way of Pueblo Colorado and Fort Defiance, to San Juan River, where it was planned to winter. In crossing Tunicha Mountains a snowstorm of unprecedented severity for the season was encountered, and the party missed the trail and for a time were lost; among other accidents a wagon was overturned in such manner that Mr. Mindeleff was caught beneath it and his shoulder dislocated, whereby he was disabled for some months. Fortunately the expedition was rescued by a party of ranchmen from Fort Defiance, organized for the purpose when the severity of the storm was realized. The success of the expedition and even the preservation of the lives of its members must be ascribed largely to the humanity which inspired the rescue party and the energy with which they pushed into the mountains, rendered almost impassable by the snow and wind. The expedition reached San Juan River a few days later, and soon after disbanded.

When able to resume work Mr. Mindeleff began a reconnoissance of San Juan Valley, not completed at the end of the fiscal year. This district was found rich in ruins, mainly of a type resembling the oldest ruins in Canyon de Chelly. San Juan Valley is terraced, and the river itself is a swift mountain stream, and conditions are thus favorable for irrigation by primitive as well as civilized men. The detailed surveys here were accordingly extended and resulted in substantial contributions to the archaeology of southwestern United States.

Mr. James Mooney spent some months, beginning with July, on the Kiowa Reservation in Indian Territory, and subsequently visited the Arapahoe and Cheyenne Indians for the purpose of collecting information concerning habits and customs as well as beliefs and languages. He was provided with a graphophone, by means of which he was able to record a number of aboriginal songs, both with and without

instrumental accompaniments, and in single voice effects as well as in chorus. Altogether he spent five months in field work, of which part was exploratory.

Col. Garrick Mallery spent the greater part of the month of September among the Indians of northern Wisconsin and northeastern Minnesota for the purpose of verifying and correcting notes obtained through correspondence.

Dr. W. J. Hoffman spent July and August and a portion of September among the Ottawa Indians near Petoskey, Mich., the Ojibwa Indians at La Pointe Reservation, Wis., and the Menomoni Indians at Keshena in the same State, and among the several tribes information pertaining to their customs and beliefs was obtained.

Mr. J. Owen Dorsey spent the month of January, 1894, on the Kwapa Reservation in Indian Territory, investigating the social organization of the tribe and recording their myths and traditions.

During the earlier part of the year the Director took advantage of opportunities growing out of work in connection with the Geological Survey on the Pacific Coast to visit several Indian tribes and to continue his researches relating to their habits, myths, and languages.

ARCHAEOLOGY.

Mr. W. H. Holmes was occupied throughout the year in archaeological researches, chiefly in eastern United States. The first half of July was spent in organizing the work of the year, and later he proceeded to different points in Delaware Valley for the purpose of continuing studies of ancient quarries and quarry shops. A new quarry shop was discovered on Delaware River, 15 miles above Trenton, yielding rejects corresponding precisely with the objects so abundantly found in the gravels on which the city of Trenton is built, and which were formerly classed as paleoliths. Subsequently he visited a number of interesting localities in Ohio, giving especial attention to the gravels at Newcomerstown, in or apparently in which an artificially shaped stone has been found, this being the only case now strongly held to indicate the existence of man during the Glacial period in this country.

In October he visited an island in Potomac River, near Point of Rocks, flooded by a recent freshet in such manner as to lay bare an ancient village and aboriginal workshop. This workshop proved of considerable interest in that here unmistakable indication was found for the first time that blocks of stone were used as anvils in the production of certain classes of stone implements and weapons.

During February he directed the exploitation, by Mr. William Dinwiddie, of an aboriginal steatite quarry near Clifton, Va. This quarry was found especially instructive by reason of its large size, the great number of partly completed utensils found within the opening and in the neighboring dump heap, and in the excellence of its preservation.

In April Mr. Holmes, accompanied by Mr. McGee, repaired to an interesting site near the mouth of Pass Creek, not far from Luray, Va., for the purpose of collecting additional data relating to a noteworthy series of stone art products, to which attention was called during the preceding fiscal year by Mr. Gerard Fowke.

A considerable additional collection was made and an aboriginal cemetery was discovered in a neighboring field, and from it a typical collection of mortuary pottery was taken. The stone art products in this locality are of exceptional interest, as the "turtleback" forms are rejects from the manufacture of celts. The rejects hitherto studied by Mr. Holmes represent, exclusively or predominantly, narrow-pointed instruments such as spear points or arrow heads, while those found at the mouth of Pass Creek represent predominantly the manufacture of broad and thin pointed objects. A sufficiently complete series of rejects and nearly completed forms to illustrate all stages in manufacturing was brought together.

Mr. McGee extended the observations from this locality up Pass Creek with the purpose of discovering the original source of the stream pebbles and cobbles used by the primitive artisans, and was rewarded by finding, well toward the head waters of the stream, a large mass of intrusive rock, from which the pebbles were originally

derived. This part of the study also proved of exceptional interest, as it indicated the delicacy with which the Indian manufacturer adjusted himself to his environment; in situ the rock is too massive and obdurate for working by primitive methods; in the upper reaches of the stream the bowlders derived from parent ledges are too large for reduction without the use of metal; below the confluence of Pass Creek with the Hawksbill the pebbles are too small and too scant for profitable working; while just above the confluence, at the site discovered by Mr. Fowke, the pebbles are at the same time of suitable size and sufficiently abundant for easy working by primitive methods—in short, the best and, indeed, the only feasible site for the aboriginal factory was that selected for the purpose. The material is a peculiarly tough and strong crystalline rock, which flakes fairly well and is at the same time adapted to battering and grinding.

During the first three months of the year Mr. Gerard Fowke was occupied, under Mr. Holmes's general instructions but under the immediate direction of the ethnologist in charge, in making collections from the little known but highly interesting interior shell mounds in the valley of Tennessee River. This work yielded excellent results, particularly in the form of material collected for the enrichment of the National Museum. The collections were duly cleaned, prepared, and tabulated, and transferred to the Museum by Mr. Henry Walther.

Mr. William Dinwiddie, under Mr. Holmes's immediate direction, spent the greater part of the months of July, August, and September in archaeological reconnoissance along the shores and tributaries of Chesapeake Bay with the object of demarking more exactly by art products the territory belonging respectively to the different peoples. His work also yielded abundant collections for the enrichment of the National Museum for the benefit of contemporary and future students.

During February and March, as already noted, Mr. Dinwiddie was occupied in investigating the aboriginal steatite quarry at Clifton, Va. The quarry was cleared and its walls and floors were found to yield numerous and characteristic traces of primitive workmanship; a rich collection of broken and partially finished utensils was made; a good series of photographs, showing with unprecedented accuracy the details of the quarrying and manufacturing operations, was taken; a number of the tools used in the work were found, while the entire collection has been brought together for study and preservation in the National Museum. The more general results of the investigation of this quarry have been incorporated in reports by Mr. Holmes, while a detailed paper on the subject is in preparation by Mr. Dinwiddie.

The results of the work by Mr. Cosmos Mindeleff in New Mexico and Arizona are of much importance. The examination of over sixty ruins in Canyon de Chelly verifies the conclusion previously reached by the same investigator that the cliff dwellings here were primarily farming outlooks, and that the home villages were commonly located on wholly indefensible sites on the canyon bottom. It was found that the ruins are divisible into several groups, apparently representing a chronologic sequence. In the later ruins highly suggestive details are found illustrating the gradual assimilation of introduced or accultural ideas. Among other results there was obtained a series of drawings and photographs showing the development of chimney structure from the first crude attempts to imitate a form known only from casual observation and description to a more finished structure, though the most finished product was far from perfect, while the first attempts were exceedingly crude. Mr. Mindeleff was led to conclude that the foreign ideas exemplified in the chimneys and other structures were introduced in the architecture of Canyon de Chelly at a late period of the occupancy of the territory, probably only a few decades before its abandonment. Other details, such as the constructive use of adobe, were traced through the various stages of development in the same way; and some ruins were found in which the old and the new ideas find expression side by side in such manner as to indicate that the village was occupied before the introduction of the foreign ideas, and that the occupancy continued until after the ideas were definitely crystallized.

One interesting group or series of ancient ruins was found, which had apparently been overlooked by previous visitors. They occur in the upper part of the canyon and are nearly obliterated. The structures were always located on sites determined wholly by agricultural necessity and methods without reference to defensive ends. Mr. Mindeleff is of opinion that these are the oldest ruins in the canyon belonging to the initial period of occupancy, which extended over many decades. Close attention was given also to a number of large ruins situated in the canyon bottom without reference to defense, also overlooked by previous explorers. These differ from the preceding type and are in some respects the most important ruins of the canyon. They apparently represent the home pueblos occupied contemporaneously with the cliff dwellings, and bore the same relation to the latter that Zuni bears to Nutria, Pescado, and Ojo Caliente, or that Oraibi bears to Moen Kopi. The cliff dwellings were apparently occupied as a rule only during the summer months, the occupants resorting to the pueblos during the winter. Thus the cliff dwellings appear to represent a phase rather than a chronologic epoch in the history of the pueblo builders.

Although the researches are not yet completed, Mr. Mindeleff is of opinion that while some of the ruins may be precolumbian others were undoubtedly occupied in the seventeenth century, and that the occupancy was probably continuous as regards the district, though probably not continuous as regards particular tribes or sub-tribes. A general result of the study was the classification of the various types of ruins, in a chronologic order, in such manner that the history of the canyon from the earliest occupancy up to the recent advent of English-speaking settlers is clearly indicated. In combining the data acquired in Canyon De Chelly with those obtained from Rio Verde during previous years, Mr. Mindeleff finds reason for the conclusion that the ruins of the former district represent the first settlements in the San Juan country, and that further developments will be found in the tributary valleys, and also that the large communal buildings on the tributaries of the San Juan, representing the highest architectural art attained by the pueblo builders, will prove to be the ultimate form of the primitive village of this district.

During the year Dr. Cyrus Thomas completed the revision of proofs of text and illustrations of his report on mound explorations, and the work was put through the press as the body of the twelfth annual report. The document comprises much information relating to the Indian mounds of the Mississippi Valley and eastern United States, and it seems reasonable to hope that the monograph may come to be regarded as a standard source of information on the subject. Subsequently Dr. Thomas gave special attention to the hieroglyphs and codices of the Maya—the ancient inhabitants of Yucatan. One of the results of the work is the demonstration that the time system recorded in the Dresden codex is precisely the same as that mentioned by the early Spanish authors, except that the years begin with what are considered the last instead of the first of the four-year series. It is also shown that this brings the calendar of the Dresden codex into harmony with the calendars recorded at Palenque, Lorillard City, and Tikal. A portion of the results of Dr. Thomas's work on this subject is published in one of the bulletins of the Bureau, a brochure of 64 pages, entitled "The Maya Year." Other results are incorporated in a bulletin on the origin and significance of the calendric terms, which is not yet completed.

During the year Mr. Hilborne T. Cresson, of Philadelphia, was occupied in archaeological researches, chiefly in Guatemala and eastern Mexico, under the provision of the De Laincel fund and under the general supervision of the Director of the Bureau. Some of the results of his interesting researches have been made public through various scientific journals.

Specially noteworthy among the results of the archaeological work in the Bureau during the current year are the monographs by Mr. Holmes on ancient pottery of eastern United States and stone art of eastern United States. Both embrace the results of researches extending over many years; both are elaborately illustrated

from material preserved in the National Museum; both represent the mature conclusions of an able and carefully trained archaeologist. The classification and interpretation adopted by Mr. Holmes are primarily indigenous, though his comparative studies have extended over the archaeological literature of the world, and it is believed that his conclusions will form a firm basis for those branches of archaeology to which his work relates. To him science is indebted for a consistent method of interpreting primitive art products through study of the arts of primitive peoples cognate to those whose relics have come down to us from prehistoric times. It was with great regret that the Director accepted his resignation from the Bureau toward the end of the fiscal year, in order that he might transfer his labors to the Field Columbian Museum.

DESCRIPTIVE ETHNOLOGY.

An important line of work in the Bureau for some years past has been the collection and systematic arrangement of tribal names and characteristics, with brief description of the habits, customs, arts, beliefs, and institutions of the aborigines. The information thus collected has been recorded on cards under the head of Tribal Synonymy.

During the last year Mr. E. W. Hodge devoted several months to the descriptive ethnology of several southwestern families, the Piman, Tanoan, Keresan, and Zunian stocks receiving chief attention. Advantage was taken of the presence in Washington of Mr. Carl Lumholtz, who has spent several seasons among the tribes of Chihuahua, to obtain valuable information relating to the Tarahumar, Tepehuan, and Tubar Indians for use in the synonymy of the Piman stock. Mr. Hodge's literary research during the year has enabled him satisfactorily to identify the obscurely recorded Jumano of the early Spanish explorers with the Comanche of more recent date. In connection with the condensed descriptions contained in the systematic work, Mr. Hodge has made progress in the preparation of a bibliography of the Pueblo Indians, designed to serve as a basis for further research concerning this interesting portion of our aboriginal population.

Mr. J. Owen Dorsey made a number of important additions to the portion of the tribal synonymy relating to the Siouan tribes, and Mr. James Mooney devoted some time to classifying and extending the material already obtained relating to the Cherokee Indians. Mr. Albert S. Gatschet also made contributions to this work.

Although the collection of material for the general descriptive ethnology of the tribal synonymy of the American Indians was commenced some years since, and although a large body of information has been collected and arranged on cards for office use, publication has not yet been undertaken, partly by reason of the great volume of the material, partly because the work is of such character as not soon to be completed, since each new investigation yields additional information; but within the past five years the records have been found so useful, and the demand for information contained therein so extensive, that a plan for publication has been formulated.

In accordance with this plan the material will be arranged by linguistic stocks and published in bulletin form in the order of completion, each bulletin comprising a stock. In addition to the usual pagination the bulletins devoted to the subject will be consecutively paged (at bottom) for the series, and it is proposed to complete the series by a bulletin so arranged as to form at the same time an index to the whole and an abbreviated dictionary of the tribal and other names used by the American Indians. In accordance with this plan the materials pertaining to a number of the stocks have been made ready for the press, with the exception of brief introductions which remain to be written.

During the first half of the fiscal year Dr. W. J. Hoffman continued the investigation of the Menomoni and related Indians in field and office and prepared an elaborate memoir, entitled "The Menomoni Indians," which has been submitted for publication in the fourteenth annual report. This tribe, located in northeastern

Wisconsin, has long been known in a general way, but has received little scientific study. Dr. Hoffman's memoir embraces a history of the tribe from their discovery by Nicollet in 1634 to the present day, including the several treaties made with the Federal Government; it includes also the genealogies of the two rival lines of hereditary chiefs, together with an exposition of the ceremonials of the several cult societies, and of the mythology, industries, arts, and manufactures of the tribe.

SOCIOLOGY.

From time to time during the year the Director found opportunity for collecting additional information relating to the institutions of the American Indians and for the elaboration of material collected during previous years. Mr. McGee also made progress in the arrangement of material pertaining to this subject gathered by various collaborators. Mr. James Mooney spent several months in the field collecting information relating to the Kiowa, Caddo, Arapahoe, and Cheyenne Indians, of which a large part is sociologic. In addition he prepared during the year a memoir on the Siouan Tribes of the East, which has been sent to press as one of the series of bulletins of the Bureau. In this paper the relations and movements of the tribes recorded by early explorers and settlers of eastern United States are analyzed and, after comparative study for the purpose of combining the various consistent records and eliminating the uncertainties due to vague geographic and ethnographic records, grouped as a consistent body of information relating to the aboriginal land-holders of cisappalachian United States. The memoir represents much patient research among early maps and throughout the earliest literature of the United States. It is enriched by synonymy of the various tribes of the district, and incidentally considerable information relating to the organization and social institutions of these tribes is incorporated.

PICTOGRAPHY AND SIGN LANGUAGE.

The earlier part of the year was spent by Col. Garrick Mallery in revising the proofs of his monograph on Picture Writing of the American Indians, which has since been published in the tenth annual report of the Bureau. Some years were devoted by Colonel Mallery to the collection of information on this subject and the subject of sign language and gesture speech among the aborigines, and this monograph represents the product of labors in the interesting line of research to which it appertains. By reason of the invasion of white men, many of the primitive customs of the Indians have been modified and some have been lost; and in few directions is the modification more complete than in that of inscribing records on rocks and other surfaces; and it has been the purpose to render this work as complete an exposition of the crude graphic art of the American Indian as it is possible to make at this time. It is believed that the work will be found practically exhaustive and a standard source of information. During the remaining portion of the year Colonel Mallery has been engaged in the preparation of a companion monograph on the sign-language of the American Indians. The material for this work is even more evanescent than that drawn on in the preparation of the preceding work; but the author's studies have extended over many years and a large part of western America, and he has been favored by rich contributions from correspondents of the office. The work is fully illustrated, as is necessary, since it is only by graphic presentation that definite ideas concerning the multiform gestures and motions used in primitive interchange of thought can be clearly expressed. The monograph is approaching completion.

LINGUISTICS.

The languages of the American Indians have received a large share of the attention of the Bureau ever since its institution. It has been the policy to collect texts and vocabularies and material for grammars as rapidly and extensively as possible

before the disappearance of the primitive languages. Only a small part of the material so collected has been published; but the vaults of the Bureau are rich in data pertaining to the languages of many tribes representing most of the linguistic stocks of the American Indians. Perhaps on no other continent has the linguistic diversification of primitive peoples been wider than in northern America, and the dialectic variations are hardly less striking. The aboriginal languages of this continent accordingly give an admirable opportunity for the study of the facts and causes of linguistic development; and from the beginning it was deemed important to collect the largest possible body of material for examination and discussion in its bearing on the general subject. Carrying out the general policy, only subordinate attention has been given to publication, and publication has been made only in cases in which the material seemed especially typical or exceptionally complete. Thus, while the amount of linguistic material published is not voluminous, the manuscripts constantly accessible for purposes of study are abundant—richer, it is believed, than any other body of linguistic records of a primitive people.

Mr. A. S. Gatschet devoted the entire year to linguistic work. Early in the year he was employed in translating texts and in extracting lexic and grammatic elements of the Peoria and Shawano languages, recorded by him during the preceding two years. This work gave abundant opportunities for comparing the two tongues with the forty or fifty other dialects of the Algonquian stock, and the interesting results of the comparison were embodied in a comparative vocabulary of the Algonquian languages. By this comparison the intimate relations between the dialects is strikingly shown and at the same time the multiplicity of forms into which the original tongues has been diversified has been brought out. Morphologically the Algonquian tongue is built on a purely nominal basis, yet in the various dialects a wide variety of ideas are expressed with surprising perfection. In all the Algonquian dialects verbal roots combine with other verbal roots in a single word giving a peculiar and forcible expression to the verbal form. The compounding of words is further extended by numerous adjectival suffixes descriptive of quality, these suffixes indicating whether the noun qualified by such an adjective is an animate or inanimate subject, and showing whether complexion, size, age, or other qualities are to be determined. This method of adjectival suffixes extends also to the numerals, and in some dialects there are special suffixes to qualify numeral cardinals as determining animate or inanimate objects in the plural. Mr. Gatschet's recent studies have brought out the fact that the Algonquian languages of the western group (Arapahoe, Cheyenne, and Siksika) differ considerably in their phonetics from the eastern dialects, these differences being especially shown in the nasalization found among the western representatives of the stock.

Mr. J. Owen Dorsey spent the earlier part of the year in office work on the Biloxi language, completing its systematic arrangement for preservation and reference. He also revised the proofs of Contributions to North American Ethnology, Volume IX (Riggs's "Dakota Grammar, Texts, and Ethnography"), as well as his own memoir, entitled "A Study of Siouan Cults," in the eleventh annual report of the Bureau. Both of these documents have now been published. The month of January was spent on the Kwapa Reservation in Indian Territory in investigating the social organization of the tribes and recording their myths and traditions in the form of texts. After his return from the field these texts were translated literally, but the preparation of explanatory notes and free translations was deferred. Some time was spent in the elaboration of a list of the characters required for recording the various sounds in the Siouan, Athapascan, and other linguistic families; in this work he had for a time the assistance of a skilled oriental linguist, Dr. J. J. Nouri, from whom he obtained for comparative purposes many of the peculiar sounds of the Semitic and other Eastern languages. Some time was spent also in the examination of supposed linguistic affinities between the Maya and Malay languages, and during the year he recorded in final form eight Winnebago texts, dictated by Philip Longtail. Subse-

quently literal translations of these texts were made, and the preparation of explanatory notes and free English translations was begun and the lexic elements were extracted.

Mr. J. N. B. Hewitt was occupied during the earlier part of the year in researches concerning the social relations recorded in the Iroquois language and the literature relating to the people. In the course of this work it was shown that the independence of the tribe in local affairs was little if at all curtailed by the confederation of the Five Nations, certain gentes being privileged from the beginning of the historical leagues (for there were undoubtedly several) to nominate lord-chiefs and vice-chiefs to the league councils. Subsequently Mr. Hewitt made examination of the data for the classification of the Wailatpuan and Shahaptian groups of languages. Despite the paucity of the linguistic material, he found that the groups display peculiarities apparently due rather to divergent growth than to original diversity, this being exceptionally true of the position of the attributing or predicating word in the word-sentences or compound stems. In the lexicon the Shahaptian dialects show specific superficial differences from the Wailatpuan group, but nevertheless a large and important number of stems pertaining to the former, which have the same or cognate significance, accord substantially in sound or form with terms in the latter; there are, moreover, in many of the dialects striking proofs of the effects of discordant linguistic growth. The general result of the study was to prove that the two groups of languages have had a common history in part; and this conclusion has been provisionally accepted in the classification of linguistic material in the Bureau vaults. Other important studies relating to the affinities of the aboriginal languages of northwestern America were successfully carried forward. Mr. Hewitt also aided in the linguistic comparison of the Maya and Malayan terms collected by Dr. Thomas. Some time was given also to the arrangement and transliteration of the Tubar material collected by Dr. Carl Lumholtz in Mexico, with a view to publication. This collection, although not large, is of a special interest, since it was obtained from the last three surviving representatives of the tribe who alone survive. During the last months of the year Mr. Hewitt made a fruitful study of the so-called irregular or anomalous verb in the Tuskarora or Mohawk dialects.

In connection with memoirs on the Menomoni Indians, already noted, Dr. Hoffman compiled a considerable vocabulary representing the language of this tribe.

In addition to the Tubar material in part transliterated by Mr. Hewitt, Dr. Carl Lumholtz turned over to the Bureau the vocabularies collected from the Tarahumar and Tepehuan tribes occupying the mountainous portions of the state of Chihuahua, in the Republic of Mexico. Several other valuable contributions to the linguistic material of the Bureau were made during the year. Among these may be mentioned a manuscript of more than a thousand pages representing the vocabulary and grammar of the Nez Perce Indians of Idaho, collected by the late Miss S. L. McBeth and kindly transmitted to the Bureau by her sister, Miss Kate C. McBeth.

MYTHOLOGY.

The myths and cognate beliefs of the American aborigines are of exceptional interest, since they exemplify in many cases the influence of environment on the minds of the devotees, and in some cases, moreover, the myths indicate the migrations of the peoples among whom they are found. Accordingly, the studies by Mrs. Stevenson and Mr. Cushing of the mythology of the Pueblo tribes, particularly that of the Zuni, are of utmost importance in American anthropology.

Having completed his work in arranging the exhibits of the Bureau of American Ethnology at the World's Fair, Mr. Frank Hamilton Cushing returned to Washington and resumed researches in mythology about the middle of September. Almost continuously since that time he has, in conjunction with Mr. Stewart Culin, of the University of Pennsylvania, whose attention has long been devoted to the games of the Orient, carried forward a study of the origin of aboriginal games, based on his

intimate acquaintance with the games of the Zuni and a knowledge gained by his investigations at the World's Fair.

A study of these primitive games reveals the fact that they were not played for amusement, as among civilized people, but chiefly for divination, which was practiced in connection with industries and enterprises of all sorts; so that divinatory games occupied a prominent place in the thoughts and exercised an important influence on the daily life of these people. It was also found that in the Orient the games were actually played with arrows and were still recognized as arrow games by the players themselves as late as the eleventh or twelfth centuries B. C., thus giving historic evidence of the arrow origin of lot and dice games in the Orient, and confirming, in Mr. Culin's estimation, Mr. Cushing's hypothesis as to the identical origin of such games in America. These researches have also brought to light many significant facts bearing on the usages, beliefs, and ethnic relations of early peoples, and the material result of the investigation is an elaborate paper on "Arrow games and their variants in America and the Orient," under the joint authorship of Messrs. Cushing and Culin, now well advanced in preparation. Mr. Cushing was greatly aided in this work by Mr. Lous C. Moctezuma, an educated young Mexican, from whom he obtained much information regarding the Indian games of his country.

Mr. Cushing has not allowed his researches relating to divinatory games completely to interrupt his more general studies relating to Zuni mythology, and during the year has given special attention to the origin and primitive use of fire. Fire myths are nearly universal and fire worship common among primitive peoples; and it is the possession of fire making which perhaps more than any other characteristic distinguishes mankind from the lower animals. The conquest of fire has not yet been clearly traced, but Mr. Cushing's researches are contributing materially to knowledge of the subject.

The manuscript of Mr. Cushing's paper bearing the title "Outlines of Zuni creation myths" was brought to completion and at the close of the year was partially in type as one of the accompanying papers of the Thirteenth Annual Report.

Mrs. Matilda Coxe Stevenson, although partially disabled by overwork and exposure during her last field season among the Sia Indians of New Mexico, began in July the revision of the proofs of her article on that tribe which covered pages 3-157 of the eleventh annual report. On the completion of the proof reading, early in September, Mrs. Stevenson continued the preparation of a report on certain myths and ceremonials of the Zuni tribe, among whom she has spent a number of seasons. Notwithstanding her ill health she succeeded in completing the preparation of most of the illustrative material of the monograph and well advanced the final revision of the text.

PSYCHOLOGY.

The Director has found opportunity for continuing his investigations in primitive modes of thought, carried on during previous years. The result of these studies was imparted to the members of the Bureau in a series of informal lectures for the purpose of establishing a firmer and more definite basis for their researches in Indian mythology and sociology.

BIBLIOGRAPHY.

The work on the bibliography of native American languages was continued by Mr. James C. Pilling. As in previous years much time was consumed in procuring new material for the main catalogue, from which are prepared the bibliographies of the various linguistic stocks. This work necessitates a careful review of all the catalogue material relating to Americana generally—those of auction sales, of booksellers' catalogues, of the reviews, etc.,—and these furnish brief titles, which are used as memoranda for further research. In this manner several hundred new titles have been added to the main catalogue during the year. For his painstaking and untiring patience in this tedious task Mr. Pilling is receiving high praise. The

press reviews of the stock bibliographies already issued indicate the regard in which they are held, for their incomparable completeness, by students in all parts of the world.

During the last year there was issued a *Bibliografía Española de Lenguas indígena de America*, by the Comte de Viñaza, bearing the imprint Madrid, 1892. Although issued years after the appearance of Mr. Pilling's "proof sheets," and although the compiler of the *Bibliografía* had unusual facilities, among them access to the archives of Spain—an advantage enjoyed by few if any foreigners,—but seventy-five titles not already contained in Mr. Pilling's catalogue were found in the Comte de Viñaza's work.

The month of August was taken up by Mr. Pilling with an examination of the plate proofs of the bibliography of the Salishan language, then ready for press, but little correction worthy of notice was necessary. The bulletin, which comprises 86 pages and 4 facsimiles, was delivered by the Public Printer in the middle of November.

During November work was renewed on the Wakashan bibliography. A trip extending over a few days was made to Lenox and Astor libraries, New York City, some new material being obtained and defective titles corrected. The work was forwarded to the Public Printer in January, and by the close of March the proof reading was finished. This bibliography, which was ready for distribution early in May, comprises 70 pages and 2 facsimiles. During the proof reading of the Wakashan bibliography the preparation of the bibliography of the Shabaptian languages was begun, and at the close of the fiscal year was in an advanced stage of progress.

PUBLICATION.

During no similar period of the Bureau's history have so many pages of ethnologic material been put in type. Since the close of the last fiscal year (1892-93) most of the proof reading of the Tenth Annual Report was completed. The volume was received from the printer in June, 1894. The monograph accompanying this report, "Picture Writing of the American Indians," by Garriek Mallery, covers 807 pages and is illustrated by 54 plates and 1,290 figures. On July 27, 1893, the Eleventh Annual Report was sent to the Public Printer, and before the close of October all the proofs had been read. Proof reading of the Twelfth Annual Report was in progress at the close of the year 1892-93, and continued until April, 1894. This report, which, in addition to the administrative report of the Director, contains a paper by Mr. Cyrus Thomas, entitled "Report on the mound exploration of the Bureau of Ethnology," was in the bindery at the close of the year. In February, 1894, the manuscript of the Thirteenth Annual Report was sent to the Public Printer, and in June the first proofs were received. With the close of the fiscal year all the illustrations for this annual had been engraved, and proof reading was well advanced.

At the close of the year 1892-93 the proof reading of the "Bibliography of the Salishan Languages," by James Constantine Pilling, was almost completed. This bulletin was delivered by the printer in November, 1893. The Bibliography of the Wakashan Languages, by the same author, was sent to the printer in December, 1893; the first proofs were received in January, 1894; the proof reading was finished in April, and the edition was delivered a month later.

Early in January of the present year the manuscript of a bulletin by Mr. John Garland Pollard, on the Pamunkey Indians of Virginia, was sent to the Public Printer, and by February 6 the final proofs had been revised. This bulletin was delivered in April, 1894.

At the close of the last fiscal year proof reading of Riggs' "Dakota Grammar, Texts, and Ethnography," which forms Contributions to North American Ethnology, Volume IX, had been in progress about a month, and by the end of July the volume was in page form.

The first proof of a bulletin entitled "The Maya Year," by Dr. Cyrus Thomas, was received early in February, 1894, the manuscript having been transmitted January 19. This brochure passed through the press and was delivered in May.

In January, 1894, there was also sent to the Public Printer the manuscript of the first of a proposed series of bulletins, entitled "Chinook Texts," by Dr. Franz Boas. The first proofs were received in March, and by July 1 176 pages and a number of galleys were in type.

Another bulletin, "An Ancient Quarry in Indian Territory," by William H. Holmes, was sent to the Public Printer on February 17, and by the close of June the paper was in type.

The following publications were received from press during the fiscal year:

Ninth Annual Report, for 1887-88, containing, in addition to the Director's report of 46 pages, the following papers: (1) "Etymological results of the Point Barrow expedition," by John Murdoch. Pages 3 to 441, Pls. I-II, figs. 1-128. (2) "The medicine men of the Apaches," by John G. Bourke. Pages 443 to 603, Pls. III-VIII, figs. 429-448.

Tenth Annual Report, for 1888-89, containing, in addition to the Director's report of 30 pages, the following: "Picture writing of the American Indians," by Garrick Mallory. Pages 3 to 807, Pls. I-LIV, figs. 1-1290.

Bibliography of the Salishan Languages, by James Constantine Pilling, XIII, 86 pages (including 4 pages of facsimiles).

The Pamunkey Indians of Virginia, by John Garland Pollard. 19 pages.

The Maya Year, by Cyrus Thomas. 64 pages, 1 plate.

Bibliography of the Wakashan Languages, by James Constantine Pilling, XI, 70 pages (including 2 pages of facsimiles).

MISCELLANEOUS.

Classification of manuscripts.—In the current appropriation for American Ethnology, provision was made for rental of quarters for the use of the Bureau, and in accordance therewith the sixth floor of the Adams Building on F street was leased. In addition to increased floor space for the use of its collaborators when not engaged in field work, the Bureau now has two large fireproof vaults, in which has been safely deposited the large body of valuable manuscript material in its possession. This material, comprising over 1,400 specific linguistic papers, 60 miscellaneous linguistic papers, and 236 manuscripts on miscellaneous ethnologic subjects, has been tentatively catalogued by subject, linguistic family, and author, and another catalogue alphabetically arranged by catalogue and unit is now being prepared.

World's Columbian Exposition.—The labor of preparing the exhibit of the Bureau of American Ethnology at the World's Columbian Exposition was assigned to Mr. William H. Holmes, who was assisted by Mr. Frank Hamilton Cushing. After directing the installation of the collections Mr. Holmes returned to Washington, leaving to Mr. Cushing the final arrangement of a number of lay figures which had been prepared by Messrs. Holmes, Mooney, and Cushing. Mr. Cushing remained at the Exposition in charge of the Bureau exhibit until the middle of September, meanwhile conducting the study of primitive American games noted above.

It is gratifying to be able to state that the figures and other collections exhibited by the Bureau at the Chicago Exposition met with high praise from every quarter. A report on these collections is in course of preparation by Mr. Cushing with a view to publication.

Library.—From the time of the establishment of the Bureau until the autumn of 1893 the books received through gift, exchange, or purchase, were temporarily deposited in the library of the Geological Survey. When the Bureau moved into independent quarters Mr. Hodge, in connection with his work on synonymy, was placed in charge of the library, which then numbered about 2,600 volumes. At the close of the year the library had increased to 4,350 volumes, chiefly through exchange

FINANCIAL STATEMENT.

Appropriation by Congress for the fiscal year ending June 30, 1894, "for continuing ethnological researches among the American Indians, under the direction of the Smithsonian Institution, including salaries or compensation of all necessary employees".....	\$10,000.00
Balance July 1, 1894, as per last annual report.....	10,509.29
Total	50,509.29

Expenditures July 1, 1893, to June 30, 1894.

Salary or compensation per month:

1 ethnologist in charge, 12 months, at \$275	\$3,300.00
1 ethnologist, 12 months, at \$250	3,000.00
1 ethnologist, 12 months, at \$200	2,400.00
1 ethnologist, 6 months, at \$200	1,200.00
1 ethnologist, 12 months, at \$166.66	1,999.92
3 ethnologists, 12 months, at \$150.....	5,400.00
2 ethnologists, 12 months, at \$133.33	3,199.92
1 ethnologist, 6 months, at \$125	750.00
1 assistant ethnologist, 6 months, at \$116.66.....	699.96
1 assistant ethnologist, 12 months, at \$100	1,200.00
1 archaeologist, 11 months, at \$216.66	2,383.26
1 archaeologist, 12 months, at \$133.33.....	1,599.96
1 assistant archaeologist, 12 months, at \$100	1,200.00
1 assistant archaeologist, 4 months, at \$100.....	400.00
1 clerk, 4 months, at \$115	460.00
2 clerks, 12 months, at \$100	2,400.00
1 clerk, 2 months, at \$90	180.00
1 clerk, 5 months, at \$75	375.00
1 clerk, 12 months, at \$70	840.00
1 clerk, 12 months, at \$60	720.00
1 clerk, 1 month, at \$60	60.00
1 copyist, 7 months, at \$60	420.00
1 copyist, 5 months, at \$50	250.00
1 copyist, 5 months, at \$40	200.00
1 copyist, 29 days, at \$40	38.70
1 modeler, 12 months, at \$60.....	720.00
1 messenger, 11 months, at \$50.....	550.00
1 messenger, 16 days, at \$50	25.80
2 messengers, 1 month, at \$50	100.00
1 laborer, 5 months, at \$50	250.00
1 laborer, 4 months, at \$40.....	160.00
1 laborer, 10 days, at \$40	14.28
1 skilled laborer, 11 months, at \$40	440.00
1 skilled laborer, 17 days at, \$40.....	21.94
Total	36,958.74

Miscellaneous:

Traveling and field expenses	\$3,702.98
Transportation and freight.....	503.39
Collections purchased.....	1,300.58
Field instruments.....	292.63
Illustrations for reports.....	1,884.76
Publications for library.....	435.67
Stationery	185.32

Miscellaneous—Continued.

Office rental	\$999.96	
Office furniture (purchased, moving, and repair)	600.53	
Miscellaneous current expenses	142.08	
Miscellaneous (temporary services, copying, etc.)	201.75	
		\$10,252.65
		<u>\$47,211.39</u>
Balance July 1, 1894		<u>3,297.90</u>

Expenditures reclassified by subject-matter.

Picture writing and sign language	\$4,367.70	
Mound work and Indian hieroglyphs	2,670.00	
Archæology, eastern	6,023.03	
Archæology, western	3,595.05	
Synonymy	5,485.44	
Mythology	3,399.96	
Linguistics	5,167.85	
Bibliography	2,428.10	
Sociology	7,375.88	
Illustrations	1,573.25	
Rent	999.96	
Current and contingent expenses	4,125.17	
Total expenditures, North American Ethnology		<u>47,211.39</u>
Balance July 1, 1894		<u>3,297.90</u>

SUMMARY.

July 1, 1893:		
Balance on hand	\$10,509.29	
Appropriation for North American Ethnology	40,000.00	
		50,509.29
Expended		<u>47,211.39</u>
Balance July 1, 1894		<u>3,297.90</u>

Respectfully submitted.

J. W. POWELL, *Director.*

Mr. S. P. LANGLEY,

Secretary of the Smithsonian Institution.

APPENDIX III.

REPORT OF THE CURATOR OF EXCHANGES FOR THE YEAR ENDING
JUNE 30, 1894.

SIR: I have the honor to present the following report upon the operations of the Bureau of International Exchanges for the fiscal year ending June 30, 1894.

It is confined, for the sake of convenient comparison, almost entirely to the presentation of statistics, compiled upon the plan established in 1888.

The Exchange Service has been conducted during the year under exceptionally disadvantageous conditions, owing to the decrease in the appropriation made by Congress to the Institution for the conduct of the exchange operations, and also owing to the fact that some of the Government bureaus transmitting large numbers of documents were unable at the end of the year to reimburse the Institution, as hitherto, for the expense incurred.

The actual number of packages received during the year was somewhat less than during the year preceding, though the weight was considerably greater. This decrease in the number of packages was due in part to the fact that toward the close of the fiscal year, no deficiency appropriation having been passed by Congress, it became necessary to restrict the operations of the Exchange Service, and to notify a number of correspondents that it would be impracticable to transmit their exchanges abroad until a further appropriation from Congress became available. A further cause of the decrease was the discontinuance of the transmission in the special Congressional Library exchange of a large number of small pamphlets or orders from the War Department, occupying but a page or two each.

Notwithstanding this fact, it will be seen that 27 more cases were shipped abroad than during any previous year.

TABULAR STATEMENT OF THE WORK OF THE BUREAU.

The work of the Bureau is succinctly given in the annexed table, prepared in a form adopted in preceding reports:

Transactions of the Bureau of International Exchanges during the fiscal year 1893-94.

Date.	Number of packages received.	Weight of packages received.	Ledger cards from January 1, 1892.				Domestic packages sent.	Invoices written.	Cases shipped abroad.	Letters received.	Letters sent.
			Foreign societies.	Domestic societies.	Foreign individuals.	Domestic individuals.					
1893.											
July.....	9,141	28,066							174	152	
August.....	8,047	23,197							206	253	
September.....	4,664	22,049							164	80	
October.....	7,181	23,156							179	169	
November.....	11,550	18,501							191	205	
December.....	6,067	14,657							205	233	
1894.											
January.....	10,213	25,223							172	155	
February.....	11,275	17,652							174	162	
March.....	9,567	21,394							191	112	
April.....	7,232	14,987							200	133	
May.....	7,835	18,342							153	134	
June.....	5,197	7,804							157	116	
Total.....	97,969	235,028	6,991	1,620	8,619	2,993	32,931	20,869	905	2,166	1,904
Increase over 1892-93..	13,094	34,100	94	794	65	2,017	3,477	864	27	153	355

¹ Decrease.

The apparent decrease in the number of correspondents shown in the following table is to be explained from the fact that the present figures represent the actual count of the ledger cards under the system adopted in 1892. The corresponding figures in the table of last year represent the total number of correspondents on both the new and old system of ledger cards.

For comparison with previous years, I add a statement from 1888 to 1894, which will make apparent the growth in the service:

	1887-88.	1888-89.	1889-90.	1890-91.	1891-92.	1892-93.	1893-94.
Number of packages received	75, 107	75, 966	82, 572	90, 666	97, 027	101, 063	97, 969
Weight of packages received	149, 630	179, 928	202, 657	237, 612	226, 517	200, 928	235, 028
Ledger accounts:							
Foreign societies	4, 194	4, 466	5, 131	5, 981	6, 204	6, 896	6, 991
Foreign individuals.....	4, 115	4, 699	6, 340	7, 072	7, 910	8, 554	8, 619
Domestic societies.....	1, 070	1, 355	1, 431	1, 588	2, 044	2, 414	1, 620
Domestic individuals....	1, 556	2, 610	3, 160	4, 207	4, 524	5, 010	2, 993
Domestic packages sent.....	12, 301	17, 218	13, 216	29, 047	26, 000	29, 454	32, 931
Invoices written.....	13, 525	14, 095	16, 948	21, 923	23, 136	19, 996	20, 869
Cases shipped abroad.....	663	693	873	962	1, 015	878	905
Letters received.....	1, 062	1, 214	1, 569	2, 207	2, 323	2, 013	2, 166
Letters written.....	1, 804	2, 050	1, 625	2, 417	2, 752	2, 259	1, 904

EXPENSES.

The expense of the exchange system is met in part by direct appropriation by Congress to the Smithsonian Institution for the purpose and in part by appropriations made to different Government departments or bureaus, either in their contingent funds or in specific terms for repayment to the Institution for a portion of the cost of transportation.

In addition to the transmission of its own documents the Government has undertaken, through a treaty which was concluded at Brussels in 1886, and formally ratified and proclaimed by the President of the United States in 1889, the exchange of the publications of learned societies in this and other countries and the Smithsonian Institution has been recognized as the medium in the United States through which this exchange is to be effected, other governments having established special exchange bureaus for the purpose.

In 1878 the Board of Regents established a charge of 5 cents per pound weight for the publications sent out or received by the various Government bureaus, this charge being necessary to prevent an undue tax upon the resources of the Institution. For similar reasons it has been found necessary to make a charge of like amount to State institutions, from which a further small revenue has been derived.

As the same reasons for the continuance of this charge have existed to the present time, the appropriations by Congress never having been sufficient to meet the entire expense of the service, recommendation has frequently been made that the entire appropriation allowed by the Government should be contained in a single item to the Smithsonian Institution.

The appropriation made by Congress to the Institution for the Exchange Service for the fiscal year 1893-94 was in the following terms:

"For expenses of the system of international exchanges between the United States and foreign countries, under the direction of the Smithsonian Institution, including salaries or compensation of all necessary employés, fourteen thousand five hundred dollars."

The receipts and disbursements by the accounting officer of the Smithsonian Insti-

tution on account of international exchanges, under date of July 1, 1894, covering the fiscal year immediately preceding, were as follows:

RECEIPTS.

Direct appropriation by Congress	\$14,500.00
Repayments to the Smithsonian Institution from United States Government departments	1,729.22
State institutions	56.75
From other sources	379.98
Total	16,665.95

EXPENSES.

For—	From specific Congressional appropriations.	From other sources.
Salaries and compensations	\$12,853.66	
Freight	1,138.60	
Packing boxes	333.00	
Printing	12.00	
Postage	60.00	
Stationery and supplies	77.32	
Total disbursements	14,474.58	\$3,110.31
Balance to meet outstanding liabilities June 30, 1894	25.42	
Total		17,610.31

The foregoing table shows that the entire amount received from Government bureaus and other sources was \$2,165.95, making the sum practically available for the specific purpose of exchanges \$16,665.95, while the expenses amounted to \$17,610.31, leaving a deficiency of \$944.36.

An estimate for the entire expense of the service of \$23,000 was submitted in October, 1892, this sum being intended to include in a single appropriation various small items in different appropriation bills, and also an item of \$2,000 to cover the expense of an immediate exchange of parliamentary documents with the countries entering into the treaty at Brussels in 1886.

I would again call attention to the fact that no appropriation has been made for this latter purpose.

CORRESPONDENTS.

As mentioned in previous reports, it became necessary in the latter part of 1891 to provide for an addition to the series of "ledger" cards upon which were entered all packages sent or received from a given society or individual. A plan was approved by which the cards were much reduced in size, the bulk of the older cards having already become a matter of serious consideration.

The new and smaller ledger cards were begun on January 1, 1892, and since that date all the transactions have been entered upon them. The abbreviation of the records and their greater convenience in handling proved to be of the utmost service when it became necessary to reduce the clerical force in the office, and it is only by such abbreviation of the records and by the introduction of several minor labor-saving devices that it has been at all possible to prevent the work from falling irretrievably behind.

The number of new ledger cards on June 30, 1893, was 16,340, and on June 30, 1894, 20,223. This difference of 3,883 represents the increase in the number of new societies or individuals during the year making use of the service, while the entire num-

ber of cards, 20,223, is the number of societies and individuals, both domestic and foreign, with which the Exchange Office has had relations since January 1, 1892.

The new list of correspondents is classified as follows:

	New list since January 1, 1892.	
	Foreign.	Domestic.
Societies and institutions.....	6,991	1,620
Individuals.....	8,619	2,993
Total.....	15,610	4,613

The actual count of the list of correspondents printed in 1886, together with all the additions made since, gives 9,212 foreign societies; of which, however, 2,221 are not as yet represented upon the new ledger cards. The accompanying map will convey most clearly an idea of the wide distribution of these correspondents.

The entire record file of the Exchange Office contains the names of approximately 13,500 individuals and 11,500 institutions; and, although a considerable number of these represent defunct institutions or individuals, their registry with a statement of this fact is often of very great value in the Exchange Service.

Attention has been directed for sometime past to the fact that the list of correspondents in the Exchange Office requires revision and recopying upon cards, the original office list prepared and printed in 1886 having become so worn and so overcrowded by frequent interlineations as to be almost illegible.

The special exchange list for the distribution of Smithsonian documents is also in need of revision and correction. It was prepared many years ago, and not a few of the libraries to which it was deemed proper at the time to send these publications have sunk into obscurity, while many new libraries have been established to which it seems desirable that Smithsonian documents should be sent. A considerable number of requests are received each year inviting an exchange of publications, or requests for the completion of the Smithsonian series of documents, with which it is rarely practicable to comply. It is earnestly hoped, therefore, that means will be found for revising this list and the general exchange list of correspondents. Either of these lists present a task of considerable magnitude, and it is manifestly impossible with the present force of employees—which is hardly able to keep up with the current work of the Bureau—to enter upon such an undertaking at the present time.

The last list of Smithsonian correspondents, that published in 1886, is the only one to which applicants can now be referred. That a printed list of the addresses of the principal learned societies and libraries of the world would be thoroughly appreciated, the frequent inquiries made to the Exchange Office abundantly testify.

INTERNATIONAL EXCHANGE OF OFFICIAL DOCUMENTS.

Under the treaty of Brussels of 1886, the text of which was given in full in the report of the Curator of Exchanges for 1887-88, the exchange of the official publications of the United States Government with other countries has been continued by the Institution, and it now forms a very large proportion of the Bureau's work.

The entire number of publications sent abroad during the year under the provision of the act of Congress of March 2, 1867, and of the treaty above referred to, was 15,000, and there have been received in return 8,812 packages. The United States Government departments have forwarded to their correspondents abroad 28,285 packages, and have received in return 14,555 packages. The total number of exchanges for government libraries has therefore been 23,367 packages received and 43,285 packages sent abroad, a total of 66,652 packages, or about 67 per cent of the entire number handled.

The very inadequate return for the great number of documents sent out is in part undoubtedly due to the fact that no other country publishes on such a lavish scale as our own. Direct solicitation made by a special representative to the governments with which the Institution are in correspondence would also probably result in a considerable increase to the library of Congress.

The exchange on account of Government bureaus is shown in detail in the following table:

Statement of Government exchanges during the year 1893-94.

Name of Bureau.	Packages—		Name of Bureau.	Packages—	
	Received for.	Sent by.		Received for.	Sent by.
Smithsonian Institution	12,610	4,898	United States Indian Affairs Office	4
Astrophysical Observatory ..	2	United States Interior Department	22	199
Bureau of Ethnology	138	2,678	United States Interstate Commerce Commission	4	88
Bureau of International Exchanges	3	363	United States Light - House Board	2	2
United States Agricultural Department	156	1,888	United States Marine-Hospital Service	6	3
United States Army Medical Museum	4	United States Mint	2
United States Botanic Garden ..	1	United States National Academy	67	1,400
United States Bureau of Education	70	2,282	United States National Board of Health	1
United States Bureau of Medicine and Surgery	2	United States National Museum	201	5,559
United States Bureau of Navigation	5	United States Nautical Almanac Office	15	29
United States Bureau of Ordnance, War Department	3	48	United States Naval Intelligence Office	1
United States Bureau of Statistics, Treasury Department ..	21	124	United States Naval Observatory	113	668
United States Census Office	8	8	United States Navy Department	7
United States Coast and Geodetic Survey	97	69	United States Patent Office	44	1,111
United States Commissioner of Internal Revenue	3	United States President	2
United States Commissioner of Weights and Measures	4	United States Public Printer	15,000
United States Comptroller of the Currency	2	309	United States Signal Service ..	44	1
United States Congressional Library	8,812	United States State Department	12	1
United States Department of Labor	14	931	United States Surgeon-General's Office (Army)	144	585
United States Department of Steam Engineering	1	United States Surgeon-General's Office (Navy)	8
United States Engineer Office ..	30	14	United States Treasury Department	8
United States Entomological Commission	3	United States Vice-President ..	1
United States Fish Commission	55	537	United States War Department ..	19	117
United States General Land Office	6	4	United States War Records Office	298
United States Geological Survey	452	3,039	United States Weather Bureau ..	63	1,038
United States Hydrographic Office	78	Total	23,367	43,285

EFFICIENCY OF THE SERVICE.

I regret to report that, through circumstances over which the personnel of the Exchange Office could have no control, it was found impracticable to prevent the work of the year from falling in arrears.

The appropriation for the fiscal year was \$2,500 less than for the years immediately preceding, and during the latter half of the year, no deficiency appropriation having been passed by Congress it became necessary to curtail the expenses in every possible way by reducing the number of employees and otherwise in order that the regular appropriation might not be exceeded.

A further embarrassment arose from the fact already stated that some of the Government bureaus, ordinarily sending a very considerable number of documents abroad through the Smithsonian Institution, were unable to reimburse the Institution, as in previous years, for the cost of transportation advanced to meet the expense involved.

In several instances, therefore, it became necessary to advise correspondents that it would be impossible to receive and transmit their publications until after the close of the fiscal year, and, as freight charges could not be met, a very large number of documents, constituting the miscellaneous exchanges, as well as some 7,000 Congressional documents to be transmitted to parliamentary libraries with which the exchange for the Library of Congress is conducted, had to be held over until after the new appropriation became available.

The exchange relations with Greece are in the same condition as a year ago, when, on account of the expenses attending the distribution of packages, the transmission of miscellaneous exchanges was discontinued by request of the librarian of the United National and University Libraries, formerly acting as the medium for distributing publications.

The transmissions to Brazil and Chile, which were for a time suspended, were renewed, but the exchange with Mexico is still in an extremely unsatisfactory condition, and the transmission of the parliamentary documents to the Mexican Government has been suspended awaiting some action by the Mexican authorities, to whose attention the matter was brought through the Mexican minister.

The difficulties attending the transmission of documents to India has been finally met by the action of the Secretary to the Government of India, at Calcutta, in obtaining the consent of Her Majesty's Secretary of State for India to continue the former arrangement under which publications intended by the Smithsonian Institution for private institutions and individuals, as well as for Government departments and individuals in their official capacity, were forwarded to India from London by the director-general of stores, at the cost of the civil department.

I take much pleasure in bearing witness to the efficiency of the employees in the Exchange Office and in expressing appreciation of their efforts to keep up with the added volume of work in spite of the unavoidable reduction in the force, and I beg leave to call to your notice the careful attention to the interests of the Institution on the part of its special agents abroad, Dr. Felix Flügel, in Leipsic, and Messrs. William Wesley & Son, in London.

The Smithsonian Institution is also under special obligation to the Secretary of the Treasury who has designated an officer of the United States Custom-House in New York, to receive and despatch to Washington cases containing international exchanges, all of these cases being passed both in this country and abroad free of custom duties.

Grateful acknowledgments are also due to the following transportation companies and others for their liberality in granting the privilege of free freight or in otherwise assisting in the transmission of exchange parcels and boxes, while to other firms thanks are due for reduced rates of transportation in consideration of the disinterested services of the Institution in the diffusion of knowledge:

LIST OF THE CORRESPONDENTS OF THE SMITHSONIAN THROUGH WHOM INTERNATIONAL EXCHANGES ARE TRANSMITTED.

- Algeria: Bureau Français des Échanges Internationaux, Paris, France.
- Argentine Republic: Musco Nacional, Buenos Ayres.
- Austria-Hungary: Dr. Felix Flügel, No. 1 Robert Schumann Strasse, Leipzig, Germany.
- Brazil: Bibliotheca Nacional, Rio Janeiro.
- Belgium: Commission des Échanges Internationaux, Rue du Musée, No. 5, Brussels.
- Bolivia: University, Chuquisaca.
- British America: McGill College, Montreal, and Geological Survey Office, Ottawa.
- British Colonies: Crown Agents for the Colonies, London, England.
- British Guiana: The Observatory, Georgetown.
- Cape Colony: Colonial Secretary, Cape Town.
- Chile: Museo Nacional, Santiago.
- China: Dr. D. W. Doberek, Government Astronomer, Hongkong; for Shanghai: Zi-ka-wei Observatory, Shanghai.
- Colombia (U. S. of): National Library, Bogota.
- Costa Rica: Instituto Físico-Geográfico Nacional, San Jose.
- Cuba: Dr. Federico Poey, Calle del Rayo, 19, Habana, Cuba.
- Denmark: Kongelige Danske Videuskabernes Selskab, Copenhagen.
- Dutch Guiana: Surinaamsche Koloniaale Bibliotheek, Paramaribo.
- East India: Director-General of Stores, India Office, London.
- Ecuador: Observatorio del Colegio Nacional, Quito.
- Egypt: Société Khédiviale de Géographie, Cairo.
- France: Bureau Français des Échanges Internationaux, Paris.
- Germany: Dr. Felix Flügel, No. 1 Robert Schumann Strasse, Leipzig.
- Great Britain and Ireland: William Wesley & Son, 28 Essex street, Strand, London.
- Guadeloupe. (*See France.*)
- Guatemala: Instituto Nacional de Guatemala, Guatemala.
- Haiti: Secrétaire d'État des Relations Extérieures, Port-au-Prince.
- Honduras: Bibliotheca Nacional, Tegucigalpa.
- Iceland: Icelands Stiptisbokasáfn, Reykjavik.
- Italy: Biblioteca Nazionale Vittorio Emanuele, Rome.
- Japan: Minister of Foreign Affairs, Tokyo.
- Java. (*See Netherlands.*)
- Liberia: Liberia College, Monrovia.
- Madeira: Director-General, Army Medical Department, London, England.
- Malta. (*See Madeira.*)
- Mauritius: Royal Society of Arts and Sciences, Port Louis.
- Mexico: Packages sent by mail.
- Mozambique: Sociedad de Geografia, Mozambique.
- Netherlands: Bureau Scientifique Central Néerlandais, Den Helder.
- New Caledonia: Gordon & Gotch, London, England.
- Newfoundland: Postmaster-General, St. Johns.
- New South Wales: Government Board for International Exchanges, Sydney.
- New Zealand: Colonial Museum, Wellington.
- Norway: Kongelige Norske Frederiks Universitet, Christiania.
- Paraguay: Government, Asuncion.
- Peru: Biblioteca Nacional, Lima.
- Philippine Islands: Royal Economical Society, Manila.
- Polynesia: Department of Foreign Affairs, Honolulu.
- Portugal: Bibliotheca Nacional, Lisbon.
- Queensland: Government Meteorological Observatory, Brisbane.
- Roumania. (*See Germany.*)

Russia: Commission Russe des Échanges Internationaux, Bibliothèque Impériale Publique, St. Petersburg.
 St. Helena: Director-General, Army Medical Department, London, England.
 San Salvador: Museo Nacional, San Salvador.
 Servia. (*See Germany.*)
 South Australia: General Post-Office, Adelaide.
 Spain: R. Academia de Ciencias, Madrid.
 Sweden: Kongliga Svenska Vetenskaps Akademien, Stockholm.
 Switzerland: Central Library, Berne.
 Tasmania: Royal Society of Tasmania, Hobarton.
 Turkey: American Board of Commissioners for Foreign Missions, Boston, Mass.
 Uruguay: Oficina de Depósito, Reparto y Cauje Internacional, Montevideo.
 Venezuela: University Library, Caracas.
 Victoria: Public Library, Museum and National Gallery, Melbourne.

LIST OF SHIPPING AGENTS AND CONSULS TO WHOM THE EXCHANGE SERVICE IS
 INDEBTED FOR SPECIAL COURTESIES.

D'Almeirim, Baron, Royal Portuguese consul-general, New York.
 American Board of Commissioners for Foreign Missions, Boston.
 Anchor Steamship Line (Henderson & Bro., agents), New York.
 Atlas Steamship Company (Pim, Forwood & Co.), New York.
 Bailey, H. B., & Co., New York.
 Börs, C., consul-general for Sweden and Norway, New York.
 Boulton, Bliss & Dallett, New York.
 Calderon, Climaco, consul-general for Colombia, New York.
 Cameron, R. W., & Co., New York.
 Baltazzi, X., consul-general for Turkey, New York.
 Columbian line (Stamford Parry, Herron & Co., agents), New York.
 Compagnie Générale Transatlantique (A. Forget, agent), New York.
 Cunard Royal Mail Steamship Company (Vernon H. Brown & Co., agents), New York.
 Espriella, Justo R. de la, consul-general for Chile, New York.
 Hamburg-American Packet Company (R. J. Cortis, manager), New York.
 Hensel, Bruckmann & Lorbacher, New York.
 Mantez, José, consul-general for Uruguay, New York.
 Muñoz y Espriella, New York.
 Navigazione Generale Italiana (Phelps Bros. & Co.), New York.
 Netherlands-American Steam Navigation Company (W. H. Vanden Toorn, agent), New York.
 North German Lloyd (agents: Oelrichs & Co., New York; A. Schumacher & Co., Baltimore).
 Obarrio, Melchor, consul-general for Bolivia, New York.
 Pacific Mail Steamship Company (H. J. Bulay, superintendent), New York.
 Pioneer Line (R. W. Cameron & Co.), New York.
 Perry, Ed., & Co., New York.
 Pomares, Mariano, consul-general for Salvador, New York.
 Red Star Line (Peter Wright & Sons, agents), New York and Philadelphia.
 Röhl, C., consul-general for Argentine Republic, New York.
 Royal Danish consul, New York.
 Raiz, Domingo L., consul-general for Ecuador.
 Stewart, Alexander, consul-general for Paraguay, Washington, D. C.
 Toriello, Enrique, consul-general for Guatemala, New York.
 White Cross Line of Antwerp (Funch, Edye & Co.), New York.

Transmission of exchanges to foreign countries.

Country.	Date of transmission.
Argentine Republic	Oct. 31, 1893.
Austria-Hungary..	July 8, 10, 15, Aug. 7, 23, 31, Sept. 1, 20, 30, Oct. 12, 23, Nov. 2, 9, 29, Dec. 9, 1893; Jan. 8, 30, Feb. 5, June 11, 1894.
Belgium	July 24, Sept. 27, Nov. 16, 1893; Jan. 3, 31, Feb. 15, June 20, 1894.
British colonies....	July 20, Aug. 16, Nov. 11, Dec. 28, 1893; Jan. 23, Apr. 23, May 22, 1894.
Cape Colony	Nov. 7, 1893.
China.....	Nov. 2, 1893.
Chile.....	Oct. 31, 1893.
Colombia	Oct. 31, 1893.
Costa Rica.....	Nov. 4, 1893.
Cuba	Nov. 4, 1893.
Denmark	July 25, Nov. 18, Dec. 30, 1893; Feb. 16, June 22, 1894.
East Indies.....	Jan. 19, 1894.
Ecuador	Oct. 31, 1893.
Egypt	Nov. 7, 1893.
France and colo- nics.....	July 8, 15, 17, 20, Aug. 11, 25, 31, Sept. 1, 26, 30, Oct. 17, 28, Nov. 7, 29, Dec. 11, 1893; Jan. 11, 25, Feb. 3, Mar. 1, Apr. 13, May 15, 1894.
Germany	July 8, 15, Aug. 7, 23, 31, Sept. 1, 5, 20, 30, Oct. 12, 23, Nov. 2, 9, 29, Dec. 9, 1893; Jan. 8, 30, Feb. 5, May 3, June 2, 11, 1894.
Great Britain, et..	July 8, 20, Aug. 16, 26, 31, Sept. 1, 26, 30, Oct. 17, 21, 28, Nov. 11, 28, Dec. 1, 28, 1893; Jan. 13, 23, Feb. 7, Mar. 17, 22, 28, Apr. 16, May 22, 1894.
Guatemala.....	Nov. 4, 1893; June 22, 1894.
Italy.....	July 8, 21, Sept. 29, Oct. 28, Nov. 16, Dec. 5, 1893; Feb. 10, May 7, 1894.
Japan.....	Nov. 2, 1893.
Mexico	(By registered mails.)
New South Wales .	Oct. 25, 1893.
Netherlands and colonies.....	July 10, Aug. 18, Nov. 15, 1893; Jan. 3, F 13, June 19, 1894.
New Zealand	Oct. 25, 1893.
Norway.....	July 10, Nov. 20, 1893; Feb. 20, 1894.
Peru.....	Oct. 31, 1893.
Polynesia.....	Oct. 25, 1893.
Portugal.....	July 10, Nov. 20, 1893; Feb. 19, June 23, 1894.
Queensland.....	Oct. 25, 1893.
Roumania	(Included in Germany.)
Russia.....	July 10, 26, Aug. 22, Oct. 3, Nov. 18, Dec. 6, 1893; Jan. 4, Feb. 1, 21, May 10, 1894.
San Salvador	Nov. 4, 1893.
Servia	(Included in Germany.)
South Australia... .	Oct. 25, 1893.
Spain	July 10, Nov. 13, 1893; Jan. 15, Feb. 17, June 21, 1894.
Sweden.....	July 10, 26, Sept. 2, Oct. 9, Nov. 18, 1893; Jan. 4, Feb. 1, 21, May 10, 1894.
Switzerland.....	July 10, Oct. 11, Nov. 20, Dec. 6, 1893; Feb. 14, June 16, 1894.
Uruguay	Oct. 31, 1893.
Venezuela	Oct. 31, 1893; May 8, 1894.
Victoria	Oct. 25, 1893.

The distribution of exchanges to foreign countries was made in 821 cases, representing 187 transmissions, as follows:

Argentine Republic.....	5	Mexico (by registered mail).....	
Austria-Hungary.....	49	New South Wales.....	3
Belgium.....	24	Netherlands and colonies.....	22
British colonies.....	8	New Zealand.....	2
Cape Colony.....	1	Norway.....	9
China.....	1	Peru.....	1
Chile.....	4	Polynesia.....	1
Colombia.....	1	Portugal.....	9
Costa Rica.....	1	Queensland.....	3
Cuba.....	1	Roumania (included in Germany).....	
Denmark.....	11	Russia.....	35
East Indies.....	4	San Salvador.....	1
Ecuador.....	1	Servia (included in Germany).....	
Egypt.....	1	South Australia.....	2
France and colonies.....	109	Spain.....	11
Germany.....	165	Sweden.....	21
Great Britain.....	223	Switzerland.....	25
Guatemala.....	3	Uruguay.....	1
Italy.....	50	Venezuela.....	2
Japan.....	6	Victoria.....	3
Liberia.....	2		

Shipments of United States Congressional publications were made on August 4 and December 20, 1893, to the Governments of the following-named countries:

Argentine Republic.	Colombia.	Netherlands.	South Australia.
Austria.	Denmark.	New South Wales.	Spain.
Baden.	France.	New Zealand.	Sweden.
Bavaria.	Germany.	Norway.	Switzerland.
Belgium.	England.	Peru.	Tasmania.
Buenos Ayres.	Haiti.	Portugal.	Turkey.
Brazil.	Hungary.	Prussia.	Uruguay.
Canada, Ottawa.	India.	Queensland.	Venezuela.
Canada, Toronto.	Italy.	Russia.	Victoria.
Chile.	Japan.	Saxony.	Württemberg.

Shipments to Greece and Mexico are withheld for the present.

RECAPITULATION.

	Cases.
Total Government shipments.....	84
Total miscellaneous shipments.....	821
Total shipments.....	905
Total shipments last year.....	878
Increase over last year.....	27

Respectfully submitted.

W. C. WINLOCK,
Curator of Exchanges.

Mr. S. P. LANGLEY,
Secretary of the Smithsonian Institution.

APPENDIX IV,

REPORT OF THE SUPERINTENDENT OF THE NATIONAL ZOOLOGICAL PARK.

SIR: I have the honor to submit the following report of the operations of the National Zoological Park for the fiscal year ending June 30, 1894:

The progress of the park has been along the lines already indicated in former reports. The appropriation granted by Congress being insufficient to permit the construction of any important new structures, attention has mainly been given to perfecting the accommodations already established and to improving the means of access enjoyed by the public.

The location of the deer paddocks, on the eastern bank of the little stream that flows through the park, was found unfavorable, they being situated there against the boundary fence, and the deer being consequently endangered by the presence of dogs roving in the vicinity of the park. The sight of a dog frightened them to such an extent as to cause them to injure themselves in their efforts to escape. Several of them were killed, breaking their necks by running violently against the fence, others broke their legs by becoming entangled, and still others, after leaping a fence eight feet high were recaptured with much difficulty. The force of watchmen at the park being insufficient to fully guard against such accidents, it was thought best to remove the paddocks to a protected situation within the park, at a sufficient distance from the boundary fence to prevent disturbance of the animals. A site was selected a short distance below the llama house, and a suitable barn or shelter was constructed of rough beams and thatch, as shown in the accompanying illustration. The paddocks were inclosed by light wire fencing 8 feet in height. No further trouble has arisen with the deer since this change was made. The approximate cost of the house and paddocks was \$600.

It being desirable to place the beavers in a locality suitable for their habits, a retired valley was selected from which the public could be excluded, and the animals were allowed to build undisturbed. These results were even more satisfactory than were expected, as the animals at once commenced to cut down trees of considerable size, and to construct a dam and a lodge. It is hoped that others may be secured, and that they may be partially domesticated so as to carry on their interesting operations under the observations of the public.

The large pond for waterfowl and other aquatic animals, situated south of the meadow near the bridge, has finally been completed, but is not yet fenced in so as to retain the animals. A smaller pond on the left bank of Rock Creek, near the Quarry road entrance, has been prepared for swans. This will prove a picturesque feature at this point, as water can be led into and out of it by a series of small cascades, which will afford a pleasing variety.

The site of the prairie-dog town, among trees upon the top of a gravelly knoll, is found to be unsatisfactory. It seems probable that when a large number are confined in a limited space for a considerable length of time, the ground becomes impregnated with injurious matters. It has been noted that the number of these animals has been gradually decreasing, and it is estimated that the total has fallen off by as many as 75 during the year. As soon as funds are available for the purpose, it is intended to remove them to a healthier situation, and to arrange so that they

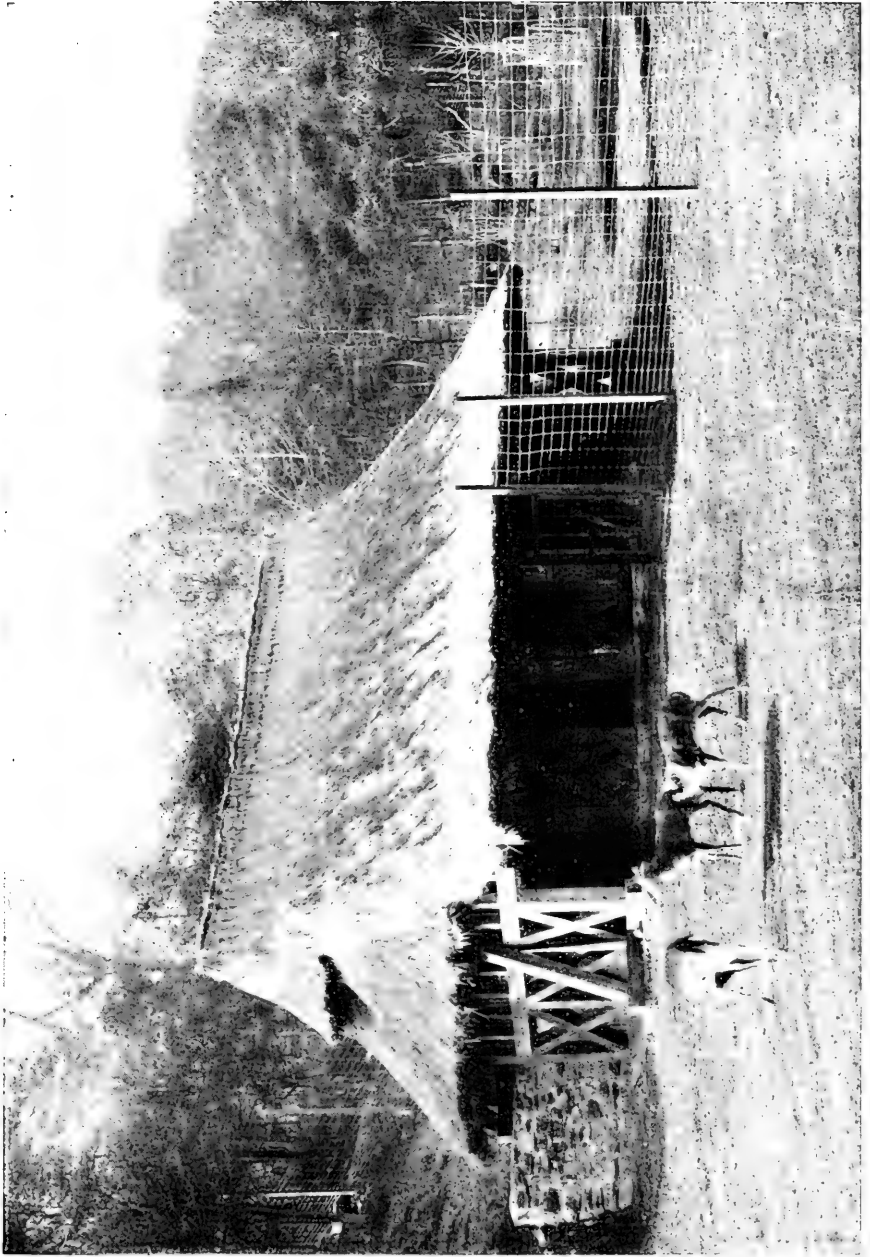

DEER HOUSE.
National Zoological Park.



may be shifted from time to time. The present site will be an admirable situation for a public comfort room and refectory, which is greatly needed for the accommodation of the public.

A considerable sum has been spent in preparing a driveway from the animal house to the west gate, through one of the most beautiful regions of the park. Considerable excavations and fills were necessary at various points, and the sum at the disposal of the administration was insufficient to properly surface and finish the road. A substantial gutter was, however, laid upon the side of the roadway. During dry summer weather this road is satisfactory, but the frosts of winter make it so soft as to be almost impassable.

Seventy-three animals were lent the park during the winter by the proprietor of the Forepaugh show. This proved a great attraction to the public, obtained at very slight expense, the only increased charge being the food consumed. It is believed that it would be advantageous to continue the practice of taking suitable and interesting animals for the expense of their maintenance, as by this means some specimens are almost certain to be added permanently to the collection, one of the stipulations made in such cases being that all animals born in the park shall become the property of the Government. A kangaroo and a monkey were in this way obtained.

The collection has thriven fairly well during the year, considering the fact that no purchases can be made and that it is so much dependent on gifts—a list of the donors of which is appended. The number of animals on hand at the close of the fiscal year was 510, being a slight increase on the number at the beginning of the year. The number of deaths was 251, chiefly among the smaller species, a considerable number occurring among animals that were in bad condition when they were lent to the park.

Among the interesting accessions was a young black bear, born on February 5, 1894. There are but few opportunities for observing the growth of these animals, as they are rarely born in captivity. The little creature was very small at birth, not larger than a good-sized rat, weighing but nine ounces, and it was thirty-nine days before it opened its eyes. It has been very vigorous and healthy from the first, and its development was evidently normal. A fine young African lion, from Mashoualand, was presented by Mr. H. C. Moore, and promises to become a very large animal when full grown.

Animals in the collection June 30, 1894.

American bison (<i>Bison americanus</i>).....	8	Crested porcupine (<i>Hystrix cristata</i>).....	3
Zebu (<i>Bos indicus</i>).....	2	Western porcupine (<i>Erethizon dorsatus</i>	
Common goat (<i>Capra hircus</i>).....	9	<i>epixanthus</i>).....	2
Angora goat (<i>Capra hircus angorensis</i>).....	1	Capybara (<i>Hydrochaeris capybara</i>).....	1
American elk (<i>Cervus canadensis</i>).....	14	Paca (<i>Calogenyx paca</i>).....	1
Virginia deer (<i>Cariacus virginianus</i>).....	11	Agouti (<i>Dasyprocta aguti</i>).....	3
Mule deer (<i>Cariacus macrotis</i>).....	2	Acouchy (<i>Dasyprocta acouchy</i>).....	3
Pecary (<i>Dicotyles tajacu</i>).....	4	Diana monkey (<i>Cercopithecus diana</i>).....	1
Hippopotamus (<i>Hippopotamus amphibius</i>)...	1	Grivet monkey (<i>Chlorocebus aegythiaca</i>).....	1
Sumatran rhinoceros (<i>Rhinoceros sumatrensis</i>)..	1	Rhesus monkey (<i>Macacus rhesus</i>).....	2
Domestic ass (<i>Equus asinus</i>).....	2	Macaque monkey (<i>Macacus cynomolgus</i>).....	4
Llama (<i>Auchenia glama</i>).....	7	White-throated capuchin (<i>Cebus hypoleucus</i>)..	3
Gunaco (<i>Auchenia huanaco</i>).....	1	Squirrel monkey (<i>Chrysothrix sciureus</i>).....	1
Indian elephant (<i>Elephas indicus</i>).....	2	Douroucouli (<i>Nyctipithecus trivirgatus</i>).....	2
Muskrat (<i>Fiber zibethicus</i>).....	3	Pinche (<i>Hapale aedipus</i>).....	1
Albino rat (<i>Mus rattus</i>).....	4	Marmoset (<i>Hapale vulgaris</i>).....	1
Coypu (<i>Myopotamus coypu</i>).....	1	Lion (<i>Felis leo</i>).....	2
Beaver (<i>Castor fiber</i>).....	1	Tiger (<i>Felis tigris</i>).....	1
Woodchuck (<i>Arctomys monax</i>).....	1	Puma (<i>Felis concolor</i>).....	2
Prairie dog (<i>Cynomys ludovicianus</i>).....	25	Ocelot (<i>Felis pardalis</i>).....	1
Red-bellied squirrel (<i>Sciurus aureogaster</i>)....	3	Bay lynx (<i>Lynx rufus</i>).....	1
Gray squirrel (<i>Sciurus carolinensis</i>).....	16	Spotted lynx (<i>Lynx rufus maculatus</i>).....	1
Fremont's chickaree (<i>Sciurus hudsonius fre-</i>		Russian wolf hound.....	4
<i>monti</i>).....	2	St. Bernard dog.....	1

Animals in the collection June 30 1894—Continued.

Eskimo dog.....	5	Domestic fowl (black-breasted red game).....	3
Black wolf (<i>Canis lupus griseo-albus</i>).....	2	Domestic fowl (spangled Hamburg).....	3
Coyote (<i>Canis latrans</i>).....	5	Curassow (<i>Craz alector</i>).....	3
Red fox (<i>Vulpes fulvus</i>).....	10	Pea fowl (<i>Pavo cristatus</i>).....	11
Swift fox (<i>Vulpes velox</i>).....	5	Cassowary (<i>Casuarus galeatus</i>).....	1
Gray fox (<i>Urocyon virginianus</i>).....	7	Cariama (<i>Cariama cristata</i>).....	1
Ferret (<i>Putorius furo</i>).....	9	Sand-hill crane (<i>Grus canadensis</i>).....	2
Wolverine (<i>Gulo luscus</i>).....	1	Black-crowned night heron (<i>Nycticorax naevius</i>).....	1
American badger (<i>Taxidea americana</i>).....	4	Scarlet ibis (<i>Guara rubra</i>).....	1
Kinkajou (<i>Cercopithecus caudivolvulus</i>).....	2	Canada goose (<i>Branta canadensis</i>).....	6
Coati mundi (<i>Nasua narica</i>).....	2	Chinese goose (<i>Anser cygnoides</i>).....	5
Coati mundi (<i>Nasua rufa</i>).....	1	Black duck (<i>Anas obscura</i>).....	4
Cacomistle (<i>Bassaris astuta</i>).....	1	Pekin duck (<i>Anas</i> sp.).....	16
Raccoon (<i>Procyon lotor</i>).....	11	Muscovy duck (<i>Cairina moschata</i>).....	1
Black bear (<i>Ursus americanus</i>).....	3	Common duck (<i>Anas boschas</i>).....	1
Cinnamon bear (<i>Ursus americanus</i>).....	3	Mute swan (<i>Cygnus gibbus</i>).....	6
Grizzly bear (<i>Ursus horribilis</i>).....	2	Black swan (<i>Chenopsis atrata</i>).....	1
Polar bear (<i>Thalassarctos maritimus</i>).....	2	European white pelican (<i>Pelecanus onocrotalus</i>).....	1
Guinea pig (<i>Cavia porcellus</i>).....	11	American herring gull (<i>Larus argentatus smithsonianus</i>).....	2
English rabbit (<i>Lepus cuniculus</i>).....	11	Alligator (<i>Alligator mississippiensis</i>).....	16
Albino rabbit (<i>Lepus cuniculus</i>).....	4	Loggerhead turtle (<i>Thalassochelys caouana</i>).....	1
Black rabbit (<i>Lepus cuniculus</i>).....	1	Tortoise (unidentified).....	2
Great red kangaroo (<i>Macropus rufus</i>).....	1	Painted turtle (<i>Chrysemys picta</i>).....	6
Kangaroo (<i>Macropus</i> sp.).....	3	Musk turtle (<i>Aromochelys odorata</i>).....	5
Common opossum (<i>Didelphys virginiana</i>).....	23	Gila monster (<i>Heloderma suspecta</i>).....	3
Golden eagle (<i>Aquila chrysaetus</i>).....	1	Diamond rattlesnake (<i>Crotalus adamanteus</i>).....	2
Bald eagle (<i>Haliaeetus leucocephalus</i>).....	6	Banded rattlesnake (<i>Crotalus horridus</i>).....	4
Red-tailed hawk (<i>Buteo borealis</i>).....	3	Prairie rattlesnake (<i>Crotalus confluentis</i>).....	3
Snowy owl (<i>Nyctea nyctea</i>).....	1	Ground rattlesnake (<i>Caudisona miliaris</i>).....	1
Great horned owl (<i>Bubo virginianus</i>).....	7	Copperhead (<i>Ancistrodon contortrix</i>).....	24
Yellow-and-blue macaw (<i>Ara ararauna</i>).....	1	Boa (<i>Boa constrictor</i>).....	2
Red-and-blue macaw (<i>Ara chloroptera</i>).....	1	Anaconda (<i>Eunectes murinus</i>).....	1
Red-and-yellow-and-blue macaw (<i>Ara macao</i>).....	2	Bull snake (<i>Pityophis sayi</i>).....	4
Sulphur-crested cockatoo (<i>Cacatua galerita</i>).....	2	Black snake (<i>Bascanium constrictor</i>).....	15
Leadbeater's cockatoo (<i>Cacatua leadbeateri</i>).....	1	Garter snake (<i>Eutania sirtalis</i>).....	12
Bare-eyed cockatoo (<i>Cacatua gymnopsis</i>).....	1	Water snake (<i>Tropidonotus sipedon</i>).....	7
Green parrot (<i>Chrysotis amazonica</i>).....	2	Hog-nosed snake (<i>Heterodon platyrhinus</i>).....	2
Green parrot (<i>Chrysotis auropalliatu</i>).....	2		
Common crow (<i>Corvus americanus</i>).....	4		
Raven (<i>Corvus corax</i>).....	1		
Clarke's nutcracker (<i>Picicorvus columbianus</i>).....	1		
Fantail pigeon (<i>Columba livia</i>).....	1		
Domestic fowl (white leghorn).....	2		
		Total.....	510

	Indigenous.	Foreign.	Domesticated.	Total.
Mammals.....	184	37	71	292
Birds.....	44	15	49	108
Reptiles.....	107	3		110
Total.....	335	55	120	510

List of accessions.

ANIMALS PRESENTED.

Name.	Donor.	Number of specimens.
Mandrill.....	J. E. Beall, Washington, D. C.	1
Lion.....	H. C. Moore.....	1
Puma.....	Lee Henderson, Memphis, Tex.....	1
Ocelot.....	C. O. Chenault, New Orleans, La.....	2
St. Bernard dog.....	Mrs. Bugher, Washington, D. C.....	1
Coyote.....	J. T. McCaddon, manager Forepaugh shows.....	2
Do.....	J. E. Beall, Washington, D. C.....	1
Red fox.....	E. S. Schmid, Washington, D. C.....	1
Do.....	L. M. Hooker, Washington, D. C.....	1
Raccoon.....	Capt. J. W. King, Eddyville, Ill.....	1
Gray coatsi mundi.....	P. L. Jouy, Washington, D. C.....	1
American tapir.....	J. T. McCaddon, manager Forepaugh shows.....	1
Common goat.....	Clarke Middleton.....	1
Do.....	G. L. Favorite, Takoma Park, D. C.....	1
Oryx.....	J. T. McCaddon, manager Forepaugh shows.....	1
Peccary.....	Dr. E. A. Mearns, Tucson, Ariz.....	1
Red-bellied squirrel.....	C. O. Chenault, New Orleans, La.....	4
Gray squirrel.....	John Balland, Washington, D. C.....	2
Do.....	A. J. Johnson, Washington, D. C.....	1
Do.....	G. F. Schaffer, Washington, D. C.....	1
Do.....	B. D. Stewart, Seabrooke, Md.....	1
Do.....	L. W. Wheeler, Washington, D. C.....	1
Fremont's squirrel.....	G. E. Marsh, Washington, D. C.....	2
Prairie dog.....	J. T. McCaddon, manager Forepaugh shows.....	10
Do.....	G. W. Paschal, Washington, D. C.....	2
Do.....	G. F. Pollock, Washington, D. C.....	1
Woodchuck.....	F. W. Pratt, Washington, D. C.....	1
White rat.....	Miss C. Gilenwater, Washington, D. C.....	2
Do.....	D. M. Smith, Washington, D. C.....	1
Do.....	J. E. Beall, Washington, D. C.....	6
Do.....	P. H. Putton, Washington, D. C.....	3
Opossum.....	F. G. Shaw, Silver Springs, Md.....	1
Great red kangaroo.....	J. T. McCaddon, manager Forepaugh shows.....	1
Golden eagle.....	A. A. Porter, Malta, Ohio.....	1
Do.....	L. M. Hoke, Martinsburg, W. Va.....	1
Bald eagle.....	G. H. Bickman, Washington, D. C.....	1
Do.....	Percy Overton, Fort Washington, Md.....	1
Do.....	C. E. Uber, Washington, D. C.....	1
Do.....	Donor unknown, Luray, Va.....	1
Fishhawk.....	W. Yerkes, Washington, D. C.....	1
Red-tailed hawk.....	R. L. Meyers, Washington, D. C.....	1
Do.....	J. L. Ely, Washington, D. C.....	1
Do.....	J. H. Darling, Brightwood, D. C.....	2
Red-shouldered hawk.....	G. McD. Hampton, Bristol, Tenn.....	1
Barred owl.....	Newman K. Perry, Columbia, S. C.....	2
Great horned owl.....	J. T. McCaddon, manager Forepaugh shows.....	1
Do.....	Mr. Crutchfield, Washington, D. C.....	1
Do.....	Mrs. H. P. Anderson, Washington, D. C.....	1
Do.....	J. H. Brown, Washington, D. C.....	1
Screech owl.....	W. W. Karr, Washington, D. C.....	1
Do.....	J. H. Kuehling, Washington, D. C.....	4
Barn owl.....	J. T. McCaddon, manager Forepaugh shows.....	2

List of accessions—Continued.

ANIMALS PRESENTED—Continued.

Name.	Donor.	Number of specimens.
Barn owl	B. F. Binnix, Seabrooke, Md	2
Red-and-yellow-and-blue macaw.	J. E. Beall, Washington, D. C.	1
Bare-eyed cockatoo	do	1
Crow	E. S. Schmid, Washington, D. C	2
Fantail pigeon	Georgie Green, Georgetown, D. C	1
Curassow	J. E. Beall, Washington, D. C.	1
Peafowl	E. E. Baltzy, Washington, D. C	4
Herring gull.....	Henry H. Kelly, Alexandria, Va.....	1
Muscovy duck.....	H. G. Hubbard, through Prof. C. V. Riley.....	2
Alligator	Mrs. M. Anderson, Washington, D. C	1
Do.....	L. M. Taylor, Washington, D. C.....	2
Loggerhead turtle	United States Fish Commission.....	1
Tortoise	H. G. Hubbard, through Prof. C. V. Riley.....	2
Gilamoster.....	Dr. M. M. Crocker, Gila Bend, Ariz	1
Green lizard.....	J. H. Wynne, Washington, D. C.....	1
Banded rattlesnake.....	Smoot & McCulloh, Salisbury, N. C.....	1
Do.....	H. W. Brion, Okome, Pa.....	4
Diamond rattlesnake	E. S. Schmid, Washington, D. C.....	1
Do.....	James Bell, Gainesville, Fla.....	1
Prairie rattlesnake	L. W. Purinton, Collyer, Kans.....	2
Do.....	Dr. M. M. Crocker, Gila Bend, Ariz.....	1
Copperhead.....	William Dinwiddie, Bureau of Ethnology	24
Boa.....	L. N. O'Dell, Washington, D. C.....	1
Bull snake.....	L. W. Purinton, Banner, Kans.....	4
Blacksnake.....	J. T. McCaddon, manager Forepaugh shows.....	5
Do.....	William Dinwiddie, Bureau of Ethnology	16
Hog-nosed snake	W. A. Davis, Herndon, Va.....	1
Do.....	J. H. Kuehling, Washington, D. C.....	1
Tarantula	G. K. Gilbert, United States Geological Survey.....	1

ANIMALS LENT.

Bonnet monkey.....	Adam Forepaugh shows.....	2
Macaque monkey.....	do	5
Do.....	Wm. Messervy, Washington, D. C.....	1
Rhesus monkey.....	Adam Forepaugh shows.....	17
Sooty mangabey.....	do	2
Yellow baboon.....	do	3
Chaema baboon.....	do	1
Papion	do	1
White-throated cebus	E. S. Schmid, Washington, D. C.....	3
Squirrel monkey.....	do	1
Marmoset	Mrs. W. B. Moses, Washington, D. C	1
Do.....	E. S. Schmid, Washington, D. C.....	1
Lion.....	Adam Forepaugh shows.....	4
Tiger.....	do	1
Puma.....	do	2
Spotted hyena	do	3
Eskimo dog.....	Minor W. Bruce, Washington, D. C.....	5
Gray fox.....	E. S. Schmid, Washington, D. C	2
Gray coati mundi.....	Adam Forepaugh shows.....	1

List of accessions—Continued.

ANIMALS LENT—Continued.

Name.	Donor.	Number of specimens.
Kinkajou.....	E. S. Schmid, Washington, D. C.....	1
Ferret.....	do.....	6
Sumatran rhinoceros.....	Adam Forepaugh shows.....	1
Zebra.....	do.....	1
Domestic ass or "burro".....	C. W. Leannarda, Hyattsville, Md.....	2
Zebu.....	Adam Forepaugh shows.....	4
Common goat.....	E. S. Schmid, Washington, D. C.....	4
Do.....	Adam Forepaugh shows.....	2
Gemsbok.....	do.....	1
Black buck.....	do.....	1
Water buck.....	do.....	1
White-tailed gnu.....	do.....	1
Tora antelope.....	do.....	1
Axis deer.....	do.....	3
Bactrian camel.....	do.....	1
Dromedary.....	do.....	2
Guanaco.....	do.....	1
Alpaca.....	do.....	1
Wart hog.....	do.....	1
Hippopotamus.....	do.....	1
Gray squirrel.....	E. S. Schmid, Washington, D. C.....	10
Gray kangaroo.....	Adam Forepaugh shows.....	4
Great gray kangaroo.....	do.....	1
Green parrot.....	Mrs. A. B. Williams, Washington, D. C.....	1
Do.....	E. S. Schmid, Washington, D. C.....	2
Sulphur-crested cockatoo.....	Dr. H. L. Hayes, Washington, D. C.....	1
Leadbeater's cockatoo.....	do.....	1
Raven.....	E. S. Schmid, Washington, D. C.....	1
Cassowary.....	Adam Forepaugh shows.....	1
European white pelican.....	do.....	1
Black duck.....	E. S. Schmid, Washington, D. C.....	4
Black swan.....	do.....	1
Mute swan.....	do.....	2
Musk turtle.....	do.....	5
Painted turtle.....	do.....	6

ANIMALS RECEIVED IN EXCHANGE.

Lion.....	Barnum & Bailey shows.....	1
Puma.....	do.....	1
Bay lynx.....	E. S. Schmid, Washington, D. C.....	1
Red fox.....	do.....	7
Raccoon.....	do.....	1
Virginia deer.....	do.....	3
Prairie dog.....	do.....	8
Gray kangaroo.....	do.....	1
Red kangaroo.....	do.....	1
Bald eagle.....	do.....	2
Great horned owl.....	do.....	1
Scarlet ibis.....	do.....	1
Swan.....	do.....	2
Pine snake.....	L. N. O'Dell, Washington, D. C.....	1

List of accessions—Continued.

ANIMALS BORN IN THE NATIONAL ZOOLOGICAL PARK.

Bengal monkey (<i>Macacus rhesus</i>)	1
Russian wolf hound	5
Black bear (<i>Ursus americanus</i>)	2
Zebu (<i>Bos indicus</i>)	1
Common goat (<i>Capra hircus</i>)	2
Virginia deer (<i>Cariacus virginianus</i>)	2
American elk (<i>Cervus canadensis</i>)	1
Llama (<i>Luchenia glama</i>)	1
Guinea pig (<i>Cavia aperia</i>)	1
Opossum (<i>Didelphys virginiana</i>)	8
Gray kangaroo (<i>Macropus</i>)	5

ANIMALS CAPTURED IN THE NATIONAL ZOOLOGICAL PARK.

Opossum (<i>Didelphys virginiana</i>)	6
Black snake (<i>Bascanium constrictor</i>)	1

ANIMALS COLLECTED IN THE YELLOWSTONE NATIONAL PARK.

Black bear (<i>Ursus americanus</i>)	1
Grizzly bear (<i>Ursus horribilis</i>)	1
American badger (<i>Taxidea americana</i>)	1
Wolverine (<i>Gulo luscus</i>)	1
Virginia deer (<i>Cariacus virginianus</i>)	1
American elk (<i>Cervus canadensis</i>)	4
Ground squirrel (<i>Spermophilus armatus</i>)	15
American beaver (<i>Castor fiber</i>)	2
Western porcupine (<i>Erethizon dorsatus epixanthus</i>)	1
Red-tailed hawk (<i>Buteo borealis</i>)	1

SUMMARY OF ACCESSIONS.

Animals presented	170
Animals lent	133
Animals received in exchange	31
Animals born in the Zoological Park	29
Animals captured in the Zoological Park	7
Animals received from the Yellowstone National Park	28
Total	398
Number of animals on hand June 30, 1893	504
Accessions during the year ending June 30, 1894	398
Total	902
Deduct—	
Deaths	251
Animals escaped	7
Animals exchanged	26
Animals returned to owners	108
	392
Animals on hand June 30, 1894	510

Respectfully submitted.

Mr. S. P. LANGLEY,
Secretary of the Smithsonian Institution.

FRANK BAKER, *Superintendent.*

APPENDIX V.

REPORT ON THE ASTRO-PHYSICAL OBSERVATORY.

As indicated in my last report, the general work of the Observatory for the fiscal year has continued to be the investigation of the infra-red solar spectrum described in the general body of the report for 1893. This work may conveniently be divided into three parts:

A. General spectrobolographic work.

B. Special spectrobolographic work.

C. Instrumental work, including manufacture of new apparatus and the perfection of old.

A. The general spectrobolographic work of the year may be summed up as follows: (A "bolograph" is an automatic reproduction of the curve representing the distribution of the energy in the infra-red spectrum.)

	Days available for bolographic work.	Number of bolographs taken.	Remarks.
1893.			
July.....	10	21	Observatory closed 5 days. Instrumental equipment improved.
August.....	4	15	Magnetic storm interrupted work during 3 days.
September.....			Instrumental and photographic work exclusively.
October.....	4	10	
November.....	13	41	
December.....	14	36	
1894.			
January.....	10	27	Weather conditions unusually bad.
February.....	1	5	
March.....	3	12	
April.....	7	35	Main Observatory closed 14 days.
May.....	10	52	
June.....			Improving apparatus.

A complete record of these bolographic curves, automatically registered by the apparatus upon glass plates, has been filed for future investigation, the work in its present stage being confined, as has already been stated, to the exploration of this hitherto unexplored region and the identification of its landmarks.

The result of the work has been extremely satisfactory, so far as regards the number and importance of the lines found. The accompanying illustration (see plate) showing a portion of the infra-red spectrum from the region 1.4μ to 2.2μ , beyond what a few years ago was considered the limit of the infra-red spectrum, will show the detail and clearness with which the present apparatus is capable of rendering what can, only in the absence of a better word, be called the "appearance" of this region, since, it must be borne in mind, no human being has senses capable of directly discriminating between these interruptions, or of directly perceiving the form of this display of energy.

The portion of the infra-red spectrum shown, which is that at present furthest advanced, has been gone over several times, and each of the more than 200 lines which occupy this plate has been verified by many observations. The plate shows but a small part of the region which is now being mapped, in all of which it is believed the results will be equally encouraging. Although no investigation has been made of the meaning of the many significant lines in this great and now first

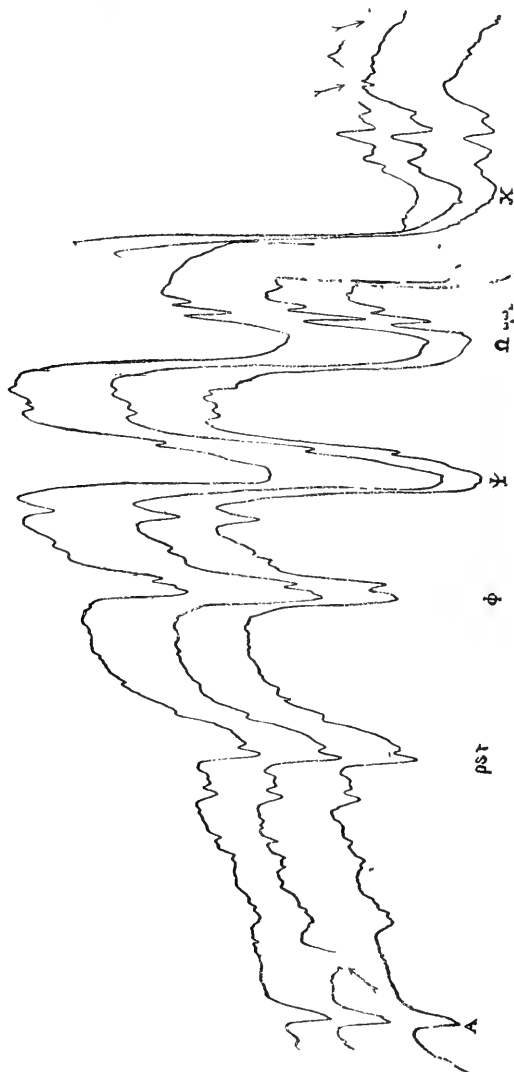
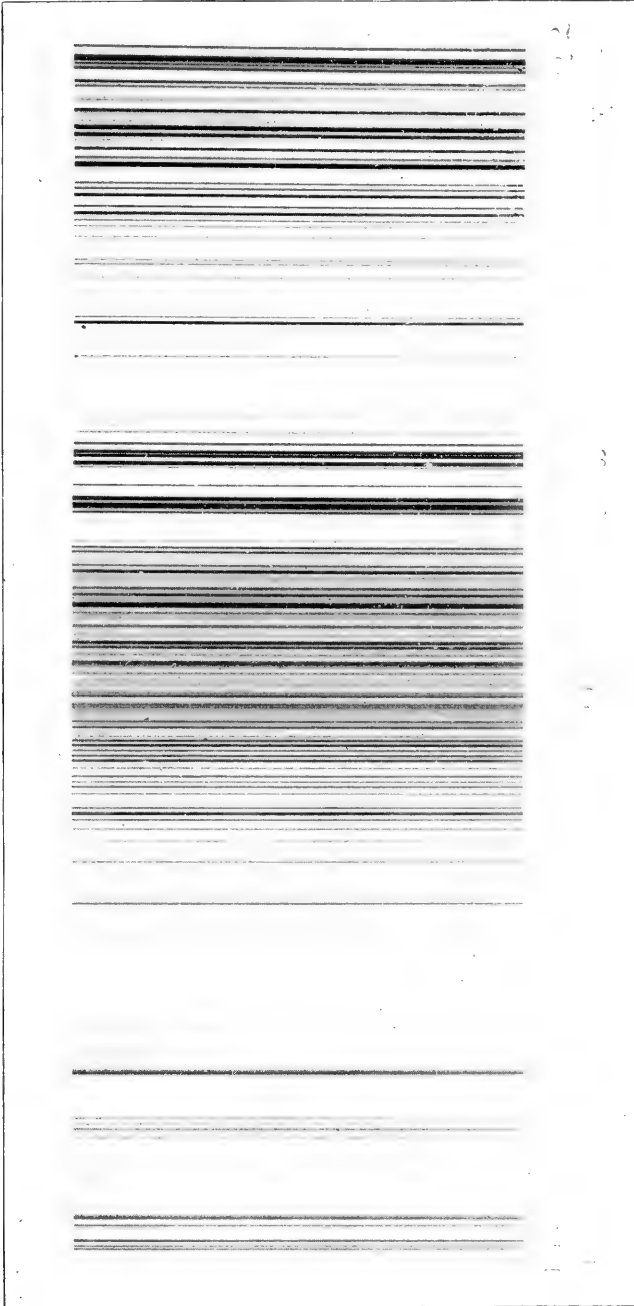

FIG. 1.—Three bollographs superposed.

exhibited region, it is reasonable to think that their study may lead to conclusions of only less importance than those resulting from the similar Fraunhofer lines in the visible spectrum. It is especially believed that the science of meteorology may become indebted to a study of this region for many indications of phenomena which can not now be foretold with any degree of accuracy.



PART OF THE INFRA-RED SPECTRUM.



Three of these bolographs, taken from a large number covering the same region, are shown in the illustration (Fig. 1), in order that the manner of recording the variations in the distribution of the energy in this portion of the spectrum may be shown, as well as the agreement of distinct observations made of the same region at different times.

In order to accomplish this agreement and accuracy in the curves, many changes suggested by experience have had to be made in the apparatus and equipment. The temporary and overcrowded quarters in which this apparatus is stored have been more and more occupied as the mechanical difficulties in the work increased, until now the space is totally inadequate to the needs of such an investigation, while an even more serious difficulty is that the locality is in the neighborhood of street traffic, and disturbed by continual tremors.

B. The special bolographic work which is carried on during days unfavorable for taking observations includes the classification, detailed examination, and finally, the reduction of the bolographs taken into linear translations of the curves, in which the final result is similar, so far as the automatic reduction processes will admit, to the photographs of the visible part of the spectrum.

Much attention has been given to the photographic work, which has presented problems somewhat difficult of solution. Much of the photographic apparatus has had to be specially designed and constructed to fit the peculiar conditions governing its use, but the present process, it is believed, will meet any exigencies of the work.

The work in this direction has kept pace with the original bolographs and I hope soon to be able to issue the preliminary charts covering at least a portion of the region under investigation.

C. What may be called the principal work of the Observatory of this kind during the year has been the improvement of the apparatus and the instrumental conditions, the lines of development being—

- (1) Toward an increase of delicacy.
- (2) Toward increased stability and accuracy.

The galvanometer, whose relative importance in the train of apparatus may almost be compared to that of the brain in the nervous system, has been perfected still further than was noted in my last report.

The utility of these improvements, however, has been, as I have already said, greatly impaired by the situation of the Observatory, close to traveled streets, where it is subject to disturbances of the most annoying kind. This will be better understood when it is considered that the galvanometer never moves very sensibly under a change of temperature on the bolograph of less than a millionth of a degree; that it is on the registry of these minute changes that the whole system of discovery rests, and that false changes can be introduced by the magnetism or the tremor from passing traffic, which so embarrass the observer and enhance his labor that it may be said to be almost hopeless to introduce any great further improvement in this direction till the Observatory occupies a site free from such disturbances, in place of its present temporary and most unsuitable quarters. These interruptions and disturbances, whether magnetic or seismic, have prevented, except at rare and short intervals, the full use of the apparatus in its more delicate capacities.

Apparatus.—The clockwork, upon which depends much of the accuracy and consequently the final efficiency of the observations, has been continually studied and improved.

The siderostat has been under continued improvements suggested by experience, but these will be better described when complete.

The Observatory, during the year, has received from the commissioners of the Russian Government to the World's Fair a very large block of optically fine rock salt from the mines, from which a collimating lens over 7 inches in diameter and a prism 7 inches in height has been wrought (by Brashear), which, it is believed, are the largest of their material in the world. To this prism and lens is due much of the increased efficiency of the whole train of apparatus.

MINOR WORK OF THE YEAR.

A number of direct photographs of a portion of the visible spectrum and as much of the infra-red as could be readily photographed were made by Mr. L. E. Jewell, with the object of comparing direct photographs with bolographs of the same region made under similar conditions.

A number of enlargements of the spectro-bolographic charts already finished have been made with a view to their early publication.

PERSONNEL.

Mr. R. C. Child was appointed to the position of junior assistant on September 1, 1893.

Mr. F. L. O. Wadsworth resigned the position of senior assistant June 1, 1894. On the same date Mr. Child was appointed aid, acting in charge of Observatory.

Mr. F. E. Fowle, jr., was appointed junior assistant on June 1, 1894.

APPENDIX VI.

REPORT OF THE LIBRARIAN FOR THE YEAR ENDING JUNE 30, 1894.

SIR: I have the honor to submit herewith a report upon the operations of the Library of the Smithsonian Institution during the fiscal year ending June 30, 1894.

The work of recording accessions has been conducted as heretofore, each publication being entered as received and given a special number. While this plan causes the exhibit of numbers in excess of volumes received, there is to set off against it the fact that an entire series received at one time is given but a single number.

The numbers in the accession book of the Smithsonian deposit at the Library of Congress extend from 268387 to 292425; in all, 24,038 entries, an increase in numbers over the year 1892-93 of 1,762.

The following tables show the number of volumes, parts of volumes, pamphlets, and charts received during the year:

Publications received between July 1, 1893, and June 30, 1894.

	Quarto or larger.	Octavo or smaller.	Total.
Volumes.....	1,060	1,163	2,223
Parts of volumes.....	18,368	11,666	30,034
Pamphlets.....	736	4,611	5,347
Charts.....			348
Total.....			37,952

This table shows an increase in publications over the year 1892-93 of 8,464.

Of these publications 587 volumes, 10,256 parts of volumes, and 1,575 pamphlets, 12,418 in all, were retained for use in the United States National Museum.

One thousand three hundred and forty-six medical dissertations were deposited in the library of the Surgeon General, United States Army. The remaining publications were sent to the Library of Congress on the Monday after their receipt.

Besides these publications entered in the accession book of the Smithsonian deposit of the Library of Congress there have been entered in the "office book" 1,580 numbers (extending from No. 4089 to No. 5669), representing 1,874 volumes and parts of volumes received, and making a grand total of accessions for the year of 39,826 publications.

This does not include a small number of books and journals purchased for the use of the Astrophysical Observatory and of the Zoological Park.

The following universities have sent academic publications and inaugural dissertations:

Basel,	Giessen,	Kazen,	Pennsylvania.
Berlin,	Göttingen,	Kiel,	Rostock,
Berne,	Greifswald,	Königsburg,	Strassburg,
Bonn,	Halle, A. S.	Leipsic,	Tubingen,
Breslau,	Heidelberg,	Liege,	Utrecht,
Dorpat (Jurjew),	Helsingfors,	Louvain,	Wurzburg,
Erlangen,	Jena,	Lund,	Zurich.
Freiburg,	Johns Hopkins,	Marburg,	

In 1887 you organized a plan for increasing the library by exchanges. Lists of periodicals were secured from the British Museum, several universities, and a great number of leading specialists. These lists were carefully revised and correspondence entered upon with each society and journal there represented. During the year this work was completed. Immediately upon its completion a new list of all scientific publications issued in France was secured, and, after revision, correspondence was entered upon; 1,191 letters asking for publications not on our list, or for numbers to complete the series already in the library, have been written. As a result, 503 new exchanges were acquired by the Institution, while 133 defective series were either completed or added to as far as the publishers were able to supply missing parts. This result is very nearly double that attained last year.

Since 1887, 5,831 letters have been written for the purpose of increasing the number of periodicals and transactions of learned societies in the library; 1,853 new periodicals have been added to the list of those received, and 1,042 defective series have been either wholly or partially completed.

Four thousand two hundred and thirty-six acknowledgments of publications received were made by the post card and other printed forms, while many gifts were acknowledged by special letter.

Three sectional libraries are now established in the Institution—the editor's, the astronomical, and one for works on aerodromics.

In the last report attention was called to the crowded condition of the library offices. Since that time two additional rooms have been assigned, one for a collection of books required for reference, and the other as an office for the librarian. In this reference room, besides cyclopedias and dictionaries, are placed the publications of six of the great scientific societies of the world.

A room has also been set apart for the collections of prints belonging to the Institution. A few of these have been framed and hung upon the walls, the remainder being retained in bound volumes and portfolios.

The card-catalogue record of periodicals received has been transferred from the large cards formerly employed to the smaller card, known as the postal size; a new card catalogue of periodicals in the Institution has also been prepared for the reading room.

The library is governed by the following regulations, which with slight additions were drawn up by the present Secretary some years ago:

CONSTITUTION OF THE CENTRAL LIBRARY.

1. By act of Congress of April 5, 1866, the library of the Smithsonian Institution is to be kept with the Library of Congress, but with the provision that the Institution shall continue to enjoy its customary use of it. The following regulations refer only to those books which under the above proviso are retained at the Smithsonian Institution proper, or in its Museum library.

2. By order of the Secretary, after April 1, 1887, these are placed in the immediate charge of a librarian, whose title shall be "librarian of the Smithsonian Institution," and whose duty it shall be to decide what books shall be retained from the Library of Congress in a central library under his charge. The following regulations are intended for the better execution of the aforesaid order:

SECTIONAL LIBRARIES.

3. Sectional libraries may be formed by the Assistant Secretary, the Chief Clerk, or assistant in charge, and also by the curators and acting curators, and the editor. Curators and acting curators are permitted, subject to the approval of the Assistant Secretary in charge of the Museum, to form sectional libraries to be kept in their respective offices; but this shall only be done by withdrawing from the general collection such books as relate exclusively to the objects under their care. Dictionaries, cyclopedias, journals, or any works other than such as relate exclusively to the

special department, can not form a part of such a sectional library, except upon the recommendation of the librarian, approved by the Assistant Secretary.

4. The official in charge of each sectional library shall be responsible for its safe-keeping and shall on no account lend the books.

5. Books in the sectional library must be returned to the central library before they can be issued for use outside of the office or room to which they are accredited.

6. The books of each sectional library shall be kept separate from all other books in the rooms of the official or curator, in distinct cases, the locks of which shall be controlled by a master key in the hands of the librarian, who may, at stated times, examine them and call the attention of the curators to any deficiencies.

7. No person who is not a member of the scientific staff of the Institution or Museum shall withdraw books or other matter without written permission from the Assistant Secretary of the Smithsonian Institution, the assistant in charge, the curator in charge of the Museum, or the librarian. Persons taking books from the central library shall be responsible for the safe-keeping of the same, and shall make good any losses. They shall not be allowed to withdraw other books until those which are lost have been restored.

8. The librarian shall have authority to decide what books are suitable for any curator's sectional library, and to recall any book not in a sectional library within two weeks. Permanent recalls of books from sectional libraries may be made, as well as temporary calls. In case of certain rare, or costly, or encyclopedic works, or in other special instances, the librarian shall be authorized to designate books which shall in no case be taken from the library. These regulations shall not apply to any books now actually in the office of the editor. All books and other matter not in the sectional library shall be at all times subject to recall by the librarian.

9. The librarian will be expected to exercise his discretion as to the books to be withdrawn from the Congressional Library, but will (in the absence of special cause to the contrary) recall any book upon receiving a written request for the same.

10. The librarian shall annually, or oftener, report to the Secretary any defective series, any missing books, or any new serials or books which are specially desirable.

REGULATIONS CONCERNING ENTRY AND ACKNOWLEDGMENT OF BOOKS.

11. All books, pamphlets, maps, and other publications acquired by the Smithsonian Institution through exchange, or donation, or purchase shall be separately entered by the librarian, who shall prepare reference lists, with the aid of which he shall, immediately upon their receipt from the assistant in charge of office, divide them into two classes; one of which is to be fully entered within a day of its receipt, the other to be fully entered in any case at some time within the current week.

12. It shall be an invariable rule that such a full entry, to consist of both a day-book and a ledger-account entry, shall be made within the above-specified time, for every separate book, or pamphlet, or map, without exception; but it is understood that this ledger account may be in the form of a card catalogue.

13. Against every title there shall be entered in the daybook the letter "C" (Smithsonian Library deposited in Library of Congress), or "G" (Smithsonian Library deposited with Surgeon-General), or "I" (Smithsonian Library deposited at the Institution). Books purchased at the Institution's cost and intended for the Secretary's library, or the office library, shall be entered in a separate book, and it shall be the duty of the librarian to see that all books of the first class are prepared for delivery to the Librarian of Congress within the current week.

14. The librarian shall notify the exchange department within the current week of any new correspondent on his books, and shall also acknowledge receipt to the senders or donors of every article, at stated times, at intervals of not more than a year, and shall make a record of such entry with the date of acknowledgment opposite to the entry of the work in question.

15. It shall be the duty of the librarian at all times to hold these books, in classes "C" and "G," open to the inspection of the Librarian of Congress, and to report to him the place and condition of any work under his charge in answer to any specific inquiry.

16. In addition to the books which are included in the Smithsonian deposit in the Library of Congress, and so stamped, there are certain books procured by the Smithsonian Institution for use in the National Museum. These shall be distinctly marked, and it is understood that, while they form no part of the above-described books of the Smithsonian deposit in the Library of Congress, they are in other respects to be treated in accordance with the above regulations. No book or chart belonging to the Smithsonian Institution is exempt from them unless procured for the specific use of the Secretary, Assistant Secretary, or assistant in charge of the Smithsonian, as above designated, and distinctly stamped as belonging to his office. Under this clause come books purchased especially for the office of the Secretary, Assistant Secretary, or assistant in charge, forming "office libraries." Indispensable books of reference in exchange departments, etc., form part of the Chief Clerk's office library.

This is to be understood as including the books purchased at the expense of the Museum appropriation, but not necessarily the books obtained by exchange for Museum publications, as it would be difficult, if not impossible, always to discriminate these under our present system. This point is reserved for future consideration, but provisionally it is understood that the librarian is to send books to the Library of Congress, if not evidently meant for the Museum.

The books provided for the office of the Secretary, and stamped "Secretary's library," are a distinct class, having no relation to the Library of Congress or to the sectional libraries. They may be lent on application in special cases by the Assistant Secretary or assistant in charge through the librarian. All other books (not forming a portion of the Smithsonian deposit with the Library of Congress, but belonging to the Institution) are stamped "Office library," which includes editor's library, Chief Clerk's office library, and others, and these, as well as those of the Secretary's library, are in the charge of the librarian.

Respectfully submitted.

CYRUS ADLER, *Librarian.*

Mr. S. P. LANGLEY,
Secretary of the Smithsonian Institution.

APPENDIX VII.

REPORT OF THE EDITOR FOR THE YEAR ENDING JUNE 30, 1894.

SIR: I have the honor to submit the following report on the publications of the Smithsonian Institution for the year ending June 30, 1894:

I. SMITHSONIAN CONTRIBUTIONS TO KNOWLEDGE.

The only publication in this series during the past year is No. 884, *The Internal Work of the Wind*, by S. P. Langley, a quarto volume of iii + 23 pages; illustrated with 3 figures in the text and 5 plates. This work is designed to form a part of Volume XXVII of the Smithsonian Contributions to Knowledge, a volume not yet completed, although Volume XXVIII has already been issued, as noticed in last year's list of publications.

II. SMITHSONIAN MISCELLANEOUS COLLECTIONS.

No. 850. *Bibliography of Chemistry, 1492-1892*, by Dr. Henry Carrington Bolton (Smithsonian Miscellaneous Collections, Vol. XXXVI). The first edition of this volume, published in 1892, having been exhausted, a second edition was issued in January, 1894.

No. 856. *An Index of the Genera and Species of the Foraminifera*, by Charles Davis Sherborn. Part I (A to Non), octavo volume of ii + 240 pages.

No. 858. *Proceedings of the Regents, and Report of the Executive Committee for the Year 1890-91, together with Acts of Congress.* (From the Smithsonian Report for 1891.) Octavo pamphlet of 37 pages.

No. 859. *Celestial Spectroscopy*, by William Huggins, F. R. S. (From the Smithsonian Report for 1891.) Octavo pamphlet of 34 pages.

No. 860. *Stellar Numbers and Distances; The Sun's Motion in Space; and A Southern Observatory*, by Agnes M. Clarke. (From the Smithsonian Report for 1891.) Octavo pamphlet of 24 pages, illustrated with 1 diagram.

No. 861. *Some Applications of Physics and Mathematics to Geology*, by C. Chree. (From the Smithsonian Report for 1891.) Octavo pamphlet of 27 pages.

No. 862. *Origin of the Rock Pressure of Natural Gas in the Trenton Limestone of Ohio and Indiana*, by Edward Orton. (From the Smithsonian Report for 1891.) Octavo; 8 pages.

No. 863. *Geysers*, by Walter Harvey Weed, United States Geological Survey. (From the Smithsonian Report for 1891.) Octavo pamphlet of 15 pages; illustrated with 1 figure.

No. 864. *The General Circulation of the Atmosphere*, by Werner von Siemens. (From the Smithsonian Report for 1891.) Octavo pamphlet of 10 pages.

No. 865. *The Gulf Stream*, by Alexander Agassiz. (From the Smithsonian Report for 1891.) Octavo pamphlet of 18 pages; illustrated with 5 figures and 1 plate.

No. 866. *The Absolute Measure of Hardness*, by F. Auerbach. (From the Smithsonian Report for 1891.) Octavo pamphlet of 30 pages; illustrated with 2 figures.

No. 867. *The Flow of Solids*, by William Hallock. (From the Smithsonian Report for 1891.) Octavo pamphlet of 10 pages; illustrated with 4 figures.

No. 868. *The Scientific Work of George Simon Ohm*, by Eugene Lommel. Translated by William Hallock. (From the Smithsonian Report for 1891.) Octavo; 10 pages.

No. 869. Justus von Liebig: an Autobiographical Sketch. Translated from the German, by Prof. J. Campbell Brown. (From the Smithsonian Report for 1891.) Octavo; 12 pages.

No. 870. Divergent Evolution through Cumulative Segregation, by Rev. John Thomas Gulick. (From the Smithsonian Report for 1891.) Octavo pamphlet of 67 pages.

No. 871. The Struggle for Life in the Forest, by James Rodway. (From the Smithsonian Report for 1891.) Octavo pamphlet of 12 pages.

No. 872. Some Difficulties in the Life of Aquatic Insects, by Prof. L. C. Miall. (From the Smithsonian Report for 1891.) Octavo pamphlet of 16 pages.

No. 873. The Geographic Distribution of Life in North America, by C. Hart Merriam, M. D. (From the Smithsonian Report for 1891.) Octavo pamphlet of 51 pages.

No. 874. The Corbin Game Park, by John R. Spears. (From the Smithsonian Report for 1891.) Octavo; 7 pages; illustrated with 1 figure.

No. 875. The Home of the Troglodytes, by E. T. Hamy. (From the Smithsonian Report for 1891.) Octavo; 7 pages.

No. 876. Summary of Progress in Anthropology, by Otis T. Mason. (From the Smithsonian Report for 1891.) Octavo pamphlet of 70 pages.

No. 877. The Mounds of the Mississippi Valley, by Lucien Carr. (From the Smithsonian Report for 1891.) Octavo pamphlet of 97 pages.

No. 878. The use of Flint Blades to work Pine Wood, by G. V. Smith. (From the Smithsonian Report for 1891.) Octavo; 5 pages.

No. 879. Modes of Keeping Time Known Among the Chinese, by D. J. Magowan, M. D. (From the Smithsonian Report for 1891.) Octavo; 6 pages.

No. 880. Navajo Dye-stuffs, by Dr. Washington Matthews. (From the Smithsonian Report for 1891.) Octavo; 3 pages.

No. 881. Some Possibilities of Economic Botany, by George Lincoln Goodale. (From the Smithsonian Report for 1891.) Octavo pamphlet of 30 pages.

No. 882. The Evolution of Commerce, by Gardiner G. Hubbard. (From the Smithsonian Report for 1891.) Octavo pamphlet of 14 pages.

No. 883. The Relation of Natural Science to Art, by Dr. E. du Bois-Reymond, F. R. S. (From the Smithsonian Report for 1891.) Octavo pamphlet of 21 pages.

No. 887. Proceedings of the Regents, and Report of Executive Committee for the Year 1891-92; together with Acts of Congress. (From the Smithsonian Report for 1892.) Octavo pamphlet of 39 pages.

No. 888. The Meteorological Work of the Smithsonian Institution. (From the Smithsonian Report for 1892.) Octavo pamphlet of 6 pages.

No. 889. The History of the Telescope, by Prof. C. S. Hastings. (From the Smithsonian Report for 1892.) Octavo pamphlet of 15 pages.

No. 890. Geological Change and Time, by Sir Archibald Geikie. (From the Smithsonian Report for 1892.) Octavo pamphlet of 20 pages.

No. 891. Geological History of the Yellowstone National Park and Soaping Geysers, by Arnold Hague. (From the Smithsonian Report for 1892.) Octavo pamphlet of 9 pages; illustrated with 1 figure.

No. 892. Continental Problems of Geology, by G. K. Gilbert. (From the Smithsonian Report for 1892.) Octavo pamphlet of 11 pages; illustrated with 5 figures.

No. 894. Hertz's Experiments in Electric Undulations. (From the Smithsonian Report for 1892.) Octavo pamphlet of 25 pages.

No. 895. The Discharge of Electricity through Exhausted Tubes, Without Electrodes, by J. J. Thomson, F. R. S. (From the Smithsonian Report for 1892.) Octavo pamphlet of 26 pages; illustrated with 15 figures.

No. 896. The Molecular Process in Magnetic Induction, by Prof. J. A. Ewing, F. R. S. (From the Smithsonian Report for 1892.) Octavo pamphlet of 13 pages; illustrated with 15 figures.

No. 897. Crystallization, by G. D. Liveing, F. R. S. (From the Smithsonian Report for 1892.) Octavo pamphlet of 12 pages; illustrated with 7 figures.

No. 898. The Rejuvenescence of Crystals, by Prof. John W. Judd, F. R. S. (From the Smithsonian Report for 1892.) Octavo pamphlet of 8 pages.

No. 899. Deduction from the Gaseous Theory of Solution, by Prof. Orme Masson. (From the Smithsonian Report for 1892.) Octavo pamphlet of 13 pages; illustrated with 3 figures.

No. 900. Some Suggestions Regarding Solutions, Liquids, and Gases, by Prof. William Ramsey, F. R. S. (From the Smithsonian Report for 1892.) Octavo pamphlet of 14 pages; illustrated with 2 figures.

No. 901. Present Problems in Evolution and Heredity, by Henry Fairfield Osborn. (From the Smithsonian Report for 1892.) Octavo pamphlet of 62 pages; illustrated with 12 figures.

No. 902. Report on the Migration of Birds, by Prof. Dr. J. A. Palmen. (From the Smithsonian Report for 1892.) Octavo pamphlet of 22 pages; illustrated with 1 plate.

No. 903. The Empire of the Air: an Ornithological Essay on the Flight of Birds, by L. P. Mouillard. (From the Smithsonian Report for 1892.) Octavo pamphlet of 67 pages; illustrated with 14 figures.

No. 904. The Progress of Anthropology in 1892, by Prof. Otis T. Mason. (From the Smithsonian Report for 1892.) Octavo pamphlet of 48 pages.

No. 905. The Advent of Man in America, by Armand de Quatrefages. (From the Smithsonian Report for 1892.) Octavo pamphlet of 8 pages.

No. 906. Primitive Industry, by Thomas Wilson. (From the Smithsonian Report for 1892.) Octavo pamphlet of 14 pages.

No. 907. Prehistoric New Mexican Pottery, by Henry Hales. (From the Smithsonian Report for 1892.) Octavo pamphlet of 20 pages; illustrated with 17 figures.

No. 908. Relics of an Indian Hunting Ground in York County, Pennsylvania, by Atrous Wanner. (From the Smithsonian Report for 1892.) Octavo pamphlet of 16 pages; illustrated with 68 figures.

No. 909. Aboriginal Burial Mounds in Seneca County, Ohio, by Russell J. Thompson. (From the Smithsonian Report for 1892.) Octavo pamphlet of 5 pages; illustrated with 4 figures.

No. 910. Indian Remains on the Upper Yellowstone River, by Col. William S. Brackett. (From the Smithsonian Report for 1892.) Octavo pamphlet of 6 pages; illustrated with 3 figures.

No. 911. Primitive Number Systems, by Levi L. Conant. (From the Smithsonian Report for 1892.) Octavo pamphlet of 12 pages.

No. 912. The Anthropology of the Brain, by D. Kerfoot Shute, M. D. (From the Smithsonian Report for 1892.) Octavo pamphlet of 8 pages.

No. 914. Endowment for Scientific Research and Publication, by Addison Brown. (From the Smithsonian Report for 1892.) Octavo pamphlet of 18 pages.

No. 915. The Inventors of the Telegraph and Telephone, by Prof. Thomas Gray. (From the Smithsonian Report for 1892.) Octavo pamphlet of 20 pages.

No. 916. Explorations in Mongolia and Thibet, by W. Woodville Rockhill. (From the Smithsonian Report for 1892.) Octavo pamphlet of 21 pages; illustrated with 12 figures.

No. 917. Progress of Astronomy for 1891 and 1892, by William C. Winlock. (From the Smithsonian Report for 1892.) Octavo pamphlet of 94 pages.

No. 919. Pre-columbian Copper Mining in North America, by R. L. Packard. (From the Smithsonian Report for 1892.) Octavo pamphlet of 24 pages.

No. 920. The Polynesian Bow, by E. Tregear. (From the Smithsonian Report for 1892.) Octavo pamphlet of 5 pages.

No. 921. The Birth of Invention, by Otis T. Mason. (From the Smithsonian Report for 1892.) Octavo pamphlet of 9 pages.

No 922. American Inventions and Discoveries in Medicine, Surgery, and Practical Sanitation, by John S. Billings, M. D. (From the Smithsonian Report for 1892.) Octavo pamphlet of 8 pages.

No. 923. The Smithsonian Institution, Revised Statutes of the United States, 1878, Title LXXIII, with Amendments to March 12, 1894. Octavo pamphlet of 10 pages.

No. 924. List of Publications of the Smithsonian Institution for Sale or Exchange. May, 1894. Octavo pamphlet of 26 pages.

III. SMITHSONIAN ANNUAL REPORTS.*

No. 848. Annual Report of the Board of Regents of the Smithsonian Institution, showing the operations, expenditures, and condition of the Institution to July, 1891. This volume contains the journal of Proceedings of the Board of Regents at the annual meeting held January 28, 1891; the report of the executive committee of the Board for the year; acts and resolutions of Congress relative to the Institution, and the report of the Secretary of the Institution; concluding with the general appendix, in which are given the following papers: "Celestial spectroscopy," by William Huggins; "Stellar numbers and distances," by A. M. Clerke; "The sun's motion in space," by A. M. Clerke; "A southern observatory," by A. M. Clerke; "Applications of physics and mathematics to geology," by C. Chree; "Origin of the rock pressure of natural gas," by Edward Orton; "Geysers," by Walter Harvey Weed; "The general circulation of the atmosphere," by Werner von Siemens; "The Gulf Stream," by Alexander Agassiz; "Absolute measurement of hardness," by F. Anerbach; "The flow of solids," by William Hallock; "The scientific work of G. S. Ohm," by E. Lommel; "Autobiographical sketch of J. von Liebig;" "Divergent evolution through cumulative segregation," by J. T. Gulick; "The struggle for life in the forest," by James Rodway; "Difficulties of aquatic insects," by L. C. Miall; "Geographic distribution of mammals," by C. Hart Merriam; "The Corbin game park," by John R. Spears; "The home of the troglodytes," by E. T. Hamy; "Summary of progress in anthropology in 1891," by O. T. Mason; "The mounds of the Mississippi Valley," by Lucien Carr; "The use of flint blades to work pine wood," by G. V. Smith; "Time-keeping among the Chinese," by D. J. Magowan; "Navajo dye-stuffs," by Washington Matthews; "Some possibilities of economic botany," by George L. Goodale; "The evolution of commerce," by Gardner Hubbard; "The relation of natural science to art," by E. du Bois-Reymond; the whole forming an octavo volume of xliii+715 pages; illustrated with 36 figures in the text and 1 plate.

No. 853. Report of the United States National Museum. Annual Report of the Board of Regents of the Smithsonian Institution, for the year ending June 30, 1891. This volume comprises five sections: I. "Report of the Assistant Secretary of the Smithsonian Institution, G. Brown Goode, in charge of the National Museum, upon the condition and progress of the Museum." II. "Reports of the curators of the National Museum upon the progress of work during the year." III. Papers describing and illustrating collections in the Museum: "The genesis of the National Museum," by Dr. G. Brown Goode; "Ethnological collections in the Museum from Kilima-Njaro, East Africa," by Dr. W. L. Abbott; "The Bernadou, Allen, and Jony Korean collections in the Museum," by Walter Hough; "Shinto, or the mythology of the Japanese," by Romyn Hitchcock; "The ancient burial mounds of Japan," by Romyn Hitchcock; "Some ancient relics in Japan," by Romyn Hitchcock; "Pre-historic naval architecture of the North of Europe," by George H. Boehmer; "First draft of a system of classification for the World's Columbian Exposition," by Dr. G. Brown Goode. IV. "Bibliography of publications by the Museum, and of papers relating to the Museum, during the year." V. "List of accessions to the Museum

* The papers in the General Appendix of the Annual Reports are also issued separately, as pamphlets, and are noted under "Miscellaneous Collections."

during the year." The whole forms an octavo volume of xvii + 869 pages; illustrated with 154 figures in the text and 84 plates.

No. 885. Annual Report of the Board of Regents of the Smithsonian Institution, showing the operations, expenditures, and condition of the Institution to July, 1892. This volume contains the journal of Proceedings of the Board of Regents, at a special meeting held October 21, 1891, at the annual meeting held January 27, 1892, and at a special meeting held March 29, 1892; the report of the executive committee of the Board for the year; acts and resolutions of Congress relative to the Institution; and the report of the Secretary of the Institution; concluding with the general appendix, in which are given the following papers: "Meteorological work of the Smithsonian Institution;" "The history of the telescope," by C. S. Hastings; "Geological change and time," by Sir Archibald Geike; "Geological history of the Yellowstone National Park," by Arnold Hague; "Soaping geysers," by Arnold Hague; "Continental problems of geology," by G. K. Gilbert; "Pre-columbian copper mining in North America," by R. L. Packard; "The Polynesian bow," by E. Tregear; "Hertz's experiments;" "The discharge of electricity through exhausted tubes without electrodes," by J. J. Thomson; "Molecular process in magnetic induction," by J. A. Ewing; "Crystallization," by G. D. Livinge; "Rejuvenescence of crystals," by John W. Judd; "Deduction from the gaseous theory of solutions," by Orme Masson; "Suggestions regarding solutions," by William Ramsay; "Liquids and gases," by William Ramsay; "Present problems in evolution and heredity," by H. F. Osborn; "Report on the migration of birds," by J. A. Palmer; "The empire of the air," by L. P. Mouillard; "Progress of anthropology in 1892," by O. T. Mason; "The advent of man in America," by A. de Quatrefages; "Primitive industry," by Thomas Wilson; "Prehistoric New Mexican pottery," by Henry Hales; "Relics of an Indian hunting ground," by Atrous Wanner; "Aboriginal burial mounds in Ohio," by R. J. Thompson; "Indian remains on the Upper Yellowstone," by William S. Brackett; "Primitive number systems," by Levi P. Conant; "Anthropology of the brain," by D. Kerfoot Shute; "The birth of invention," by Otis T. Mason; "American inventions and discoveries in medicine, surgery, and practical sanitation," by John S. Billings; "Endowment for scientific research and publication," by Addison Brown; "The inventors of the telegraph and telephone," by Thomas Gray; "Explorations in Mongolia and Thibet," by W. W. Rockhill; "Progress of astronomy for 1891 and 1892," by William C. Winlock; the whole forming an octavo volume of xlix + 811 pages; illustrated with 183 figures.

No. 886. Report of the United States National Museum. Annual Report of the Board of Regents of the Smithsonian Institution for the year ending June 30, 1892. This volume comprises five sections: I. "Report of the Assistant Secretary of the Smithsonian Institution, G. Brown Goode, in charge of the National Museum, upon the condition and progress of the Museum for the year." II. "Reports of the curators of the National Museum upon the progress of work during the year." III. Papers describing and illustrating collections in the Museum: "Japanese wood-cutting and wood-cut printing," communicated by Mr. T. Tokuno, and edited by S. R. Koehler; "The relation of biology to geological investigation," by Dr. Charles A. White; "Scientific taxidermy for museums, based on a study of the United States Government collection," by Dr. R. W. Shufeldt; "The shofar, its use and origin," by Dr. Cyrus Adler; "The Crump burial cave," by Frank Burns; "Minute stone implements from India," by Thomas Wilson; "Comparative oology of North American birds," by Dr. R. W. Shufeldt. IV. "Bibliography of publications by the Museum, and of papers relating to the Museum during the year." V. "List of accessions to the Museum during the year." The whole forms an octavo volume of xv+620 pages; illustrated with 5 figures in the text and 103 plates.

No. 918. Report of S. P. Langley, Secretary of the Smithsonian Institution, for the year ending June 30, 1893, to the Board of Regents of the Institution. Octavo pamphlet of iii + 70 pages; illustrated with 2 plates.

IV.—REPORTS OF THE BUREAU OF ETHNOLOGY.

No. 855. Eighth Annual Report of the Bureau of Ethnology to the Secretary of the Smithsonian Institution, 1886-87, by J. W. Powell, Director. This volume contains the report of the Director, together with accompanying papers, to wit: "A study of Pueblo architecture, Tusayan and Cibola," by Victor Mindeleff; "Ceremonial of Hasjelti Dailjis and mythical sand painting of the Navajoe Indians, by James Stevenson. A royal-octavo volume of xxxvi + 298 pages; illustrated with 118 figures in the text and 123 plates, of which 12 are chromolithographs.

No. 857. Ninth Annual Report of the Bureau of Ethnology to the Secretary of the Smithsonian Institution, 1887-88, by J. W. Powell, Director. This volume contains the report of the Director, together with accompanying papers, to wit: "Ethnological results of the Point Barrow expedition," by John Murdoek; "The medicine men of the Apaches," by John G. Bourke. A royal-octavo volume of xlvi + 617 pages; illustrated with 448 figures in the text and 8 plates, 6 of which are chromolithographs.

No. 966. Tenth Annual Report of the Bureau of Ethnology to the Secretary of the Smithsonian Institution, 1888-89, by J. W. Powell, Director. This volume contains the report of the Director, together with a very comprehensive paper on "Picture writing of the North American Indians," by Garrick Mallery; a royal-octavo volume of xxx + 822 pages; illustrated with 1,290 figures in the text and 54 plates.

Other publications of the National Museum and of the Bureau of Ethnology are enumerated in the reports on those branches of the Institution.

Very respectfully,

WM. B. TAYLOR, *Editor.*

Mr. S. P. LANGLEY,
Secretary of the Smithsonian Institution.

GENERAL APPENDIX

TO THE

SMITHSONIAN REPORT FOR 1894.



ADVERTISEMENT.

The object of the GENERAL APPENDIX to the Annual Report of the Smithsonian Institution is to furnish brief accounts of scientific discovery in particular directions; reports of investigations made by collaborators of the Institution; and memoirs of a general character or on special topics that are of interest or value to the numerous correspondents of the Institution.

It has been a prominent object of the Board of Regents of the Smithsonian Institution, from a very early date, to enrich the annual report required of them by law with memoirs illustrating the more remarkable and important developments in physical and biological discovery, as well as showing the general character of the operations of the Institution; and this purpose has, during the greater part of its history, been carried out largely by the publication of such papers as would possess an interest to all attracted by scientific progress.

In 1880 the Secretary, induced in part by the discontinuance of an annual summary of progress which for thirty years previous had been issued by well-known private publishing firms, had prepared by competent collaborators a series of abstracts, showing concisely the prominent features of recent scientific progress in astronomy, geology, meteorology, physics, chemistry, mineralogy, botany, zoology, and anthropology. This latter plan was continued, though not altogether satisfactorily, down to and including the year 1888.

In the report for 1889 a return was made to the earlier method of presenting a miscellaneous selection of papers (some of them original) embracing a considerable range of scientific investigation and discussion. This method has been continued in the present report, for 1894.

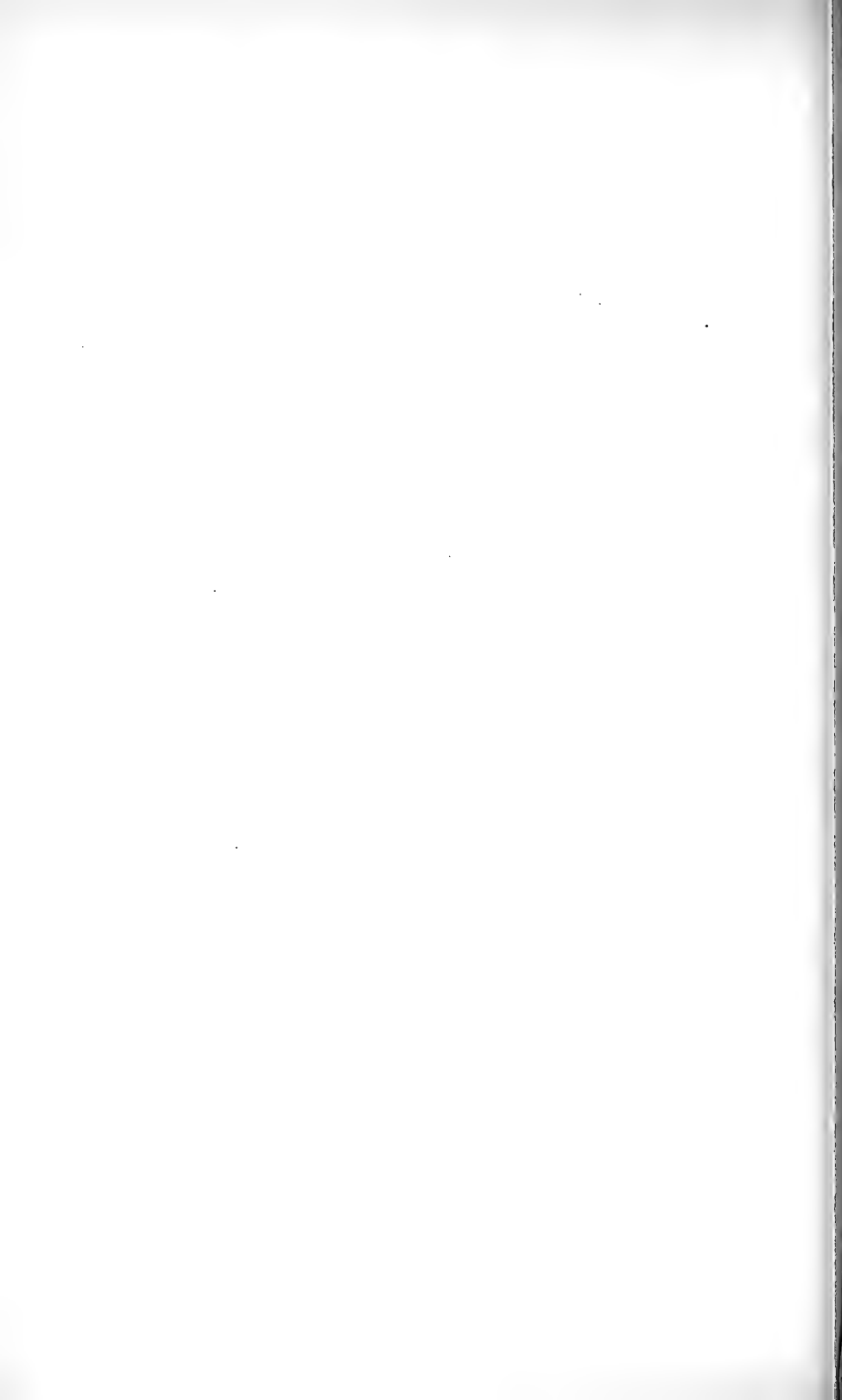

ON THE MAGNITUDE OF THE SOLAR SYSTEM.¹

By WILLIAM HARKNESS.

Nature may be studied in two widely different ways. On the one hand we may employ a powerful microscope which will render visible the minutest forms and limit our field of view to an infinitesimal fraction of an inch situated within a foot of our own noses; or, on the other hand, we may occupy some commanding position, and from thence, aided perhaps by a telescope, we may obtain a comprehensive view of an extensive region. The first method is that of the specialist, the second is that of the philosopher, but both are necessary for an adequate understanding of nature. The one has brought us knowledge wherewith to defend ourselves against bacteria and microbes, which are among the most deadly enemies of mankind, and the other has made us acquainted with the great laws of matter and force upon which rests the whole fabric of science. All nature is one, but for convenience of classification we have divided our knowledge into a number of sciences which we usually regard as quite distinct from each other. Along certain lines, or, more properly, in certain regions, these sciences necessarily abut on each other, and just there lies the weakness of the specialist. He is like a wayfarer who always finds obstacles in crossing the boundaries between two countries, while to the traveler who gazes over them from a commanding eminence the case is quite different. If the boundary is an ocean shore, there is no mistaking it; if a broad river or a chain of mountains, it is still distinct; but if only a line of posts traced over hill and dale, then it becomes lost in the natural features of the landscape, and the essential unity of the whole region is apparent. In that case the border land is wholly a human conception of which nature takes no cognizance, and so it is with the scientific border land to which I propose to invite your attention this evening.

To the popular mind there are no two sciences farther apart than astronomy and geology. The one treats of the structure and mineral

¹ Presidential address delivered before the American Association for the Advancement of Science, at its Brooklyn meeting, August 16, 1894. Printed in *Astronomy and Astro Physics*, Vol. XIII, No. 8; also in *American Journal of Science*, Vol. XLVIII, September, 1894.

constitution of our earth, the causes of its physical features and its history, while the other treats of the celestial bodies, their magnitudes, motions, distances, periods of revolution, eclipses, order, and of the causes of their various phenomena. And yet, many, perhaps I may even say most, of the apparent motions of the heavenly bodies are merely reflections of the motions of the earth, and in studying them we are really studying it. Furthermore, precession, nutation, and the phenomena of the tides depend largely upon the internal structure of the earth, and there astronomy and geology merge into each other. Nevertheless, the methods of the two sciences are widely different, most astronomical problems being discussed quantitatively by means of rigid mathematical formulae, while in the vast majority of cases the geological ones are discussed only qualitatively, each author contenting himself with a mere statement of what he thinks. With precise data the methods of astronomy lead to very exact results, for mathematics is a mill which grinds exceeding fine; but, after all, what comes out of a mill depends wholly upon what is put into it, and if the data are uncertain, as is the case in most cosmological problems, there is little to choose between the mathematics of the astronomer and the guesses of the geologist.

If we examine the addresses delivered by former presidents of this association, and of the sister—perhaps it would be nearer the truth to say the parent—association on the other side of the Atlantic, we shall find that they have generally dealt either with the recent advances in some broad field of science, or else with the development of some special subject. This evening I propose to adopt the latter course, and I shall invite your attention to the present condition of our knowledge respecting the magnitude of the solar system; but in so doing it will be necessary to introduce some considerations derived from laboratory experiments upon the luminiferous ether, others derived from experiments upon ponderable matter, and still others relating both to the surface phenomena and to the internal structure of the earth, and thus we shall deal largely with the border land where astronomy, physics, and geology merge into each other.

The relative distances of the various bodies which compose the solar system can be determined to a considerable degree of approximation with very crude instruments as soon as the true plan of the system becomes known, and that plan was taught by Pythagoras more than five hundred years before Christ. It must have been known to the Egyptians and Chaldeans still earlier, if Pythagoras really acquired his knowledge of astronomy from them, as is affirmed by some of the ancient writers, but on that point there is no certainty. In public Pythagoras seemingly accepted the current belief of his time, which made the earth the center of the universe, but to his own chosen disciples he communicated the true doctrine that the sun occupies the center of the solar system and that the earth is only one of the planets revol-

ing around it. Like all the world's greatest sages, he seems to have taught only orally. A century elapsed before his doctrines were reduced to writing by Philolaus of Crotona, and it was still later before they were taught in public for the first time by Hicetas, or as he is sometimes called Nicetas, of Syracuse. Then the familiar cry of impiety was raised, and the Pythagorean system was eventually suppressed by that now called the Ptolemaic, which held the field until it was overthrown by Copernicus almost two thousand years later. Pliny tells us that Pythagoras believed the distances to the sun and moon to be, respectively, 252,000 and 12,600 stadia, or, taking the stadium at 625 feet, 29,837 and 1,492 English miles; but there is no record of the method by which these numbers were ascertained.

After the relative distances of the various planets are known, it only remains to determine the scale of the system, for which purpose the distance between any two planets suffices. We know little about the early history of the subject, but it is clear that the primitive astronomers must have found the quantities to be measured too small for detection with their instruments, and even in modern times the problem has proved to be an extremely difficult one. Aristarchus, of Samos, who flourished about 270 B. C., seems to have been the first to attack it in a scientific manner. Stated in modern language, his reasoning was that when the moon is exactly half full the earth and sun, as seen from its center, must make a right angle with each other, and by measuring the angle between the sun and moon, as seen from the earth at that instant, all the angles of the triangle joining the earth, sun, and moon would become known, and thus the ratio of the distance of the sun to the distance of the moon would be determined. Although perfectly correct in theory, the difficulty of deciding visually upon the exact instance when the moon is half full is so great that it can not be accurately done, even with the most powerful telescopes. Of course Aristarchus had no telescope, and he does not explain how he effected the observation, but his conclusion was that at the instant in question the distance between the centers of the sun and moon as seen from the earth is less than a right angle by one-thirtieth part of the same. We should now express this by saying that the angle is 87° , but Aristarchus knew nothing of trigonometry, and in order to solve his triangle he had recourse to an ingenious, but long and cumbersome, geometrical process, which has come down to us, and affords conclusive proof of the condition of Greek mathematics at that time. His conclusion was that the sun is nineteen times farther from the earth than the moon, and if we combine that result with the modern value of the moon's parallax, viz, $3,422.38''$, we obtain for the solar parallax $180''$, which is more than twenty times too great.

The only other method of determining the solar parallax known to the ancients was that devised by Hipparchus about 150 B. C. It was based on measuring the rate of decrease of the diameter of the earth's

shadow cone by noting the duration of lunar eclipses, and as the result deduced from it happened to be nearly the same as that found by Aristarchus, substantially his value of the parallax remained in vogue for nearly two thousand years, and the discovery of the telescope was required to reveal its erroneous character. Doubtless this persistency was due to the extreme minuteness of the true parallax, which we now know is far too small to have been visible upon the ancient instruments, and thus the supposed measures of it were really nothing but measures of their inaccuracy.

The telescope was first pointed to the heavens by Galileo in 1609, but it needed a micrometer to convert it into an accurate measuring instrument, and that did not come into being until 1639, when it was invented by William Gascoigne. After his death, in 1644, his original instrument passed to Richard Townley, who attached it to a 14-foot telescope at his residence in Townley, Lancashire, England, where it was used by Flamsteed in observing the diurnal parallax of Mars during its opposition in 1672. A description of Gascoigne's micrometer was published in the *Philosophical Transactions* in 1667, and a little before that a similar instrument had been invented by Auzout, in France, but observatories were fewer then than now, and, so far as I know, J. D. Cassini was the only person beside Flamsteed who attempted to determine the solar parallax from that opposition of Mars. Foreseeing the importance of the opportunity, he had Richer dispatched to Cayenne some months previously, and when the opposition came he effected two determinations of the parallax; one being by the diurnal method, from his own observations in Paris, and the other by the meridian method, from observations in France by himself, Römer, and Picard, combined with those of Richer at Cayenne. This was the transition from the ancient instruments with open sights to telescopes armed with micrometers, and the result must have been little short of stunning to the seventeenth century astronomers, for it caused the hoary and gigantic parallax of about $180''$ to shrink incontinently to $10''$, and thus expanded their conception of the solar system to something like its true dimensions. More than fifty years previously Kepler had argued from his ideas of the celestial harmonies that the solar parallax could not exceed $60''$, and a little later Horrocks had shown on more scientific grounds that it was probably as small as $14''$; but the final death blow to the ancient values—ranging as high as $2'$ or $3'$ —came from these observations of Mars by Flamsteed, Cassini, and Richer.

Of course the results obtained in 1672 produced a keen desire on the part of astronomers for further evidence respecting the true value of the parallax, and as Mars comes into a favorable position for such investigations only at intervals of about sixteen years, they had recourse to observations of Mercury and Venus. In 1677 Halley observed the diurnal parallax of Mercury, and also a transit of that planet across

the sun's disk, at St. Helena, and in 1681 J. D. Cassini and Picard observed Venus when she was on the same parallel with the sun, but although the observations of Venus gave better results than those of Mercury, neither of them was conclusive, and we now know that such methods are inaccurate even with the powerful instruments of the present day. Nevertheless Halley's attempt by means of the transit of Mercury ultimately bore fruit in the shape of his celebrated paper of 1716, wherein he showed the peculiar advantages of transits of Venus for determining the solar parallax. The idea of utilizing such transits for this purpose seems to have been vaguely conceived by James Gregory, or perhaps even by Horrocks, but Halley was the first to work it out completely, and long after his death his paper was mainly instrumental in inducing the Governments of Europe to undertake the observations of the transits of Venus in 1761 and 1769, from which our first accurate knowledge of the sun's distance was obtained.

Those who are not familiar with practical astronomy may wonder why the solar parallax can be got from Mars and Venus, but not from Mercury or the sun itself. The explanation depends upon two facts. Firstly, the nearest approach of these bodies to the earth is for Mars 33,874,000 miles, for Venus 23,654,000 miles, for Mercury 47,935,000 miles, and for the sun 91,239,000 miles. Consequently, for us Mars and Venus have very much larger parallaxes than Mercury or the sun, and of course the larger the parallax the easier it is to measure. Secondly, even the largest of these parallaxes must be determined within far less than one-tenth of a second of the truth, and while that degree of accuracy is possible in measuring short arcs, it is quite unattainable in long ones. Hence, one of the most essential conditions for the successful measurement of parallaxes is that we shall be able to compare the place of the near body with that of a more distant one situated in the same region of the sky. In the case of Mars that can always be done by making use of a neighboring star, but when Venus is near the earth she is also so close to the sun that stars are not available, and consequently her parallax can be satisfactorily measured only when her position can be accurately referred to that of the sun, or, in other words, only during her transits across the sun's disk. But even when the two bodies to be compared are sufficiently near each other, we are still embarrassed by the fact that it is more difficult to measure the distance between the limb of a planet and a star or the limb of the sun than it is to measure the distance between two stars, and since the discovery of so many asteroids that circumstance has led to their use for the determination of the solar parallax. Some of these bodies approach within 75,230,000 miles of the earth's orbit, and as they look precisely like stars, the increased accuracy of pointing on them fully makes up for their greater distance as compared with Mars or Venus.

After the Copernican system of the world and the Newtonian theory of gravitation were accepted it soon became evident that trigonomet-

rical measurements of the solar parallax might be supplemented by determinations based on the theory of gravitation, and the first attempts in that direction were made by Machin in 1729 and T. Mayer in 1753. The measurement of the velocity of light between points on the earth's surface, first effected by Fizeau in 1849, opened up still other possibilities, and thus for determining the solar parallax we have at our command no less than three entirely distinct classes of methods, which are known respectively as the trigonometrical, the gravitational, and the photo-tachymetrical. We have already given a summary sketch of the trigonometrical methods as applied by the ancient astronomers to the dichotomy and shadow cone of the moon, and by the moderns to Venus, Mars, and the asteroids, and we shall next glance briefly at the gravitational and photo-tachymetrical methods.

The gravitational results which enter directly or indirectly into the solar parallax are six in number, to wit: First, the relation of the moon's mass to the tides; second, the relation of the moon's mass and parallax to the force of gravity at the earth's surface; third, the relation of the solar parallax to the masses of the earth and moon; fourth, the relation of the solar and lunar parallaxes to the moon's mass and parallactic inequality; fifth, the relation of the solar and lunar parallaxes to the moon's mass and the earth's lunar inequality; sixth, the relation of the constants of nutation and precession to the moon's parallax.

Respecting the first of these relations it is to be remarked that the tide-producing forces are the attractions of the sun and moon upon the waters of the ocean, and from the ratio of these attractions the moon's mass can readily be determined. But unfortunately the ratio of the solar tides to the lunar tides is affected both by the depth of the sea and by the character of the channels through which the water flows, and for that reason the observed ratio of these tides requires multiplication by a correcting factor in order to convert it into the ratio of the forces. The matter is further complicated by this correcting factor varying from port to port, and in order to get satisfactory results long series of observations are necessary. The labor of deriving the moon's mass in this way was formerly so great that for more than half a century Laplace's determination from the tides at Brest remained unique; but the recent application of harmonic analysis to the data supplied by self-registering tide gauges is likely to yield abundant results in the near future.

Our second gravitational relation, viz, that connecting the moon's mass and parallax with the force of gravity at the earth's surface, affords an indirect method of determining the moon's parallax with very great accuracy if the computation is carefully made, and with a fair approximation to the truth even when the data are exceedingly crude. To illustrate this, let us see what could be done with a railroad transit such as is commonly used by surveyors, a steel tape, and a fairly good watch. Neglecting small corrections due to the flattening of the

earth, the centrifugal force at its surface, the eccentricity of its orbit and the mass of the moon, the law of gravitation shows that if we multiply together the length of the seconds pendulum, the square of the radius of the earth, and the square of the length of the sidereal month, divide the product by four, and take the cube root of the quotient, the result will be the distance from the earth to the moon. To find the length of the seconds pendulum we would rate the watch by means of the railroad transit, and then making a pendulum out of a spherical leaden bullet suspended by a fine thread, we would adjust the length of the thread until the pendulum made exactly three hundred vibrations in five minutes by the watch. Then, supposing the experiment to be made here or in New York City, we would find that the distance from the point of suspension of the thread to the center of the bullet was about $39\frac{1}{2}$ inches, and dividing that by the number of inches in a mile, viz, 63,360, we would have for the length of the seconds pendulum one sixteen hundred and twentieth of a mile. The next step would be to ascertain the radius of the earth, and the quickest way of doing so would probably be, first, to determine the latitude of some point in New York City by means of the railroad transit; next to run a traverse survey along the old post-road from New York to Albany, and finally to determine the latitude of some point in Albany. The traverse survey should surely be correct to one part in three hundred, and as the distance between the two cities is about 2° the difference of latitude might be determined to about the same percentage of accuracy. In that way we would find the length of 2° of latitude to be about 138 miles, whence the earth's radius would be 3,953 miles. It would then only remain to observe the time occupied by the moon in making a sidereal revolution around the earth, or, in other words, the time which she occupies in moving from any given star back to the same star again. By noting that to within one-quarter of her own diameter we would soon find that the time of revolution is about 27.32 days, and multiplying that by the number of seconds in a day, viz, 86,400, we would have for the length of the sidereal month 2,360,000 seconds. With these data the computation would stand as follows: The radius of the earth, 3,953 miles, multiplied by the length of a sidereal month, 2,360,000 seconds, and the product squared gives 87,060,000,000,000,000. Multiplying that by one-fourth of the length of the seconds pendulum, viz, one sixty-four hundred and eightieth of a mile, and extracting the cube root of the product, we would get 237,700 miles for the distance from the earth to the moon, which is only about 850 miles less than the truth, and certainly a remarkable result considering the crudeness of the instruments by which it might be obtained. Nevertheless, when all the conditions are rigorously taken into account these data are to be regarded as determining the relation between the moon's mass and parallax, rather than the parallax itself.

Our third gravitational relation, to wit, that existing between the solar parallax, the solar attractive force, and the masses of the earth and moon, is analogous to the relation existing between the moon's mass and parallax and the force of gravity at the earth's surface, but it can not be applied in exactly the same way on account of our inability to swing a pendulum on the sun. We are therefore compelled to adopt some other method of determining the sun's attractive force, and the most available is that which consists in observing the perturbative action of the earth and moon upon our nearest planetary neighbors—Venus and Mars. From this action the law of gravitation enables us to determine the ratio of the sun's mass to the combined masses of the earth and moon, and then the relation in question furnishes a means of comparing the masses so found with trigonometrical determinations of the solar parallax. Thus it appears that notwithstanding necessary differences in the methods of procedure, the analogy between the second and third gravitational relations holds not only with respect to their theoretical basis, but also in their practical application, the one being used to determine the relation between the mass of the moon and its distance from the earth, and the other to determine the relation between the combined masses of the earth and moon and their distance from the sun.

Our fourth gravitational relation deals with the connection between the solar parallax, the lunar parallax, the moon's mass, and the moon's parallactic inequality. The important quantities are here the solar parallax and the moon's parallactic inequality, and although the derivation of the complete expression for the connection between them is a little complicated, there is no difficulty in getting a general notion of the forces involved. As the moon moves around the earth she is alternately without and within the earth's orbit. When she is without, the sun's attraction on her acts with that of the earth; when she is within, the two attractions act in opposite directions. Thus in effect the centripetal force holding the moon to the earth is alternately increased and diminished, with the result of elongating the moon's orbit toward the sun and compressing it on the opposite side. As the variation of the centripetal force is not great, the change of form of the orbit is small; nevertheless, the summation of the minute alterations thereby produced in the moon's orbital velocity suffices to put her sometimes ahead and sometimes behind her mean place to an extent which oscillates from a maximum to a minimum, as the earth passes from perihelion to aphelion, and averages about $125''$ of arc. This perturbation of the moon is known as the parallactic inequality, because it depends on the earth's distance from the sun, and can therefore be expressed in terms of the solar parallax. Conversely, the solar parallax can be deduced from the observed value of the parallactic inequality, but unfortunately there are great practical difficulties in making the requisite observations with a sufficient degree of accuracy. Notwithstanding the ever-recurring

talk about the advantages to be obtained by observing a small, well-defined crater instead of the moon's limb, astronomers have hitherto found it impracticable to use anything but the limb, and the disadvantage of doing so, as compared with observing a star, is still further increased by the circumstance that in general only one limb can be seen at a time, the other being shrouded in darkness. If both limbs could always be observed we should then have a uniform system of data for determining the place of the center, but under existing circumstances we are compelled to make our observations half upon one limb and half upon the other, and thus they involve all the systematic errors which may arise from the conditions under which these limbs are observed, and all the uncertainty which attaches to irradiation, personal equation, and our defective knowledge of the moon's semidiameter.

Our fifth gravitational relation is that which exists between the solar parallax, the lunar parallax, the moon's mass, and the earth's lunar inequality. Strictly speaking the moon does not revolve around the earth's center, but both bodies revolve around the common center of gravity of the two. In consequence of that an irregularity arises in the earth's orbital velocity around the sun, the common center of gravity moving in accordance with the laws of elliptic motion, while the earth, on account of its revolution around that center, undergoes an alternate acceleration and retardation which has for its period a lunar month, and is called the lunar inequality of the earth's motion. We perceive this inequality as an oscillation superposed on the elliptic motion of the sun, and its semiamplitude is the measure of the angle subtended at the sun by the interval between the center of the earth and the common center of gravity of the earth and moon. Just as an astronomer on the moon might use the radius of her orbit around the earth as a base for measuring her distance from the sun, so we may use this interval for the same purpose. We find its length in miles from the equatorial semidiameter of the earth, the moon's parallax, and the moon's mass, and thus we have all the data for determining the solar parallax from the inequality in question. In view of the great difficulty which has been experienced in measuring the solar parallax itself, it may be asked, Why we should attempt to deal with the parallactic inequality, which is about 26 per cent smaller? The answer is, Because the latter is derived from differences of the sun's right ascension, which are furnished by the principal observatories in vast numbers, and should give very accurate results on account of their being made by methods which insure freedom from constant errors. Nevertheless, the sun is not so well adapted for precise observations as the stars, and Dr. Gill has recently found that heliometer measurements upon asteroids which approach very near to the earth yield values of the parallactic inequality superior to those obtained from right ascensions of the sun.

Our sixth gravitational relation is that which exists between the moon's parallax and the constants of precession and nutation. Every

particle of the earth is attracted both by the sun and by the moon, but in consequence of the polar flattening the resultant of these attractions passes a little to one side of the earth's center of gravity. Thus a couple is set up, which, by its action upon the rotating earth, causes the axis thereof to describe a surface which may be called a fluted cone, with its apex at the earth's center. A top spinning with its axis inclined describes a similar cone, except that the flutings are absent and the apex is at the point upon which the spinning occurs. For convenience of computation we resolve this action into two components, and we name that which produces the cone the luni-solar precession, and that which produces the flutings the nutation. In this phenomenon the part played by the sun is comparatively small, and by eliminating it we obtain a relation between the luni-solar precession, the nutation, and the moon's parallax which can be used to verify and correct the observed values of these quantities.

In the preceding paragraph we have seen that the relation between the quantities there considered depends largely upon the flattening of the earth, and thus we are led to inquire how and with what degree of accuracy that is determined. There are five methods—viz, one geodetic, one gravitational, and three astronomical. The geodetic method depends upon measurements of the length of a degree on various parts of the earth's surface; and with the data hitherto accumulated it has proved quite unsatisfactory. The gravitational method consists in determining the length of the seconds pendulum over as great a range of latitude as possible, and deducing therefrom the ratio of the earth's polar and equatorial semidiameters by means of Clairaut's theorem. The pendulum experiments show that the earth's crust is less dense on mountain plateaus than at the seacoast, and thus for the first time we are brought into contact with geological considerations. The first astronomical method consists in observing the moon's parallax from various points on the earth's surface; and as these parallaxes are nothing else than the angular semidiameter of the earth at the respective points, as seen from the moon, they afford a direct measure of the flattening. The second and third astronomical methods are based upon certain perturbations of the moon which depend upon the figure of the earth, and should give extremely accurate results; but unfortunately very great difficulties oppose themselves to the exact measurement of the perturbations. There is also an astronomico-geological method which can not yet be regarded as conclusive on account of our lack of knowledge respecting the law of density which prevails in the interior of the earth. It is based upon the fact that a certain function of the earth's moments of inertia can be determined from the observed values of the coefficients of precession and nutation, and could also be determined from the figure and dimensions of the earth if we knew the exact distribution of matter in its interior. Our present knowledge on that subject is limited to a superficial layer not more than 10 miles thick,

but it is usual to assume that the deeper matter is distributed, according to Lagrange's law, and then by writing the function in question in a form which leaves the flattening indeterminate, and equating the expression so found to the value given by the precession and nutation, we readily obtain the flattening. As yet these methods do not give consistent results, and so long as serious discrepancies remain between them there can be no security that we have arrived at the truth.

It should be remarked that in order to compute the function of the earth's moments of inertia which we have just been considering, we require not only the figure and dimensions of the earth and the law of distribution of density in its interior, but also its mean and surface densities. The experiments for determining the mean density have consisted in comparing the earth's attraction with the attraction either of a mountain or of a known thickness of the earth's crust or of a known mass of metal. In the case of mountains the comparisons have been made with plumb lines and pendulums; in the case of known layers of the earth's crust they have been made by swinging pendulums at the surface and down in mines; and in the case of known masses of metal they have been made with torsion balances, fine chemical balances, and pendulums. The surface density results from a study of the materials composing the earth's crust, but notwithstanding the apparent simplicity of that process it is doubtful if we have yet attained as accurate a result as in the case of the mean density.

Before quitting this part of our subject it is important to point out that the luni-solar precession can not be directly observed, but must be derived from the general precession. The former of these qualities depends only upon the action of the sun and moon, while the latter is affected in addition by the action of all the planets, and to ascertain what that is we must determine their masses. The methods of doing so fall into two great classes, according as the planets dealt with have or have not satellites. The most favorable case is that in which one or more satellites are present, because the mass of the primary follows immediately from their distances and revolution times; but even then there is a difficulty in the way of obtaining very exact results. By extending the observations over sufficiently long periods the revolution times may be ascertained with any desired degree of accuracy; but all measurements of the distance of a satellite from its primary are affected by personal equation, which we can not be sure of completely eliminating, and thus a considerable margin of uncertainty is brought into the masses. In the cases of Mercury and Venus, which have no satellites, and to a certain extent in the case of the earth also, the only available way of ascertaining the masses is from the perturbations produced by the action of the various planets on each other. These perturbations are of two kinds, periodic and secular. When sufficient data have been accumulated for the exact determination of the secular perturbations they will give the best results, but as yet it remains advantageous to employ the periodic perturbations also.

Passing now to the photo-tachymetrical methods, we have first to glance briefly at the mechanical appliances by which the tremendous velocity of light has been successfully measured. They are of the simplest possible character, and are based either upon a toothed wheel or upon a revolving mirror.

The toothed-wheel method was first used by Fizeau, in 1849. To understand its operation, imagine a gun barrel with a toothed wheel revolving at right angles to its muzzle in such a way that the barrel is alternately closed and opened as the teeth and the spaces between them pass before it. Then, with the wheel in rapid motion, at the instant when a space is opposite the muzzle let a ball be fired. It will pass out freely, and after traversing a certain distance let it strike an elastic cushion and be reflected back upon its own path. When it reaches the wheel, if it hits a space it will return into the gun barrel, but if it hits a tooth it will be stopped. Examining the matter a little more closely we see that, as the ball requires a certain time to go and return, if during that time the wheel moves through an odd multiple of the angle between a space and a tooth the ball will be stopped, while if it moves through an even multiple of that angle the ball will return into the barrel. Now imagine the gun barrel, the ball, and the elastic cushion to be replaced, respectively, by a telescope, a light wave, and a mirror. Then if the wheel moved at such a speed that the returning light wave struck against the tooth following the space through which it issued, to an eye looking into the telescope all would be darkness. If the wheel moved a little faster and the returning light wave passed through the space succeeding that through which it issued, the eye at the telescope would perceive a flash of light, and if the speed was continuously increased a continual succession of eclipses and illuminations would follow each other according as the returning light was stopped against a tooth or passed through a space farther and farther behind that through which it issued. Under these conditions the time occupied by the light in traversing the space from the wheel to the mirror and back again would evidently be the same as the time required by the wheel to revolve through the angle between the space through which the light issued and that through which it returned, and thus the velocity of light would become known from the distance between the telescope and the mirror, together with the speed of the wheel. Of course the longer the distance traversed and the greater the velocity of the wheel the more accurate would be the result.

The revolving-mirror method was first used by Foucault in 1862. Conceive the toothed wheel of Fizeau's apparatus to be replaced by a mirror attached to a vertical axis and capable of being put into rapid rotation. Then it will be possible so to arrange the apparatus that light issuing from the telescope shall strike the movable mirror and be reflected to the distant mirror, whence it will be returned to the movable mirror again, and being thrown back into the telescope will appear

as a star in the center of the field of view. That adjustment being made, if the mirror were caused to revolve at a speed of some hundred turns per second it would move through an appreciable angle while the light was passing from it to the distant mirror and back again, and in accordance with the laws of reflection, the star in the field of the telescope would move from the center by twice the angle through which the mirror had turned. Thus the deviation of the star from the center of the field would measure the angle through which the mirror turned during the time occupied by light in passing twice over the interval between the fixed and revolving mirrors, and from the magnitude of that angle, together with the known speed of the mirror, the velocity of the light could be calculated.

In applying either of these methods the resulting velocity is that of light when traversing the earth's atmosphere, but what we want is its velocity in space, which we suppose to be destitute of ponderable material, and in order to obtain that the velocity in the atmosphere must be multiplied by the refractive index of air. The correct velocity so obtained can then be used to find the solar parallax, either from the time required by light to traverse the semidiameter of the earth's orbit, or from the ratio of the velocity of light to the orbital velocity of the earth.

Any periodic correction which occurs in computing the place of a heavenly body or the time of a celestial phenomenon is called by astronomers an equation, and as the time required by light to traverse the semidiameter of the earth's orbit first presented itself in the guise of a correction to the computed times of the eclipses of Jupiter's satellites, it has received the name of the light equation. The earth's orbit being interior to that of Jupiter, and both having the sun for their center, it is evident that the distances between the two planets must vary from the sum to the difference of the radii of their respective orbits, and the time required by light to travel from one planet to the other must vary proportionately. Consequently, if the observed times of the eclipses of Jupiter's satellites are compared with the times computed upon the assumption that the two planets are always separated by their mean distance, it will be found that the eclipses occur too early when the earth is at less than its mean distance from Jupiter, and too late when it is farther off, and from large numbers of such observations the value of the light equation has been deduced.

The combination of the motion of light through our atmosphere with the orbital motion of the earth gives rise to the annual aberration, all the phases of which are computed from its maximum value, commonly called the constant of aberration. There is also a diurnal aberration due to the rotation of the earth on its axis, but that is quite small and does not concern us this evening. When aberration was discovered the corpuscular theory of light was in vogue, and it offered a charmingly simple explanation of the whole phenomenon. The hypothetical

light corpuscles impinging upon the earth were thought to behave precisely like the drops in a shower of rain, and you all know that their apparent direction is affected by any motion on the part of the observer. In a calm day, when the drops are falling perpendicularly, a man standing still holds his umbrella directly over his head, but as soon as he begins to move forward he inclines his umbrella in the same direction, and the more rapidly he moves the greater must be its inclination in order to meet the descending shower. Similarly, the apparent direction of oncoming light corpuscles would be affected by the orbital motion of the earth, so that in effect it would always be the resultant arising from combining the motion of the light with a motion equal and opposite to that of the earth. But since the falsity of the corpuscular theory has been proved that explanation is no longer tenable, and as yet we have not been able to replace it with anything equally satisfactory based on the now universally accepted undulatory theory. In accordance with the latter theory we must conceive the earth as plowing its way through the ether, and the point which has hitherto baffled us is whether or not in so doing it produces any disturbance of the ether which affects the aberration. In our present ignorance on that point we can only say that the aberration constant is certainly very nearly equal to the ratio of the earth's orbital velocity to the velocity of light, but we can not affirm that it is rigorously so.

The luminiferous ether was invented to account for the phenomena of light, and for two hundred years it was not suspected of having any other function. The emission theory postulated only the corpuscles which constitute light itself, but the undulatory theory fills all space with an imponderable substance possessing properties even more remarkable than those of ordinary matter, and to some of the acutest intellects the magnitude of this idea has proved an almost insuperable objection against the whole theory. So late as 1862 Sir David Brewster, who had gained a world-wide reputation by his optical researches, expressed himself as staggered by the notion of filling all space with some substance merely to enable a little twinkling star to send its light to us; but not long after Clerk Maxwell removed that difficulty by a discovery coextensive with the undulatory theory itself. Since 1845, when Faraday first performed his celebrated experiment of magnetizing a ray of light, the idea that electricity is a phenomenon of the ether had been steadily growing, until at last Maxwell perceived that if such were the fact the rate of propagation of an electro-magnetic wave must be the same as the velocity of light. At that time no one knew how to generate such waves, but Maxwell's theory showed him that their velocity must be equal to the number of electric units of quantity in the electro-magnet unit, and careful experiments soon proved that that is the velocity of light. Thus it was put almost beyond the possibility of doubt that the ether gives rise to the phenomena of electricity and magnetism as well as to those of light, and perhaps it may

even be concerned in the production of gravitation itself. What could be apparently more remote than these electric quantities and the solar parallax? And yet we have here a relation between them, but we make no use of it because as yet the same relation can be far more accurately determined from experiments upon the velocity of light.

Now, let us recall the quantities and methods of observation which we have found to be involved, either directly or indirectly, with the solar parallax. They are, the solar parallax, obtained from transits of Venus, oppositions of Mars, and oppositions of certain asteroids; the lunar parallax, found both directly and from measurements of the force of gravity at the earth's surface; the constants of precession, nutation, and aberration, obtained from observations of the stars; the parallactic inequality of the moon; the lunar inequality of the earth, usually obtained from observations of the sun, but recently found from heliometer observations of certain asteroids; the mass of the earth, found from the solar parallax and also from the periodic and secular perturbations of Venus and Mars; the mass of the moon, found from the lunar inequality of the earth and also from the ratio of the solar and lunar components of the ocean tides; the masses of all the planets, obtained from observations of their satellites whenever possible, and when no satellites exist, then from observations of their mutual perturbations, both periodic and secular; the velocity of light, obtained from experiments with revolving mirrors and toothed wheels, together with laboratory determinations of the index of refraction of atmospheric air; the light equation, obtained from observations of the eclipses of Jupiter's satellites; the figure of the earth, obtained from geodetic triangulations, measurements of the length of the seconds pendulum in various latitudes, and observations of certain perturbations of the moon; the mean density of the earth, obtained from measurements of the attractions of mountains, from pendulum experiments in mines, and from experiments on the attraction of known masses of matter made either with torsion balances or with the most delicate chemical balances; the surface density of the earth, obtained from geological examinations of the surface strata; and, lastly, the law of distribution of density in the interior of the earth, which in the present state of geological knowledge we can do little more than guess at.

Here, then, we have a large group of astronomical, geodetic, geological and physical quantities which must all be considered in finding the solar parallax, and which are all so entangled with each other that no one of them can be varied without affecting all the rest. It is therefore impossible to make an accurate determination of any one of them apart from the remainder of the group, and thus we are driven to the conclusion that they must all be determined simultaneously. Such has not been the practice of astronomers in the past, but it is the method to which they must inevitably resort in the future. A cursory glance at an analogous problem occurring in geodesy may be instructive.

When a country is covered with a net of triangles it is always found that the observed angles are subject to a certain amount of error, and a century ago it was the habit to correct the angles in each triangle without much regard to the effect upon adjacent triangles. Consequently the adjustment of the errors was imperfect, and in computing the interval between any two distant points the result would vary somewhat with the triangles used in the computation—that is, if one computation was made through a chain of triangles running around on the right-hand side, another through a chain of triangles running straight between the two points, and a third through a chain of triangles running around on the left-hand side, the results were usually all different. At that time things were less highly specialized than now, and all geodetic operations were yet in the hands of first-rate astronomers, who soon devised processes for overcoming the difficulty. They imagined every observed angle to be subject to a small correction, and as these corrections were all entangled with each other through the geometrical conditions of the net, by a most ingenious application of the method of least squares they determined them all simultaneously in such a way as to satisfy the whole of the geometrical conditions. Thus the best possible adjustment was obtained, and no matter what triangles were used in passing from one point to another, the result was always the same. That method is now applied to every important triangulation, and its omission would be regarded as proof of incompetency on the part of those in charge of the work.

Now let us compare the conditions existing respectively in a triangulation net and in the group of quantities for the determination of the solar parallax. In the net every angle is subject to a small correction, and the whole system of corrections must be so determined as to make the sum of their weighted squares a minimum and at the same time satisfy all the geometrical conditions of the net. Like the triangles, the quantities composing the group from which the solar parallax must be determined are all subject to error, and therefore we must regard each of them as requiring a small correction, and all these corrections must be so determined as to make the sum of their weighted squares a minimum, and at the same time satisfy every one of the equations expressing the relations between the various components of the group.

Thus it appears that the method required for adjusting the solar parallax and its related constants is in all respects the same as that which has so long been used for adjusting systems of triangulation, and as the latter method was invented by astronomers, it is natural to inquire Why have they not applied it to the fundamental problem of their own science? The reasons are various, but they may all be classed under two heads: First, an inveterate habit of overestimating the accuracy of our own work as compared with that of others; and second, the unfortunate effect of too much specialization.

The prevailing opinion certainly is that great advances have recently been made in astronomy, and so they have in the fields of spectral analysis and in the measurement of minute quantities of radiant heat; but the solution of the vast majority of astronomical problems depends upon the exact measurement of angles, and in that little or no progress has been made. Bradley, with his zenith sector a hundred and fifty years ago, and Bessel and Struve, with their circles and transit instruments seventy years ago, made observations not sensibly inferior to those of the present day, and indeed it would have been surprising if they had not done so. The essentials for accurately determining star places are a skilled observer, a clock, and a transit circle, the latter consisting of a telescope, a divided circle, and four micrometer microscopes. Surely no one will claim that we have to-day any more skillful observers than were Bessel, Bradley, and Struve, and the only way in which we have improved upon the telescopes made by Dollond one hundred and thirty years ago is by increasing their aperture and relatively diminishing their focal distance. The most famous dividing engine now in existence was made by the elder Repsold seventy-five years ago; but as the errors of divided circles and their micrometer microscopes are always carefully determined, the accuracy of the measured angles is quite independent of any small improvement in the accuracy of the divisions or of the micrometer screws. Only in the matter of clocks has there been some advance, and even that is not very great. On the whole, the star places of to-day are a little better than those of seventy-five years ago, but even yet there is great room for improvement. One of the commonest applications of these star places is to the determination of latitude, but it is very doubtful if there is any point on the face of the earth whose latitude is known certainly within one-tenth of a second.

Looking at the question from another point of view, it is notorious that the contact observations of the transits of Venus in 1761 and 1769 were so discordant that from the same observations Encke and E. J. Stone got respectively for the solar parallax $8.59''$ and $8.91''$. In 1870 no one thought it possible that there could be any difficulty with the contact observations of the then approaching transits of 1874 and 1882, but we have found from sad experience that our vaunted modern instruments gave very little better results for the last pair of transits than our predecessors obtained with much cruder appliances in 1761 and 1769.

The theory of probability and uniform experience alike show that the limit of accuracy attainable with any instrument is soon reached; and yet we all know the fascination which continually lures us on in our efforts to get better results out of the familiar telescopes and circles which have constituted the standard equipment of observatories for nearly a century. Possibly these instruments may be capable of indicating somewhat smaller quantities than we have hitherto succeeded

in measuring with them, but their limit can not be far off, because they already show the disturbing effects of slight inequalities of temperature and other uncontrollable causes. So far as these effects are accidental they eliminate themselves from every long series of observations, but there always remains a residuum of constant error, perhaps quite unsuspected, which gives us no end of trouble. Encke's value of the solar parallax affords a fine illustration of this. From the transits of Venus in 1761 and 1769 he found $8.58''$ in 1824, which he subsequently corrected to $8.57''$, and for thirty years that value was universally accepted. The first objection to it came from Hansen in 1854, a second followed from Leverrier in 1858, both based upon facts connected with the lunar theory, and eventually it became evident that Encke's parallax was about one-fourth of a second too small.

Now please observe that Encke's value was obtained trigonometrically, and its inaccuracy was never suspected until it was revealed by gravitational methods, which were themselves in error about one-tenth of a second and required subsequent correction in other ways. Here, then, was a lesson to astronomers, who are all more or less specialists, but it merely enforced the perfectly well-known principle that the constant errors of any one method are accidental errors with respect to all other methods, and therefore the readiest way of eliminating them is by combining the results from as many different methods as possible. However, the abler the specialist the more certain he is to be blind to all methods but his own, and astronomers have profited so little by the Encke-Hansen-Leverrier incident of thirty-five years ago that to-day they are mostly divided into two great parties, one of whom holds that the parallax can be best determined from a combination of the constant of aberration with the velocity of light and the other believes only in the results of heliometer measurements upon asteroids. By all means continue the heliometer measurements and do everything possible to clear up the mystery which now surrounds the constant of aberration, but why ignore the work of predecessors who were quite as able as ourselves? If it were desired to determine some one angle of a triangulation net with special exactness, what would be thought of a man who attempted to do so by repeated measurements of the angle in question while he persistently neglected to adjust the net? And yet until very recently astronomers have been doing precisely that kind of thing with the solar parallax. I do not think there is any exaggeration in saying that the trustworthy observations now on record for the determination of the numerous quantities which are functions of the parallax could not be duplicated by the most industrious astronomer working continuously for a thousand years. How, then, can we suppose that the result properly deducible from them can be materially affected by anything that any of us can do in a lifetime unless we are fortunate enough to invent methods of measurement vastly superior to any

hitherto imagined? Probably the existing observations for the determination of most of these quantities are as exact as any that can ever be made with our present instruments, and if they were freed from constant errors they would certainly give results very near the truth. To that end we have only to form a system of simultaneous equations between all the observed quantities and then deduce the most probable values of these quantities by the method of least squares. Perhaps some of you may think that the value so obtained for the solar parallax would depend largely upon the relative weights assigned to the various quantities, but such is not the case. With almost any possible system of weights the solar parallax will come out very nearly $8.809'' \pm 0.0057''$, whence we have for the mean distance between the earth and the sun 92,797,000 miles, with a probable error of only 59,700 miles; and for the diameter of the solar system, measured to its outermost member, the planet Neptune, 5,578,400,000 miles.

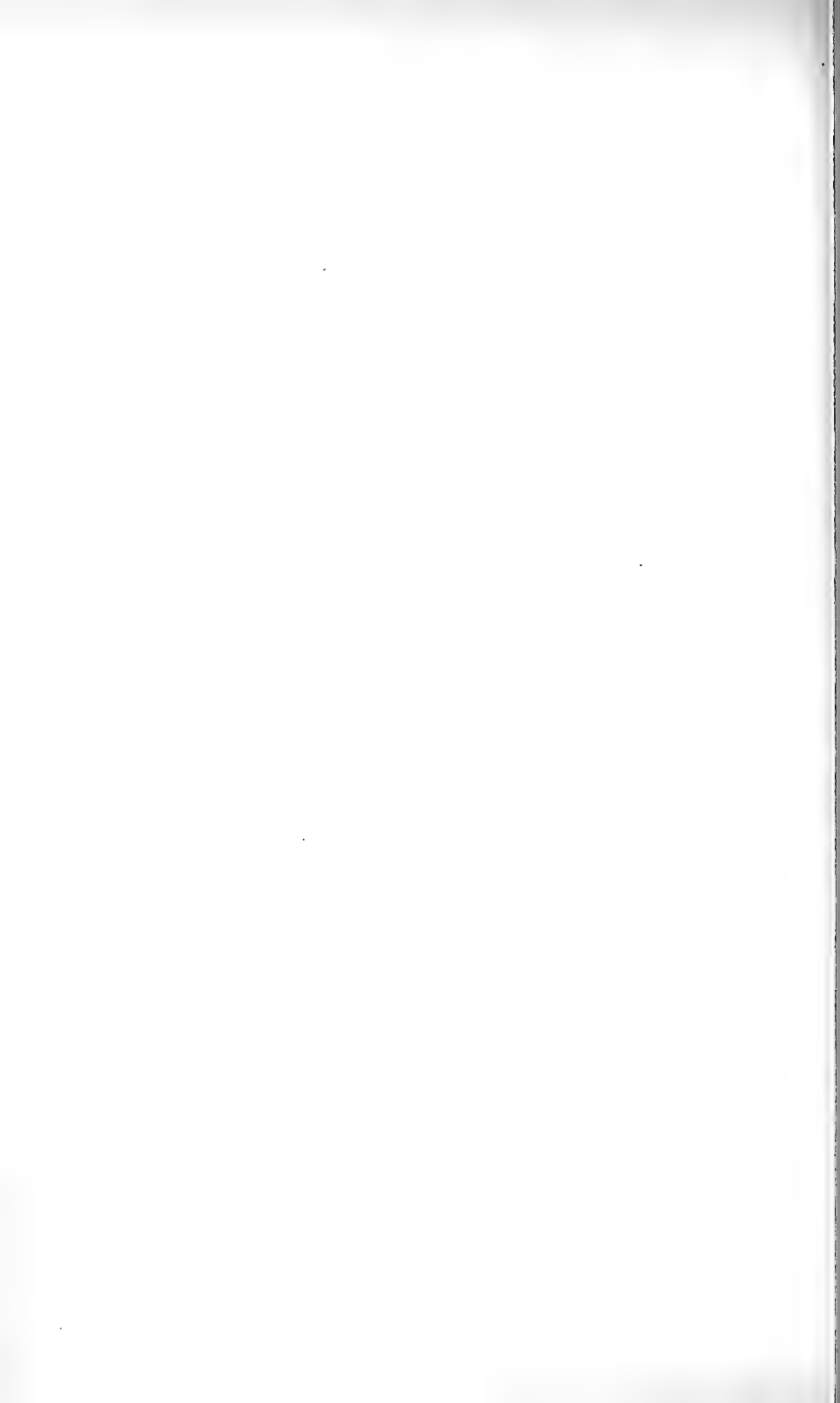

SCHIAPARELLI'S LATEST VIEWS REGARDING MARS.¹

By WILLIAM H. PICKERING.

It is probable that the astronomer whose name is most closely linked with the planet Mars at the present time is Giovanni Schiaparelli; and yet, although nearly everybody has heard of Schiaparelli's canals, very few astronomers even, outside of France and Italy, had until recently more than a very vague notion what were really his ideas in regard to them. This is due probably to the fact that he has written exclusively in Italian, a language which very few American astronomers, and I believe very few English ones, understand. To this fact chiefly, I think, is due the great incredulity with which his observations have been treated, at least until recently, in both of these countries. Astronomers could understand his maps; they knew, therefore, what he had done, but they could not understand his descriptions of his observations, and so were incredulous regarding their accuracy. Moreover, such a mass of detail appeared upon his maps, which had not before been seen by others, that it completely masked the more striking features of the planet, thus rendering its appearance entirely different from that which it presented in the telescope under ordinary atmospheric conditions.

But within the last few years a change has occurred. Flammarion has translated a large part of Schiaparelli's writings into French, a language with which most English speaking astronomers are familiar, and moreover the canals have been seen by a number of astronomers whose descriptions of them in English and French could be understood and were found to agree with those of Schiaparelli.

But errors are still frequently made by people who might be expected to know better. Thus, many people suppose that Schiaparelli was the original discoverer of the canals, a claim which he never made for himself. In point of fact, some of them appear upon maps of the planet published more than fifty years ago. The former English incredulity in the matter seems the more strange, since many of the canals were seen by Dawes in 1864 and by Burton and Dreyer in 1879. Schiaparelli, however, has discovered far more canals than anyone else, and he is also the discoverer of their gemination.

¹ From *Astronomy and Astro-Physics*, Vol. XIII, Nos. 8 and 9, October and November, 1894.

In this connection it may be that a brief chronological statement of the more important facts and discoveries relating to Mars will not be without interest. In compiling it I have been chiefly indebted to Flammarion's classic work, *La Planète Mars*, although other sources have also been consulted.

272 B. C. The first known observation of Mars is recorded in Ptolemy's *Almagest*.

1610 A. D. The phases of Mars were discovered by Galileo.

1659. The first sketch showing surface detail was made by Huygens. He also suggested a rotation in twenty-four hours.

1666. Cassini determined the rotation of Mars to take place in twenty-four hours and forty minutes. He also observed the polar caps, and "he distinguished on the disk of Mars, near the terminator, a white spot advancing into the dark portion, and representing, without doubt, like those of the moon, a roughness or irregularity of the surface." This latter statement is curious, but the effect was undoubtedly due to irradiation, since his telescope was entirely inadequate to enable him to observe such a delicate phenomenon.

1777. With the exception of Huygens, Hooke, and possibly Maraldi, no one succeeded in making recognizable sketches of the surface detail upon Mars for over a century, until Sir William Herschel took the matter up in this year.

1783. Sir William Herschel detected the variation of the size of the polar snowcaps with the seasons, measured the polar compression, and determined the inclination of the axis of the planet to its orbit.

1785-1802. Schroeter made an extended study of the planet. His drawings are upon the whole rather better than those of Herschel. He discovered, among other things, the very dark spots to which I have referred in my publications as the Northern and Equatorial Seas. He, however, supposed them to be clouds.

1840. Beer and Maedler published the first map of the planet, assigning latitudes and longitudes to the various markings. On this map are indicated the first canals and the first of the small lakes, so many of which have been discovered during the last few years. The canals are Nectar and Agathodæmon and portions of Hades and Tartarus. The lake is *Lacus Phœnicis*. Their map is the first satisfactory representation of the entire surface of the planet. The only region which previous observers had clearly distinguished was that in the vicinity of the *Syrtis Major*.

1858. Secchi made a careful study of the colors exhibited by the planet.

1862. Lockyer made the first series of really good sketches of the planet, showing all the characteristic forms with which we are now so familiar. His drawings, and also those of some of the other observers, give the first indications of the appearance of the central branch in the Y, so called by Secchi.

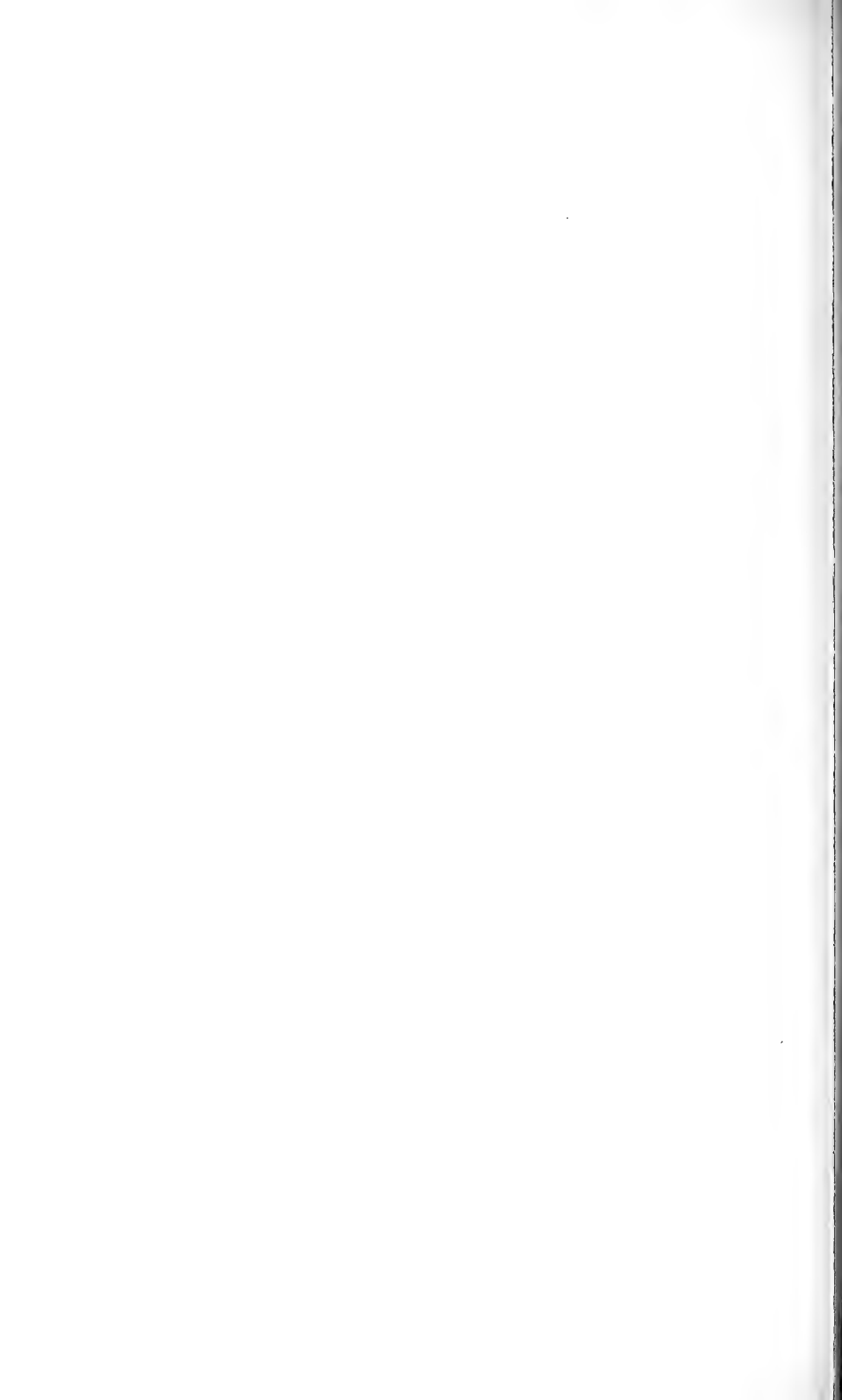

1864. Dawes detected eight or ten of the canals.

1867. Huggins detected lines due to the presence of water vapor in the spectrum of Mars.

1876. Proctor determined the period of rotation of Mars within 0.1 second.

1877. Hall discovered the two satellites of Mars.

1877. Green made a very excellent series of drawings of the planet, superior to anything which had preceded them.

1877. Schiaparelli made the first extensive triangulation of the surface of the planet, and added very largely to the number of known canals.

1879. Schiaparelli detected the gemination of Nilus, the first known double canal.

1882. Schiaparelli discovered numerous double canals, and announced that the appearance formed one of the characteristic phenomena of the planet.

The most reliable confirmation of this phenomenon hitherto reported has come from Perrotin, of Nice, and A. Stanley Williams, in England. If Schiaparelli's theory is correct, that the duplication occurs only between the spring and autumn equinoxes of the Northern Hemisphere, the last opportunity to witness it was in 1890, and the next will be in January and February of 1895, unless the planet proves to be too remote at that period.

Very few of Schiaparelli's writings have ever been translated into English, and none so far as I know, hitherto, without the intervention of some other language, such as German or French. The following translation is from *Natura ed Arte* for February 15, 1893. It gives the latest expression of his views upon the periodical inundations experienced by the planet, upon the nature of the seas, the canals, and the gemination of the latter.

LOWELL OBSERVATORY, FLAGSTAFF, ARIZ., *August 26, 1894.*

THE PLANET MARS.

By GIOVANNI SCHIAPARELLI.

Many of the first astronomers who studied Mars with the telescope had noted on the outline of its disk two brilliant white spots of rounded form and of variable size. In process of time it was observed that while the ordinary spots upon Mars were displaced rapidly in consequence of its daily rotation, changing in a few hours both their position and their perspective, the two white spots remained sensibly motionless at their posts. It was concluded rightly from this that

they must occupy the poles of rotation of the planet, or at least must be found very near to them. Consequently they were given the name of polar caps or spots. And not without reason is it conjectured that these represent upon Mars that immense mass of snow and ice which still to-day prevents navigators from reaching the poles of the earth. We are led to this conclusion not only by the analogy of aspect and of place, but also by another important observation. - - -

As things stand, it is manifest that if the above-mentioned white polar spots of Mars represent snow and ice they should continue to decrease in size with the approach of summer in those places and increase during the winter. Now this very fact is observed in the most evident manner. In the second half of the year 1892 the southern polar cap was in full view; during that interval, and especially in the months of July and August, its rapid diminution from week to week was very evident even to those observing with common telescopes. This snow (for we may well call it so), which in the beginning reached as far as latitude 70° and formed a cap of over 2,000 kilometers (1,200 miles) in diameter, progressively diminished, so that two or three months later little more of it remained than an area of perhaps 300 kilometers (180 miles) at the most, and still less was seen in the last days of 1892. In these months the southern hemisphere of Mars had its summer, the summer solstice occurring upon October 13. Correspondingly the mass of snow surrounding the northern pole should have increased; but this fact was not observable, since that pole was situated in the hemisphere of Mars which was opposite to that facing the earth. The melting of the northern snow was seen in its turn in the years 1882, 1884, and 1886.

These observations of the alternate increase and decrease of the polar snows are easily made even with telescopes of moderate power, but they become much more interesting and instructive when we can follow assiduously the changes in their more minute particulars, using larger instruments. The snowy regions are then seen to be successively notched at their edges; black holes and huge fissures are formed in their interiors; great isolated pieces many miles in extent stand out from the principal mass and, dissolving, disappear a little later. In short, the same divisions and movements of these icy fields present themselves to us at a glance that occur during the summer of our own arctic regions, according to the descriptions of explorers.

The southern snow, however, presents this peculiarity: The center of its irregularly rounded figure does not coincide exactly with the pole, but is situated at another point, which is nearly always the same, and is distant from the pole about 300 kilometers (180 miles) in the direction of the Mare Erythræum. From this we conclude that when the area of the snow is reduced to its smallest extent the south pole of Mars is uncovered, and therefore, perhaps, the problem of reaching it upon this planet is easier than upon the earth. The southern snow

is in the midst of a huge dark spot, which with its branches occupies nearly one-third of the whole surface of Mars, and is supposed to represent its principal ocean. Hence the analogy with our arctic and antarctic snows may be said to be complete, and especially so with the antarctic one.

The mass of the northern snow cap of Mars is, on the other hand, centered almost exactly upon its pole. It is located in a region of yellow color, which we are accustomed to consider as representing the continent of the planet. From this arises a singular phenomenon which has no analogy upon the earth. At the melting of the snows accumulated at that pole during the long night of ten months and more the liquid mass produced in that operation is diffused around the circumference of the snowy region, converting a large zone of surrounding land into a temporary sea and filling all the lower regions. This produces a gigantic inundation, which has led some observers to suppose the existence of another ocean in those parts, but which does not really exist in that place, at least as a permanent sea. We see then (the last opportunity was in 1884) the white spot of the snow surrounded by a dark zone, which follows its perimeter in its progressive diminution, upon a circumference ever more and more narrow. The outer part of this zone branches out into dark lines, which occupy all the surrounding region, and seem to be distributary canals by which the liquid mass may return to its natural position. This produces in these regions very extensive lakes, such as that designated upon the map by the name of *Lacus Hyperboreus*; the neighboring interior sea called *Mare Acidalium* becomes more black and more conspicuous. And it is to be remembered as a very probable thing that the flowing of this melted snow is the cause which determines principally the hydrographic state of the planet and the variations that are periodically observed in its aspect. Something similar would be seen upon the earth if one of our poles came to be located suddenly in the center of Asia or of Africa. As things stand at present, we may find a miniature image of these conditions in the flooding that is observed in our streams at the melting of the Alpine snows.

Travelers in the arctic regions have frequent occasion to observe how the state of the polar ice at the beginning of the summer, and even at the beginning of July, is always very unfavorable to their progress. The best season for exploration is in the month of August, and September is the month in which the trouble from the ice is the least. Thus in September our Alps are usually more practicable than at any other season. And the reason for it is clear—the melting of the snow requires time; a high temperature is not sufficient; it is necessary that it should continue, and its effect will be so much the greater, as it is the more prolonged. Thus, if we could slow down the course of our season so that each month should last sixty days instead of thirty, in the summer, in such a lengthened condition, the melting of the ice

would progress much further, and perhaps it would not be an exaggeration to say that the polar cap at the end of the warm season would be entirely destroyed. But one can not doubt, in any case, that the fixed portion of such a cap would be reduced to much smaller size, than we see it to-day. Now, this is exactly what happens on Mars. The long year, nearly double our own, permits the ice to accumulate during the polar night of ten or twelve months, so as to descend in the form of a continuous layer as far as parallel 70° , or even farther. But in the day which follows, of twelve or ten months, the sun has time to melt all, or nearly all, of the snow of recent formation, reducing it to such a small area that it seems to us no more than a very white point. And perhaps this snow is entirely destroyed; but of this there is at present no satisfactory observation.

Other white spots of a transitory character and of a less regular arrangement are formed in the southern hemisphere upon the islands near the pole, and also in the opposite hemisphere whitish regions appear at times surrounding the north pole and reaching to 50° and 55° of latitude. They are, perhaps, transitory snows, similar to those which are observed in our latitudes. But also in the torrid zone of Mars are seen some very small white spots more or less persistent; among others one was seen by me in three consecutive oppositions (1877-1882) at the point indicated upon our chart by longitude 268° and latitude 16° north. Perhaps we may be permitted to imagine in this place the existence of a mountain capable of supporting extensive ice fields. The existence of such a mountain has also been suggested by some recent observers upon other grounds.

As has been stated, the polar snows of Mars prove in an incontrovertible manner that this planet, like the earth, is surrounded by an atmosphere capable of transporting vapor from one place to another. These snows are in fact precipitations of vapor, condensed by the cold, and carried with it successively. How carried with it if not by atmospheric movement? The existence of an atmosphere charged with vapor has been confirmed also by spectroscopic observations, principally those of Vogel, according to which this atmosphere must be of a composition differing little from our own, and, above all, very rich in aqueous vapor. This is a fact of the highest importance, because from it we can rightly affirm with much probability that to water and to no other liquid is due the seas of Mars and its polar snows. When this conclusion is assured beyond all doubt, another one may be derived from it of not less importance—that the temperature of the Aëran climate, notwithstanding the greater distance of that planet from the sun, is of the same order as the temperature of the terrestrial one. Because, if it were true, as has been supposed by some investigators, that the temperature of Mars was on the average very low (from 50° to 60° below zero), it would not be possible for water vapor to be an important element in the atmosphere of that planet, nor could water

be an important factor in its physical changes, but would give place to carbonic acid, or to some other liquid whose freezing point was much lower.

The elements of the meteorology of Mars seem, then, to have a close analogy to those of the earth. But there are not lacking, as might be expected, causes of dissimilarity. From circumstances of the smallest moment nature brings forth an infinite variety in its operations. Of the greatest influence must be different arrangement of the seas and the continents upon Mars and upon the earth, regarding which a glance at the map will say more than would be possible in many words. We have already emphasized the fact of the extraordinary periodical flood, which at every revolution of Mars inundates the northern polar region at the melting of the snow. Let us now add that this inundation is spread out to a great distance by means of a network of canals, perhaps constituting the principal mechanism (if not the only one) by which water (and with it organic life) may be diffused over the arid surface of the planet. Because on Mars it rains very rarely, or perhaps even it does not rain at all. And this is the proof.

Let us carry ourselves in imagination into celestial space, to a point so distant from the earth that we may embrace it all at a single glance. He would be greatly in error who had expected to see reproduced there upon a great scale the image of our continents with their gulfs and islands and with the seas that surround them which are seen upon our artificial globes. Then without doubt the known forms or part of them would be seen to appear under a vaporous veil, but a great part (perhaps one-half) of the surface would be rendered invisible by the immense fields of cloud, continually varying in density, in form, and in extent. Such a hindrance, most frequent and continuous in the polar regions, would still impede nearly half the time the view of the temperate zones, distributing itself in capricious and ever varying configurations. The seas of the torrid zone would be seen to be arranged in long parallel layers, corresponding to the zone of equatorial and tropical calms. For an observer placed upon the moon the study of our geography would not be so simple an undertaking as one might at first imagine.

There is nothing of this sort in Mars. In every climate and under every zone its atmosphere is nearly perpetually clear and sufficiently transparent to permit one to recognize at any moment whatever the contours of the seas and continents and, more than that, even the minor configurations. Not indeed that vapors of a certain degree of opacity are lacking, but they offer very little impediment to the study of the topography of the planet. Here and there we see appear from time to time a few whitish spots, changing their position and their form, rarely extending over a very wide area. They frequent by preference a few regions, such as the islands of the Mare Australe, and on the continents the regions designated on the map with the names of Elysium

and Tempe. Their brilliancy generally diminishes and disappears at the meridian hour of the place, and is reenforced in the morning and evening with very marked variations. It is possible that they may be layers of cloud, because the upper portions of terrestrial clouds where they are illuminated by the sun appear white. But various observations lead us to think that we are dealing rather with a thin veil of fog instead of a true nimbus cloud, carrying storms and rain. Indeed, it may be merely a temporary condensation of vapor under the form of dew or hoar frost.

Accordingly, as far as we may be permitted to argue from the observed facts, the climate of Mars must resemble that of a clear day upon a high mountain. By day a very strong solar radiation, hardly mitigated at all by mist or vapor; by night a copious radiation from the soil toward celestial space, and because of that a very marked refrigeration. Hence a climate of extremes, and great changes of temperature from day to night, and from one season to another. And as on the earth at altitudes of 5,000 and 6,000 meters (17,000 to 20,000 feet) the vapor of the atmosphere is condensed only into the solid form, producing those whitish masses of suspended crystals which we call cirrus clouds, so in the atmosphere of Mars it would be rarely possible (or would even be impossible) to find collections of cloud capable of producing rain of any consequence. The variation of the temperature from one season to another would be notably increased by their long duration, and thus we can understand the great freezing and melting of the snow, which is renewed in turn at the poles at each complete revolution of the planet around the sun.

As our chart demonstrates, in its general topography Mars does not present any analogy with the earth. A third of its surface is occupied by the great Mare Australe, which is strewn with many islands, and the continents are cut up by gulfs and ramifications of various forms. To the general water system belongs an entire series of small internal seas, of which the Hadriacum and the Tyrrhenum communicate with it by wide mouths, whilst the Cimmerium, the Sirenum, and the Solis Lacus are connected with it only by means of narrow canals. We shall notice in the first four a parallel arrangement, which certainly is not accidental, as also not without reason is the corresponding position of the peninsulas of Ausonia, Hesperia, and Atlantis. The color of the seas of Mars is generally brown, mixed with gray, but not always of equal intensity in all places, nor is it the same in the same place at all times. From an absolute black it may descend to a light-gray or to an ash color. Such a diversity of colors may have its origin in various causes, and is not without analogy also upon the earth, where it is noted that the seas of the warm zone are usually much darker than those nearer the pole. The water of the Baltic, for example, has a light, muddy color that is not observed in the Mediterranean. And thus in

the seas of Mars we see the color become darker when the sun approaches their zenith, and summer begins to rule in that region.

All of the remainder of the planet, as far as the north pole, is occupied by the mass of the continents, in which, save in a few areas of relatively small extent, an orange color predominates, which sometimes reaches a dark red tint, and in others descends to yellow and white. The variety in this coloring is in part of meteorological origin, in part it may depend on the diverse nature of the soil, but upon its real cause it is not as yet possible to frame any very well grounded hypothesis. Nevertheless, the cause of this predominance of the red and yellow tints upon the surface of ancient Pyrois is well known.¹ Some have thought to attribute this coloring to the atmosphere of Mars, through which the surface of the planet might be seen colored, as any terrestrial object becomes red when seen through red glass. But many facts are opposed to this idea, among others that the polar snows appear always of the purest white, although the rays of light derived from them traverse twice the atmosphere of Mars under great obliquity. We must then conclude that the Arean continents appear red and yellow because they are so in fact.

Besides these dark and light regions, which we have described as seas and continents, and of whose nature there is at present scarcely left any room for doubt, some others exist, truly of small extent, of an amphibious nature, which sometimes appear yellowish like the continents, and are sometimes clothed in brown (even black in certain cases), and assume the appearance of seas, whilst in other cases their color is intermediate in tint, and leaves us in doubt to which class of regions they may belong. Thus all the islands scattered through the Mare Australe and the Mare Erythræum belong to this category; so too the long peninsula called Deucalionis Regio and Pyrrhæ Regio, and in the vicinity of the Mare Acidalium the regions designated by the names of Baltia and Nerigos. The most natural idea, and the one to which we should be led by analogy, is to suppose these regions to represent huge swamps, in which the variation in depth of the water produces the diversity of colors. Yellow would predominate in those parts where the depth of the liquid layer was reduced to little or nothing, and brown, more or less dark, in those places where the water was sufficiently deep to absorb more light and to render the bottom more or less invisible. That the water of the sea, or any other deep and transparent water, seen from above, appears more dark the greater the depth of the liquid stratum, and that the land in comparison with it appears bright under the solar illumination, is known and confirmed by certain physical reasons. The traveler in the Alps often has occasion to convince himself of it, seeing from the summits the deep lakes

¹Pyrois I take to be some terrestrial region, although I have not been able to find any translation of the name.—Translator.

with which the region is strewn extending under his feet as black as ink, whilst in contrast with them even the blackest rocks illuminated by the sunlight appeared brilliant.¹

Not without reason, then, have we hitherto attributed to the dark spots of Mars the part of seas, and that of continents to the reddish areas which occupy nearly two-thirds of all the planet, and we shall find later other reasons which confirm this method of reasoning. The continents form in the northern hemisphere a nearly continuous mass, the only important exception being the great lake called the Mare Acidalium, of which the extent may vary according to the time, and which is connected in some way with the inundations which we have said were produced by the melting of the snow surrounding the north pole. To the system of the Mare Acidalium undoubtedly belong the temporary lake called Lacus Hyperboreus and the Lacus Niliacus. This last is ordinarily separated from the Mare Acidalium by means of an isthmus or regular dam, of which the continuity was only seen to be broken once for a short time in 1888. Other smaller dark spots are found here and there in the continental area which we may designate as lakes, but they are certainly not permanent lakes like ours, but are variable in appearance and size according to the seasons, to the point of wholly disappearing under certain circumstances. Ismenius Lacus, Lunæ Lacus, Trivium Charontis, and Propontis are the most conspicuous and durable ones. There are also smaller ones, such as Lacus Moeris and Fons Juventæ, which at their maximum size do not exceed 100 to 150 kilometers (60 to 90 miles) in diameter, and are among the most difficult objects upon the planet.

All the vast extent of the continents is furrowed upon every side by a network of numerous lines or fine stripes of a more or less pronounced dark color, whose aspect is very variable. These traverse the planet for long distances in regular lines that do not at all resemble the winding courses of our streams. Some of the shorter ones do not reach 500 kilometers (300 miles), others, on the other hand, extend for many thousands, occupying a quarter or sometimes even a third of a circumference of the planet. Some of these are very easy to see, especially that one which is near the extreme left-hand limit of our map, and is designated by the name of Nilosyrtris. Others in turn are extremely difficult, and resemble the finest thread of spider's web drawn across the disk. They are subject also to great variations in their breadth, which may reach 200 or even 300 kilometers (120 to 180 miles) for the Nilosyrtris, whilst some are scarcely 30 kilometers (18 miles) broad.

¹This observation of the dark color which deep water exhibits when seen from above is found already noted by the first author of antique memory, for in the Iliad (verses 770-771 of Book V) it is described how "the sentinel from the high sentry box extends his glance over the wine-colored sea, *οἶνοσα πόντον*." In the version of Monti the adjective indicating the color is lost.

These lines or stripes are the famous canals of Mars, of which so much has been said. As far as we have been able to observe them hitherto, they are certainly fixed configurations upon the planet. The Nilosyrtis has been seen in that place for nearly one hundred years, and some of the others for at least thirty years. Their length and arrangement are constant, or vary only between very narrow limits. Each of them always begins and ends between the same regions. But their appearance and their degree of visibility vary greatly, for all of them, from one opposition to another, and even from one week to another, and these variations do not take place simultaneously and according to the same laws for all, but in most cases happen apparently capriciously, or at least according to laws not sufficiently simple for us to be able to unravel. Often one or more become indistinct, or even wholly invisible, whilst others in their vicinity increase to the point of becoming conspicuous even in telescopes of moderate power. The first of our maps shows all those that have been seen in a long series of observations. This does not at all correspond to the appearance of Mars at any given period, because generally only a few are visible at once.¹

Every canal (for now we shall so call them) opens at its ends either into a sea, or into a lake, or into another canal, or else into the intersection of several other canals. None of them have yet been seen cut off in the middle of the continent, remaining without beginning or without end. This fact is of the highest importance. The canals may intersect among themselves at all possible angles, but by preference they converge toward the small spots to which we have given the name of lakes. For example, seven are seen to converge in Lacus Phœnicis, eight in Trivium Charontis, six in Lunæ Lacus, and six in Ismenius Lacus.

The normal appearance of a canal is that of a nearly uniform stripe, black, or at least of a dark color, similar to that of the seas, in which the regularity of its general course does not exclude small variations in its breadth and small sinuosities in its two sides. Often it happens that such a dark line opening out upon the sea is enlarged into the form of a trumpet, forming a huge bay, similar to the estuaries of certain terrestrial streams. The Margaritifer Sinus, the Aonius Sinus, the

¹In a footnote the author refers to a drawing of Mars made by himself, September 15, 1892, and says, - - - "At the top of the disk the Mare Erythræum and the Mare Australe appear divided by a great curved peninsula, shaped like a sickle, producing an unusual appearance in the area called Deucalionis Regio, which was prolonged that year so as to reach the islands of Noachis and Argyre. This region forms with them a continuous whole, but with faint traces of separation occurring here and there in a length of nearly 6,000 kilometers (4,000 miles). Its color, much less brilliant than that of the continents, was a mixture of their yellow with the brownish gray of the neighboring seas." The interesting feature of this note is the remark that it was an unusual appearance, the region referred to being that in which the central branch of the fork of the Y appeared. Since no such branch was conspicuously visible this year, it would therefore seem from the above that it was the opposition of 1892 that was peculiar, and not the present one.—Translator.

Aurora Sinus, and the two horns of the Sabæus Sinus are thus formed, at the mouths of one or more canals, opening into the Mare Erythræum or into the Mare Australe. The largest example of such a gulf is the Syrtis Major, formed by the vast mouth of the Nilosyrtis, so called. This gulf is not less than 1,800 kilometers (1,100 miles) in breadth, and attains nearly the same depth in a longitudinal direction. Its surface is little less than that of the Bay of Bengal. In this case we see clearly the dark surface of the sea continued without apparent interruption into that of the canal. Inasmuch as the surfaces called seas are truly a liquid expanse, we can not doubt that the canals are a simple prolongation of them, crossing the yellow areas or continents.

Of the remainder, that the lines called canals are truly great furrows or depressions in the surface of the planet, destined for the passage of the liquid mass and constituting for it a true hydrographic system, is demonstrated by the phenomena which are observed during the melting of the northern snows. We have already remarked that at the time of melting they appeared surrounded by a dark zone, forming a species of temporary sea. At that time the canals of the surrounding region become blacker and wider, increasing to the point of converting at a certain time all of the yellow region comprised between the edge of the snow and the parallel of 60° north latitude into numerous islands of small extent. Such a state of things does not cease until the snow, reduced to its minimum area, ceases to melt. Then the breadth of the canals diminishes, the temporary sea disappears, and the yellow region again returns to its former area. The different phases of these vast phenomena are renewed at each return of the seasons, and we were able to observe them in all their particulars very easily during the oppositions of 1882, 1884, and 1886, when the planet presented its northern pole to terrestrial spectators. The most natural and the most simple interpretation is that to which we have referred, of a great inundation produced by the melting of the snows; it is entirely logical and is sustained by evident analogy with terrestrial phenomena. We conclude, therefore, that the canals are such in fact and not only in name. The network formed by these was probably determined in its origin in the geological state of the planet, and has come to be slowly elaborated in the course of centuries. It is not necessary to suppose them the work of intelligent beings, and, notwithstanding the almost geometrical appearance of all of their system, we are now inclined to believe them to be produced by the evolution of the planet, just as on the earth we have the English Channel and the channel of Mozambique.

It would be a problem not less curious than complicated and difficult to study the system of this immense stream of water, upon which perhaps depends principally the organic life upon the planet, if organic life is found there. The variations of their appearance demonstrated that this system is not constant. When they become displaced or

their outlines become doubtful and ill defined, it is fair to suppose that the water is getting low or is even entirely dried up. Then, in place of the canals there remains either nothing or at most stripes of yellowish color differing little from the surrounding background. Sometimes they take on a nebulous appearance, for which at present it is not possible to assign a reason. At other times true enlargements are produced, expanding to 100, 200 or more kilometers (60 to 120 miles) in breadth, and this sometimes happens for canals very far from the north pole, according to laws which are unknown. This occurred in Hydaspes in 1864, in Simois in 1879, in Ackeron in 1884, and in Triton in 1888. The diligent and minute study of the transformations of each canal may lead later to a knowledge of the causes of these effects.

But the most surprising phenomenon pertaining to the canals of Mars is their gemination, which seems to occur principally in the months which precede and in those which follow the great northern inundation—at about the times of the equinoxes. In consequence of a rapid process, which certainly lasts at most a few days, or even perhaps, only a few hours, and of which it has not yet been possible to determine the particulars with certainty, a given canal changes its appearance and is found transformed through all its length into two lines or uniform stripes more or less parallel to one another, and which run straight and equal with the exact geometrical precision of the two rails of a railroad. But this exact course is the only point of resemblance with the rails, because in dimensions there is no comparison possible, as it is easy to imagine. The two lines follow very nearly the direction of the original canal and end in the place where it ended. One of these is often superposed as exactly as possible upon the former line, the other being drawn anew; but in this case the original line loses all the small irregularities and curvature that it may have originally possessed. But it also happens that both the lines may occupy opposite sides of the former canal and be located upon entirely new ground. The distance between the two lines differs in different geminations and varies from 600 kilometers (360 miles) and more down to the smallest limit at which two lines may appear separated in large visual telescopes—less than an interval of 50 kilometers (30 miles). The breadth of the stripes themselves may range from the limit of visibility, which we may suppose to be 30 kilometers (18 miles), up to more than 100 kilometers (60 miles). The color of the two lines varies from black to a light red, which can hardly be distinguished from the general yellow background of the continental surface. The space between is for the most part yellow, but in many cases appears whitish. The gemination is not necessarily confined only to the canals, but tends to be produced also in the lakes. Often one of these is seen transformed into two short, broad, dark lines parallel to one another and traversed by a yellow line. In these cases the gemination is naturally short and does not exceed the limits of the original lake.

The gemination is not shown by all at the same time, but when the season is at hand it begins to be produced here and there, in an isolated, irregular manner, or at least without any easily recognizable order. In many canals (such as the Nilosyrtris, for example) the gemination is lacking entirely, or is scarcely visible. After having lasted for some months, the markings fade out gradually and disappear until another season equally favorable for their formation. Thus it happens that in certain other seasons (especially near the southern solstice of the planet) few are seen, or even none at all. In different oppositions the gemination of the same canal may present different appearances as to width, intensity, and arrangement of the two stripes; also in some cases the direction of the lines may vary, although by the smallest quantity, but still deviating by a small amount from the canal with which they are directly associated. From this important fact it is immediately understood that the gemination can not be a fixed formation upon the surface of Mars and of a geographical character like the canals. The second of our maps will give an approximate idea of the appearance which these singular formations present. It contains all the geminations observed since 1882 up to the present time. In examining it it is necessary to bear in mind that not all of these appearances were simultaneous, and consequently that the map does not represent the condition of Mars at any given period; it is only a sort of topographical register of the observations made of this phenomenon at different times.¹

The observation of the geminations is one of the greatest difficulty, and can only be made by an eye well practiced in such work, added to a telescope of accurate construction and of great power. This explains why it is that it was not seen before 1882. In the ten years that have transpired since that time, it has been seen and described at eight or ten observatories. Nevertheless, some still deny that these phenomena are real, and tax with illusion (or even imposture) those who declare that they have observed it.

Their singular aspect, and their being drawn with absolute geometrical precision, as if they were the work of rule or compass, has led some to see in them the work of intelligent beings, inhabitants of the planet. I am very careful not to combat this supposition, which includes nothing impossible. (*Io mi guarderò bene dal combattere questa supposizione, la quale nulla include d' impossibile.*) But it will be noticed that in any case the gemination can not be a work of permanent character, it being certain that in a given instance it may change its appearance and dimensions from one season to another. If we should assume such a work, a certain variability would not be excluded from it; for example, extensive agricultural labor and irrigation upon a large scale. Let us add, further, that the intervention of intelligent beings might explain

¹This map may be found also in *La Planète Mars*, by Flammarion, page 440.—Translator.

the geometrical appearance of the gemination, but it is not at all necessary for such a purpose. The geometry of nature is manifested in many other facts from which are excluded the idea of any artificial labor whatever. The perfect spheroids of the heavenly bodies and the ring of Saturn were not constructed in a turning lathe, and not with compasses has Iris described within the clouds her beautiful and regular arch. And what shall we say of the infinite variety of those exquisite and regular polyhedrons in which the world of crystals is so rich? In the organic world, also, is not that geometry most wonderful which presides over the distribution of the foliage upon certain plants, which orders the nearly symmetrical, star-like figures of the flowers of the field, as well as of the animals of the sea, and which produces in the shell such an exquisite conical spiral that excels the most beautiful masterpieces of Gothic architecture? In all these objects the geometrical form is the simple and necessary consequence of the principles and laws which govern the physical and physiological world. That these principles and these laws are but an indication of a higher intelligent Power we may admit, but this has nothing to do with the present argument.

Having regard, then, for the principle that in the explanation of natural phenomena it is universally agreed to begin with the simplest suppositions, the first hypotheses of the nature and cause of the geminations have for the most part put in operation only the laws of inorganic nature. Thus, the gemination is supposed to be due either to the effects of light in the atmosphere of Mars, or to optical illusions produced by vapors in various manners, or to glacial phenomena of a perpetual winter, to which it is known all the planets will be condemned, or to double cracks in its surface, or to single cracks of which the images are doubled by the effect of smoke issuing in long lines and blown laterally by the wind. The examination of these ingenious suppositions leads us to conclude that none of them seem to correspond entirely with the observed facts, either in whole or in part. Some of these hypotheses would not have been proposed had their authors been able to examine the geminations with their own eyes. Since some of these may ask me directly, Can you suggest anything better? I must reply candidly, No.

It would be far more easy if we were willing to introduce the forces pertaining to organic nature. Here the field of plausible supposition is immense, being capable of making an infinite number of combinations capable of satisfying the appearances even with the smallest and simplest means. Changes of vegetation over a vast area, and the production of animals, also very small, but in enormous multitudes, may well be rendered visible at such a distance. An observer placed in the moon would be able to see such an appearance at the times in which agricultural operations are carried out upon one vast plain—the seed-time and the gathering of the harvest. In such a manner also would the flowers of the plants of the great steppes of Europe and Asia be

rendered visible at the distance of Mars—by a variety of coloring. A similar system of operations produced in that planet may thus certainly be rendered visible to us. But how difficult for the Lunarians and the Areans to be able to imagine the true causes of such changes of appearance without having first at least some superficial knowledge of terrestrial nature! So also for us, who know so little of the physical state of Mars, and nothing of its organic world, the great liberty of possible supposition renders arbitrary all explanations of this sort and constitutes the gravest obstacle to the acquisition of well-founded notions. All that we may hope is that with time the uncertainty of the problem will gradually diminish, demonstrating if not what the geminations are, at least what they can not be. We may also confide a little in what Galileo called “the courtesy of nature,” thanks to which a ray of light from an unexpected source will sometimes illuminate an investigation at first believed inaccessible to our speculations, and of which we have a beautiful example in celestial chemistry. Let us therefore hope and study.

LIGHT AND ELECTRICITY, ACCORDING TO MAXWELL AND HERTZ.¹

By M. POINCARÉ.²

It was at the moment when the experiments of Fresnel were forcing the scientific world to admit that light consists of the vibrations of a highly attenuated fluid filling interplanetary spaces that the researches of Ampère were making known the laws of the mutual action of currents and were so enunciating the fundamental principles of electro-dynamics.

It needed but one step to the supposition that that same fluid, the ether, which is the medium of luminous phenomena, is at the same time the vehicle of electrical action. In imagination Ampère made this stride; but the illustrious physicist could not foresee that the seducing hypothesis with which he was toying, a mere dream for him, was ere long to take a precise form and become one of the vital concerns of exact science.

A dream it remained for many years, till one day, after electrical measurements had become extremely exact, some physicist, turning over the numerical data, much as a resting pedestrian might idly turn over a stone, brought to light an odd coincidence. It was that the factor of transformation between the system of electro-statical units and the system of electro-dynamical units was equal to the velocity of light. Soon the observations directed to this strange coincidence became so exact that no sane head could longer hold it a mere coincidence. No longer could it be doubted that some occult affinity existed between optical and electrical phenomena. Perhaps, however, we might be wondering to this day what this affinity could be were it not for the genius of Clerk Maxwell.

¹ Translated from *Annuaire du Bureau des Longitudes*, Paris, 1894.

² M. Henri Poincaré, one of the leading mathematicians of France, is the author of a work entitled *Électricité et Optique*, in two volumes, of which the first treats of the discoveries of Maxwell, the second of those of Hertz.

DISPLACEMENT CURRENTS.

The reader is aware that solid bodies are divided into two classes, conductors through which electricity can move in the form of a galvanic current, and nonconductors, or dielectrics. The electricians of former days regarded dielectrics as quite inert, having no part to play but that of obstinately refusing passage to electricity. Had that been so, any one nonconductor might be replaced by any other without making any difference in the phenomena; but Faraday found that that was not the case. Two condensers of the same form and dimensions put into connection with the same source of electricity do not take the same charge, though the thickness of the isolating plate be the same, unless the matter of that plate be chemically the same. Now Clerk Maxwell had too deeply studied the researches of Faraday not to comprehend the importance of dielectrics and the imperative obligation to recognize their active part.

Besides, if light is but an electric phenomenon, when it traverses a thickness of glass electrical events must take place in that glass. And what can be the nature of those events? Maxwell boldly answers, they are, and must be, currents.

All the experience of his day seemed to contradict this. Never had currents been observed except in conductors. How was Maxwell to reconcile his audacious hypothesis with a fact so well established as that? Why is it that under certain circumstances those supposed currents produce manifest effects, while under ordinary conditions they can not be observed at all.

The answer was that dielectrics resist the passage of electricity not so much more than conductors do, but in a different manner. Maxwell's idea will best be understood by a comparison.

If we bend a spring, we meet a resistance which increases the more the spring is bended. So, if we can only dispose of a finite force, a moment will come when the motion will cease, equilibrium being reached. Finally, when the force ceases the spring will in flying back restore the whole of the energy which has been expended in bending it.

Suppose, on the other hand, that we wish to displace a body plunged into water. Here again a resistance will be experienced, but it will not go on increasing in proportion as the body advances, supposing it to be maintained at a constant velocity. So long as the motive force acts, equilibrium will never, then, be attained; nor when the force is removed will the body in the least tend to return, nor can any portion of the energy expended be restored. It will, in fact, have been converted into heat by the viscosity of the water.

The contrast is plain; and we ought to distinguish elastic resistance from viscous resistance. Using these terms, we may express Maxwell's idea by saying that dielectrics offer an elastic resistance, conductors a

viscous resistance, to the movements of electricity. Hence, there are two kinds of currents; currents of displacement which traverse dielectrics and ordinary currents of conduction which circulate in conductors.

Currents of the first kind, having to overcome an elastic resistance which continually increases, naturally can last but a very short time, since a state of equilibrium will quickly be reached.

Currents of conduction, on the other hand, having only a viscous resistance to overcome, must continue so long so there is any electromotive force.

Let us return to the simile used by M. Cornu in his notice in the *Annuaire du Bureau des Longitudes* for 1893. Suppose we have in a reservoir water under pressure. Lead a tube plumb downward into the reservoir. The water will rise in the tube, but the rise will stop when hydrostatic equilibrium is attained—that is, when the downward pressure of the water in the tube above the point of application of the first pressure on the reservoir, and due to the weight of the water, balances that first pressure. If the pipe is large, there will be no friction or loss of head, and the water so raised can be used to do work. That represents a current of displacement.

If, on the other hand, the water flows out of the reservoir by a horizontal pipe, the motion will go on till the reservoir is emptied; but if the tube is small and long there will be a great loss of energy and considerable production of heat by friction. That represents a current of conduction.

Though it would be vain, not to say idle, to attempt to represent all details, it may be said that everything happens just as if the currents of displacement were acting to bend a multitude of little springs. When the currents cease, electrostatic equilibrium is established, and the springs are bent the more, the more intense is the electric field. The accumulated work of the springs—that is, the electrostatic energy—can be entirely restored as soon as they can unbend, and so it is that we obtain mechanical work when we leave the conductors to obey the electrostatic attractions. Those attractions must be due to the pressure exercised on the conductors by the bent springs. Finally, to pursue the image to the death, the disruptive discharge may be compared to the breaking of the springs when they are bent too much.

On the other hand, the energy employed to produce conduction currents is lost, being wholly converted into heat, like that spent in overcoming the viscosity of fluids. Hence it is that the conducting wires become heated.

From Maxwell's point of view it seems that all currents are in closed circuits. The older electricians did not so opine. They regarded the current circulating in a wire joining the two poles of a pile as closed; but if in place of directly uniting the two poles we place them in communication with the two armatures of a condenser, the momentary current which lasts while the condenser is getting charged was not

considered as a current round a closed circuit. It went, they thought, from one armature through the wire, the battery, the other wire, to the other armature, and there it stopped. Maxwell, on the contrary, supposed that in the form of a current of displacement it passes through the nonconducting plate of the condenser, and that precisely what brings it to cessation is the opposite electromotive force set up by the displacement of electricity in this dielectric.

Currents become sensible in three ways—by their heating effects, by their actions on other currents and on magnets, and by the induced currents to which they give rise. We have seen why currents of conduction develop heat and why currents of displacement do not. But Maxwell's hypothetical currents ought at any rate to produce electromagnetic and inductive effects. Why do these effects not appear? The answer is, that it is because a current of displacement can not last long enough. That is to say, they can not last long in one direction. Consequently in a dielectric no current can long exist without alternation. But the effects ought to and will become observable if the current is continually reversed at sufficiently short intervals.

THE NATURE OF LIGHT.

Such, according to Maxwell, is the origin of light. A luminiferous wave is a series of alternating currents produced in dielectrics, in air, or even in the interplanetary void, and reversed in direction a million of millions of times per second. The enormous induction due to these frequent alternations sets up other currents in the neighboring parts of the dielectric, and so the waves are propagated.

Calculation shows that the velocity of propagation would be equal to the ratio of the units, which we know is the velocity of light.

Those alternative currents are a sort of electrical oscillation. Are they longitudinal, like those of sound, or are they transversal, like those of Fresnel's ether? In the case of sound the air undergoes alternative condensations and rarefactions. The ether of Fresnel, on the other hand, behaves as if it were composed of incompressible layers capable only of slipping over one another. Were these currents in open paths, the electricity carried from one end to the other would become accumulated at one extremity. It would thus be condensed and rarefied like air, and its vibrations would be longitudinal. But Maxwell only admits currents in closed circuits; accumulation is impossible, and electricity behaves like the incompressible ether of Fresnel, with its transversal vibrations.

EXPERIMENTAL VERIFICATION.

We thus obtain all the results of the theory of waves. Yet this was not enough to decide the physicists to adopt the ideas of Maxwell. It was a seductive hypothesis; but physicists consider hypotheses which lead to no distinct observational consequences as beyond

the borders of their province. That province, so defined, no experimental confirmation of Maxwell's theory invaded for twenty-five years.

What was wanted was some issue between the two theories not too delicate for our coarse methods of observation to decide. There was but one line of research along which any experimentum crucis was to be met with.

The old electro-dynamics makes electro-magnetic induction take place instantaneously; but according to Maxwell's doctrine it propagates itself with the velocity of light.

The point was then to measure, or at least to make certain, a velocity of propagation of inductive effects. This is what the illustrious German physicist Hertz has done by the method of interferences.

The method is well known in its application to optical phenomena. Two luminous rays from one identical center interfere when they reach the same point after pursuing paths of different lengths. If the difference is one, two, or any whole number of wave lengths, the two lights reenforce one another so that if their intensities are equal, that of their combination is four times as great. But if the difference is an odd number of half wave lengths, the two lights extinguish one another.

Luminiferous waves are not peculiar in showing this phenomenon; it belongs to every periodic change which is propagated with definite velocity. Sound interferes just as light does, and so must electro-dynamic induction if it is strictly periodic and has a definite velocity of propagation. But if the propagation is instantaneous there can be no interference, since in that case there is no finite wave length.

The phenomenon, however, could not be observed were the wave length greater than the distance within which induction is sensible. It is therefore requisite to make the period of alternation as short as possible.

ELECTRICAL EXCITERS.

We can obtain such currents by means of an apparatus which constitutes a veritable electrical pendulum. Let two conductors be united by a wire. If they have not the same electric potential the electrical equilibrium is disturbed and tends to restore itself, just as the molar equilibrium is disturbed when a pendulum is carried away from the position of repose.

A current is set up in the wire, tending to equalize the potential, just as the pendulum begins to move so as to be carried back to the position of repose. But the pendulum does not stop when it reaches that position. Its inertia carries it farther. Nor, when the two electrical conductors reach the same potential, does the current in the wire cease. The equilibrium instantaneously existing is at once destroyed by a cause analogous to inertia, namely self-induction. We know that when a current is interrupted it gives rise in parallel wires to an induced current in the same direction. The same effect is produced in the circuit

itself, if that is not broken. In other words, a current will persist after the cessation of its causes, just as a moving body does not stop the instant it is no longer driven forward.

When, then, the two potentials become equal, the current will go on and give the two conductors relative charges opposite to those they had at first. In this case, as in that of the pendulum, the position of equilibrium is passed, and a return motion is inevitable. Equilibrium, again instantaneously attained, is at once again broken for the same reason; and so the oscillations pursue one another unceasingly.

Calculation shows that the period depends on the capacity of the conductors in such a way that it is only necessary to diminish that capacity sufficiently (which is easily done) to have an electric pendulum capable of producing an alternating current of extremely short period.

All that was well enough known by the theoretical researches of Lord Kelvin and by the experimentation of Federsen on the oscillatory discharge of the Leyden jar. It was not that which constituted the originality of Hertz.

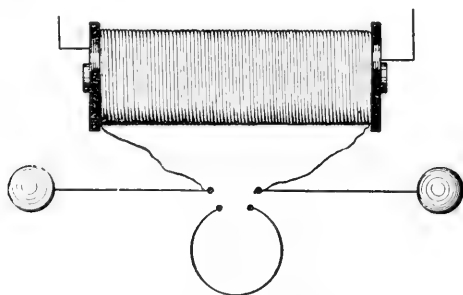

FIG. 1.—The Hertz exciter.

But it is not enough to construct a pendulum; it is further requisite to set it into oscillation. For that, it is necessary to carry it off from equilibrium and to let it go suddenly, that is to say, to release it in a time short as compared to the period of its oscillation.

For if, having pulled a pendulum to one side by a string, we were to let go of the string more slowly than the pendulum would have descended of itself, it would reach the vertical without momentum, and no oscillation would be set up.

In like manner, with an electric pendulum whose natural period is, say, a hundred-millionth of a second, no mechanical mode of release would answer the purpose at all, sudden as it might seem to us with our more than sluggish conceptions of promptitude. How, then, did Hertz solve the problem?

To return to our electric pendulum, a gap of a few millimeters is made in the wire which joins the two conductors. This gap divides our apparatus into two symmetrical parts, which are connected to the two poles of a Ruhmkorff coil. The induced current begins to charge the two conductors, and the difference of their potential increases with relative slowness.

At first the gap prevents a discharge from the conductors; the air in it plays the rôle of insulator and maintains our pendulum in a position diverted from that of equilibrium.

But when the difference of potential becomes great enough, a spark will jump across. If the self-induction is great enough and the capacity and resistance small enough, there will be an oscillatory discharge whose period can be brought down to a hundred-millionth of a second. The oscillatory discharge would not, it is true, last long by itself; but it is kept up by the Ruhmkorff coil, whose current is itself oscillatory with a period of about a hundred-thousandth of a second, and thus the pendulum gets a new impulse as often as that.

The instrument just described is called a resonance exciter. It produces oscillations which are reversed from a hundred million to a thousand million times per second. Thanks to this extreme frequency, they can produce inductive effects at great distances. To make these effects sensible another electric pendulum is used, called a resonator. In this the coil is suppressed. It consists simply of two little metallic spheres very near to one another, with a long wire connecting them in a round-about way.

The induction due to the exciter will set the resonator in vibration the more intensely the more nearly the natural periods of vibration are the same. At certain phases of the vibration the difference of potential of the two spheres will be just great enough to cause the sparks to leap across.

PRODUCTION OF THE INTERFERENCES.

Thus we have an instrument which reveals the inductive waves which radiate from the exciter. We can study them in two ways. We may either expose the resonator to the direct induction of the exciter at a great distance, or else make this induction act at a small distance on a long conducting wire which the electric wave will follow and which in its turn will act at a small distance on the resonator.

Whether the wave is propagated along a wire or across the air, interferences can be produced by reflection. In the first case it will be reflected at the extremity of the wire, which it will again pass through in the opposite direction. In the second case it can be reflected on a metallic leaf which will act as a mirror. In either case the reflected ray will interfere with the direct ray, and positions will be found in which the spark of the resonator will be extinguished.

Experiments with a long wire are the easier and furnish much valuable information, but they can not furnish an *experimentum crucis*, since in the old theory, as in the new, the velocity of the electric wave in a wire should be equal to that of light. But experiments on direct induction at great distances are decisive. They not only show that the velocity of propagation of induction across air is finite, but also that it is equal to the velocity of the wave propagated along a wire, conformably to the ideas of Maxwell.

SYNTHESIS OF LIGHT.

I shall insist less on other experiments of Hertz, more brilliant but less instructive. Concentrating with a parabolic mirror the wave of induction that emanates from the exciter, the German physicist obtained a true pencil of rays of electric force, susceptible of regular reflection and refraction. These rays, were the period but one-millionth of what it is, would not differ from rays of light. We know that the sun sends us several varieties of radiations, some luminiferous, since they act on the retina, others dark, infra-red, or ultra-violet, which reveal themselves in chemical and calorific effects. The first owe the qualities which render them sensible to us to a physiological chance. For the physicist, the infra-red differs from red only as red differs from green; it simply has a greater wave length. That of the Hertzian radiations is far greater still, but they are mere differences of degree, and if the ideas of Clerk Maxwell are true, the illustrious professor of Bonn has effected a genuine synthesis of light.

CONCLUSION.

Nevertheless, our admiration for such unhoped-for successes must not let us forget what remains to be accomplished. Let us endeavor to take exact account of the results definitely acquired.

In the first place, the velocity of direct induction through air is finite; for otherwise interferences could not exist. Thus the old electro-dynamics is condemned. But what is to be set up in its place? Is it to be the doctrine of Maxwell, or rather some approximation to that, for it would be too much to suppose that he had foreseen the truth in all its details? Though the probabilities are accumulating, no complete demonstration of that doctrine has ever attained.

We can measure the wave length of the Hertzian oscillations. That length is the product of the period into the velocity of propagation. We should know the velocity if we knew the period; but this last is so minute that we can not measure it; we can only calculate it by a formula due to Lord Kelvin. That calculation leads to figures agreeable to the theory of Maxwell; but the last doubts will only be dissipated when the velocity of propagation has been directly measured. (See Note I.)

But this is not all. Matters are far from being as simple as this brief account of the matter would lead one to think. There are various complications.

In the first place, there is around the exciter a true radiation of induction. The energy of the apparatus radiates abroad, and if no source feeds it, it quickly dissipates itself and the oscillations are rapidly extinguished. Hence arises the phenomenon of multiple resonance, discovered by Messrs. Sarasin and De la Rive, which at first seemed irreconcilable with the theory.

On the other hand, we know that light does not exactly follow the laws of geometrical optics, and the discrepancy, due to diffraction, increases proportionately to the wave length. With the great waves of the Hertzian undulations these phenomena must assume enormous importance and derange everything. It is doubtless fortunate, for the moment at least, that our means of observation are as coarse as they are, for otherwise the simplicity which struck us would give place to a dedalian complexity in which we should lose our way. No doubt, a good many perplexing anomalies have been due to this. For the same reason the experiments to prove a refraction of the electrical waves can hardly be considered as demonstrative.

It remains to speak of a difficulty still more grave, though doubtless not insurmountable. According to Maxwell, the coefficient of electrostatic induction of a transparent body ought to be equal to the square of its index of refraction. Now this is not so.¹ The few bodies which follow Maxwell's law are exceptions. The phenomena are plainly far more complex than was at first thought. But we have not yet been able to make out how matters stand, and the experiments conflict with one another.

Much, then, remains to be done. The identity of light with a vibratory motion in electricity is henceforth something more than a seductive hypothesis; it is a probable truth. But it is not yet quite proved.

NOTE I.—Since the above was written another great step has been taken. M. Blondlot has virtually succeeded, by ingenious experimental contrivances, in directly measuring the velocity of a disturbance along a wire. The number found differs little from the ratio of the units; that is, from the velocity of light, which is 300,000 kilometers per second. Since the interference experiments made at Geneva by Messrs. Sarasin and De la Rive have shown, as I said above, that induction is propagated in air with the same velocity as an electric disturbance which follows a conducting wire, we must conclude that the velocity of the induction is the same as that of light, which is a confirmation of the ideas of Maxwell.

M. Fizeau had formerly found for the velocity of electricity a number far smaller, about 180,000 kilometers. But there is no contradiction. The currents used by M. Fizeau, though intermittent, were of small frequency and penetrated to the axis of the wire, while the currents of M. Blondlot, oscillatory and of very short period, remained superficial and were confined to a layer of less than a hundredth of a millimeter in thickness. One may readily suppose the laws of propagation are not the same in the two cases.

NOTE II.—I have endeavored above to render the explanation of the electrostatic attractions and of the phenomena of induction comprehensible by means of a simile. Now let us see what Maxwell's idea is of the cause which produces the mutual attractions of currents.

¹That is, it is not so when we make the calculation with the indexes of refraction of the waves of visible light.—Translator.

While the electrostatic attractions are taken to be due to a multitude of little springs—that is to say, to the elasticity of the ether—it is supposed to be the living force and inertia of the same fluid which produce the phenomena of induction and electrodynamical effects.

The complete calculation is far too extended for these pages, and I shall again content myself with a simile. I shall borrow it from a well-known instrument—the centrifugal governor.

The living force of this apparatus is proportional to the square of the angular velocity and to the square of the distance of the balls.

According to the hypothesis of Maxwell, the ether is in motion in galvanic currents, and its living force is proportional to the square of the intensity of the current, which thus correspond, in the parallel I am endeavoring to establish, to the angular velocity of rotation.

If we consider two currents in the same direction, the living force, with equal intensity, will be greater the nearer the currents are to one another. If the currents have opposite directions, the living force will be greater the farther they are apart.

In order to increase the angular velocity of the regulator and consequently its living force, it is necessary to supply it with energy and consequently to overcome a resistance which we call its inertia.

In the same way, in order to increase the intensity of a current, we must augment the living force of the ether, and it will be necessary to supply it with energy and to overcome a resistance which is nothing but the inertia of the ether and which we call the induction.

The living force will be greater if the currents are in the same direction and near together. The energy to be furnished the counter electromotive force of induction will be greater. This is what we express when we say that the mutual action of two currents is to be added to their self-induction. The contrary is the case when their directions are opposite.

If we separate the balls of the regulator, it will be necessary, in order to maintain the angular velocity, to furnish energy, because with equal angular velocity the living force is greater the more the balls are separated.

In the same way, if two currents have the same direction and brought toward one another, it will be necessary, in order to maintain the intensity to supply energy, because the living force will be augmented. We shall, therefore, have to overcome an electromotive force of induction which will tend to diminish the intensity of the currents. It would tend on the contrary to augment it, if the currents had the same direction and were carried apart, or if they had opposite directions and were brought together.

Finally, the centrifugal force tends to increase the distance between the balls which would augment the living force were the angular velocity to be maintained.

In like manner, when the currents have the same direction, they attract each other—that is to say, they tend to approach each other, which would increase the living force if the intensity were maintained. If their directions are opposed they repel one another and tend to separate, which would again tend to increase the living force were the intensity kept constant.

Thus, the electrostatic effects would be due to the elasticity of the ether and the electrodynamical phenomena to the living force. Now, ought this elasticity itself to be explained, as Lord Kelvin thinks, by rotations of small parts of the fluid? Different reasons may render this hypothesis attractive; but it plays no essential part in the theory of Maxwell, which is quite independent of it.

In the same way, I have made comparisons with divers mechanisms. But they are only similes, and pretty rough ones. A complete mechanical explanation of electrical phenomena is not to be sought in the volumes of Maxwell, but only a statement of the conditions which any such explanation has to satisfy. Precisely what will confer long life on the work of Maxwell is its being unentangled with any special mechanical hypothesis.

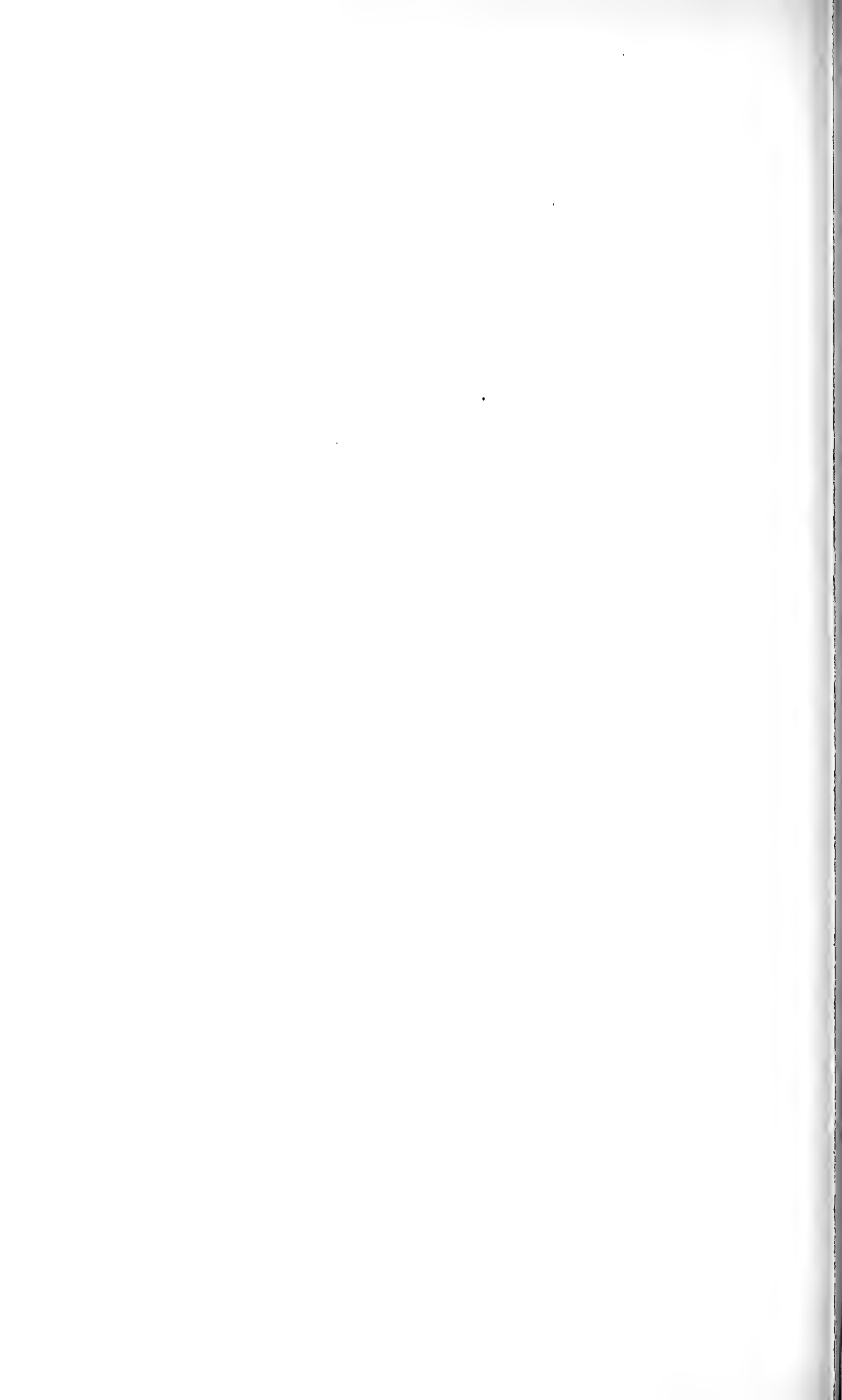

THE HENRY.¹

By T. C. MENDENHALL.

On the 21st of August, 1893, there assembled in Chicago an International Congress of Electricians, the transactions of which, while largely technical and scientific in their character, were in all respects important, and in some respects of great interest to the intelligent American public.

The organization of the congress and preparations for holding it in connection with the World's Columbian Exposition were well under way before the conception, or at least the publication, of the scheme for a series of so-called "World's Congresses," the proceedings of which were brought prominently to the attention of the reading public during the past summer. The American Institute of Electrical Engineers was probably the first body to take action in reference to an Electrical Congress. Cordial cooperation existed between it and the Exposition authorities, and a large and representative advisory committee, embracing nearly all of the leading American electricians, together with many of the first rank from foreign countries, was organized, with Dr. Elisha Gray, of Chicago, as chairman.

It is not intended, in this article, to give an account of the congress and its doings, but to refer to its organization and personnel only so far as is necessary to throw light upon the full intent and meaning of a single sentence in its proceedings.

The number of representatives of foreign governments present was unexpectedly large, and the delegates were of the highest character. To one who has some familiarity with the literature of electricity it will suffice to mention the names of Von Helmholtz, Mascart, Preece, Rowland, Silvanus Thompson, Ferraris, Ayrton, and Hospitalier, among the many who took part in the deliberations of the congress. The honorary president was Dr. H. von Helmholtz, whose splendid contributions to science cover so wide a field that he would have been easily first in congresses devoted to the consideration of several departments of human knowledge quite distinct and apart from that of electricity.

In its internal constitution the congress differed in some particulars from all others held in Chicago, and a part of its work had more of an

¹From the Atlantic Monthly, May, 1894, Vol. LXXIII, No. 439.

official and international character than that of any other. This was the consideration and official sanction of names and values of units of electrical measure.

Notwithstanding the fact that more than a hundred million dollars are invested in machines and instruments for the production and consumption of electricity and in their manufacture, little legislation has been had looking to the protection of producer and consumer through accurate measurement, as has long been recognized to be imperatively necessary in other commercial transactions. It is true that the science of electrical measurement has been thoroughly explored; excellent methods and instruments have been devised and constructed, and the most perfect system of units of measure ever conceived has been developed during the past quarter of a century. These units, being continually in use among scientific men, had come to be recognized as in some degree authoritative among those engaged in commercial applications of electricity, but in general no legal values were attached to these units, and in reference to two or three of them scientific men were not yet in entire accord in their nomenclature and definition. One or two electrical congresses, notably that at Paris in 1881, had previously considered these questions, and a tentative agreement upon some of the points at issue had been reached, but not much was accomplished that was satisfactory and lasting, except that an incentive was created for further and more accurate investigation of the values of certain physical constants in doubt. The results of these investigations and the general progress of the science of electricity during the past decade were such as to justify the belief that the time had now arrived when an international agreement could be reached upon definitive values of the units desirable and necessary in electrical measurement, as well as upon the names they should bear. To this end it was desirable that the consideration of such important questions should be restricted to a smaller, more deliberative body than the general congress of electricians, the membership of which reached several hundred. It was therefore agreed to create what was technically known as the chamber of delegates, which, as its name implies, consisted of specially commissioned delegates from the several countries represented.

In this chamber the United States, Great Britain, France, and Germany were allowed five delegates each. Some other nations were allowed three, others two, and some only one.

The members bore commissions from their respective Governments, and twenty-six were actually in attendance, representing nine different nations. The four great nations named above had full delegations, some others were only partly represented, and two or three nations had appointed delegates who failed to reach Chicago in time for the meeting of the congress. The chamber met in regular session every day during the week of the International Congress, with Professor Rowland, of Johns Hopkins University, as its presiding officer. At the end

it had unanimously agreed upon names and definitions for eight units of electrical measure, all that are thought to be necessary or desirable at the present time, and no more are likely to receive consideration for some years to come. The chamber passed a resolution recommending the official and authoritative adoption of these units by the several nations represented in the congress. They are all primarily derived from the fundamental units of length, mass, and time of the metric system, and are thus inter-related in the simplest possible manner.

As already stated, it is not the purpose of this article to discuss the conclusions reached by the chamber of delegates from a scientific standpoint, but it will be desirable to name the units selected, and explain in a general way their technical significance. In the order of their adoption by the chamber they are as follows: The ohm, the ampere, the volt, the coulomb, the farad, the joule, the watt, the henry.

These names are derived from those of distinguished scientific men, all worthy of a place in the front rank of modern physicists, and many of whom have made signal contributions to the advancement of the science of electricity and electrical measurement.

The *ohm* is the unit of resistance. It has been applied by common consent for many years to one of the three most important characteristics of a circuit conveying a current of electricity. Its use perpetuates the fame of the author of a simple and beautiful law by which these three fundamental elements are bound together.

G. S. Ohm was born in Bavaria in 1781, and educated at the University of Erlangen. In 1827 he published a pamphlet, *The Galvanic Circuit Investigated Mathematically*, containing what has since been universally known as "Ohm's law," and which has had a most important and far-reaching influence on the development of the theory and applications of electricity. Guided by Fourier's classic investigation of the flow of heat in conductors, Ohm, from purely theoretical considerations, arrived at the conclusion that in any circuit through which an electric current was made to pass the strength of the current—that is, the quantity of electricity passing a given section of a conductor in one second of time—was directly proportional to the electro-motive force (often called the "electrical pressure"), and inversely proportional to its resistance. The importance of Ohm's investigations was not recognized at the time of their publication. Had the full meaning of his conclusions been understood by those who shortly afterwards engaged in the development of the electro-magnetic telegraph, they would have been guided to results which were reached only after much loss of time and money and many vexatious and discouraging disappointments. In 1825 Barlow, in England, had declared the impossibility of the telegraph, owing to the difficulty of sending electric currents through long wires. It was noted that the strength of the current diminished greatly when the length of the conductor was increased, and this was properly assumed to be due to the greater resistance offered to the

passage of the current by the increased length. Barlow suggested that this could be overcome only by enlarging the dimensions of the conductor, and that when a current was transmitted through any considerable distance the diameter of the wire must be enormous. For this reason the electro-magnetic telegraph was an impracticable scheme. This apparently conclusive argument undoubtedly seriously delayed the progress of invention along that line.

But, curiously enough, about the time Ohm in Europe was publishing a theoretical investigation which might have furnished the key to the solution of the problem, in America a young man, not yet 30 years of age, named Joseph Henry, had begun a series of experimental researches at Albany, N. Y., which did make the way entirely clear a few years later. Henry attacked the difficulty both as to cause and effect. The effect was that when the conductor through which the current was passing was increased greatly in length, the strength of the current was so reduced that it was insufficient to operate the apparatus necessary for the reproduction of the signal at the receiving end. To meet this difficulty he investigated electro-magnets, and so improved upon the original device of Sturgeon that comparatively feeble currents were capable of producing mechanical effects through long wires. He also originated the ingenious device known as a "relay," by means of which a local battery is put in operation by a main current of little strength, thus making local effects independent of the strength of the main-line currents. By his invention of the "intensity magnet" and use of the "intensity battery" he made the electro-magnetic telegraph possible, and in 1831 he transmitted signals through a mile of wire, causing a bell to ring by the action of an electro-magnet. Out of this has grown the astounding network of wires—overhead, underground, and across the seas—by which the earth is girdled and the existence of which has wrought more change in the treatment of social, political, and commercial problems than any other single fact of the present century. While many of the conclusions which Henry had experimentally reached were in harmony with and might have been deduced from Ohm's law, to Ohm belongs the credit of having first clearly pointed out the real and exact meaning of "resistance" and its relation to the other conditions of the circuit. The bestowal of his name upon the unit by which it is measured is a fitting recognition of the lasting value of his discovery.

The *ampere* is the unit of current. André Marie Ampère, born at Lyons, France, in 1775, must be regarded as the creator of the science of electro-dynamics. In 1820 Oersted, the Dane, published his magnificent discovery of the effect of an electric current upon a freely suspended magnet, thus establishing the relation between magnetism and electricity which many of the ablest philosophers had sought in vain for years. Ampère first heard of what was called the "Copenhagen experiment" on September 11, 1820. On the 18th of the same month

he presented to the French Academy a paper in which he announced the fundamental principle of the science of electro-dynamics, together with a number of capital experiments in extension of Oersted's principle. In the incredibly short time of a single week he had gone all over Oersted's work, experimentally and theoretically; he had devised a new and ingenious hypothesis, for the examination of which he had invented novel forms of apparatus and by means of which he had brought the whole subject within the domain of mathematical treatment. The history of the science of electricity shows nothing more brilliant than the work of that memorable week. To him who was first to show the action and reaction of currents upon each other, and at the same time furnish a rational and most useful hypothesis upon which the now rapidly growing theory of electro-magnetism might be constructed, has long been freely accorded the high praise which is implied in calling the unit of current measure an ampere.

The beautifully simple law of Ohm, to which reference has already been made, and which is as omnipresent and omnipotent in electricity as is Newton's law of gravitation in astronomy and mechanics, is administered by and through a triumvirate. Two of the triad, namely, resistance and current, are presented above. The third, which is mathematically the product of these two, is the electro-motive force in the circuit, and its unit of measure is the *volt*. The appropriateness of this name will be at once recognized when the services of the distinguished Italian philosopher, Volta, the contemporary of Galvani, are remembered. In his early youth Volta was considered dull, and he showed little promise of future distinction. His first awakening to intellectual activity manifested itself in a tendency to compose poetry, but from this he turned to experimental science; and when Galvani, in 1786, saw in the twitchings of the legs of a frog the beginning of a series of marvelous discoveries which have made the nineteenth century greater than any that have gone before, Volta was in the prime of life, thoroughly equipped by taste and experience to take up the subject at a point where his countryman seemed likely to leave it, and so enlarge and enrich it as almost to make it entirely his own.

Differing from Galvani as to the cause of what was long called "galvanism," he originated what is known as the "contact theory," and was the first to have clear ideas of what is now termed "electro-motive force." His theory led him to the construction of the voltaic pile or battery, which has been of incalculable value in the development of the science of electricity and its applications. It happens that the unit of measure, one volt, is very nearly the electro motive force of one cell of Volta's battery, being a little less than that of an ordinary sulphate of copper ("bluestone") cell.

These, the ohm, the ampere, and the volt, are the three fundamental units of electrical measurement. They are related to one another through Ohm's law, and, as other units are largely derived from them

it will be useful to illustrate this relation before proceeding further. For this purpose perhaps nothing is better than the well-known and oft-repeated comparison of the flow of a current of electricity in a conductor to the flow of a stream of water through a pipe. When water flows from a reservoir through a pipe the quantity which passes any point in the pipe in one second (current strength) depends on the height of the reservoir above the outlet—that is, on the “head” or pressure under which it flows—and also on the resistance which the pipe offers to its motion. The greater the pressure the greater the flow, and the greater the resistance the less the flow. The strength of the current is therefore directly proportional to the pressure, and inversely proportional to the resistance. If in this statement “electro-motive” force be substituted for “pressure,” it becomes Ohm’s law. When these elements are measured in the units given above, the electro-motive force in volts, the resistance in ohms, and the current in amperes, the law is expressed very simply by saying that the “current is equal to the electro-motive force divided by the resistance.”

Thus, if the electro-motive force be 1 volt and the resistance of the circuit be 1 ohm the current will be 1 ampere. In an ordinary incandescent electric lamp the electro-motive force may be about 110 volts, the resistance of the carbon filament when hot about 175 ohms, and the current must therefore be about six-tenths of an ampere.

The unit of quantity is the *coulomb*. Charles Augustus Coulomb was a French engineer who made important contributions to science during the latter half of the last century. His character is well shown by the fact that he submitted to imprisonment rather than make a favorable report upon a proposed system of canals which he examined as a royal commissioner and which he could not approve. His ingenious invention, the torsion balance, enabled him to measure exceedingly small forces with an accuracy hitherto unknown in science; and by its use he made many brilliant researches in electricity, the first in which exact measurement played an important part. A coulomb is the quantity of electricity transferred by a current of 1 ampere in one second.

The unit of capacity is the *farad*. The name of Faraday might with propriety have attached to more than one unit of electrical measure. His remarkable career—as a newsboy, a bookbinder’s apprentice, an intensely interested listener to the lectures of Sir Humphry Davy, Davy’s helper, later his assistant, and finally his successor at the head of the Royal Institution in London—is so generally known that reference to it is hardly necessary. In the history of electricity three splendid discoveries stand incomparably above all others. With the first the names of Galvani and Volta are associated in the discovery of the new electricity and the means of generating it. In the second, Oersted and Ampère united in laying the foundation of the science of electro-magnetism. The third was the discovery of “induction,” in which Faraday and Joseph Henry made possible the marvelous development of the last two decades.

But every branch of the subject was enriched by Faraday, and among his most brilliant investigations are those relating to the "capacity of condensers," and especially the influence of the dielectric.

If an insulated, conductor is charged with electricity, the quantity which exists upon it will depend on the potential and the capacity of the conductor. It is exactly as if one spoke of the quantity of water in a lake or pond as depending on the depth (pressure, or "potential") and the area of the bottom (capacity). If two conductors are near each other, but separated by a comparatively thin layer of air, glass, shellac, or other dielectric, the "capacity" of the combination is much greater than that of either of the conductors, and it is known as a "condenser." The well-known Leyden jar is a common type. In speaking of the "potential" to which a condenser is charged, the word is used very much in the same sense as "electro-motive force" in what has gone before. Potential, therefore, may be, and constantly is, expressed in volts. The unit of capacity, the farad, is the capacity of a condenser which is charged to a potential of 1 volt by 1 coulomb of electricity.

To continue the analogy already used, the unit of capacity (area of bottom) for vessels holding water might be defined as that which would require unit depth to hold unit quantity.

The *joule* is the unit of work. The name of James Prescott Joule will forever be associated with the most splendid generalization of the present age, namely, the principle of the conservation of energy. Through his interest in electro-magnetism, and especially by his investigation of the efficiency of electric motors, he was led to the consideration of the correlation of the various forces of nature, and associated with Prof. William Thomson, now Lord Kelvin, he executed a remarkable series of experiments affording cumulative proof of the indestructibility of energy. With great appropriateness his name has been given to the unit of work. It is related directly and simply to the "erg," which is the unit of work of the centimeter-gram-second system. Reference has already been made to the fact that when a current of electricity is passed through a conductor heat is generated, the amount depending on the resistance of the conductor and the strength of the current. This heat is the equivalent of the energy electrically expended. The joule is the energy expended in one second by a current of 1 ampere passing through a resistance of 1 ohm. In the common incandescent or glow lamp the energy expended as heat in the carbon filament is about 63 joules in every second.

In addition to the unit of work, it is also extremely desirable to have a unit of rate of work, or, as it has been called by many writers, "activity," but which is more commonly expressed by the word "power." It is only natural that the name of one who was the first to recognize the necessity for a quantitative evaluation of the rate at which energy was absorbed, and to give numerical expression to it in the definition

of the horsepower, should be given to the new unit. The *watt* is also simply related to the centimeter-gram-second unit of power, and is defined as work done at the rate of 1 joule per second. The rate of expenditure of energy in the glow lamp already quoted would be 63 watts. One horsepower is equal to about 746 watts. When Watt came to Glasgow he was prevented from securing work as a mathematical-instrument maker by the action of the trades unions of that time. Fortunately, the door of the great university was opened to him, and there, in the capacity of maker and repairer of instruments and apparatus, his genius received its first encouragement and development. Although by education and training rather a practical than a scientific man, he possessed the true scientific insight to an unusual degree, and is eminently worthy of the associates among whom he is here placed.

The foregoing somewhat lengthy and detailed account of the history and origin of seven of the eight units of electrical measure recently adopted by the international congress has been thought desirable, if not necessary, to a full understanding of their relation, historically and otherwise, to the eighth and last, the name of which is the title of this article.

Most Americans are more or less familiar with the name and fame of Joseph Henry. To many he is known, however, only as the first Secretary of the Smithsonian Institution. Giving a broad and liberal interpretation to the somewhat vague language of the will of its founder, Henry molded the institution, while it was yet plastic and without traditions, into the form in which it has since essentially existed. He directed its energies into channels very different from those that would have been selected by one whose horizon was narrower than his, and, by steadfastly adhering to his own splendid conception of its functions as an instrument "for the increase and diffusion of knowledge among men," he made of it an organization which is, and must perpetually be, a benefit and a blessing to all mankind. Others, a smaller number, think of him as the youthful professor of mathematics and natural philosophy in the Albany Academy, where, in spite of the seven solid hours of teaching each day required of him, he found time to begin the series of researches in electro-magnetism which in later years were to make him famous. Here, and at the College of New Jersey, at Princeton, to which he was shortly transferred, he is seen pursuing these researches with that clearness of vision which characterized his work along all lines, and with an extraordinary fruitfulness which goes only with great intellectual activity accompanied by unflinching honesty of purpose. For fourteen years at Princeton, where he discharged the duties of professor of natural philosophy with signal success, he continued his original investigations, which, while touching many of the more important branches of physical science, were in general related to his favorite subjects, electricity and magnetism. At the end of this period, when at the very highest development of his powers, he was transferred to

that larger field of activity and usefulness which was offered by the new institution at Washington, to enter which he knowingly, and against the wishes of many of his friends, abandoned the practically assured prospect of lasting fame as one of the three or four most distinguished physicists of the present century. During these years the work was done which justifies and demands the recognition accorded to it in bestowing upon Henry the high honor of a place in the galaxy of famous physicists whose names will be perpetuated in the metrological nomenclature of all modern languages. In much of this work he was running on lines parallel to those followed by an English philosopher who is doubtless justly entitled to be considered as the first experimental physicist of the present age.

Although older by several years than Henry, Faraday began his series of memorable investigations in electricity about the time Henry presented his first papers on the same subject before the Albany Institute, a local scientific society of which he was a member. From this time forward they were often "treading upon each other's heels." In the early thirties great scientific discoveries were not announced in all parts of the world within twenty-four hours of their making, as is done to-day, thanks to the labor of these same two philosophers who sixty years ago, owing to infrequent communication across the sea and scanty means of publication on either side, were often ignorant of an important advance for some years after it had been made. Henry's innate modesty made him slow to recognize, at least to acknowledge, the value of what he did, and there is no doubt that he lost much in the way of general recognition by his failure to bring the results of his investigations promptly to the attention of the scientific public. Indeed, it was sometimes the urgency of his friends, more jealous than himself of his scientific reputation, that secured the tardy publication of important papers. At that date, far removed both in space and time from the center of scientific activity, he often contended with the discouraging yet natural and almost necessary fact that some of his finest work had been anticipated by those who had the start of him in time and the advantage in facilities and resources.

On August 30, 1831, Faraday made his splendid discovery of electromagnetic induction. Before this time Henry had investigated the conditions necessary to the production of a strong magnetic field, and had constructed by far the most powerful magnet known up to that day. Ignorant of Faraday's work, he planned and began in August, 1831, a series of experiments with a still more powerful magnet, having in view the discovery of a method of producing electricity from magnetism which Faraday was then on the eve of making. But, as already stated, his duties in the academy were exacting, and, being interrupted, he was prevented from returning to the subject for nearly a year. In the meantime news of Faraday's discovery had crossed the ocean, a meager account of his results having reached Henry sometime early in the

summer of 1832. He at once took up the subject, and by the aid of his powerful apparatus was enabled to produce striking verifications and extensions of Faraday's conclusions. A description of these experiments was published in Silliman's *American Journal of Science* for July, 1832, and the article contains the first announcement of a most important discovery, in which he anticipated Faraday by several years. "Ik Marvel" wrote a sentence in *Dream Life*, which has been an inspiration to many a young man, "There is no genius in life like the genius of energy and industry;" and if the genius is to develop in the direction of experimental science he might well have added, "and the genius of attention to apparently unimportant, accidental phenomena." It was this trait that was so highly developed in his character, this anxious solicitude that nothing, however trivial it might at the time seem, should escape without note, that brought to Henry the honor of the discovery of self-induction.

Faraday had found that when a current of electricity through one circuit was started, or stopped, or altered in strength, a current would be induced in a neighboring circuit; but the induction of a part of the circuit upon another part, or self-induction, had escaped him. Henry saw it in the interesting and previously unobserved fact that if the poles of a battery of no very great power be connected by a long wire, and the circuit be suddenly broken, a spark will be produced at the point of interruption, while if the connecting wire be short a spark will not be produced. He also noted that the effect was increased by coiling the wire into a helix, and he remarked, at the close of the article describing these experiments, "I can account for these phenomena only by supposing the long wire to become charged with electricity, which, by its reaction on itself, projects a spark when the connection is broken."¹

This was a capital observation; but, although published in 1832, it was apparently unknown to Faraday, who rediscovered the fact a few years later and announced it as new. As a matter of fact, it appears that Faraday did not himself observe the fundamental phenomenon, but that his attention was called to it by a friend. His announcement was made in the *Philosophical Magazine* in 1834, and in a communication to the Royal Society in 1835 he extended and enlarged upon the observation.

In much that he had done, however, he had been anticipated by Henry, who, although greatly interrupted in his original investigations by his removal from Albany to Princeton, had himself taken up the phenomenon of self-induction and made an interesting research.

As time and opportunity allowed, Henry continued his electrical investigations during the years that followed. He was the first to obtain induction from induced currents, and he made a classic investigation of

¹ There is good reason for believing that Henry had observed this phenomenon at a much earlier date than that of publication, and that the observation was really made before the discovery of induction by Faraday.

mutual induction and of currents of the second, third, fourth, and higher orders. In addition to his discovery of self-induction, his researches on the inductive effects of transient currents, on magnetic screening, and especially on the oscillations of the electric discharge were on new lines and of the highest order. The investigation of the oscillations of an electric discharge, one of the most important of all, was almost unrecognized until nearly a half century had elapsed. It was published in the Proceedings of the American Philosophical Society in 1842. In it he says: "The phenomena require us to admit the existence of a principal discharge in one direction, and then several reflex actions, backward and forward, each more feeble than the preceding, until the equilibrium is obtained."

Two years later Helmholtz wrote: "We assume that the discharge is not a simple motion of the electricity in one direction, but a backward and forward motion between the coatings, in oscillation, which become continually smaller, until the entire vis viva is destroyed by the sum of the resistances;" and in 1853 Prof. W. Thompson published in the Philosophical Magazine a mathematical investigation of Transient Electric Currents, developing an equation in which "the whole theory is packed up."

Concerning the influence of Henry's discoveries on the marvelous progress of electricity during the past five or ten years, it may be well to rest upon the opinion of one of England's leading electricians, who, in the preface to a recent volume on one of the latest phases of electrical development, writes as follows:

"At the head of this long line of illustrious investigators stand pre-eminent the names of Faraday and Henry. On the foundation stones of truth laid down by them all subsequent builders have been content to rest. The experimental researches of the one have been the guide of the experimentalist no less than the instructor of the student, since their orderly and detailed statements, alike of triumphant discovery and of suggestive failure, make them independent of any commentator. The scientific writings of Henry deserve hardly less careful study, for in them we have not only the lucid explanations of the discoverer, but the suggestions and ideas of a most profound and inventive mind, and which indicate that Henry had early touched levels of discovery only just recently becoming fully worked."¹

That one whose work is so highly esteemed should have been selected for honor in the international chamber of delegates is not surprising. It was also eminently fitting that his name should be given to the unit of induction.

As already intimated, the strength of the induced current depends on the rapidity with which that of the inducing current is altered. The sudden stopping of a current must be regarded as decrease at a very rapid rate, and the starting of a current as increase at a rapid

¹Fleming. The Alternate Current Transformer in Theory and Practice, Vol. I, London, 1889.

rate. It is during the most rapid changes in the strength of the inducing current that the strength of the induced current is greatest, and when a current is once established and flowing at a uniform rate no induction takes place. The unit of induction, the *henry*, is the induction in a circuit when the electromotive force induced is 1 volt, while the inducing current varies at the rate of 1 ampere per second.

It was gratifying to the American delegates in the chamber at Chicago that the motion to adopt "henry" as the name of this unit came from Professor Mascart, the distinguished leader of the French delegation, for among the French, some years ago, another name, the "quadrant" or "quad," had been proposed and since that time much used; that it was seconded by one of the leading delegates from England, Professor Ayrton, who had himself a few years ago proposed the word "sec-ohm" as being a proper name for the unit of induction, a proposition which for a time found much favor; and, finally, that it received the unanimous approval of the entire chamber, thus furnishing a testimonial of the highest order of the estimation in which the work of Joseph Henry is held, and a recognition of his rank as a natural philosopher, which some of his own countrymen had been somewhat tardy to appreciate and acknowledge.

THE AGE OF ELECTRICITY.¹

By M. MASCART,

President of the French Association for the Advancement of Science.

I.

The city of Caen, which so cordially greets us this day, was the capital of Normandy, and some of the greatest events of our national history are recorded in its annals.

Here was formed the little army that achieved the conquests of England, a glorious campaign indeed, but one from which, by a cruel turn of events, sprung a long period of struggle and misery when the heirs of the conquerors, merged in the great nation they had invaded, returned to enforce ever increasing claims upon the Kingdom of France.

Few provinces have been the birthplace of so many illustrious sons—soldiers, sailors, politicians, magistrates, historians, orators, jurists, poets, artists, men of letters and of science. Your city has long been a center of learning and it still maintains its intellectual predominance over the neighboring departments which in former years were part of its territory. Your literary and scientific societies have been famous for centuries. You are even now one of the principal headquarters of the university, and the Palace of the Faculties which you inaugurated a few days ago shows that your hearts are set upon maintaining that noble tradition.

The sojourn of the French Association might afford an opportunity for paying homage to the celebrities of your place, but I am too obviously unfit to do so. I shall confine myself to recalling the names of some of the scientists of whom you may justly be proud.

Unless we go as far back as the celebrated Graindorge family we must first mention the name of Pierre Varignon, born at Caen in 1654, a geometrician and mechanist, a member of the Academy of Sciences, whom students still hear mentioned at lectures when care is taken to acquaint them with the founders of science. The chemists

¹Address before l'Association Française pour l'Avancement des Sciences. Congrès de Caen, 1894. Translated from *Revue Scientifique*, August 11, 1894, 4th series, Vol. II.

Rouelle and Vauquelin were both born in the suburbs of Caen of the most lowly families, who, by stubborn labor and struggle with the difficulties of life, reached the highest station in science. Earnestness in teaching and uncommon skill in experimenting made Rouelle famous. It is said of him that when before an audience he was not quite himself until he had doffed his coat and wig. Vauquelin had received but indifferent instruction in his native village. On the advice of an intelligent mother he left his home at the age of 14 to make a living as a laboratory boy in apothecary shops, where he stealthily learned the chemistry of the times.

On being introduced to Fourcroy he had at last some leisure in which to perfect his knowledge, adding thereto the ancient languages; became the collaborator of his master; and occupied in turn the chairs of the *École Polytechnique*, the *École des Mines*, the *Collège de France*, the *École de Pharmacie*, the *Faculté de Médecine*, and the *Muséum d'Histoire Naturelle*.

"After living," says Cuvier, "in circumstances closely resembling destitution, and being pushed by others into the possession of quite a considerable fortune, which increased all the more rapidly, as he never had any personal cravings, he always held to the habits of his youth. He would return to his village every year and there meet his old mother without whom he would accept no invitation, whatever might be the station and wealth of those who asked his company."

Dumont-Durville, born in 1790 at Condésur-Noireau (Calvados), has carried the flag of his country over every sea on the surface of the globe, striking the seafaring world with amazement at the boldness of his undertakings and bringing from his travels scientific treasures of every description, until the end came, after going through the most daring ventures in safety, by his being burned to death in a railroad accident. It was no vanity for him to say: "An iron will never permitted any obstacle to stand in my way. When I had once made up my mind to perish or succeed, I was proof against any wavering, against any uncertainty."

There is at Beaumont-en-Auge a house which bears on its front an inscription that begins thus:

"In this humble dwelling Laplace was born."

I curtail the citation so as not to lay the inspiration of this homely poetry open to criticism, but it is pleasant to find in it the homage of his countrymen to one of the greatest minds of the century. In his oration, delivered before the Academy of Sciences, Fourier said:

"The wonders of heaven, the high questions of philosophy, the ingenious and profound combinations of mathematical analysis, all the laws of the universe, have for over sixty years occupied his mind, and his efforts have been crowned with immortal discoveries. - - -

"It can not be asserted that he would have been qualified to create some entirely new science, as was done by Archimedes and Galileo;

to infuse, like Descartes, Newton, and Leibnitz, original principles into mathematical doctrines, or, like Newton, to be the first in applying to the sky and extending to the whole universe the terrestrial dynamics of Galileo; but Laplace was born to perfect, to search into everything, to remove all bounds, to solve that which may have seemed insolvable. He would have completed the science of the heavens if it were possible to complete it. - - - Science was the object of his life; science has made his memory imperishable."

You also may claim as your own one of the founders of geology in France. Like the author of the *Mécanique Céleste*, Élie de Beaumont was a scion of a great family, whose name was already prominent in the history of parliaments. He had no sooner graduated from the *École des Mines* than he was, jointly with Dufrenoy, commissioned to make a geological map of France. After preparing for their work by travels abroad, especially to England, the two engineers spent many years in laboriously exploring every part of the country. The result of their gigantic work was the publication of a celebrated map which has served as a model, of which the geologists of to-day can only complete the details. At the same time, Élie de Beaumont soared to the loftiest conceptions in regard to the structure of the terrestrial strata, and recognizing no other criterion than that afforded by demonstrated facts, he did not hesitate to criticise the doctrines of his tutors. In spite of the dryness of his subjects, he knew how to arrest attention by his style, from which elegance was not excluded by accuracy, a praise that can seldom be made in our days. Some of his pages on the physiography of the Vosges have often been cited as bearing the marks of the sweetest poetry. Allow me to again borrow from it:

"The systems of mountains are at one and the same time the most delicate and the most general features of the projections on the surface of the globe. They are at one and the same time the quintessence of topography, and the most characteristic marks of the upheavals which the surface of the globe has experienced. They are the mutual bond that unites the daily operation of the elements as determined by the present relief of the earth with the events that gave this relief its shape in the past. When it was sought to coordinate the component parts of the vast combination of signs with which the hand of time has engraved the history of the globe on its surface, it was found that the mountains are the capital letters of the immense manuscript, and that each system of mountains contains a chapter of it."

It affords me special pleasure to now recall the name of a modest savant who might, perhaps, experience the greatest surprise at the tribute which I desire to pay to his memory. Gaugain, at one time a student of the *École Polytechnique*, soon gave up industrial pursuits, in which he had met with but little success, for there was nothing he was less fitted for than trade, and devoted himself to scientific researches.

There was no luxury in his laboratory; his fond daughter was his preparator; a bottle and a gold leaf constituted one of the most ingenious electrometers; a few spools of sewing thread were enough to represent electric cables. With such a crude outfit he succeeded in giving

an experimental demonstration of the laws of the propagation of electricity through slightly conductive bodies and to verify the correctness of the formulæ that Ohm had merely indicated as being mathematically analogous to Fourier's theory on the propagation of heat. With similar means he disclosed the relations existing between the theorems of static electricity and the propagation of currents. His investigations of thermoelectric phenomena and the properties of crystals are stamped with the same mark of perfection; the methods adopted by him still stand among the most elegant and correct. The one fault with his investigations was perhaps that they were too early and could not be well understood; they were subsequently thrown in the shade by more brilliant discovery, and it was only when nearing the close of his career that Gaugain enjoyed the well-deserved satisfaction of being appreciated according to his merits.

Augustin Fresnel was born at Broglie. He is not therefore a citizen of the Department of Calvados, but he is one of yours as a Low Norman, and a memorable circumstance of his life binds him to you by even closer ties. At the beginning of the "Hundred days" he was suspended from his office of engineer for expressing too openly his partiality to the restoration, and came to enjoy his enforced leisure in the small village of Mathieu, the elder Rouelle's home. He undertook at that place his labors on optics which were to make him famous. But for that fortunate disgrace, Fresnel would, we fear, never have found time to give himself up to scientific investigation, by reason of his extremely delicate health, and to give full scope to his genius. From that time, and during a period of twelve years, his papers follow one another with prodigious fecundity, as though he had a presentiment that his days were numbered. He shattered forever the hypothesis of emission by showing that all the phenomena of interference and diffraction are the necessary consequence of the doctrine of undulations; and he followed up the expansion of that theory in all its details by setting down the rules of reflection, refraction, double refraction, etc.

Whenever he found that mathematical analysis or the accepted notions on the mechanical structure of the mediums did not afford him adequate resources, he boldly skipped the arduous passages over which he had no time to tarry and guessed the rest. After eighty years his work remains intact, confirmed more and more by subsequent investigations. His papers still constitute the most fruitful reading for physicists. They afford a better comprehension of his mind, and offer a vast number of disseminated prolific notions which had at first escaped notice, and which others after him thought they had discovered. Newton alone, according to an English savant, is greater than he.

A bust of Fresnel stands on his grave at the Père-Lachaise cemetery. Some years ago the Société de Physique set about to search for any memento of this national celebrity. An abandoned grave, hidden from view by wild vegetation, was discovered with great difficulty.

No near or distant relative authorized to maintain its sanctity was in existence. Being unable to do more for the present, the society had the unpretending monument repaired and keeps it reverently adorned with flowers. Lavoisier has been waiting a century for the memorial he is entitled to, but the oversight will soon be repaired. At a time like this when the talent of our artists is a sufficient justification for the number of statues, Fresnel should wait no longer.

You also hold title to another celebrity in astronomy and celestial mechanics, Leverrier born at St. Malo de la Cande (Manche), in the heart of Normandy, and whom it was the pride of the College of Caen to number among its students. Leverrier is chiefly known for his discovery of Neptune. The learned astronomer, while yet almost a beginner, succeeded by a formidable amount of clever and sedulous calculations in determining its existence and its position in the heavens. The planet Uranus appears every day in the telescope which is set for it at the meridian, now ahead, and then aback of the anticipated time, but never by more than a second. These slight differences were, however, the starting point for which the disturbing celestial body was looked for and found on the very day when the announcement was made within a degree of the position given by the reckonings. The expanse open to observations, within which the planets gravitate around the sun, has been doubled by the discovery of Neptune. Although the general public is less familiar with the works of Leverrier on the stability of the solar system and on the theory of the several planets, these are, nevertheless, imperishable monuments.

In a different field Leverrier proved to be a veritable originator. The hurricane which fell upon the allied fleets in the Black Sea in 1854 and caused the loss of the French ship *Henri IV* is still remembered. Gales had been signaled at the same time over the whole of Europe with differences of from one to two days. Leverrier instituted an inquiry among the observatories of the several countries. It was found, upon a retrospective examination of the perturbation, that it had progressed from the west to the east, and that through telegraphic warning our fleets and armies might have been saved from the disaster. Grasping at once the import of an international service of weather forecast, he applied his whole diligence to the purpose. As early as 1857 the observatory at Paris was in daily receipt of telegrams from all parts of Europe and inaugurated the service of notices which has since been imitated the world over: "To signal a hurricane," thought he, "as soon as it may make its appearance in any part of Europe, to follow it in its advance by means of the telegraph and to give previous notice to such coasts as it may visit, such is the ultimate end of the organization we are aiming at."

Moreover he was looking upon that science from a higher standpoint. The laws of the atmospheric movements can not be known unless all the phenomena produced are examined upon a large area, if not over

the whole surface of the earth. "Better," said he, "ascertain facts in all parts at one time during the year than to keep up for a whole century a few scattered observations." Besides, these movements undergo changes in each region according to local conditions, so that the general manifestations of the climate, the course of rainfall and of temperature require a system of interdependent observations. Leverrier leaves nothing undone. He bespeaks the cooperation of foreign observatories for the forecast service, that of seafaring men for the meteorological observations on the ocean, that of all willing contributors for a knowledge of all the particulars of climate in France. We have inherited the responsible duty of continuing this part of his work, and have hardly anything better to do than to follow up his programme. Would that we could fulfill it.

In one respect Leverrier is specially entitled to our gratitude. He founded, in 1864, the Association Scientifique, an efficient organization which, after long prosperity, finally consolidated with ours, a new-comer, so as to constitute a compact union of scientists and of friends of science from all parts.

I again find here occasion to speak of one of your fellow-townsmen. In 1839 an association of men, moved by the spirit of progress, and of which de Caumont was the most active member, wished to place on the footing of permanent organization certain scientific congresses that had already met regularly for a number of years, and drafted the constitution of an institute of the provinces whose object was to include all men of letters and of science whose long labors had won for them a well-deserved renown. In the minds of its founders, that society was to be the soul of the academic movement in France and the departments. They expected to fulfill that part by multiplying calls for congresses, by establishing closer relations between local societies and academies, thus leading them to greater uniformity in their work and publications so as to unite for the same ends the large amount of power scattered all over the soil of France.

De Caumont was indefatigable. He recklessly spent his time and his own fortune. The very plan of the undertaking did perhaps contain germs of weakness for the future, but the scheme was a generous one, and although they never met with any of the encouragement they might have anticipated, the founders were largely instrumental in arousing scientific activity in the departments. Their efforts have been successful, for it can not be denied that the committee of scientific societies, now a dependency of the ministry of public instruction, the annual meetings of the Sorbonne, the congresses of the late scientific association and the sittings of the French Association are carrying out under various forms the several parts of the vast programme that the Institute of the Provinces had set up for itself. After holding its own for thirty-four years, the Institute of the Provinces made way for the French Association, which aimed at the same ends with better means of action and better security for the future.

De Caumont was above all an archaeologist, and he has his place marked among the leading founders of the science, but the part he took in developing scientific activity in the provinces is liable to sooner pass from memory. This is a fit occasion on which to pay tribute to his achievements in intellectual propagation.

It is not only in the scientific domain that you have an abundance of local celebrities. You have already done justice to the most famous, but there is still ample material from which to designate your streets and public squares with names that redound to the glory of your country.

II.

You will not be surprised if a president who has crossed the Atlantic and thereby been kept from discharging the duties that fell to him last year at the Besançon congress, now feels desirous of explaining his absence and of laying before you some reminiscences of the American continent. The United States have come to be a fashionable topic. They have been much talked of in newspapers and publications of all kinds, in a rather unkind vein at first, we must confess, but public opinion has since undergone a perceptible change.

The visitors brought to that country by the Chicago Exposition are unanimous in confessing their opinion that while the manners there widely differ from ours, the Americans in the North constitute a great nation, whose influence will be more and more felt on the ancient continent.

Upon first landing in the United States one is not very favorably impressed, possibly from the effects of prejudice. One sees there restless people who rush through the streets as through the halls of a bank, with no other care than business; who do away with idle talk and forms of politeness to save time, and whose only concern seems to be about the number of dollars that the day will bring in. In that land of freedom a high price appears to be set on everything, public office, access to the bench, and the stewardship of city funds. The young go into early training at small trades which enable them to "make money" whatever may be the circumstances of their fathers, and launch into greater undertakings before their minds have gone through sufficient intellectual preparation. The girls, who generally have better instruction, direct their own course in the world, receive friends of either sex, and being without the attraction of a dowry, depend upon their personal gifts and charms to find husbands who have already been successful in business, and whom they are to win for themselves. Outside of cities, and not remote from the Eastern coast, where civilization has longer existed, forests have been burned, either for the purpose of leaching the ashes or simply for making a clearing at small expense, thus absolutely spurning the wealth wasted in that manner. In meadows or cultivated fields charred trunks or huge stumps stand here and there as witnesses of wanton destruction, and have been left on

the spot because they would not yield enough to pay for more complete removal. In the far West settlers are seldom seen without their revolvers, with which they are armed not only for defense against and, if need be, the merciless extermination of the aborigines, but also to fight against newcomers, and thus maintain possession of their fields or mines.

The multitude of emigrants, who are prone to blend their various origins and to constitute a peculiar race, comes in like an army of invaders gifted with unwonted pluck, and bent on making the most of the country without many scruples or much regard for the future.

I need not say that such a picture, in spite of its foundation of truth, is no more accurate than a cartoon is like a portrait, but "Paris en Amerique" is also a legend that must be taken with considerable allowance.

And yet a longer intercourse with the Americans, a more thorough insight into their private lives and public institutions, a partial departure from the European standpoint and our historical traditions, will very soon create in us a genuine sense of admiration for the prodigious results they have achieved in a few centuries. The country has received its true characteristics from its people of Anglo-Saxon descent; they have imbued it with a spirit of adventure, of profitable enterprise, of independence and liberty. Those who go there with any ambition for success must perforce conform by degrees to the same ideas. In most cases the process of assimilation is evidenced by their rapidly forgetting their mother tongue. Free will is impeded by no trammels; everyone works for himself and his own, and makes as few calls as possible on the resources of the community.

Without saying anything of the general departments of the Union and of the several States which might profitably be considered, I only wish to call your attention for an instant to the part taken by private initiative in scientific matters. We all have within us, at different degrees of development, the notion of a State—Providence—but the State is not equal to this universal function, and the support that is too often demanded as of right from it is detrimental to the share that each individual might take in matters of public interest.

To be sure there are benefactors left in our country. Several names are upon your lips, and they would be the first to admit that examples from the New World are likely to enhance their merits in your opinion.

The foundations of scientific institutions or establishments in the United States are of two kinds. Some are progressive; others are, so to speak, extemporaneous.

In the year 1620 a colony of Puritans, persecuted in England on account of their religious tenets, came to America and founded the town of Plymouth, on the coast of Massachusetts. In 1630 others of their faith from Boston and other parts of England settled Boston, Massachusetts, near Plymouth; their new city has eclipsed the mother

town in a singular manner. In 1636 the general court appropriated a sum of \$2,000 for the foundation of a college, especially denominational in its character, in a neighboring place, which soon assumed the name of Cambridge in remembrance of the celebrated university at which most of the colonists had received their education. Two years thereafter Rev. John Harvard bequeathed one-half of his property and the whole of his library to the new college. Such was the origin of Harvard College, which later became the Harvard University.

That example of private donations has been uninterruptedly followed ever since. The institution, which had very hard beginnings, refused no offerings, however modest. The list includes a lot of sheep, 9 shillings' worth of cotton, a pewter pot, a fruit dish, a sugar spoon, a pitcher inlaid with silver, etc. The college subsequently received the income of the ferry which crossed the river.

During many years the history of the college is but a narrative of a succession of financial difficulties; of strife with the city council, that sought to maintain its control over the institution; with the government of the metropolis, with which the sentiments of the founders found little favor; and, lastly, with the clergy, to the end that teachers and students might preserve their religious independence and that the scope of teaching be enlarged. Some of the buildings were destroyed by several fires, but in these instances, barring the regret felt for the loss of the articles destroyed—as, for instance, the library of Harvard, the founder, which had theretofore been preserved as a relic—the evil proved a blessing in the end, for private contribution, under the emotion caused by the calamity, supplied means far in excess of the losses sustained by the disaster.

Even in the midst of the ordeals caused by the Revolutionary and civil wars, the institution constantly added to its wealth and continued its onward march. It shakes off at last every outside influence and acquires absolute autonomy. Harvard University at the present day constitutes a powerful corporation, which includes faculties of arts, sciences, theology, law, medicine, dental and veterinary surgery, and agriculture. In 1891-92 there were 253 teachers of various grades and 2,700 students, who were the recipients of subsidies in various shapes, prizes, or cost of tuition amounting to \$85,000.

In 1891 the aggregate of ordinary receipts, income from various sources, and money paid for instruction, was \$966,000. Over and above these sums, there was received during the year \$100,000 to add to the capital and \$65,000 for immediate use, without taking into account the donations in kind such as scientific collections or implements. The greater portion of the capital comes from gifts without any special application and remains at the disposal of the directors; about one-fifth consists of special funds destined for the erection of buildings, the maintenance of certain chairs, laboratories, gymnasiums, lecture halls, or for special investigations. It is proper to mention at this place the

admirable Museum of Comparative Zoology founded by Louis Agassiz, as well as the observatory established by Bond in 1840, which commands a revenue of its own such as to enable it to maintain, besides the mother institution and transient missions, three meteorological stations in the United States, a permanent astronomical observatory at Arequipa, Peru, 2,600 meters above the level of the sea, and a meteorological station on Mount Chachani, Peru, at an altitude of 5,460 meters.

The university spends its income, but when confronted by some new requirement it need not be embarrassed. Such is the popularity it enjoys that all it needs to do is to publish a notice in the daily press that a sum of \$50,000 is deemed necessary for the establishment of a chair of histology or of the Peruvian language, and in a fortnight the sum will be subscribed.

It happens that some of the donations cause the directors considerable embarrassment; such, for instance, as the pension applicable to the maintenance of a pastor of Indian extraction. Not only are the original races indifferently adapted to the duties of a Christian pastor, but the incumbents themselves will fail on the day, that may be near at hand, when they shall have disappeared before the advance of a civilization they can not withstand.

A number of institutions of learning, charity, or public utility have had a similar origin in the several States, and have in time grown always in proportion to the good they have done. But the pace must be quicker in these days of ours. Cities thrive at a more rapid rate, and each State strives to do as well as the neighboring States or better.

Chicago was last year the focus of public attention, and our countrymen have had some share in founding that great city. For these two reasons we shall refer to it for some examples. The Institute of Fine Arts of Chicago, incorporated under legal authority in 1879, erected in 1892, after occupying several temporary homes, a palace that cost \$600,000. I give the figures, because everything is measured by them in America. This institute is nothing more than an association organized for the public good, and all its revenues are applied to the advancement of art. It receives no subsidy from the State or the city; it has no other source of income than the tuition fees and private contributions. It has barely made a start and it already owns valuable collections, donated by private citizens, some of which are entitled to the much coveted name of being the greatest in the United States, pending the time when they will be the greatest in the world.

The first university of Chicago, begun in 1858, was not a success. It closed its doors in 1886. In 1889, Mr. John D. Rockefeller, after taking reliable advice, undertook to resurrect it and began with a donation of \$600,000, subject to that noteworthy condition that \$400,000 more be collected by subscription before a certain date, for he wanted to make sure that the public would approve his undertaking. Encour-

aged by the success then achieved, he added, in 1890, \$1,000,000 to his original contribution; then, in 1892, one thousand 5 per cent bonds, representing another million. In the same year Mr. Marshall Field donated \$100,000 for a special purpose, on condition that a million dollars be secured by subscriptions within ninety days, and all was subscribed before the appointed day. In the month of December Mr. Rockefeller again contributed bonds for \$1,000,000. The same influx of liberality occurred in 1893, when again donations are made conditionally, and the required complement never fails to realize at a stated time.

This infant university, which has kept the name of its founder, Mr. Rockefeller, is almost as wealthy already as its elder, Harvard. It has teachers in every branch of learning, and its material equipment is such as to excite much envy. It is not my object to go into an examination of the courses, but one may rest assured that, with the command of such resources, a supply which is never exhausted, and the facility thus afforded of calling men of the highest merit to its chairs, the University of Chicago has a great future in store, and it will make its mark in scientific advancement.

I have no desire to continue dazzling you with figures; all I should have to do would be to quote freely from the documents distributed with readiness by the Americans.

The Armour Institute bears a name which the trade in food products has made known over the whole world. This tells for itself where the dollars come from. This institution now comprises nine departments for the simultaneous teaching of letters, fine arts, sciences and their applications, household arts, education, and commerce. "The Armour Institute," says the programme, "aims to help those who are willing to help themselves and to educate the head, hand, and heart"—the three "hs", as they style it over there.

The same methods obtain in all the States, whether young or old. It would require a volume to convey an idea of the liberality with which the citizens act toward the institutions of learning, whatever be their degree.

Astronomy enjoys especial favor. Observatories with greater or less endowments are erected in all parts; but, save that at Washington, which is Federal property, nearly all the others are private foundations with resources which to us are not usual. The largest telescope yet known, built for the Chicago Observatory, was at the Exposition.

The founder of the Pulkowa Observatory expressed the desire that it might possess a telescope as powerful as any that was to be found in the world; the Americans are bent on having the largest. It is the ancient fable: Bacchus created a wonderful fox that could not be outrun; Vulcan, on the other hand, gave to a dog of his own making the faculty of overtaking any animal that it might chase. "Then it came to pass that both beasts met." In the present case all the appearances are in favor of the Yankee god coming out best.

And yet America occupies even now a place of honor in astronomical discoveries, and her share grows greater every day. Besides, every science is rapidly progressing there, and her scientists of the first rank are multiplying. There will soon be nothing except history for which the United States can envy the nations of the old continents.

You will no doubt hold that it is a grand sight to behold a people against whom the charge of avarice and of immoderate lust of gain is readily brought, show themselves so universally considerate of the public weal and achieve such results either through the continuous action of the citizens or through princely foundations, whether it be a question of charitable institutions, model hospitals, fine arts, primary or trade schools, institutions for the training of engineers or machinists, or of institutions of learning for the intellectual elevation of the mind, and all without any design for commercial gain. Men of pluck and daring make fortunes in a short time. They are not to the same extent as we are intent on letting their heirs profit by the whole of their wealth. In the same manner as titles of nobility are sought after elsewhere, they have at heart to perpetuate their names by enduring deeds that will do good to the community or honor to the country.

Are our efforts in that direction to be compared with those, even though we may take into consideration all the liberal gifts it would be unfair to ignore? Do not those who are among the foremost favorites of fortune, either by grace of their ancestors or through personal industry, experience greater difficulty, as I look upon it from some distance, in putting their wealth to good use than they ever had in coming by it?

I am well aware of the fact that the greater number of institutions in our country are under State control and that no one thinks much of giving to the State, because such donations are merged in the ocean of appropriations. The French Association is free from such objections. It is a private institution, founded by men of honest purpose whose object was the advancement of science for the good name of the country. It promotes that purpose by calling these meetings, so fraught with good results, that bring us together at various parts of our territory. It strives to assist single-handed investigators and applies the best part of its resources to such assistance. It lacks none of the requisites that should receive the attention of donors and it deserves to attract it. We already find great encouragement in our circumstances. The total receipts from donations, bequests, and founders' shares exceed 1,000,000 francs at the present time. It is proper to separate therefrom the legacies of Messrs. Brunet, Legroux, Fontarive, and Girard (this latter being set apart for the section of anthropology), which aggregate over 400,000 francs.

If I may be allowed to throw out a hint for those who may be encouraged by these examples, I would suggest that the nature of the investigations they intend to further be not defined with too narrow preciseness. We need not fear that we might be required to maintain

an Indian pastor, but science is making unceasing strides forward; questions present themselves under altered forms, new ones come up, and others again unexpectedly command more interest than could have been anticipated. The board of directors of the association is composed of recognized savants who will manage such funds as may be intrusted to their care to the best advantage of science and country.

III.

Tradition requires that the president of your academy should impart to you his comments on the advance made in such branch of the sciences as may have received his greatest attention. My duties might perhaps lead me to speak of the weather. It is a topic that is always in order. But electricity has reached so prominent a place in industrial and social matters that you will readily pardon me for endeavoring to retrace some of the features of its history.

The science of electricity dates from at least as remote a period as classic antiquity, but it did not really come into favor until the course of the eighteenth century. Experiments then began to multiply, in some confusion at first, for most of the important facts were made known at the same time. Order was gradually established. The conductivity of various mediums, the two kinds of electricity, and condensation, were discovered in turn. The transmission of signals to long distances was even conceived, while De Romas and Franklin ascertained the identity of lightning and electrical sparks. There seemed to be nothing left undone after Coulomb had demonstrated that the reciprocal action of electrified bodies and magnets was the same as that of universal gravitation. The mathematical methods, as perfected by the astronomers, were applied to the new science, and the phenomena, or at least most of them, were to be deduced by mere calculation.

To be sure Volta made thereupon an unexpected discovery, the voltaic pile, at the effects of which his contemporaries marveled; but there will always be shortsighted minds entertaining the notion that human progress is drawing near the bounds of its course.

In a History of Galvanism, published in 1805 and not extensively read in our days (who among us can cherish the hope of being read a century hence?), the author returns a very fit answer to the objection of those who believe that history should not be published until it is absolutely complete; but he proceeds thus:

“Moreover, if fresh material compels us to publish a third part, as it will consist of new matter distinct from that of the first two, it will answer as a sequel to those two, and will perhaps make up the conclusion of the History of Galvanism, which may be nearer its end than is generally believed.”

It was an unfortunate prediction, for he was forthwith compelled to add a third and even a fourth part; he would have many more additions to make. The First Consul had better judgment. Four years

before, on the 16th Brumaire of the year 10, after attending the sitting of the institute at which Volta's paper on the pile was read, he was struck with the idea that it would be a credit to France to open a contest to which all the scientists from all countries should be invited, and to award an extraordinary prize "to the most valuable writing on this branch of physics which seemed to open the way for great discoveries."

Progress in science is made by starts, when a felicitous experiment or a stroke of genius brings a change in its confines. It took over twenty years after Volta to find whether any perceptible phenomenon takes place in the copper conductor which connects the two poles in the pile. The discovery of Oersted and the immortal investigations of Ampère established a relation between electricity and magnetism; iron was magnetized by means of currents and electrical telegraphy was the result.

But what a number of questions then confronted our minds. As long as the phenomena remained independent of one another, they could be explained by special theories applying to each one of them. It was the day of fluids. After the caloric fluid, it cost no greater effort to imagine the two electric fluids and the two magnetic fluids, to say nothing of the neutral fluids required to connect them, and the ether with which the universe was filled to serve as a medium of transmission of light. No true philosophy can be based on such a multiplicity of independent entities, for phenomena are not confined in distinct provinces with their immediate causes. Ampère had already pointed out that it would undoubtedly be necessary to turn to the intervention of the fluid that pervades all space in order to explain the forces that operate between conductors carrying electric currents.

The agent itself remains a mystery, a title that electricity enjoys by privilege, as it were. Yet we must admit without looking back to the origin of all things, that science is everywhere face to face with mysteries—universal gravitation, heat, constitution of bodies, light, electricity, magnetism, life,—

While habit impels us to accept such of these as come under the more direct observation of our senses, they remain none the less inexplicable, and we must confine ourselves to a study of experimental laws, more or less connected by other laws of a more general character, without any possibility of penetrating the intimate structure of the universe. One of the great minds of our age, in whose presence wonder was expressed at the inexplicability of certain phenomena, remarked with profound meaning: "Tell me what electricity is and I will tell you all the rest."

After Oersted and Ampère, a great step remained to be made. "When it is seen," said Fresnel in 1820, "that an electric current running through a metallic helix wound around a steel cylinder magnetizes the latter, it seems natural to try whether a magnetized bar is not capable of producing a voltaic current in the surrounding

helix; not that this be at first sight a natural consequence of the facts - - - yet I thought it would not be an idle experiment to attempt."

The result was disappointing, and Fresnel concludes that curious paper with the following words:

"I must add, in behalf of M. Ampère, that the slight movements that he had noticed in a magnetic needle when he brought near to it a circuit of brass wire, a part of which was spirally wound around a magnet, were not repeated in a constant manner, and besides that they were so slight that he would not have made that experiment public had he not felt certain from the success of my own experiment, of which he entertained no doubt, that these slight motions were also caused by an electric current produced by the magnet acting upon the helix wound around it."

We may rely on the notorious awkwardness of Ampère for an assurance that his helix was not attached to the magnet, that it was thrown out of shape while a portion of the wire was brought near the needle, and that he had actually discovered the induction currents; it will suffice to repeat his experiment without any modification.

Shortly thereafter Daniel Colladon, in whom the last figure of an illustrious generation has just disappeared, also investigated, by a more delicate process, whether a very powerful magnet will produce an electric current in a helix by being brought near it. The helix was connected with a galvanometer and the latter was kept in a separate room so as to preclude any direct action of the magnet. After making all preparations for the experiment and putting the magnet in position, Colladon would go and inspect his galvanometer. He probably did so without great haste, for the index was motionless and at the same point where it stood before.

"I had not suspected," said he, "that induction could only be instantaneous. If I had had an assistant he would have seen for me the displacement of the magnetic needle occurring at the instant when I brought the magnet near the helix."

It has sometimes been said that the induction currents are the sentries charged with the protection of the principle of the conservation of energy. Nothing is produced without an expense of labor, and the failure of the preceding experiments was due to a singular oversight of that principle.

The discovery by Arago of the effect of copper plates in abating the oscillations of magnetic bars, and of the attraction of these bars by conductive mediums in motion was giving there and then the clew to inductive currents and the energy necessary for their maintenance. Again they were at hand when Ampère and Colladon went over the same experiments by substituting helices conducting a current for the bars, and when Fresnel, in an experiment that remained unpublished for a long while, demonstrated that by increasing the weight of the magnetic bar with a copper bar, the oscillations were modified with greater rapidity than the increased mass of the whole would lead to suppose.

Finally, I have it as a tradition that once Pouillet, showing in a lecture the properties of an unusually powerful electro-magnet, was so rash as to break with both his hands the exciting current so as to show that the magnetic force had instantly, almost wholly, disappeared. He received a shock which came near striking him down. We now know that the extra-current of rupture had run through his body.

The experiments made before the days of Faraday show how obscure is the path that leads to the unknown and how hard it is to put to a practical use the precepts of philosophers, although their principle may be excellent. The induction currents had been sought after without being found; they were found without being seen. The best minds had a preconceived notion of them which no doubt would have soon taken the shape of demonstrated facts, but so many failures only enhance the fame of the true originator of modern electricity. We can thus realize how bitter were the feelings of Ampère, who had had this signal discovery within his grasp; and after all he left in the history of sciences a good enough record to preclude envy of his successors.

As to Faraday, he lived in a world of notions that were peculiarly his own. He had but little regard for old paths and followed the lead of his genius. He was a skillful experimenter and knew how to interpret phenomena in accordance with what seemed to him to most closely conform to nature, heedless of accepted theories and current ideas. To indiscreet questions on the subject of his present experiments he would answer with the most sincere modesty: "Do not ask me; I am seeking for absurdities."

It has subsequently been found that the induction currents are a necessary consequence of the general laws and that they might have been foreseen; foresight is easy as an afterthought.

It would be superfluous to dwell on the universal applicability of the inductive currents. They are found in telegraphs, in our house bells, in that recent wonder the telephone; they are the key to the present condition of industrial electricity; they are displayed in the indirect effects of lightning, in those produced upon telegraphic circuits by the variations of terrestrial magnetism, in the grand apparitions of the polar auroras; they even seem to respond on our globe to the physical disturbances which incessantly affect the solar mass, and thus enable us to perceive through the vacuum of space, if not the celestial harmony, at least the echo of the terrific commotions of which the center of our planetary system is the seat.

At the same time Faraday resumed the study of electrical influence, a question that was thought to have been solved long ago, and presented a new interpretation. The conception of the force lines, which was the fruit of that study, has made it possible to put into physical shape, so to speak, the most abstract results of analysis. Faraday gave prominence to this fruitful conception by a succession of skillfully conducted experiments and intuitive deductions. It could properly be

said of him that, without figuring out any computation and without writing down an equation, he had proved himself a great geometrician.

Faraday's mind carried him further. He imagined that the very notion of action from a distance could not stand, and that in every instance the intervening medium plays the leading part. To electrify a body, to produce a magnet, is but to modify the conditions of the medium by which they are surrounded, and the forces that may be brought out in the field of action are but a manifestation of the elastic properties of the intervening medium.

The condition of the fluid theory, then, appears considerably damaged; it was even worse when Faraday discovered after numerous attempts—the secret of which he kept—that a ray of light is altered in passing through a magnetic field produced by magnets or currents; so that there is a connection among them all—electricity, magnetism, light, and consequently heat. We have no longer before us isolated personages acting independently of one another, but the several actors in the great drama of nature which each one renders under a particular form; whose passions come in conflict and undergo transformations as the plot progresses; the spectator, human intellect, at first listened to the several parts in turn; he is aware to-day of a common action and of a general bond which will probably remain the great mystery.

Universal gravitation itself, which was held to be the type of action from a distance, must be subject to the common rule and find its true explanation in the structure of the medium which fills the celestial space.

One of our best-beloved masters, before whom the example of the sun, which attracts the earth, was given as an objection to these ideas, said: "Have you seen his hands? If the sun attracts the earth, he must have hands and a string."

The adoption of a system of interdependent measures for electric and magnetic phenomena which worked invaluable good in industrial applications had previously been the starting point of immense progress in the province of pure science. It has been ascertained that if the same quantity of electricity is measured by Coulomb's law on reciprocal actions or by the magnetic properties of currents the ratio of the two values is a physical velocity, and it was found by experiment to be virtually at the same rate as the velocity of the propagation of light. Such a coincidence could not be the effect of mere accident; it bespoke a close connection between electricity and light.

Clerk Maxwell, who had made a profound study of Faraday's works on the action of the mediums, thought that they were the actual seat of electrical phenomena. In a learned mathematical analysis he proved that luminous undulations may be explained by means of currents whose frequent alternations excite other currents in the adjacent parts and propagate from place to place, in which case the velocity of propagation would be nothing else than the celebrated ratio of units of measure-

ment. Light, then, would be a combination of electric currents, characterized by the prodigious frequency of alternations, a billion during a millionth of a second. Ampère could not foresee that the speculations of his imagination would so soon be put in so precise a form.

Maxwell's theory, however, was not accepted without many reservations; it still lacked the confirmation of experiment, for the properties of the dielectrics obey but in an imperfect manner the laws as indicated. Hertz's experiments afforded a memorable confirmation. Thanks to the discoveries of the inventor and the investigations of the physicists who followed in his footsteps, the demonstration is now made that the electric oscillations travel with the same velocity as light, that they produce the same phenomena of interference, that they are subject to the same laws of reflection and refraction; they could be perceived by the eye if it were possible to give them the same frequency. That extreme limit is still far from being reached, since the shortest electric undulations that have been observed are not less than several centimeters, that is, one hundred thousand times longer than those of light.

So that all the phenomena which were at first ascribed to various independent causes must now be explained by means of the mechanical properties of a single medium which exists in the vacuum of space, and is more or less modified by ponderable bodies. We have here a philosophical conception which is not lacking in grandeur, but which makes the task of the mathematicians a peculiarly hard one, and, maybe, extends beyond the range of the human mind. As long as it was only a question of imagining the structure of the medium capable of transmitting light the problem was comparatively easy, and yet it has exercised the sagacity of the most eminent men without our being yet able to affirm that it has been solved. What is it now, when we must turn for everything to a veritable Proteus? Our successors will not be idle.

While the alternate currents have taken such a prominent part in the development of theoretical notions, their importance in practice has been just as great. All the methods of producing inductive currents without interruption naturally supply them in the alternating form, because the organs that are brought into operation must revert to the same conditions, and that the two halves of each period produce effects in opposite directions. This alternation of the currents makes them for the most part unfit for use.

At the beginning an effort was made to utilize them by means of correctors, whose object was to drive them upon a neighboring circuit in a constant direction, like a torrent consisting of successive waves. These commutators, however, were so inconvenient that investigations continued for forty years after Faraday's discovery without reaching any practical solution.

M. Pacinotti had solved the problem in 1864 without imagining that his laboratory apparatus could be applied to industrial purposes. A

hand-rail maker, M. Gramme, who was working as a joiner in electric works, made himself acquainted, by uncommon perseverance, with the machines that came under his observation. In 1869 he devised the admirable contrivance which justly bears the name of gramme ring, and accomplished actual industrial machines.

The gramme ring is in the nature of an artifice which makes it possible to extract from the inductive alternating effects a manner of rippling stream. Save a few direct applications of the alternating currents, as to light-houses, for instance, this may be said to have been the origin of industrial electricity. A few years later, 200-horsepower dynamos were built. There was a 2,000-horsepower dynamo on exhibition at Chicago. The power of these machines is boundless. Electricity receives the energy of steam engines or waterfalls, transforms it, utilizes it, distributes it, transmits it to long distances, again receives it, and returns it in the most varied forms.

A new revolution is at hand. By a strange vicissitude of human affairs we are now retracing our steps. Those alternating currents that seemed so fractions are now tractable. Of easier production, since they require no correcting device, they are transformed by raising their level, so that they may cover long distances at small cost, then by bringing the sluices down for direct application.

These are strange rivers, with no tangible flow, whose waters move only by oscillation, whose alternating flow and height of fall may be modified at will, and that are capable of supplying at all times the same amount of effective power, leaving out leakage on the way and invisible friction.

It was not easy to imagine that a sort of tide, the ebb and flow of which follow each other in less than a twenty-fifth of a second of time, could be made available to operate hydraulic wheels and turbines. We now know how to do this.

If the receiver moves in the same period as the alternating current, the effects of the impulsion produced by the successive shocks are cumulative; the apparatus is a synchronous motor.

If the conductive wires bring several alternating currents, these are regulated so as to operate at stated intervals during a period, in the same manner as the two rods of a locomotive; these are the revolving motors.

Other contrivances occur to our mind, but to dwell upon them would take up too much time.

The Niagara Falls will, in the near future, furnish a striking illustration of the application of electricity; 5,000-horsepower turbines, the most powerful ever built, will produce formidable alternating currents which will be easily regulated, transformed, transmitted, and availed of for all purposes.

At this day electricity transmits instantaneously the human thought through oceans and over continents; it enables us to hear the voice

and sentiments of our loved ones, though we may be separated by hundreds of miles; it finds its use in the details of our household life; it wins favor for a method of lighting with which oxygen is no longer consumed, and our dwellings are free from offensive smell; it has made such inroads into industrial works that it is looked upon as a necessity wherever the wise step was taken of calling upon its aid. At the same time it has thrown the notions of natural philosophy into confusion and put to a severe ordeal the conceptions of the human mind.

All of this progress is of yesterday's date, and no one can tell what the future has in store; but whatever wonders may be witnessed by our successors, it could properly be said that the nineteenth century, now drawing to its close, will, with good reason, be called the age of electricity.

TERRESTRIAL MAGNETISM.¹

By Prof. A. W. RÜCKER, M. A., F. R. S.

It is impossible for a body of English scientific men to meet in one of our ancient university towns without contrasting the old ideal of the pursuit of learning for its own sake with the modern conception of the organization of science as part of a pushing business concern.

We are, as a nation, convinced that education is essential to national success. Our modern universities are within earshot of the whirr of the cotton mill or the roar of Piccadilly. Oxford and Cambridge themselves are not content to be centers of attraction to which scholars gravitate. They have devised schemes by which their influence is directly exerted on every market town and almost on every village in the country. University extension is but a part of the extraordinary multiplication of the machinery of education which is going on all around us. The British Association, which was once regarded as bringing light into dark places, is now welcomed in every large provincial town by a group of well-known men of science; and we find ready for the meetings of our sections, not only the chapels and concert rooms which have so often and so kindly been placed at our disposal, but all the appliances of well-designed lecture rooms and laboratories.

I do not propose, however, to detain you this morning with a discourse on the spread of scientific education, but you will forgive me if I illustrate its progress by two facts, not perhaps the most striking which could be selected, but especially appropriate to our place of meeting. It is little more than thirty years since the two branches of science with which our section deals, mathematics and physics, have been generally recognized as wide enough to require more than one teacher to cope with them in an educational institution of high pretensions and achievement. In 1860 the authorities of the Owens College, Manchester, debated whether it was desirable to create a professorship of natural philosophy in addition to, and independent of, the chair of

¹Address as president of section of mathematics and physics at meeting of British Association for the Advancement of Science, Oxford meeting, 1894. Printed by the Association; also in *Nature*, No. 1293, Vol. L.

mathematics. It was thought necessary to obtain external support for the opinions of those who advocated this step. An appeal was made to Professors De Morgan and Stokes. The former reported that a "course of experimental physics is in itself desirable;" the latter, that "there would be work enough in a large institution for a mathematician and a physicist."

In the end the chair of natural philosophy was established, and the fact that our host of to-day, Professor Clifton, was its first occupant reminds us how little we have advanced in time and how far in educational development from the days when propositions such as those I have cited were only accepted on the authority of the names of Stokes and De Morgan.

The other fact to which I would refer is that the Clarendon Laboratory, in which the meetings of Section A are to be held, though erected barely a quarter of a century ago, was the first laboratory in this country which was specially built and designed for the study of experimental physics. It has served as a type. Clerk Maxwell visited it while planning the Cavendish Laboratory, and traces of Professor Clifton's designs can be detected in several of our university colleges.

But though our surroundings remind us of the improvement which has been effected in the equipment of our science, it would not be difficult to indicate weak points which should forthwith be strengthened. On these, in so far as they affect education, I will not dwell—and that for two reasons. In the first place, we meet to-day not as teachers, but as students; and, secondly, I think that whereas we have as a nation awoken—though late in the day—to the importance of education, we are not yet fully awake to the importance of learning. Our attitude in such matters was exactly expressed by one of the most eminent of the witnesses who gave evidence before the "Gresham Commission." In his opinion the advancement of knowledge must in a university in London be secondary to the higher instruction of the youth of London. If this be so—and I will not now dispute it—we shall surely all agree that somewhere or other, in London or out of it, included in our universities or separate from them, there ought to be institutions in which the advancement of knowledge is regarded as of primary and fundamental interest, and not as a mere secondary by-product thrown off in the course of more important operations.

It is not essential that in such an institution research should be the only task. Investigation may be combined with the routine work of an observatory, with teaching, with the care of standards, or with other similar duties. It is however essential that, if the advancement of knowledge is seriously regarded as an end worth attaining, it should not be relegated to a secondary place.

Time and opportunity must be found for investigation, as time and opportunity are found for other tasks. It is not enough to refer to research in a prospectus and then to leave it to be accomplished at odd

times and in spare moments not claimed by more urgent demands. Those to whom the future of the higher learning in England is dear must plan and scheme to promote the life-long studies of men, as in the last quarter of a century they have struggled, with marked success, to promote the preparatory studies of boys and girls. That the assignment of a secondary position to research is the more popular view, and that the necessity for encouraging it has as yet hardly been grasped by many of those who control our modern educational movements is, I fear, too true. It is therefore a matter for congratulation that within the last year Oxford has established a research degree, and has thus taken an important step toward gathering within her fold workers of mature years who are able and willing, not merely to gain knowledge, but to add to it.

We may also note, with pleasure and gratitude, that the stream of private munificence has recently been in part directed to the advancement of learning. Sir Henry Thompson has generously offered a sum of £5,000 to provide a large photographic telescope for the National Observatory at Greenwich. The new instrument is to be of 26 inches aperture and 22 feet 6 inches focal length, or exactly double the linear dimensions of that which has been previously employed. Mr. Ludwig Mond, too, has added to his noble gifts to science by the new research laboratories which he is about to establish in connection with the Royal Institution. Albemarle street is thronged with memories of great discoveries. The researches of Lord Rayleigh and the remarkable results of Professor Dewar's studies of matter at low temperatures are maintaining the great reputation which the Royal Institution has gained in the past, and all English physicists will rejoice that prospects of new and extended usefulness are opening before it.

Another hopeful though very embarrassing fact is that the growth in the number of scientific workers makes it increasingly difficult to find the funds which are necessary for the publication of their work. Up to the present the author of a paper has had to submit it to criticism, but when it has been approved by competent judges it has been published without ado and without expense to himself. This is as it should be. It is right that due care should be exercised to prune away all unnecessary matter, to reduce as far as may be the necessary cost. It will, however, be a great misfortune if judgment as to what curtailment is necessary is in future passed, not with the object of removing what is really superfluous but in obedience to the iron rule of poverty. Apart from all other disadvantages, such a course would add to the barriers which are dividing the students of different sciences. A few lines and a rough diagram may suffice to show to experts what has been attempted and what achieved; but there is no paper so difficult to master as that which assumes that the reader starts from the point of vantage which months or years of study have enabled the author to attain. Undue pruning will not make the tree of knowledge more fruitful, and will certainly make it harder to climb.

Connected also with the vast increase of scientific literature is a growing necessity for the publication of volumes of abstracts, in which the main results of recent investigations are presented in a concentrated form. English chemists have long been supplied with these by the Chemical Society. The Physical Society, though far less wealthy than its elder sister, has determined to undertake a similar task. We are compelled to begin cautiously, but in January next the first number of a monthly pamphlet will be issued containing abstracts of all the papers which appear in the principal foreign journals of physics. In this venture the society will incur grave responsibilities, and I avail myself of this opportunity to appeal to all British physicists to support us in a work the scope of which will be rapidly extended if our first efforts succeed.

From this brief glance at what has been or is about to be done to promote the study of physics I must now turn to the discussion of narrower but more definite problems, and I presume that I shall be most likely to deserve your attention if I select a subject in which I am myself especially interested.

During the last ten years my friend Dr. Thorp and I have been engaged upon a minute magnetic survey of the United Kingdom. The main conclusions at which we have arrived are about to be published, and I do not propose to recount them now. It is, however, impossible to give so long a time to a single research without having one's attention drawn to a number of points which require further investigation, and I shall perhaps be making the best use of this opportunity if I bring to your notice some matters in the practical and theoretical study of terrestrial magnetism which deserve a fuller consideration than has yet been given to them.

In the first place, then, there is little doubt that the instruments at present used for measuring declination and horizontal force are affected with errors far greater than the error of observation.

We employed four magnetometers by Elliott Brothers, which were frequently compared with the standard instrument at Kew. These measurements proved that the instrumental differences which affect the accuracy of the declination and horizontal force measurements are from five to ten times as great as the error of a single field observation. The dip circle which two generations ago was so untrustworthy, is, in our experience, the most satisfactory of the absolute instruments.

In most cases these comparisons extended over several days, but the astronomer royal has described in his recent report observations made at Greenwich for two years and a half with two horizontal force instruments. These differ between themselves, and the discrepancy is of the same order of magnitude as those we have detected.

If such differences exist between instruments of the Kew pattern, it is probable that they will be still greater when the magnetometers under investigation are of different types.

This point has been investigated by Dr. Van Rijkevorsel, who five years ago visited Kew, Parc St. Maur, Wilhelmshaven, and Utrecht, and, using his own instruments at each place, compared the values of the magnetic elements determined by himself with those deduced from the self-registering apparatus of the observatory.

The discrepancies between the so-called standards which were thus brought to light were quite startling and prove the necessity for an investigation as to their causes.

Magneticians had long been aware that the instruments used by travelers should be compared at the beginning and end of a journey with those at some fixed observatory to make sure that the comparatively rough usage to which they are subjected has not affected their indications. But Dr. Van Rijkevorsel's expedition first drew general attention to the fact that there are serious differences between the standard observatory instruments themselves.

The importance of a careful comparison between them was at once recognized. The magnetic subcommittee of the International Meteorological Conference held at Munich in the autumn of 1891 resolved that it is "necessary that the instruments employed for absolute measurements at the different observatories should be compared with each other and the results published." As far as I am aware nothing has been done to give effect to this resolution, but the necessity for such an international comparison is urgent. The last few years have been a period of unexampled activity in the conduct of local magnetic surveys. To cite instances from the northwest of Europe only, observations have recently been made on a more or less extended scale in the United Kingdom, France, Holland, North Germany, and Denmark.

It will be absurd if these surveys can not be collated and welded into a homogeneous whole, because we are in doubt whether the indications of our standard instruments for the measurement of declination and dip differ by five or six minutes of arc.

If, however, an official international comparison of the magnetic standards in use in different countries is instituted it is probable that only one observatory in each country will take part in it.

It may fairly be left to each nation to determine for itself the relations between the results of measurements made in its own institutions. Apart, therefore, from all other reasons, we in England would only be able to make the best use of an international comparison if we had beforehand set our own house in order and were able at once to extend the results of experiments made at Kew or Greenwich to Stonyhurst, Valentia, and Falmouth.

This we are not at the present moment in a position to do. As far as I know nobody has ever carried a magnetometer backward and forward between Kew and Greenwich to test the concordance of the published results. During the recent survey single or double sets of observations have been made at Stonyhurst, Falmouth, and Valentia,

with instruments which have been compared with Kew, but these measurements, though amply sufficient for the purposes of our research, were not numerous enough to serve as a firm basis for determining the discrepancies between the various standards, so that the exact relations between these important sets of apparatus are still unknown.

The first point, therefore, to which I wish to draw the attention of the section is the necessity for a full primary comparison between the standard magnetic instruments in use at our different observatories.

But if this were satisfactorily accomplished the question would arise as to whether it should be repeated at regular intervals. We have at present only a presumption in favor of the view that the standards which we know are discordant are nevertheless constant. A single instance may suffice to show how necessary it may be—at all events in the case of outlying and isolated observatories—to put this belief to the test.

In the most recent account of the work of the observatory of the Bombay government at Colába, the dips are discussed for the period of twenty years between 1872 and 1892. During this interval the adjustment of the agate plates upon which the dip needle rolls has thrice been modified. In 1877 the plates were renewed. In 1881 and 1887 the dip circle was taken to pieces and rebuilt. In the intervals the dip as determined by several needles, but always with this circle, remained approximately constant, but after each overhauling it suddenly altered, increasing by 12 minutes on the first occasion, by 23 minutes on the second, and by 20 minutes on the third. Mr. Chambers states that he “can give no satisfactory account of this behavior of the instrument,” but suggests that “the needle gradually hollows out a depression in the agate plates on which it rolls, and that this characteristic of the dip circle” has not before been discovered owing to the reluctance of magnetic observers to interfere with the adjustment of instruments which are apparently working well.

I do not think that this explanation will suffice. Dr. Thorpe and I employed a new dip circle in the earliest part of our survey work, which has remained in accord with Kew for ten years. During that time the dip has been measured some seven hundred times with it. This corresponds, I believe, to more than the amount of work done with the circle at Colába in six years, which in turn is longer than some of the intervals in which the Colába instruments gave results erroneous to the extent of 20 minutes. I feel, therefore, quite sure that the difficulties which have been experienced at Bombay are not due to any “characteristic defect of the dip circle.” But whatever the cause may have been, surely the lesson is that, if such things can happen in so well-known an institution, it is desirable that we should take the moderate pains required to assure ourselves whether smaller—but, possibly, not unimportant—errors are gradually affecting the results at any of our observatories.

This brings me to my next point, namely, that if we are to draw conclusions from the minor differences between measurements of secular or diurnal change made in the observatories, it is not only necessary that we should know whether the instruments are strictly comparable and constant, but the observations must be reduced by precisely the same methods.

In 1886 the late Mr. Whipple drew the attention of the British Association to the fact that there was a systematic difference between the diurnal ranges of declination at Greenwich and Kew. His results were based on the three years 1870–1872. In 1890 two of my students, Messrs. Robson and S. W. J. Smith, extended the comparison to three more recent years (1883, 1886, 1887), and obtained results in complete accord with those of Mr. Whipple.

It is well known that the average daily oscillation of the magnet is affected by the magnetic weather. Sabine showed that magnetic storms do not merely buffet the needle now in this direction and now in that—they affect its average behavior, so that the mean swing east and west is different according as we deduce it only from days of magnetic calm or include those of storm.

Mr. Whipple reduced the Kew observations by two methods,¹ one of which depended on the calmest days only, while the other included those which were moderately disturbed. Neither agreed exactly with the method in use at Greenwich, but the difference between the results deduced from them was so small when compared with the difference between either and that obtained at Greenwich, that it seemed possible that the diurnal variations, even at these closely neighboring places, might differ appreciably. The question whether this is so has now been answered. In 1890, at the request of the Kew committee, the astronomer royal undertook to select early in each year five quiet days in each of the preceding twelve months. It was also agreed that, whether they adopted other methods or not, the chief English magnetic observatories should determine the diurnal variations from these days alone. The Greenwich² and Kew observations for 1890 have therefore been worked up in exactly the same way, with the result that the discrepancy, which had persisted for twenty years, has entirely disappeared, and that the two diurnal ranges at the two observatories are in as close accord as could be expected.

If, therefore, we may judge from a single year, the cause of the difference lay in the choice of days. Greenwich will in future give us two diurnal variations, one obtained from the most quiet days only, the other from all days except those of violent storm, and in these we shall have most valuable data for studying the mean effect of disturbances on the diurnal variation.

To this satisfactory conclusion I have only one suggestion to add. The astronomer royal and M. Mascart now publish for the same stormy

¹ Sabine's and Wild's.

² The Greenwich observations for subsequent years have not yet been published.

days the photographic traces by which the history of a magnetic storm is mapped. Is it possible for Greenwich and Paris also to agree in their choice of calm days for the calculation of the diurnal variation so that a precise similarity of method may obtain not only between the English observatories but between England and France?

The importance of cooperation between institutions engaged on the same tasks having been illustrated, I am glad to be able to announce that another step is about to be taken in the same direction. For some years, in spite, I believe, of great financial difficulties, the Cornwall Royal Polytechnic Society has maintained a magnetic observatory at Falmouth. The results of the observations have hitherto been printed in the journal of the society only, but the Royal Society has now consented to publish them in the Proceedings. Before long, therefore, the Kew and Falmouth records, which are already worked up in the same way, will be given to the world side by side. Is it too much to hope that this may be the first step toward the production of a British Magnetic Year Book, in which observations whose chief interest lies in their comparison may be so published as to be easily compared?

We owe to private enterprise another advance of the same kind. The managers of the new journal *Science Progress* have made arrangements with the Kew committee for the yearly publication of a table showing the mean annual values of the magnetic elements as determined at the various magnetic observatories of the world. It will therefore in future be possible to get a general idea of the rate of secular change in different localities without searching through a number of reports in different languages, which can only be consulted in the rooms of the few societies or institutions to which they are annually sent. The present state of our knowledge of the secular change in the magnetic elements affords, indeed, very strong support to the arguments I have already adduced in favor of a comparison between the instruments of our magnetic observatories.

The whole question of the cause of this phenomenon has entered on a new stage. It has long been recognized that the earth is not a simple magnet, but that there are in each hemisphere one pole or point at which the dip needle is vertical and two foci of maximum intensity. A comparison of earlier with later magnetic observations led to the conclusion that one or both of the foci in each hemisphere is in motion, and that to this motion, however caused, the secular change in the values of the magnetic element is due. Thus the late Prof. Balfour Stewart, writing in 1883, says: "While there is no well-established evidence to show that either the pole of verticity or the center of force to the north of America has perceptibly changed its place, there is on the other hand very strong evidence to show that we have a change of place on the part of the Siberian focus."¹ The facts in favor of this conclusion are there discussed. The arguments are based, not on the results of any actual

¹ *Encyclopedia Brit.*, 9th ed., art. "Meteorology—Terrestrial magnetism."

observations near to the focus in question, but on the behavior of the magnet at points far distant from it in Europe and Asia. The westerly march of the declination needle, which lasted in England up to 1818, and the easterly movement which has since replaced it, are connected with a supposed easterly motion of the Siberian focus, which, it is added, "there is some reason to believe - - - has recently been reversed." In opposition, therefore, to the idea of the rotation of a magnetic focus round the geographical poles which the earlier magneticians adopted, Stewart seems to have regarded the motion of the Siberian focus as oscillatory.

A very different aspect is put upon the matter by a comparison of the magnetic maps of the world prepared by Sabine and Creak for the epochs 1840 and 1880, respectively. Captain Creak, having undertaken to report on the magnetic observations made during the voyage of the *Challenger*, supplemented them with the unrivaled wealth of recorded facts at the disposal of the hydrographic department of the Admiralty. He was thus able, by a comparison with Sabine's map, to trace the general course of the secular changes all over the world for forty years. The negative results may be shortly stated. There is no evidence of any motion either of magnetic pole or focus. The positive conclusions are still more curious. There are certain lines on the surface of the earth toward which in the interval under consideration the north pole of the needle was attracted. From each side the compass veered or backed toward them. Above them the north pole of dip needle moved steadily down.

There are other lines from which, as tested by compass and dip circle, a north pole was in like manner repelled. The two principal points of increasing attraction are in China and near Cape Horn; the chief points of growing repulsion are in the north of Canada and the Gulf of Guinea.

I am sure that my friend Captain Creak would be the first to urge that we should not generalize too hastily from this mode of presenting the facts, but there can be no doubt that they can not be explained, by any simple theory of a rotating or oscillating pair of poles. Prima facie they suggest that the secular change is due not so much to changes at the principal magnetic points as to the waxing and waning of the forces apparently exerted by secondary lines or points of attraction or repulsion.

All down the west coast of America, close, be it noted, to one of the great lines of volcanic activity, north hemisphere magnetism has since 1840 been growing in relative importance. Near Cape Horn a weak embryonic pole is developing of the same kind as the well-known pole at the other end of the continent near Hudson Bay. Along a line which joins Newfoundland to the Cape of Good Hope precisely the reverse effects have been experienced; while in the Gulf of Guinea a south hemisphere pole is growing within the Tropics. Of course I do not

suggest that these secondary systems can ever determine the principal phenomena of terrestrial magnetism, or reverse the magnetic states of the hemispheres in which they occur. These are no doubt fixed by the rotation of the earth. I do, however, wish to emphasize the fact that they show that either secular change is due to the conjoint action of local causes, or that if some single agent such as a current system within the earth, or a change of magnetic conditions outside it, be the primary cause, the effects of this cause are modified and complicated by local peculiarities.

Mr. Henry Wilde has succeeded in representing with approximate accuracy the secular change at many points on the surface of the earth by placing two systems of currents within a globe, and imparting to the axis of one of them a motion of rotation about the polar axis of the earth. But he has had to supplement this comparatively simple arrangement by local features. He has coated the seas with thin sheet iron. The ratio between the two currents which serves to depict the secular change near the meridian of Greenwich fails in the West Indies. Thus this ingenious attempt to imitate the secular change by a simple rotation of the magnetic pole supports the view that local peculiarities play a powerful part in modifying the action of a simple first cause, if such exist. I need hardly say that I think the proper attitude of mind on this difficult subject is that of suspended judgment, but there is no doubt that recent investigation has, at all events, definitely raised the question how far secular change is either due to, or modified by, special magnetic features of different parts of the earth.

It is possible that light may be thrown upon this point by observations on a smaller scale. Assuming for the moment that the difference in the secular changes on opposite sides of the Atlantic is due to a difference of local causes, it is conceivable that similar causes, though less powerful and acting through smaller ranges, might produce similar though less obvious differences between places only a few miles apart. For testing this Greenwich and Kew are in many respects most favorably situated. Nowhere else are two first-class observatories so near together. Differences in the methods of publishing the results have made it somewhat difficult to compare them, but the late Mr. Whipple furnished me with figures for several years, which made comparison easy. Without entering into details it may be sufficient to say that the declination needles at the two places do not from year to year run parallel courses. Between 1880 and 1882 Kew outstripped its rival; between 1885 and 1889 it lost, so that the gain was rather more than compensated. The difference of the declination of the two places appears to increase and diminish through a range of 5 minutes of arc.

This evidence can be supplemented by other equally significant examples. No fact connected with terrestrial magnetism is more certain than that at present the rate of secular change of declination in this part of Europe increases as we go north. This is shown by a com-

parison of our survey with those of our predecessors fifty and thirty years ago, by M. Moureaux's results in France, and by Captain Creak's collation of previous observations. Yet, in spite of this, Stonyhurst, which is some 200 miles north of Greenwich and Kew, and should therefore outrun them, sometimes lags behind and then makes up for lost time by prodigious bounds. Between 1882 and 1886 the total secular change of declination at Stonyhurst was about 3.5 minutes less than that at Greenwich and Kew, whereas in the two years, 1890-92, it reached at Stonyhurst the enormous amount of 28 minutes, just doubling the corresponding alteration registered in the same time at Kew. If these fluctuations are caused by the instruments or methods of reduction, my argument in favor of frequent comparisons and uniform treatment would be much strengthened, but, apart from the inherent improbability of such large differences being due to the methods of observation, the probability of their physical reality is increased by the work of the magnetic survey.

The large number of observations at our disposal has enabled us to calculate the secular change in a new way, by taking the means of observations made about five years apart at numerous though not identical stations scattered over districts about 150 miles square. The result thus obtained should be free from mere local variations, but as calculated for the southeast of England for the five years 1886-91, it differs by nearly 5 minutes from the change actually observed at Kew.

We have also determined the secular change at twenty-five stations by double sets of observations made as nearly as possible on the same spot at intervals of several years. The results must be interpreted with caution. In districts such as Scotland, where strong local disturbances are frequent, a change of a few yards in the position of the observer might introduce errors far larger than the fluctuations of secular change. But when all such changes are eliminated, when all allowance is made for the possible inaccuracy of field observations, there are outstanding variations which can hardly be due to anything but a real difference in the rate of change of the magnetic elements.

A single example will suffice. St. Leonards and Tunbridge Wells are about 30 miles apart. Both are situated on the Hastings Sand formation, and on good nonmagnetic observing ground. At them, as at the stations immediately around them—Lewes, Eastbourne, Appledore, Etchingham, Heathfield, and Maidstone—the local disturbing forces are very small. All these places lie within a district about 40 miles square, at no point of which has the magnet been found to deviate by 5 minutes from the true magnetic meridian. No region could be more favorably situated for the determination of the secular change, yet according to our observations the alteration in the declination at St. Leonards in six years was practically equal to that at Tunbridge Wells in five. It is difficult to assign so great a variation to an accumulation of errors, and this is only one among several instances of the same kind which might be quoted.

We find, then, when we consider the earth as a whole, grave reason to question the old idea of a secular change caused by a magnetic pole or focus pursuing an orderly orbit around the geographical axis of the earth, or oscillating in some regular period in its neighborhood. It would of course be absurd to admit the possibility of change in the Tropics and to deny that possibility in the Arctic circle, but the new facts lead us to look upon the earth not as magnetically inert, but as itself—at the equator as well as at the pole—producing or profoundly modifying the influences which give rise to secular change. And then, when we push our inquiry further, accumulating experience tells the same tale. The earth seems, as it were, alive with magnetic forces, be they due to electric currents or to variations in the state of magnetized matter. We need not now consider the sudden jerks which disturb the diurnal sweep of the magnet, which are simultaneous at places far apart, and probably originate in causes outside our globe. But the slower secular change, of which the small part that has been observed has taken centuries to accomplish, is apparently also interfered with by some slower agency the action of which is confined within narrow limits of space. Between Kew, Greenwich, and Stonyhurst, between St. Leonards and Tunbridge Wells, and I may add, between Mablethorpe and Lincoln, Enniskillen and Sligo, Charleville and Bantry, the measured differences of secular variation are so large as to suggest that we are dealing not with an unruffled tide of change, which, unaltered by its passage over continent or ocean, sweeps slowly round the earth, but with a current fed by local springs or impeded by local obstacles, furrowed on the surface by billows and eddies, from which the magnetician, if he will but study them, may learn much as to the position and meaning of the deeps and the shallows below. But if this is the view which the facts I have quoted suggest, much remains to be done before it can be finally accepted; and in the first place—to come back to the point from which I started—we want, for some years at all events, a systematic and repeated comparison of the standard instruments in use at the different observatories. That they are not in accord is certain; whether the relations between them are constant or variable is doubtful. If constant, the suggestions I have outlined are probably correct; if variable, then the whole or part of the apparent fluctuations of secular change may be nothing more than the irregular shiftings of inconstant standards.

I can not myself believe that this is the true explanation, but in any case it is important that the doubt should be set at rest, and that if the apparent fluctuations of secular change are not merely instrumental, the inquiry as to their cause should be undertaken in good earnest.

The question is interesting from another point of view. It is now fully established that even where the surface soil is nonmagnetic, and even where geologists have every reason to believe that it lies upon

nonmagnetic strata of great thickness, there are clearly defined lines and centers toward which the north-seeking pole of a magnet is attracted, or from which it is repelled. To the magnetic surveyor fluctuations in secular change would appear as variations in the positions of these lines, or as changes in the forces in play in their neighborhood.

Greenwich and Kew are both under the influence of a widespread local disturbance which culminates near Reading. At both places the needle is deviated to the west of the normal magnetic meridian, and if the westerly declination diminishes sometimes faster and sometimes more slowly at one observatory than at the other, this must be, or, at all events, would in the first instance appear to be, due to local changes in the regional disturbing forces. The questions of the nature of the irregularities of secular change and of the causes of local disturbances are therefore intermingled, and information gained on these points may in turn be useful in solving the more difficult problem of world-wide secular variations.

Two causes of regional and local disturbances have been suggested, viz, earth currents and the presence of visible or concealed magnetic rocks. The two theories are not mutually exclusive. Both causes of the observed effects may, and probably do, coexist. I have, however, elsewhere explained my reasons for believing that the presence of magnetic matter, magnetized by induction in the earth's field, is the principal cause of the existence of the magnetic ridge-lines and foci of attraction which for so many years we have been carefully tracing. I will only now mention what appears to me to be the final and conclusive argument, which, since it was first enunciated, has been strengthened by the results of our more recent work. We find that every great mass of basic rock, by which the needle is affected at considerable distances, attracts the north-seeking pole. Captain Creak some years ago showed that the same statement is true of those islands in the Northern Hemisphere which disturb the lines of equal declination, while islands in the Southern Hemisphere repel the north pole and attract the south. In other words, these disturbances are immediately explained if we suppose that they are due to magnetic matter magnetized by induction. The theory of earth currents would, on the other hand, require that round the masses of visible basalt, and round the island investigated by Captain Creak, currents, or eddies in currents, should circulate in directions which are always the same in the same hemisphere, and always opposed on opposite sides of the equator. For this supposition no satisfactory explanation is forthcoming, and, therefore, with all reserve and a full consciousness that in such matters hypothesis differs but little from speculation, it appears to me that the theory that induced magnetism is the main cause of the disturbance has the greater weight of evidence in its favor.

If this be granted, it is evident that the positions of the main lines and centers of attraction would be approximately constant, and, so far

as it is possible to form an opinion, these conditions seem to be satisfied. There has certainly been no noticeable change in the chief loci of attraction in the five years which have elapsed between the epochs of our two surveys. Mr. Welsh's observations made in Scotland in 1857-58 fit in well with our own. Such evidence is not, however, inconsistent with minor changes, and it is certain that as the directions and magnitude of the inducing forces alter, the disturbing induced forces must alter also. But this change would be slow, and as the horizontal force is in these latitudes comparatively weak, the change in the disturbing forces would also be small, unless the vertical force altered greatly. It is at all events impossible to attribute to this cause oscillations which occupy at most eight or ten years. It is possible to suggest other changes in the state of the concealed magnetic matter, alterations of pressure, temperature, and the like, to which the oscillations of secular change might be due, but probably there will be a general consensus of opinion that if the slowly changing terms in the disturbance function are due to magnetic matter, the more rapid fluctuations of a few years' period are more likely to be connected with earth currents. It becomes therefore a matter of interest to disentangle the two constituents of local disturbances; and there is one question to which I think an answer might be obtained without a greater expenditure than the importance of the investigation warrants. Are the local variations in secular change waves which move from place to place, or are they stationary fluctuations, each of which is confined to a limited area beyond which it never travels? Thus if the annual decrease in the declination is at one time more rapid at Greenwich than at Kew, and five years afterwards more rapid at Kew than at Greenwich, has the maximum of rapidity passed in the interval through all intervening places, or has there been a dividing line of no change which has separated two districts which have perhaps been the scenes of independent variations? The answer to this question is, I take it, outside the range of our knowledge now, but if the declination could be determined several times annually at each of a limited number of stations in the neighborhood of London, to this inquiry, at all events, a definite answer would soon be furnished.

There are two other lines of investigation which I hope will be taken up sooner or later, for one of which it is doubtful whether the United Kingdom is the best site, while the other is of uncertain issue.

If, however, it be granted that the principal cause of local and regional magnetic disturbances is the magnetization by the earth's field of magnetic matter concealed below its surface, the question as to the nature of this material still remains to be solved. Is it virgin iron or pure magnetite, or is it merely a magnetic rock of the same nature and properties as the basalts which are found in Skye and Mull? There is of course no *a priori* reason why all these different materials should not be active, some in one place and some in another.

As regards the United Kingdom I have, both in a paper on the "Permeability of magnetic rocks" and in the description of the recent survey, made calculations which tend to prove that if we suppose that the temperature of the interior of the earth is, at a depth of 12 miles, such as to deprive matter of its magnetic properties, and if we further make the unfavorable assumption that down to that limit the susceptibility is constant, the forces which are observed on the surface are of the same order of magnitude as those which could be produced by large masses of ordinary basalt or gabbro. It would not, however, be wise to generalize this result and to assume that in all places regional disturbances are due to basic rocks alone.

We know that local effects are produced by iron ore, for the Swedish miners seek for iron with the aid of the magnet, and in some other cases magnetic disturbances of considerable range are so intense as to suggest that material of very high magnetic permeability must be present.

If the concealed magnetic matter were iron, and if it were present in large quantity, it is evident that the results of experiments with the magnetometer and dip circle might be supplemented by observations made with the plumb line or pendulum. In such a case the region of magnetic disturbance would also be a region of abnormal gravitational attraction. An account of a suggested connection between anomalies of these two kinds occurring in the same district has lately been published by Dr. Fritsche.¹

Observations made about thirty years ago by a former director of the Astronomical Observatory in Moscow led to the conclusion that throughout two large districts to the north and south of that city the plumb line is deviated in opposite directions. The deflections from the vertical are very considerable, and indicate a relative defect in the attraction exerted by the rocks in the neighborhood of Moscow itself, and the suggestion has been made that there is either a huge cavity—a bubble in the earth crust—under the town, or that the matter beneath it is less dense than that which underlies the surface strata on either side at a distance of 10 or 12 miles.

As long ago as 1853 Captain Meyen made magnetic observations in order to determine whether the same district is also the seat of any magnetic irregularity. His stations were hardly sufficiently numerous to lead to decisive results, but the magnetic elements have recently been measured by Dr. Fritsche at thirty-one places within 50 miles of Moscow. The experiments were all made within eleven days, so that no correction for secular change is required. They indicate a locus of magnetic attraction running through Moscow itself. South of the town the disturbance again changes in direction so as to show either

¹ "Die magnetischen Localabweichungen bei Moskau und ihre Beziehungen zur dortigen Local-Attraction," *Bulletin de la Société Impér. des Naturalistes de Moscou*, 1894, No. 4.

that repulsive forces are in play, or that there is another magnetic ridge line still farther to the south. Dr. Fritsche thinks that these observations explain the gravitational anomalies without recourse to the somewhat forced hypothesis of a vast subterranean cave. He assumes that there is a concealed mass of iron which approaches near to the surface at Moscow and also along two loci to the south and north of the city. He attributes the magnetic irregularities to the attraction of the central iron hill, the deflections of the plumb line to the flanking masses. It is perhaps not inconceivable that such results might follow in a special case, but without the support of calculation it certainly appears that the magnetic experiments point to the existence of the principal attracting mass under the town. This is in fact the arrangement shown in the figure with which Dr. Fritsche illustrates his hypothesis. If this is so, the theory would *prima facie* seem to require that the bob of a plumb line should be attracted toward and not, as is actually the case, away from the center of the magnetic disturbance. On the whole, then, though the coexistence of large magnetic and gravitational disturbances in the same place is suggestive, I do not think that they have as yet been proved to be different effects of the same hidden mass of magnetic matter.

In a few weeks an international geodetic conference will meet at Innsbruck, at which the Royal Society will be represented. It is, I believe, intended to extend the detailed investigation of the relations between the nature of the earth's crust and the gravitational and magnetic forces to which it gives rise. We may therefore hope that special attention will before long be given to localities where both may combine to give information as to facts outside the range of the ordinary methods of geology.

The second phenomenon on which more light is desirable is the permanent magnetization of magnetic rocks. It is known that fragments of these are strongly but irregularly magnetized, but that the effect of very large masses at a distance appears to be due to induced rather than to permanent magnetism. There are three questions to which I should like an answer: Are underground masses of magnetite ever permanently magnetized? Are large areas of surface masses—say a few hundred square yards in extent—ever permanently and approximately uniformly magnetized in the same sense? Is there any relation between the geological age and the direction of the permanent magnetism of magnetic rocks?

Inquiries such as these can only be taken up by individual workers, but I venture to think that the comparison of the observatory instruments and the fluctuations of secular change outside the observatories could best be investigated under the auspices of a great scientific society. The cooperation of the authorities of the observatories will no doubt be secured, but it is most important that the comparison

should in all cases be made with one set of instruments and by the same methods. Whether the British Association, which for so long managed a magnetic observatory, may think that it could usefully inaugurate the work it would be improper for me in a presidential address to forecast. Who does it is of less importance than that it should be done, and I can not but hope that the arguments and instances which I have to-day adduced may help to bring about not only the doing of the work, but the doing of it quickly.

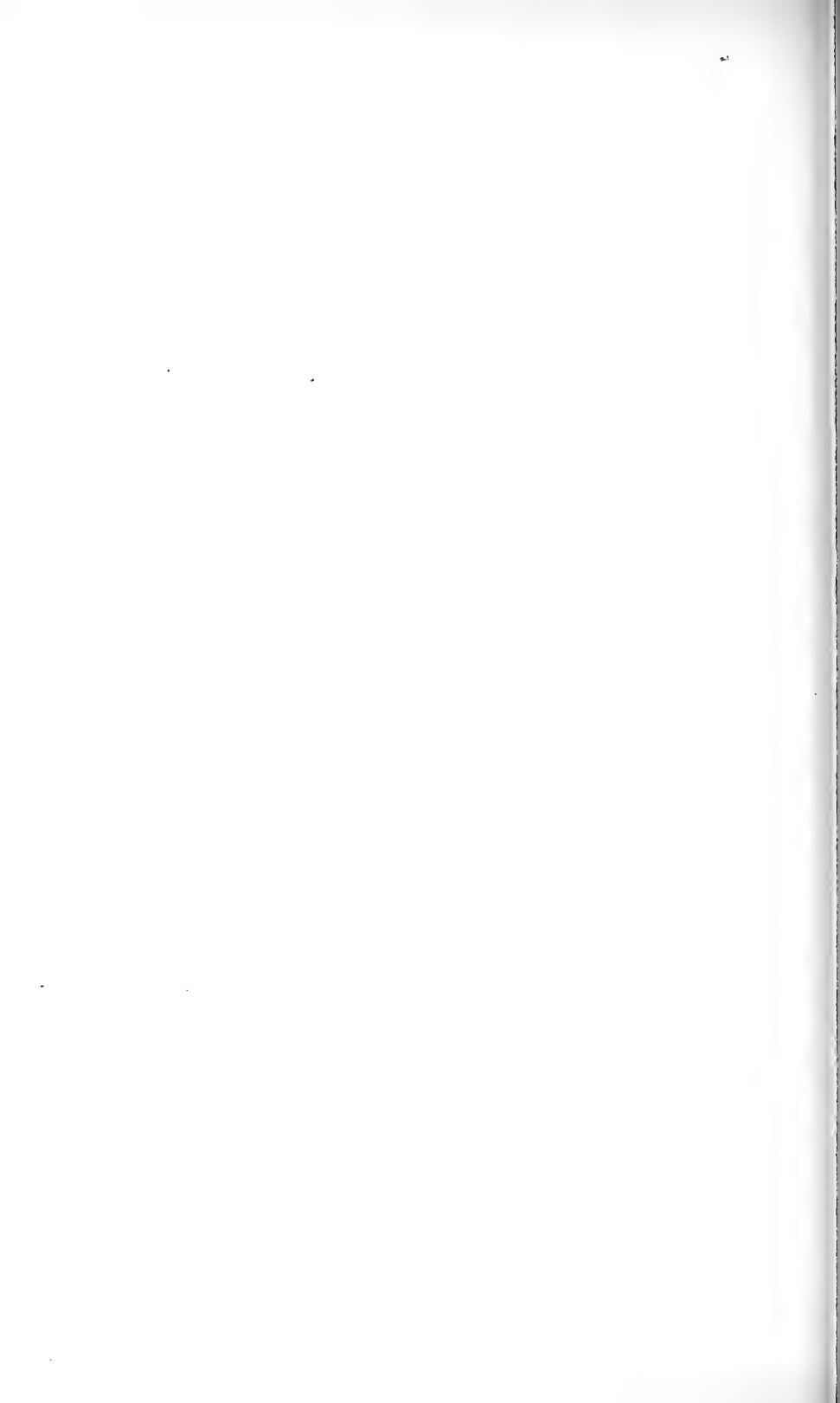

PHOTOGRAPHIC PHOTOMETRY.¹

By M. J. JANSSEN.

A dozen years ago I undertook to lay the foundations of a science of photographic photometry, with special reference to its application to astronomical physics. I applied the fundamental principle of my researches—a principle to be restated below—to the measurement of the comparative intensities of solar and lunar light, to that of the earth light on the moon, to the radiating activity of the sun as compared with several stars, notably Sirius, and finally to the law of decrement of the light in passing away from the head along the tail of the comet *C* of 1881, which had been photographed at Meudon, the first among such bodies.

Perhaps these researches were not as energetically followed up by me as they ought to have been, for their astronomical importance is great, and they might have furnished valuable terms of comparison for the future. But I have had the satisfaction of seeing the principle adopted by the International Congress of Photometry for the measures of photometric order for which they laid down the rules. In order to renew attention to the subject, I here reproduce a résumé of my researches, wishing that it may become the starting point of new investigations.

Photometry has to determine the ratio of intensities of two lights. For example, to determine the ratio of luminosity of a candle and a Carcel lamp is one problem of photometry, and to evaluate in Carcel lamps the power of an electric source of luminous radiation is another.

We often have to make comparisons of this sort in the heavens. They are always highly interesting and sometimes lead to beautiful discoveries. Thus, we know that the moon is an opaque ball not self-luminous, but shining because lit up by the sun's rays. Now, we may ask what proportion of the incident light it remits, in what measure the surface shows specular reflection, and what is the relative amount of light of the full moon as compared with that of the luminary from which its rays are borrowed. Independent of the curiosity of such data in themselves, it is clear that if the study of them is carried deep enough it may lead to important conclusions relative to the nature of materials at the surface of the moon.

¹Translated from *Annuaire du Bureau des Longitudes*, Paris, 1895.

So, also, the study of the planets would be advanced by photometric observations which should afford a knowledge of the relations of their surfaces and atmospheres to light.

A special importance attaches to photographic photometry in its application to the fixed stars. The quantity of light a star sends us depends chiefly on its distance and its radiating power, so that either of these two factors being known the apparent light will determine the other. Thus, if the parallax of a star and the amount of light which it sends to us are known, we can deduce the intrinsic amount of its radiation—that is to say, its rank among the hosts of suns with which the spaces of heaven are sown. Add to this knowledge that of the qualities of its light, and you will have a total from which the magnitude, the constitution, and the activity of the luminary in question may be almost completely defined.

Similar remarks apply to comets and nebulae. Thus, celestial photometry constitutes one of the most important methods of astronomy; and it is very interesting to see what aid it can derive from photography. For this purpose I have employed a method which I proceed to describe.¹ We know that in the common photometric method the ratio of emission of the two sources of light is obtained by removing the brighter of them until they each illuminate the shadow due to the other equally. This is one of numerous methods not hitherto used in photographic photometry. In a photograph, in order to judge of the brightness of a luminous or illuminated body, we have nothing but its photographic action, or the greater or less opacity of the metallic deposit which it occasions on the sensitive film. Now, the blackness of this deposit is very far from being proportional to the time of action of the light. Could we see the deposit increase, and could we measure its amount while the action of a steady light was going on, we should find that it increased rapidly at first, and afterwards slower and slower, until it became practically stationary. Thus, we can not take as measure of the intensity of a source of light the degree of opacity of the metallic deposit which it occasions, since that opacity is not proportional to its action during a determinate time. But if, in place of considering the different degrees of opacity in relation to equality of the time of action, we consider on the contrary the variable time necessary to obtain a deposit of one fixed opacity, we shall have a sure basis for the comparisons, and this, in fact, appears from experiment.

The fact is, that to produce in a sensitive film a metallic deposit of given blackness a certain sum of radiant action is needed, and whether this sum is brought into existence in a longer or shorter time makes no difference. Hence it follows that the energy of a source is increased by the time necessary to effect the given degree of blackness—that is to say, according to this principle, two sources are to one another inversely

¹Comptes rendus de l'Académie des Sciences, XCII, 1881, April 4. Annuaire du Bureau des Longitudes for 1882.

as the times they occupy in producing a given shade upon the same sensitive film, or in other words, to produce equal photographic effects.

This is the principle I have adopted in my investigations into photographic photometry. I have assured myself experimentally of the legitimacy of this principle by ascertaining the relative amounts of time necessary to obtain tints of the same opacity on one sensitive film placed at increasing distances of the source of light. It is found that these times increase as the squares of the distances. Thus, for distances 1, 2, 3, 4 - - - 8, etc., the times are in the ratio of 1, 4, 9, 16 - - - 64, etc. It is necessary to work with one and the same film, to avoid all stray light, to develop the plates in one bath, and, in a word, to use all precautions possible in order to establish this law. We may also mention that to obtain the best results possible it is needful to take care to choose the opacity which corresponds to the most rapid variation which happens toward the beginning of the action.

Let us see how this method can be applied to the photometric study of the heavenly bodies.

For a long time astronomers and physicists have sought to determine the luminous intensity of the moon relatively to that of the sun. Bouguer appears to be the one who came nearest to the truth. Employing a candle as middle term of the comparison, he found the light of the full moon at its mean distance to be about $\frac{1}{300000}$ of that of the sun. The employment of a candle is open to criticism, because its light is of a hue much warmer than that of the sun and still more so than that of the moon—a circumstance which must have introduced peculiar difficulties in making the photometric matchings of shades. Bouguer would have much improved his method had he subjected the candle-light to the sifting action of a suitable blue glass, so as to bring its color nearer to that of the lunar rays.

However that may be, it is remarkable that that old determination agrees closely with the photographic measures which I obtained in taking series of solar and lunar images and comparing the times of exposure to which correspond photographs of the same intensity.¹ It is to be further noticed that Bouguer's determination refers to the integral of visible rays, while the photographs are caused by more refrangible rays.

One could only infer that the lunar rays are highly photographic and have great intensity in the blue and violet. The hue of moonlight might have enabled us to foresee that result.

The comparison of the light of the sun and moon speaks volumes in regard to the admirable elasticity of our visual organ. When a country is lit up by the full moon it only receives $\frac{1}{300000}$ of the light of noon-

¹Instead of taking photographs of the luminaries themselves, we can also, as I did at the time, avail ourselves of bands of successive intensity obtained by sunlight and moonlight. Thus, for the moon, we exposed to its light a holder whose curtain uncovered successively and at equal intervals of time the different parts of a sensitive plate, giving, after development, a series of bands of increasing opacity, which were compared with a plate exposed to sunlight for $\frac{1}{30000}$ second.

day. One might suppose that such a prodigious lowering of the illumination would produce apparently total darkness. Yet our organ takes on such increased sensibility under those circumstances that we can not only find our way about, but distinguish objects, make out details, and even enjoy the landscape. Nay, in some fine tropical regions bright nights seem almost like day.

Before quitting the subject of the moon let us say a word about the earth light. Everybody knows the appearance of "the new moon in the old moon's arms." It is a faint light on the darker side of the moon showing the main features, i. e., the great "seas" or dark patches, to the naked eye, and in a large telescope showing almost everything that can be seen at full moon, though not so well as at other phases.

The genius of Lionardo (less correctly Leonardo) da Vinci divined that the cause of this was the light reflected from the earth. Photographic photometry can give us the relative brightness of this light. In an experiment made with a telescope of 0.50 meter aperture and 1.60 meters focal length I obtained an image of the lunar ball, rendered visible by earth light in sixty seconds, showing the great accidents of its surface. On the other hand, from a series of photographs of the full moon it was found that one obtained by an exposure of one-eightieth of a second had the same intensity. We infer that the ratio of intensity of full earth light to sunlight at the moon's surface is $\frac{1}{5000}$. Arago had found $\frac{1}{4000}$ in one observation, $\frac{1}{7000}$ in a subsequent one. The value $\frac{1}{5000}$ seems probably nearer the truth. These determinations are to be regarded as merely preliminary to a thorough study in which the situations of the three luminaries are to be taken account of and the specular distinguished from irregular reflection from the earth.

Fixed stars in the focus of a telescope appear nearly like points, not lending themselves advantageously to photometric comparisons, least of all by the photographic method. Accordingly I have proposed, instead of putting the sensitive plate in the focal plane of the instrument to place it a little forward of that plane. In this way, instead of a point each star makes a little disk bounded by the section of the cone of rays from the objective by the plane of the film. With a well-corrected lens this disk will be uniformly illuminated. I term this disk the "stellar circle." With first-magnitude stars and a telescope of moderate size a few seconds suffice for obtaining such a photograph as is most suitable. We can obtain on one and the same plate a series of such circles of graduated exposures.

Forming a similar series with a second comparison star, the differences in the times of exposure being constant in each series, though not quite equal in the two, it will only remain, after the development, to pick out two circles, one from each series of equal intensities, just as in reading a vernier we find two coincident lines. The photographic luminosities of the two stars will be inversely as the times of exposure.

When the problem is to compare a star with the sun a special device is required on account of the enormous light of the latter. We can

then make use of the photographic photometer. Suppose we have a holder fitting a sensitive plate, and over the latter a metallic shutter pierced with holes of the size of the "stellar circles." Before this plate let a second plate move by virtue of a spring, this second plate having a triangular window. When the window, in consequence of the action of the spring, passes before the holes of the shutter it will determine for each of them a photographic action, which will be measured by the width of the triangular window at that point and by the velocity of the slide, which can be evaluated by a tuning fork. Thus a series of circles of graduated intensity will be obtained comparable with the "stellar circles." These circles are due to direct sunlight. But to render the results more strictly comparable it will be proper to lay the telescope objective down on the plate, so that the effects of absorption and reflection may be the same as when the stars were photographed.

By this method, the results of which were duly reported to the Academy of Sciences,¹ the radiating powers of several stars were investigated. In particular it was used to compare the light of our sun with that of the brightest star in the heavens, the Dog Star, or Sirius. It showed that that colossal orb had an intrinsic radiation in the photographic spectrum ten times that of the center of our planetary system.

But it is especially when we wish to measure the luminosity of special parts of an object, and are not content with knowing the total radiation, that the advantages of the photographic method are manifested. We have, for example, been able to evaluate the light of different parts of the tail of comet 1881 *b*, and to give quite closely the law of the decrease of that light as the distance from the nucleus increases.

The arrangement employed was as follows: On the photographic plate, fitted into a holder, was placed a screen with an opening representing the comet's tail. Before the apparatus was a shutter in which a triangle had been cut out, having its base rectilinear, but its sides curved. When this triangular window moved in the direction of the line of its base the times of exposure of the different parts depended on the forms of the curved sides. The whole base moved along that point of the opening in the screen that represented the nucleus, while the vertex of the triangle passed over the part of the opening representing the extreme and evanescent portions of the tail. Here the time of exposure vanished. In intermediate parts, say, at distance x from the base, the time of exposure was proportional to the distance, $2y$, from one side of the triangle to the other along a line parallel to the base and to the motion. A number of such shutters were constructed, the curves of the sides being determined by one of the equations $\Delta y = x^m$, m having a constant value for each shutter, but different values for different shutters. The whole being exposed to uniform illumination and the shutter moved by a spring an artificial figure of a comet was obtained with each shutter—

¹ April 4, 1891.

that is, with each value of m . When $m=2$ the photographic action would be inversely as the second power of the distance from the nucleus. With $m=3$, it would be inversely as the third power, etc.

Now, the different pictures so obtained being compared with the photograph of the real comet, it was found that the intensities could best be matched in all parts by taking m between 4 and 6, so that the result was that the intensity of the light in the comet's tail, in the photographic part of the spectrum, varied inversely as the fourth to sixth power of the distance from the nucleus.¹ At such enormous rate does the light diminish as we pass away from the nucleus.

The method of "stellar circles" comes into play again when we wish to reproduce the conditions under which any celestial photograph has been taken, especially in the study of nebulae. A nebula is not an object having a definite outline, like the sun, the moon, etc. Its image is rather like a nimbus cloud, its different parts differing greatly in brightness. The consequence is that differences in the power of the telescope, the time of exposure, the sensitiveness of the film, the transparency of the atmosphere, etc., result in pictures so different that they sometimes would not be supposed to possibly represent the same thing. If, for instance, a nebula has brilliant parts scattered in it, a photograph with short exposure will show these parts only as isolated from one another, while with a long exposure the intervening places will be all filled up with little variation of intensity. In 1881 we obtained at Meudon a series of photographs of the great nebula in Orion, which show how surprisingly the aspect of that object may change with greater or less exposure.

Nevertheless, if we wish to hand down to posterity monuments which shall allow changes in the nebula to be put out of doubt, we must contrive some way in which the photographs of future ages shall be rendered comparable with those of to-day. Here the "stellar circles" afford valuable assistance. Suppose that on the plate which has just received the photographic impression of the nebula we form stellar circles of some five stars, well chosen, not variable, and situated in the neighborhood. Then we shall obtain, after the development, along with the image of the nebula those of the stellar circles of comparison. The ratios of the times of exposure of the nebula and the circles will be carefully noted. Later, then, when the time comes to make a comparable photograph, we have only to ascertain the time of exposure which, with a new telescope and a new photographic preparation, is required to produce stellar circles of the same diameter from the same stars of equal intensity, and we find by the rule of three the time of exposure requisite to obtain an equivalent photograph of the nebula.

It is remarkable that we can, by such device, obtain, after any lapse of time, no matter how different all the conditions may have become, a photographic image altogether comparable with that of times gone by.

¹ *Annuaire du Bureau des Longitudes* for 1882.

THE SPLASH OF A DROP AND ALLIED PHENOMENA.¹

By Prof. A. M. WORTHINGTON, M. A., F. R. S.

The splash of a drop is a transaction which is accomplished in the twinkling of an eye, and it may seem to some that a man who proposes to discourse on the matter for an hour must have lost all sense of proportion. If that opinion exists, I hope this evening to be able to remove it and to convince you that we have to deal with an exquisitely regulated phenomenon, and one which very happily illustrates some of the fundamental properties of fluids. It may be mentioned also that the recent researches of Lenard, in Germany, and J. J. Thomson, at Cambridge, on the curious development of electrical charges that accompanies certain kinds of splashes have invested with a new interest any examination of the mechanics of the phenomenon. It is to the mechanical and not to the electrical side of the question that I shall call your attention this evening.

The first well-directed and deliberate observations on the subject that I am acquainted with were made by a schoolboy at Rugby some twenty years ago, and were reported by him to the Rugby Natural History Society. He had observed that the marks of accidental splashes of ink drops that had fallen on some smoked glasses with which he was experimenting, presented an appearance not easy to account for. Drops of the same size falling from the same height had made always the same kind of mark, which when carefully examined with a lens showed that the smoke had been swept away in a system of minute concentric rings and fine striæ. Specimens of such patterns, obtained by letting drops of mercury, alcohol, and water fall onto smoked glass, are thrown on the screen, and the main characteristics are easily recognized. Such a pattern corresponds to the footprints of the dance that has been performed on the surface, and though the drop may be lying unbroken on the plate, it has evidently been taking violent exercise, and were our vision acute enough we might observe that it was still palpitating after its exertions.

A careful examination of a large number of such footprints showed that any opinion that could be formed therefrom of the nature of the

¹Address at weekly evening meeting, May 18, 1894, Royal Institution of Great Britain. Printed in proceedings of the Royal Institution.

motion of the drop must be largely conjectural, and it occurred to me about eighteen years ago to endeavor by means of the illumination of a suitably timed electric spark to watch a drop through its various changes on impact.

The reason that with ordinary continuous light nothing can be satisfactorily seen of the splash is not that the phenomenon is of such short duration, but because the changes are so rapid that before the image of one stage has faded from the eye the image of a later and quite different stage is superposed upon it. Thus the resulting impression is a confused assemblage of all the stages, as in the photograph of a person who has not sat still while the camera was looking at him. The problem to be solved experimentally was therefore this: To let a drop of definite size fall from a definite height in comparative darkness onto a surface, and to illuminate it by a flash of exceedingly short duration at any desired stage, so as to exclude all the stages previous and subsequent to the one thus picked out. The flash must be bright enough for the image of what is seen to remain long enough on the eye for the observer to be able to attend to it, even to shift his attention from one part to another, and thus to make a drawing of what is seen. If necessary the experiment must be capable of repetition, with an exactly similar drop falling from exactly the same height, and illuminated at exactly the same stage. Then, when this stage has been sufficiently studied, we must be able to arrange with another similar drop to illuminate it at a rather later stage, say one one-thousandth second later, and in this way to follow step by step the course of the whole phenomenon.

The apparatus by which this has been accomplished is on the table before you. Time will not suffice to explain how it grew out of earlier arrangements very different in appearance, but its action is very simple and easy to follow by reference to the diagram (fig. 1).

A A' is a light wooden rod rather longer and thicker than an ordinary lead pencil, and pivoted on a horizontal axle, O. The rod bears at the end A a small deep watch glass, or segment of a watch glass, whose surface has been smoked, so that a drop even of water will lie on it without adhesion. The end A' carries a small strip of tinned iron, which can be pressed against and held down by an electro-magnet, C C'. When the current of the electro-magnet is cut off the iron is released, and the end A' of the rod is tossed up by the action of a piece of india rubber stretched catapult-wise across two pegs at E, and by this means the drop resting on the watch glass is left in mid-air free to fall from rest.

B B' is a precisely similar rod worked in just the same way, but carrying at B a small horizontal metal ring, on which an ivory timing sphere of the size of a child's marble can be supported. On cutting off the current of the electro-magnet the ends A' and B' of the two levers are simultaneously tossed up by the catapults, and thus drop and sphere

begin to fall at the same moment. Before, however, the drop reaches the surface on which it is to impinge, the timing sphere strikes a plate, D, attached to one end of a third lever pivoted at Q, and thus breaks the contact between a platinum wire bound to the underside of this lever and another wire crossing the first at right angles. This action breaks an electric current which has traversed a second electro-magnet,

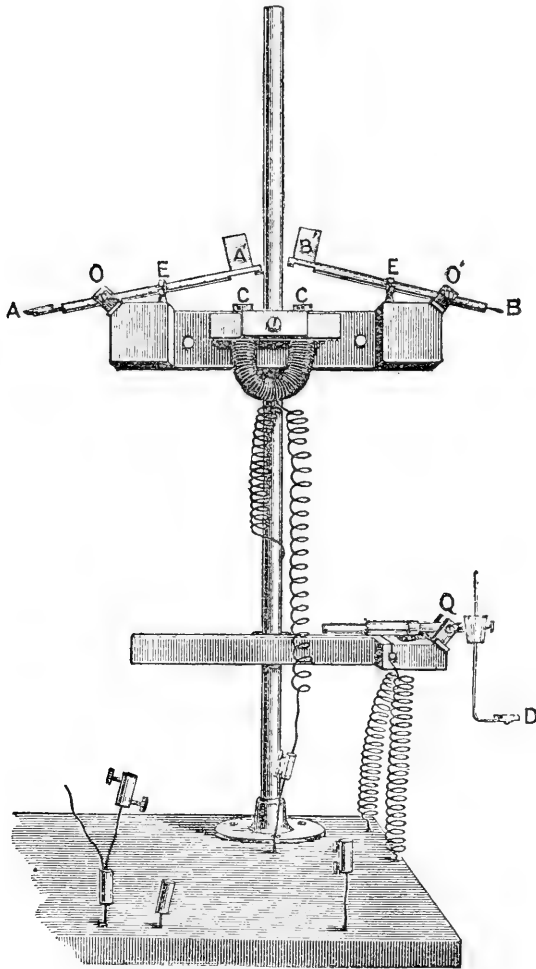

FIG. 1.—Electric flash apparatus.

F (fig. 2), and releases the iron armature N of the lever N P, pivoted at P, thus enabling a strong spiral spring, G, to lift a stout brass wire, L, out of mercury, and to break at the surface of the mercury a strong current that has circulated round the primary circuit of a Ruhmkorff's induction coil; this produces at the surface of the mercury a bright self-induction spark in the neighborhood of the splash, and it is by this

flash that the splash is viewed. The illumination is greatly helped by surrounding the place where the splash and flash are produced by a white cardboard inclosure, seen in fig. 2, from whose walls the light is diffused.

It will be observed that the time at which the spark is made will depend on the distance that the sphere has to fall before striking the plate D, for the subsequent action of demagnetizing F and pulling the wire L out of the mercury in the cup II is the same on each occasion. The modus operandi is consequently as follows: The observer, sitting in comparative but by no means complete darkness, faces the apparatus as it appears in fig. 2, presses down the ends A' B' of the levers first described, so that they are held by the electro-magnet C (fig. 1).

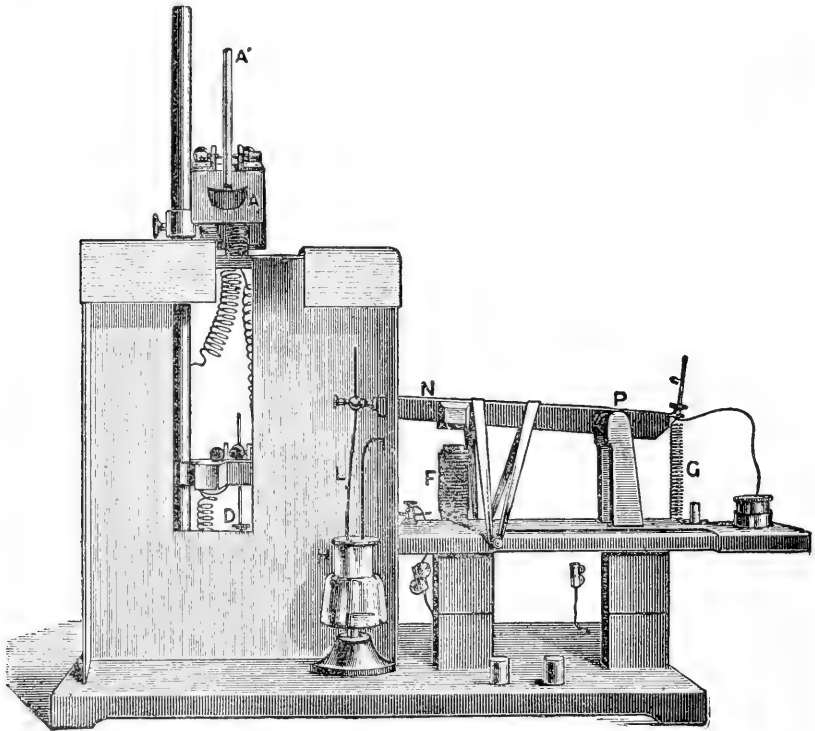
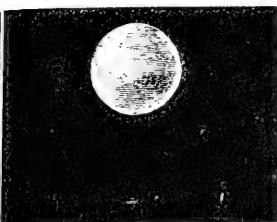

FIG. 2. Electric flash apparatus.

Then he presses the lever N P down on the electro-magnet F, sets the timing sphere and drop in place, and then, by means of a bridge between two mercury cups, short-circuits and thus cuts off the current of the electro-magnet C. This lets off drop and sphere, and produces the flash. The stage of the phenomenon that is thus revealed having been sufficiently studied by repetition of the experiment as often as may be necessary, he lowers the plate D a fraction of an inch, and thus obtains a later stage. Not only is any desired stage of the phe-

1



2

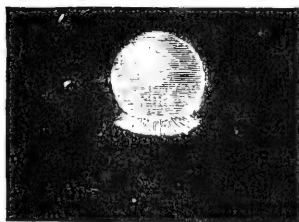

3

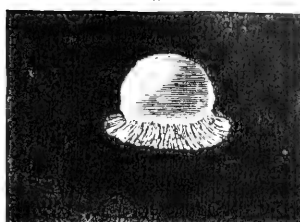

4

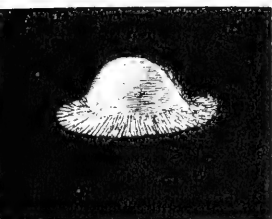

5

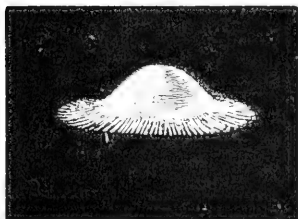

6

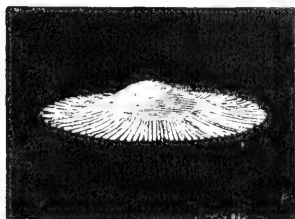

7

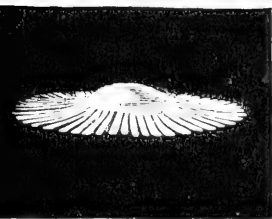

8

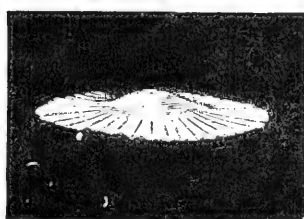

9

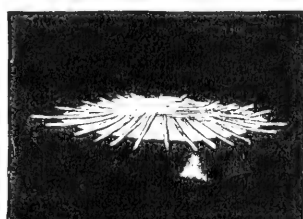

10

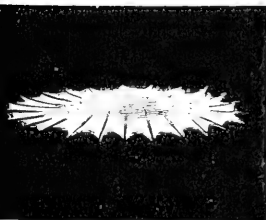

11

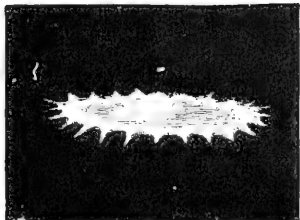

12

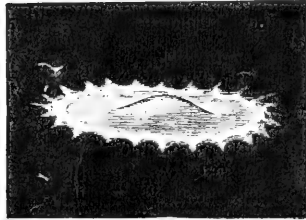

13

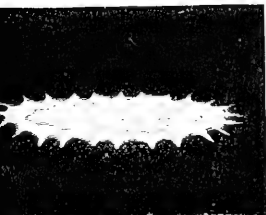

14

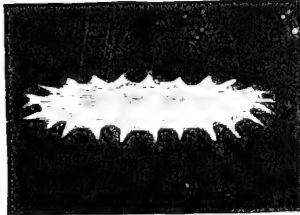

15

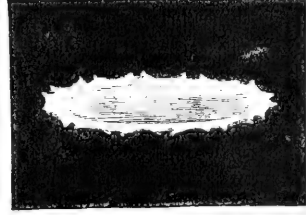

SERIES I.
SPLASH OF A DROP.

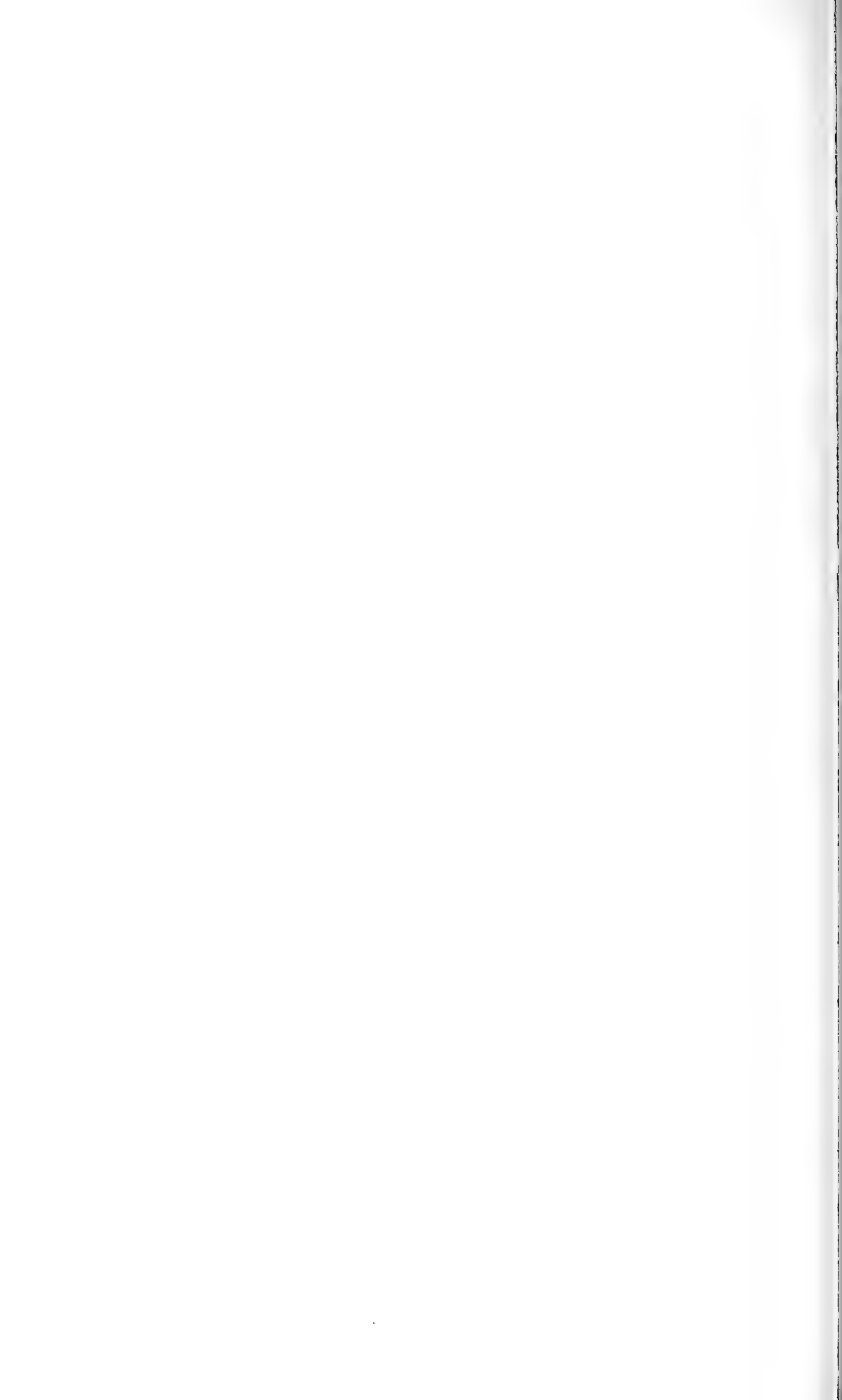

nomenon thus easily brought under examination, but the apparatus also affords the means of measuring the time interval between any two stages. All that is necessary is to know the distance that the timing sphere falls in the two cases. Elementary dynamics then give us the interval required. Thus, if the sphere falls 1 foot and we then lower D one-fourth of an inch, the interval between the corresponding stages will be about 0.0026 second.

Having thus described the apparatus, which I hope shortly to show you in action, I pass to the information that has been obtained by it.

This is contained in a long series of drawings, of which a selection will be presented on the screen. The first series that I have to show represents the splash of a drop of mercury 0.15 inch in diameter that has fallen 3 inches onto a smooth glass plate. (Plates II, III.) It will be noticed that very soon after the first moment of impact minute rays are shot out in all directions on the surface. These are afterwards overflowed or united, until, as in fig. 8, the outline is only slightly rippled. Then (fig. 9) main rays shoot out, from the ends of which in some cases minute droplets of liquid would split off, to be left lying in a circle on the plate, and visible in all subsequent stages. By counting these droplets when they were thus left, the number of rays was ascertained to have been generally about twenty-four. This exquisite shell-like configuration shown in fig. 9, marks about the maximum spread of the liquid, which, subsiding in the middle, afterwards flows into an annulus or rim with a very thin central film, so thin, in fact, as often to tear more or less irregularly. This annular rim then divides or segments (figs. 14, 15, 16) in such a manner as to join up the rays in pairs, and thus passes into the twelve-lobed annulus of fig. 16. Then the whole contracts, but contracts most rapidly between the lobes, the liquid then being driven into and feeding the arms, which follow more slowly. In fig. 21 the end of this stage is reached, and now the arms continuing to come in, the liquid rises in the center; this is, in fact, the beginning of the rebound of the drop from the plate. In the case before us the drops at the ends of the arms now break off (fig. 25), while the central mass rises in a column which just fails itself to break up into drops, and falls back into the middle of the circle of satellites which, it will be understood, may in some cases again be surrounded by a second circle of the still smaller and more numerous droplets that split off the ends of the rays in fig. 9. The whole of the thirty stages described are accomplished in about one-twentieth of a second, so that the average interval between them is about one six-hundredth of a second.

It should be mentioned that it is only in rare cases that the subordinate drops, seen in the last six figures, are found lying in a very complete circle after all is over, for there is generally some slight disturbing lateral velocity which causes many to mingle again with the central drop, or with each other. But even if only half or a quarter of the circle is left, it is easy to estimate how many drops and therefore how

many arms there have been. It may be mentioned that sometimes the surface of the central lake of liquid (figs. 14, 15, 16, 17) was seen to be covered with beautiful concentric ripples, not shown in the figures.

The question now naturally presents itself, Why should the drop behave in this manner? In seeking the answer it will be useful to ask ourselves another question. What should we have expected the drop to do? Well, to this I suppose most people would be inclined, arguing from analogy with a solid, to reply that it would be reasonable to expect the drop to flatten itself, and even very considerably flatten itself, and then, collecting itself together again, to rebound, perhaps as a column such as we have seen, but not to form this regular system of rays and arms and subordinate drops.

Now this argument from analogy with a solid is rather misleading, for the forces that operate in the case of a solid sphere that flattens itself and rebounds, are due to the bodily elasticity which enables it not only to resist, but also to recover from any distortion of shape or shearing of its internal parts past each other. But a liquid has no power of recovering from such internal shear, and the only force that checks the spread, and ultimately causes the recovery of shape is the surface tension, which arises from the fact that the surface layers are always in a state of extension and always endeavoring to contract. Thus we are at liberty when dealing with the motions of the drop to think of the interior liquid as not coherent, provided we furnish it with a suitable elastic skin. Where the surface skin is sharply curved outward, as it is at the sharp edge of the flattened disk, there the interior liquid will be strongly pressed back. In fact the process of flattening and recoil is one in which energy of motion is first expended in creating fresh liquid surface and subsequently recovered as the surface contracts. The transformation is, however, at all moments accompanied by a great loss of energy as heat. Moreover, it must be remembered that the energy expended in creating the surface of the satellite drops is not restored if these remain permanently separate. Thus the surface tension explains the recoil, and it is also closely connected with the formation of the subordinate rays and arms. To explain this it is only necessary to remind you that a liquid cylinder is an unstable configuration. As you know, any fine jet becomes beaded and breaks into drops, but it is not necessary that there should be any flow of liquid along the jet; if, for example, we could realize a rod of liquid of the shape and size of this ruler and liberate it in the air, it would not retain its cylindrical shape, but would segment or divide itself up into a row of drops regularly disposed according to a definite and very simple numerical law, viz, that the distances between the centers of contiguous drops would be equal to the circumference of the cylinder. This can be shown by calculation to be a consequence of the surface tension, and the calculation has been closely verified by experiment. If the liquid cylinder were liberated on a plate, it would still topple into a

16

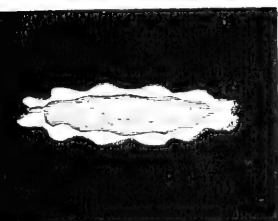

17

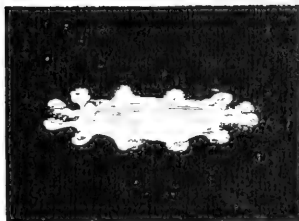

18

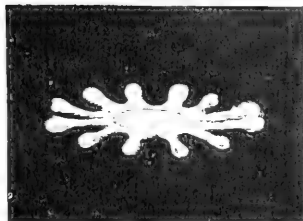

19

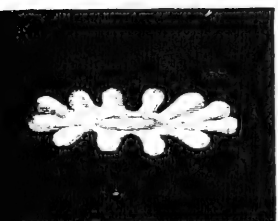

20

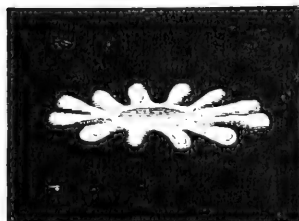

21

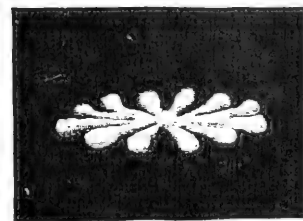

22

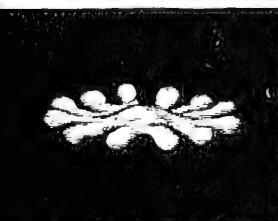

23



24

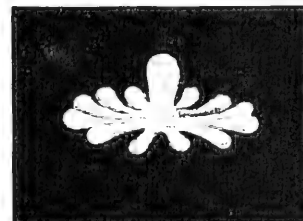

25

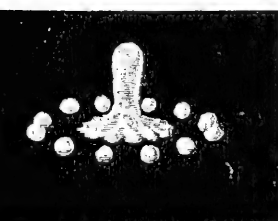

26

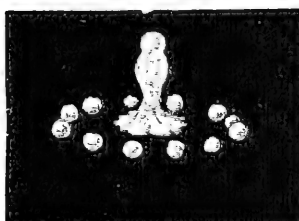

27

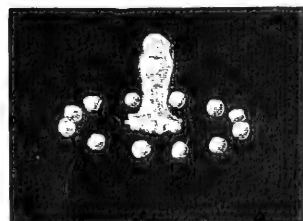

28

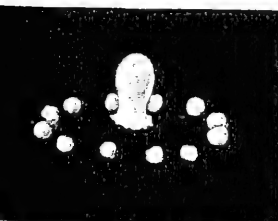

29

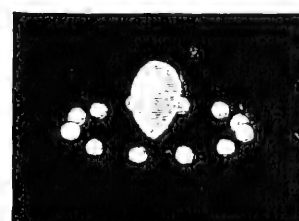

30

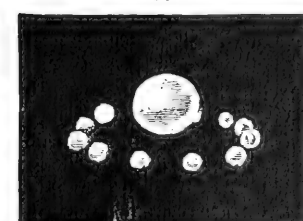

SERIES I—CONTINUED.

SPLASH OF A DROP.



regular row of drops, but they would be farther apart; this was shown by Plateau. Now imagine the cylinder bent into an annulus. It will still follow the same law,¹ i. e., it will topple into drops just as if it were straight. This I can show you by a direct experiment. I have here a small thick disk of iron, with an accurately planed face and a handle at the back. In the face is cut a circular groove, whose cross section is a semicircle. I now lay this disk face downward on the horizontal face of the lantern condenser, and through one of two small holes bored through to the back of the disk I fill the groove with quicksilver. Now, suddenly lifting the disk from the plate I release an annulus of liquid, which splits into the circle of very equal drops which you see projected on the screen. You will notice that the main drops have between them still smaller ones, which have come from the splitting up of the thin cylindrical necks of liquid which connected the larger drops at the last moment.

Now, this tendency to segment or topple into drops, whether of a straight cylinder or of an annulus, is the key to the formation of the arms and satellites, and indeed to much that happens in all the splashes that we shall examine. Thus in fig. 12 we have an annular rim, which in figs. 13 and 14 is seen to topple into lobes by which the rays are united in pairs, and even the special rays that are seen in fig. 9 owe their origin to the segmentation of the rim of the thin disk into which the liquid has spread. The proceeding is probably exactly analogous to what takes place in a sea wave that curls over in calm weather on a slightly sloping shore. Anyone may notice how, as it curls over, the wave presents a long smooth edge, from which at a given instant a multitude of jets suddenly shoot out, and at once the back of the wave, hitherto smooth, is seen to be furrowed or "combed." There can be no doubt that the cylindrical edge topples into alternate convexities and concavities; at the former the flow is helped, at the latter hindered, and thus the jets begin, and special lines of flow are determined. In precisely the same way the previously smooth circular edge of fig. 8 topples, and determines the rays and lines of flow of fig. 9.

Before going on to other splashes I will now endeavor to reproduce a mercury splash of the kind I have described, in a manner that shall be visible to all. For this purpose I have reduplicated the apparatus which you have seen, and have it here so arranged that I can let the drop fall onto the horizontal condenser plate of the lantern, through which the light passes upward, to be afterwards thrown upon this screen. The illuminating flash will be made inside the lantern, where the arc light would ordinarily be placed. I have now set a drop of mercury in readiness and put the timing sphere in place, and now if you will look intently at the middle of the screen I will darken the room and let off the splash. [The experiment was repeated four or

¹ See Worthington on the "Spontaneous segmentation of a liquid annulus," Proc. Roy. Soc., No. 200, page 49 (1879).

five times, and the figures seen were like those of Series X.] Of course all that can be shown in this way is the outline, or rather a horizontal section of the splash; but you are able to recognize some of the configurations already described, and will be the more willing to believe that a momentary view is after all sufficient to give much information if one is on the alert and has acquired skill by practice.

The general features of the splash that we have examined are not merely characteristic of the liquid mercury, but belong to all splashes of a liquid falling onto a surface which it does not wet, provided the height of fall or size of the drop are not so great as to cause complete disruption,¹ in which case there is no recovery and rebound. Thus a drop of milk falling onto a smoked glass will, if the height of fall and size of drop are properly adjusted, give forms very similar to those presented by a drop of mercury. The whole course of the phenomenon depends, in fact, mainly on four quantities only: (1) The size of the drop; (2) the height of fall; (3) the value of the surface tension; (4) the viscosity of the liquid.

The next series of drawings illustrates the splash of a drop of water falling into water.

In order the better to distinguish the liquid of the original drop from that into which it falls, the latter was colored with ink or with an aniline dye, and the drop itself was of water rendered turbid with finely divided matter in suspension. Finally, drops of milk were found to be very suitable for the purpose, the substitution of milk for water not producing any observable change in the phenomenon.

In Series II the drop fell 3 inches, and was one-fifth of an inch in diameter. (Plate IV.)

[In most of the figures of this and of succeeding series the central white patch represents the original drop, and the white parts round it represent those raised portions of the liquid which catch the light. The numbers at the side of each figure give the time interval in seconds from the occurrence of the first figure, or of the figure marked $T=0$.]

It will be observed that the drop flattens itself out somewhat, and descends at the bottom of a hollow with a raised beaded edge (fig. 2). This edge would be smooth and circular but for the instability which causes it to topple into drops. As the drop descends the hollow becomes wider and deeper, and finally closes over the drop (fig. 3), which, however, soon again emerges as the hollow flattens out, appearing first near, but still below the surface (fig. 4), in a flattened, lobed form, afterward rising as a column somewhat mixed with adherent water, in which traces of the lobes are at first very visible.

¹ Readers who wish a more detailed account of a greater variety of splashes are referred to papers by the author, Proc. Roy. Soc., Vol. XXV, pages 261 and 498 (1877); and Vol. XXXIV, page 217 (1882).

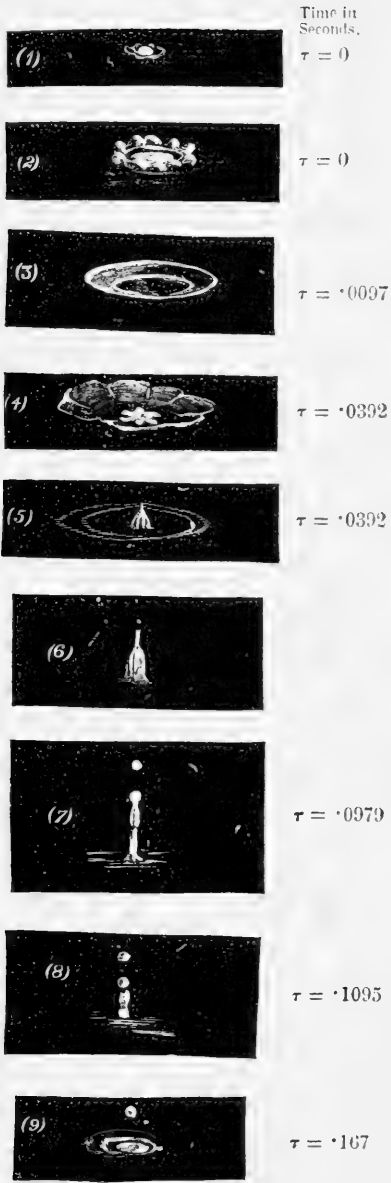

SERIES II.

THE SPLASH OF A DROP, FOLLOWED IN DETAIL BY INSTANTANEOUS ILLUMINATION.

Diameter of drop, half inch. Height of fall, $3\frac{1}{2}$ inches.



The rising column, which is nearly cylindrical, breaks up into drops before or during its subsequent descent into the liquid. As it disappears below the surface the outward and downward flow causes a hollow to be again formed, up the sides of which an annulus of milk is carried, while the remainder descends to be torn again a second time into a vortex ring, which, however, is liable to disturbance from the falling in of the drops which once formed the upper part of the rebounding column.

It is not difficult to recognize some features of this splash without any apparatus beyond a cup of tea and a spoonful of milk. Any drinker of afternoon tea, after the tea is poured out and before the milk is put in, may let the milk fall into it drop by drop from 1 or 2 inches above it. The rebounding column will be seen to consist almost entirely of milk, and to break up into drops in the manner described, while the vortex ring, whose core is of milk, may be seen to shoot down into the liquid. But this is better observed by dropping ink into a tumbler of clear water.

Let us now increase the height of fall to 17 inches. Series III exhibits the result (Plate V). All the characteristics of the last splash are more strongly marked. In fig. 1 we have caught sight of the little raised rim of the hollow before it has beaded, but in fig. 2 special channels of easiest flow have been already determined. The number of ribs and rays in this basket-shaped hollow seemed to vary a good deal with different drops, as also did the number of arms and lobes seen in later figures, in a somewhat puzzling manner, and I have made no attempt to select drawings which are in agreement in this respect. It will be understood that these rays contain little or none of the liquid of the drop which remains collected together in the middle. Drops from these rays or from the larger arms and lobes of subsequent figures are often thrown off high into the air. In figs. 3 and 4 the drop is clean gone below the surface of the hollow, which is now deeper and larger than before. The beautiful beaded annular edge then subsides, and in fig. 5 we see the drop again, and in fig. 6 it begins to emerge. But although the drop has fallen from a greater height than in the previous splash, the energy of the impact, instead of being expended in raising the same amount of liquid to a greater height, is now spent in lifting a much thicker adherent column to about the same height as in the last splash. There was sometimes noticed, as is seen in fig. 9, a tendency in the water to flow up past the milk, which, still comparatively unmingled with water, rides triumphant on the top of the emergent column. The greater relative thickness of this column prevents its splitting into drops, and figs. 10 and 11 show it descending below the surface to form the hollow of fig. 12, up the sides of which an annular film of milk is carried (figs. 12 and 13), having been detached from the central mass, which descends to be torn again, this time centrally into a well-marked vortex ring.

If we keep to the same size of drop and increase the fall to something over a yard no great change occurs in the nature of the splash, but the emergent column is rather higher and thinner and shows a tendency to split into drops.

When, however, we double the volume of the drop and raise the height of fall to 52 inches, the splash of Series IV is obtained (Plate VI), which is beginning to assume quite a different character. The raised rim of the previous series is now developed into a hollow shell of considerable height, which tends to close over the drop. This shell or dome is a characteristic feature of all splashes made by large drops falling from a considerable height, and is extremely beautiful. In the splash at present under consideration it does not always succeed in closing permanently, but opens out as it subsides, and is followed by the emergence of the drop (fig. 8). In fig. 9 the return wave overwhelms the drop for an instant, but it is again seen at the summit of the column in fig. 10.

But on other occasions the shell or dome of figs. 4 and 5 closes permanently over the imprisoned air, the liquid then flowing down the sides, which become thinner and thinner, till at length we are left with a large bubble floating on the water (see Series V, Plate VII). It will be observed that the flow of liquid down the sides is chiefly along definite channels, which are probably determined by the arms thrown up at an earlier stage. The bubble is generally creased by the weight of the liquid along these channels. It must be remembered that the base of the bubble is in a state of oscillation, and that the whole is liable to burst at any moment, when such figures as 6 and 7 of the previous series will be seen.

Such is the history of the building of the bubbles which big rain-drops leave on the smooth water of a lake, or pond, or puddle. It is only the bigger drops that can do it, and reference to the number at the side of fig. 5 of Series IV (Plate VI) shows that the dome is raised in about two-hundredths of a second. Should the domes fail to close, or should they open again, we have the emergent columns which any attentive observer will readily recognize, and which have never been better described than by Mr. R. L. Stevenson, who, in his delightful *Inland Voyage*, speaks of the surface of the Belgian canals along which he was canoeing, as thrown up by the rain into "an infinity of little crystal fountains."

Very beautiful forms of the same type indeed, but different in detail, are those produced by a drop of water falling into the lighter and more mobile liquid, petroleum.

It will now be interesting to turn to the splash that is produced when a solid sphere, such as a child's marble, falls into water.

I found to my great surprise that the character of the splash, at any rate up to a height of fall of 4 or 5 feet, depends entirely on the state of the surface of the sphere. A polished sphere of marble about 0.6 of an inch in diameter, rubbed very dry with a cloth just beforehand and



Time in Seconds.

$\tau = 0$



$r = \cdot 00314$



$r = \cdot 0317$



$r = \cdot 0389$



$\tau = \cdot 0498$



$\tau = \cdot 0551$



$\tau = \cdot 0759$



Time in Seconds.

$\tau = \cdot 0901$



$\tau = \cdot 295$



SERIES III.

THE SPLASH OF A DROP, FOLLOWED IN DETAIL BY INSTANTANEOUS ILLUMINATION.

Diameter of drop, one-fifth inch. Height of fall, 1 foot 5 inches.



dropped from a height of 2 feet into water, gave the figures of Series VI (Plate VIII), in which it is seen that the water spreads over the sphere so rapidly that it is sheathed with the liquid even before it has passed below the general level of the surface. The splash is insignificantly small and of very short duration. If the drying and polishing be not so perfect, the configurations of Series VII (Plate VIII) are produced; while if the sphere be roughened with sandpaper, or left wet, Series VIII (Plate VIII) is obtained, in which it will be perceived that, as was the case with a liquid drop, the water is driven away laterally, forming the ribbed basket-shaped hollow, which, however, is now prolonged to a great depth, the drop being followed by a cone of air, while the water seems to find great difficulty in wetting the surface completely. Part of this column of air was carried down at least 16 inches, and then only detached when the sphere struck the bottom of the vessel.

Figs. 6 and 7 show the crater falling in, but this did not always happen, for the walls often closed over the hollow exactly as in figs. 4 and 5 of Series IV. Meanwhile the long and nearly cylindrical portion below breaks up into bubbles which rise quickly to the surface.

By increasing the fall to 5 feet we obtain the figures of Series IX (Plate IX). The tube of fig. 1 corresponds to the dome of Series IV and V, and is not only elevated to a surprising height, but is also in the act of cleaving (the outline being approximately that of the unduloid of M. Plateau). Figs. 2 and 3 show the bubble formed by the closing up of this tube, weighed down in the center as in figs. 5 and 6 of Series V. Similar results were obtained with other liquids, such as petroleum and alcohol.

It is easy to show in a very striking manner the paramount influence of the condition of the solid surface. I have here a number of similar marbles. This set has been well polished by rubbing with wash leather. I drop them one by one through a space of about 1 foot into this deep, wide, cylindrical glass vessel, lighted up by a lamp placed behind it. You see each marble enters noiselessly and with hardly a visible trace of splash. Now I pick them out and drop them in again (or to save trouble, I drop in these other wet ones); everything is changed. You see how the air is carried to the very bottom of the vessel, and you hear the "*φλοτσβους*" of the bubbles as they rise to the surface and burst. These dry but rough marbles behave in much the same way.

Such are the main features of the natural history of splashes, as I made it out between thirteen and eighteen years ago. Before passing on to the photographs that I have since obtained, I desire to add a few words of comment. I have not till now alluded to any imperfections in the timing apparatus. But no apparatus of the kind can be absolutely perfect, and, as a matter of fact, when everything is adjusted so as to display a particular stage, it will happen that in a succession of observations there is a certain variation in what is seen. Thus the

configuration viewed may be said to oscillate slightly about the mean for which the apparatus is adjusted. Now this is due both to small imperfections in the timing apparatus and to the fact that the splashes themselves do actually vary within certain limits. The reasons are not very far to seek. In the first place the rate of demagnetization of the electro-magnets varies slightly, being partly dependent on the varying resistance of the contacts of crossed wires and partly on the temperature of the magnet, which is affected by the length of time for which the current has been running. But a much more important reason is the variation of the slight adhesion of the drop to the smoked watch glass that has supported it, and consequently of the oscillations to which, as we shall see, the drop is subjected as it descends. Thus the drop will sometimes strike the surface in a flattened form, at others in an elongated form, and there will be a difference, not only in the time of impact, but in the nature of the ensuing splash; consequently some judgment is required in selecting a consecutive series of drawings. The only way is to make a considerable number of drawings of each stage and then to pick out a consecutive series. Now, whenever judgment has to be used there is room for error of judgment, and moreover it is impossible to put together the drawings so as to tell a consecutive story, without being guided by some theory, such as I have already sketched, as to the nature of the motion and the conditions that govern it. You will therefore be good enough to remember that this chronicle of the events of a tenth of a second is presented by a fallible human historian, whose account, like that of any other contemporary observer, will be none the worse for independent confirmation. That confirmation I am fortunately able in some measure to supply. When I endeavored eighteen years ago to photograph the splash of a drop of mercury, I was unable to obtain plates sufficiently sensitive to respond to the very short exposures that were required, and consequently abandoned the attempt. But in recent years plates of exquisite sensitiveness have been produced, and such photographs as those taken by Mr. Boys¹ of a flying rifle bullet have shown that difficulties on the score of sensitiveness have been practically overcome. Within the last few weeks, with the valuable assistance of my colleague at Devonport, Mr. R. S. Cole, I have succeeded in obtaining photographs of various splashes. Following Professor Boys's suggestion, we employed Thomas's cyclist plates, or occasionally the less sensitive "extra-rapid" plates of the same makers, and as a developer, eikonogen solution of triple strength, in which the plates were kept for about forty minutes, the development being conducted in complete darkness.

A few preliminary trials with the self-induction spark produced at the surface of mercury by the apparatus that you have seen at work showed that the illumination, though ample for direct vision, was not

¹ Professor Boys' article on photographs of flying bullets was reprinted in the *Smithsonian Report* for 1893.



Time in Seconds.

$\tau = 0$

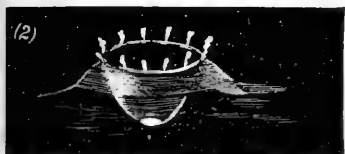

$\tau = .0021$



$\tau = .0042$

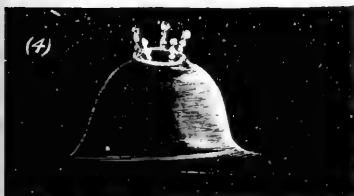

$\tau = .0165$



$\tau = .0206$



Time in Seconds.

$\tau = .0443$



$\tau = .0482$



$\tau = .0595$



$\tau = .0707$



SERIES IV

THE SPLASH OF A DROP, FOLLOWED IN DETAIL BY INSTANTANEOUS ILLUMINATION.

Diameter of drop, one-fourth inch. Height of fall, 4 feet 4 inches.

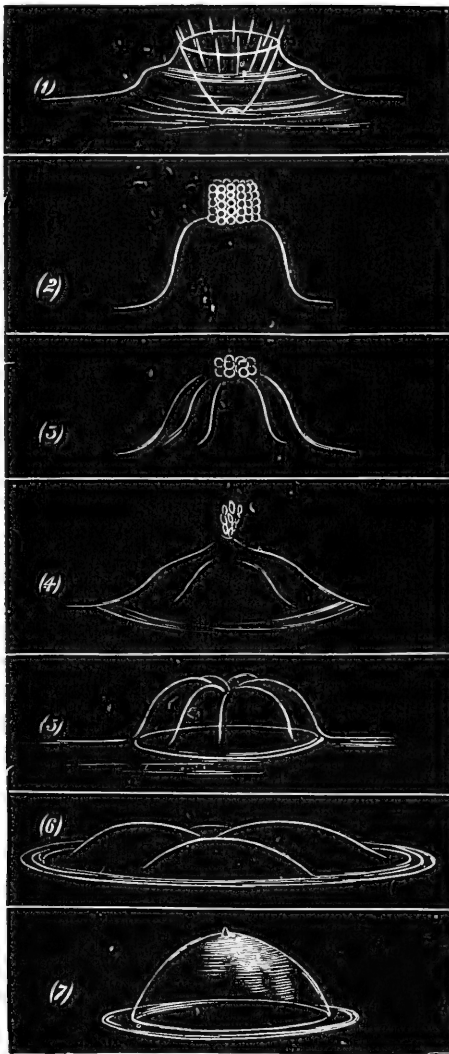

SERIES V.

THE SPLASH OF A DROP, FOLLOWED IN DETAIL BY INSTANTANEOUS ILLUMINATION.

The size of drop and height of fall are the same as before, but the hollow shell (see figs. 4 and 5 of the previous series) does not succeed in opening, but is left as a bubble on the surface. This explains the formation of bubbles when big raindrops fall into a pool of water.



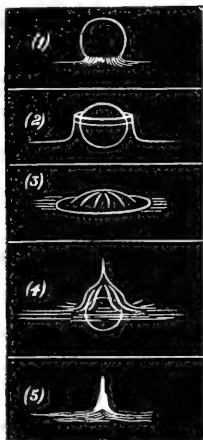

SERIES VI.

WHEN THE SPHERE IS DRY AND POLISHED.

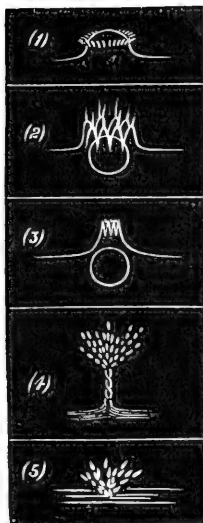

SERIES VII.

WHEN THE SPHERE IS NOT WELL DRIED AND POLISHED.

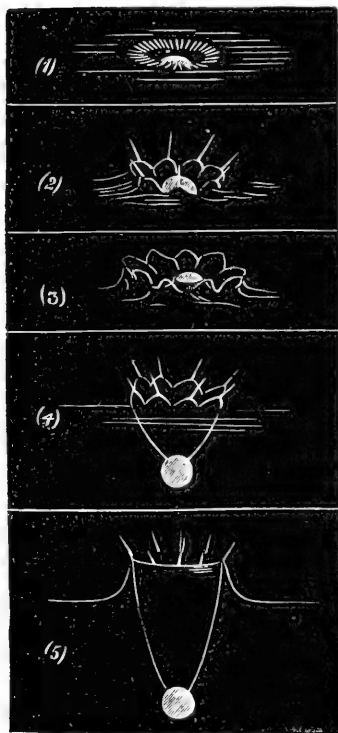

SERIES VIII.

WHEN THE SPHERE IS ROUGH OR WET.

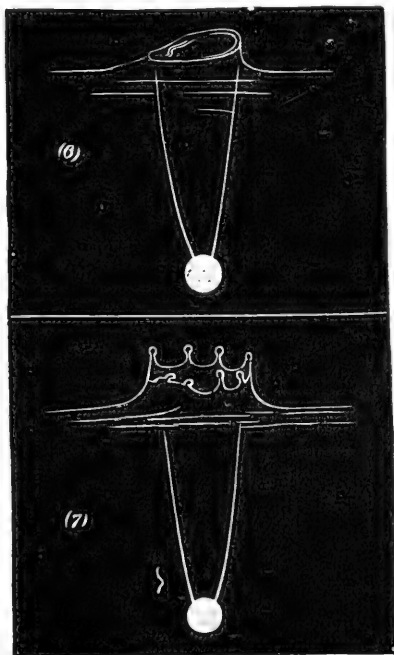

SPLASH OF A SOLID SPHERE (MARBLE HALF INCH DIAMETER, FALLING 2 FEET INTO WATER).

sufficient for photography. When the current strength was increased, so as to make the illumination bright enough for the camera, then the spark became of too great duration, for it lasted for between four and five thousandths of a second, within which time there was very perceptible motion of the drop and consequent blurring. It was therefore necessary to modify the apparatus so as to employ a Leyden-jar spark whose duration was probably less than ten-millionths of a second. A very slight change in the apparatus rendered it suitable for the new conditions, but time does not permit me to describe the arrangements in detail. It is, however, less necessary to do so as the method is in all essentials the same as that described in this room two years ago by Lord Rayleigh in connection with the photography of a breaking soap-film.¹ I therefore pass at once to the photographs themselves.

The first two series (Plates X, XI) may be described as shadow photographs. They were obtained by allowing a drop of mercury to fall onto the naked photographic plate itself, the illuminating spark being produced vertically above it, and they give only a horizontal section of the drop in various stages. The first series corresponds to a mercury splash very similar to that first described, and the second to the splash of a larger drop such as was not described. In each series the tearing of the thin central film to which allusion was made is well illustrated. I think the first comment that anyone would make is that the photographs, while they bear out the drawings in many details, show greater irregularity than the drawings would have led one to expect. On this point I shall presently have something to say.

Comparing the first set of drawings with the photographs of Series X, it will be seen that photograph 2 corresponds to drawing 4 or 5; photograph 3 to that of 9; photograph 4 to that of 18; photograph 6 to that of 20, and photograph 7 to that of 24, but the irregularity of the last photograph almost masks the resemblance.

Series XII (Plate XII) gives an objective view of a mercury splash as taken by the camera. Only the first of this series shows any detail in the interior. The polished surface of the mercury is, in fact, very troublesome to illuminate, and this splash proved the most difficult of all to photograph.

Series XIII (Plate XIII) shows the splash of a drop of milk falling onto a smoked-glass plate, on which it runs about without adhesion, just as mercury would. Here there is much more of detail. In fig. 4 the central film is so thin in the middle that the black plate beneath it is seen through the liquid. In fig. 8 this film has been torn.

Series XIV (Plates XIV, XV) exhibits the splash of a water drop falling into milk. The first four photographs show the oscillations of the drop about a mean spherical figure as it approaches the surface.

¹A detailed account of the optical, mechanical, and electrical arrangements employed, written by Mr. Cole, will be found in *Nature*, Vol. I, page 222 (July 5, 1894).

In the subsequent figures it will be noticed that the arms which are thrown up at first afterward segment into drops which fly off and subside (fig. 8), to be followed by a second series which again subside (fig. 11), to be again succeeded by a third set. In fact, so long as there is any downward momentum the drop and the air behind it are penetrating the liquid, and so long must there be an upward flow of displaced liquid. Much of this flow is seen to be directed into the arms along the channels determined by the segmentation of the annular rim. This reproduction of the lobes and arms time after time, on a varying scale, goes far to explain the puzzling variations in their number which I mentioned in connection with the drawings. I had not, indeed, suspected this, which is one of the few new points that the photographs have so far revealed.

With respect to these photographs,¹ the credit of which I hope you will attribute, first, to the inventors of the sensitive plates, and, second, to the skill and experience of Mr. Cole, I desire to add that they are, as far as we know, the first really detailed objective views that have been obtained with anything approaching so short an exposure.

Even Mr. Boys's wonderful photographs of flying bullets were after all but shadow photographs, and did not so strikingly illustrate the extreme sensitiveness of the plates, and I want you to distinguish between such and what (to borrow Mr. F. J. Smith's phrase) I call an "objective view."

It remains only to speak of the greater irregularity in the arms and rays as shown by the photographs. The point is a curious and interesting one. In the first place, I have to confess that in looking over my original drawings I find records of many irregular or unsymmetrical figures, yet in compiling the history it has been inevitable that these should be rejected, if only because identical irregularities never recur. Thus the mind of the observer is filled with an ideal splash—an "auto-splash"—whose perfection may never be actually realized.

But in the second place, when the splash is nearly regular it is very difficult to detect irregularity. This is easily proved by projecting on the screen with instantaneous illumination such a photograph as that of Series X, fig. 6. My experience is that most persons pronounce what they have seen to be a regular and symmetrical star-shaped figure, and they are surprised when they come to examine it by detail in continuous light to find how far this is from the truth. Especially is this the case if no irregularity is suspected beforehand. I believe that the observer, usually finding himself unable to attend to more than a portion of the rays in the system, is liable instinctively to pick out for attention a part

¹Three of these photographs, viz, Nos. 11, 12, and 17, are reproduced full size (Plate XVI) by a photographic process, to enable the reader to form a more correct idea than can be gathered from the engravings of the amount of detail actually obtained. The black streaks seen in figs. 11, 15, 16, and 17 are due to particles of lampblack carried down by the drop from the smoked surface on which it rested.

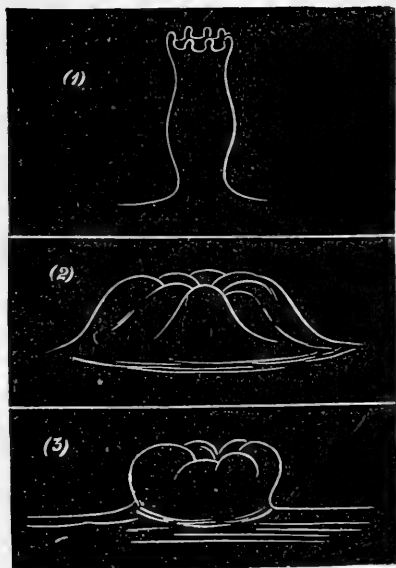

SERIES IX.

WHEN THE SPHERE IS ROUGH OR WET, AND FALLS ABOVE 5 FEET.

SPLASH OF A SOLID SPHERE.

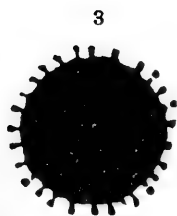
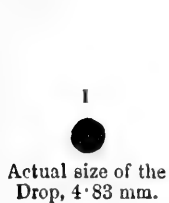

SERIES X.

(1) INSTANTANEOUS SHADOW PHOTOGRAPHS (LIFE SIZE) OF THE SPLASH OF A DROP OF MERCURY FALLING 8 CM. ONTO THE PHOTOGRAPHIC PLATE.

of the circumference where they are regularly spaced and to fill up the rest in imagination, and that where a ray may be really absent he prefers to consider that it has been imperfectly viewed.

This opinion is confirmed by the fact that in several cases I have been able to observe with the naked eye a splash that was also simultaneously photographéd, and have made the memorandum "quite regular," though the photograph subsequently showed irregularity. It must, however, be observed that the absolute darkness and other conditions necessary for photography are not very favorable for direct vision.

And now my tale is told, or, rather, as much of it as the limits of the time allowed me will permit. I think you will agree that the phenomena are very beautiful, and that the details of this transaction, familiar though it has been to all mankind since the world began, have yet proved worthy of an hour's attention.



1

Actual size, 4.83 mm.
in diameter.

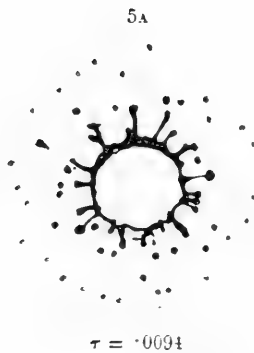
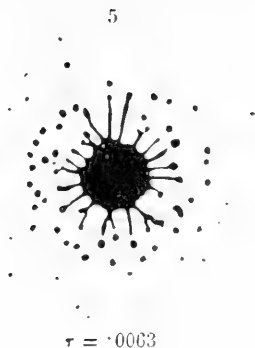
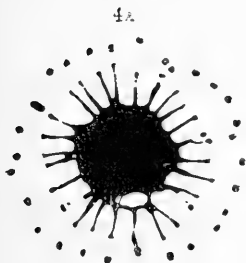
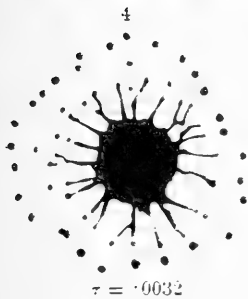

SERIES XI.

(2) INSTANTANEOUS SHADOW PHOTOGRAPHS (LIFE SIZE) OF THE SPLASH OF A DROP OF MERCURY FALLING 15 CM. ONTO GLASS.

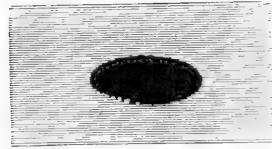
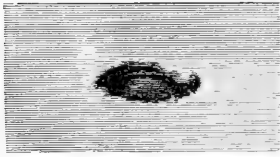

$\tau = 0$

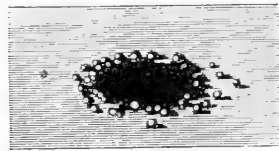
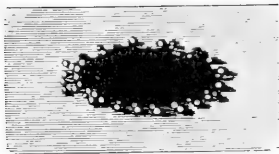
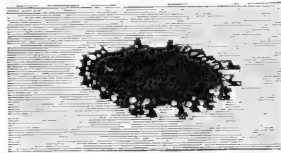
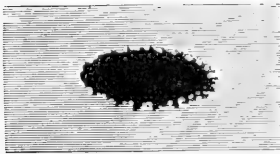

$\tau = \cdot 0195$ sec.

SERIES XII.

ENGRAVINGS FROM INSTANTANEOUS PHOTOGRAPHS (SIXTEEN-SEVENTEENTHS REAL SIZE) OF THE SPLASH OF A DROP OF MERCURY, 4.83 MM. IN DIAMETER, FALLING 8.9 CM. ONTO A HARD POLISHED SURFACE.

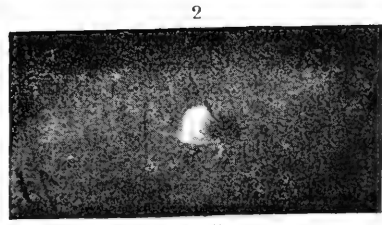
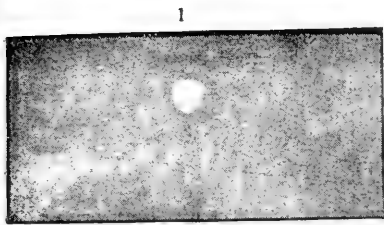

$\tau = 0$

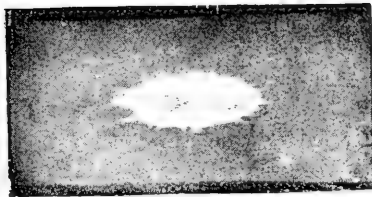

$\tau = .0025$ sec.

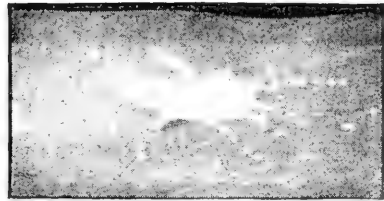

$\tau = .0128$ sec.

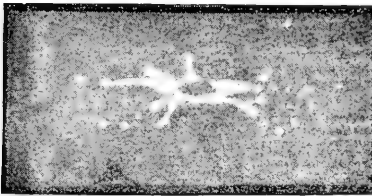

$\tau = .0140$ sec.

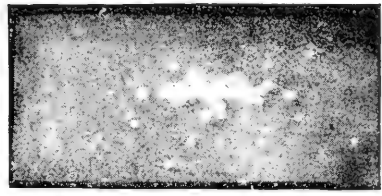

SERIES XIII.

ENGRAVINGS OF INSTANTANEOUS PHOTOGRAPHS (SIXTEEN-SEVENTEENTHS REAL SIZE) OF THE SPLASH OF A DROP OF MILK FALLING 20 CM. ONTO SMOKED GLASS.

(It was not found possible to reproduce satisfactorily the missing figures of this series.)



$\tau = \cdot 0056$ sec.



$\tau = \cdot 0182$ sec.

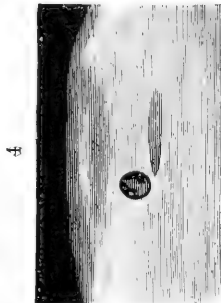
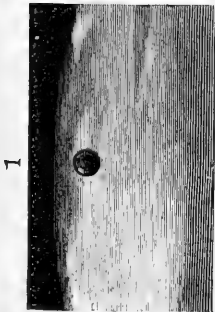
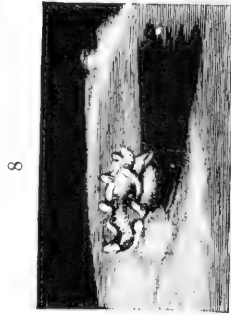
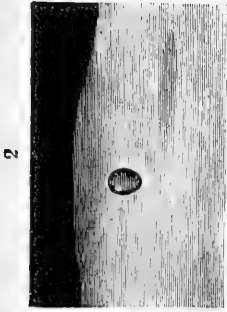

$\tau = 0$



$\tau = \cdot 0163$ sec.

SERIES XIV.

ENGRAVINGS OF INSTANTANEOUS PHOTOGRAPHS OF THE SPLASH OF A DROP OF WATER FALLING 40 CM. INTO MILK.

Scale about six-tenths actual size.

10



$\tau = \cdot 0197$ sec.

13



$\tau = \cdot 0514$ sec.

16

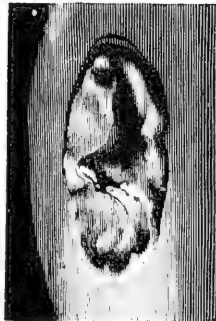

$\tau = \cdot 080$ sec.

11



$\tau = \cdot 0262$ sec.

14



$\tau = \cdot 0601$ sec.

17

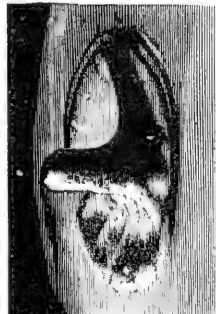

12



$\tau = \cdot 0391$ sec.

15



18



SERIES XIV—CONTINUED.

ENGRAVINGS OF INSTANTANEOUS PHOTOGRAPHS OF THE SPLASH OF A DROP OF WATER FALLING 40 CM. INTO MILK.
Scale about six-tenths actual size.

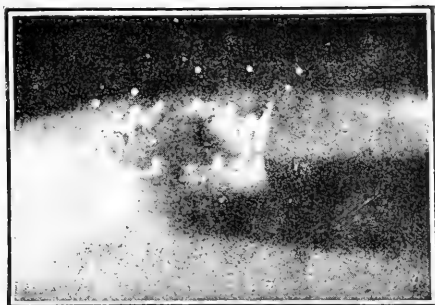

Time after contact = $\cdot 0262$ sec.



Time after contact = $\cdot 0391$ sec.

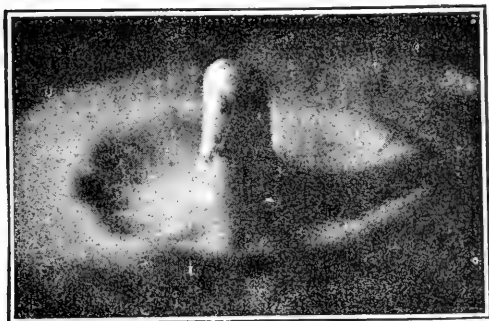

INSTANTANEOUS PHOTOGRAPHS OF A SPLASH OF A WATER DROP FALLING INTO MILK.

THE WASTE AND CONSERVATION OF PLANT FOOD.¹

By HARVEY W. WILEY.

One of the greatest of the practical problems presented for solution by agricultural chemistry is the conservation of plant food. With an abundance of plant food and a favoring climate, it is difficult to place a limit to the power of the earth for supporting life. We have read much in political economy of the limit of subsistence, and one bold philosopher has based a theory of the limitation of the number of human beings upon the earth on the insufficiency of the earth to support a greater number. Happily, however, the Malthusian philosophy was promulgated before the days of that great agricultural renaissance which has been brought about chiefly through the efforts of experimental agricultural chemistry. I am not so blinded by the achievements of agricultural chemistry as to deny to many other branches of science an important and, in many cases, necessary influence in this development of agricultural science; but I think every candid man will admit that in this development chemistry has always taken the front rank and led the way. This is preeminently true of the investigations into the nature and extent of the plant food available on the surface of the earth.

In this country, owing to the great stores of wealth which the past had accumulated in the soil, it is only within recent years that the question of the supply of plant food has assumed any practical importance. As long as there were virgin fields at the disposal of the agricultural rapist, the conservation and restoration of exhausted fields were of little consequence. The result has been that the wealth of hundreds or perhaps thousands of years slowly stored in the soil has been poured forth in a century, not only for the enrichment of this country but for the benefit of all countries. Unfortunately, or fortunately, these stores are now practically explored and there is little left in this land of virgin fertility to tempt the farmer to new conquests. Not only have these stores of plant food been utilized but, much to the discredit of the American farmer, they have been wasted. The mark of good agriculture is to see fields yielding annually good returns and

¹ Retiring address of the president of the American Chemical Society, Baltimore meeting, December 27, 1893. From the *Journal of the American Chemical Society*, Vol. XVI, No. 1, January, 1894.

increasing, or at least not lessening, in fertility. This being true, the history of American agriculture to within a few years must be the history of bad farming, for everywhere we have seen fertile fields losing their fertility and farms once productive abandoned. No difference how great the store may be, if it be continually drawn upon and never replenished the day will sometime come when it will be exhausted. This day has come to a large portion of the agricultural lands of this country, and to-day there is an awakening everywhere in regard to the best methods of checking the waste and of restoring what has been lost.

I desire for a brief period, on this occasion, to call the attention of the chemists of this country to some of the methods by which plant food is removed from the fields and some of the direct and indirect ways in which it is and may be returned. On a former occasion¹ I have discussed the extent to which plant food is removed from the soil directly in the crops and the dangers which arise to an agricultural community which continually exports its agricultural products. On that occasion I pointed out the amount of potash, phosphoric acid, and nitrogen per acre annually removed by the crops of the United States, and showed that the only safe agricultural products to send out of a country were sugar, oil, and cotton. It is true that with native, unexhausted soils a country may acquire great wealth by agricultural exports, but the history of the world shows that a country which depends for its wealth and its commerce on agricultural exportation is in the end reduced to pauperism. A single example may serve to accentuate this remark; I refer to the island of Cyprus, which two thousand years ago was the granary of many cities bordering on the Mediterranean Sea. Supplying hundreds of thousands of people with corn, it gradually became impoverished, and to-day its soils are perhaps the poorest of any known.

The waste to which I desire to call your attention to-day is not that which normally takes place in the production of a crop, but that which is incidental to the cultivation of the soil and to a certain extent unavoidable. My purpose is to develop, if it be possible, the relations of agricultural chemistry to this waste, with the purpose of pointing out a course by which it can be returned and in what way we may at least reduce to a minimum the unavoidable removal of valuable plant food. You have all, perhaps, surmised the character of this waste; I refer to the denudation of fields by water and to the removal of soluble plant food by the percolation of water through the soil.

The losses due to the denudation of fields are purely of a mechanical character. The natural forest, or the natural covering of grass over an area of soil, prevents to a large extent the denudation due to heavy downpours of rain. The removal of the forest and the destruction of the grass by cultivation leave the soil in a condition in which it is

¹Vice-presidential address before the American Association for the Advancement of Science, Buffalo, 1886.

unable to resist the action of flowing surface water. The muddy character of the water in all streams bordering on cultivated hilly fields after a heavy rain storm is a familiar instance of the tremendous energies which are exerted by a heavy downpour of rain in the carrying of the soil into the streams and its transportation toward the sea.

It is not necessary to emphasize the fact that the agricultural chemist is practically powerless to prevent the surface erosion due to heavy rains, but a few practical lessons derived from the application of chemical discoveries to the soils show how, in a certain measure, even surface erosion may be controlled, or at least reduced to a minimum by the application of the principles of culture founded upon the facts disclosed by advanced science.

The observing agriculturist will have noticed that even in a hilly country a soil in situ underlain by limestone is less likely to be cut up by gullies than a soil similarly situated and deficient in carbonate of lime. The reason of this is plain. In a soil deficient in lime the clays when once brought into suspension by moving water assume a semi-colloid state and remain indefinitely in suspension. Clays, on the other hand, which are heavily impregnated with lime salts are in a flocculated state, and the larger aggregates thus produced settle quickly. The result of this is that such a soil is less easily moved by water, and a field thus treated less exposed to washing by heavy rains.

Our knowledge of flocculation and its physical and chemical results is due largely to the investigations of Shulze, Schloesing, and Hilgard, and the results of their researches have shown in a most emphatic way the beneficial changes which take place, especially in stiff clay soils, by the application of lime.

It is thus an incontrovertible fact that the surface washing of cultivated fields, especially if they be naturally deficient in lime, could be greatly diminished and has been greatly diminished by the free application of this substance.

The change in the physical condition of the soil, which is produced by the lime, is also another important factor worthy of consideration. A stiff clay soil is almost impervious to the penetration of surface water and thus the amount which is carried off is raised to a maximum. A well-limed soil, on the contrary, in which the particles are perfectly flocculated, is much more pervious and the amount of water which will be retained and delivered gradually to vegetable growth is much greater. Thus the beneficial effects of lime are manifested in both ways—in the better retention of the flocculated clays and in increasing the capacity of the soil for holding a given amount of water in its interstitial spaces.

There are many other salts which also have the same properties as those of lime, but I have spoken of lime salts chiefly because they are cheaper and therefore more economically applied. Perhaps next to lime, common salt would be the most efficient in producing the results already described; but common salt being extremely soluble would

soon be leached out of a soil. On the other hand, lime, even when supplied as hydrate, in which case it is somewhat soluble, quickly becomes converted into a carbonate which is practically insoluble in water which does not contain an excess of carbon dioxide.

I am aware of the fact that liming to prevent erosion by surface drainage has not been emphasized as an example of the benefit of the proper chemical treatment of soils, yet I feel sure that all who will give the subject a thoughtful consideration will agree with me in saying that this aspect of the subject is one of no small importance, especially when considered in respect of hilly fields, and even of fields of more level surface.

Without dwelling long upon this point, it is only necessary to call your attention to the immense quantities of soil material annually conveyed to the sea by the causes of erosion already mentioned to show what an active and powerful foe the farmer has in this source of loss. Anyone who watches, even for a short time, the volume of water carried by the Mississippi into the Gulf of Mexico will have a most effective object lesson in regard to this source of loss.

A more striking lesson may be seen in the hill regions bordering both banks of the Ohio River. Hundreds of fields once covered with sturdy forests of oak, maple, and walnut, and afterward bearing large crops of maize, tobacco, and wheat, may now be seen furrowed with gullies, as with the wrinkles of age, and abandoned to brush and briars. The same is doubtless true of other hill regions, but I speak the more advisedly of those which have come under my personal observation.

Great, however, as the mechanical loss of plant food is, it is by no means as dangerous as the loss of the soluble materials caused by the percolation of the water through the soil. The study of the nature of the loss of these soluble materials, together with the estimation of their amount, forms the subject of lysimetry. Agricultural chemists have used many devices for the purpose of determining the character and amount of the natural drainage of soils. Evidently the treatment of a specially prepared portion of soil by any solvent, although giving interesting results, does not indicate the natural course of solution. The only way in which this can be determined is to be able to collect, measure, and study the character of the drainage from a given portion of the arable surface of the earth in situ and under normal conditions. Various methods of lysimetric investigation have been proposed and used, all of them possessing many points of value.

An excellent system of such observation has been established, for instance, at the Agricultural Experiment Station of Indiana. It is not my purpose, however, to discuss the mechanical details of lysimetry, but only to call your attention to the main principles which underlie it. The movement of water near the earth's surface is a matter of especial interest to agriculturists. Whitney¹ has clearly pointed out that the

¹"Some physical properties of soils," United States Weather Bureau, Bulletin No. 4.

little excess or deficiency of water is of far more importance to the growing crop than the quantity of the excess or deficiency of its other foods. Soils richest in plant food will produce a small harvest if there be a great excess or deficiency of water, while soils which are poor in plant food will produce an abundant crop if the water be present in proper amounts and have proper and timely access to the rootlets of the plant. The study, therefore, of the water movement in the soil, whether laterally, upward, or downward, is of the utmost practical importance. The methods of a study of this kind have been well established by King.¹

The plant food of the soil, it is well understood, only has access to the absorbent organs of the plant when presented in a proper soluble or semisoluble form in connection with water. From a chemical standpoint, in connection with the subject under discussion, the movement of water in the soil should be considered in connection, not alone with its power of dissolving plant foods, but with especial reference to its power of carrying them not only away from the reach of the roots of the plant, but even out of the field and into the streams and rivers and eventually into the sea. For our present purpose, therefore, we have only need to examine lysimetric observations for the purpose of determining the kinds of plant food which are most exposed to waste. It is not my purpose to take your time here with a vast array of figures, but I desire only to call your attention to the fact that of the chief plant foods potash and the nitrates are the ones which are most exposed to loss.

The earliest systematic investigations of the quantity and composition of drainage were commenced at the Rothamsted Station by Lawes and Gilbert,² in 1870. Lysimeters were constructed for the collection of the drainage water from 30, 40, and 60 inches depth of soil, respectively, the soil and subsoil being kept in the natural state of aggregation.

Lawes and Gilbert call attention to the fact that probably at the Rothamsted Station not more than 5 pounds of nitrogen are secured per acre each year from the atmosphere and the rain water, while the average loss of nitrogen through the drainage water is over 30 pounds per acre. The quantity of course varies with the amount of rainfall and the activity of nitrification. They speak of the possible exaggeration of the loss of nitrogen on account of the fact that the air had access to the soil both from below and above, and therefore the process of nitrification where the lysimeters were placed might have been intensified.

Among the latest researches on this subject are those of Deherain.³ It is pointed out by this author that the character of the crop grown upon the cultivated field has much to do with the determination of the

¹ Ninth Annual Report of the Wisconsin Experiment Station, page 129 et seq.

² Jour. Roy. Agri. Soc., vol. 17, pages 241-279 and 311-350; Vol. 16, pages 1-71.

³ Annales Agronomiques, February 25, 1893, page 65 et seq.

loss of nitrogen per acre. Those crops which require an immense amount of moisture for their growth, such as the sugar beet, would tend thereby to prevent the loss of nitrogen in the drainage waters, the nitrates being stored in the beet instead of being given up to percolation. In general, it may be said that it is the quantity of the drainage water rather than its richness in nitrates which determines the total loss due to percolation, and from this it may be inferred that the loss by drainage is directly proportional to the rainfall and inversely proportional to the magnitude of the harvest. The season at which the greatest loss takes place is also, therefore, the one in which the growth of the plant is the least vigorous, provided that the vigor of nitrification and quantity of rainfall remain the same. When plants grow vigorously and when they occupy the soil for a long time, the losses due to drainage are reduced to a minimum. On the other hand, with plants which rapidly ripen, so that the harvest follows soon after the sowing, the losses are greater. The farmer, therefore, who suffers a failure of his crop, not only loses from the smallness of the harvest, but also by the percolation of the water through the soil. For this reason it is obvious that leaving fields fallow is a very dangerous proceeding. Deherain found that fallow fields during the season lost as high as 50 kilograms of nitrogen per hectare, corresponding to 330 kilograms of nitrate of soda, worth 76 francs. These figures show plainly the magnitude of the losses which take place in the one item of nitrogen alone, due to the percolation of rain water through the soil.

In this connection it may be of interest again to refer to the favorable action of lime in a great many soils in regard to its power of increasing the ability of a soil to hold the soluble plant foods against their removal by water. This favorable action is particularly manifested in many soils in the power of lime to increase their capacity for holding potash.

Warington explains this action of the lime salts, especially the carbonate, by suggesting that by combining with the acids of certain salts, as the carbonates, sulphates, chlorides, and nitrates, they allow the bases of these salts to unite with the hydrated metallic oxides. The carbonate of lime also converts the soluble acid phosphates, applied in manure, to the sparingly soluble calcium phosphates, which, as they gradually enter into solution, are converted into ferric and aluminic phosphates. An admirable description of the absorptive power of soils has been given by Warington,¹ and many other authors have also discussed this matter in detail.

We can see from the data given above how water continually acts upon a soil in the removal of certain soluble plant foods. It might be inferred from this that all arable soils exposed continually to rains would soon be exhausted of all valuable soluble plant food. But it has also been pointed out how certain constituents of the soil have a faculty

¹Practice with Science, page 2.

of absorbing and retaining materials which are soluble in water under ordinary conditions. It must not be forgotten also that the rain water which descends upon the earth is not pure. Rain water brings to the earth a certain amount of valuable plant food. Not only does it absorb and hold in solution ammonia and nitric acid, which may be formed by the electrical discharges in the air, but it also collects and brings to the surface of the earth vast quantities of meteoric dust containing valuable fertilizing principles. Thus we have constantly entering the soil water which contains more or less of the materials necessary to plant growth. Even the drainage waters, which leave an arable field, may not reach the sea without giving up much of this material. The drainage waters in passing underneath the earth's surface take devious courses and are often brought near to the surface again or are poured upon soils which are quite different in their texture from those furnishing the materials in solution. Sterry Hunt¹ has pointed out how such waters sooner or later come upon permeable strata by which they are absorbed and in their subterranean circulation undergo important changes. Especially when these waters reach argillaceous strata their content of neutral, soluble salts may suffer great changes. Such waters, charged with organic and mineral materials, contain, usually, large amounts of potassium salts and notable quantities of silica and phosphates and in many cases ammoniated salts and nitrites or nitrates.

The experiments of Way, Voelcker, and others have shown that in contact with argillaceous sediments these waters give up their potash, ammonia, silica, phosphoric acid, and organic matter, which remain in combination with the soil; on the other hand, soda, magnesia, sulphuric acid, and chlorine are not removed from the drainage waters. Eichorn attributes this power of selective absorption in the soil chiefly to the action of hydrated double aluminum silicates, and supposes that the process is one of double exchange, equivalents of lime or soda being given up for the potash retained. By this power of selective absorption the mineral matters required for the growth of plants tend to be retained in most soils, while those not required for the growth of plants are removed. Nevertheless, much of the valuable mineral material in solution must escape absorption and finally find its way into the streams, rivers, and seas.

From the foregoing summary of the methods of waste of plant food it has been seen that in spite of all the precautions of the farmer and the chemist, and in spite of the selective absorption of the soil, immense quantities of valuable plant food are carried into the sea, where apparently they are lost to agriculture forever. But this is only an apparent loss. The economies of nature are so happily adjusted as to provide a means of gradually returning in some form or other to the power of the farmer the plant food which has been apparently destroyed. It is true that this return will probably not be to the locality where the waste

¹ Chemical and Geological Essays, page 95.

originally occurred, and it may not take place until after the lapse of thousands of years, but this is of no consequence. Provided arable lands in general receive in some way and at some time a certain return for the plant food removed, it is entirely immaterial whether this be the original plant food removed or other equally as good.

The sea is the great sorting ground into which all this waste material is poured. The roller processes of nature, like the mills of the gods, grind exceedingly slow and small, and the sea becomes the bolting cloth by which the products of milling are separated and sorted out. As soon as this waste material is poured into the sea, the process of sorting at once begins. The carbonate of lime becomes deposited in vast layers, or by organic life is transformed into immense coral formations or into shells. Phosphoric acid is likewise sifted out into phosphatic deposits or passes into the organic life of the sea. Even the potash, soluble as it is, becomes collected into mineral aggregates or passes into animal or vegetable growth. All these valuable materials are thus conserved and put into a shape in which they may be returned sooner or later to the use of man. In the great cosmic economy there is no such thing as escape from usefulness of any valuable material.

Sterry Hunt¹ has called especial attention to this sifting and sorting power of water and the important part it plays in the formation of crystalline rocks. "Igneous fusion," he says, "destroys the mineral species of the crystalline and brings them back as nearly as possible to the great primary and undifferentiated material. This is the great destroyer and disorganizer of mineral as well as of organic matter. Subterranean heat in our time, acting on buried aqueous sediments, destroys carbonates, sulphates, and chlorides with the evolution of acidic gases and the generation of basic silicates, and thus repeats in miniature the conditions of the anteneptunian chaos. On the other hand, each mass of cooling igneous rock in contact with water begins anew the formative process. The hydrated amorphous product palagonite is, if we may be allowed the expression, a sort of silicated protoplasm, and by its differentiation yields to the solvent action of water the crystalline silicates which are the constituent elements of the crenitic rocks, leaving at the same time a more basic residuum abounding in magnesia and iron oxide and soluble not by crenitic but subaerial action."

Let me call attention, for a few moments, to some of the more important ways, pointed out through the researches of agricultural chemists, in which these waste products are restored. We are inclined to look upon the sea as devoid of vegetable growth, but the gardens of the sea are no less fully stocked with economic plants than the gardens of the land. The seaweeds of all genera and species are constantly separating valuable materials from the waters of the ocean and placing them again in organic form. Many years ago Forchhammer² pointed out the

¹Mineral Physiology and Physiography, page 188.

²J. prakt. Chem., 1st series, Vol. 38, page 388.

agricultural value of certain fucoids. Many chemists have contributed important data in regard to the composition of these bodies. Jenkins¹ gives analyses of several varieties of seaweed, showing that in the green state it is quite equal to stall manure. The farmers are said to pay as high as 5 cents a bushel for it. Goessmann² also gives analyses of several varieties of seaweed. We are indebted, however, to the reports of Wheeler and Hartwell³ for the fullest and most systematic discussion of the agricultural value of seaweeds which has been published. Their interesting and elaborate report was published in January, 1893. Those who are interested in the details of this work can find all known publications on the subject properly arranged, classified, and studied in the publication mentioned. We learn from this publication that seaweed was used as a fertilizer as early as the fourth century, and its importance for this purpose has been recognized more and more in modern days, especially since chemical investigations have shown the great value of the food materials contained therein.

To show the commercial importance of seaweed as a fertilizer it is only necessary to call attention to the fact that in 1885 its value for use in the State of Rhode Island was \$65,044, while the value of all other commercial fertilizers was only \$164,133. While seaweed, in a sense, can only be successfully applied to littoral agriculture, yet the extent of agricultural lands bordering on the sea is so great as to render the commercial importance of the matter of the highest degree of interest.

It is not my intention here to enter into the discussion of the methods of preparing the seaweed, the times at which it should be gathered, and the best means of applying it to the soil. These matters are all thoroughly discussed by Wheeler and Hartwell in the publication mentioned. As an instance of the value of seaweed at a point far removed from the Rhode Island coast, I may be permitted to say that near the mouth of the Caloosahatchee River, at the town of Fort Meyers, I saw the most happy effects produced in intensive culture by the application of seaweed alone to the sandy soils bordering on this arm of the sea. Dr. Washburn, of the Florida Experiment Station, was conducting the experiments to which I refer, and he spoke in the highest terms of the value of the seaweed in his work. Thousands of tons of this seaweed are allowed to go to waste annually along these shores, simply because the agriculturist has not been informed in regard to its fertilizing value.

There are many other uses for seaweed besides the agricultural one, but in these we are not much interested except incidentally. Many of the varieties of sea grass are used for filling mattresses, cushions, etc. Other varieties are burned and their ashes used for the manufacture

¹ Annual Report Connecticut State Experiment Station, 1890, page 72.

² Annual Report Massachusetts State Experimental Station, 1887, page 223.

³ Rhode Island Experiment Station Bulletin, 21.

of soda, iodine, and bromine. The gelatinous portions of seaweeds become exceedingly hard and elastic upon being dried, and have been moulded into various forms as substitutes for horn and shells in making handles for knives, files, and other tools. In the *Techno-Chemical Receipt Book*, on page 177, may be found receipts for making artificial ebony from the charcoal obtained from seaweeds, also for making leather, soap, and glue. For the latter purpose the plants are dried and powdered, extracted with warm water, with or without the addition of alcohol. The solution is allowed to settle at a temperature of 120° F. When cool it forms a jelly, which is used for various purposes. The direction is then given for making transparent seaweed leather, opaque seaweed leather, seaweed soap, and seaweed glue. •

No attempt can be made to give the quantities of seaweed which are annually cast upon the shores of the different continents. Perhaps Rhode Island is no more favored in this respect than any other locality, and we have seen the value of the seaweed which was gathered for agricultural purposes in that State alone. The amount gathered represents only a very small fraction of the amount which was thrown upon the shores. It is easy therefore to conclude that the quantities of nitrogen, phosphoric acid, and potash annually removed from the seas by the plants living therein are no less great in magnitude than those removed from the land by crops and plants of all kinds.

But seaweed and other vegetable products of the sea are not the only vehicles in which the plant food in solution in the waters of the ocean may be returned to the uses of man. The animal life of the ocean is not less important than that of the land. In the animal economy of the ocean are gathered, therefore, immense quantities of valuable food material which are thus placed in a condition to be at least in part restored in the form of food. Relatively, phosphoric acid and nitrogen are restored in much greater quantities than potash. The composition of fish in general shows that relatively larger quantities of phosphoric acid and nitrogen are found than of fat and potash. The chemical composition of the nutritive portion of fishes has been thoroughly investigated by Atwater.¹

The percentage of phosphoric acid in the flesh of American fishes in its fresh state is about one-half of 1 per cent. In one instance, that of smelt, Atwater found 0.81 per cent in the flesh of the fish. In the water-free substance of the flesh the percentage of phosphoric acid in round numbers is 2.5. In the case of the smelt, above mentioned, it amounted to 5.49 per cent. When it is considered that the bones and other refuse of the fish, presumably richer in phosphoric acid than the flesh, were not included in this investigation, the quantity of phosphoric acid in fish is distinctly brought to view.

¹“The chemical composition and nutritive values of food fish and aquatic Vertebrates,” by W. O. Atwater. Report of the United States Commissioner of Fish and Fisheries 1888, pages 679-868.

The quantity of albuminoids in the water-free substance of the flesh of fish is enormously high as compared with that of ordinary foods. In round numbers it may be said to be about 75 per cent of the total water-free substance. In some cases the albuminous matter, or in other words the protein, makes up almost the whole of the water-free substance, as in the case of a brook trout, quoted by Atwater, in which the percentage of protein in the dry flesh was 93.25; and of a perch, in which it was 93.33; and of a sea bass, in which it was 95.88; and a red snapper, in which it was 95.38, and others in which even a higher percentage was reported.

It is thus seen that the ordinary fishes of the ocean collect especially the two great elements of plant food, phosphorus and nitrogen.

Oysters and other shellfishes collect not only large quantities of phosphorus and nitrogen, but also larger quantities of carbonate of lime. As has been intimated in another place, it is entirely probable that in earlier times, when the sea was richer in phosphoric acid than at present, considerable quantities of phosphate of lime may have been secreted with the carbonate of lime in the shell. At the present time, however, the phosphate of lime has almost or quite disappeared from the matters of which shells are composed.

While the art of fishing is practiced chiefly for the purpose of gaining human food, yet in many large fishing districts the fish waste becomes valuable fertilizing material. Some kinds of fish, as the menhaden, are, however, collected chiefly for their fertilizing value. The use of fish for fertilizing purposes is not new. A most interesting description of the use of agricultural fertilizers by the American Indians is given by Goode.¹ As long ago as 1875 the value of the nitrogen derived from the menhaden was estimated to be about \$2,000,000. In the year 1878 it is estimated that 200,000 tons of menhaden were captured between Cape Henry and the Bay of Fundy. The oil is first extracted from the fish for commercial purposes and afterward the residue is dried and ground and sold to farmers and fertilizer manufacturers. For a complete history of the menhaden the articles of Prof. G. Brown Goode in the Report of the United States Commissioner of Fish and Fisheries for 1877 and 1879 may be consulted.

The honor of teaching the American colonists the use of artificial fertilizers belongs, without doubt, to an Indian named Squanto. In Governor Bradford's History of Plymouth Plantation is given an account of the early agricultural experiences of the Plymouth colonists. In April, 1621, at the close of the first long, dreary winter, "they (as many as were able) began to plant their corne, in which service Squanto (an Indian) stood them in great stead, showing them both ye manner how to set it, and after how to dress and tend it. Also he tould them, axceptè they got fish and set with it (in these old grounds) it would come to nothing; and he showed them yt in ye middle of April,

¹American Naturalist, vol. 14, July, 1880, No. 7, page 473 et seq.

they should have store enough come up ye brooke by which they begane to build and taught them how to take it."¹

Another account mentioned by Goode of the practice of the Indians in this respect may be found in George Mourt's Relation or Journal of the Beginning and Proceedings of the English Plantation Settled at Plimouth in New England, by Certain English Adventurers, both Merchants and others, London, 1622. "We set the last spring some twenty acres of Indian corn, and sowed some six acres of barley and pease, and, according to the manner of the Indians, we manured our ground with herrings, or rather shads, which we have in great abundance and take with great ease at our doors. Our corn did prove well, and God be praised, we had a good increase of Indian corn, and our barley indifferent good."²

Thomas Morton, in his New England Canaan, London, 1632, wrote of Virginia: "There is a fish (by some called shadds, by some, allizes,) that at the spring of the yeare passe up the rivers to spawn in the pond, and are taken in such multitudes in every river that hath a pond at the end that the inhabitants doung their ground with them. You may see in one township a hundred acres together, set with these fish, every acre taking 1,000 of them, and an acre thus dressed will produce and yield so much corn as three acres without fish; and (least any Virginea man would infere hereupon that the ground of New England was barren, because they use more fish in setting their corne, I desire them to be remembered, the cause is plaine in Virginea) they have it not to sett. But this practice is onely for the Indian maize (which must be set by hands), not for English grain; and this is, therefore, a commodity there."

The following amusing study quoted by Goode is taken from the records of the town of Ipswich, May 11, 1644: "It is ordered that all the doggs for the space of three weeks from the publishing hereof, shall have one legg tyed up, and if such a dog shall break loose and be found doing harm the owner of the dogg shall pay damage. If a man refuse to tie up his dogg's legg, and hee bee found scraping up fish in a cornfield, the owner thereof shall pay twelve pence damage beside whatever damage the dogg doth. But if any fish their house lotts and receive damage by doggs, the owners of these house lotts shall bear the damage themselves."

The practice of using fish, therefore, for fertilizing purposes is many centuries old, but until recent years the farmers residing along the coast were the only ones who received any benefit therefrom; but since the more careful scientific study of the value of fish fertilization, the nitrogenous elements taken from the sea by the fish now find their way not only to the gardens and truck farms along the New England and New Jersey coasts but also to the wheat fields of Ohio and the cotton fields of North Carolina.

¹Coll. Mass. Hist. Soc., 4th series, No. 3, 1856, page 100.

²Coll. Mass. Hist. Soc., 2d series, No. 9, 1832, page 60.

CONSERVATION OF NITROGEN.

Attention has been called to the manner in which the nitrogen carried into the ocean by the waste of the land is returned in great part through the marine, vegetable, and animal life. Immense quantities of waste nitrogen, however, are further secured, both from sea and land, by the various genera of birds. The well-known habits of birds in congregating in rookeries during the nights, and at certain seasons of the year, tends to bring into a common receptacle the nitrogenous matters which they have gathered and which are deposited in their excrement and in the decay of their bodies. The feathers of birds are particularly rich in nitrogen, and the nitrogenous content of the flesh of fowls is also high. The decay, therefore, of remains of birds, especially if it take place largely excluded from the leaching of water, tends to accumulate vast deposits of nitrogenous matter. If the conditions in such deposits are favorable to the processes of nitrification the whole of the nitrogen, or at least the larger part of it, which has been collected in this débris, becomes finally converted into nitric acid and is found combined with appropriate bases as deposits of nitrates. The nitrates of the guano deposits and of the deposits in caves arise in this way. If these deposits are subject to moderate leaching the nitrate may become infiltrated into the surrounding soil, making it very rich in this form of nitrogen. The beds and surrounding soils of caves are often found highly impregnated with nitrates.

While for our purpose deposits of nitrates only are to be considered which are of sufficient value to bear transportation, yet much interest attaches to the formation of nitrates in the soil, even when they are not of commercial importance.

In many soils of tropical regions not subject to heavy rainfalls the accumulation of these nitrates is very great. Müntz and Marcano¹ have investigated many of these soils to which attention was called first by Humboldt and Boussingault. They state that these soils are incomparably more rich in nitrates than the most fertile soils of Europe. The samples which they examined were collected from different parts of Venezuela and from the valleys of the Orinoco as well as on the shore of the Sea of Antilles. The nitrated soils are very abundant in this region of South America, where they cover large surfaces. Their composition is variable, but in all of them carbonate and phosphate of lime are met with and organic nitrogenous material. The nitric acid is found always combined with lime. In some of the soils as high as 30 per cent of nitrate of lime has been found. Nitrification of organic material takes place very rapidly the year round in this tropical region. These nitrated soils are everywhere abundant around caves, as described by Humboldt, caves which serve as the refuge of birds and bats. The

¹Compt. Rend., 101, 1885, page 65 et seq.

nitrogenous matters which come from the decay of the remains of these animals form true deposits of guano, which are gradually spread around, and which, in contact with the limestone and with access of air, suffer complete nitrification with the fixation of the nitric acid by the lime.

Large quantities of this guano are also due to the débris of insects, fragments of elytra, scales of the wings of butterflies, etc., which are brought together in those places by the millions of cubic meters. The nitrification which takes place in these deposits has been found to extend its products to a distance of several kilometers through the soil. In some places the quantity of the nitrate of lime is so great in the soils that they are converted into a plastic paste by this deliquescent salt.

It is suggested by the authors that the coexistence of the nitrate and phosphate of lime is sufficient in all cases to demonstrate the organic origin of the nitric acid. It would not be possible to attribute such an origin to the nitrate present in these soils if it could not be determined that it was thus associated with phosphate and other remains, the last witnesses of a former animal life.

As a result of the observations of Müntz and Marcano, they conclude that it is not proper to accredit to the electrical discharges in the atmosphere the origin of the nitric acid forming these deposits, although they admit primarily the source of the nitric acid may have been due to electricity, but that it first was passed through the organism of the plant and thence into that of the animal, whence it is accumulated in the deposits referred to.

The theory of Müntz and Marcano in regard to the nitrates of soils, especially in the neighborhood of caves, is probably a correct one, but there are many objections to accepting it to explain the great deposits of nitrate of soda which occur in many parts of Chile. Another point which must be considered also is this: That the processes of nitrification can not now be considered as going on with the same vigor as formerly. Some moisture is necessary to nitrification, as the nitrifying ferment does not act in perfectly dry soil, and in many localities in Chile where the nitrates are found it is too dry to suppose that any active nitrification could now take place.

The existence of these nitrate deposits has long been known.¹ The old Indian laws originally prohibited the collection of the salt, but nevertheless it was secretly collected and sold. Up to the year 1821 soda saltpeter was not known in Europe except as a laboratory product. About this time the naturalist Mariano de Rivero found on the Pacific Coast, in the province of Tarapaca, immense new deposits of the salt. Later the salt was found in equal abundance in the Territory of Antofagasta and farther to the south in the desert of Atacama, which forms the Department of Taltal.

¹A most interesting article on the subject may be found in *Jour. Roy. Agric. Soc.*, 1852, Vol. 13, page 349 et seq.

At the present time the collection and export of saltpeter from Chile is a business of great importance. The largest export which has ever taken place in one year was in 1890, when the amount exported was 927,290,430 kilograms; of this quantity 642,506,985 kilograms were sent to England and 86,124,870 kilograms to the United States. Since that time the imports of this salt into the United States have largely increased.

According to Pissis¹ these deposits are of very ancient origin. This geologist is of the opinion that the nitrate deposits are the result of the decomposition of feldspathic rocks; the bases thus produced gradually becoming united with the nitric acid provided from the air.

According to the theory of Nöhlner² the deposits are of more modern origin and due to the decomposition of marine vegetation. Continuous solution of soils beneath the sea gives rise to the formation of great lakes of saturated water, in which occurs the development of much marine vegetation. On the evaporation of this water, due to geologic isolation, the decomposition of nitrogenous organic matter causes generation of nitric acid, which, coming in contact with the calcareous rocks, attacks them, forming nitrate of calcium, which, in presence of sulphate of sodium, gives rise to a double decomposition into nitrate of soda and sulphate of calcium.

The fact that iodine is found in greater or less quantity in Chile saltpeter is one of the chief supports of this hypothesis of marine origin, inasmuch as iodine is always found in sea plants and not in terrestrial plants. Further than this, it must be taken into consideration that these deposits of nitrate of soda contain neither shells nor fossils, nor do they contain any phosphate of lime. The theory, therefore, that they were due to animal origin is scarcely tenable.

Lately extensive nitrate deposits have been discovered in the United States of Colombia.³ These deposits have been found extending over 30 square miles, and vary in thickness from 1 to 10 feet. The visible supply is estimated at 7,372,800,000 tons, containing from 1 to 13.5 per cent of nitrate. The deposits consist of a mixture of nitrate of soda, chloride of soda, sulphate of calcium, sulphate of alumina, and insoluble silica. It is thought that the amount of these deposits will almost equal those in Chile and Peru.

PHOSPHATIC DEPOSITS.

Gautier⁴ calls attention to the fact that the oldest phosphates are met with in the igneous rocks, such as basalt, trachyte, etc., and even in granite and gneiss. It is from these inorganic sources, therefore, that all phosphatic plant food must have been drawn. In the second

¹Fuchs and De Launy. *Traité des Gîtes Minéraux*, 1893, Vol. 1, page 425.

²El Salitre de Chile, René F. Le Feuvre y Arturo Dagino, 1893, page 12.

³Bureau of American Republics, *Monthly Bulletin*, December, 1893, page 18 et seq.

⁴Compt. Rend., 116, pages 1271, 6.

order in age Gautier places the phosphates of hydro-mineral origin. This class not only embraces the crystalline apatites, but also those phosphates of later formation formed from hot mineral waters in the Jurassic, Cretaceous, and Tertiary deposits.

These deposits are not directly suited to nourish plants.

The third group of phosphates in order of age and assimilability embraces the true phosphorites containing, generally, some organic matter. They are all of organic origin. In caves where animal remains are deposited there is an accumulation of nitrates and phosphates.

Not only do the bones of animals furnish phosphates, but they are also formed in considerable quantities by the decomposition of substituted glycerides, such as lecithin.

The ammonia produced by the nitrification of the albuminoid bodies combines with the free phosphoric acid thus produced, forming ammonium or diammonium phosphates.

The presence of ammonium phosphates in guanos was first noticed by Chevreul more than half a century ago.

If such deposits overlay a pervious stratum of calcium carbonate, such as chalk, and are subject to leaching, a double decomposition takes place as the lye percolates through the chalk. Acid calcium phosphate, and ammonium carbonate are produced. By further nitrification the latter becomes finally converted into calcium nitrate. In like manner aluminum phosphates are formed by the action of decomposing organic matter on clay.

Davidson¹ explains the origin of the Florida phosphates by suggesting that they arose chiefly through the influx of animals driven southward by the Glacial period. According to his supposition the waters of the ocean, during the Cenozoic period contained more phosphorus than at the present time. The waters of the ocean over Florida were shallow, and the shellfish existing therein may have secreted phosphate as well as carbonate of lime. This supposition is supported by an analysis of a shell of *Lingula ovalis*, quoted by Dana, in which there was .85.79 per cent of lime phosphate. In these waters were also many fishes of all kinds, and their debris served to increase the amount of this substance. As the land emerged from the sea, came the great Glacial epoch driving all terrestrial animals southward. There was therefore a great mammal horde in the swamps and estuaries of Florida. The bones of these animals contributed largely to the phosphatic deposits. In addition to this, the shallow sea contained innumerable sharks, manatees, whales, and other inhabitants of tropical waters, and the remains of these animals added to the phosphatic store.

While these changes were taking place in the Quaternary period, the Florida peninsula was gradually rising, and, as soon as it reached

¹Engineering and Mining Journal, quoted in the Phosphates of America, by Wyatt, page 66 et seq.

a considerable height, the process of denudation by the action of water commenced. Then there was a subsidence, and the peninsula again passed under the sea and was covered with successive layers of sand. The limestones during this process had been leached by rain water, containing an excess of carbonic acid. In this way the limestones were gradually dissolved, while the insoluble phosphate of lime was left in suspension. During this time the bones of the animals before mentioned, by their decomposition, added to the phosphate of lime present in the underlying strata, while some were transformed into fossils of phosphate of lime, just as they are found to-day in vast quantities.

Wyatt¹ explains the phosphate deposits somewhat differently. According to him, during the Miocene submergence there was deposited upon the Upper Eocene limestones, more especially in the cracks and fissures resulting from their drying up, a soft, finely disintegrated calcareous sediment or mud. The estuaries formed during this period were swarming with animal and vegetable life, and from this organic life the phosphates were formed by decomposition and metamorphism due to the gases and acids with which the waters were charged.

After the disappearance of the Miocene sea there were great disturbances of the strata. Then followed the Pliocene and Tertiary periods and Quaternary seas with their deposits and drifts of shells, sands, clays, marls, bowlders and other transported materials, supervening in an era when there were great fluctuations of cold and heat.

By reason of these disturbances the masses of the phosphate deposits which had been infiltrated in the limestones became broken up and mingled with the other débris and were thus deposited in various mounds or depressions. The general result of the forces which have been briefly outlined was the formation of bowlders, phosphatic débris, etc. Wyatt therefore classifies the deposits as follows:

(1) Original pockets or cavities in the limestone filled with hard and soft rock phosphates and débris.

(2) Mounds or beaches, rolled up on the elevated points, and chiefly consisting of huge bowlders of phosphate rock.

(3) Drift or disintegrated rock, covering immense areas, chiefly in Polk and Hillsboro counties, and underlying Peace River and its tributaries.

N. H. Darton, of the United States Geological Survey, ascribes the phosphate beds of Florida to the transformation of guano.² According to this author two processes of decomposition have taken place; one of these is the more or less complete replacement of the carbonate by the phosphate of lime; the other is a general stalactitic coating of phosphatic material. Darton further calls attention to the relation of the distribution of the phosphate deposits as affecting the theory of their

¹ Engineering and Mining Journal, August 23, 1890.

² Amer. Jour. of Science, Vol. 41, February, 1891.

origin, but does not find any peculiar significance in the restriction of these deposits to the western ridge of the Florida Peninsula.

As this region evidently constituted a long, narrow peninsula during early Miocene times it is a reasonable tentative hypothesis that during this period guanos were deposited from which was derived the material for the phosphatization of the limestone either at the same time or soon after.

Darton closes his paper by saying that the phosphate deposits in Florida will require careful, detailed geologic exploration before their relations and history will be fully understood.

According to Dr. N. A. Pratt the rock or boulder phosphate had its immediate origin in animal life, and the phosphate boulder is a true fossil. He supposes the existence of some species in former times in which the shell excreted was chiefly phosphate of lime. The fossil boulder therefore becomes the remains of a huge foraminifer which had identical composition in its skeleton with true bone deposits or of organic matter.

Perhaps the most complete exposition of the theory of the recovery of waste phosphates, with especial reference to their deposition in Florida, has been given by Eldridge,¹ of the United States Geological Survey. Eldridge calls attention to the universal presence of phosphates in sea water and to the probability that in earlier times, as during the Miocene and Eocene geologic periods, the waters of the ocean contained a great deal more phosphate in solution than at the present time. He cites the observations of Bischof, which show the solubility of different phosphates in waters saturated with carbon dioxide. According to these observations apatite is the most insoluble form of lime phosphate, while artificial basic slag phosphate is the most soluble. Among the very soluble phosphates, however, are the bones of animals, both fresh and old. Burnt bones, however, are more soluble than bones still containing organic matter. Not only are the organic phosphates extremely soluble in water saturated with carbon dioxide but also in water which contains common salt or chloride of ammonium. The presence of large quantities of common salt in sea water would, therefore, tend to increase its power of absorbing lime phosphates of organic origin. It is not at all incredible, therefore, to suppose that at some remote period the waters of the ocean, as indicated by these theories, were much more highly charged with phosphates than at the present time.

According to Eldridge, the formation of the hard rock and soft phosphates may be ascribed to three periods: First, that in which the primary rock was formed; second, that of secondary deposition in the cavities of the primary rock; third, that in which the deposits thus formed were broken up and the resulting fragments and comminuted material were redeposited as they now occur.

¹A Preliminary Sketch of the Phosphates of Florida, by George H. Eldridge, author's edition, 1892, page 18 et seq.

“The first of these stages began probably not later than the close of the older Miocene, and within the Eocene area it may have begun much earlier. Whether the primary phosphate resulted from a superficial and heavy deposit of soluble guanos, covering the limestones, or from the concentration of phosphate of lime already widely and uniformly distributed throughout the mass of the original rock, or from both, is a difficult question. In any event, the evidence indicates the effect of the percolation of surface waters, highly charged with carbonic and earth acids, and thus enabled to carry down into the mass of the limestone dissolved phosphate of lime, to be redeposited under conditions favorable to its separation. Such conditions might have been brought about by the simple interchange of bases between the phosphate and carbonate of lime thus brought together, or by the lowering of the solvent power of the waters through loss of carbonic acid. The latter would happen whenever the acid was required for the solution of additional carbonate of lime, or when, through aeration, it should escape from the water. The zone of phosphate deposition was evidently one of double concentration, resulting from the removal of the soluble carbonate thus raising the percentage of the less soluble phosphate, and from the acquirement of additional phosphate of lime from the overlying portions of the deposit.

“The thickness of the zone of phosphatization in the Eocene area is unknown, but it is doubtful if it was over 20 feet. In the Miocene area the depth has been proved from the phosphates in situ to have been between 6 and 12 feet.”

The deposits of the secondary origin, according to Eldridge, are due chiefly to sedimentation, although some of them may have been due to precipitation from water. This secondary deposition was kept up for a long period, until stopped by some climatic or geologic change. The deposits of phosphates thus formed in the Florida peninsula are remarkably free from iron and aluminum, in comparison with many of the phosphates of the West Indies.

The third period in the genesis of the hard-rock deposits embraces the period of formation of the original deposits and their transportation and storage as they are found at the present time. The geologic time at which this occurred is somewhat uncertain, but it was probably during the last submergence of the peninsula.

In all cases the peculiar formation of the Florida limestone must be considered. This limestone is extremely porous and, therefore, easily penetrated by the waters of percolation. A good illustration of this is seen on the southwestern and southern edges of Lake Okeechobee. In following down a drainage canal which had been cut into the southwest shore of the lake I saw the edge of the basin, which is composed of this porous material. The appearance of the limestone would indicate that large portions of it had already given way to the process of solution. The remaining portions were extremely friable, easily crushed, and much of it could be removed by the ordinary dredging machines. Such a limestone as this is peculiarly suited to the accumulation of phosphatic materials, due to the percolation of the water containing them. The solution of the limestone and consequent deposit of the

phosphate of lime is easily understood when the character of this limestone is considered.

Shaler, as quoted by Eldridge in the work already referred to, refers to this characteristic of the limestone and says that the best conditions for the accumulation of valuable deposits of lime phosphate in residual débris appear to occur where the phosphatic lime marls are of a rather soft character; the separate beds having no such solidity as will resist the percolation of water through innumerable incipient joints such as commonly pervade stratified materials, even when they are of a very soft nature.

Eldridge is also of the opinion that the remains of birds are not sufficient to account for the whole of the phosphatic deposits in Florida. He ascribes them to the joint action of the remains of birds, of land and marine animals, and to the deposition of the phosphatic materials in the waters in the successive subsidences of the surface below the water line.¹

POTASH DEPOSITS.

In the foregoing pages I have tried to set clearly before you the different ways in which the waste of nitrogen and phosphoric acid has been recovered by nature in a form suitable for restoration to arable fields. In the case of potash, however, we have seen that this element is not restored by the processes already mentioned, in amounts proportionate to nitrogen and phosphorus. Potash salts, being extremely soluble, are likely to be held longest in solution. Some of them, of course, are recovered in the animal and vegetable life of which we have spoken, but the great mass of potash carried into the sea still remains unaccounted for. The recovery of the waste of potash is chiefly secured by the isolation of sea waters containing large quantities of this salt and their subsequent evaporation. Such isolation of sea waters takes place by means of geologic changes in the level of the land and sea. In the raising of an area above the sea level there is almost certain to be an inclosure, of greater or less extent, of the sea-water in the form of a lake. This inclosure may be complete or only partial, the inclosed water area being still in communication with the main body of the sea by means of small estuaries. If this body of water be exposed to rapid evaporation, as was doubtless the case in past geologic ages, there will be a continual influx of additional sea water through these estuaries to take the place of that evaporated. The waters may thus become more and more charged with saline constituents. Finally a point is reached in the evaporation when the less soluble of the saline constituents begin to be deposited. In this way the various formations of mineral matter, produced by the drying up of inclosed waters, take place.

¹For an elaborate discussion of phosphate deposits consult Gîtes Minéraux, par Fuchs et DeLauny, page 309 et seq.

The most extensive deposits of potash known are those in the neighborhood of Stassfurt, in Germany. The following description probably represents the method of formation of these deposits:¹

"The Stassfurt salt and potash deposits had their origin thousands of years ago, in a sea or ocean, the waters of which gradually receded, leaving near the coast, lakes which still retained communication with the great ocean by means of small channels. In that part of Europe the climate was still tropical, and the waters of these lakes rapidly evaporated, but were constantly replenished through these small channels connecting them with the main body. Decade after decade this continued, until, by evaporation and crystallization, the various salts present in the sea water were deposited in solid form. The less soluble material, such as sulphate of lime or 'anhydrite,' solidified first and formed the lowest stratum. Then came common rock salt with a slowly thickening layer which ultimately reached 3,000 feet, and is estimated to have been thirteen thousand years in formation. This rock-salt deposit is interspersed with lamellar deposits of 'anhydrite,' which gradually diminish toward the top and are finally replaced by the mineral 'polyhalite,' which is composed of sulphate of lime, sulphate of potash, and sulphate of magnesia. The situation in which this polyhalite predominates is called the 'polyhalite region' and after it comes the 'kieserite region,' in which, between the rock-salt strata, kieserite (sulphate of magnesia) is embedded. Above the kieserite lies the 'potash region,' consisting mainly of deposits of carnallite, a mineral compound of muriate of potash and chloride of magnesia. The carnallite deposit is from 50 to 130 feet thick and yields the most important of the crude potash salts and that from which are manufactured most of the concentrated articles, including muriate of potash.

"Overlying this region is a layer of impervious clay which acts as a water-tight roof to protect and preserve the very soluble potash and magnesia salts which, had it not been for the very protection of this overlying stratum, would have been long ages ago washed away and lost by the action of the water percolating from above. Above this clay roof is a stratum of varying thickness of anhydrite (sulphate of lime), and still above this a second salt deposit, probably formed under more recent climatic and atmospheric influences or possibly by chemical changes in dissolving and subsequent precipitation. This salt deposit contains 98 per cent (often more) of pure salt, a degree of purity rarely elsewhere found. Finally, above this are strata of gypsum, tenacious clay, sand, and limestone, which crop out at the surface.

"The perpendicular distance from the lowest to the upper surface of the Stassfurt salt deposits is about 5,000 feet (a little less than a mile), while the horizontal extent of the bed is from the Harz Mountains to the Elbe River in one direction, and from the city of Magdeburg to the town of Bernburg in the other."

According to Fuchs and De Launy² the saline formation near Stassfurt is situated at the bottom of a vast Triassic deposit surrounding the city of Magdeburg. The quantity of sea water which evaporated to produce saline deposits of more than 500 meters in thickness must have been enormous and the rate of evaporation great. It appears that a temperature of 100° would have been quite necessary, acting for a long time, to produce this result.

¹Potash, Columbian Exposition, German Kali Works, pages 3, 4.

²Gites Minéraux, page 429.

These authors therefore admit that all the theories so far advanced to explain the magnitude of these deposits are attended with certain difficulties. What, for instance, could have caused a temperature of 100°? The most reasonable source of this high temperature must be sought for in the violent chemical action produced by the double decompositions of such vast quantities of salts of different kinds. There may also have been at the bottom of this basin some subterranean heat such as is found in certain localities where boric acid is deposited.

Whatever be the explanation of the source of the heat it will be admitted that at the end of the Permian period there was thrown up to the northeast of the present saline deposits a ridge extending from Helgoland to Westphalia. This dam established throughout the whole of North Germany saline lagoons in which evaporation was at once established, and these lagoons were constantly fed from the sea.

There was then deposited by evaporation first of all a layer of gypsum and afterwards rock salt, covering with a few exceptions the whole of the area of North Germany.

But around Stassfurt there occurred at this time geologic displacements, the saline basin was permanently closed, and then by continued evaporation the more deliquescent salts, such as polyhalite, kieserite, and carnallite, were deposited.

These theories account with sufficient ease for the deposition of the saline masses, but do not explain why in those days the sea water was so rich in potash and why potash is not found in other localities where vast quantities of gypsum and common salt have been deposited. It may be that the rocks composing the shores of these lagoons were exceptionally rich in potash and that this salt was, therefore, in a certain degree, a local contribution to the products of concentration.

Through the ages of the past the rich stores of plant food have been steadily removed from arable fields and apparently forever lost. But in point of fact no particle of it has been destroyed. Even the demitrifying ferments described by Springer, Gayon and Dupetit, and Müntz reduce only to a lower stage of oxidation or restore to a gaseous form the nitric nitrogen on which alone vegetables can feed. But electricity, combustion, and the activity of certain anaerobic ferments herding in the rootlets of legumes and other orders of plants are able to recover and again make available this loss.

Lately Winogradsky and Warington have shown that an organism can be grown in a sugar solution containing certain salts and excluding all nitrogenous matter save the free nitrogen of the atmosphere, which is capable of oxidizing and assimilating this inert gas. In a solution containing 7 grams of sugar as high as 14 milligrams of nitrogen have been fixed.

Warington says in speaking of this phenomenon:

“That a vegetable organism should be able to acquire from the air the whole of the nitrogen which it needs is certainly very remarkable, and is an extraordinary fact both to the physiologist and the chemist.”¹

The fact that a few million years may supervene before the particle that is carried off to-day as waste may return to organic life shows the patience rather than the wastefulness of nature.

As a result of this general review of the migrations of plant food, the reassuring conclusion is reached that there is no danger whatever of the ultimate consumption or waste of the materials on which plants live. Circumscribed localities, through carelessness or ignorance, where once luxuriant crops grew, may become sterile, but the great source of supply is not exhausted. In fact, as the rocks decay and nitrifying organisms increase, the total store of plant food at the disposal of vegetation may continue to grow. When we join with this the fact that the skill of man in growing crops is rapidly increasing, we find no danger ahead in respect of the quantity of human food which may be produced.

Only the novelist might be able, by the aid of an unfettered imagination, to say how many human beings the United States alone will be able to feed in comfort. With the aid of scientific agriculture, with the help of the agricultural chemist, we may safely say that a thousand million people will not so crowd our means of subsistence as to make Malthus more than a pleasing theorist. As I pointed out in my vice-presidential address at Buffalo, the death of humanity is not to come from starvation but from freezing, and many a geologic epoch will come and go before this planet dies of cold.

¹Chem. News, October 13, 1893, page 170.

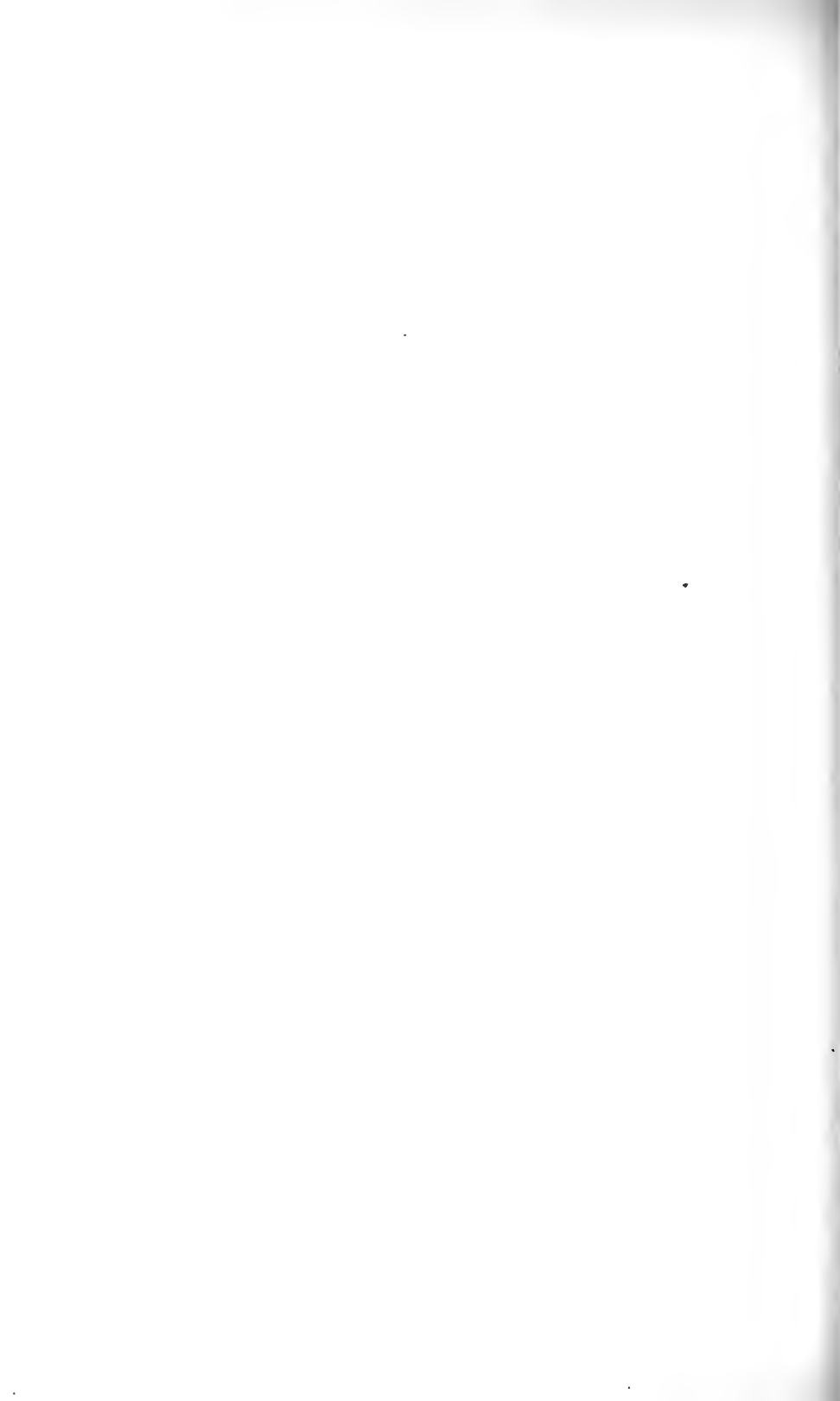

FOUR DAYS' OBSERVATIONS AT THE SUMMIT OF MONT BLANC.¹

By M. J. JANSSEN.

On Friday, the 22d of August, in the year 1890, about noon, a sleigh driven, or rather hoisted, by twelve men of extraordinary vigor and resolution, attained the summit of Mont Blanc.

It was the first time an ascent had been accomplished in this novel style and that a traveler had reached the very top of the renowned pile hardly having set foot to the ground.

The journey had called for heroic efforts. Slopes of extreme steepness had been climbed, broad crevasses had been crossed or turned, ridges like knife edges, with abysses on either hand, had been followed. But triumph had crowned their efforts; and, the feat accomplished, there had been an explosion of enthusiasm—congratulations, and even kisses.

The traveler, having paid his debt of praise and thanks to his companions, glanced at the scene unrolled before his eyes and seemed ravished with a sort of ecstacy.

The weather was splendid, and the celestial vault appeared of a dark and somewhat violet blue; but quite unexpectedly, however rationally, that vault seemed continued below the horizon, as if the heaven had wished to draw its strings and inclose the observer in an azure sphere.

The plains, the cities, the valleys, and all the fields which were spread out within the immense circle of that horizon looked as if they were sunk to the bottom of an ocean of heavenly blue. It was as if the kingdom of the mermen were revealed at the bottom of the ocean.

However, from the bottom of that ocean rose here and there huge reefs, whose tops of dazzling whiteness emerged from the surface and rose toward the horizon. These were the mountain chains at the center of which Mont Blanc presides.

The traveler did not permit himself to be completely absorbed by that memorable picture. He directed his attention to the conditions offered by this station for astronomical and physical observations, and after this scrutiny and rapidly taken notes were completed he gave the signal of retreat and the band descended.

¹ Translated from *Annuaire du Bureau des Longitudes*, Paris, 1894. Read in the annual public meeting of the five academies, October 13, 1893, by Dr. Janssen, member of the institute, delegate of the Academy of Sciences.

The success of this journey proved that those glaciers which present to the scientific man such novel and important subjects of research, and to the artist and the poet such sublime scenes, are henceforth not inaccessible to those whose physical forces play the traitor to their wills.

We may add that a mode of ascent which spares the traveler the extraordinary fatigues of an ascent on foot alone permits him fully to enjoy the beauty of those regions.

A month later the traveler in question, he who has the honor of addressing you, reported to the Academy of Sciences the circumstances of the ascent and the observations he had made, calling attention to the advantages which meteorology, terrestrial physics, and astronomy would find in this incomparable station, at which he proposed to establish an observatory.

Scarcely was his reading done when one of his colleagues, the Mécenas of contemporary French astronomy, enthusiastic for the project, desired immediately to inscribe himself as principal coöperator. Shortly after, the project received the spontaneous cooperation of a prince friendly to science, the bearer of a great historic name, and one of the most generous financiers of our age.

To these supports were soon added others whose importance was due particularly to the high situations of the persons bringing their adhesion to the plan.

A society was then formed. The President of the Republic condescended to be an honorary member; M. Leon Say, honorary president; M. Janssen, president; M. Bischoffsheim, secretary; M. Ed. Delessert, treasurer; MM. Prince Roland Bonaparte, Baron Alph. de Rothschild, Count Greffülthe, members.

The scheme was thus incorporated and its realization now only depended upon the good fortune with which natural obstacles might be surmounted. Yet it could not be denied that the difficulties of the enterprise were great, as I had myself foreseen and emphatically stated.

Indeed, the people who were the best acquainted with the glaciers of the great mountain deemed the establishment at the summit of a construction of some importance, capable of affording lodging to the observers, to be impossible. On the one hand, it was said, and with great appearance of reason, the icy crust of the summit must have a great thickness, forbidding the establishment of foundations on the rock, and on the other hand the possibility of founding on the snow was denied. In fact, the general opinion was unfavorable.

On the other hand, M. J. Vallot had just established on the rock of the Bosses, about 400 meters from the summit, a refuge of great utility and an observatory which was to be considerably enlarged and would permit a variety of extremely valuable observations at a high altitude. But those considerations, notwithstanding their weightiness, could not arrest us.

The summit alone by its commanding situation and the immense horizon that it embraces is adapted to the investigations which we propose.

An experience of thirty-five years of travel and research in the different parts of the world, especially my sojourns on the summit of the Faulhorn, on that of Etna, on the Pic du Midi, and on the highlands of the Himalaya had shown me the imperfections of observations made on the flanks of mountains, by reason of all the disturbing causes which go to derange them, and the incontestible superiority from that point of view of the culminating points.

I considered that, France having the good fortune to possess the better part of the great pile of Mont Blanc and to have access to its summit, we had not the right to stop so near our end, and in order to spare ourselves a last effort to deprive ourselves of the incomparable advantages attached to the possession of the peak which commands three countries and permits the study of a layer of air of 5 kilometers thickness and 100 diameter the conquest should be made at any cost. Hence, as soon as the soundings, due in great part to the generosity of M. Eiffel, had shown that the thickness of the snow at the top appeared to negative a foundation on the rock, I thought we ought not to hesitate to seek all means of obtaining an installation on the snow itself. But, as I said, this novel plan met with almost universal incredulity, and nothing but the conviction due to a thorough examination of the question prevented its author from being shaken by those criticisms.

Two principal questions had first to be cleared up: In the first place, What resistance could the snow of the summit offer to support the weight of an important construction? Next, What movements were to be feared in the snowcap?

In order to answer the first question experiments upon the resistance of snow were instituted at the observatory of Meudon. They gave surprising results for the force of the resistance. A column of lead of 360 kilograms and only 30 centimeters diameter sunk only a few millimeters in settled snow brought to the density of that at the summit of Mont Blanc. Later the experiment was repeated with still more surprising results.

As to the question of movement, it was studied and solved by the putting in place, in the year 1891, of a little building of wood sunk in the snow by a determinate amount and carefully leveled. This little building has now been on the summit for two years and still answers for a storehouse.

All these encouraging results having been acquired, the execution of the plan was vigorously begun.

The shape of the observatory and its internal arrangement had to be adapted to the novel conditions of its erection.

The construction, which was to have two stories and a terrace, took the form of a truncated quadrangular pyramid, a form which gives a large base and offers little hold to winds on account of the slanting surfaces.

The lower story was to be three-quarters sunk under the snow in order to insure to the edifice a solid seat and to give the sleeping chambers of this story a relatively mild temperature.

Moreover, the whole construction would be so bound together in all its parts that it would form a rigid whole, which with the aid of proper jackscrews could be brought back into place in case motions of the snows of its foundations should take place.

It was necessary also to take into account the weight and dimensions of the materials by reason of the difficulties of transport over the glacier. It was decided to make the beams in different parts hollowed out in the interior, so as to limit the weight of them and to obtain lightness combined with rigidity.

Such were the general arrangements adopted.

For their realization and the drawing up of plans I was greatly aided by my friend, M. Vandremere, the eminent architect, member of the Academy of Fine Arts, who had fully approved my ideas and my plan.

The observatory was constructed at Meudon under our direction. It was then taken apart and transported to Chamonix, where the materials were divided for the ascent. The weight of the materials amounted to nearly 15 tons and formed the matter of seven or eight hundred porters' loads. Accordingly, to avoid confusion and diminish the chances of accident, the road was divided into four sections and huts of deposit and refuge were constructed at the two principal stations.

The first section comprised the road from Chamonix to the entrance of the glacier. This road, new made in its upper part, could be traveled on the backs of mules. The second station embraced the part from the entrance of the glacier to the rocks called the Grands Mulets, where there is an inn belonging to the commune.

At this important station in the midst of the glacier and at about 3,000 meters elevation—that is, half way up—a rude hut for porters was built, for the transportation across this part of the glacier, which is highly diversified, can only be effected on men's backs.

The course from the station of Grands Mulets to that of the Grand Rocher Rouge, about 300 meters below the summit, formed the third section.

This station of the Grand Rocher Rouge was valuable owing to its proximity to the summit. We there built a living hut, which was of the greatest service to our workers. They came there to pass the night and to take refuge in bad weather.

The whole summer of 1892 was spent in the construction of the observatory, its transportation to Chamonix, the organization of the stations, and the building of the huts and transports.

Business had been pushed, for at the end of the campaign all the stations had been organized, a quarter of the materials had been carried to the Grand Rocher Rouge, and the rest was on deposit at the Grands Mulets.

The campaign of 1893 was to be employed in finishing the transportation of materials to the summit and to the building.

An accident such as often happens on Mont Blanc came near compromising the whole thing. A large deposit of materials placed at the Grand Rocher Rouge at the beginning of winter was nowhere to be found in the spring. After hunting everywhere it was discovered buried beneath some 8 or 9 meters of snow, and it was a great labor to get it out.

To facilitate the transportation of the heavier pieces I had invented and caused to be constructed a number of very light winches or windlasses, formed of a simple frame inclosing the drum and gearing and furnished with rings which allowed them to be solidly fixed in the snow by the aid of ice axes or stakes.

These windlasses, placed from stretch to stretch on the great slopes, served to tug the sledges bearing materials.

Thus the workmen were much relieved, and they could mount the greatest slopes, the ascent of which is so laborious and even dangerous for heavily loaded porters.

It was a novel thing, and curious, too, to see the great glacier of Mont Blanc, whose successive projections looked like the steps of some gigantic staircase, marked with the line of laborers working these machines, which slowly but surely dragged along the heavy loads toward the summit. It was a new kind of undertaking, whose object was not search for material wealth, but the conquest of a station which was to endow science with new truths.

Meantime materials were accumulating on the top, and the critical moment was approaching when the final effort was to crown all these labors; I mean the moment of building.

Then a gang of the strongest men was chosen—the most habituated to these high elevations. To them were joined the very carpenters who had put the house together at Meudon, and the summit was attacked.

We were much afraid of the gales and the hurricanes that are so frequent on Mont Blanc; but by an unhopèd-for piece of good luck, like a favor accorded to such perseverance and such efforts, there was a whole fortnight perfectly calm with a temperature relatively mild.

So the work went on with astonishing celerity, and on the 8th of September the observatory was built, walled in, floored, and its staircase up. A part of the terrace alone remained in abeyance. It was necessary to go back to finish it.

Meantime, impatient to see our observatory in place and to make observations there, I organized my ascent. In this second journey to the top we employed windlasses for hoisting the travelers' sleigh. The line being attached to the sleigh, the guides carrying the windlass stretched out the rope and fixed the windlass at a good distance. The windlass, put in place on pickets and solidly bound to ice axes deeply

buried in the snow, was set in motion and the sleigh advanced. But, as it approached the machine, two guides took the line which had passed the drum, and, furnished with a second windlass, went to establish a new hauling station. As soon as the sleigh had reached the first windlass, the latter was disengaged and carried in its turn to a higher station, and this maneuver continued without interruption to the summit of the side to be climbed.

Thus we climbed the steep slopes of the Cerisier, of the Petit-Plateau, of the Grand Plateau, of the wall of the Corridor, and of the wall of the Côte.

The glacier this year, after the long and hot summer, was stripped of its snow and crevassed everywhere; so that it would in the opinion of the guides have been impossible to accomplish the ascent by men's arms alone, as was done in 1890.

We left Chamonix Friday, the 8th of September, and we reached the summit Monday, the 11th, at half past 2 in the afternoon.

The ascent had been so difficult that we had to press into service, besides the men detailed to the sleigh, all the porters of provisions and instruments.

I had only taken with me the instruments required for the principal observation that I had in view, and the provisions had been left at the Rocher Rouge where they were to be sent for the next day.

But the weather suddenly became bad, and we remained without provisions for the two days the gale lasted.

Thursday at 1 o'clock the wind fell, the sky cleared up, and about 6 I witnessed a magnificent sunset. The top of Mont Blanc emerged from a sea of clouds extending on all sides to the horizon. The rounded forms of this surface looked like the waves of an ocean. Here and there fragments of cloud rising above the general level looked like isolated high mountains with strange outlines. The rays of the setting sun lit up the scene with reddish fires and made of it a world too fantastic for Gustave Doré to dare to dream. However, little by little the cooling of the atmosphere produced a gradual descent of the cloudy layer, and the great peaks of the chain of Monte Rosa and of the Oberland began to emerge, sowing that sea with new archipelagoes whose glaciers glittered with redder and redder fires as the sun sank. The disk of this sun of blood red broke into sinister fragments whose tatters were soon lost in that sea.

Then a glacial wind came up from the east and breathed upon the surface of the deep, and the shadows descended.

Nothing can convey the impression such scenes produce on those who love the sublime beauties of nature.

For my part, in face of this scene which recalled those pictures which show the first ages of the world when the continents first began to rise above the boundless surface of the waters, I was as one turning to stone. My emotions were too strong; to take notes would have been

impossible; but of that there was no need, since the succession of these scenes remained engraved ineffaceably upon my mind.

Why are the emotions so lively? Why, in particular, during the four nights I passed at the summit did I experience a feeling of such delicious buoyancy throughout my being? Why did it seem that I was relieved of a great weight which till then had fettered and weighed down my mind, and that it was now to take its flight and open in full liberty and love the questions the hardest and the finest of a higher moral order?

Is it the simple effect of the small specific gravity of the air of those high altitudes? Do there not enter other causes still unknown which shall be investigated in the future?

Be this as it may, it seems that nature, which does nothing in vain, and which is full of these harmonies, wishes to prepare us by the very effect of these high altitudes to better feel the greatness and the sublimity of the scenes that it presents to us.¹

But the sun rose brightly the next morning, while I was present as spectator of an event less dramatic than the setting of the previous evening, but still of a grandeur unparalleled. I could give it, however, but a few moments' attention. I wished to profit by the presence of this fine sun to execute the long and delicate observations which I had not been able to make with my large instruments at the time of my ascent of 1890.

Those observations related, as is known, to the vexed question of the presence of oxygen in the gaseous elements of the sun.

The eminent American physicist, Draper, thought himself able to conclude from observations of spectral photography that oxygen was a part of the solar atmosphere. Now this question of solar oxygen has an importance which transcends the purely scientific horizon.

If the sun is so constituted as to fill for long ages its office of dispenser of heat and light to the worlds it enchains around it, science foresees, nevertheless, that by the inevitable effect of time its radiating powers will diminish and more and more decline. Now if, during the ages which shall witness this lowering of temperature, the gaseous envelopes so rich in hydrogen surrounding the incandescent orb were to contain oxygen besides, a moment would necessarily be reached in which a combination of the two bodies would take place, and then enormous quantities of aqueous vapor would appear in the solar atmosphere.

Now, we know that the vapor of water is that one of the elastic fluids that is endowed with the most energetic power of absorption for radiant heat. This aqueous atmosphere would, then, form a veil, a

¹ I here repeat what I have already said apropos of the ascent of 1890, that this state of mind supposes that one has nothing to do in the way of physical effort. In my opinion, it is the mode of going up I employed and the care I took to preserve all the forces of my intellectual life which put me into the state of mind shown in the above passages.

screen which would diminish in an enormous proportion the power of the already declining sun.

At the surface of the earth one would quickly enough perceive the terrible phenomenon (supposing, at the low temperature the air would have, there were any living beings to perceive it, which is improbable). Temperature would everywhere fall, the climate of the poles would advance toward the equator (already far more frigid than the poles are now), and the conditions of vegetation and of animation would be still more remote from fulfillment.

It is true that by reason of the enormous mass of our central orb and of the conditions which have presided over its constitution, we still have at all events a long future before us before we shall witness any such catastrophe. But let us not selfishly forget that the earth is not alone over against the sun, that the happy family of the planets counts sister planets whose mass is incomparably greater than ours, the evolution of the phenomena of animation there being correspondingly much slower, and that those planets need long futures to assure their healthy and normal development. Such is the case with Jupiter and Saturn, whose masses are so vast, and which appear to have passed through as yet but a small fraction of their evolution.

We have thus an interest, not for the moment, but in the future, for our planetary world, in the atmosphere of the sun being so constituted as to have a long future before it; that is to say, in its being free from oxygen.

But how shall we obtain intelligence as to the state of our interests in this matter?

If we could transport ourselves without inconvenience to the limit of our atmosphere, where it is on the border of the celestial void, the solution of the question would be simple enough. We should receive in a spectroscope a solar ray, and, by our knowledge of all the special and characteristic modifications which oxygen gas produces in the spectrum, should decide the question in an instant.

But the problem is not so simple and easy. As things are, the atmospheric air consists one-fifth of oxygen, to which we mainly owe the presence of animal life on our globe, and when we wish to analyze a ray, it has already traversed an almost infinite thickness of oxygen. How, then, shall we distinguish between the spectroscopic effect on the sun's atmosphere and that of the earth?

Here it is that the high stations become useful.

Imagine that, with our eyes fixed upon the solar spectrum, we could be buoyed up higher and higher in the air. We should see the oxygen lines pale as we approached the limits of our atmosphere; and since these rays have not all the same intensity, but become weaker the less their refrangibility, we should see the feebler lines disappear one after another. If, then, it were made out that the decrement in the intensity and number of lines corresponded strictly to the quantity of oxygen

left below us, we should have a right to infer that in rising still more and approaching the atmospheric limits all the oxygen-rays of the spectrum would disappear, and that, consequently, the sun has nothing to do with the phenomenon, and contains no oxygen in its atmosphere.

We come now to the observation made on Mont Blanc on Thursday, the 14th, and Friday, the 15th, of September, 1893.

We have been able to aver that as a matter of fact the number and enfeebling of the oxygen lines of the solar spectrum seemed to correspond to an atmospheric thickness of 4,800 meters, precisely the amount which was underfoot, and that consequently the oxygen lines in the solar spectrum are entirely due to the oxygen of our atmosphere.

To make sure of this is a delicate matter. On the one hand the heavens must be very pure, and on the other hand a large apparatus must be mounted with care and protected from the wind and from stray light. That is to say, the observation can only be properly made in a closed room sufficiently spacious. Those are the conditions which the Mont Blanc Observatory offered. It was inaugurated by that study.¹

This absence of oxygen in the atmospheres of the central orb not merely interests us from the point of view of the future of the worlds

¹ What makes the novelty of the observations of 1893 is that on the one hand they have been effected upon the summit of Mont Blanc, and especially that the instrument employed was infinitely superior to that of the two previous ascents. The first was a spectroscope by Duboscq, incapable of separating the B group into distinct lines, while the second was a spectroscope with a Rowland grating (presented by Professor Rowland), with telescopes of 0.75 meters focal length, showing, it is needless to say, all known details of B.

A special importance attaches to this, because there may be found in the constitution of this B group valuable elements for measuring in some sort the effects of the decrement of the action of our atmosphere as we rise in it, and consequently for judging whether that decrement corresponds to a total extinction at the limit of the atmosphere. In fact we know that the double lines, whose aggregate constitutes the B group, diminish in intensity as their refrangibility diminishes, or, if you choose, with their increased wave length.

We can avail ourselves of this circumstance, if not to measure, at least to estimate the diminution of the action of selective absorption of our atmosphere. In fact, we find that the feeblest doublets vanish successively in the atmosphere—that is to say, according as the action of absorption diminishes. For example, in ordinary circumstances, on the surface of seas or plains, the maps of the B group show, besides what we call the head of B, thirteen or fourteen doublets. Already at Chamonix, at 1,050 meters, the thirteenth doublet is difficult to make sure of. At the Grands Mulets (3,050 meters) it is only from the tenth to the twelfth that sure observations can be made. At the summit of Mont Blanc I could hardly go beyond the eighth.

But is it not remarkable that, taking the ratio of atmospheric pressures on Mont Blanc and in the plain, or

$$\frac{0.43}{0.76} = 0.566,$$

and multiplying this by the number of doublets generally quite visible in the plain, or say thirteen to fourteen, we get 7.4 or about the number (8) seen by me at the summit?

that belong to it, but it has another bearing of a still more lofty order. It reveals to us a new harmony in the constitution of the system.

We already know the grand outlines of the sun's constitution and the admirable conditions realized to assure both the abundance and the duration of the radiation with which it supplies the planets. We know how, as M. Faye's fine theory teaches, the incandescent surface of excessive thinness in which resides its radiating virtue is itself regenerated by the vast reserves of heat of the great central mass.

We know too, that this radiating surface is protected from rubbing against the icy void of space by a number of gaseous envelopes. Of these envelopes, or atmospheres, the highest, and doubtless the most efficacious, is the coronal atmosphere, which, during total eclipses, produces the splendid phenomenon of the glory of the corona.

This atmosphere is principally composed of hydrogen, the lightest and most transparent of known gases. The capital function of radiation, which is the rational end of the central luminary, is then assured by that transparent and protecting atmosphere. But we now see that, by an arrangement no less admirable, the body which could in a moment compromise this function has been removed with care.

Thus it is that science as she advances reveals to us at every step unknown laws and harmonies in the constitution of the world.

The observatory which now rears its head above the summit of Mont Blanc has just contributed a little part to this work. It promises in the future much larger results. The building is the realization of the thought and the desire of numbers of distinguished men of science who have worked on the renowned mountain. Since the memorable ascent of De Saussure, Mont Blanc has formed acquaintance with the

But though this is striking, it is the comparison with tubes placed under optical conditions as identical as possible which alone can lead to any certain conclusion. These comparative experiments have been commenced in the laboratory of the Observatory of Meudon. They lead to the same result, to wit, the disappearance of the groups A, α , and B at the limits of the atmosphere. But because of the importance of the question they will be taken up anew and completed.

It might be asked whether the elevated temperatures to which are submitted the gases and vapors of the solar atmospheres are not capable of modifying their power of selective absorption, and in particular whether oxygen, which might be in those atmospheres, would not have a spectrum quite different from that which we recognize in our experiments at ordinary temperatures.

I have already instituted experiments with a view to meeting this objection. I shall report them to the Academy, but I wish to say that the absorption spectra of oxygen, whether that with irresolvable bands or that with lines, do not appear to be appreciably modified when the oxygen is carried to 400° or 500°.

On the whole I may say that the observations which have been made at the summit of Mont Blanc put the question of the telluric origin of the oxygen groups of the solar spectrum upon a new footing much more precise and lead to the answer indicated.

various methods of investigation of Martins, Bravais, and Le Pileur, of Tyndall, Hodgkinson, Soret, Violle, and, more recently, M. Vallot.

But it must be confessed that those researches would have given results still more important, in view of the science and talents of their authors, if the latter had had a better installation for their instruments. Now that the observatory is built, and that it will soon offer a comfortable sojourn, nothing will any longer prevent all the results that are to be expected at this station from being reached.

A fine and copious scientific harvest is to be reaped. Let us invite to it the scientific men of all countries, and we shall thus adhere to the constant tradition of France, who has always loved to take the nations into partnership in her endeavors after progress and light.



WEATHER MAKING, ANCIENT AND MODERN.¹

By MARK W. HARRINGTON.

The subject of ancient and modern weather making is a very large one—too large to be treated with entire generality. I shall discuss it rather from the American standpoint, and shall use cases in the Old World simply for the purpose of illustration and for completeness.

Three distinct sorts of weather making have been employed. The first depends on superstitious and religious methods; then follows on this the degradation of these religious ideas into folklore remnants, which have a curious persistency in civilized countries. Both these are psychic. Opposed to them is the third method, mainly American and intensely practical, with which some history and literature are connected.

I.—SUPERSTITIOUS AND RELIGIOUS METHODS.

RAIN MAKING AND STOPPING.²

Many Indian tribes have attempted to produce rainy or dry weather, according to requirements. Among these may be mentioned the Mandan, the Muskingum, the Moqui, the Natchez, Zuni, Choctaws, and others. For this purpose pipes were smoked, tobacco was burned, prayers and incantations were offered, arrows were discharged toward the clouds, charms were used, and various other methods were employed. Classifying by tribes the processes employed, we turn first to the Iroquois.

Mrs. E. A. Smith, in her *Myths of the Iroquois*, says:

“In a dry season, the horizon being filled with distant thunder heads, it was customary to burn what is called by the Indians real tobacco as an offering to bring rain.

“On occasions of this nature the people were notified by swift-footed heralds that the children, or sons, of Thunder were in the horizon, and that tobacco must be burned in order to get some rain.”³

¹From the *National Geographic Magazine*, Vol. VI, pages 35-62, April 25, 1891.

²These cases of weather making among the North American Indians were collected for me by Dr. Fuller Walker, of the Weather Bureau, who searched through the literature available in Washington.

³Second Ann. Rep. Bureau of Ethnology for 1880-81 (1883), page 72.

As to the Muskingum, Heckewelder, in his *Account of the Indians of Pennsylvania* (Philadelphia, 1819, p. 229), says:

“There are jugglers, generally old men and women, who get their living by pretending to bring down rain when wanted, and to impart good luck to bad hunters. In the summer of 1799 a most uncommon drought happened in the Muskingum country (Ohio). An old man was applied to by the women to bring down rain, and, after various ceremonies, declared that they should have rain enough. The sky had been clear for nearly five weeks, and was equally clear when the Indian made this declaration; but about 4 o'clock in the afternoon the horizon became overcast, and, without any thunder or wind, it began to rain, and continued to do so until the ground became thoroughly soaked.”

Heckewelder adds that “experience had doubtless taught the juggler to observe that certain signs in the sky and in the water were the forerunners of rain.”

Among the Natchez, according to Father Charlevoix,¹ jugglers not only pretended to cure the sick, but also professed to procure rain and seasons favorable for the fruits of the earth. Their incantations were often directed to the dispersion of clouds and the expulsion of evil spirits from the bodies of the afflicted.

In the third report of the Bureau of Ethnology it is stated by J. Owen Dorsey that “when the first thunder is heard in the spring of the year the Elk people (among the Omaha Indians) call to their servants, the Bear people, who proceed to the sacred tent of the Elk gens. When the Bear people arrive one of them opens the sacred bag and, after removing the sacred pipe, hands it to one of the Elk men, with some of the tobacco from the elk bladder. Before the pipe is smoked it is held toward the sky, and the thunder god is addressed. . . . ‘At the conclusion of this ceremony the rain always ceases, and the Bear people return to their homes.’”²

Catlin, in his “*Life among the Indians*” (p. 78), says that he found that the Mandan had “rain makers” and also “rain stoppers,” who were respected medicine men “from the astonishing facts of their having made it rain in an extraordinary drought, and for having stopped it raining when the rain was continuing to an inconvenient length.” He adds:

“For this purpose, in a very dry time, the medicine men assembled in the medicine lodge, and sitting around a fire in the center, from day to day smoking and praying to the Great Spirit for rain, while a requisite number of young men volunteered to make it rain. Each one of these, by ballot, takes his turn to mount to the top of the wigwam at sunrise in the morning, with his bow and arrows in his hand and shield on his arm, talking to the clouds and asking for rain, or ranting and threatening the clouds with his bow, commanding it to rain. After several days of unsuccessful attempts have passed off in this way with a clear sky, someone more lucky than the rest happens to take his stand on a day on which a black cloud will be seen moving up. When

¹ *Voyage to North America*, Dublin, 1776, Vol. II, page 203.

² *Omaha Sociology*, op. cit., 1884, page 227.

he sees the rain actually falling he lets his arrow fly, and pointing says: "There! my friends, you have seen my arrow go. There is a hole in that cloud. We shall soon have rain enough." When he comes down he is a medicine man. The doctors give him a feast and a great ceremony and the doctor's rattle. When the doctors commence rain making they never fail to succeed, for they keep up the ceremony until the rain begins to fall. Those who have once succeeded in making it rain in the presence of the whole village never undertake it a second time. They would rather give other young men a chance."

A similar account of the Mandan ceremony is given by Mr. John Frost in his book, "The Indians of North America" (New York, 1845, p. 109). He says:

"It was in a time of great drought that I once arrived at the Mandan village on the Upper Missouri. The young and the old were crying out that they should have no green corn. After a day or two the sky grew a little cloudy in the west, when the medicine men assembled together in great haste to make it rain. The tops of the wigwams were soon crowded. In the mystery lodge a fire was kindled, around which sat the rain makers, burning sweet-smelling herbs, smoking the medicine pipe, and calling on the Great Spirit to open the door of the skies to let out the rain. At last one of the rain makers came out of the mystery lodge and stood on the top of it with a spear in his hand, which he brandished about in a commanding and threatening manner, lifting it up as though he were about to hurl it at the heavens. He talked loud of the power of his medicine, holding up his medicine bag in one hand and his spear in the other; but it was of no use, and he came down in disgrace. For several days the same ceremony continued, until a rain maker with a headdress of the skins of birds ascended the top of the mystery lodge, with a bow in his hand and a quiver at his back. He made a long speech, for the sky was growing dark, and it required no great knowledge of the weather to foretell rain. He shot arrows to the sunrise and sundown points of the heavens and also to the north and south, in honor of the Great Spirit, who could send rain from all parts of the sky. A fifth arrow he retained until it was almost certain that rain was at hand. Then sending up the shaft from his bow with all his might to make a hole in the dark cloud over his head, he cried aloud for the waters to pour down at his bidding and to drench him to the skin. He was brandishing his bow in one hand and his medicine in the other, when the rain came down in torrents."

Among the Blackfeet Indians, according to W. P. Clark, in his "Indian Sign Language" (Philadelphia, 1885, p. 72)—

"The medicine man has a separate lodge, which faces the east. He fasts and dances to the sun, blowing his whistle. He is painted in different colors, and he must have no water, and only after dark can he eat, and then only the inner bark of the cottonwood tree. A picture of the sun is painted on his forehead, the moon, Ursa Major, etc., on his body. The dance continues for four days, and should this medicine man drink it is sure to cause rain, and if it [does not] rains no other evidence of his weakness is wanted or taken. He is deposed as high priest at once."

Mr. W. Noble, of Indian Territory, says that "the Choctaws, during a severe drought, will fasten a fish to one of their number, who then goes into the water and remains there every day for two weeks in order

to cause it to rain." He adds that "in wet weather, if they wish the rain to cease, they go to a sand bank, put sand in a pan, and dry it over a fire."

Among the Moqui, according to Schoolcraft—

"There is a charm used for calling down rain. It consists of a small quantity of wild honey wrapped up in the inner fold of the husk of the maize. To produce the effect desired it is necessary to take a piece of the shuck which contained the wild honey, chew it, and spit it upon the ground which needs the rain."¹

Capt. J. G. Bourke, in his "Snake dance of the Moqui" (p. 120), says:

"There was painted on the east wall a symbolical design, or 'prayer,' representing three rows of clouds in red and blue, from which depended long, narrow, black and white stripes, typical of rain, while from right and left issued long red and blue snakes, emblematic of lightning. This was a prayer to the god of clouds to send refreshing rains upon the Moqui crops. . . . Yellow was used in all prayers for pumpkins, green for corn, and red for peaches."

Among the Zuñi, according to Stevenson, medicine sticks were supposed to influence rain. These little sticks are found hidden beneath the rafters of nearly every house in Zuñi.²

Passing a little farther from home we find, in Acosta's "History of the Indies,"³ some accounts of rain producing and weather making among the Peruvian natives. According to him a Peruvian king in his lifetime caused a figure to be made wherein he was represented, which they called Huague, which signifies brother. They carried this image to the wars and in procession for rain or fair weather, making sundry feasts and sacrifices to it. They also pursued other methods. "In matters of importance they offered up alpacas, hanging the beast by the right fore leg, turning his eyes to the sun, speaking certain words according to the quality of the sacrifice they slew, for if it were of color their words were addressed to the god of thunder and lightning, that they might want no water" (p. 341). If they wanted water, to procure rain they set a black sheep tied in the middle of a plain, pouring much chiea about it, and giving it nothing to eat until it rained (p. 376). This is practiced (says Acosta, 1571-1588) at this day in many places in the month of October.

OTHER WEATHER MAKING.

What precedes relates to rain making or stopping. A somewhat similar series of facts occur among the American Indians concerning other elements of the weather, but their energies in this direction seem to be expended chiefly in the control of the winds.

It appears that the Kansas gens of the Omaha are Wind people, and to them is especially intrusted the control of the wind. Mr. J. Owen

¹ "History," etc., Vol. III, page 208.

² Second Ann. Rep. Bureau of Ethnology, page 371.

³ Hakluyt Society edition, Vol. II, pages 312, 313.

Dorsey says the Kanze (Kansa or Kaw) gens of the Omaha tribe, being Wind people, "flap their blankets to start a breeze."¹ He adds that when there is a blizzard the other Kansa tribe of Indian Territory beg the members of the Wind gens to interpose, saying, "O grandfather, I wish good weather. Cause one of your children to be decorated." Then the youngest son of a Kanze man, say one about 4 feet high, is chosen for the purpose, and painted with red paint. The youth rolls over and over in the snow, reddening it for some distance all around him. This is supposed to stop the blizzard.

The following account is from a book entitled *The Fourteen Ioway Indians* (London, 1844), and relates to raising wind:

"A packet ship with Indians on board, was becalmed for several days near the English coast. It was decided to call upon the medicine man to try the efficacy of his magical powers with the endeavor to raise the wind. After the usual ceremony of a mystery feast, and various invocations to the spirit of the wind and ocean, both were conciliated by the sacrifice of many plugs of tobacco thrown into the sea, and in a little time the wind began to blow, the sails were filled, and the vessel soon wafted into port."

The Indians also have many associations with thunder. Madam Lucy Elliot Keeler, in a paper recently contributed to the *American Agriculturist* for December, 1892, says:

"The Dakotas used to have a company of men who claimed the exclusive power and privilege of fighting the thunder. Whenever a storm which they wished to avert threatened, the thunder fighters would take their bows and arrows, their magic drum, and a sort of whistle made of the wing bone of a war eagle, and, thus armed, run out and fire at the rising cloud, whooping, yelling, whistling, and beating their drum to frighten it down again. One afternoon a heavy black cloud came up, and they repaired to the top of a hill, where they brought all their magic artillery into play against it; but the undaunted thunder darted out a bright flash which struck one of the party dead as he was in the very act of shaking his long-pointed lance against it. After that they decided that no human power could quell the thunder."

In the *Pawnee Hero Stories and Folk-tales*, published by George Bird Grinnell, we find the following:

"An old Pawnee Indian said: 'Up north where we worshipped at the time of the first thunder we never had cyclones. Down here [Indian Territory], now that this worship has been given up, we have them.'"

The Indians in some cases have ideas of controlling the weather more generally, and Dablin, in his *Relation of the Voyages, Discoveries, and Death of Father James Marquette*,² writing in 1671-1675, says:

"It now only remains for me to speak of the calumet, than which there is nothing among the Indians [i. e., the Illinois] more mysterious or more esteemed. - - - They esteem it particularly because they regard it as the calumet of the sun, and in fact they present it to him to smoke when they wish to obtain calm, or rain, or fair weather."

¹ Third Ann. Rep. Bureau of Ethnology, page 241.

² Hist. Coll. of Louisiana, Part IV, 1852, pages 34, 35.

Even the control of fog has been attempted, as shown by the following quotation from Dorsey's account of the Turtle subgens of the Omaha:¹

"In the time of a fog the men of this subgens drew the figure of a turtle on the ground with its face to the south. On the head, tail, middle of the back, and on each leg were placed small pieces of a (red) breech cloth, with some tobacco. This they imagined would make the fog disappear very soon."

But it is not only the pagan Indians who have tried their hand at weather making. Their Christianized descendants have also tried to control these operations of nature. In the transition times between paganism and Christianity occurred some events which throw a curious and instructive side light on this question, and two of these I will now give.

Mr. Parkman says that while the Jesuits labored with the Hurons a severe drought came upon the fields. The sorcerers put forth their utmost power, and from the tops of the houses yelled incessant invocations to the spirits. All was in vain. A renowned "rain maker," seeing his reputation tottering under his repeated failures, bethought him of accusing the Jesuits, and gave out that the red color of the cross which stood before their house scared away the bird of thunder and caused him to fly another way. On this a clamor arose. The popular ire turned against the priests, and the obnoxious cross was condemned to be cut down. The Jesuits said: "If the red color of the cross frightens the bird of thunder, paint it white." This was done, but the clouds still kept aloof. The Jesuits followed up their advantage. "Your spirits can not help you. Now ask the aid of Him who made the world." Heavy rains occurring soon after, it is said that many Indians believed in the white man's Great Spirit and presented themselves to the priests for baptism (Alice Elliot Keeler).

A somewhat similar story is told of Peru by Acosta. It appears that the Santa Cruz Indians became Christians because of the success of a renegade soldier in making rain. This soldier, seeing the native Indians "in a great extremity for water, and that to procure rain they used many superstitious ceremonies, according to their usual manner," said to them that if they would do as he said they should presently have rain, which they willingly offered to perform. "Then the soldier made a great cross, which he placed on a high and eminent place, commanding them to worship it and to demand water, which they did. A wonderful thing to see, there presently fell such an abundance of rain, as the Indians took so great devotion to the holy cross as they fled unto it in all their necessities, and obtained all they demanded, so as they broke down their idols."²

The quotation from Acosta indicates the attitude of the Indians of middle latitudes on this subject. This attitude, as is well known to

¹ Third Ann. Rep. Bureau of Ethnology, page 240.

² Op. cit., Vol. II, page 524.

those familiar with the Latin-American countries, is preserved unchanged among their descendants. Interesting illustrations of it can be picked up any day even as far north as Arizona and New Mexico, and every traveler in Latin-America has several at his disposal. As the quintessence of them all I present a clipping from the New York Tribune, to which my attention was called by Dr. T. C. Mendenhall. *Se non é vero é ben trovato.* The extract runs as follows:

"In the department of Castañas there had been no rain for nearly a year, and the people were brought to such a pass that they were actually dying for thirst, to say nothing of the total destruction of all crops and other agricultural industries.

"El Pueblo Católico, of New San Savaldor, prints a number of resolutions promulgated by the principal alcalde of the town and department of Castañas. They are as follows:

"Considering that the Supreme Creator has not behaved well in this province, as in the whole of last year only one shower of rain fell; that in this summer, notwithstanding all the processions, prayers, and praises, it has not rained at all, and consequently the crops of Castañas, on which depend the prosperity of the whole department, are entirely ruined, it is decreed:

"Article 1. If within the peremptory period of eight days from the date of this decree rain does not fall abundantly, no one will go to mass or say prayers.

"Art. 2. If the drought continues eight days more the churches and chapels shall be burned, and missals, rosaries, and other objects of devotion will be destroyed.

"Art. 3. If, finally, in a third period of eight days it shall not rain, all the priests, friars, nuns, and saints, male and female, will be beheaded. And for the present permission is given for the commission of all sorts of sin in order that the Supreme Creator may understand with whom he has to deal."

"The most remarkable feature of this affair is the fact that four days after these resolutions were passed the heaviest rainfall known for years was precipitated on the burning community."

II.—FOLKLORE REMNANTS.¹

Among the many curious remnants of folklore which we find in connection with the subject of weather making none is more curious than the idea that birds "call for rain." Whenever this expression is used the evident intention is, as is well known to those who are familiar with this mode of speech, to express the idea that they demand the rain, and that rain is likely to follow because of this demand. For instance, the call of the robin, heard so frequently, is interpreted to mean, "Bring out your skillet, bring out your skillet, the rain will fill it." In popular estimation this is a "call for rain." This association with our American robin is very general. In Maine and Massachusetts they are said to "sing for rain" (Miss F. D. Bergen). The

¹This series of associations of natural objects with weather making in the sense of a weather fetich—a weather maker, not simply a weather forecaster—is taken from the collections of weather proverbs made by the Signal Service and Weather Bureau.

American quail is also said to "call for rain," and its cry is interpreted to be, "More wet, more wet" (Dr. Robert Fletcher). The call of the loon is given the same meaning in so widely separated localities as Cape Breton, the State of Washington, and Florida (Mr. C. A. Smith). The same power is attributed, generally in the Old World, to many other birds, as ducks, geese, crows, and ravens. From Pennsylvania (William Schrock) comes the quaint conception expressed in the following rhyme:

The goose and the gander
 Begin to meander;
 The matter is plain,
 They are dancing for rain.

But the birds are not only effective in making rain; they can exert still greater influence. The kildee, or killdeer plover, is said, in Maryland, to call up the wind by his cry of "Kildee! kildee!" while to kill him would cause a violent storm (Dr. Fletcher). The Kiowa of Indian Territory attributes to the killdeer the bringing of spring (James Mooney, Washington).

Another popular association between animals and rain is the idea that by certain treatment of some animals definite results in the way of rain making can be obtained. For instance, on Santee River, in South Carolina, it is believed that if you catch an alligator, tie him to a tree, and whip him to death it will be certain to bring rain (Dr. W. W. Anderson). This seems to be a fragment of negro folklore. In Massachusetts it is said that if you see or step on a frog it is a sure sign of rain, while in Maine they say, "Kill a frog and it will rain before morning" (Miss F. D. Bergen). This association of rain with the toad is general over the United States. Still another folklore remnant of the same sort relates to snakes. It is a curious fact that among many races the snake is supposed to have some relations with the weather. Mr. James Mooney says, "The belief in a connection between rain and snakes is quite general among Indian tribes. The snake dance is intended to bring rain. The Indians of Indian Territory turn a dead snake on its back to bring rain." It is a piece of negro folklore that hanging a dead snake on a tree will bring rain in a few hours. Farther northward it runs, "Hang up a snake skin and it will bring rain." This refers to the cast-off skin. In northern Illinois the expression is, "Hang up a snake's cast-off skin on the crab-apple tree and it will bring rain." The snake has played a very important part in weather making, and to it has been attributed many other magical powers.

An interesting series of superstitions with reference to weather making are those which are common to sailors, who have a well-known half-serious belief that one can raise wind by whistling. In Newfoundland they say, "Stick a knife in the mainmast and whistle, and it must produce wind." In Newfoundland, also, they have an idea that if a vessel is becalmed wind can be produced by throwing over-

board a half-penny. Another notion, common also to the same sailors, is that if you put the end of the sheet overboard it will produce wind, and that if you hit it three times across the thwarts it will stop the rain. Mr. Kinahan, illustrating the sincerity of the belief in the power of whistling in raising wind, says: "In a dead calm you may whistle for wind, except in a dangerous place. Crossing from Skibbereen to Clear Island, County Cork, a friend of mine was very nearly getting into a row for inadvertently whistling." This belief is very general. In California sailors say that one may whistle softly for a breeze, but that it is dangerous to indulge in loud or thoughtless whistling as it may bring a gale. Here the skipper scratches the mizzen-mast for a fair wind.

Sailors profess great confidence in the ability of the cat to raise the wind, and are accustomed to say that the cat carries the wind in her tail. Cats have the general reputation of being very weatherwise. On shipboard, especially, it is considered imprudent to provoke a cat, because she is assumed to have a certain share in the arrangement of the weather. Imprudence of this sort appears, however, to have no terrors for the Soudanese in western Java, for, when rain is needed, they form in procession with gongs and clappers, take their cats to the nearest streams, where the animals are sprinkled and bathed.¹

Many sailors also have a very curious notion that hens' eggs on board ship produce contrary winds, and on the occurrence of such winds they are likely to insist that the eggs must be thrown overboard.

Another of these folklore remnants of sailors is the idea that there is a distinct relation between the albatross and wind. This superstition has been embalmed in most attractive form by Coleridge in his *Lay of the Ancient Mariner*. One stanza runs as follows:

For all averred I had killed the bird
That made the breeze to blow.
Oh, wretch! said they, the bird to slay
That made the breeze to blow.

In addition to the above folklore remnants there are some methods which are purely magical. The earliest reference of this sort which I have found is the case of Sópater. He is said to have caused a horrible famine in Asia Minor by "chaining the winds." He was put to death by Constantine—probably for this reason, as this crime was forbidden by the laws of the Twelve Tables, as well as later in the Theodosian code.

The association of weather making with the witches in Finland is familiar. Steele, in his *Medieval Lore*, from Bartholomew Anglicus (about 1260), referring to the people in Finland, says:

"The men . . . occupy themselves with witchcraft, and so to men that sail by their coasts, and also to men that abide with them for default of wind; they prefer wind to sailing, and so they sell wind.

¹ Forbes. Eastern Archipelago, page 75.

They used to make a clue [skein] of thread, and they make divers knots to be knit therein, and then they command to draw out of the clue to three knots, more or less, as they will have the wind more soft or strong; and for their misbelief fiends move the air and arise strong tempests, or soft, as they draweth of the clue more or less knots; and sometimes they move the wind so strongly that the wretches that believe in such doings are drowned by the rightful doom of God."

The elder bush is especially associated with weather making. The witches were thought to make bad weather by stirring water with branches of the elder.

Still another remnant of ancient superstition is, according to Aubrey (1696), to the effect that "On Malvern Hills, in Worcestershire, and thereabouts, when they farm their corn and want wind they cry 'Youle! youle! youle!' to invite it, which word, no doubt, is a corruption of Æolus, the god of the winds." (Dr. R. Fletcher.)

III.—PHYSICAL METHODS.

WEATHER MAKERS.

What precedes relates to purely psychic methods of controlling the weather or the elements. The collection which it presents has been made in no spirit of disrespect, but solely in that of the collection and scientific comparison of facts. I have great respect for all sincere religious belief and great interest in folklore remnants—fragments of what have once been great psychic structures—ruins about the tombs of the ancients. What follows is intensely *fin de siècle* and treats of the paradoxer in a well-developed stage. The paradoxer deserves a respect to be measured by the sufficiency of his information and the correctness of his logic. He is a possible benefactor of the world, a potential great man. Galileo was a paradoxer—very unwelcome to the Aristotelians of his time. Kepler was a rank paradoxer to his contemporaries, and Newton was a paradoxer to the Cartesians of his day.

Time will not be spent on rash paradoxers in the field of weather making. We shall only consider those who have some such guarantee as a patent, an appropriation, or genuine learning. As an illustration of the rash paradoxers, I will simply mention two, one the man who proposed to destroy blizzards by a line of coal stoves along our northern boundary from Red River to the Continental Divide, and the other a man who proposed to ameliorate the weather of New England and the Canadian provinces by damming the Strait of Belle Isle.

WEATHER MAKING.

We pass first to the treatment for tornadoes. M. Weyher has made laboratory tornadoes of a mild and gentle character, but they contain no suggestion as to how to treat this pathologic phenomenon of the weather.

A treatment has been suggested, which is heroic and may possibly be effective. It is, however, a local application, and the chief difficulty is to have it ready when and where wanted. The method proposed is that of a great explosion in the tornado itself. Many plans have been suggested, and two patents have been granted. I will consider the first, that of Mr. J. B. Atwater, of Chicago (No. 370845, 1887). A strong box with a double bottom is firmly supported on a pole erected at a suitable point, probably a mile or so southwest of the village to be protected. The upper bottom is fixed, and the space above it is filled with an explosive and firmly closed. In holes in the upper bottom are inserted fulminating caps, and these project below its lower surface. The lower bottom slides up and down. Then, if a high wind drives the lower bottom against the upper with such force as to flash the caps, the explosion follows, and the tornado (if present) suffers the effects which a tornado will suffer when a powerful explosion occurs in its immediate vicinity.

What these effects will be we do not yet know. It is said, with enough repetition to make it fairly worthy of credence, that a cannon fired into a waterspout destroys the latter. If such a disturbance destroys the gentler waterspout, it may be worth while to try a larger one on the more intense tornado. Perhaps it will be effective; we can be more positive when it has been tried.

Many other schemes have been proposed for the control of the elements of the weather. Most of them have an objectionable side, notably in rain making, which can be pointed out here as well as elsewhere. It is this: The phenomenon to be produced probably can not be controlled as to area covered, and may occur where it is not wanted. If we are clothing merchants and I carry over too large a stock of winter clothing into late spring, I may order a cold wave to help me reduce my stock. But you may have exhausted your winter stock and wish to have warm weather to start your summer stock. My cold wave affects your trade seriously; I may be sued for damages. Such a state of things is said to have actually happened in Kansas, where a rain maker was refused payment by his employer because of failure of contract, and was sued by a neighbor of the employer because his crops were washed out of the ground. Should the weather maker prosper he will often find himself very much embarrassed until our lawmakers have caught up with our advance in the arts, and the volume of the statute books has been materially enlarged.

RAIN MAKING.

We come now to the subject of rain making, which has attracted more attention, been more tried, and has more history than any other one method of weather making. It has attained the dignity of at least two patents and two Congressional appropriations. A bibliography of the subject is appended, containing sixty-four titles, two of which refer to books devoted to this subject, by Power and Gathman, respectively.

First method.—To clear the way for the American history we may note here as method No. 1 a French method reported in the Comptes Rendus for October 23, 1893. M. Baudouin sent a note to the French Academy of Sciences in which he wrote that in Algeria, earlier in that year, he used a kite to obtain electric connection with a cloud at the height of about 4,000 feet. As soon as this connection was made a few drops of rain fell and a local fog formed. These disappeared on breaking the connection, presumably by withdrawing the kite from the cloud. M. Baudouin had obtained some rain in Algeria in 1876 by the same method. I know of no other experiments in this direction, nor do they involve anything in opposition to knowledge already acquired. It is a fair field for experiment, and it is remarkable that M. Baudouin's experiments have not attracted more attention in the United States.

Second method.—A second proposed method of obtaining rain is by means of great fires. With this proposal the name of a Pennsylvania meteorologist, James P. Espy, is inseparably connected. In 1841 he published a Philosophy of Storms, in which he enlarged on this idea previously propounded by him in occasional articles dating from 1838. The idea was not new, for Dobrizhoffer, a Jesuit missionary in South America, in his Account of the Abipones (first published in 1784), says that these Indians produced rain by setting fire to the plains. Indeed the idea has been and is generally entertained, and in the West has crystallized into the weather proverb, "A very large prairie fire will cause rain." To show something of the character of the testimony on which Espy relied we shall quote the story of George Mackay as given in a letter to Espy and printed by him in his Fourth Meteorological Report (pp. 32-34). Mr. Mackay says:

"In 1845 I was engaged in the public survey on the Atlantic coast of Florida. Sometime in April (the time of the dry season there, which lasts up to June) I was running a township line between latitudes 26° and 27° , about 5 miles from the sea. The weather was oppressively warm that day. There was not air enough stirring to move an aspen leaf. We found our line must pass through a saw-grass pond, containing about 500 acres. In ponds of this description the green grass at the top shoots up from 5 to 6 feet in height, and when the region has not been for some years swept clear by fires the dead and dry growths of preceding seasons accumulate under the latest growth, and are often found there from 2 to 4 feet in depth. They are exceedingly inflammable. When lighted in dry weather they burn with frightful rapidity and violence. Whenever, in our explorations, we came upon a place of this description we could only pass our line by cutting away the lofty fresh grass and wading (or rather wallowing) through the mud and the underrubbish. On the day in question we determined, as it was so hot, that to save ourselves trouble we would burn our way through. I had then no thought of your theory. In order to prevent the flames from running over the woods, through which we were obliged to pass, we communicated them at once to both sides of the spot we desired to open, that they might converge and combine in its center and not scatter laterally. In a very few minutes an awful blaze swept over the entire surface which we had marked out for our purpose.

We then crossed our line. Ere we had proceeded over 40 chains a delightful breeze sprang up and cooled the atmosphere, and presently a refreshing shower sparkled in the bright rays of the sun. All this excited no further observation than that it had not rained there before for a long time. I myself did not observe any smoke nor the formation of any cloud.

“Our work went on for some days without a repetition of our short cut at pioneering, some objection having been made when another burning was proposed, because the first one had rendered it difficult, after crossing the lines, to distinguish the white men from the negroes. At length, however, the pleasant breezes ceased, which had made the weather for a while endurable, and the still air and intense heat returned, and with them constant murmurs from the men, especially the negroes, whose duty it was to cut lines and mark trees. We were now on the confines of a saw-grass pond, and a much more formidable one than any we had yet encountered. Being surrounded by a cypress swamp, we concluded that it had never yet been burned. My assistant, Capt. Alexander Mackay, who was standing by my side, mentioned his having, in our late conflagration, observed the formation of a cloud at the apex of the smoke. He added that it had frequently since brought to his mind some account which he had read of Professor Espy’s theory. He suggested that there could not be a better opportunity than this to put the theory to the test, and being fond of a joke, he said he would like to astonish the superstitious negroes and to make them believe that he could call together the clouds and bring down rain. So we determined to make the experiment.

“When our party was all gathered at the halting place complaints of the extreme heat went around, and all unanimously agreed that a more confined and oppressive day had never been known to them. To these complaints the usual wishes for ‘a little breath of air’ and ‘a few drops of rain’ succeeded. ‘Cut through this pond,’ exclaimed the Captain, ‘and I will bring you more than a few drops of rain; I’ll give you a plentiful shower and a breeze, too, that shall wake you up. Come, boys, cut away, and when you’ve done you shall wash off the dust in a cold bath from the skies.’ They stared up and around; not a cloud as large as a man’s hand was to be seen, and they looked back at the Captain with a good-natured grin of incredulity. ‘Ho, ho! ha, ha! Captain make cloud out o’ nuffin’; he, he! Captain bring water all dis way from de sea? Ho, ho! ha, ha! he, he!’ Whereupon the Captain affected to be very indignant. To hasten his victory I ordered the grass to be set on fire. The flames soared forthwith above the tallest trees; a dense volume of smoke mounted upward spirally; the grass soon disappeared; we crossed over. As the smoky column broke and the cloud began to form, the Captain traced a large circle in the sand around him, and placed himself in its center, making fantastic figures and forming cabalistic phrases out of broken French. Still was the cloud unnoticed. All eyes were riveted upon the Captain, who stood gazing at the earth and shaping outlines of devils there. At this juncture came a roll of distant thunder. Every glance instantly turned upward; a cloud was spreading there; the thunders increased; the lightnings flashed more vividly; the knees of the negroes shook together with alarm. Already was the rain descending, and in torrents, though the clear sky could be seen in all directions under the cloud. The Captain meanwhile maintained his mystical attitude and continued his wild and extraordinary evolutions. Some of the whites, who were in the secret of the hoax, fell upon their knees, and were imitated by the negroes,

whose fears augmenting as the storm grew fiercer, with clasped hands fastened upon the Captain a stare of awe and deprecation. In short, the scene presented a more complete triumph of philosophy over ignorance than I could have supposed it possible to have been produced anywhere in the nineteenth century, and most especially anywhere in our enlightened Republic.

"We often fired the saw-grass marshes afterwards, and whenever there was no wind stirring we were sure to get a shower; and I say with perfect confidence that we never had a shower in April or May at any other time. Sometimes when there was a breeze it would carry the smoke toward the horizon, where there would seem to be a fall of rain."

Espy dwelt on this theory with great devotion, and in 1845 published a special letter addressed "To the friends of science," in which he proposed a plan for practical rain production. As the paper in question is now very rare and his plan possesses some features of interest, I quote it here:

"Let masses of timber to the amount of 40 acres for every 20 miles be prepared and fired simultaneously every seven days in the summer on the west of the United States, in a line of 600 or 700 miles long from north to south; then the following results seem highly probable, but not certain until the experiment is made: A rain of great length north and south will commence near or on the line of fire; this rain will travel eastward; it will not break up till it reaches far into the Atlantic Ocean; it will rain over the whole country east of the place of beginning; it will rain only a short time in any one place; it will not rain again until the next seventh day; it will rain enough and not too much in any one place; it will not be attended with violent wind, neither on land nor on the Atlantic Ocean; there will be no hail nor tornadoes at the time of the general rain nor intermediate; there will be no destructive floods, nor will the waters ever become very low; there will be no more oppressive heats nor injurious colds; the farmers and mariners will always know before the rains when they will commence and when they will terminate; all epidemic diseases originating from floods and subsequent droughts will cease; the proceeds of agriculture will be greatly increased, and the health and happiness of the citizens will be much promoted. These, I say, are the probable—not certain—results of the plan proposed—a plan which could be carried into operation for a sum which would not amount to half a cent a year to each individual in the United States; a plan, which, if successful, would benefit in a high degree not merely the landsman, but every mariner that plies the Atlantic. If this scheme should appear too gigantic to commence with let the trial be first made along the Alleghany Mountains; and let 40 acres of four 10-acre lots be fired every seven days through the summer in each of the counties of McKean, Clearfield, Cambria, and Somerset, in Pennsylvania; Allegany, in Maryland, and Hardy, Pendleton, Bath, Alleghany, and Montgomery, in Virginia. The 10-acre lots should be, as nearly as convenient, from 1 to 4 miles apart, in the form of a square, so that the up-moving column of air which shall be formed over them may have a wide base, and thus may ascend to a considerable height before it may be leaned out of the perpendicular by any wind which may exist at the time."

Espy's theory was practically the modern convective theory of storms, and to this most worthy student of science is due the credit of calling

effective attention to the part which the condensation of aqueous vapor plays in the mechanism of storms.

Third method.—Another proposed method of making rain artificially is that of L. Gathman, of Chicago, patented in 1891 (No. 462795). His method is to “suddenly chill the atmosphere by rapid evaporation, and it is also advisable to produce a heavy concussion in connection with the cooling in order to set the different air currents in motion. It is obvious that sudden and rapid evaporation in the upper regions of the atmosphere could be accomplished in various ways by the evaporation of various highly compressed gases; but the evaporation consequent upon the release of liquefied carbonic acid gas is thought to be the most efficient.” He proceeds:

“In accordance, therefore, with my invention, liquefied carbonic acid gas is liberated in the upper regions of the atmosphere and will, of course, instantly evaporate and spread out in a sheet of vapor of an extremely low temperature and produce a cloud. The surrounding atmosphere will be chilled by its proximity to the cold vapor, and the moisture in the atmosphere will be condensed thereby. The condensation takes place in large quantities and with great rapidity, so that a cloud is formed that will precipitate a rainfall upon the earth.

“The liquefied carbonic acid gas can be confined in a suitable shell or casing, said casing also to contain an explosive—gunpowder, dynamite, etc.—which is thrown or shot into the upper regions of the atmosphere and there exploded by a time fuse. A balloon, moreover, could be employed to elevate the shell or casing containing the liquefied carbonic acid gas, and the explosion to liberate the gas could be made by an electric current controlled by persons upon the earth.”

Mr. Gathman also published a little book in which were reproduced, with approval, Professor Newcomb’s article entitled, “Can we make it rain?” and Professor Houston’s “Artificial rain making.” In this book we learn that Mr. Gathman has been occupied with the use of condensed carbon anhydride to cool heavy guns, and was led to his theory by the results of his experiments with ordnance. He also experimented on his method of rain making, and says (p. 38):

“In making some experiments last year, a shell filled with liquefied carbonic acid gas was exploded at a height of 600 feet; a cloud was produced in the clear sky at once, and, floating along on a current of air, was visible for miles. This experiment was made in July, 1890, and since that time I have made sufficient other experiments to satisfy myself that I can produce rain whenever necessary, or at will. Experiments made in my astronomical observatory, at a height of only 75 feet, have proven that by the evaporation of liquefied carbonic acid gas a rain shower on a small scale can be produced with but a small quantity of the gas. When completed arrangements have been made, the experiments mentioned will be seen to be but a step to the practical illustration on a grand scale.”

It appears that in Gathman’s method the explosion plays a very subordinate part; but in the method to follow the explosion is the main, if not the only, thing.

Fourth method.—The concussion theory is probably an old one, though it is not correct to refer it to Plutarch, as is sometimes done.

In his life of Marius, referring to the battle with the Teutons near Aix, in July, 102 B. C., Plutarch says: "Extraordinary rains pretty generally fall after great battles; whether it be that some divine power thus washes and cleanses the polluted earth with showers from above, or that moist and heavy evaporations steaming forth from the blood and corruption thicken the air, which naturally is subject to alteration from the smallest causes."¹ Here are two distinct suggestions for rain making, but not that of concussion.

The first elaborate treatment of the concussion theory appears to have been by Edward Powers, civil engineer, who published in 1890 a book on the relations of battles to rainfall. The first edition was printed in Chicago in 1871, but most of the edition was destroyed by the great fire in that city, which also destroyed the stereotype plates. The latest issue seen by me contains an inset of 15 pages devoted to a criticism of Professor Newcomb's article already mentioned. The aim of this book is to prove that great battles or heavy cannonading are usually soon followed by rainfall. A fair criticism of the book is that such phenomena are not invariably followed by rain. The coincidences could be explained by the fact that in the season of military operations rain is usually falling somewhere in eastern United States; that in fact it is not clear but that the rain is a pure coincidence. The argument is not conclusive. Indeed, it is only fair to say that under the conditions involved it could not be made conclusive. Mr. Powers, however, did not despond, but used his utmost endeavors to bring the matter to a test. For this purpose he persuaded Senator Farwell, in 1874, to present a petition to Congress asking that the theory be tried. This, with a previous petition to which he refers, seems to have been without response on the part of Congress.

Later, and apparently independently, the matter was taken up by Gen. Daniel Ruggles, of Fredericksburg, Va., who obtained a patent in 1880 (No. 230067) on making rain by explosions in the clouds. His claim runs:

"The nature of my invention consists in sending one or more balloons into the cloud realms, said balloon or balloons carrying torpedoes and cartridges charged with explosives, and there to explode or detonate them by magneto-electric or electric force through metallic wire, textile cordage, or by the fuse, or by mechanical force, in order to precipitate rainfall by concussion or vibration of the atmosphere."

General Ruggles succeeded in bringing the matter before Congress, but did not succeed in getting an appropriation. His plan was much discussed in the newspapers at the time, but does not seem to have reached the experimental stage.

Senator Farwell, however, continued his interest in the matter, and in 1890 finally succeeded in obtaining an appropriation, first of \$2,000,

¹Plutarch's Lives, Clough's revision, Am. Book Exchange edition, 1881, pages 390, 391.

then of \$7,000, for carrying on the experiments, some of which he had already had made at his own expense. The appropriation assigned the conduct of the experiments to the Department of Agriculture, and the Secretary selected R. G. Dyrenforth for the work. The experiments were carried on in the vicinity of Washington and in Texas. A report from Mr. Dyrenforth was published by Congress in 1892. At the next session of Congress another appropriation of \$10,000 was made for this purpose, of which the sum of \$4,913.59 was expended, as before, under Dyrenforth's direction, the remainder having been covered back into the Treasury.

Mr. Dyrenforth's methods were highly ingenious. He used a variety of explosives, on the ground and in the air, by great single explosions and by volleys. He introduced many novelties, among them that of exploding the gas in the balloon itself when high in the air. His conclusions, as stated by himself in his first report, were (p. 59):

"First. That when a moist cloud is present, which, if undisturbed, would pass away without precipitating its moisture, the jarring of the cloud by concussions will cause the particles of moisture in suspension to agglomerate and fall in greater or less quantity, according to the degree of moistness of the air in and beneath the cloud.

"Second. That by taking advantage of those periods which frequently occur in droughts, and in most if not in all sections of the United States where precipitation is insufficient for vegetation, and during which atmospheric conditions favor rainfall, without there being actual rain, precipitation may be caused by concussion.

"Third. That under the most unfavorable conditions for precipitation, conditions which need never be taken in operations to produce rain, storm conditions may be generated and rain be induced, there being, however, a wasteful expenditure of both time and material in overcoming unfavorable conditions."

His second report has not been published, but I infer that his second series of observations were believed by him to confirm the results of the first.

Mr. Dyrenforth generally omitted one check which he might well have employed, and which I personally urged him to employ. Experiments of this sort, made in the free air, with the accompanying conditions not under control, should be accompanied with every possible check; and one self-evident and very necessary one is the observation of a physicist familiar with the meteorologic side of physics. Such an expert (Mr. G. E. Curtis) accompanied the party in its first experiments. His report (except the bare meteorologic record made during the experiments) does not accompany Dyrenforth's document. It was presented, however, to the Philosophical Society of Washington, and was printed elsewhere. Mr. Curtis says, substantially, that an explosion in a cloud brings down a few scattering drops of rain, and this may happen even with an explosion on the ground, if heavy. Otherwise he says there was no rain making. It is but fair to say that with Mr. Dyrenforth's report are given the reports of his assistants, Mr. John

T. Ellis, Lieut. S. A. Dyer, and Mr. Eugene Fairchild, and they were stronger in the expression of a belief that rain was successfully made than is Mr. Dyrenforth; and there are also many favorable quotations from spectators.

Prof. A. Macfarlane, of the University of Texas, was present as an uninvited guest during the elaborate experiments near San Antonio on Friday, November 25, 1892, beginning at 4 p. m. The sky was from time to time overcast, and the natural conditions were not unfavorable for rain. Many explosions were made without rain until late in the evening, from which point I will take up the story in Professor Macfarlane's own words, as given in a letter to the *New York World* December 4, 1892:

"At 10.15 a balloon was sent up and was lost in the darkness; when it exploded a very large area of light was seen, as if the explosion had occurred inside a cloud. There was no fall of rain at the camp, and nobody was stationed below the spot where the balloon exploded.

"I consider this the only experiment that was worth making, yet no care was taken to observe whether rain did fall. It is conceivable that the explosion of a 12-foot balloon inside a cloud ready to precipitate may jar the particles so as to quicken the dropping of the rain. This was the idea of Ruggles. But to test whether some rain can be drawn down in this manner from a rain cloud does not suit the ideas of cranks who wish to get a large something out of an absolute nothing.

"At 10.45 a mist became just perceptible. The General issued an order to get ready the rain gauge. The boys hurried up a balloon, which was nearly ready, but it had no effect on that mist.

"At 11.40 the mist ceased, and the stars appeared in places nearly overhead. The General apparently felt that things were going against him, for he suggested to the Doctor to put a small piece of dynamite in the shells, and also to try the effect of an explosion down at the springs.

"At 12.30 a 12-foot balloon went well into the cloud, but no rain effect.

"At 1 o'clock, the time when operations were to be suspended for the night, it was fair, with some stars visible, and the boys were preparing one more balloon. Colonel King remarked that it would be necessary to keep up the operations for forty-eight hours. I retired to a room in the hotel, from which I could see the operations.

"At 1.30 I heard a slight shout from the balloon boys, and I could hear the rain pattering on the roof. The General, who had also retired to the hotel, threw open the window and called out: 'Hurry up, boys.' After ten minutes the balloon was exploded, and the rain almost immediately diminished so as to be scarcely perceptible. When the explosion occurred I had my head out of the window. The hotel, a frame house, shook considerably, but there was no breaking of glass or any of the effects produced by a powerful explosion on the solid earth.

"At 1.50 the General went out to observe, and I heard him say: 'There is a beautiful rain to the north of us and to the west of us.'

"At 2 the rain had entirely ceased, and the last of the operations consisted of two shells fired in succession at 2.05."

Professor Macfarlane is a competent physicist. He was trained in Edinburgh, and has, I believe, no such appreciation of humor as to

make him unconsciously color his report. His conclusions were adverse to the rain makers.

Referring in general to the experiments in Texas, one fact has been generally overlooked. The rainfall in western Texas is always small, but it is subject to its maxima and minima, like other regions. Now, there is a rainfall season in July and August in Arizona and New Mexico, and this reaches western Texas. Thirty per cent of the annual rainfall descends in these two months along the eastern border of New Mexico and in the western angle of Texas. At El Paso this percentage is 40. This maximum passes gradually eastward and is found in the southeastern part in September. The experiments in the western part of Texas in 1891 were in September, fairly in the time of this maximum. There is another maximum of rainfall in Texas in November. This is in the northeastern part of the State. The second series of rainfall experiments in Texas was in November, 1892, at San Antonio. The maximum here occurs in September, but there is in November an average (for twenty-four years) of 2.5 inches, or one-twelfth of the annual 30.6 inches. There is a high relative probability of rain naturally in September in the region of the experiments in 1891, and there is an even chance of it in the region of 1892. To test the theory of rain making in Texas the months might have been better chosen; yet it is but fair to say that the rainfall in western Texas is very fluctuating, as it comes generally in local storms.

Fifth method.—There is another method of rain making which is still a mystery, but which deserves mention because it has been submitted to actual test. I have not been given permission to use names in this case, and will only guarantee that the letter which I quote came from a high official of a railway company and is worthy of the credence which an official business letter of this sort should carry with it. This gentleman, under date of August 22, 1893, wrote to me as follows:

“DEAR SIR: Your letter, August 10, - - - has been referred to me. In reply thereto, we have no published reports concerning rain-making experiments such as mentioned by you. While these experiments have been made by a couple of employees of this company, we can say but little about them ourselves. These parties claimed to be able to cause rainfall by artificial means, and we have furnished them with materials, together with transportation facilities, more or less all the time since the early part of May, they having experimented in some eighteen or twenty different locations, and in each case we have had more or less rainfall. In nearly every instance we can but feel there is something in their claim. We have had from one-half to 3 or 3½ inch falls of rain, covering a section of country from 25 to 90 miles in length and 10 to 30 miles wide, all owing to the direction of the wind, and in some cases at times when there was no moisture in sight or known until they began operations, and then only throughout the section over which their own rainfall extended.

“I presume the operators themselves have kept a record of their work, and results of same, at each of the different points where they have been located, and should you desire I will have them make a state-

ment showing what they themselves feel they have accomplished. We have been slow to believe there was anything in this business, but at the same time must admit that they are either very fortunate in reaching the different points where they have experimented just in time to have rain storms, or they have certainly hit upon the right thing in the way of rain making."

The process I do not know, but a humorous railway man, personally cognizant of the matter, told me that the operators kept themselves carefully secluded in a freight car with a hole in the roof, and when occasional glimpses were caught of them they seemed to be cooking over a red-hot coal stove. Probably the method employed was that of Frank Melbourne, the Australian, who has most reputation in the West, and who has carefully kept his secret. It is proposed by the company in question to continue the experiments in another field and with competent experts accompanying, and another railroad company is seriously considering the propriety of entering the field.

CONCLUSIONS.

Finally, permit me to complete this sketch by some remarks; and, to make them as specific as they can be made, permit me to put them in the form of questions and answers. The answers are my own.

Q. Will a noise make rain?—A. No; there is no reason in theory or practice to make us think it will.

Q. Will a concussion make rain?—A. It will probably jostle the droplets in a cloud and may bring a few together, which may coalesce and become large enough to cause them to fall to the ground—a few scattering drops only.

Q. Will smoke or dust released in great quantities produce rain?—A. Floating particles of spongy texture will absorb the moisture hygroscopically. If the air is dry this will make it drier, and prevent rain. If the air is very moist and near saturation, any solid particles in the air will facilitate the condensation; witness the experiments of Aitken and Barus. Thus, when other conditions are very favorable, an addition of much dust or smoke to the air might determine a fall of rain.

Q. Will the expansion of carbon anhydride produce rain?—A. Mr. Gathman says he has tried it and with success. Experiments should be made systematically.

Q. Will electric connection with a cloud aid in rain formation?—A. M. Baudouin says it does.

Q. Will a conflagration produce rain?—A. Quite probably, under favorable circumstances. It acts in the line in which nature acts, according to the best of our knowledge. Condensation is the result of chilling the air. The theory of chilling by mixture, the Huttonian theory, a century old, is now known to be inefficient. The chilling in nature seems to be due either to the ascent of air and its consequent expansion and loss of heat, or the chilling of one cloud by having the shadow of a higher cloud fall on it in sunlight. The chilling by ascent

is the method evoked in the Espy plan, and appears to be by all odds the most effective rain producer in nature.

Q. If rain can be made, how much will it cost?—A. This is truly an American question, and quite appropriate to the fin de siècle. Mr. Powers, who, by the way, says that Mr. Dyrenforth did not after all really try *his* experiment, put the cost of one experiment with Government aid at \$80,000. Gathman says he can sprinkle the earth at a cost of from \$30 to \$90 a square mile. Espy proposed to fire the low forest growths at regular intervals at a cost less than 5 mills per citizen per year. The method of concussion costs the comfort and peace of all within hearing, a cost which a much more certain result would not justify.

LIST OF REFERENCES TO THE LITERATURE ON THE ARTIFICIAL PRODUCTION OF RAINFALL.

- ATWATER, JOHN B. Cyclone-destroyer: United States patent No. 370845, October 4, 1887; 2 pp., 1 pl.
- ABBE, CLEVELAND. The Production of Rain: Report Maryland State Weather Service, Vol. II, 1892, pp. 64-65.
- On the Production of Rain: Agric. Sci. State College Pennsylvania, Vol. VI, 1892, pp. 288-309. [Abstract: Amer. Met. Journ., Vol. IX, 1892, pp. 312-316; Symon's Met. Mag., London, Vol. XXVII, 1892, pp. 129-137, 154-155.]
- BELL, G. H. A Rain Controller: Sci. Amer., New York, Vol. XLIII, 1880, p. 113.
- BELLE, DANIEL. La Pluie artificielle dans l'Inde: La Nature, Paris, 23 Avril, 1892, pp. 321-322.
- BLAKE, LUCIEN J. Can we make it Rain? Science, New York, Vol. XVIII, 1891, pp. 296-297.
- BLUNT, W. B. Automatic Tornado-breaker: United States patent No. 290956, December 25, 1883; 2 pp., 2 pls.
- BROWN, L. L. Automatic Transporter and Exploder for Explosives for Aiding Rainfall: United States patent No. 473820, April 26, 1892; 2 pp., 1 pl.
- BRUEGMANN, H. Einwirkung des Kanonendonners auf die Regenbildung: Petermann's Mitth., Gotha, 1862, pp. 439-440.
- CURTIS, GEORGE E. Rain Making in Texas: Nature, London, Vol. XLIV, 1891, p. 591.
- Rain Making in Texas: The Inventive Age, Washington, Vol. III, 1891, p. 2.
- The Facts About Rain Making: Engin. Mag., New York, Vol. III, 1892, pp. 540-551.
- CURTISS, G. G. The Production of Rain: Report Maryland State Weather Service, Vol. II, 1892, pp. 63-64.
- DAVIS, W. M. The Theories of Artificial and Natural Rainfall: Amer. Met. Journal, Ann Arbor, Vol. VIII, 1891-92, pp. 493-502.
- Der Einfluss des Krieges auf die Witterung: Illustr. Zeitung, Leipzig, B. II, 1870, No. 1418.
- DYRENFORTH, ROBERT G., and NEWCOMB, SIMON. Can We Make it Rain? N. Amer. Rev., New York, Vol. CLIII, 1891, pp. 385-404.
- ESPY, JAMES P. Artificial Rains [from the National Gazette]: In "Philosophy of Storms," 8°, Boston, 1841, pp. 492-518.
- To the Friends of Science (on producing rain by artificial means), 8° (Philadelphia), 1845; 6 pp.
- (Concerning the artificial production of rain). In his Fourth Met. Report: 34th Cong., 3d session, Senate Ex. Doc. 65, 1857, 4°.
- FERNOW, B. E. Artificial Rain: Report Secretary of Agriculture, 1890, pp. 227-236.
- GATHMAN, LOUIS. Method of Producing Rainfall: United States patent No. 462795, November 10, 1891, 1 p., 1 pl.
- GATHMAN, LOUIS. Rain Produced at Will: 8°, Chicago, 1891; 61 pp.
- GATTA, L. La Guerra e la Meteorologia. Considerazioni intorno agli effetti dello sparo dell'artiglieria e della fuociera sullo stato dell'atmosfera: 4°, Roma, 1875.
- GUYOT, P. Faut-il tirer le Canon pour avoir de la Pluie? Sci. pour Tous, Paris, T. XVII, 1872, pp. 236-238, 244.
- HAZEN, H. A. The Production of Rain: Report Maryland State Weather Service, 1892, Vol. II, pp. 69-70.
- Rain Making: Sci. Amer., New York, October 31, 1891, p. 277.
- HAZEWELL, C. C. Weather in War: Atlantic Mon., Boston, May, 1862, pp. 593-606.
- HOUSTON, EDWIN J. Artificial Rain Making: Jour. Franklin Inst., Philadelphia, Vol. CXXXII, 1891 (October), pp. 308-315; Sci. Amer. Suppl., No. 824, October 17, 1891, p. 13161.
- L—. Artificial Production of Rain: Science, Cambridge, Vol. III, 1884, p. 276; La Natura, Milano, Vol. I, 1884, p. 270.

- LAUGHTON, J. K. Can Weather be Influenced by Artificial Means? *Nature*, London, Vol. III, 1870-71, pp. 306-307.
- LE MAOUT, CHARLES. Exposé de la Doctrine des Condensations (Artificial production of rain): 8°, Saint-Brieuc, 1856; 17 pp.
- Effets du Canon et du Son des Cloches sur l'Atmosphère: 8°, Saint-Brieuc, 1861; 15 pp.
- Le Canon et la Pluie: 8°, Saint-Brieuc, 1870; 9 pp.
- Cuirassés, Torpilles et Tempêtes: 8°, Cherbourg, 1891; 6 pp.
- Lettre adressée par Charles Le Maout au "Petit Journal," le 23 février 1887. *Météorologie* (Artificial production of rain): 8°, Cherbourg, 1891; 6 pp.
- LE MAOUT, ÉMILE. Lettre à M. Tremblay sur les Moyens proposés pour faire cesser la Sécheresse des six premiers mois de l'année, 1870: 8°, n. p. (1891); 16 pp.
- LEWIS, J. C. Rain Following the Discharge of Ordnance (note to the National Intelligencer, July 25, 1861): *Amer. Journ. Sci.*, New Haven, Vol. XXXII, 1861, p. 296; *Petermann's Mitth.*, Gotha, 1862, p. 113.
- MACFARLANE, ALEXANDER. On Rain-Making (December 31, 1892): *Trans. Texas Acad. Sci.*, Austin, Vol. I, 1892-93, pp. 70-80.
- NEWCOMB, SIMON. See Dyrenforth.
- NOYES, ISAAC P. The Weather Map and the Rain Makers: 8°, Washington, 1892; 46 pp.
- Ob die Blitzableiter (Gewitter und Regen verhindern und demnach Dürre verursachen können? *Schles. Prov.-Bl.*, Breslau, 1793, number 1.
- On Great Meteorological Changes which have Followed Violent Engagements in War: *Quart. Journal Sci.*, London, Vol. VIII, 1871, p. 126.
- PICCARD, J. F. Connexion entre le Nombre des Incendies et celui de Jours de Pluie dans le canton de Vaud, pendant la Période de 1840 à 1864: *Bull. Soc. Vaud, Lausanne*, T. IX, 1866-68, pp. 167-189.
- POTTS, T. H. Rain after Fire: *Nature*, London, Vol. VI, 1872, p. 121.
- POWERS, EDWARD. War and the Weather, or the Artificial Production of Rain: 12°, Chicago, 1871; 171 pp.; 2d ed., revised, 12°, Delavan, Wis., 1890, 202 pp.
- Should the Rainfall Experiments be Continued? A criticism of Prof. Simon Newcomb's contribution to the article in the *North American Review* for October, 1891, entitled "Can we make it rain?" 12°, Delavan, Wis., 1892, 15 pp.
- Rain Making: *Science*, New York, Vol. XIX, 1892, pp. 52-53.
- Production of Rain by Human Agency: *Sci. Amer. Suppl.*, New York, Vol. III, 1877, p. 1070.
- Rain Makers and Science: *The Nation*, Oct. 1, 1891, p. 253.
- Rain Makers in India: *Sci. Amer. Suppl.*, New York, October 17, 1891.
- Rain Making: *Symon's Met. Mag.*, London, Vol. XXVI, 1891, pp. 134-137.
- ROWELL, G. A. On the Production of Rain at Will: *Builder*, London, 1880, pp. 265, 298.
- Artificial Aurora and Precipitation of Rain: 8°, Oxford, 1883. Privately printed.
- RUGGLES, DANIEL. New Method of Precipitating Rainfalls: *Sci. Amer.*, New York, Vol. XLIII, 1880, pp. 106, 342; *Les Mondes*, Paris, T. LI, 1880, pp. 850-851; *Année Sci. Indust.*, Paris, T. XXIV, 1880, pp. 69-71; *Cronica Cient.*, Barcelona, Vol. IV, 1881, pp. 53-54.
- Method of Precipitating Rainfalls: United States patent No. 230067, July 13, 1880; 2pp., 1 pl.
- RUSSELL, ROBERT. Rain Produced by Fires: *Nature*, London, Vol. III, 1870-71, p. 448.
- SCHREIBER, PAUL. Ueber die in Nordamerika angestellten Versuche zur künstlichen Erzeugung von Regen. (A lecture before the Saxon Economical Society, February 10, 1893): *Mitth. der Ock.-Gesell. im Königr. Sachsen*, B. V, 1892-93, 8°, 22 pp.
- SCHROEPFER, A. Einwirkung des Kanonendonners auf die Regenbildung: *Petermann's Mitth.*, Gotha, 1862, pp. 312-313.
- STONE, G. H. Rain Making by Concussion in the Rocky Mountains: *Science*, New York, Vol. XIX, 1892, p. 52.
- TICE, J. H. Do Battles Cause Storms? *Amer. Meteorologist*, St. Louis, Vol. I (No. 6), 1876, pp. 138-145.
- TROWBRIDGE, JOHN. Great Fires and Rain Storms: *Pop. Sci. Month.*, New York, Vol. II, 1873, pp. 206-211.
- UNITED STATES DEPARTMENT OF AGRICULTURE. Letter from the Secretary of Agriculture transmitting a report of the special agent of the Department of Agriculture for making experiments in the production of rainfall: 52d Cong., 1st Session, Senate Ex. Doc. 45, 8°, Washington, 1892, 59 pp., 9 pls.
- VAN BIBBER, ANDREW. Rain not Produced by Cannonading: *Sci. Amer.*, New York, Vol. XLIII, 1880, p. 405.
- WALTON, J. P. Rain Making: *Kansas Academy of Sciences*, February 12, 1894, 8°; 3 pp.
- WARD, R. DE C. Artificial Rain; a Review of the Subject to the Close of 1889: *Amer. Metl. Journal*, Ann Arbor, Vol. VIII, 1891-92, pp. 484-493.

VARIATION OF LATITUDE.¹

By J. K. REES.

The question is frequently asked, "How can latitude change?" There are two ways, obviously. First, we may imagine that a portion of the earth slips on the surface of the globe, due, say, to earthquake shock. Then if the movement of the mass has been toward the equator the latitude of that place is decreased; if toward the pole of the earth the latitude is increased. But suppose that some forces at work on the earth cause it to revolve about a new axis, then we have at once a new equator, and the latitudes of all points on the earth's surface change except at those places where the old and new equator intersect.

If, for example, the earth's axis of revolution should be changed so as to pass through this hall, the latitude would be changed from a little over 40° , as it now is, to 90° . There are changes no doubt produced by the slipping of portions of the earth's strata, but we know that these causes are insignificant and local. The only way that latitudes could be made to change throughout the world would be by changes in the axis of rotation of the earth, thus changing the position of the equator.

Are there any undisputed evidences of a variation in the latitude of a place, and is it large?

To-day the evidence is overwhelming, but the amount is small; so small, in fact, that only the refined instruments of the present day have been able to discover it; though now, that it is discovered, older observations show it.

Laplace, in his *Mécanique Céleste* (Tome V, p. 22), says: "All astronomy depends upon the invariability of the earth's axis of rotation and upon the uniformity of this rotation."

He considered that down to the beginning of this century astronomical instruments had not been able to show any variation of latitudes.

¹ From a lecture before the New York Academy of Sciences, April 29, 1895. Printed in *Science*, new series, Vol. I, No. 21.

There were differences, but these he thought could be accounted for as errors of observation.¹

To-day, however, we feel certain that small variations in latitude are taking place, but so small that practically, in map making, for example, and in navigation, they are of no importance, though scientifically very important.

It might also, in this connection, be stated that there are theoretical reasons which seem to indicate that the earth's rotation time is not only changing, but also is not altogether uniform. The effect of the tide wave as it moves west over the earth is to act as a friction brake on the revolving earth, and so slow up the rotation time; and as this tide effect is not always the same the retarding effects differ, and theoretically produce a nonuniformity in the rotation time. But the shrinkage of the earth, due to loss of heat, would tend to make it revolve more rapidly. These effects may work against each other. However, observations and calculations to-day do not furnish us with any certain evidence that the rotation time is longer or shorter than it was ten centuries ago.

It no doubt will happen that, when observations and instruments are much improved, astronomers will discover these slight changes in rotation time that theory seems to require.

The idea that the latitudes of places change is not a new one.

Down to about the time that the telescope was invented there were many learned persons who believed that the latitudes of places changed several degrees in the course of centuries. These ideas were based on a comparison of maps made at different times.

A disciple of the illustrious Copernicus considered that the evidence was conclusive, and was satisfied that the pole of the earth was changing its position in a progressive manner; he considered that in time the torrid and frigid zones would change places.

However, these views of Dominique Maria de Ferrare were founded on poor data. The latitudes of a few places had been determined, by very imperfect means, in the best way they had, viz, from the shadow cast by a gnomon; but the latitudes of many places on the maps were put in from the accounts of travelers, the time it took to travel from one point to another being used as the basis of calculation.

Even in these enlightened days, as we like to consider them, there is no good map of our own Empire State. The latitudes of a few points only in New York State have been determined with accuracy. But there are many places in the State whose positions are not known within more than a mile.

In the latter part of the sixteenth century Tycho Brahe, of Denmark, improved the instruments in use (without the telescope), and later, about 1610, the telescope was discovered and applied to astronomical instruments. Then new and more accurate methods were used to

¹ The writer is much indebted to the paper by Professor Doolittle on "Variations of latitude," read before the A. A. A. S., at Madison, Wis., August, 1893.

determine latitude, and the large discrepancies disappeared. Some observers found differences between latitudes determined in winter and in summer, and they supposed those differences to be due to changes of the pole.

In the latter part of the seventeenth century J. D. Cassini summed up the state of the problem in his day, and arrived at the conclusion that, notwithstanding the apparent variations in the latitudes, the pole of the earth did not change to any large extent; that most of the apparent changes in latitude were due to errors of observation and defects in theory; but he thought it probable that small changes did occur in the position of the pole; he thought the changes were periodic, and did not amount to more than 2 minutes of arc, equal to about 12,000 feet. "Thus, instead of several degrees which were conceded by the astronomers of previous centuries, but a paltry 2 minutes was now allowed; but with improved instruments, with the discovery of aberration and nutation and the perfection of the theory of refraction even this modest allowance was gradually reduced to a vanishing quantity."

The geologists in their investigations have found fossil remains in the cold regions of the North belonging to the Miocene, Upper and Lower Cretaceous, Jurassic, and other geological periods, which seem to indicate a former temperature much higher than the present. In 1876 Dr. John Evans, then president of the British Geological Society, discussed the problem, and concluded that the amount of polar light and heat in the past must have been much greater than it is now. He invited the attention of the mathematicians to this problem, and asked: "Would a considerable elevation and depression of the sea bottoms and continents produce a change of 15 to 20 degrees in the position of the pole?"

Sir William Thomson discussed this problem and gave his conclusions in 1876 to the British Association for Advancement of Science. He said: "Consider the great facts of the Himalayas and Andes and Africa, and the depths of the Atlantic, and America and the depths of the Pacific, and Australia; and consider further the ellipticity of the equatorial section of the sea level, estimated by Colonel Clarke at about one-tenth of the mean ellipticity of the meridional sections of the sea level. We need no brush from a comet's tail to account for a change in the earth's axis; we need no violent convulsions producing a sudden distortion on a great scale, with change of axis of maximum moment of inertia, followed by gigantic deluges; and we may not merely admit, but assert as highly probable, that the axis of maximum inertia and the axis of rotation, always near one another, may have been in ancient times very far from their present geographical position, and may have gradually shifted through 10, 20, 30, or 40 or more degrees without at any time any perceptible sudden disturbance of either land or water."

Sir William Thomson gave no account of the calculations made by him as the basis of these conclusions.

In 1877 Mr. G. H. Darwin made a careful and elaborate mathematical discussion of the problem. He showed that in a perfectly rigid globe the pole could not have wandered more than 3 degrees from its original position as the result of the continents and oceans changing places. "If, however, the earth is sufficiently plastic to admit of readjustment to new forms of equilibrium, by earthquakes and otherwise, possible changes of 10 or 15 degrees may have occurred. This would require, however, such a complete changing about of the continents and oceans, with maximum elevations and depressions in precisely the most favorable places, as has certainly never occurred in geologic times."

The evidence indicates in fact that the continental areas have always occupied about the same positions as now.

Thus it would seem that the geologists must abandon the hypothesis of great changes in latitude as a factor in the earth's development, unless a new cause can be found that will move the pole to the extent required by the geologists.

In an address made before Section A, of the British Association in 1892, Professor Shuster stated that he believed the evidence at hand was in favor of the view that there was sufficient matter in interplanetary space to make it a conductor of electricity. This conductivity, however, must be small, for if it were not, he said, the earth would gradually set itself to revolve about its magnetic poles. However, changes in the position of the magnetic poles would tend to prevent this result. Perhaps the investigator in the near future, working on the suggestion of Dr. Shuster, may find some connection between the earth's magnetism, rotation time, and position of rotation axis.

The evidence then, at this phase of the discussion, is in favor of the view that there is no adequate reason for believing that any large changes of latitude, amounting to several degrees, have occurred in geologic times. The evidence shows, however, that there are small changes. Are they progressive; does the north pole of the earth wander slowly but surely farther and farther away from its positions of ages gone by?

At the International Geodetic Congress held in 1883 at Rome, Sig. Fergola, of the Royal Observatory, Cappodimonti, Naples, gave a tabular statement which seemed to show that small but progressive changes had taken place in Europe and America. This table showed, for example, that the latitude of Washington, D. C., had decreased from 1845 to 1865, $0.47''$; at Paris, from 1825 to 1853, the decrease was $1.8''$; at Milan in sixty years, $1.5''$; at Rome during fifty-six years, $0.17''$; at Naples in fifty-one years, $0.22''$; at Königsberg in twenty-three years, $0.15''$; at Greenwich in nineteen years, $0.51''$. Fergola, at the congress mentioned, suggested a plan for making systematic observations, and he pointed out the favorable location of several observatories that were on nearly the same circle of latitude, but differing widely in longitude. Unfortunately this suggestion of Fergola's was not carried out in any way until 1892, when the Columbia College

Observatory arranged to work in conjunction with the Naples Observatory on the problem. This series of observations was begun in the spring of 1893, and will be continued several years.

The data given by Fergola at Rome in 1883 showed a diminution of latitude in every case; other data showed a similar diminution; however there were exceptions, where the latitudes seemed to increase.

The investigations that have been going on since 1883 throw doubt on the progressive changes in latitude, or at least such changes are masked by proved periodic changes.

For a long time, since 1765, periodic changes have been looked for, because the theory of a rotating earth, an earth having the form of a sphere flattened at the poles, or, more accurately, an ellipsoid of revolution, demanded such changes; but the theory did not furnish any clue to the amount of changes, except that they must be very small. This theory shows that if the earth were absolutely rigid and revolved about its shortest axis (called the axis of figure) at any time it would continue to revolve about such axis forever, unless disturbed by some outside force. If so disturbed, then the axis of rotation would no longer coincide with the axis of figure—the axis of rotation would intersect the earth's surface at points away from the points where the axis of figure comes out. But the theory also showed that the new axis of rotation would revolve about the old one in a period of 304.3 days. This period comes from the knowledge of the magnitude of precession and nutation, and is known very accurately.

We would expect therefore that changes in latitude would show this 305-day period.

Several attempts have been made to determine the distance between the two axes (figure and rotation axis) from changes in latitudes.

The celebrated astronomer Bessel made the first attempt, and was unsuccessful it was supposed until recently.¹

¹ Tisserand says in *Ann. Bur. Long.*, 1895 (p. 42, B. 11), that there is a letter of April 7, 1846, in which Humboldt replies to Gauss that Bessel had told him in 1844 that his observations showed that his latitude had decreased 0.3" in two years. Bessel attributed this variation to changes accomplished in the interior of the globe. See also Hagan's letter in *Astr. Nach.*, September, 1894.

In this connection it ought to be noted also that Prof. J. C. Maxwell read a paper April 20, 1857, before the Royal Society of Edinburgh (see *Transactions Roy. Soc. Edinburgh*, Vol. XXI, Part IV, pp. 559-571), "On a dynamical top for exhibiting the phenomena of the motion of a system of invariable form about a fixed point, with some suggestions as to the earth's motion." He deduced a period of 325.6 solar days. He examined the observations of Polaris made with the Greenwich transit circle in the years 1851-1854. He found the apparent colatitude of Greenwich for each month of the four years specified.

There appeared a very slight indication of a maximum belonging to the set of months, March, 1851; February, 1852; December, 1852; November, 1853; September, 1854. "This result," he says, "is to be regarded as very doubtful, as there did not appear to be evidence for any variation exceeding half a second of space, and more observations would be required to establish the existence of so small a variation at all."

Observations were also made at Pulkova, Russia, Greenwich, and Washington. The Washington observations were made between 1862 and 1867, and included six complete periods of 305 days each. A rigorous discussion by Newcomb gave the separation of the axes as 3 feet, or $0.03''$.

C. A. F. Peters, of Pulkova, had in 1842, obtained $0.079'' = 8$ feet.

These figures are small, but fairly accordant. A reinvestigation, however, showed that the various calculations did not agree in showing the same displacement at the same time. This made the whole result doubtful, so that Newcomb (in 1892, March, Mon. Not. R. A. S.) remarked that "the observations showed beyond doubt there could be no inequality of the kind looked for."

It was while investigations of this kind, to determine the separation of the axis of rotation and axis of figure, were going on that Sir William Thomson (now Lord Kelvin) announced, at the congress of the British Association at Glasgow in 1874, that the meteorological phenomena, the fall of rain and snow, the changes which occur in the circulation of the air and of the sea waters, would modify a little the mechanical constitution of the globe, and displace a little the axis of figure, i. e., the form of the earth would be changed by the causes mentioned, and so a new shortest axis would be made. The effect of this would be to produce a change in the latitudes of places, evidently. He thought that it might amount to $0.50''$, which would correspond to a movement of the old axis (at the pole) of 50 feet on the earth's surface. Sir William Thomson did not publish his calculation, but the authority of the great English mathematician and physicist was such as to make scientific men give the statement great attention. These meteorologic phenomena of which Sir William Thomson spoke are annual in character. When this annual period is combined with the 305-day or ten-month period of Euler we see that complexity results. This was the state of the investigation when Dr. Küstner, of the Berlin Observatory, published the results of his observations made in 1884-85. Dr. Küstner undertook some observations for the trial of a new method for the determination of the constant of aberration. On reducing his observations he obtained results which were not at all satisfactory. A careful examination of his work led him to make the announcement that the unsatisfactory value for the aberration constant was due to a comparatively rapid, though very small, change in the latitude of the Berlin Observatory—"that from August to November, 1884, the latitude of Berlin had been from $0.2''$ to $0.3''$ greater than from March to May in 1884 and 1885."

This would indicate that from August to November, 1884, the pole of the earth had approached Berlin more closely by 20 to 30 feet than in the time from March to May.

This conclusion was fortified by the examination of other data, obtained from the observations made at Pulkova by Nyrén.

Here, then, was evidence of a comparatively rapid change in latitude. New observations were undertaken at Berlin, Potsdam, Prague, and Bethlehem, Pa. (all by Talcott's method), and all agreed in showing plus and minus changes in latitude for the years 1888-1890.

There were still some doubters. Moreover, it was decided to critically test the matter by sending an expedition to the Sandwich Islands, which is 180 degrees (nearly) in longitude from Berlin. If it were known the latitude of Berlin increased, then a point in the Northern Hemisphere 180 degrees away from Berlin should simultaneously show a decrease in latitude, for if the pole move toward Berlin it must move from the point on the other side of the earth.

Our own Government joined in the effort. Marcuse, of Berlin, and Preston, of Washington, spent more than a year on the Sandwich Islands observing for latitude, while at the same time observations were continued at Berlin, Prague, and Strasburg in Europe, and at Rockville, Bethlehem, and San Francisco in the United States. The results of all these observations have been published, and show, without a chance of error, that the earth's axis is moving, that the latitudes at the Sandwich Islands increased when the latitudes in Germany diminished, and vice versa.

The law of the change was eagerly and industriously sought for by some of the ablest mathematical astronomers of the world. They first worked on the idea that the changes must conform to the 305-day period of Euler, combined with an annual change due to causes set forth by Sir William Thomson, and which I have previously mentioned. None of these investigations have given a satisfactory formula for the prediction of the latitude of any place.

In 1891 Dr. S. C. Chandler, of Cambridge, Mass., began his investigation of the problem. He remarks:

"I deliberately put aside all teaching of theory, because it seemed to me high time that the facts should be examined by a purely inductive process; that the nugatory results of all attempts to detect the existence of the Eulerian period (of 305 days) probably arose from a defect of the theory itself, and that the entangled condition of the whole subject required that it should be examined afresh by processes unfettered by any preconceived notions whatever. The problem which I therefore proposed to myself was to see whether it would not be possible to lay the numerous ghosts in the shape of various discordant, residual phenomena pertaining to determinations of aberration, parallaxes, latitudes, and the like, which have heretofore flitted elusively about the astronomy of precision during the century, or to reduce them to some tangible form by some simple consistent hypothesis. It was thought that if this could be done a study of the nature of the forces as thus indicated, by which the earth's rotation is influenced, might tend to a physical explanation of them."

Dr. Chandler proceeded to examine his own work with the Almucantar at Cambridge, the observations of Küstner, Gylden Nyrén, the Washington observations, and others. He found that they all seemed

to indicate that the pole of the rotation axis was moving from west to east about the axis of figure of the earth in a period of 427 days. Other observations did not seem to confirm this period. Finally he made an elaborate analysis of 33,000 observations between 1837 and 1891, and the result was an empirical law which can be announced as follows:

The pole of the rotation axis of the earth moved with its greatest velocity about the pole of the axis of figure about the year 1774; the period then was 348 days. The velocity has diminished with an accelerated rate since then. In 1890 the period was 443 days. The distance of one pole from the other was about 22 feet, equal to $0.22''$.

Further elaborate examination of this material developed the exceedingly important and interesting result that the changes in latitude were the sum of two periodic fluctuations superposed on each other. One had a period of about 427 days and an amplitude of $0.12''$; the second had a period of a year, with an amplitude that was variable between $0.04''$ and $0.20''$.

Sometimes these two fluctuations worked together, giving a total range of $0.33''$, and at times they conspired against each other, reducing the range to a minimum of a few hundredths of a second. He compared his theory with the observations, and the result was, in the main, exceedingly satisfactory.

His conclusions were attacked as to the 427-day term. The annual term could be explained as due to meteorologic causes.

Professor Newcomb, however, in March, 1892, explained, in a paper communicated to the Monthly Notices of the Royal Astronomical Society, that in deducting the Eulerian period of 305 days the earth, as we have remarked, was considered absolutely rigid; that when the effect of the mobility of the oceans and of the lack of perfect rigidity of the earth were taken into account, the mathematics required a time of rotation of the true pole about the axis of figure longer than the previously accepted 305 days. Making certain assumptions, Newcomb obtained a period of 443 days.¹

An additional interesting conclusion which Dr. Chandler has lately published is that the fluctuation with a period of 427-428 days is a circular one, as theory seems to demand, while the annual fluctuations appear elliptical in character.

An exceedingly interesting and important confirmation of the Chandlerian period of 427 days, or about 14 months, was lately announced by M. Tisserand. Examination has been made of the tide records of the Helder in Holland. These are kept with great accuracy. It has been found that between 1851 and 1893 these tide records show a variation in the average sea level indicating a 14-month period. The greatest

¹Prof. R. S. Woodward has lately obtained, by a new discussion of the theoretical problem, a formula that seems to indicate the correctness of Chandler's empirical formula.

divergencies are very small, only 14 millimeters, equal to one-half inch about, but they appear unmistakably and are what theory would demand.

In a letter, recently received from Dr. Chandler, he states that he finds that the annual part of the polar motion is an ellipse three or four times as long as broad, and he expresses the law of the motion of the pole in this ellipse as that the areas described from the center are proportional to the times.

We can conclude safely, therefore, that no large changes of latitude have taken place for many thousands of years; in fact, in geologic times, that there is no adequate proof of progressive changes in the latitude of any place; but, finally, that very small periodic changes have occurred, and they are such as can be and are observed.

The feeling is growing in the minds of those who have given the subject close attention that we shall find that many and various causes enter into the problem of determining the law of changes. It will no doubt take many years of careful observation to obtain the data necessary to fully test Dr. Chandler's, or any other hypothesis.

The scientific men abroad are discussing the advisability of establishing several observatories at various places on the earth's surface for the purpose of collecting the data.

Ultimately Dr. Chandler's formula, or a slight modification of it, may be proved correct, and with it we may be able to state what the latitude of any place will be at any time.

The lecture was followed by some illustrations showing that revolving bodies preferred to revolve about their shortest axis or around the axis about which the moment of inertia was a maximum.

Charts and diagrams were exhibited showing the results of observations made at Pulkova, Prague, Berlin, Strasburg, Bethlehem, the Sandwich Islands, etc.

These results were compared with the deductions from Chandler's formula and shown to agree therewith to a remarkable extent.

The preliminary results of the observations made at Columbia College from May, 1893, to July, 1894, were exhibited.

The lecturer threw on the screen illustrations of several forms of zenith telescopes, and described the new form made by Wanschaff, of Berlin.

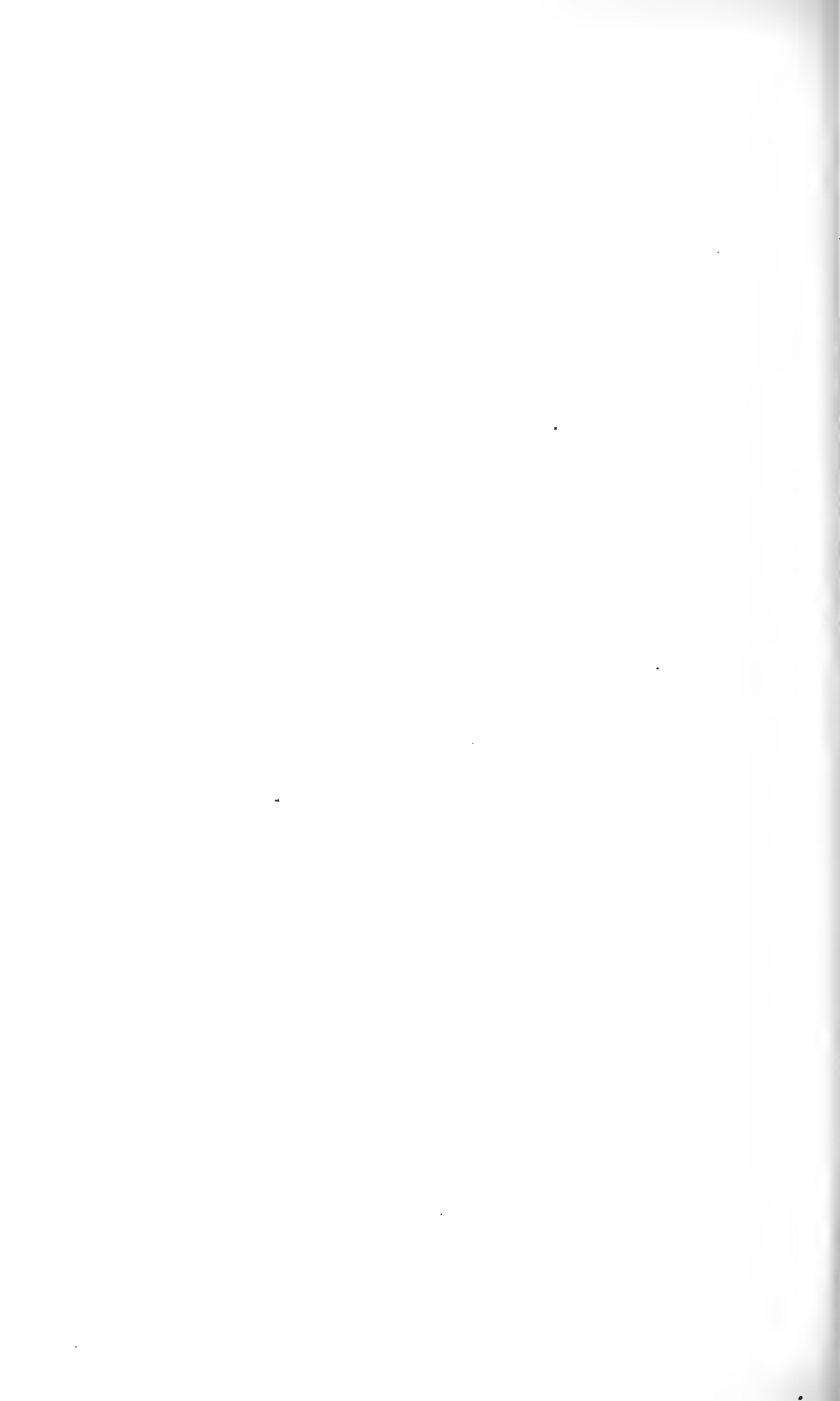

THE DEVELOPMENT OF THE CARTOGRAPHY OF AMERICA UP TO THE YEAR 1570.¹

By Dr. SOPHUS RUGE.

The discovery of America and the geographical researches on that continent may be regarded as the initial period of the era of discovery. In order to intelligently trace the gradual dawning of a new world upon the geographical chart and, at the same time, to compare the discoveries made by the several pilots and to estimate briefly their value from a scientific point of view, I have selected the medium of a collection of thirty-two maps, upon which are represented the progress of discovery from decade to decade.

This cartographical evolution ends with the year 1570, for in that year first appeared Ortelius's *Theatrum Orbis*, the earliest modern atlas, by which, in numerous editions and in various languages, we have an easily accessible collection of new charts. Previous to that publication, exclusive of the rare collection of Lafreris, the maps of the several engravers, through successive years combined, were printed only in single sheets or introduced as such in scientific works of the most dissimilar character.

The present maps contain four series of illustrations. The first series (Pls. XVII-XX) exhibits, on modern charts, the coasts and inland regions that have been discovered. The second series (Pls. XXI-XXIV) presents to our view the results of the observations of the pilots to whom we are indebted for the production of these maps.

Naturally, with the exception of the Cosa chart, no original surveys could be represented, but they are, on the contrary, copies and transcripts of copies which are extant, a compilation gathered from different sources, so that only the general impression of the ideas promulgated at the time are shown to us. In details, however, and specially in local names, numerous inaccuracies occur.

Finally, the third and fourth series (Pls. XXV-XLV) introduce to us the scientific conclusions of geographers and the inductions of scientists together with established theories in regard to the positions of

¹Translated from Dr. A. Petermann's *Mitteilungen*, 1892. *Ergänzungsheft* Nr. 106.

the new, relatively to the known world. Here the originals are, almost without exception, modified typographically, and they are either woodcuts or copper engravings. Copies, however, are introduced of manuscripts and of painted globes. Where single charts, simply marine charts, have been struck off, which, however, but seldom occurs, they are given uncolored and without doctrinal reasoning or scientific significance. For the information of the scholar, which it was necessary to express in the third or fourth series, two series were requisite, partly in order to give an indication of the abundance of the theories, that often changed as suddenly as they arose, and partly with a view to introduce into this history all prominent or representative names.

In order to subjoin to the discoveries as well as to the charts the necessary explanations, inasmuch as they could only be given cursorily and summarily in a map, the second and special part of this paper comprises a history of the voyages of discovery and exploration, and the necessary material for charts, all of which is chronologically arranged.¹ The important points in a history of discoveries are not alone to clearly set forth the more prominent incidents of the earlier voyages, and especially those of Colon, as also the names given to the discovered localities, but likewise to give the sources of evidence, and opportunely, works of critical research. In the course of the sixteenth century the more real discoveries cease, and the more brief, generally speaking, are communications and critical observations. The chronological series of charts that are accessible, in so far as they are geographical, possess a certain value and are given with the utmost completeness possible. Among them the principal works of HARRISSE offer the most valid claims to our recognition. I confidently believe that although this series is far from being exhaustive, it will nevertheless be acceptable to those who are interested in the too-little-cultivated history of cartography. The works, too, are cited, as far as known to me, in which the respective charts are to be found, either in facsimile or imitation.

For a critical analysis and appreciation of the charts themselves, and an understanding of their relation one to another, synoptical tables of all the names and legends were requisite, the laborious preparation of which may not appear in a brief statement, but the value of which may be recognized from the few critical observations upon them.

In the third series, charts 1 and 2 revert to a period anterior even to the discovery of America by Columbus, in 1492. These are shown for the purpose of giving expression to ideas and theories on the lines of demarcation of countries which have had decided influence on posterity, such, for example as the Zamoiski codex of 1468 for Northern, and Behaim's Globus of 1492, for Eastern Asia. The questionable Zeno

¹ This history in detail of the several voyages and of the charts is too voluminous for translation here, covering about eighty pages of Petermann's *Mitteilungen*.

chart of 1380 (?) is included in the appended list,¹ for the reason that after its publication in the year 1558, not merely did the Italian Ptolemæus editions, but even Mercator, as well, follow its delineation of the northern regions.

THE MARINE CHARTS.

The art of designing marine charts originated with the Italians. When the Portuguese Prince Henry began his discoveries he sought to obtain Italians for his enterprises. So likewise in chart design, or drafts, Italians became the instructors of the Portuguese, and with the latter the Basques appeared as skillful mariners and cartographers. Not until toward the middle of the sixteenth century did nautical cartography find its entrance into France. It did not reach either England or Germany at the epoch of the great discoveries. But in Spain, to which is due the most ancient cartography of the most important regions in America, guidance and enlightenment were derived from Italians, Basques, and Portuguese. And thus the material for American cartography consists of Spanish, Portuguese, Italian, and more recently of French charts, or coast pilots. The language of these charts is exclusively Romanish.

But, unfortunately, original drafts are hardly accessible. Unfortunately, also, most of the track charts no longer exist. "What, in the lapse of time, has been preserved from shipwreck, or the hands of the gold-beaters, is as yet not fully ascertained, and very little indeed has been described" (Harrisse, Cabot, p. 139). As often as pictures of the uprising New World vary in the first decades, just so often do the charts become antiquated and dangerous as guides. It therefore became necessary from considerations of prudence or utility to discard or destroy the more ancient. Thus it happens that neither in Spain nor in Portugal is there to be found a chart of America for the first fifteen years of the sixteenth century, with the exception of that oldest map of the world, which was recovered from France, and on which the New World is represented—the noted chart of the Basque pilot Juan de la Cosa. The earliest charts that have been preserved, next to that of Cosa, the marine charts of Canario and Cantero, and that of Kunstmann in his atlas of published sheets, Nos. 2 and 3, are to be found in the collections of Italy, France, and Germany. And even these, collectively, are no longer original, but imitations and compilations collected from various State archives. And although Cosa, in the delineation of America, has pronounced his work as original, his chart upon the whole is merely a compilation.

The elaborate, and in many respects incisive criticism which Harrisse² above all others, has devoted to the subject, has enabled us, in

¹List not translated.

²"Names, when methodically interrogated, yield very useful results, which reach even distant questions." (Harrisse, *Disc. of N. America*, p. 325.)

special instances to determine what originals were used in drawing some of the chart copies, but it is impossible to say how far original and copy agree with each other. So, also, the oldest manuscripts for a cartographic history of America are not originals, but merely arbitrary combinations of various copies, not drawn from originals of equivalent value, for the value of a first impression on the mind is always dependent upon the intelligence of the pilot. Every copyist is subjected to the risk of committing errors, through a misapprehension, or perhaps through careless haste. And here no connected text is employed, as in the transcript of a literary composition, but individual names without connection or correlation are strung along, like beads, upon the water line of a seacoast. Cosmographers, too, avail themselves in numerous instances of abbreviations in favor at the time, and employed in manuscripts. The points designated along the coast are in some localities so crowded together that errors may readily occur in their repetition, not alone through the misinterpretation of a name badly or illegibly written, but in some cases from its entire omission. And thus the correct reduplication of a series of appellations, so closely written, would be rendered almost impracticable. Besides, if copperplates or woodcuts were designed for charts written upon parchment, the brittle character of the material on which it must be printed would doubtless make necessary a reduction in the number of the local names. It could not be assumed, moreover, that due discrimination had been exercised in the topography of these sheets, and only the less unimportant particulars omitted.

The principal share in the explorations made along the American seacoast unquestionably belongs to the Spanish pilots, or to those employed in the service of Spain. But it must in no wise be supposed from this that Spanish influence in the development of the cartography of America has been very considerable. The reverse, indeed, is the case. Spanish cartography, it is true, begins immediately after the first voyage of Colon, and innumerable traces in the literature of the country, and the manuscripts contained in their archives, afford ample evidence of the rapid development among them of the art of sketching and designing marine charts. But despite this fact, the dissemination of this art throughout Spain, and its progress toward northern regions, and consequent influence upon the cartographic conceptions of middle Europe during the first quarter of the sixteenth century, can not be established. Columbus had promised to draw up a chart of the discoveries of his first voyage, and he had held out to their majesties an assurance of its execution on his return home. On the 5th of September, 1493, he was again reminded of his engagement by Queen Isabella (Navarr. II., p. 122., 2d edition, 1859). Meanwhile the court records communicate nothing to us, in respect either to the dispatch of the chart or its receipt. It is proved in several ways that a chart of his third voyage was in existence. Hojeda saw it first at Bishop Fon-

seca's, and obtained a copy of the chart for his own first voyage (Navarr. III, pp. 539, 586). But of all his charts, not one has been preserved.

The restored chart of Juan de la Cosa, 1500, is, then, the earliest cartographic memorial handed down to us; and in this map the skillful Basque mariner has combined in one exhibit the various Spanish discoveries, and, possibly also, the discoveries of John Cabot in North America.

The incidents of the fourth voyage of the Admiral in 1502-1504 were rapidly disseminated throughout Europe, for not only Columbus himself and his brother Bartholomew, but likewise the other mariners had each designed charts. It might therefore be readily inferred that not merely facts but names themselves might vary in many important particulars. Charts were no mystery, and they might be indiscriminately reproduced, or even acquired by purchase. In Portugal there was a chart industry, and there was an open traffic in them under the restriction, however, that it was forbidden, under a heavy penalty, to draw plans of the route by sea to the Molucca Islands. We thus find that later on an Italian draftsman, Baptista Agnese, contributed, as a supplement to his finely executed collection of maps, a chart of the world, upon which the Molucca route was clearly traced, and it was recognized as such.

When, in 1500, the Portuguese Indian fleet under Cabral discovered Brazil, and when in succeeding years Portuguese vessels had coasted along a considerable portion of the eastern coast of South America, it appears that in Portugal they encouraged the publication of these facts. This was naturally in the highest degree obnoxious to the Spaniards, for at Lisbon copies of the charts were willingly accorded to Italians. It appears further that charts of Cabot's voyages were brought to Lisbon earlier than to Spain. At all events, the explorations of Cortoreal and the earliest received charts of Cantino and Canario had their origin in Portugal. To a wide diffusion of the incidents of his own voyages in Portuguese ships, Vespucci himself contributed, as they were accustomed to say, through picture and narrative; and thus the influence of Portuguese charts, copied by Italians, upon the ideas of Middle Europe was already inaugurated before Spanish cartography was directed into regular channels. The first foundation for the system was laid in the establishment of the Indian office at Seville in 1503. The lead in all transmarine enterprises emanated from the Casa de Contratacion for the Indies. Here were necessarily collected charts of all recent discoveries. But it would necessarily soon become evident that such charts, based upon charts often widely deviating from each other and giving imperfect or erroneous delineations of the coasts in the new hemisphere, would rather expose mariners to danger than afford them security. It became necessary, therefore, to exercise a many-sided critique and careful investigation of the charts accessible, and care be taken that seamen were

furnished with the most accurate maps obtainable and designed upon uniform principles.

The progress here indicated was associated with the nomination of Amerigo Vespucci in 1508 to be chief pilot in Spain. The plan was then first conceived of drawing under his supervision an official general map of the regions discovered (Navarr. III, p. 300). Juan Diaz de Solis and Vincencio Yañez Pinzon were associated with him. Of all the charts then in existence that of Andres de Morales was declared to be the best, and it was raised to the grade of an official chart, or royal padron. No mariner was permitted to have on board his ship, under a penalty of 50 doubloons (\$240), any other chart. But it was more easy to issue than to enforce such an order.

When Amerigo Vespucci died, on the 22d of February, 1512, Diaz de Solis succeeded him as chief pilot. In the same year, the latter, together with the nephew of Amerigo, Juan Vespucci, received a commission to draw up an official chart. In consideration of this they were each to receive the privilege of copying and selling the royal padron. But other cartographers did not trouble themselves about this privilege. During subsequent years, and up to the period of Diaz de Solis's death, we are informed of several convocations of a junta through which the preparation of an official chart might be expedited, but it seems that many impediments were encountered in its execution. And, in fact, no trace has been preserved of any similarly authorized charts. The question here was an exact determination of the longitude of Cape St. Augustine, in Brazil, according to which it was hoped that the line of demarcation of the Portuguese claims in South America might be definitely adjusted, for the Portuguese were determined to imprison every Spaniard who overstepped the boundary. Incorrect charts, moreover, exposed seamen to imminent peril in that locality.

It has been supposed that Sheets IV and V in Kunstmann's Atlas were promulgated as results of the junta of 1515 (Kohl, Generalkarten, p. 30), for these charts must have appeared subsequent to 1513, inasmuch as Balboa's South Sea is indicated upon them. But these two charts represent two different standpoints. No. IV represents the Portuguese claim in Brazil as proved by the line of demarcation through that country and the long legend upon the Portuguese side, while No. V defends Spanish pretensions, according to which the boundary line recognizes as valid, in behalf of the claims of Portugal, only the extreme projection of Brazil. The first chart employs the medium of the Portuguese tongue; the second of the Italian. The uncertainty as to a comprehensive idea of the new regions lasted only a few years; that is to say, until the shores of the Mexican Gulf were taken up by Pinedo or until Sebastian d'Elcano, of Magellan's squadron, brought home the earliest charts of the southern extremity of South America. Moreover, not until about 1522 or 1523 was the Spanish coast line in America fully determined in the west, through their

researches on the broad ocean, as furnished by the surveys of Cortez and Pizarro. And now the idea of a universal official map or "padron" was once more reverted to.

In the year 1526 Ferdinand Columbus received an order to prepare an accurate chart, and this, by a later imperial decree, was to be entitled the "general padron." But when, after the lapse of nine years, a reiterated command was dispatched to the son of the Admiral to complete the work, it must not be concluded that up to that period he had not executed the commission or supplied any map whatever. Nor does this entirely justify the assumption that the Weimaraner general chart of 1527, the first general map, originated with him. The second, designed by Ribero, and the general map of 1527, and that of 1529, essentially altered, have both likewise been preserved. The approved type exhibited in each of these charts was henceforth as a general rule steadily adhered to.

Though the Portuguese occupy a subordinate rank as regards the extent of their contributions to the cartography of America, the distinction is assuredly due them of having first conceived and portrayed the continent of North America in its correct and proper contour, exclusive, of course, of the polar regions. They were able pilots and expert draftsmen, and not only by their labors, but by their methods, they have exercised a vast influence, especially upon geographical works in Germany. Many of their pilots and draftsmen emigrated secretly from Portugal into Spain and entered into the service of Charles V. Such, for example, were Francisco and Ruy Faliero, Jorge and Pedro Reinel, and Simon de Alcazaba de Sotomayor. Along with these, and even to a greater extent than the latter, Italians emigrated to Spain. Only Columbus, however, with Amerigo and Juan Vespucci, are here mentioned (Harrisse, Cabot, p. 219). Two of the earliest and most important cartographic records, the charts of Cantino and Canerio, although supplied or drawn by Italians, are copies of Portuguese originals. Both of these, as also the surveys of the coasts of the New World sent to the Duke René of Lothringen, had a far-reaching influence upon scientific cosmography.

This influence, however, emanates from Italians residing abroad. Harrisse calls attention to the fact (Discovery of North America, p. 270) that cartographers living in Italy only recently, comparatively, took notice of the discoveries of Spaniards and Portuguese in the New World, and with the exception of Johann Ruysch, a German, who copied in its essential details a Portuguese map of the New World for the Roman Ptolemäus of 1508, the Viscount di Maggiolo was the first who brought to Naples a representation of the newly discovered regions, in 1511. Cartographic activity in Italy, up to the year 1527, remained dependent upon Portuguese exemplars. Spanish influence is first detected in Maggiolo's chart of 1527. The French took part in these nautical and cartographic enterprises much later than the three south-

ern Romanish nations—the Italian, Spanish, and Portuguese. Here, too, an Italian, Giov. Verrazzano, in 1524, was the pioneer. The voyage of the first Frenchman, Jacques Cartier, followed ten years later, and although none of his original drawings have been preserved, the results of his first voyages of discovery shown upon the chart of the world by Nicolas Desliens of Dieppe, 1541, constitute the oldest French cartographic publications known to us. The latter is preserved in the Royal Library at Dresden.

But it was no longer possible for French cartography to exert a decided influence; on the contrary, their cosmographers showed themselves dependent, in many respects, upon Germany. The earliest marine chart, in a modern sense, in nautical use, the celebrated map of the world by Mercator, appeared in 1569, and consequently at the close of the period here under discussion. The uncertainty which prevailed for a decade in the delineation of the newly discovered coasts was chiefly due to inexact astronomical calculations. Calculations of latitude were naturally more easily determined than those of longitude. And when it is remarked that in the middle of the New World and in West Indian waters, where alone the Spaniard was enterprising, vacillation prevailed longest, while north and south, in Newfoundland and Brazil, whither in the same year, 1500, came Portuguese vessels, long before the geographical latitude was clearly determined, we necessarily reach the conclusion that the Portuguese were greatly in advance of the Spaniards in their nautical skill and ability.

Columbus himself did not rise above the companions of his voyages in knowledge and address. Information which comes to us, second-hand, of his observations of latitude betrays a vacillation and hesitancy between his own tendencies and the chart of Toscanelli, which he blindly followed. H. Harrisse in his latest work (*Discovery of North America*, p. 401), adopts, however, the conclusion of Humboldt, that Columbus did not have on board a chart of Toscanelli, for he would otherwise have crossed the ocean under the parallel of Lisbon. I consider, however, this assumption as untenable, for the rich territories of Eastern Asia, the goal of his western voyages, must first be sought in the torrid zone, or in the vicinity of that zone; and it is questionable whether it would not have been more advisable to navigate seas that were known, those for example, from Spain to the Canaries, on the borders of the Tropics, than to seek a fresh route thither on the unknown waters of Eastern Asia. In the second place, according to the chart, as may be seen on Behaim's copy, two very desirable anchorages were to be anticipated at Antilia and Zipangu, on the western route, from the Canaries to Zayton, under rather similar conditions, whereby a sea voyage of indefinite length was broken in a very welcome manner. In the third place, it is manifest from the daybook of the Admiral that he hoped to reach these points. Antilia he desired to visit upon his return voyage, since he did not find it precisely where he

supposed from his chart he ought to have found it, and Zipangu he believed he had discovered on reaching Haiti. All the observations of the discoverer respecting his ideas of the division of land and water are intelligible through this chart. And lastly, due weight should be given to the highly important testimony of Bishop Las Casas, which, in view of its manifold repetitions, should not be treated as a common error, as is sometimes the case with his statements.

Las Casas (Lib. I, chap. 12, Bd. I, p. 96) having referred to the geographical error of Toscanelli, through which, in a western voyage, the territories of the "Grosschans" were first touched upon (remarks which, in an abbreviated form and in part also verbally, are again met with in the histories, Chap. VIII¹) the Bishop adds some significant paragraphs to this, which are omitted in the histories, being somewhat equivocal as affecting the reputation of the Genoese: "La carta de marear (Toscanelli) que le invi6, yo, que esta historia escribo, tengo en mi poder, y della se har4 m4s mencion abajo." (The marine chart which I sent to him, I, who am writing this history, hold in my custody, and about which further mention will be made below.) And a few lines farther on he adds: "Y ansi creo que todo su viaje sobre esta carta fund6." (I believe also that his [Columbus's] entire voyage was based upon this chart.) Then Las Casas again returns to the chart in his narrative of the first passage across the ocean, when Columbus, on September 25, 1492, withheld the marine chart of Martin Alfonso Pinzon, while borne onward upon the ocean waters which they were then navigating. It was a question of the precise situation of Antilia. Here Las Casas remarks, in chapter 38 (p. 279): "Esta carta es la, que envio Paulo, f4sico, el Florentin, la cual tengo en mi poder." (This is the chart which the Florentine physician [Toscanelli] sent, whom I hold in my power.) Toscanelli's chart was held in high estimation by Columbus. Of this there can exist no doubt, for no other chart was obtainable that exhibited the entire ocean as far as the coast of Asia. He must have had the Toscanelli chart on board, for he could have guided himself by none other, and he piloted his course solely by this chart.

The uncertainty of the latitudes, which I ascribe to the influence of Toscanelli, can even be recognized in a chart handed down from very early times. It is Table II in Kunstmann's Atlas. Here the shores of the Greater Antilles extend from Puerto Rico to Cuba, and directly onward to the northwest, so that the northwestern extremity of Cuba reaches the fiftieth parallel of latitude. Such errors disappear gradually, and not until after the death of Colon, and by degrees only, does the tropical circle assume its proper position relatively to the Greater Antilles. The correct delineation of the chart does not come to us until it is first exhibited in the general map of 1527. On the other hand, the mouth of the Amazon was correctly placed, from the

¹I say designedly "again met with," for I consider here Las Casas as the original and the one upon which the historians have drawn.

first, under the equator. The eastern projection of Brazil, Cape St. Augustine, appears early in its proper situation. Far more difficult than the latitude was the determination of the longitude. They could not then reckon astronomically. It was much easier to ascertain the dangerous character of the coast through an estimate of the rapidity of the passage. But that even here opinions differed may be perceived from the varying estimates of pilots on the occasion of the first voyage of Colon. His own observations or calculations of latitude are no better than those of his contemporaries. Nor do I believe that the few astronomical efforts that were made to determine the longitude on American soil have had any influence upon the maps. It is therefore not to be wondered at that the eastern shores of the New World, namely, South and Central America, should be removed 3 to 5 degrees too far toward the east. Things were even in a worse state in the beginning in the case of North America. The insular-like appearance of the shores of Newfoundland, Labrador, and Greenland (?) scarcely permit us, at first, to divine their actual character. The eastern coast of the present United States was quite delusive, extending horizontally from west to east, as if the ocean were quite dammed off on the north. As a necessary sequence, Newfoundland lay about 40 degrees too far to the east. These errors had undergone hardly any correction during the sixteenth century.

The line of demarcation, decided upon since 1494, frequently served on the general charts as an initial meridian. We first meet with it on Sheet IV, in Kunstmann's Atlas, and consequently somewhere about the year 1518. It here lies 21 to 22 degrees westward from the Cape Verde Island Santo Antonio, and hence 370 leagues remote from it, as was settled in the convention of Tordesillas in 1494. But Spanish cosmographers wished to remove it as far as possible to the east, in order to lessen the domains of Portugal. They were unable to come to a full settlement of this point. The old charts, whether of land or sea, track charts, or maps multiplied by typography, could alone supply a scientific desideratum where the date of restoration is clearly indicated by the compiler, and when, moreover, an exact computation of the time is made, or where this date may be ascertained with reasonable probability from the text. The greater portion of the old cartographic records that have been preserved are without date.

Of the twelve oldest sheets that we possess from the year 1500 to 1509, four are dated and eight are without date. We may regard it as a great piece of good fortune that the oldest chart of Juan de la Cosa that has been preserved bears a precise date, and that to the so-called Cantino chart a definite year may be ascribed with confidence through the letter that accompanies it. In other cases a determination of the time of a chart without date is always an extremely difficult problem.

It is true that in many instances it is possible to verify which are the most recent discoveries recorded, but it follows necessarily from this

that the chart could not have been delineated previous to the fact of its discovery. On the other hand, it can not be perceived after how long a space of time later on the cartographer executed the draft. If no one of the cartographers who were residing in Italy prior to 1508, or, more correctly speaking, anterior to 1511, take any note of America, such a fact should only counsel the exercise of extreme caution.

Inasmuch as with but few exceptions none of the original drafts have descended to us from remote times, and since the labors of successive pilots have been collected, for various years, into one general map, the difficulty of ascertaining the exact dates has been greatly increased. And yet, in the case of the port entry records, which were made up in the seaport towns, it is more easily established than through the sheets subsequently printed. The execution or engraving of the sheets required considerable time, the printing was often retarded a year or more, and all this must be weighed with the possibility that the latest designs were not always at the disposal of the scientist from whom these charts emanated. It thus happens that such sheets, without any date, were begun too prematurely. It is well ascertained that designs for the Ptolemæus charts (Strasburg, 1503) were six years at least in the hands of the college authorities at St. Dié before they were issued. And, moreover, Duke Renatus (deceased in 1508) had come into possession of the new marine charts of South America and South Africa, which, at a later period, are said to have embellished the Ptolemæus editions, although only in woodcut; and Martin Waldseemüller announced, in 1507, in a letter to Amerbach, St. Dié, of the 5th of April, that the charts would very soon appear in print.

The first known globe executed by Nordenskjöld presents another illustration of this (facsimile atlas, Table XXXVIII). The origin of this globe, Nordenskjöld thinks, may be traced to the years 1510 to 1515, while HARRISSE has proven by an inscription discovered in Haiti that we should not assign a date earlier than 1518 to the appearance of the globe.

In the same way the date of a chart of the world, designed by Descahier, the so-called chart of Henry II, was antedated by a year, until the inscription with the date itself was discovered upon the original. If, in the catalogue¹ of known charts, the figures of the year, in the case of charts without date, are definitely or approximately given, these figures should always be received with reserve, though I have always endeavored to follow only the most approved authorities.

In the study of marine charts another difficulty arises, where it is a question of identification or determination definitely of the old names and reconciling them with the existing local appellations, for only a portion of the names given by the discoverers themselves have been retained up to the present time. Many of them likewise have been modified, mutilated, or supplanted by other appellations even during

¹ Catalogue not translated.

the lifetime of their sponsors. The Spaniards ignored the distinctions of the Portuguese, and vice versa. Nay, more than this, of one and the same marine expedition varying or widely differing charts might be brought home by different pilots, and if upon these originals the names were abbreviated or illegibly written not inconsiderable discrepancies would necessarily arise in the first copies. The interpretation of the names, moreover, is fraught with the difficulty that discoverers have rarely given an exact description of the coasts in their written reports, for only very seldom indeed, as in the case of Columbus, are the ships' logbooks or even an epitome of them accessible. The reports, also, are not infrequently too vaguely or generally recorded—as, for example, in the four voyages of the two Vespuccis—to afford any medium for their correct interpretation. The description of the localities also often presents wide divergencies. As the signification or correct interpretation of the local names is often obscure or unintelligible, it is natural that to fresh inquiries an elucidation of these details is often embarrassing.

According to H. A. Schumacher's communication (Kohl's *American Studies*, in the German geographical sheets, Bd. XI, p. 106, Bremen, 1888), J. G. Kohl writes concerning the old charts, in which he had for years earnestly interested himself: "One is to be cautioned against a too indiscriminate use of these things. As a matter of course the charts assume to give a correct representation of the countries in their more prominent features, as the author proposes to himself at the moment of their execution; but the operation of delineating charts, which should properly have been the work of only cultivated and learned minds, was often confided to very inexperienced hands, and was conducted in part in an extremely negligent manner, while the draft of a chart, correct in all its details, presupposes so extraordinary a mass of information, that it was impossible to meet all its requirements until in more recent times; and not until in more recent times was all this knowledge combined and attainable in due form."

Now all this may be readily conceded, and yet we are constrained, where it is a question of the development of cartography, as in the case of America, to consult and investigate closely the most insignificant sheet, and we must at all events endeavor to obtain a clear elucidation of each of the names. But unfortunately it is hardly practicable to determine with confidence, in the case of many of the important voyages of discovery—as, for example, those of B. Gomez, Ayllons (in spite of the Spanish chart of a Ribero)—what points of the coast are indicated under the old designations, or in what locality a landing, or possibly a settlement, has been effected.

If not for the determination of the local names, at all events for that of the dates of discovery, the saints of the Catholic Church are of great utility. The day of the discovery is hereby conclusively established, and in accordance with this it may not infrequently be demon-

strated that a discovery should not be credited to a sea captain whose voyage harmonizes with the year but not with the month to which it is accredited.

It may be profitable and useful in investigations relating to this subject to annex here an alphabetical list of the saintly names most frequently in use.

Names.	Date.	Names.	Date.
Alexius.....	July 17.	Hyacinthus.....	
All Saints.....	November 1.	Hieronymus.....	September 20.
Ambrosius.....	April 4.	Jacobus.....	July 25.
Andreas.....	November 30.	Januarius.....	September 19.
Anna.....	July 26.	Jacinto.....	September 11.
Annunciatio Mariæ.....	March 25.	Johannes Baptista.....	July 24.
Antonius.....	January 7.	Julian.....	February 27, 28.
Appolonia.....	February 9.	Exaltatis.....	September 14.
Ascensio Domini.....	Himmelfahrt.	Laurentius.....	August 10.
Ascensio Mariæ.....	August 15.	Lazarus.....	December 17.
Assumptio St. Johannis.....	December 27.	Lucas.....	October 18.
Assumptio Mariæ.....	August 15.	Lucia.....	December 13.
Augustin.....	August 28.	Louis.....	August 25.
Balthazar.....	January 4.	Louisa.....	March 2.
Barbara.....	December 4.	Magdalena.....	July 22.
Bartolomeus.....	August 24.	Margaret.....	July 13.
Beata.....	December 22.	Maria.....	September 8.
Benedictus.....	March 21.	Martha.....	July 29.
Bernhard.....	May 20.	Martin.....	November 11.
Blasius.....	February 3.	Martyrs.....	June 22.
Bonaventura.....	July 14.	Matthæw.....	September 21.
Bonifacius.....	June 5.	Matthias (in leap year, Feb- ruary 25).	February 24.
Catherina.....	November 25.	Michael.....	September 29.
Christoph Cristoval.....	December 18.	Nativitas Christi (Navidad Natal).	December 25.
Circumcisio Domini.....	January 1.	Nicolas.....	December 6.
Clara.....	August 12.	Omnium Sanctorum.....	November 1.
Conceptio Mariæ.....	December 8.	Pantaleon.....	July 27.
Crucis.....	September 14.	Paulus.....	January 25.
Dionysius.....	October 9.	Peter-Paul.....	June 29.
Dominica-Sunday.....		Petrus.....	August 1.
Dominicus.....	August 5.	Philippus and Jacobus.....	May 1.
Eleven Thousand Virgins.....	October 21.	Raphael.....	October 24.
Elias.....	July 20.	Rochus.....	August 16.
Epiphany (Three Kings' Day).....	January 6.	Romanus.....	August 9.
Ferdinand.....	January 19.	Sebastian.....	January 20.
Franciscus.....	October 4.	Severinus.....	Aug. 26-Oct. 23.
Gallus.....	October 16.	Stephanus.....	December 26.
George.....	April 23.	Thomas.....	December 21.
Germanus.....	July 31.	Trinitas (Trinidad).....	Sunday.
Gregorius.....	March 12.	Trinmfo de la Cruz.....	July 16.
Holy Three Kings.....	January 6.	Vincentius.....	January 22.
Helena.....	August 18.		

Besides these saintly names, which for the most part fall upon their feast days, though occasionally on a proximate date, the nomenclature of the old maps consists only of characteristic symbols of the coasts visited and first taken possession of. The usual names are as follows:

Aguada.... watering place.	Bahia.....?.... bay.	Rio dolcesweet river.
Aldea..... village.	Fonduradeeps.	Rio saladosalt river.
Arenas.... sand banks.	Furna.....creek.	Rio escon- concealed
Anegadas..swamps.	Mar baxashallows.	dido. river.
Ancón bay.	Medanoshills.	Rio verdegreen river.
Arboledas..forest.	Plaiaflat coast.	Salinas.....salt beds.
Arecifes ..ridges.	Pracelshoals.	Tierra llana..plains.

Similar general distinctions in reference to the character of the coast, singularly enough, may be found upon charts, engraved or woodcut; that is to say, where they are true copies of marine charts.

The woodcut is the most brittle of all the substances employed, but it came in use in all German charts. And here distortions of names most readily occur, as well as limitations in the manner of representing the prominent local features. The woodcuts fronting the marine charts are inferior and rough, and reflect only imperfectly the information obtained. Yet such a merely general index as *bahia* has become a symbol of recognition for a whole collection of maps. The well-known Bay of All Saints, on the coast of Brazil, was converted into Abatia of the Saints, through the general distortion of names, and afterwards into Abbey of all the Saints. It was in the German cosmography, beginning with the Waldseemüller charts of 1513, that the remarkable error first appeared, which was more widely spread by Schöner (Harrisse, *Discovery of North America*, p. 275).

THE TERRESTRIAL CHARTS AND GLOBES.

It deserves to be particularly emphasized that in those countries to which we are chiefly indebted for discoveries in the New World, no cosmographic science existed; that in Spain and Portugal no globe has been produced, and only very rarely has a woodcut come to light.

What position the newly discovered islands—for of such the North American regions apparently consisted—and also what situation the great continent occupied on both sides of the equator relatively to all other parts of the known world; whether the new country was to be included with Asia in a broad signification, or whether connected with Asia at all; whether what is now called North and South America stand in any correlation to each other—all these questions were discussed in Germany and Italy, and more recently in France, but neither in Spain nor Portugal. Various opinions and doctrines in reference to these points arose and environed the gradual evolution of the new hemisphere.

This first geographical development of scientific inquiry had gone forth from Italy with the resuscitation of the "Ptolemæus." German astronomers and mathematicians were once more seated at the feet of the ancient Alexandrine geographers. For this reason the charts first printed are, almost without exception, closely allied with the rapidly succeeding editions of the Ptolemæus. In accuracy of drawing and copiousness of nomenclature, the Italian editions far exceeded the German, for here we find the copperplate. In Germany, on the other

hand, the woodcut predominated in the restoration of the charts. It was indeed a unique apparition that in the Romish edition of the Ptolemäus of 1508 a map of the New World by Johann Ruysch should present itself. Five years later on appeared the Strasburg Ptolemäus, that being the earliest chart of the new continent executed beyond the Alps. In the interim, however, globes carved in wood had made their first appearance.

Notwithstanding the inferiority and brittle nature of the materials used in the reduplication of charts, Germany won from the first an acknowledged supremacy in the delineation of the contours of transatlantic regions, and it continued to exercise this influence, uncontested, for a full half century. The reason for this is a very remarkable one. A small Vosges town, St. Die, the seat of the Lothringen Duke Renatus, who died in 1508, acquired the foremost prominence in the development of the cartography of America. Portuguese marine charts and the reports of the four sea voyages of Amerigo Vespucci possibly gave the first impulse to this art in 1506. The news brought to the Duke was quickly appreciated in the halls of the Gymnasium College, to which Walther Lud, Ringmann, and Waldseemüller were attached. The four marine voyages, in a Latin version, soon appeared, accompanied by a "Cosmographiæ introductio," or preliminary initiation in the principles of cosmographic science, by Waldseemüller, in which the author, as is well known, in 1507 proposed the name America for the new continent. At the same time it was decided to convert the marine charts, which had just reached the Duke, into a fresh edition of the Ptolemäus. The restoration of the charts was placed in the hands of Waldseemüller, but after many delays the work at length appeared in 1513. How well this edition succeeded may be recognized from the fact that in 1520 a second impression became necessary, and the editions of 1522 and 1525, imitations of the charts of the same locality, and even the Ptolemäus editions of Lyons in 1535, and of Vienna in 1541, were reproductions of the charts of Waldseemüller.

St. Die, however, soon lost its prominence after the departure of Waldseemüller. His Ptolemäus certainly appeared in Strasburg. Nuremberg succeeded Strasburg with the globe of Schöner, and thus an interest in cosmographic works extended more and more over German territory until its acme was reached at the close of the era in the Netherlands and on the Lower Rhine in the writings of Mercator.

If we now take a retrospective glance at the period when German cosmographers dominated in cartographic designs, from 1508 to 1569, several types, partly contemporary and partly subsequent, reveal themselves, and acquire prominence in the representation of the newly discovered regions of the globe.

In the interval of time here indicated seven different types may be distinguished:

(1) Johann Ruysch, 1508. In North America the well-known countries of Greenland, Labrador, and Baccalaos (Newfoundland) are

regarded as the eastern coasts of Asia, whose farther extension southward is given entirely in accordance with Behaim-Toscanelli. South America has no connection with it.

(2) Waldseemüller, 1509. The "Globustypus," or globe type, with the designation America. The New World does not belong to Asia, but consists of two parts or divisions intersected by the ocean. The Central American straits are a characteristic feature. This impression is adopted by Boulenger, Schöner, the so-called Leonardo da Vinci, and Nordenskjöld's globe (Table 37), together with Apian, Grynäus, and Honterus.

(3) America constitutes an homologous body of land, lying at a convenient distance from Eastern Asia and Western Africa. Stobnecza, 1512; Waldseemüller, 1513.

(4) North America, for a considerable extent of territory, is connected with Asia. It is, in part, a tendency toward the first type. According to Harrisse (*Discovery of North America*, p. 284), the idea is to be referred to Peter Martyr's *Enchiridion* (*De nuper sub D. Cardo repertis insulis, simulque incolarum moribus*. Basel, 1521). Perhaps Johann Schöner likewise has given credit to these views in his obsolete globe of 1523, as he has doubtless done in his *Opusculum Geographicum* (Nürnberg, 1533), in which he writes, "Unde longissimo tractu occidentem versus ab Hispali terra est quæ Mexico et Temistitan vocatur, in superiori India, quam priores vocavere Quinsay (thence for a considerable extent toward the west from Hispali is a country which is called Mexico and Temistitan, which in Upper India our predecessors named Quinsay). Apparently before Schöner's little treatise this idea had been promulgated by the Hollander Franciscus Monachus, 1526, upon the hemisphere drawn by him. This opinion was disseminated by Oronce Finé, and particularly in the Italian Ptolemæus editions (Venice, 1548, 1561, 1562), and for a long while it found approval in Germany also.

(5) North America is not united to Asia, but is separated from it by a continuous sea, which becomes narrower and narrower from the north to the east, and is almost reduced to a strait. The western coast extends in a semicircular configuration toward the North Atlantic Ocean. The marine route formerly traced in the middle of the New World, is placed toward the north, and, in polar latitudes, is bounded by Asia. This extends throughout the whole of America as far as Greenland.

(6) Type of Sebastian Münster, in which the influence of the chart of Verrazzano and of Maggiolo in the north, especially through the isthmus south of Newfoundland becomes apparent. South America assumes an uncouth, fantastic form.

(7) North America and northern Asia lie east and west, and not north and south, relatively to each other as in (5). A marine strait, in shape and location reminding us of Bering Straits separates the two continents and is called *Fretum Anian*. This view is first met with in Zaltieri's chart of 1566. Mercator follows it in 1569 and Ortelius in 1570.

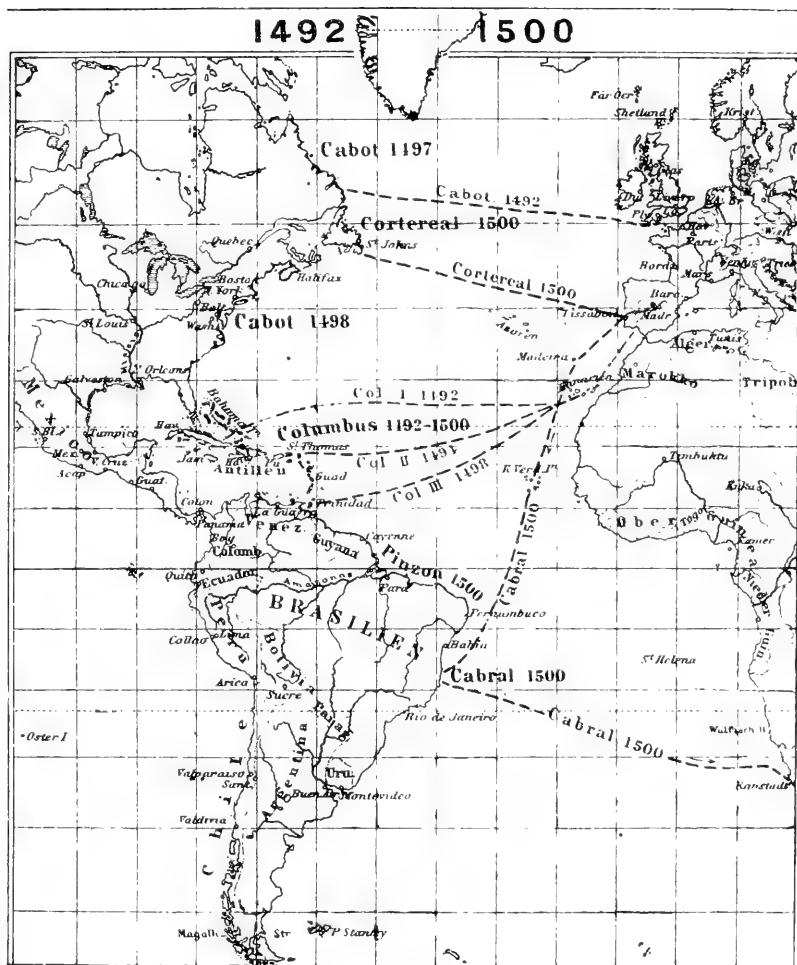

AMERICAN COASTS AND INLAND REGIONS DISCOVERED FROM 1492 TO 1500.

(Exhibit on modern chart.)

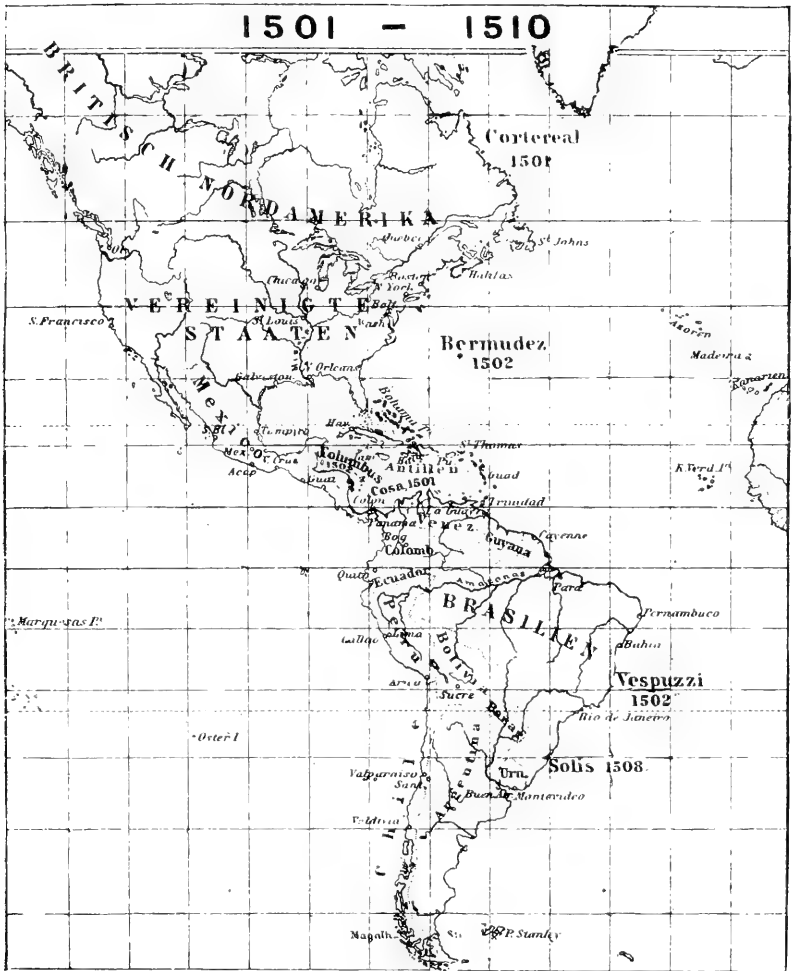

AMERICAN COASTS AND INLAND REGIONS DISCOVERED FROM 1501 TO 1510.

(Exhibit on modern chart.)

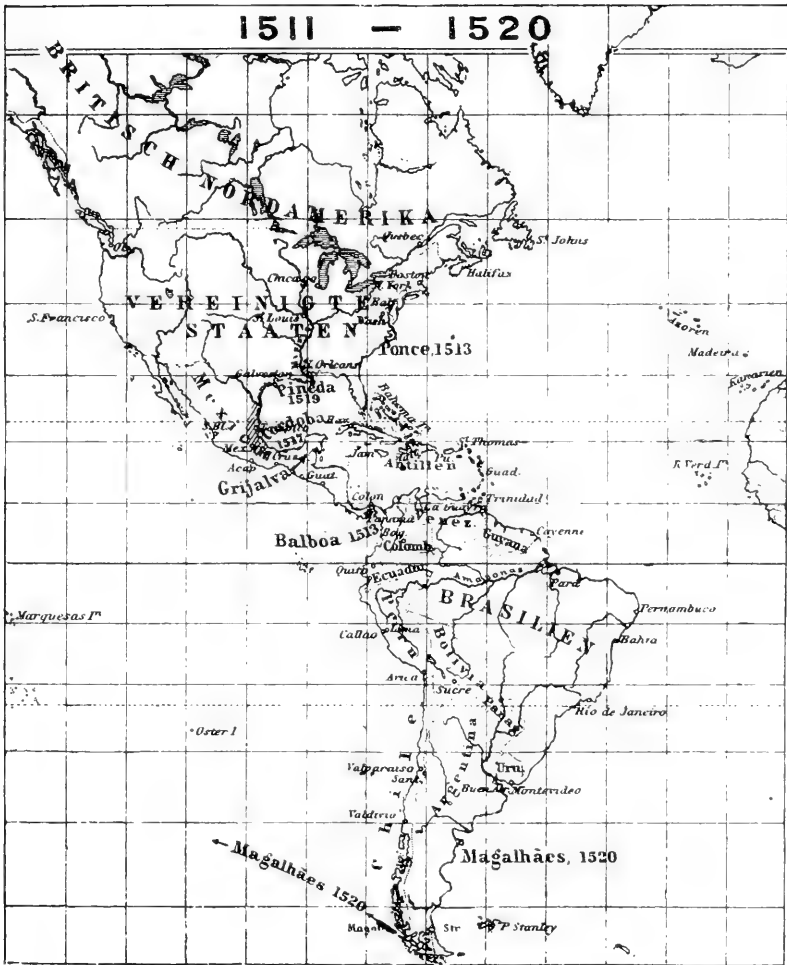

AMERICAN COASTS AND INLAND REGIONS DISCOVERED FROM 1511 TO 1520.

(Exhibit on modern chart.)

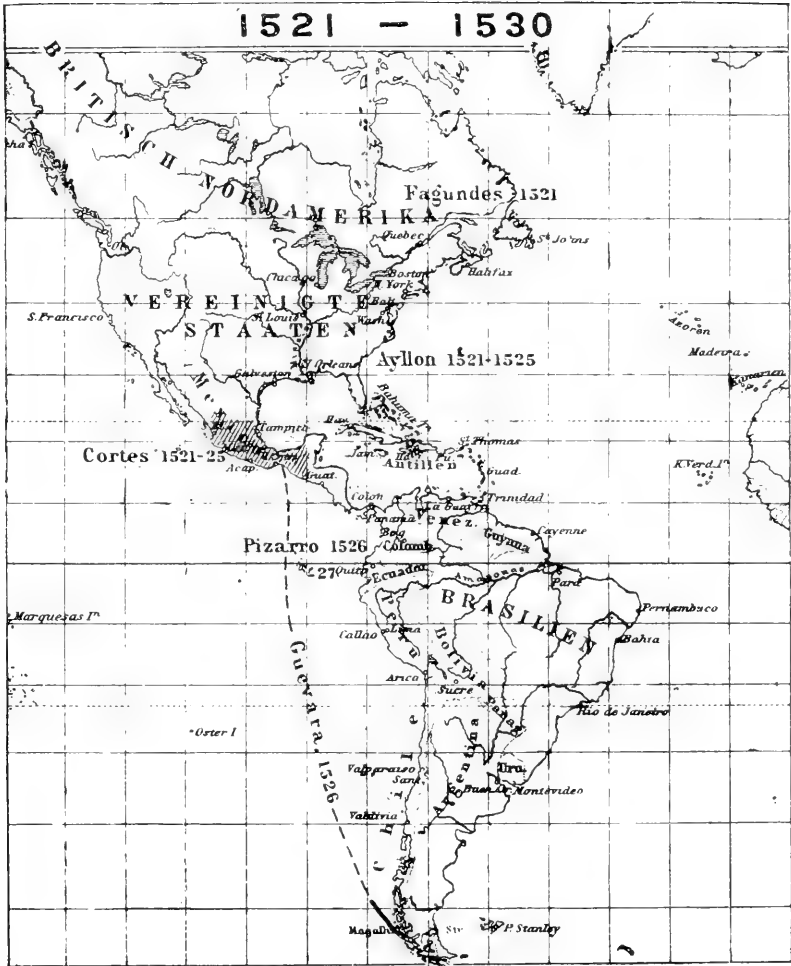

AMERICAN COASTS AND INLAND REGIONS DISCOVERED FROM 1521 TO 1530.

(Exhibit on modern chart.)

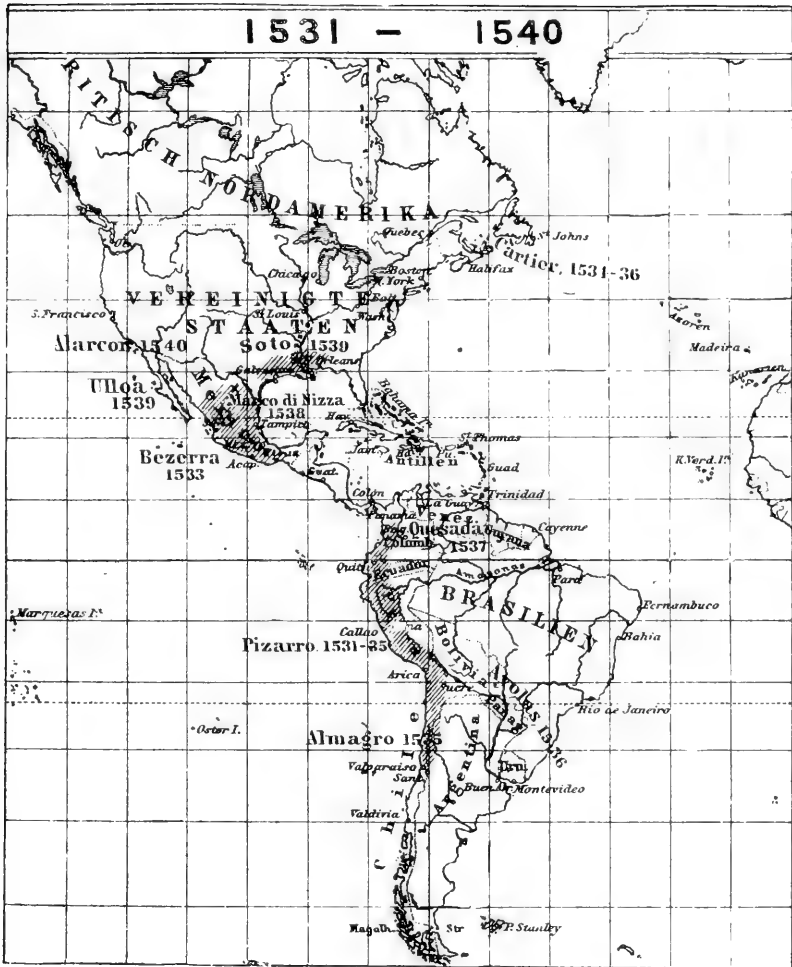

AMERICAN COASTS AND INLAND REGIONS DISCOVERED FROM 1531 TO 1540.
(Exhibit on modern chart.)



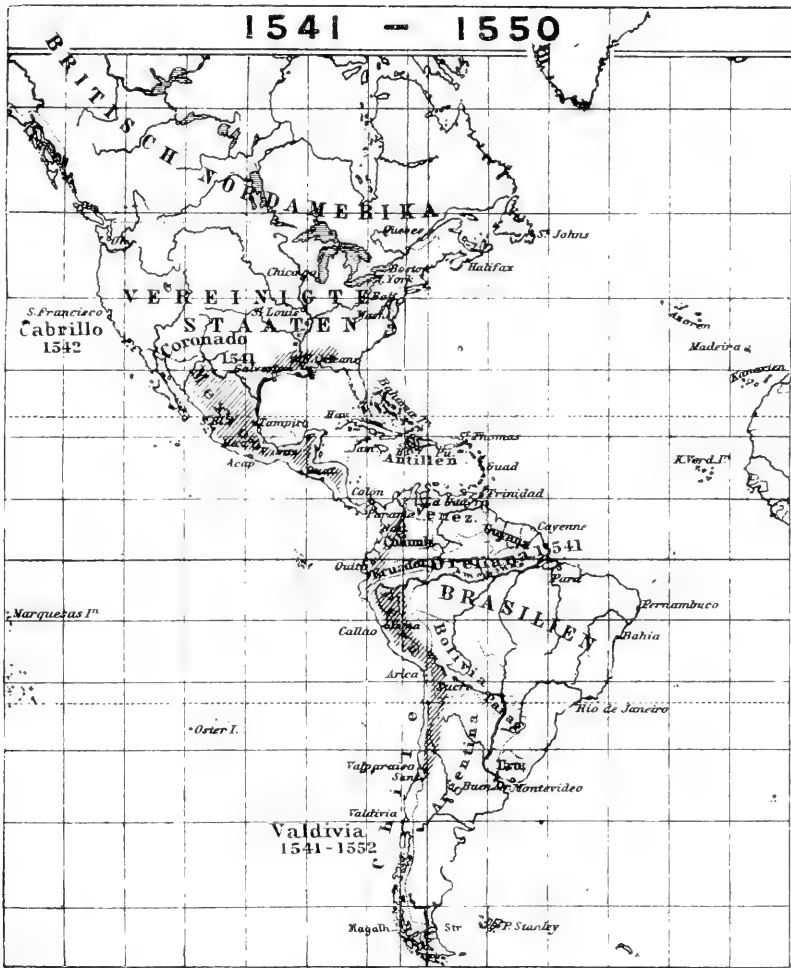

AMERICAN COASTS AND INLAND REGIONS DISCOVERED FROM 1541 TO 1550

(Exhibit on modern chart.)

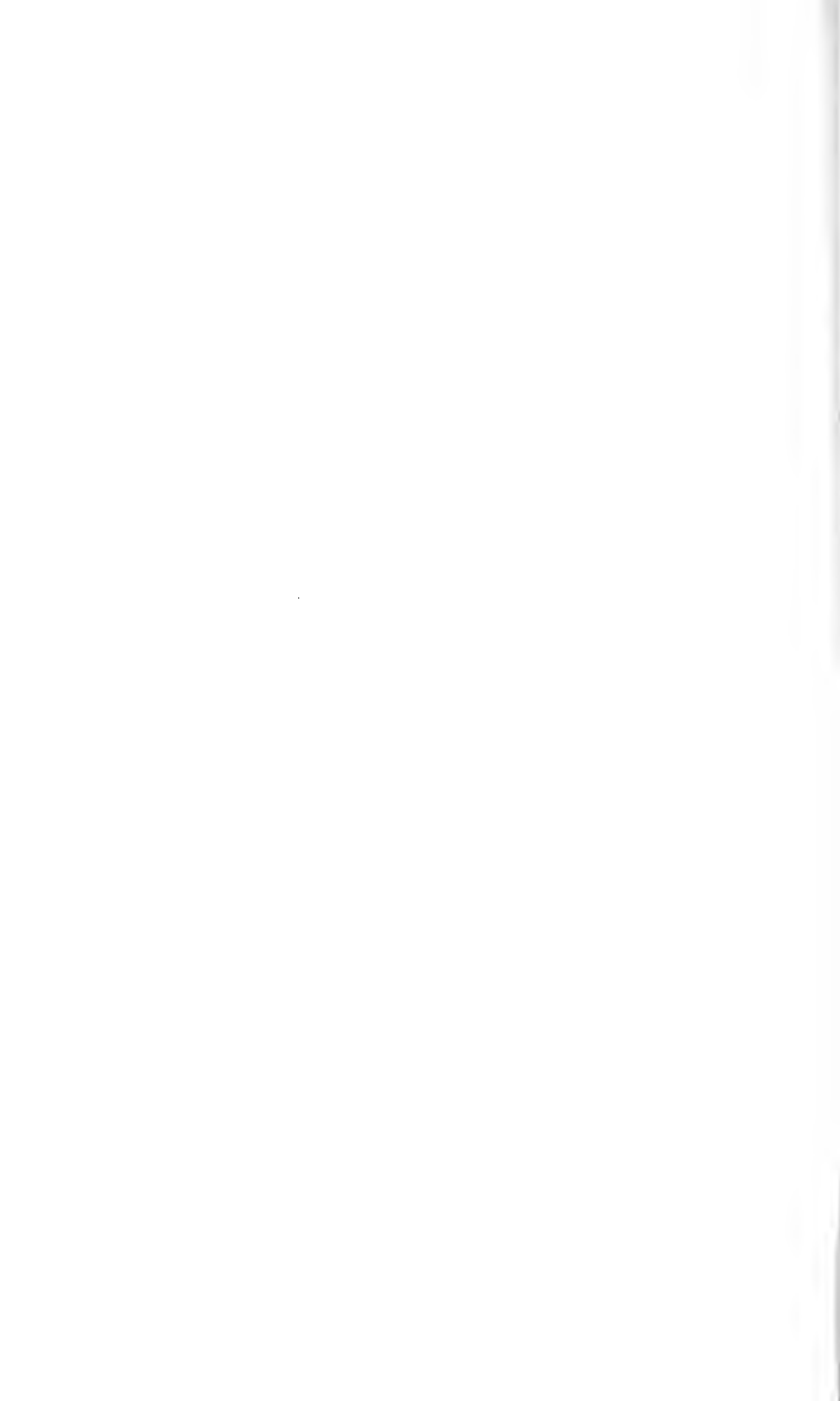



AMERICAN COASTS AND INLAND REGIONS DISCOVERED FROM 1551 TO 1560.

(Exhibit on modern chart.)

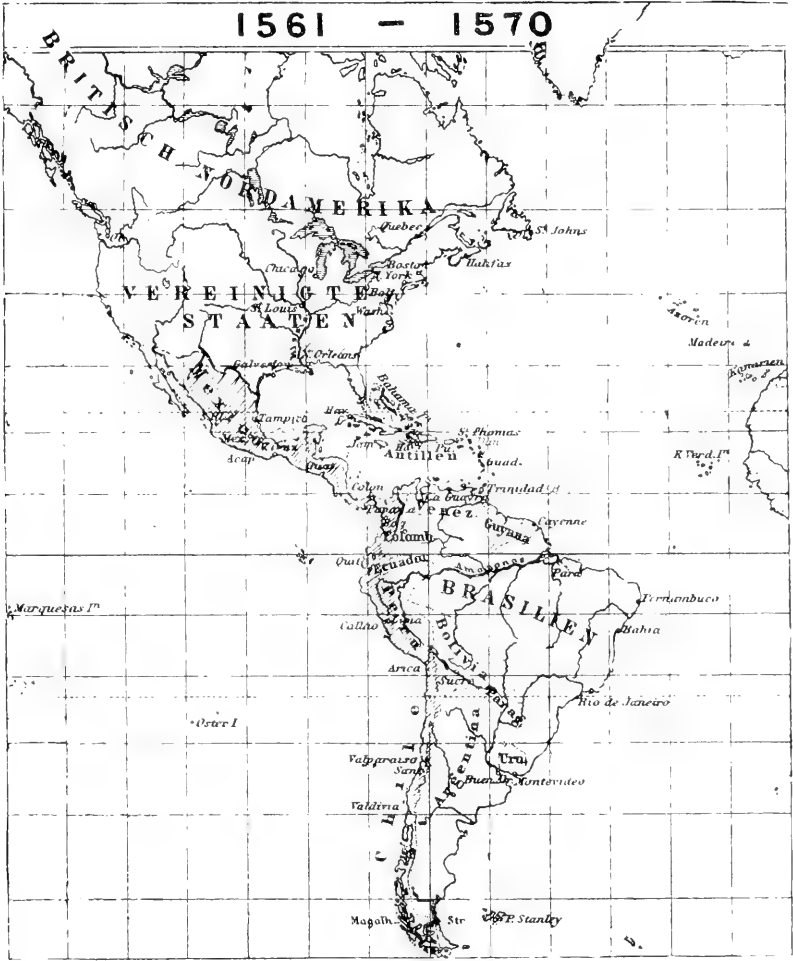

AMERICAN COASTS AND INLAND REGIONS DISCOVERED FROM 1561 TO 1570
(Exhibit on modern chart.)

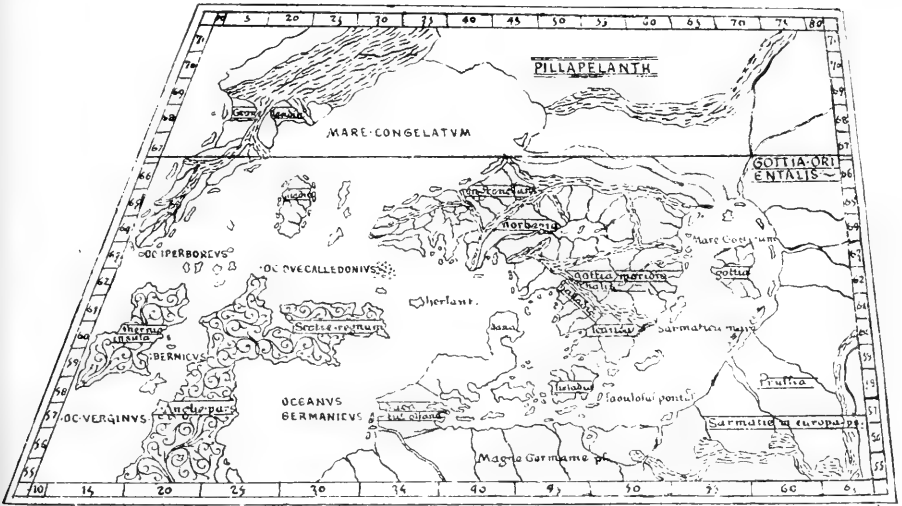

ZAMOISKI CODEX, 1467.

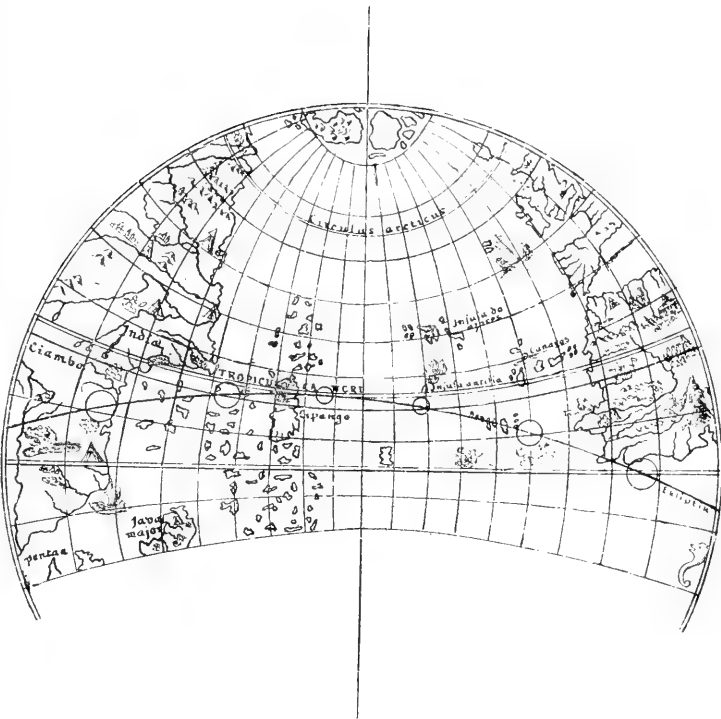

MARTIN BEHAIM GLOBE, 1492.

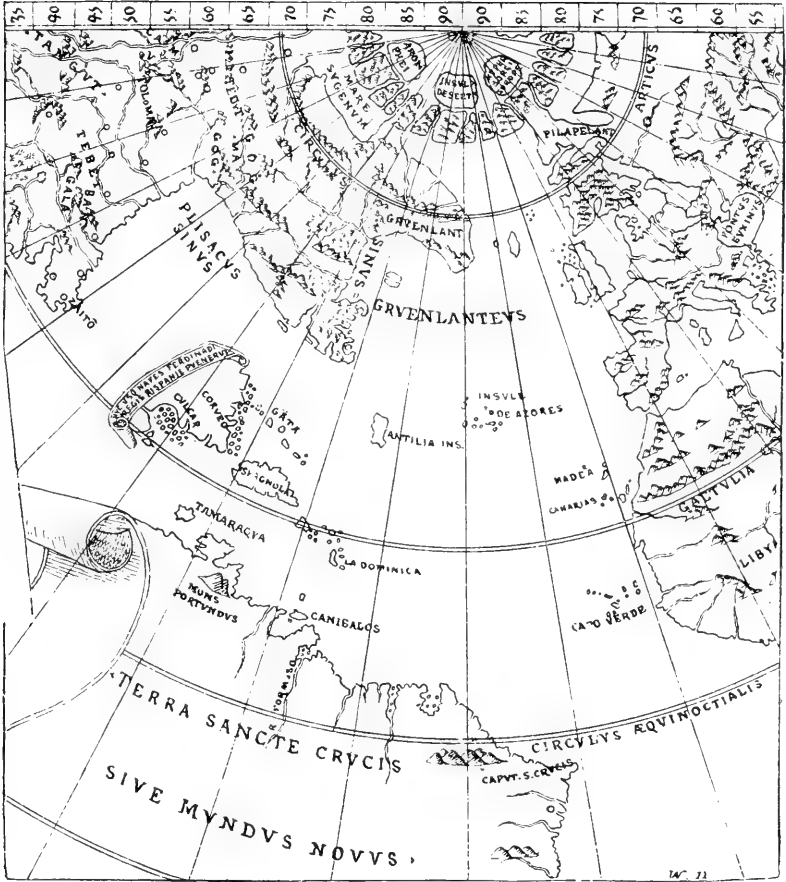

RUYSCH (IN PTOLEMY), 1508.

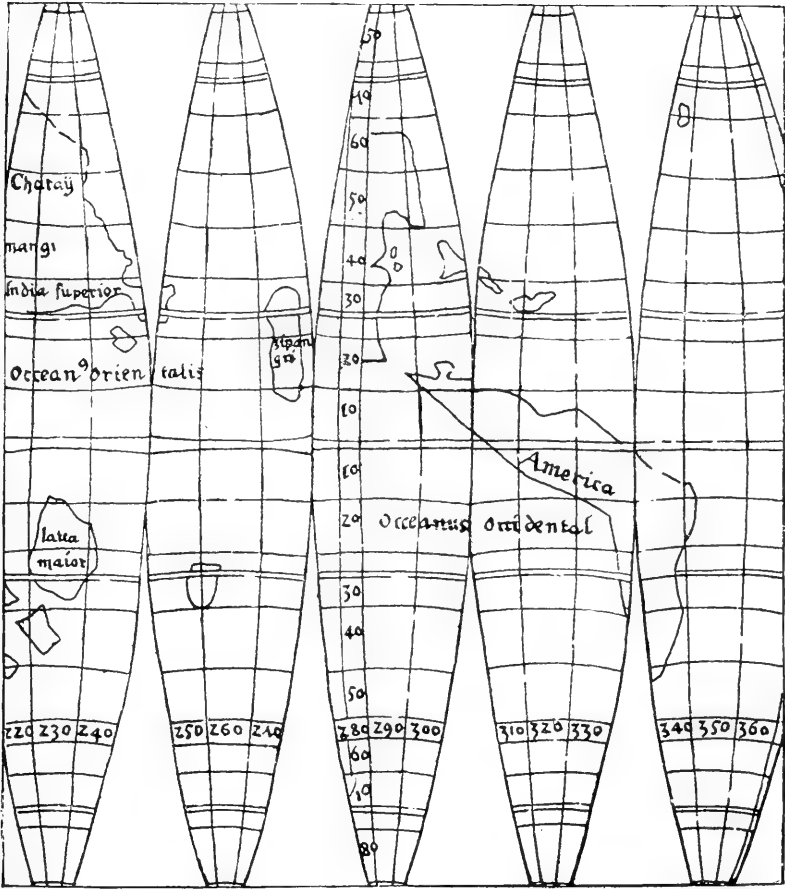

WALDSEEMÜLLER (?), 1509.



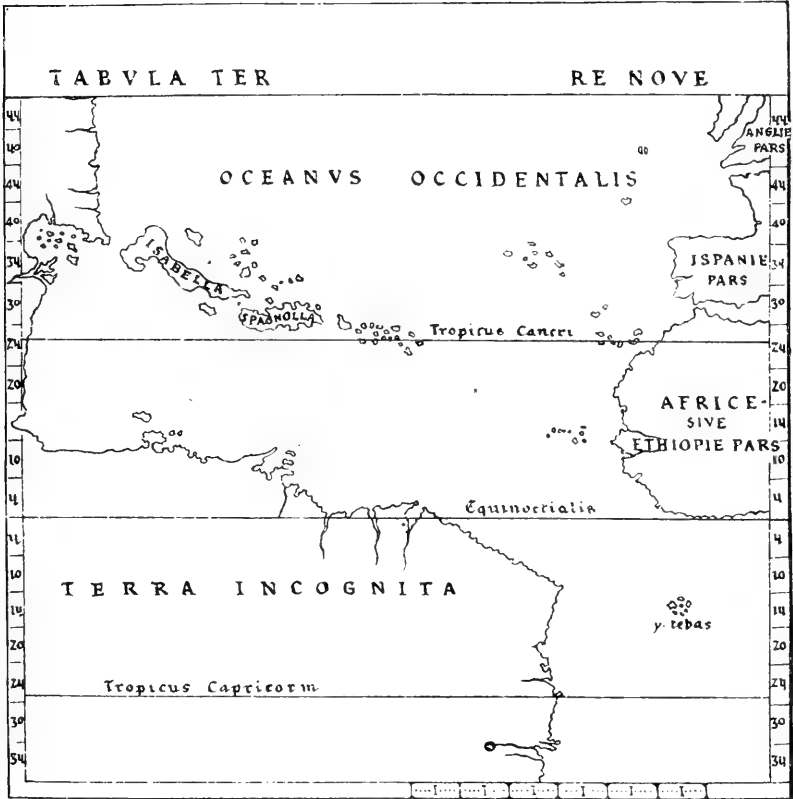

TABULA OCEANI OCCIDENTALIS SEU TERRÆ NOVÆ
PTOLEMÆUS, ARGENTINÆ 1513.

WALDSEEMÜLLER, 1513.

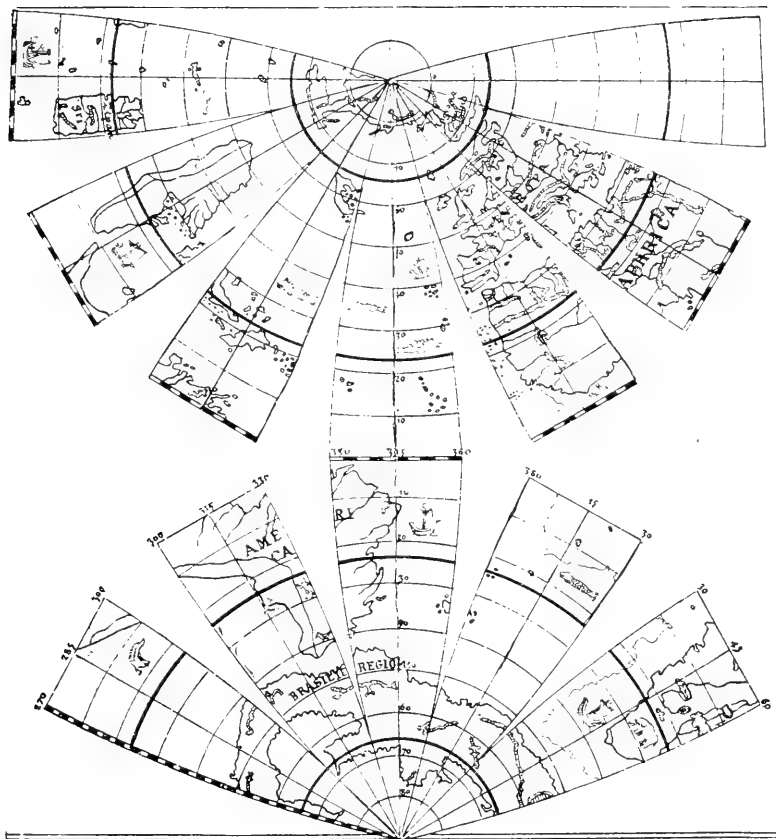

SCHÖNER'S (?) GLOBE, 1515.

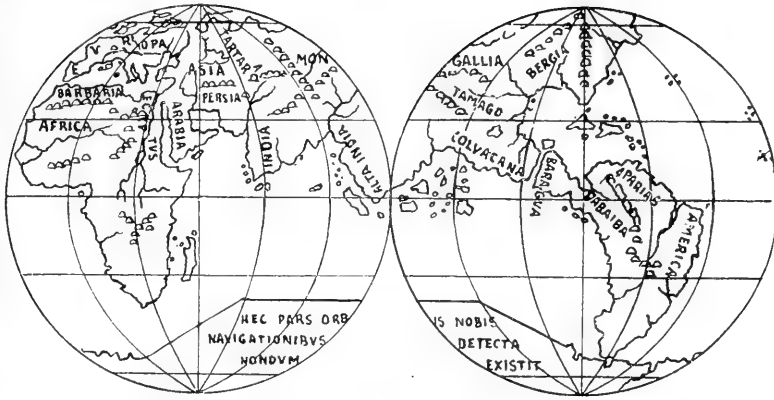

FIG. 1.—FRANC. MONACHUS. 1526.

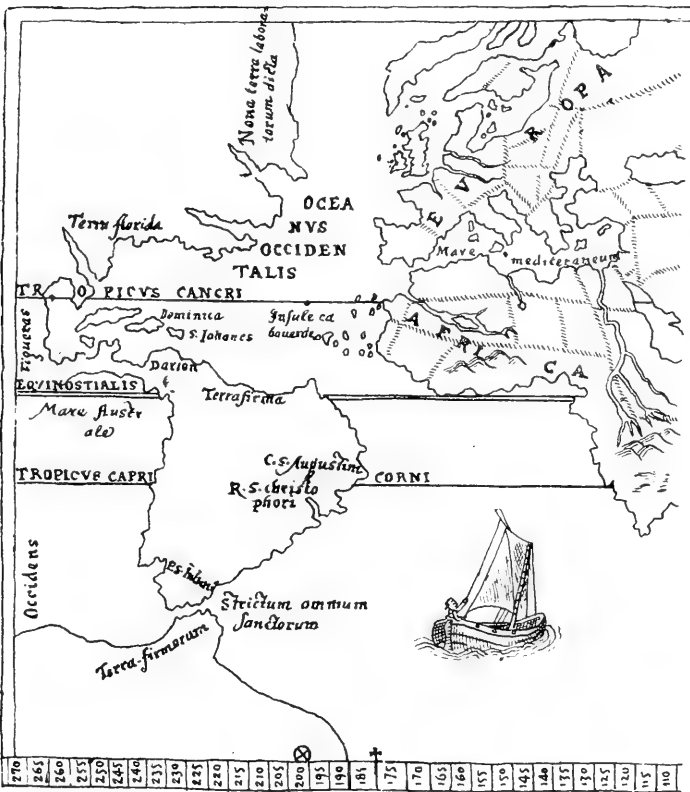

FIG. 2.—THORNE, 1527.



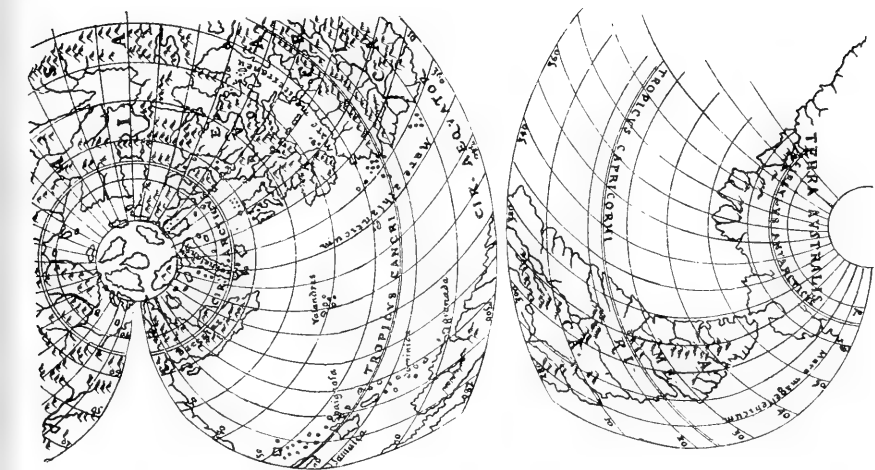

FIG. 2.—ORONCE FINÉ, 1531.

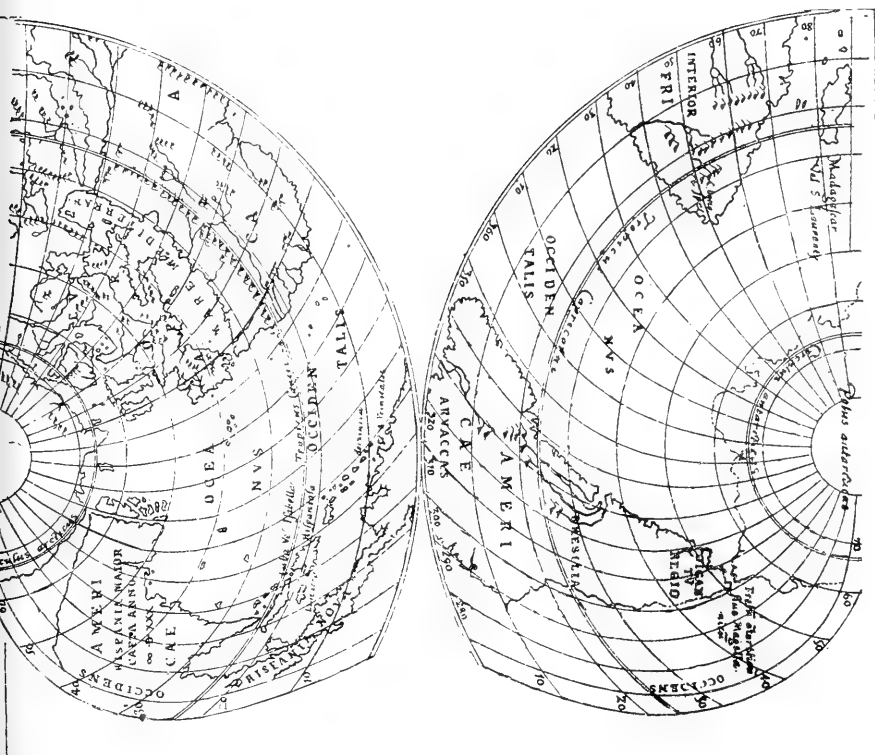
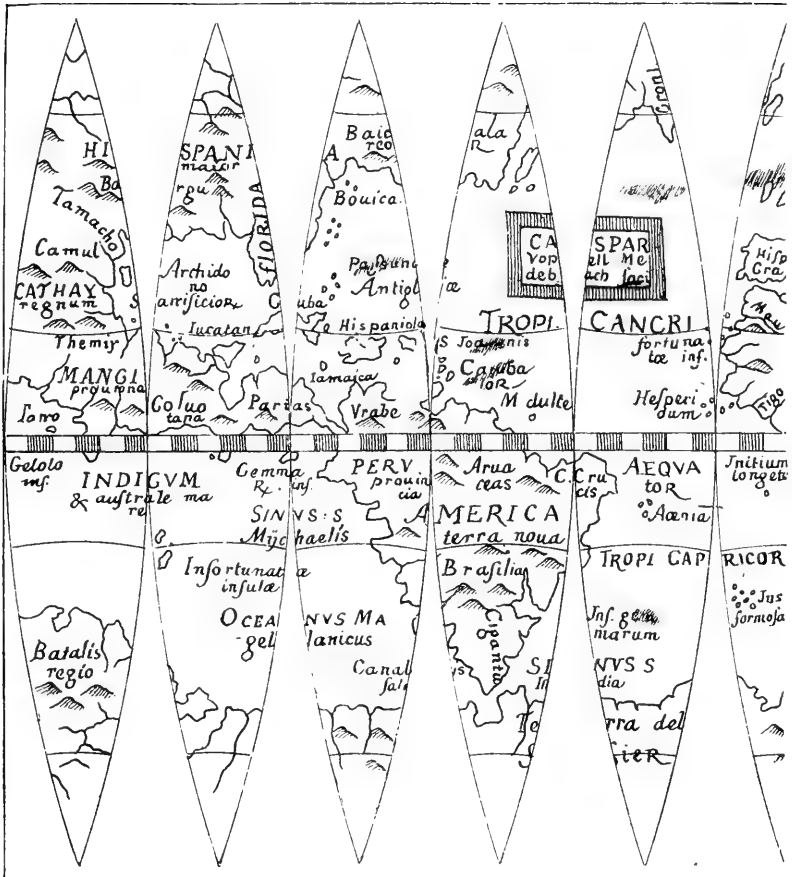

FIG. 1.—GERARD MERCATOR, 1538.





CASPAR VOPELL, 1543.



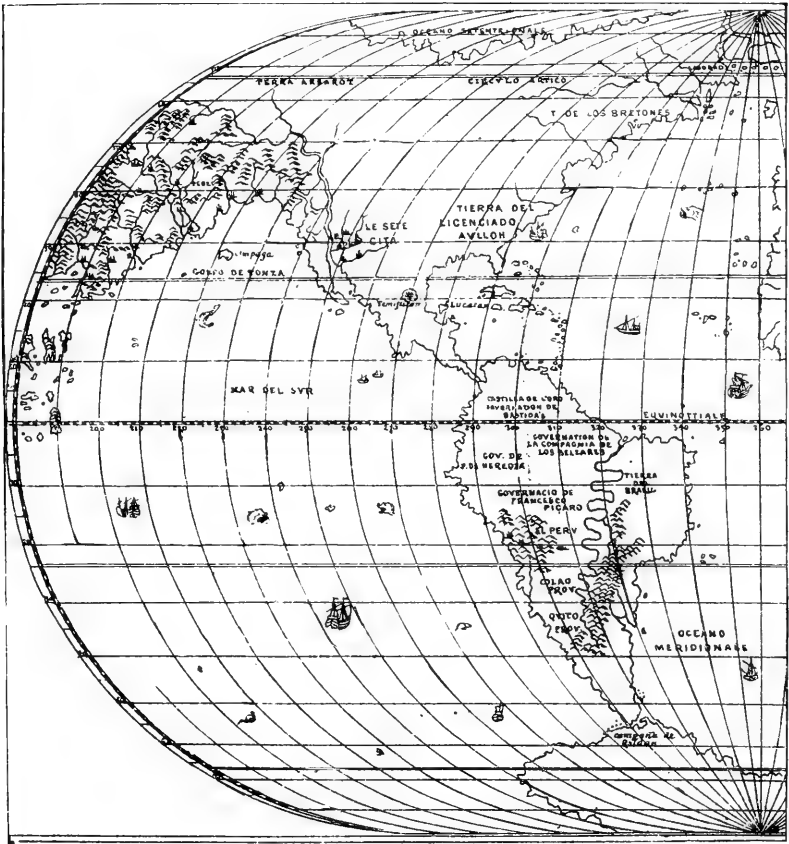

J. CASTALDI, 1546.



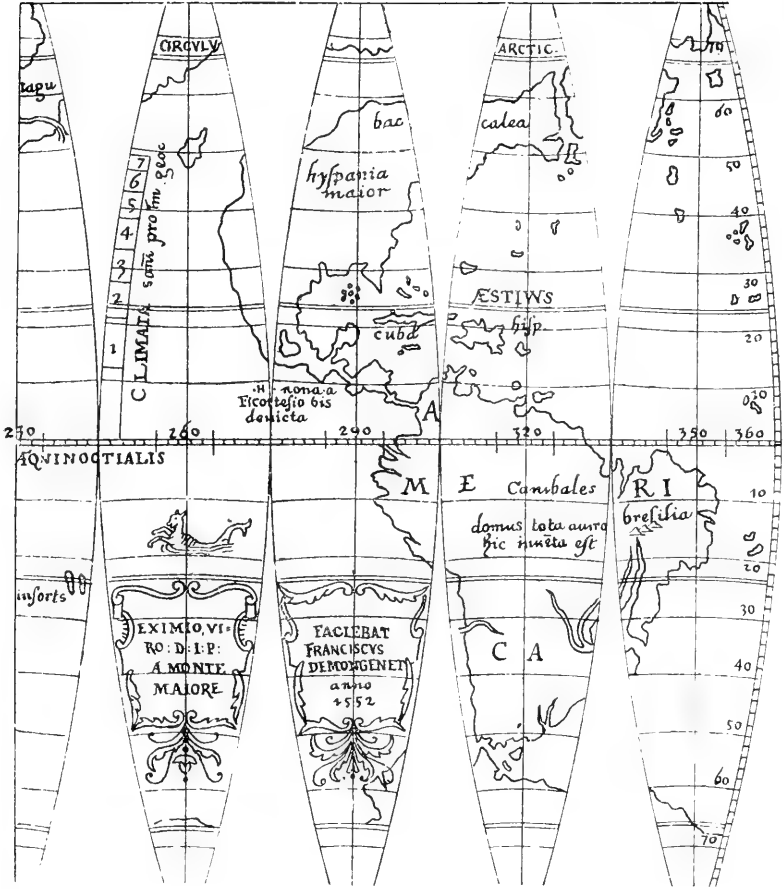

DEMONCENET, 1552.



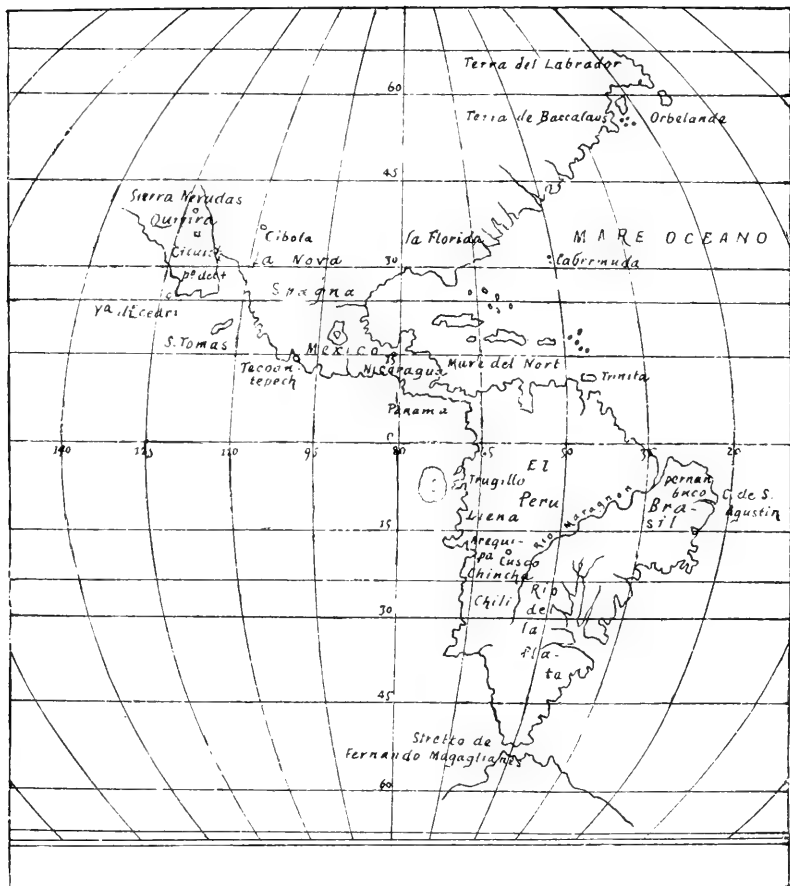

RAMUSIO (III), 1556.



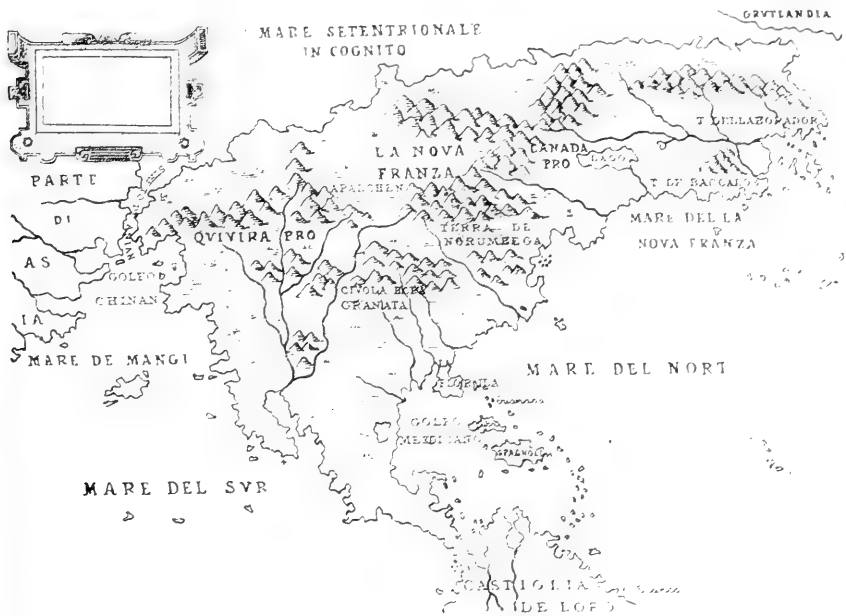

ZALTIERI. 1566.



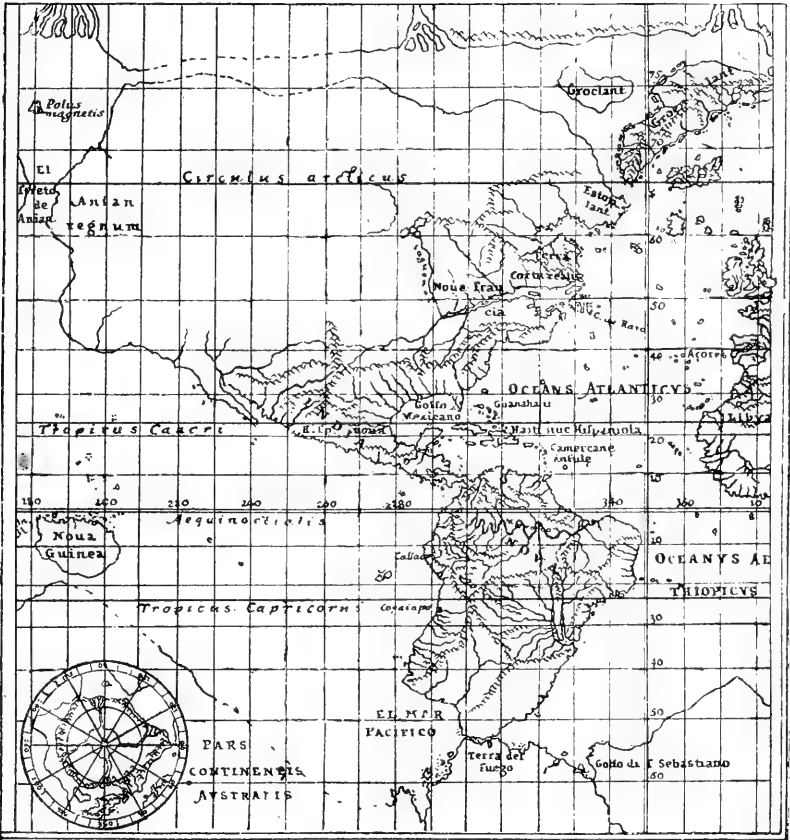

C. MERCATOR. 1569.

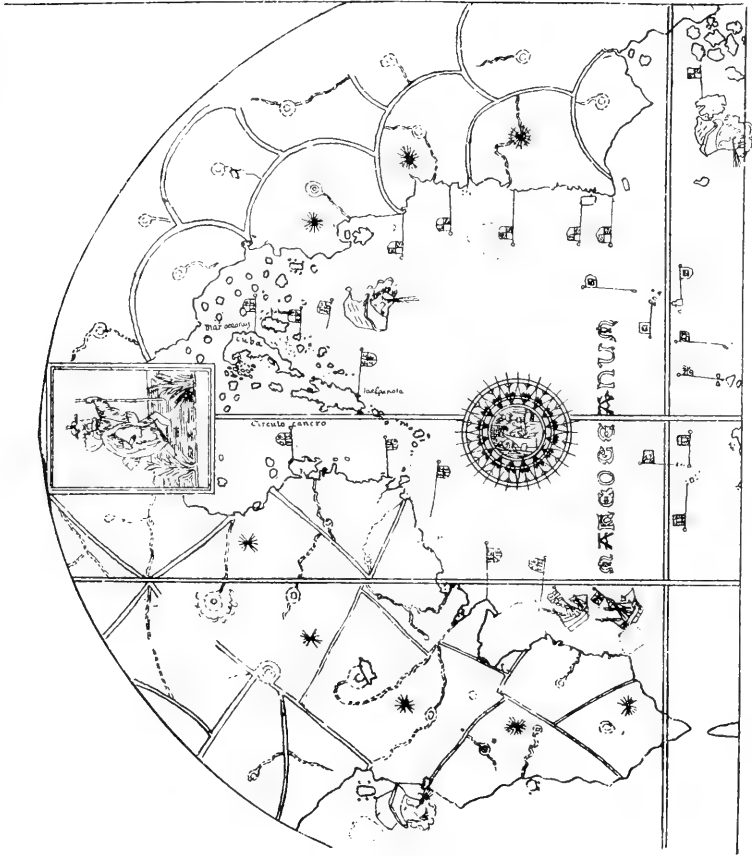

JUAN DE LA COSA, 1500.



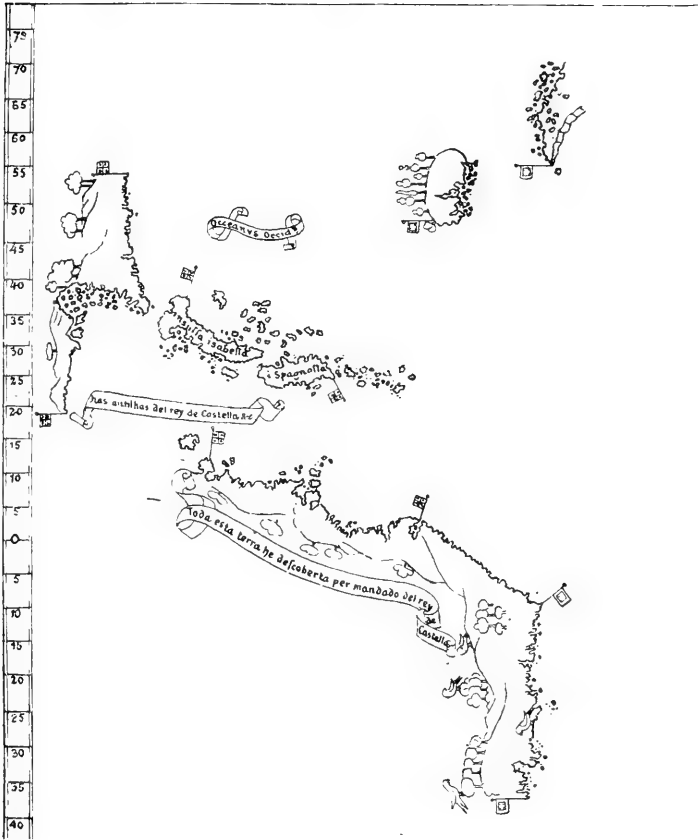

CANERIO, ABOUT 1502.



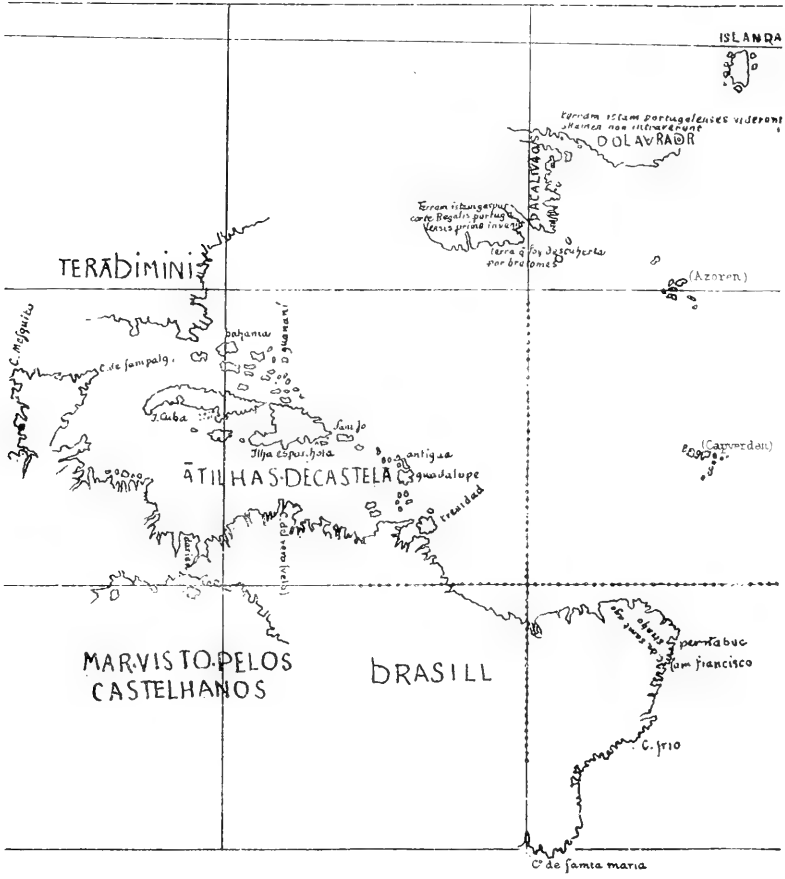

PORTUGUESE MARINE CHART, 1520.



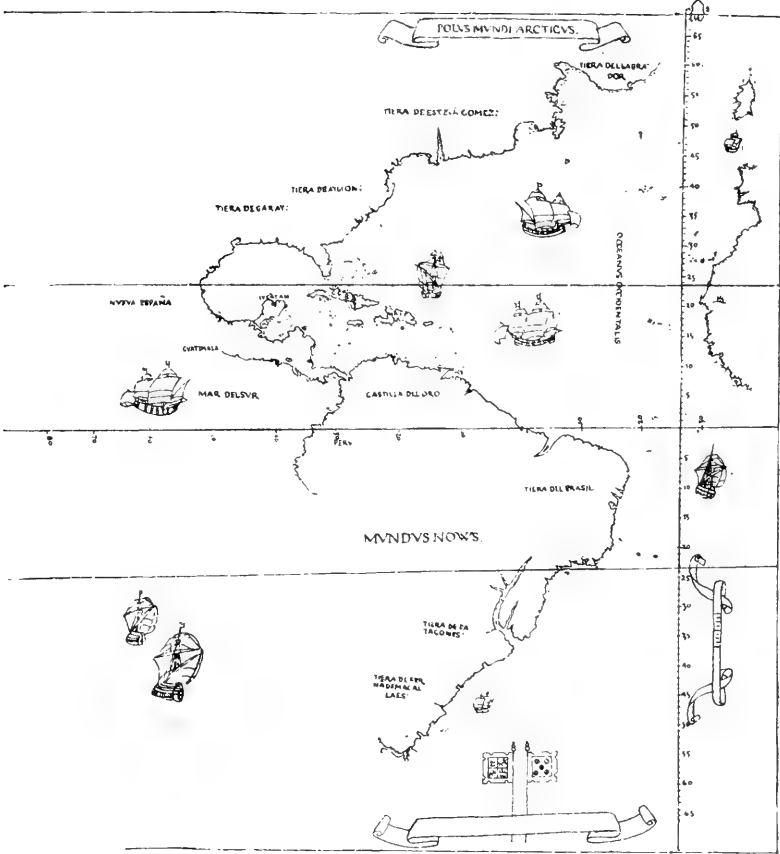

DIEGO RIBERO, 1529.



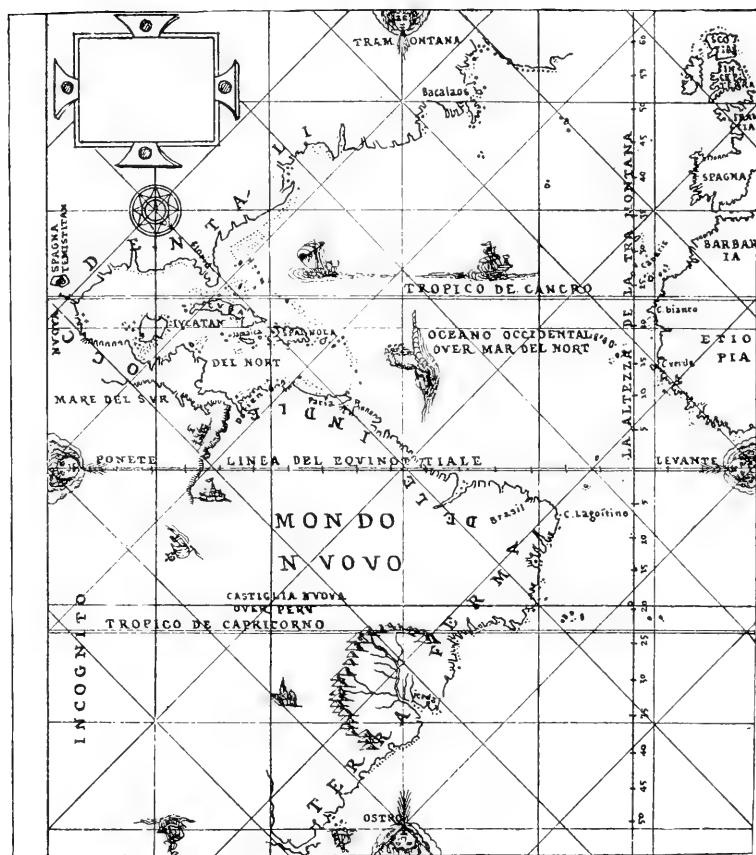

PETER MARTYR, 1534.

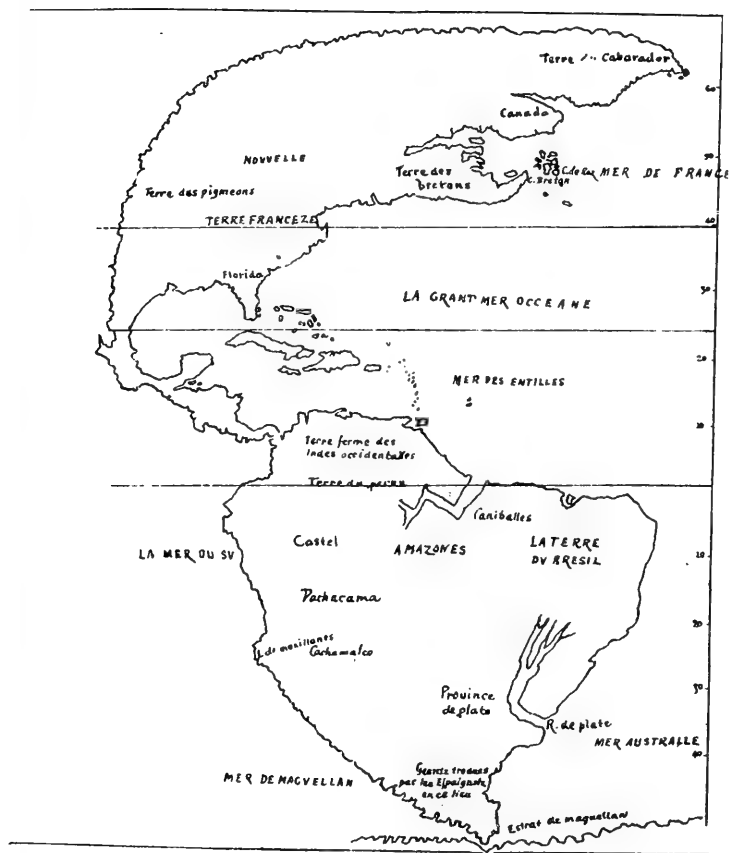

NICOLAS DESLIENS, 1541.

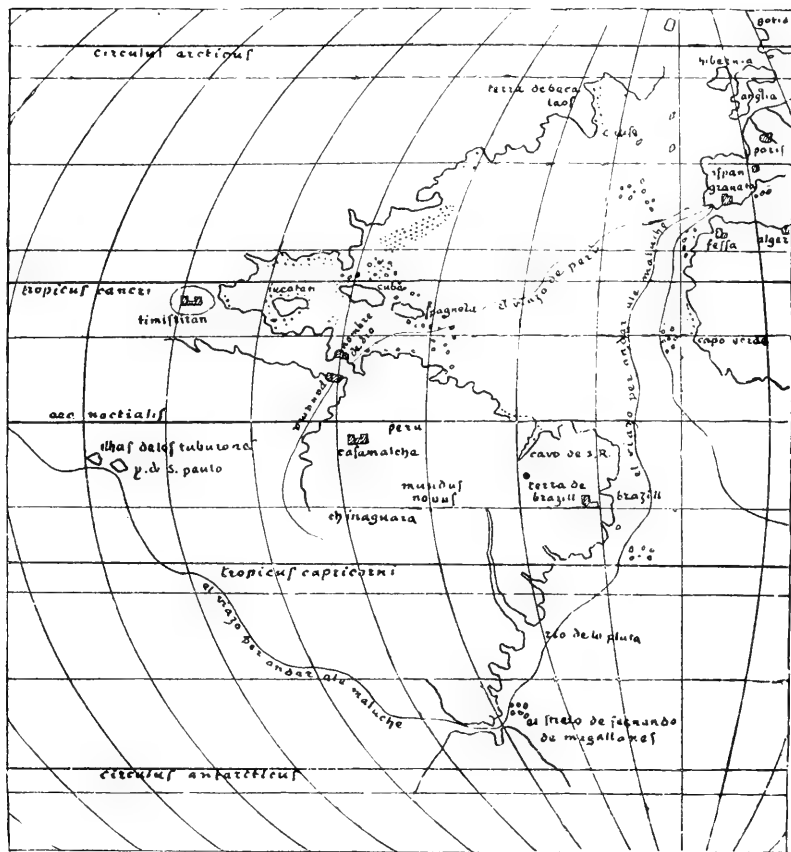

BAPTISTA AGNESE, 1550.

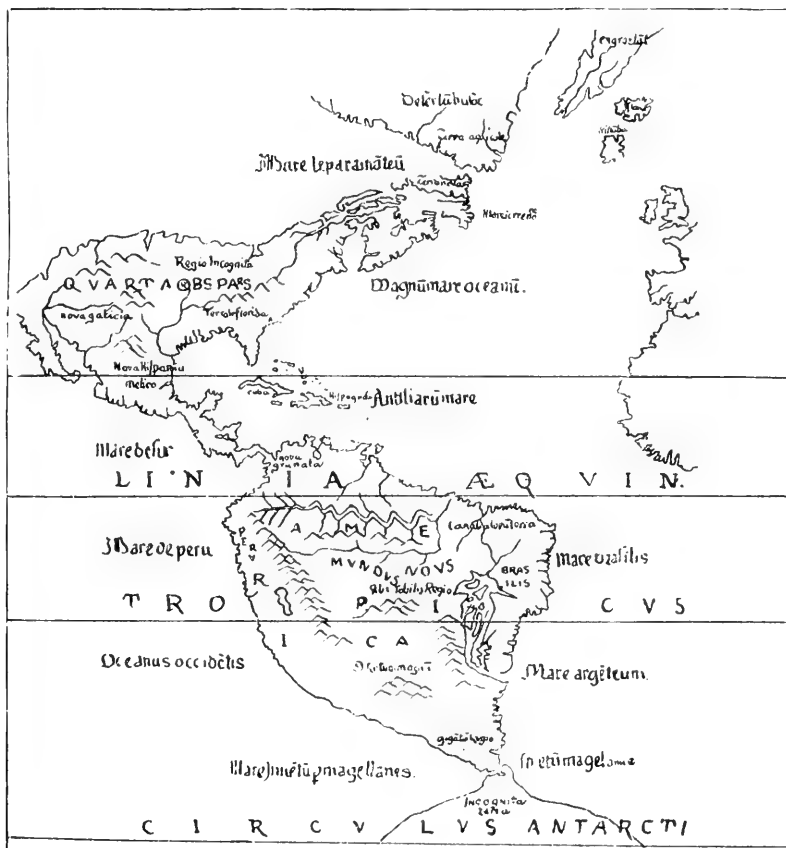

DIEGO HOMEM. 1568.

ANTARCTICA: A VANISHED AUSTRAL LAND.¹

By HENRY O. FORBES.

The student of the general fauna and flora of the different countries of the world soon finds himself faced by this remarkable fact, that the same species of a genus or the same genera of a family often occur at spots on the earth's surface separated by enormous distances, in the interval between which there is to be found not a single specimen of any of them. Before the Darwinian era we were taught that those similar isolated forms originated where they are now found by the fiat and at the incomprehensible will of the Creator; an explanation, however unsatisfying, which there was no going behind. The purpose and design in this distribution may have appeared strangely erratic and arbitrary, yet our longing to "know why" had to be stifled before this ultimate fact that the power that willed it so was inscrutable; nor dared one to question further without incurring the charge of sacrilegiously prying into the unknowable. The light from laborious embryological investigation, however, revealed no fact more clearly than this, that the individuals of the same family, however far separated on the globe, had arisen from the same progenitors by ordinary generation, and that the cause of this random distribution of the same forms of life in distant regions might, without impiety, be investigated, and with some hope of success. Having once, therefore, all had a common ancestry, how did they reach their present habitats, which are half the circumference of the globe apart, and separated by wide and deep oceans, impassable to them unless they flew, swam, sailed over on floats, or marched across by bridges that have disappeared between their present and their former homes? For instance, the members of that curious family of animals with something of the horse and the elephant in their composition, the tapirs, are now found only in the southern parts of South America on the one side of the globe, and in the center of the islands of Sumatra and Borneo of the Malay Archipelago on the other, and nowhere else. Their bizarre appearance and their close sim-

¹From the *Fortnightly Review*, February, 1894, Vol. LV, new series, No. 126; by permission of the Leonard Scott Publication Company, New York.

ilarity in form and structure render it absolutely certain that they have had a common parentage, and that, though now living so widely sundered from each other, they radiated from one ancestral home.

To trace out the migration of the varied forms of life, both animal and vegetable, to their present habitats forms one of the most absorbing of zoo-geographical investigations—a “study,” as Mr. Wallace well remarks, “which will surely lead . . . to a fuller comprehension of the complex relations and mutual interdependence which link every animal and vegetable form with the ever-changing earth which supports them into one grand organic whole,” and which, besides, will enable the investigator to demark with increasing certainty, as his labors progress, the changes in fluctuation of land and water which the globe has from age to age restlessly experienced. As soon as our knowledge of the fauna and flora of the continents and islands of the globe had advanced sufficiently far to enable fairly accurate systematic catalogues of the animals and plants inhabiting them to be drawn up, many singular anomalies came to light, some of which have been apparently sufficiently explained, while of others the causes are still as inexplicable as ever.

In the year 1861 those distinguished paleontologists, Professors Herr and Unger, pointed out that the present vegetation of the Eastern States of America exhibited remarkable resemblances to that which flourished in Europe during the Miocene age, and they suggested the hypothesis that during the Miocene period Europe and America were united by a land bridge (long celebrated as the Atlantis continent), which stretched across the Atlantic Ocean. By the perusal of the essay of these botanists, *Recherches sur le Climat et la Végétation du Pays Tertiaire*, Professor Oliver, of Kew, having been induced to investigate “carefully the relations between the Tertiary and some existing floras,” was led to the conclusion that the intercommunity of “types in the Tertiary beds of Europe and the present flora of the eastern States of the North American continent took place, not over an Atlantis, but over land probably in a comparatively high latitude to the north of the Pacific Ocean”¹—that is to say, that the flora of Europe followed the climate as, in that epoch, it became more and more genial into the circumpolar regions, and thence it dispersed southward again on the advent of the cold, into such parts of Asia and America as it could obtain foothold in. That a genial climate and a vegetation of very temperate character did exist to within nearly 8° of the North Pole, was proved in a most conclusive manner by the officers of the Arctic expedition of 1876, who discovered, in those now ice-bound latitudes, fossil plants which now grow not farther north than mid-Europe.

Perhaps nothing in natural history surprised naturalists more than the distributional facts—both of the fauna and the flora—first indicated

¹“The Atlantis hypothesis in its botanical aspect,” *The Natural History Review*, 1862, page 149.

by Mr. A. R. Wallace on the east and west sides of what is known as Wallace's Line, which separates the two Malayan islands of Bali and Lombock. The strait that separates these islands is so narrow that, standing on the vessel's deck, the voyager to the southward has an excellent view of the land on both sides, and can admire the richly forest-clad and shapely volcanic cones of Agong and Rinjani that tower into the blue on his right hand and on his left. To "the eastern side of this line," Mr. Wallace writes, "the fauna and the flora, and even the people, are essentially Australian; to the western side, as essentially Asiatic." On crossing this narrow passage from west to east "we at once meet with those singular birds, the mound builders (*Megapodidae*), as well as friar birds and other honeysuckers, cockatoos, and many other groups found only in the Australian regions; while a large number of animals found in every one of the Asiatic islands suddenly disappear. We have no longer any elephants, rhinoceroses, or tigers; none of the carnivora but a common civet cat (probably introduced); none of the insectivora but a small shrew; none of the numerous rodents but one or two squirrels." Yet in the island of Timor, farther to the east and near to Australia, one is surprised to discover that, as Mr. Wallace points out, the characteristic mammals of Australia are quite as much wanting as those of Asia. "Birds," he remarks, "however, having the means of passing freely over narrow arms of the sea, have not been excluded, and, notwithstanding the similarity in climate and vegetation to Australia, the birds and insects of Timor more resemble those of Java, Celebes, and the Moluccas." These islands are hundreds of miles apart, and yet have an interchange, according to Mr. Wallace, of many birds and insects; while from Bali and Lombock, which gaze on each other across a narrow arm of the sea, there has been, when the distances apart of the two localities are compared, only a slight interchange. In South America again we have genera of monkeys and birds living in abundance along one bank of a river, which apparently find this comparatively narrow line of water an impassable barrier.

In a paper contributed to *The Fortnightly Review* in May last I referred to the discovery in the Chatham Islands (near New Zealand) of the subfossil remains of birds which were up to that time known to have lived only a few hundred years since in the Mascarene Islands as confirming the belief that there must have existed in the southern seas an extensive continuous land similar to that in the Northern Hemisphere, on which the common ancestors of the forms unknown north of the equator, but confined to one or more of the southern extremities of the great continents, lived and multiplied, and whence they could disperse in all directions. "This lost continent," I observed then, "I am constrained to believe from evidence which space does not on the present occasion permit me to adduce, lies in part beneath the southern ice cap, and it approached to or included the Antarctic

islands as well as extended northward to unite with the southern extremities of South America, perhaps with Africa, and with the Mascarene, the Australian, and the New Zealand continental islands." The larger evidence to which I then referred I purpose now to lay before the readers of this Review.

We find either still living or preserved fossil in the strata of their Tertiary formations in regions of the Southern Hemisphere so widely apart as the south of South America, the Madagascar region, Australia, and New Zealand many forms of plants and animals unknown in the Northern Hemisphere possessing so many characters in common as to show at once that they are descended from the same stock.

To commence with birds, the distribution of the ostrich group is very remarkable. New Zealand, as it is scarcely necessary to remind the reader, is celebrated for the remains of those extinct giants of the family known as moas. Their bones are found all over the two main islands of which that colony consists, and they might have been gathered in the early years of its settlement by Europeans in vast numbers from off the surface of the ground, especially in the interior of the provinces of Canterbury and Otago, or from the sandy flats of the larger rivers where they had become exposed by the action of the wind. They have also been found in caves, under rock shelters, and in the ancient kitchen middens of the natives, as well as exhumed in enormous quantities from the peat bogs of both islands, where they have been discovered huddled together in crowds of many hundreds. These birds varied very greatly in size, the larger specimens attaining a stature of from 10 to 12 feet. They had bones of herculean proportions, and, needless to say, they were quite unable to fly, being, indeed, devoid of wings. Their feathers, which, singularly enough, have been preserved to us in considerable numbers, show that each had an after shaft equal in length to the primary plumes of their contour feathers—forming, as it were, a double feather—a characteristic mark of the ostriches of the Australian region, the emu and cassowaries; and they all possessed, on the metatarsal bone, articular pulleys for three toes instead of two, as the African ostrich has. Australia also included in its bird fauna of ancient days a giant ostrich, the *Dromornis*, and now possesses the emu, while New Guinea reckons at the present time the cassowary—of which one species crosses into Australia—among its wonderful bird inhabitants. In the distant island of Madagascar also there flourished once, though now extinct, a member of the same family, the *Aepyornis*, a giant, if not in height, at all events in the bulk and dimensions of its limbs, which appear to have exceeded those of even the most elephantine of the moas. Yet another stately member, the *Brontornis*, lived in early ages in southern Patagonia, a necessarily flightless bird; which, as we know from its fossil remains, far excelled in stature even the tallest of its New Zealand relatives. This remarkable group of birds, therefore, we find occupied New Zealand, Australia, Madagas-

car, and South America—that is, their distribution extended right round, and was practically confined to the lands of the Southern Hemisphere, in which the area that each occupies is seen from a study of the map to be separated from the other by vast stretches of unbridged ocean. Yet a comparison of their skeletons—for of the moa, the *Epyornis*, and the *Brontornis* we have only their fossil bones to judge from—leaves little doubt that they are all ramifications of one branch of the same genealogical tree which flourished in a region which I hope to indicate in the course of this paper, and that they wandered in all directions from a common land by roads which I shall presently attempt to trace.

The traveler interested in bird life who has spent some time either in South Africa, or in South Australia, or has had the good fortune to land on the shores of Terra del Fuego, or of one of the Antarctic islands, can scarcely have failed to watch those quaint fishlike birds, the penguins, which are far more at home under the water than they are on the land. They breed in enormous rookeries on some of the more unfrequented southern islands, but they are met with in all parts of the Southern Hemisphere south of 40 degrees of south latitude, each island or continent having some species peculiar to itself. One important point in their history is that none of the family have ever been found on the northern side of the equator, a distribution which has probably been always equally circumscribed within these latitudes, for their earliest fossil remains—osteologically identical throughout the enormous period separating the Eocene from to-day—are known only from, and are, so far as I am aware, confined to the older Tertiary formations of New Zealand and Patagonia. More interesting still, perhaps, and very important from the point of view of the subject of this paper, is the distribution of the *Chionidae*, a family of beautiful, pure white birds related to the plovers. These sheath bills, as they are named, from a conspicuous horny sheath at the base of their bills, are not marine but land birds. They would be incapable of undertaking a journey of any great duration across the sea where they could find nothing to support them; yet they are found, so far as known, in Fuegia and the neighboring Falkland Islands, but not elsewhere till the far-off Crozet Islands and Kerguelen Land are reached.

The well-known and brilliantly plumaged family of the parrots have their chief development in the Australian and Papuan regions and in South America (with a few stragglers extending up into North America), while in South Africa and in India they are but feebly represented. Now, the curious owl parrots and the keas of New Zealand have a near relationship with the macaws of South America. Mr. Wallace has pointed out that an unusual style of coloration occurs among the parrots living both in Australia and the Mascarene Islands; and that though in Australia alone species adorned with crests now live, yet within the historical period, such forms occurred in the Mascarene

region also—characters, he observes, “too well marked to be considered accidental.”

In the May number of *The Fortnightly Review* I have already drawn attention to the fact that what now constitutes New Zealand was but a small portion of a once far greater continental island—which I have designated Antipodea—stretching south as far at least as the Macquarie Islands, and embracing all those lying between them and the Chatham Islands, as well as those to the northward as far as New Caledonia, the Fiji, the Friendly, and the Kermadec islands—a fact deduced from the occurrence on these separated specks of land of a common flora and fauna which could not have arrived there without a land connection. On that occasion also, I spoke of the discovery in the Chatham Islands—an unsubmerged portion of a once larger region—of the remains of two birds, a tall coot (*Fulica*) and a giant wood hen (*Aphanapteryx*), which had been previously known only from Mauritius, which is also an unsubmerged portion of a greater continental island, comprising Bourbon, Rodriguez, Madagascar, and the Seychelles. The wood hens, a group of rails entirely unknown in the Northern Hemisphere, are in the Southern Hemisphere absolutely confined to the islands of the Mascarene and of the New Zealand archipelagoes, which are separated from each other by nearly half the circumference of the globe. Dr. R. Bowdler Sharpe, speaking not long ago on the “Geographical distribution of birds,” at the Royal Institution, pointed out additional relationships (so far as their birds are concerned) between these same widely disconnected areas. In the Island of Bourbon there lived, till exterminated in comparatively recent times by incursive Europeans, a very peculiar starling with a long, slightly curved bill, the *Fregilupus*, the sole species of its genus, of which one of the very few examples that have been preserved may be seen mounted in the bird gallery of the Natural History Museum at South Kensington. It has no near relatives except in New Zealand, where the huia (*Heteralocha gouldi*), a bird equally peculiar and the solitary representative of its genus, forms one of the most interesting species of one of the most peculiar bird faunas of the world. The huia is remarkable in that the shape of the beak differs in the two sexes in a most surprising manner in association with habits unique, I believe so far as yet known, among the feathered tribes. The bill of the male is straight, powerful, and sharp; that of the female is in comparison exceedingly slender and strongly curved. The straight-beaked bird breaks up and chips off the bark and wood of trees, in quest of the tunnels of the grubs and insects that form their food; while the closely attendant female is keenly on the alert to thrust in its slender, curved forceps—where the beak of its mate is useless—to extract each nutritious morsel when discovered. Both are aberrant forms of their family, and both are on excellent authority considered to be descendants of the same ancestor. In the same two regions also, alone of all

the globe, there lived down to recent times, but now extinct (though ornithologists still cling to the hope that a few survivors may yet be holding out in the dense forests of southwest New Zealand), giant and flightless forms of blue water hens of two species, the *Aptornis* and the *Notornis*, of which as yet no remains have come to light in the Mascarenes, but are still found in some abundance in the caves and swamps of New Zealand.

The late Mr. W. A. Forbes (who at the time of his death held the post of prosector to the Zoological Society of London, and had already become distinguished as one of the best anatomists who had filled that most coveted position), a man remarkable for the keenness of his observational powers, for the amount and accuracy of his knowledge, and for the tenacity of his memory in regard to details of structure, investigated shortly before his death the relationships of *Acanthisitta* and *Xenicus*, lively little birds which are year by year becoming rarer in the forests and on the rocky talus slopes among the hills of New Zealand, and discovered that, in their anatomical structure, they have their nearest allies in Australia (and in part of the Indian region), in Madagascar, and in South America, but exhibit few affinities with groups elsewhere.

Professor Huxley many years ago, in a remarkable paper, read before the Zoological Society of London, on the "Classification of the gallinaceous birds," pointed out that they fall into two great groups, the one broadly occupying the Northern Hemisphere, and the other the Southern Hemisphere—Australasia and South America; thus dividing the globe into two regions which he felicitously termed Arctogæa and Notogæa. The Notogæan section of these birds comprises, according to him, the mound builders or megapodes (*Megapodidae*) in Australia and Papuasias, and the curassows or guans (*Cracidae*) in South America, both of which possess structural peculiarities in common, pointing to the fact that, though they now form different and easily distinguishable families occupying distant areas of the globe, they sprang from the same stock.

The relationships of the groups above referred to as distributionally confined to the Southern Hemisphere are such as can be made out by a trained eye without going very far below the surface; they are classified by characters either externally apparent or recognizable by an examination of their osteology or their coarser anatomy. But we have evidence of the same affinities existing between the fauna of the same dissociated portions of the globe derived from a deeper source than these. It is but a year or two since science had to mourn in the death of Prof. W. K. Parker the loss of the very foremost of English morphologists, and one whose knowledge of the anatomy—especially of the cranial structure—not only of birds but of most of the vertebrates, from their embryo onward, was unrivaled. In one of those numerous erudite papers, lit up with brilliant thoughts and analogies expressed

in deeply poetic language—unexpected in a subject so abstruse—and superbly illustrated by his own hand, which he communicated to the Zoological, the Linnean, and the Royal societies of London throughout his life, he has published his labors on the embryology of some of the birds most typical of Australia—its piping crows, its warblers, and wood swallows. He devoted himself especially to the investigation of the cranial constitution of birds from the very early stages of their existence, for he believed that “the outward form of the face gives the keynote to the whole bird; the head and face rule all things else, and every modification in the organs of progression must be in correlation with that deeper change which has taken place in the storied and labyrinthine walls of the head.” He has unfolded their lineage as surely as if he had witnessed its growth through the vistas of the past by watching the laying together of each separate element before “nature with her cementing osteoblasts had obliterated their individuality.” His penetrating eye detected the existence and recognized the significance to their pedigree of those structures, useless to the individual save that each new life must inexorably ascend by all the stairs its sires have climbed before it, which within the secrecy of the egg appear but for an hour and vanish as if they had never been. The pedigree of the Australian piping crows arises, he finds, from the same stock as the South American creepers (*Dendrocolaptidae*); that of the wood swallows oscillates between the ground thrushes (*Pitta*) of the Malayan Archipelago and the South American ant thrushes; while the affinities of the Australian warblers are with the wood warblers (*Mniotiltidae*) of South America, all of them declaring their affinity with forms in the Southern and not in the Northern Hemisphere—with groups whose homes are not on land areas continuous to their own, but in regions separated by wide seas, and at their farthest limits apart.

Such is the singular disconnected distribution of many undoubtedly related groups of birds, of which I shall presently proceed to offer an explanation.

Before doing so I wish to refer shortly to other sections of the animal kingdom. It is well known that Australia is the great home of those lowly mammals, the marsupials, the survivors of a family whose ancestry dates back to the Trias, a period to be reckoned only in ages, each perhaps of thousands of centuries. They are remarkable, as an order, for containing “isomorphs,” or groups that have the form and habits of many of the various other orders of the animal kingdom. The kangaroo rats, for instance, assume the outward form of our common rats and mice; others, such as the beautiful flying phalangers, resemble the insectivora; while yet others, as the “Tasmanian devil” are large, carnivorous, and wolf-like. Besides the Austromalaya region (which is a part of the Australasian realm), no region of the globe now contains any representative of those implantal animals, except the South American forests (from which two species have wan-

dered into North America). The present marsupials, however, of South America (the opossums) exhibit wide differences from those now living in Australia; it is therefore not improbable that their ancestry must be traced from forms once living, but now found fossil only, in North America. The singular implantal animals now living in Australia are but the remnants of a much more extensive order; for there vanished at a comparatively recent geological period other marsupials still more remarkable, especially for their gigantic size. Of these the *Diprotodon* attained to the proportions of a rhinoceros or a hippopotamus, and the *Nototherium* to that of a tapir; while the *Thylacoleo* was a gigantic carnivore that probably preyed on the titanic kangaroo of its own time, an animal twice as tall as the largest "old man" kangaroo (*Macropus giganteus*) of to-day, which has been known to measure nearly 6 feet from the point of the nose to the root of the tail. The interest of these remains has largely increased through the discoveries of South American paleontologists who have quite recently disinterred most unexpected treasures from the early Tertiary formations of Patagonia, the first fruits, there can be little doubt, of a large harvest of remains, which will certainly shed, as those already obtained have done, a flood of light on the pedigree of many of the vertebrata. Among these treasures not the least important are the remains of marsupials closely related to the *Diprotodon*, the *Thylacoleo*, and the "Tasmanian devil," which, in the Pliocene age, flourished in Australia in such abundance.

Turning for a moment to still another group of the vertebrata, we find that, in such widely separated spots as New Zealand, Patagonia, and the Falkland Islands, there occur identical species of different families of fresh-water fishes. The southern salmon (*Haplochitonidae*) and the southern pikes (*Galaxiidae*), which are unknown north of the equator, and which could not traverse the wide expanse of sea dividing them, are common to all of these localities. Our highest authority on ichthyology, Dr. A. Günther, F. R. S., of the British Museum, has shown that between the fresh-water fishes of Africa and Australia there is, though not an extensive, yet an unmistakable affinity; while, with many points of close resemblance between them, the African and the South American genera are distinct, which indicates "that the separation of these continents must have been of old date."

Mr. Wallace has, in his great work on *The Distribution of Animals*, pointed out how insects, as a whole, show a decided interrelation between Australia and South America. Indeed, he believes that the *Buprestidae*, a family of brilliantly metallic beetles, had their original development in temperate Australia, and spread thence, while of the longicorn beetle (so named from the long antennæ they possess) several genera are common to South America, Australia, and New Zealand, indicating that there must have been some means of communication between these countries other than at present. Both the families of

insects I have mentioned are wood borers, living on soft or decaying trees, in which also their larvæ are developed, and necessarily requiring for their growth and differentiation throughout the area of their dispersal an extensive and wooded region—a genial Antarctic continent, not merely a series of far separated islands as stepping stones.

Now if we turn to the plants of the Southern Hemisphere, and confining our attention to those not or but slightly ranging with the north of the equator, we find they present the same problems for solution as the fauna offered. Of the charming saxifrage family there are two tribes (*Escalloniæ* and *Cunoniæ*) which are peculiarly restricted to the south of the equator. They contain between them thirty-five genera, of which two only cross that boundary; the remaining thirty-three genera are distributed to New Caledonia, New Zealand, Australia (with Tasmania), the Mascarene Islands, and South America areas, as we have seen above in the case of the fauna, occupied by related forms, though separated from each other by wide seas. Of the forty-nine genera and nine hundred and fifty species of the *Proteaceæ*, the whole, with the infinitesimal exception of twenty-five species which pass to the north of the line, are distributed across the same regions, with the addition of South Africa. The genus *Cryptocarya* of the *Perseaceæ* is common to New Zealand, South Africa, and South America, while among the genera of other families we find some occurring in Africa, or Madagascar and Australia; some in Tasmania and South America only; while others crop up in South Africa and Australia, or New Zealand, or in New Zealand and South America only. During my travels in the Eastern Archipelago I discovered growing wild in the forests of Java a large colony of *Petræa arborea*, an arboreal species of the *Verbenaceæ*, which at the end of the last century (1792) was found by Smith and Wiles, on the *Providence* expedition, in Timor also. This genus was previously supposed to be entirely confined to the South American continent. And yet another near relative, *Petræa viter*, has still more lately been obtained in the islands of Buru and Amboina.

Now, as to the explanation of these instances of singularly disconnected distribution of so many plants and animals, the highest authorities are by no means agreed. Nor is it a question that can be finally settled while our information on many points necessary to its solution is so fragmentary. Year by year, however, new discoveries are mending the imperfections of our records, while continued sifting of the evidence already gathered is gradually eliminating what is unreliable and establishing more firmly that which is trustworthy. So far as his latest opinions have been expressed, Mr. Wallace, our highest authority on geographical distribution, holds that the presence of these numerous genera and species of the same families or groups of plants and animals in Australasia, in the Mascarene Islands, or in South Africa, and in South America, can be sufficiently explained as the remnants of ancient types once spread over the Northern Hemisphere, whose lands are prac-

tically continuous, driven southward along these continents by the pressure of more specialized types, and now finding refuge in these widely separated southern lands. No one can differ from Mr. Wallace on this subject without great diffidence, and certainly no one can feel a profounder admiration, even veneration, than the present writer (who has followed in so many of his footsteps in the archipelago he has made famous, with his fascinating book as his best guide and companion) for the opinions and writings of this most distinguished doyen of our naturalists. Still, I can not persuade myself that this explanation covers all the instances of discontinuous distribution—of forms unknown in the Northern Hemisphere—which have been adduced in the foregoing pages. It seems too extraordinary to be credible that it should alone have been the same forms that have survived the vicissitudes of climate and food during their long migrations through the deserts and forests of Asia, Malaya, and Australia to reach New Zealand; of Europe and Africa to reach the Cape and Madagascar, and of North and South America to arrive in Patagonia, and even in the Antarctic islands, and that scarcely a single representative of their line should have survived north of the equator. Nor does the explanation that has also been offered of the occurrence of the same genera and species in those remote regions—that they have been the result of independent development—appear to me to be more satisfactory; for the chances against the same genus or species becoming developed independently at various times in three or four distinct regions of the globe, under different conditions and latitudes, and only in the southern extremities of the great continents, are enormously great.

It has hitherto been laid down as a fundamental law in geographical distribution that the areas inhabited by a given species, and in considerable measure likewise by the same genera, are or have been continuous with each other. The conclusion has been forced upon us, therefore, that there must once have existed in the Southern Ocean a land area common to the terminations of the great continents extensive enough to afford room for the development of the ancestors of so many forms of life absent from the Northern Hemisphere; and that it was very genial in climate and clad with vegetation sufficiently luxuriant to support so varied a fauna. In studying the Southern Hemisphere on a globe, on which the natural relations of land and water are evident, and tracing out the continental shelf surrounding the existing Antarctic land within the contour of the 2,000-fathom line, so far as it is known, I was surprised to observe that the land that would result from such an elevation of the Antarctic sea floor would explain the perplexing distribution of the southern fauna and flora. It was also evident that a continent so formed would not interfere with the opinions entertained by so many of our highest geological authorities and oceanographers, that the beds of the great oceans are troughs, and the great meridional land masses are buckles (in parts at one time dry and

at another submerged) of the earth's crust, both of which have practically been permanent since primeval times, or to quote Mr. Darwin, that "where our oceans now extend, oceans have extended from the remotest period of which we have any record; and where continents now exist large tracts of land have existed, subjected, no doubt, to great oscillations of level since the Cambrian period."

The boundaries of this continent of Antarctica, as I have proposed to designate it, would have united Patagonia, New Zealand (as part of such a large continental island as I have described and named Antipodea, on page 299), Tasmania with East Australia, and that old island-continent (joined, perhaps, by a narrow commissure, for a longer or shorter time, to East Africa), which Dr. Selater long ago named Lemuria, to a circumpolar land greater than at present by extensive independent peninsulas, between which the Atlantic, the Pacific, and the Indian oceans extended almost as far south as they do now. It will be observed that South Africa is excluded in this view from actual contact with this southern continent. That it did not remain so long as the others in direct connection with Antarctica seems indicated by the presence of so aberrant a form of the struthious family in that country as its ostriches, which possess on their tarso-metatarsal bones two articulatory trochleæ only, thus reducing theirs to a two-toed instead of a three-toed foot, as is found in the moas, the *Epyornis*, the cassowaries, the emus, and the *Brontornis*. The loss of this toe points unquestionably to a very long isolation of the ostrich from inter-marriage with the more normal members of its order. The African ostriches also differ from the eastern members of the family, in having no after-shaft to their contour feathers, a character in which they agree with the rheas of South America, a group to which the African ostriches are more closely, though still very distantly, related than perhaps to any of the others. It would seem highly probable also that the connection between South America and Africa was severed at a very early period—an assumption supported by the distribution of the fresh-water fishes of Patagonia and South Africa, which, though indicating, as Dr. Günther has so well elucidated, by the undoubted affinities between them, a previous approximation of the two regions, yet in the distinctness of their genera plainly speaks of a long disseverance. The boundaries of this Antarctic continent, which I have indicated, would have inclosed all the circumpolar land and the islands in the Southern Sea. Actual, apart from deductive, evidence for the existence of a greater extension of land in this region is of course very limited, yet it is not altogether absent.

No visitor to the Chatham Islands can fail to be struck by the number of lakes and tarns that everywhere dot the landscape. Nor can he travel far without remarking that the surface of the ground is covered by a continuous layer of peat, which is in many places 40 to 50 feet deep, and in some still unfathomed. It is in general solid enough

to permit safe traffic over it, but extensive areas are covered with unsuspected wet bogs extremely dangerous to a pedestrian unacquainted with the country. The time required for the accumulation of this enormous deposit may be imagined when it is remembered that it takes several feet of sphagnum—the moss of which peat is chiefly composed—as seen growing on the surface of the bog, to form 1 inch of dense black peat at its bottom. Everywhere throughout those peat bogs trunks of trees, larger than and of a different sort to those that now grow in the islands, lie entombed. They are the remains of ancient forests which have succumbed “to the chilling effects of the wet bog mosses in their upward growth.” The woods that now or did recently (for they are fast disappearing before the demands of the agriculturist) cover the ground are but the latest of a succession of forests already swallowed up that had in turn taken possession of the land wherever the water had drained away and the growth of the mosses ceased.¹ The antiquity of these islands is proved by the fact that in different places the more ancient of these peat beds have become consolidated into lignite.

This account of the surface features of the Chatham Islands might serve equally for those of Kerguelen Land, which also abounds in large bogs, in lakes and great pools in the hills, and in fiords—all evidences of great antiquity, of glaciation probably, and certainly of very extensive subsidence. In the Auckland Islands also occur bogs and beds of bituminous peat; while both in the Crozets and in Kerguelen Land fossil trunks of large trees have been found, all distinctly pointing to the existence of extensive and varied forests on these now sleet-swept, bare, inhospitable lands. The prevalent features of the present flora of Kerguelen are Fuegian, many of the species in both regions being identical or nearly related, while others are common to Tasmania, and still others to one or more of the unsubmerged fragments of Antipodea (New Zealand and its surrounding islands), and some to all these three regions, one fern being common to Kerguelen and the Cape of Good Hope. To Kerguelen Land and to Marion Island, 1,600 miles west of it, is confined a still more remarkable genus of plants, known as *Pringlea*. It is very distinct, is without near relatives, and is the survivor of a flora unknown in any other part of the globe. Its seeds are perishable, and on this account it is very unlikely that it has been conveyed by birds from one island to the other; and is therefore with high probability indigenous to both. Its distribution to those isolated spots, and various “phenomena, besides, common to the three archipelagoes—Kerguelen, Crozets, and Marion—favor,” in the opinion of Sir Joseph Hooker and other high botanical authorities, the “inference - - - that these constitute the wrecks of either an ancient continent

¹The reader is referred to a very interesting little volume on British mosses, where their relation to ancient forests is dealt with, by the Right Hon. Sir Edward Fry, and to his paper in the Proceedings of the Royal Institution, 1892.

or an archipelago extending farther westward," on which the progenitors of their once existing, or still surviving, endemic flora became developed.

On a former page it was predicated that if such an austral continent ever did exist, it must have been blessed with a very genial if not a tropical climate, capable of supporting extensive forests and other luxuriant vegetation fit to harbor and nourish the marsupials, the birds, and the insects found in these southern regions. That such extensive forests did exist in far southern latitudes requires no more proof than the occurrence of the fossil tree stems in Kerguelen Land and in the Crozets; while I shall now try to show that the genial climate of which I have spoken once prevailed in these islands.

It is to the late Dr. James Croll that we owe the first satisfactory account of the astronomical and physical causes on which climate depends, especially in reference to the causes of the glacial epochs, which he proved to be, in that hemisphere, due to the occurrence of winter when its pole was turned away from the sun at the same time that the earth during its greatest eccentricity was at its farthest distance in its orbit from the source of heat. Sir Robert Ball, who has made some important additions to this theory (by establishing mathematically the different percentages of heat that are received in the summer and in the winter of each hemisphere) emphatically asserts, as a mathematician, that it is of the essence of the astronomical theory that "the glaciation over the hemisphere shall be simultaneous," and if it were not so "it would seem wholly impossible to offer an explanation of the phenomena by any physical cause known to us." On the other hand, "viewing the two hemispheres each as a whole it is important to observe that their respective glaciations were not simultaneous," indeed "if it could be shown that the ice ages in the two hemispheres were concurrent, the astronomical doctrine would have to be forthwith abandoned." "It is also of the essence of the astronomical theory," he maintains, "that a glacial epoch in one hemisphere shall be accompanied by a genial epoch in the other, and that, after certain thousands of years, the climatic conditions of the two hemispheres shall become interchanged; that the ice shall leave - - - and the regions that it has abandoned shall become clothed with luxuriant vegetation." Since the duration of the eccentricity of the earth's orbit, when once it supervenes, endures through a period in which the rotation of the line of the equinoxes round the ecliptic may take place more than once, "clusters of ice ages and genial ages" may have followed each other before each period of high eccentricity which originated them passed away. "Each hemisphere is plunged alternately into extremely glacial and extremely genial conditions, and though, no doubt, during the transition, there may be centuries during which intermediate conditions will prevail, yet such periods can hardly be said to have resem-

bled the normal conditions of the globe such as that which it now enjoys."¹

Many authorities are of opinion that great subsidences of land are natural concomitants of a glacial period, and that it naturally follows that the accumulation of ice at one pole must abstract and pile up a large amount of water, and thus cause land in the opposite hemisphere to be uncovered.

During the continuance, therefore, of the glacial epoch in the Northern Hemisphere, there must have existed over the Southern Hemisphere an extremely genial epoch, during which there is no doubt that wherever land existed it was clothed with a luxuriant vegetation, and that its boundaries would be enlarged from the causes just spoken of. This vegetation would, doubtless, not be less varied and tropical than that which flourished in high northern latitudes in Miocene times, and which was still a remarkably temperate flora within $8\frac{1}{2}$ degrees of the North Pole, and it is evident that it could harbor, and on it there could develop the ancestors of the fauna and flora whose descendants are now scattered across all the southern regions of the globe. That an extensive land did exist not dissimilar to that described in a former page, seems to me almost an inevitable deduction from the distributional facts adduced above—especially in regard to the insects, the marsupials, the birds, and the plants. Of this mass of evidence, the distribution—to shortly recapitulate—of the three trochleated struthious birds in all the great regions; the *Aphanapteryx*, the blue gallinules, the starlings, and the crested parrots in Antipodea and Lemuria; the fresh-water fishes of Australia and America—none of them northern forms—is, to me at least, evidence not otherwise explicable. But none of that evidence seems to me to testify with greater weight than the embryological and anatomical data, which I have quoted from the writings of those distinguished workers, Parker and Forbes, two men of the highest authority in their science, inasmuch as it has been detected, not in the superficial characters only, but deep down in structures whose similarity can not but proclaim genetic relationship, through ancestors who have now vanished, and whose homes must have been on a land common to and in connection with those widely separated regions which their descendants now occupy. The necessity for the existence of a land surface in the Antarctic Ocean was recognized and has been expressed by Mr. Darwin. "New Zealand is plainly," he says, "related to South America, which though the next nearest continent is enormously remote, yet this difficulty disappears in the view that New Zealand, South America, and the other southern lands have been stocked in part from the Antarctic islands when they were clothed with vegetation during a warmer Tertiary period."² Dr. Blanford, in his well-known

¹ These various extracts are from *The Cause of the Ice Age*, by Sir Robert Ball.

² *Origin of Species*, Vol. II, page 190, 1888.

address to the Geological Society of London, in 1890, gave it as his opinion that "if the difficulty about the depth of the intervening ocean is overcome"—and such a continent as I have sketched out in the rough, whose shores, more or less, followed the 2,000-fathom line, presents no insuperable bathymetrical difficulties to acceptance—"there is no improbability in the suggestion that at some period of geological history an important continent, having connections with South America, South Africa, and New Zealand, may have occupied the Antarctic area."

Throughout his wonderful papers on the embryology of the bird's skull, Professor Parker¹ constantly perceives and insists on the necessity of dividing birds into northern and southern forms: "In the South the most struthious types, and in the North the highest," and he expresses his belief that our bird groups are "as important for study in their geographical distribution as in their taxonomy or their morphology." Professor Parker constantly adduces also instances of the relationship of the birds of the eastern with those of the western side of Notogaea. "If these instances," he says, "of changed forms in the eastern Notogaea, corresponding to unchanged (or less changed) types in the western Notogaea, can be shown to be common, it will go far toward the establishment of a true theory of dispersion and modification of types. If not, if every zoological species has been created, as it is now, fenced in by laws that can not be broken, 'a hedge set about it and all that it hath,' then I trust, for the sake of true science, that this glamour will soon be removed from our eyes, and that we shall not be lured on farther after evolutional 'will-o'-the-wisps.'" This bond of organic community must have been by a land area in the southern seas, which with considerable probability occupied the region which I have designated Antarctica. It seems to me that such geological evidence as the occurrence of fossil penguins in the Eocene of both Patagonia and New Zealand, and of marsupials and dinornithine ostriches in the early Tertiaries of South America, of *Dinornis* and *Epyornis* in New Zealand and Madagascar, point to the existence of southern land—doubtless with elevations and subsidences between—at least from the close of Secondary times. But it is impossible, at least yet, to determine whether the fauna and flora of which remnants exist in the present southern continents and islands are the result of the development and dispersal during the genial period corresponding to the last of the northern alternating clusters of glacial and genial periods during the latest high orbital eccentricity, or partly of the first of these or of a combination of both and of similar former vicissitudes.

It seems established on paleontological evidence that in the Northern Hemisphere, during the early part of the Tertiary period, the climate was tropical in the middle of Europe, and that in the Miocene we have

¹ On *Ægithognathous* Birds, Transactions Z. S., Vol. X.

this climate extending not only to the limits of the north temperate zone, but a luxuriant temperate flora flourishing up to nearly 82° of north latitude. It seems difficult, too, to believe, if we compare all the conditions now existing at both poles under the present low eccentricity of the orbit, that such a genial climate as just described could have prevailed at so high a latitude, except under the conditions that would necessitate a glacial epoch at its antipodes. So that, if we accept the astronomical theory, we must believe that during the northern Miocene period there was a glacial epoch in the Southern Hemisphere, of which the rock striation and moraines in Africa, the moraines in Australia, New Zealand, and South America, may perhaps be the result. That there was at this time a force driving southern and tropical forms to the north is strongly corroborated by the distribution of the fossil *Sirenia* (now, and probably always, exclusively confined to the Tropics) of which there are twelve genera and twenty-seven species ranging from the Tropics up to 60° of north latitude in the Eocene and Miocene of Europe, Asia, and North America.¹ The remains of southern forms of birds, such as parrots and trogons, not infrequent in the Oligocene and Miocene strata of Europe may not unlikely have been migrants driven from the south before the same impelling force. That there has been such a northward migration is also evidenced by the occurrence of so many plants belonging to New Zealand, Australia, and some of the Antarctic islands isolated on the peaks of New Guinea and of Borneo. We must caution the reader, however, against supposing that the southern formations which have been named Eocene and Miocene, etc., are necessarily synchronous with those so named in the Northern Hemisphere. All that can be affirmed is that those systems which contain a similarity of succession of their fossils (especially their marine organic remains) are homotaxial—that is, the order in which they appeared on the earth has been similar.

This much, however, may be accepted as mathematically demonstrated, that, during the glacial epoch of the Northern Hemisphere, while the high eccentricity of the earth's orbit lasted, there was an extremely genial age over the continent, the probability of whose existence we have shown to be high, and that its fauna and flora, of which some examples have been cited, were eventually expelled from their southern paradise, on the passing away of the northern glacial epoch, by the slow increase of the southern cold, which has gradually reached to but no farther than its present condition toward glaciation, owing to the decrease of the eccentricity of the orbit and by the extensive subsidences of the land, due probably both to the ice accumulation round its pole and to the enormous amount of volcanic disturbance of which the whole region appears to have been the theater.

Now, as to the explanation of these anomalies of distribution in the Southern Hemisphere, the arrangement of land which I have outlined

¹Dr. H. Woodward, F. R. S., in the *Geological Magazine*, page 423, 1885.

above will, I think, account for them not less satisfactorily than that by an entirely northern center of dispersion. Mr. Wallace¹ holds that "the three most important south temperate land areas—south temperate America, South Africa, and Australia—have in all probability always been as widely separated from each other as now," and "that it is unnecessary to suppose any land connection to explain the resemblance between their animal and vegetable inhabitants," as he considers that the northern continuous land was the origin of them all, and that they spread meridionally south. That many forms of life did thus reach Notogæa "under pressure" of glacial epochs and "of more specialized types" it is impossible to doubt. But, as I have already remarked, this explanation will not account for marks of heredity seen in such southern groups as the piping crows of Australia and the dendrocolaptine birds of America, and the many other instances in the same category enumerated by Professor Parker. That their original ancient progenitor may have come from the north is, of course, possible, but the characters that prove a common parentage—in forms now so diverse—could not have arisen in birds living so far apart as Australia and South America, without, I believe, a large common land area on which the progeny of the original parents could develop and spread over.

Mr. Wallace believes also that the ancestral forms of the marsupials and monotremes reached West Australia (which for a long period in secondary and primary times was separated off as an island from East Australia, an arm of the sea uniting the Banda and the Antarctic seas) from the north, through Java and the intervening islands or land in that sea. Their fossil forms have, however, been chiefly found in East Australia, or if found in West Australia, they occur in strata certainly of no greater age. If such, indeed, were the route of their southward march, it is remarkable that throughout the extensive regions over which they passed not a single individual has survived—not even in Timor, an island of like vegetation and climate to Australia, and that nearest to West Australia; while marsupials and monotremes are represented abundantly on the northern and eastern Papuan islands, with which West Australia, as Mr. Wallace believes, was not at that period in connection. That these groups may have originated in Antarctica and spread into Australia via its Tasmanian peninsula, since fossils presenting many affinities with the Australian forms have recently been discovered in Patagonia, appears to me a not less satisfactory explanation of their distribution. Their absence so far from New Zealand is not more difficult to account for than their entire absence in the land which, according to Mr. Wallace, they traversed. Again, as regards the dispersal of the ancestors of the struthious birds, Mr. Wallace believes that they reached East Australia from New Guinea, with which it was united across Torres Strait; and that the emus, the cassowaries, the

¹ *Island Life*, page 527.

Dromornis, and the moas are their descendants. If the forms with a three-trochleated metatarsus (from South America, Madagascar, and New Zealand) had been developed on a southern land, they could, on their dispersal and northern trek, have reached the region where they now are with as much ease as by the route supposed by Mr. Wallace.

The earliest strata in which the fossil remains of both the Northern and Southern Hemisphere struthious birds have been found have been determined as Eocene, but whether these were really contemporaneous periods in the north and in the south, and which is the older, it is impossible to tell, so that their migrations may have been quite as likely from the south as from the north; indeed, the struthious type of bird is, according to Professor Parker, essentially Notogæan. The African ostrich has been isolated from its congeners in the south for a long period of time through the disconnection of Africa from Antarctica, and has become specialized and lost its third metacarpal trochlea and the toe it carried. Since its isolation it has spread over Africa northward, but it once lived in Miocene times in Greece, in Persia, and in the Siwalik region of India. Again, in New Zealand and in East Australia we find a great similarity in the genera of their plants, while the species they possess in common are comparatively few, which is what might be expected in regions unconnected with each other except through a common land at some distance—the Antarctic continent I have predicated. No other explanation except a common southern land will satisfy the distribution of the *Aphanapteryx*, the blue water hens and the starlings of the Mascarene and the New Zealand regions—groups of birds which are unknown on the north side of the equator.

As is well known, there live in the Galapagos Islands, on the equator, off the west coast of America, giant tortoises, of which one of the most remarkable facts about them is their zoological isolation. They have no relations with any of the forms of their own order on the neighboring continent. In several of the Mascarene Islands there lived when they were first visited by Europeans enormous numbers of equally giant tortoises—of which a few still survive—also in as complete isolation as the Galapagos species, for they can claim no relationship with the tortoises of the nearest land, Africa. Yet, strange to say, the tortoises of Aldabra and Madagascar indicate the closest affinity with those of the Galapagos Islands. This extraordinary and seemingly inexplicable case of distribution receives, in my opinion, its easiest explanation by supposing that their ancestral home was in Antarctica, whence, forced by cold and the submergence of the land south of them, they traveled north by diverging tracks, waudering, the one along the west coast of America and the other toward Lemuria, where, having reached islands without foes, they have prolonged their years beyond those of their fellows, which have died out everywhere else.

It is not necessary to suppose—and, moreover, it is very improbable—that all these continental southernly peninsulas were contemporaneously connected with Antartica. It is impossible otherwise to account for the presence, for instance, of the same South American forms in Australia and their absence in New Zealand; for Mascarene forms in the New Zealand region and not in Australia or Africa or elsewhere. So long as we are unacquainted with the orography of the submerged southern continent, with its mountain and river barriers, and the order of the making and breaking of its various commissures, we can hardly hope to account satisfactorily for all the anomalies of the southern distribution, none of which, however, are inexplicable when the inevitable elevations and subsidences due to the vast physical disturbances, of which we have abundant evidence all over the region, are considered.

Shortly, therefore, it is highly probable that an extensive continent existed in the Southern Hemisphere, on which many forms of terrestrial life originated and had there the original center of their development and dispersal; that Professor Huxley's division of the globe, according to the distribution of its life, into a northern and into a southern land must be accepted as its two primary biological divisions, from whose centers of development at both poles the wanderings of the fauna and flora were regulated by cold and warm periods and by the elevation and flooding of one part of the continental plateau after another, and that from their advances and retreats across the equator and their journeyings from east to west, according to the geographical features of the region and its meteorological conditions, on which their existence depends, resulted the present wonderful distribution of life on the globe which forms so fascinating a study to all who commence it.

THE PROMOTION OF FURTHER DISCOVERY IN THE ARCTIC AND THE ANTARCTIC REGIONS.¹

By CLEMENTS R. MARKHAM, C. B., F. R. S.

In delivering my anniversary address for the first time as your president, it is with a feeling of intense satisfaction that I am able to do so after all old wounds have been permanently healed over, and after perfect harmony has been restored in the society. It was found last year that the rules did not all work so as to give complete satisfaction either to the council or to the rest of the fellows, and some deplorable friction was the result. This has now been remedied. The privileges and rights intended to be enjoyed by the fellows under the charter have been fully and clearly secured to them by the rules; all possibility of contentious discussion and debate has been entirely banished for the future from our anniversary meetings; and special general meetings will not be called without more ample notice than has hitherto been given, while requisitions for them will be made, and resolutions will be passed by a more adequate number of fellows. These alterations in the rules were called for by the general sense of the fellows. They have removed all feeling of dissatisfaction that lingered amongst us. It will be my aim, as your president, to maintain the harmony which happily now exists by keeping the fellows acquainted with the decisions of the council affecting the well-being of the society, and by using every effort to prevent friction, and to promote, and if possible to increase, the interest taken in the society's work by the individuals who compose it.

I have long entertained the idea that these desirable objects might be secured, among other ways, by a plan which, with much help and advice from members of the council and from the society's staff, is now nearly matured. I have drawn up a list of all the fellows who have written papers for our Proceedings or Journal, or have published books, or are known to have a special knowledge of one or more departments of our science, and to this list additions have been made by others. For the present I have called it a List of Referees, because papers or

¹Address to the Royal Geographical Society. Delivered at the anniversary meeting, May 28, 1894. Printed in the Geographical Journal, Vol. IV, No. 1, July, 1894.

questions can advantageously be referred for report to any of the fellows contained in the list, as regards their special subject or subjects. It is divided into two parts, the first being an alphabetical list of names with the subjects respecting which each is an expert; and the second being arranged according to countries and subjects. It will be sent to many fellows of the society for suggestions and additions, and when tolerably complete, it will probably include several hundred names. Some fellows are collectors of geographical books or maps. Others may have a profound knowledge of particular regions, or of special departments of our work, who have never published anything. The referees may have papers referred to them, may become members of committees on questions relating to their special subjects, and would, no doubt, be ready to give information and advice to inquiries, while the council will be mainly recruited from them. The existence, and eventual publication, of the List of Referees will be of use to the general body of fellows in various ways. Taking a more general interest in geographical subjects, the elders will thus be informed whither to go for information on points that occupy their attention, while it will be the ambition of the younger members to qualify themselves for inclusion in the list. In various ways I confidently hope that the plan will have the desired tendency of drawing the fellows more together, and into nearer touch with the council.

Another measure, which I anticipate will have a similar effect, will be to offer more inducements to study and make use of the great store of geographical information in our library, by the completion of the catalogues, and by giving greater convenience and more comfort to readers. The present alphabetical catalogue was made in 1865, and there have been two supplements in 1870 and 1880. But in 1893 it was decided to recast the whole catalogue, including the three supplements (for a third up to 1890 had been prepared and was ready for printing), and to make one continuous alphabetical catalogue, printed in smaller type than previously and in double column, and brought down to 1893. It is now all in print. There will be two appendices, the first containing an alphabetical list of all the collections of voyages and travels, with an analytical table of contents to each volume, which is also in type. The second appendix is devoted to anonymous and periodical literature arranged in geographical order. The catalogues have been made under the control and superintendence of Dr. Mill. The assistant in the library, Mr. Vincent Hawkins, deserves great credit for his industry and diligence, and Dr. Murie has now put the series of periodicals into perfect order, making a list of all deficiencies; but the second appendix is not yet finished. The authors' catalogue will, however, be in the hands of the fellows in the course of the present year.

A subject catalogue was prepared by Mr. Godfrey Evans in 1871, and was extremely useful, but it now contains less than half the books in the library. In 1892 it was therefore resolved that a new and exhaustive

subject catalogue should be prepared, and the services of Dr. Murie were secured, to work at it under the control of Dr. Mill. He has since given the society the benefit of his remarkably wide knowledge of geography and travel, and of his rare perseverance and organizing ability. The three essentials of this catalogue are that it is to be exhaustive, systematic, and exclusively geographical, many works in the library that are not geographical appearing only in the authors catalogue. A subject catalogue fulfilling these conditions will be an invaluable contribution to geography, serving as a guide to all workers in all parts of the world, as well as rendering the contents of the library accessible to fellows. It involves enormous labor. All the titles of books and pamphlets in the printed catalogues, numbering 18,000, have been cut out and classified; and all transactions and periodicals have been rearranged. Dr. Murie calculates that the number of titles of papers in periodicals will amount to 84,000; so that the complete catalogue will comprise about 110,000 titles, occupying 5,000 octavo pages of print. Dr. Murie is now put upon his metal to complete the work in not more than two years.

Dr. Mill gave a new form to the bibliography in the Journal when it was commenced last year. It was made to include not only books and separate pamphlets, but all the longer geographical papers which appeared in the periodicals received in the library. Thus an analysis of current geographical work is presented each month. From these notices a subject card catalogue has been compiled since June, 1892, divided into continents and subdivided into countries and provinces, the arrangement being assisted by the use of differently colored cards. As it is kept up to date, this card catalogue forms an appendix to the great subject catalogue.

As soon as the alphabetical catalogue is finished I intend to establish two desiderata books—one for fellows to enter any book they may have asked for which is not in the library, and the other to contain a complete list of works which are wanting to make our library perfect.

I am very anxious that the accommodation for readers should be improved and that they should be made more comfortable, in order that their numbers may increase and that more use may be made of the library. Several suggestions have been made with this object in view from time to time, and now the question of either improving and enlarging the accommodation in our present house or of buying other premises is occupying the very serious attention of the council. Momentous financial and other questions are involved, and the subject is one which calls for most careful consideration. It will not be decided hurriedly, and no irremediable step will be taken without the consent of the fellows of the society assembled at a special general meeting. At the same time a final decision is rather pressing, as all the work is kept in an unsettled state until it is known whether we are to remain in our present house or to go elsewhere. For instance, the press marking

of the books in the library can not be proceeded with until it is known on what shelves they are to rest. The fellows may be assured that our deliberations will be full and mature, that we shall seek the best advice, and that our final decision on this subject will be the best that can be made under the very difficult circumstances, when there are so many things for and against any course we can adopt.

The Geographical Journal in its present form has now completed the first eighteen months of its existence, and we may claim for it that it has more than fulfilled the expectations that were entertained of it. We now receive every month the papers read at our evening meetings, with good and original maps, with the discussions and often with illustrations, papers on scientific and on applied geography, carefully selected and classified notes on matters of general geographical interest, notices of the literature and cartography of the month, obituaries, and news. I find that already our Journal has attained a fair share of success. The sale to the outside public has increased considerably, and the importance of our publication may be gauged to some extent from the fact that the advertisements have increased from four to an average of twenty-two pages. This is important, because it helps the Journal in its new form to pay for the expense of its production. The fact that it is quoted everywhere, at home and abroad, may be taken as a sign that it has already been recognized as the leading organ of geography, at least in the English language. From the beginning it has been favorably noticed by the principal organs of the press. But I consider that the most gratifying testimony to the enterprise of our society in this and other directions is contained in a letter from the celebrated traveler and geographer, Baron von Richthofen. "Will you allow me," he wrote, "to make use of this opportunity for congratulating you on the excellent character of the Geographical Journal?" As far as our means permit, we shall endeavor to improve its character and attractions. We have subscribers outside the society in all parts of the world—in remote towns in the United States and in Australia—and steps will be taken to bring the Journal under the notice of hundreds likely to be interested in it, both in America and the Colonies. The size of our publication will probably have to be increased before long, for even with the extra pages which have been added our accomplished editor finds it increasingly difficult to keep pace with geographical activity in all departments and in all parts of the world.

We thus have in our Journal every month a very complete review of geographical proceedings throughout the world, and every six months six Journals are presented to us with an index. The review of these proceedings which it has been customary for former presidents to give in their annual addresses, has therefore become unnecessary, for the fellows will already be in possession of such a review, and another recapitulation is neither useful as information nor serviceable for future reference. It is work already well done. It seems desirable, therefore,

as likely to be more interesting to the fellows, that the main part of the address should in future dwell upon some particular subject, preferably one that has most engaged the attention of geographers during the past year.

I freely acknowledge that the omission of a detailed review of the progress of geography will be quite a new departure, for such a review has annually been given since the foundation of the society. For many years it was essential, because the information could not be found elsewhere, and for a long time it was very useful; but as it has now become unnecessary, owing to the improved character of our Journal, the time for a change in the plan of the annual address seems to have arrived. During the first eight years of our existence the reviews of geographical progress were written by our indefatigable naval secretaries, Captains Maconochie and Washington; but in 1838 my accomplished predecessor, Mr. W. R. Hamilton, introduced the practice of delivering annual presidential addresses, which has ever since prevailed. Since 1838 there have been only three occasions on which the annual address has not been written and delivered by the president. In 1861 Sir Roderick Murchison, as vice-president, delivered the address in the absence of Lord Ashburton; in 1879 I delivered the address as secretary, owing to the absence of Lord Dufferin; and the illness of Lord Aberdare made it necessary for General Strachey to deliver the address in 1886. It was the custom for the obituaries, which now appear in the different numbers of the Journal, to be collected in the address, and there was a detailed review of work done during the year. I may observe that the address was always entitled "Address to the Royal Geographical Society by the president" from 1838 to 1878. In 1879 I prepared a statement of the progress of geography during the year in lieu of a president's address, and ever since my title has been adopted and the president's address has been called "The annual address on the progress of geography." But that title was not intended for the president's address. I now propose to revert to the older and more convenient title, "Address to the society by the president," leaving each president freedom to choose his own subject-matter.

For it was not the plan of Mr. Hamilton that the addresses should be confined to obituaries and reviews of current work, as has generally been the case in recent times. He and his immediate successors, while following the established practice, also dwelt upon some special subject in the body of their addresses. In 1838 Mr. Hamilton discoursed on the importance of geography and on the uses of the society; and in 1839 his great numismatic knowledge enabled him to offer some most interesting suggestions respecting our medals. Mr. Greenough occupied his address with a treatise on map drawing and an improved system of mapping. Admiral Smyth dwelt on the duties of the society, and on the definition and scope of geography. Sir Roderick Murchison made it a regular practice to select some subject of interest as the principal

feature or kernel of his addresses. In 1844 this was the Ural Mountains and the gold produce of Russia. In 1852 he sketched out, with a master hand, the geographical features of the African continent. Oceanography, suggested by Maury's charming work, was the subject of Sir Roderick's address in 1853. In 1857 he stirred his audience to enthusiasm by his advocacy of a final Arctic search; and in the following year he dwelt on changes of the earth's surface. Earthquakes were his subject in 1859, the former condition of Europe in 1863, and glaciers in 1864. In 1865 he reviewed the work remaining to be done in all parts of the world. The address of 1867 was devoted to the Aralo-Caspian Basin, and Sir Roderick's later addresses were occupied with the connection of geography with geology. After Sir Roderick's time the practice of giving a kernel to the presidential addresses was abandoned until, in 1888, General Strachey touched upon the legitimate limits of geography and, in 1889, on the occupation of the waste spaces and on the supremacy of civilized races.

The idea of devoting the bulk of the presidential address to one special subject of interest is not, therefore, an innovation, for it was the almost invariable practice of Sir Roderick, and had been occasionally adopted before his time. As the ordinary subject of former addresses is now adequately provided for every month in the *Journal*, a mere recapitulation can serve no useful purpose. The fare that should now be served up to the fellows is a kernel in imitation of Sir Roderick's menu, with such garnishing as time and circumstance may suggest and as each president may think desirable. Such is my ideal of the presidential address of the future; but I am unable to entertain the hope that I can make even an approach to its realization. I will, however, take this opportunity of dwelling upon the subjects which have chiefly occupied geographers during the past year, namely, the promotion of further discovery both in the Arctic and the Antarctic regions.

No less than six expeditions have either been projected or undertaken to explore different parts of the Arctic regions within the last two years, so that the subject has necessarily occupied a large share of our attention. It is one that has been before this society since its foundation, and some of the most important Government expeditions, including that of Sir George Nares in 1875, were due to the initiative of our council. In the long period, during which Arctic work has been over and over again under the special consideration of the council, and of committees appointed by it, consisting of men of science and of varied Arctic experience, distinct canons of exploration have been laid down, and opinions have been formulated which will certainly be useful for our guidance in the future. The council has always consistently maintained that merely to reach the North Pole, or to attain a higher latitude than someone else, were objects unworthy of support. In our view, the objects of Arctic exploration are to secure useful scientific results: In geography, by exploring the coast lines and interiors, and by

ascertaining the conditions of land and sea within the unknown area; in geology, by observations and collections; in zoology and botany; and in physics, by a complete series of observations, extending over at least a year. I well remember that when, in 1874, we were preparing the memorandum on the scientific results of Arctic work, General Strachey added another consideration. It may be shown, he said, that no such extent of unknown area, in any part of the world, ever failed to yield results of practical as well as of purely scientific value; and it may safely be urged that, as it is mathematically certain that the area exists, it is impossible that its examination can fail to add largely to the sum of human knowledge.

The unknown area remains very much as it was left when these words were written in 1874, except that the expedition of Sir George Nares, in the two following years, discovered the trend of the land on the eastern and western sides of Robeson Channel, the great extent of the sea of ancient ice, and brought back valuable collections and observations in all branches of science. We are still ignorant of the region to the north of Siberia. The northern, western, and eastern sides of the archipelago of Franz Josef Land have yet to be explored. The problem is still unsolved whether there is land due north of Spitzbergen. We have yet to hear whether the outline of Greenland has been completed. Ellesmere Land is almost entirely unknown, as well as the important and interesting region leading from Jones Sound. The whole vast region between Prince Patrick Island and Siberia, the exploration of which will lead to such important results in physical geography, is also unknown. The whole of this work can only be accomplished gradually, and one expedition will have to follow another until all the knowledge attainable in this field of inquiry has been secured.

For achieving success we have held certain canons, the correctness of which has been confirmed by all experience. It is true that they may be neglected on rare occasions without fatal consequences, but this can very seldom be done with impunity. The first great lesson taught by two centuries of experience is that no extensive and useful exploring work can be calculated upon by merely entering the drifting pack. Secure progress can only be made by following a coast line. The second canon is that at least one winter must be passed at a point beyond any hitherto reached. This is essential in order to obtain series of meteorological and magnetic observations of any value. The third rule is that a ship, not a hut on shore, must be looked upon as the proper base of operations, sledges being the main instruments for exploration and discovery. Thoroughly good work, including complete series of observations of all kinds, can only be secured by the appliances and resources of well-equipped Government expeditions. When the conviction of the importance of that part of the duty of a Government is absent, which is unfortunately the case during long intervals, private enterprise has always been ready to enter the breach, though with

inferior resources, and therefore at greater risk. The commander of an Arctic expedition ought to be a man of high scientific attainments, of great experience in the ice, and known to be gifted with the rare qualifications of a leader of men. Such a commander is seldom to be found except in the service of a Government with a wide range of selection. When the circumstances and qualifications that we would desire to secure are unattainable, then we gladly welcome the nearest approach to them. Enterprise, however contrary to rule and however audacious, should ever be encouraged and cheered onward. When there are only small resources, risks must be run and attempts must be made which could not be approved under other circumstances. We shall always admire and applaud the enthusiasm and temerity of those who make attempts to open geographical secrets by private enterprise and with inadequate means. It is under such conditions that the projects have been conceived, and in some cases matured, which have engaged our attention in the Arctic regions during the last two years. The merit of the work that may be achieved will be immensely enhanced by the special difficulties arising from different causes in each case, but all increasing the risk and the glory.

In Nansen the expedition to the north of Siberia has the unusual advantage of having a commander of high scientific attainments, considerable Arctic experience, and the rare gift of inspiring confidence among his followers. As is well known, his guiding idea is that as all previous expeditions have been stopped by the ice drifting south, he would not be stopped if he entered the Arctic regions in the ice stream drifting north. He thus discards our chief Arctic canon, which is that progress should always be made along a coast line; but the application of that rule has always been to ice drifting in a direction contrary to the course of the ship. It seems very doubtful whether the initial force of the current on the Siberian side of the Polar Sea will be sufficient to carry the *Fram* into the strong stream which undoubtedly flows south between Spitzbergen and Greenland. Her drift, however, may be in the direction that is anticipated by her sanguine and very able commander, and it is almost certain that there is an ice-laden channel, unobstructed by extensive land. We have no intelligence of the expedition having reached the neighborhood of the mouth of the Lena, and it is possible that the *Fram* may have been beset in rounding Cape Chelyuskin, or even earlier. In that case it is likely that land will be discovered, which will certainly diminish the dangers of the pack. Wilczek Land may extend for a great distance to the east. The water to the east and west of the most northern point of Siberia is deeper than that directly to the north, which seems to indicate the existence of land north of Cape Chelyuskin, and it is not unlikely that the *Fram* will have fallen in with it. In that case Nansen will doubtless seek its northern limit, and thence endeavor to get into the northerly drift. Under any circumstances, he is sure to accomplish a great deal of valuable scien-

tific work, and to make important discoveries. Of that we may be quite confident; and I am glad to think that Nansen concurs in the maxim of our council, that the principal aim of Arctic voyages should be to explore the unknown regions, and not merely to reach the Pole. Lieutenant Weyprecht writes even more strongly. "The key to many secrets of nature," he says, "the search for which has now been carried on for centuries, is certainly to be sought for near the poles. But as long as polar expeditions are looked upon merely as a sort of international steeplechase, and their main object is to exceed by a few miles the latitude reached by a predecessor, those mysteries will remain unsolved."

The scene of Weyprecht's scientific observations, and of Payer's interesting and ably conducted sledge journey, was Franz Josef Land, which is certainly the most promising starting point for further discovery. This land, discovered by the Austrian expedition in 1872, consists of an archipelago, the southern shores of which are as far north as 80° , while the most northern land seen is in 83° . It will be remembered that Franz Josef Land consists, besides smaller islands, of two masses of land of sufficient extent to bear discharging glaciers sending forth flat-topped icebergs, which apparently drift northward. Between these two masses, called Zichy and Wilczek lands, is the channel named Austria Sound, which was explored for a considerable distance by Payer in the months of March and April, by means of sledges drawn by men, assisted by three dogs. All the low islands, as well as the main masses of land, were found to be covered by glacial caps. The remarkable fact connected with this journey is that from Payer's farthest point in $82^{\circ} 5'$ north a water sky made its appearance in the north, the temperature rose, and the rocks were covered with thousands of auks and guillemots. From a height Payer looked down on a dark sheet of open water dotted with icebergs. On April 12 the thermometer was at 54° F. These phenomena so early in the year are most exceptional, and point to an abnormal condition of things, the causes of which it would be of the utmost importance to discover. Possibly they betoken the navigability of the Polar Sea in this direction at certain seasons, although it is true that Payer's open water was only a "polynia," and was surrounded by old ice. In 1880 Mr. Leigh Smith, in the *Eira*, reached the southern shore of Franz Josef Land, and succeeded in rounding the western headland, whence the land trended in a northwesterly direction.

Judging from the birds and open water in 82° north as early as the month of April, and from the success of Mr. Leigh Smith's voyage in 1880, it was considered by all who were capable, from their Arctic experience, of forming a judgment that the proper way to explore the northern part of the Franz Josef Archipelago would be by dispatching a well-equipped vessel along the western coast. It was the maxim of the Baffin Bay whalers to "stick to the land floe," and to this Sherard

Osborn added, "Stick to the western shore." I strongly advocated the dispatch of such an expedition at a meeting of this society on December 9, 1878, and my views were indorsed by several high Arctic authorities. A vessel well handled would certainly reach the threshold of the unknown, and would probably establish a base on the west shore of King Oscar or of Petermann lands, whence extensive and most important discoveries would be made in the spring. This, no doubt, is the most promising way of attempting the exploration of one of the most important sections of the unknown polar region, and I believe that it will be undertaken the next time the British people wake up from their lethargy and become alive to the national importance of Arctic work. This happens about every thirty years.

Meanwhile we welcome the enterprise of Mr. Harmsworth and Mr. F. G. Jackson, which is directed toward the Austria Sound of Payer. It is highly to the credit of Mr. Harmsworth that he should have determined to provide the funds for a laudable geographical undertaking. It reminds one of the patriotic munificence of the merchant princes of old, and of Sir Felix Booth in more recent times. Mr. Jackson has made a voyage in a whaler, and last year he went out with Captain Wiggins to Waigats Island, where he was landed. He then made an excursion around the island with some Samoyeds, returning by Archangel; these sledge journeys being undertaken in order that he might acquire experience for his future work. His plan is to be landed at Eira Harbor, or at some other convenient point on the southern shore of the Franz Josef Archipelago. For this purpose a whaler named the *Windward* has been purchased. She will land the party of six men, and return without wintering. A house, brought out in pieces, will be erected, and the explorers will pass the winter in it in order to be ready for a spring journey up Austria Sound in the footsteps of Payer. The chief drawback to the plan is that so much of the traveling will be over old ground already well explored by the Austrian expedition; so that the base of operations will be at least 160, and if at Eira Harbor nearer 200, miles from the point reached by Payer, where Mr. Jackson's work will commence. It does not appear how a second winter quarters can be established, with a sufficient stock of provisions, at the farthest point reached. It will therefore be necessary to return to the original base of operations, and to start again over all the same ground, in the second spring. A well-considered system of depots would render this second journey more rapid if the explorers maintain their health, and with a good team of dogs much ground might be covered. The most fortunate thing that could happen would be to find Austria Sound open, so that the *Windward* or a steam pinnace could convey the explorers northward to within a shorter distance of their work. Austria Sound is not the route I should have recommended for reaching Petermann Land, but, with wise management and under favorable conditions of ice and weather,

a good measure of success is quite possible. The council is desirous of giving Mr. Jackson all the encouragement and assistance in its power, and we heartily wish him all the success that is attainable with the means at his disposal.

Westward the archipelago of Spitzbergen ends in the parallel where that of Franz Josef commences. It has long been a favorite idea with inexperienced theorists, that the pole might be reached by a ship shaping a northern course through the ice to the north of Spitzbergen. This idea transgresses the best established of our Arctic canons, which is never to enter the drifting pack away from land. But it occurred to Sir Edward Parry that, although the impracticability of sailing to the pole by the Spitzbergen route was sufficiently proved, the same object might be attained by traveling with sledges over the ice. Parry undertook this feat in 1827 with two flat-bottomed boats 20 feet long, with runners on each side of the keels shod with metal, so that the boat entirely rested on the runners when on the ice, and became a sledge. They started with seventy-one days' provisions, and on June 23 the boats were hauled on the ice in $81^{\circ} 13'$ north. The weight of each boat with provisions was 3,753 pounds, or 268 pounds per man, there being twelve men and two officers for each boat. The ice floes were found to be of small extent and intersected by high ridges of hummocks, the snow was soft and heavy, and there was much water lodged on the floes; but the southerly drift exceeded 4 miles a day. The advance north under such circumstances was hopeless, and Parry resolved to retrace his steps on July 23, when he was in $82^{\circ} 45'$ north. From this point there was a strong yellow ice blink overspreading the northern horizon and showing that the polar pack extended far to the northward. Parry's great mistake was in starting so late in the year. He ought to have been at least two months earlier. The daily allowance of food was insufficient, and the weight to be dragged, of 268 pounds per man, was far too great.

Undoubtedly, if these errors were avoided, a much farther advance to the northward might be made under favorable circumstances. The object of such an expedition would be to get farther north than anybody else—"to beat the best record"—a motive which was so earnestly deprecated by Lieutenant Weyprecht as the bane of good Arctic work. Still, it is a sporting thing to attempt, and as those who are engaged in it will acquire valuable experience in the ice, it deserves every encouragement. Mr. Walter Wellman, a journalist of Washington City, with funds amounting to £4,000, has undertaken to make a renewed attempt to attain a very high latitude north of Spitzbergen, and has already started on his adventurous undertaking, with a few carefully chosen assistants. He is a capable and resolute man, and a thoroughly well-planned effort will be made under his auspices. He will land on Danes Island, near the northeast angle of Spitzbergen, in the present month. Thence he will push northward in aluminium boats of a new

design, constructed at Baltimore, and weighing only 450 pounds each. The boats are 18 feet long, 6 in beam, and 2 feet deep amidships, and are intended for a crew of nineteen men. They contain no frames, the gunwale, thwarts, knee braces, and water-tight compartments at either end giving the necessary rigidity; but too much rigidity is undesirable, elasticity serving to cushion the blows of the ice and to transmit the force of the concussion through the whole structure. The keel is a plate of aluminium, and the plates are riveted together clinker fashion, and are only a tenth of an inch thick. Two ash runners are fitted on the boat's bottom, so as to convert it into a sledge, and a sheet of aluminium is riveted to the outer sides of both, so as to form a broad surface for running on the snow or ice. It is doubtful how this kind of runner will work, but the lightness of the boats will be an incalculable advantage, and Mr. Wellman ought to advance far beyond Parry, especially if the dogs prove to be of use. If there are islands beyond 83° north on the Spitzbergen meridians, and he is able to explore them, his expedition will be of great service to geography; but if not, very little benefit can be derived from a journey over the ice floes in Parry's footsteps.

The enterprise of Lieut. Robert E. Peary in northern Greenland is of the greatest geographical importance. It is designed to solve the question of the insularity of Greenland, one of the oldest that remains for solution, and not the least interesting. It is a great achievement to put the finishing touch to the long tale of heroism and constancy which relates the discovery of the outline of that vast glacier-bearing island. The romantic story of the Norsemen is succeeded by the splendid work of Davis and Baffin, followed by the voyages of Ross, Inglefield, Kane, Hayes, Hall, and Nares, and by the sledge journeys of Beaumont and Lockwood. These dauntless explorers completed what we know of the western side. On the east side the boat journeys of Graah, Holm, and Ryder have been connected with the discoveries of Scoresby and Clavering, and the German expedition of Koldewey named the most northern point they saw on the east coast after Prince Bismarck. It is Peary's noble ambition to connect Cape Bismarck with the farthest point reached by Lockwood; and he resolved to make the attempt from the western side by one of the most remarkable, if not the most remarkable, journeys ever made over an unbroken glacier.

Peary is a native of Maine, aged about 40, and an engineer in the United States Navy. He is a man who appears to be cut out for such work, combining forethought and prudence in planning his operations with great skill and the most undaunted resolution in carrying them into execution. His first expedition in 1891-92 was tentative, but it was a great success. He went out in the whaler *Kite*, and was landed in McCormick Bay in 77° 43' north, on the northern side of Inglefield Gulf (the Whale Sound of Baffin), the party consisting of seven persons, including Mrs. Peary. Peary had his leg broken during the voyage,

and was in a helpless condition when he was landed. His complete recovery was due in no small degree to the unremitting care of his wife. We must all feel the greatest admiration for the devotion of this lady, who braved the rigors of the Arctic regions, and was not only the life and soul of the winter quarters, but was throughout a most useful member of the expedition. The house was conceived and erected in a workmanlike manner, and in all Peary's operations there is the evidence of capacity and skill. He studied the questions of clothing, of provisions, and of sledge weights with great care and good working results. He also tried the different kinds of sledges before finally deciding that McClintock's pattern was the best. His journey occupied eighty-three days, from May 15 to August 6. The start was made with four sledges, four men, and dog teams, the depot sledge with two men returning from Humboldt Glacier. Peary, with his companion Astrup, proceeded with three sledges and the dogs, and was traveling forty-eight days before reaching the northern edge of the great glacier, the actual marching time being forty days, and the distance covered 650 miles, or $16\frac{1}{2}$ miles a day. They had no depots, and all the food was carried on the sledges, except two musk oxen and a calf shot on the northeast coast. The return journey of 600 miles occupied only twenty-eight days. Peary started with twenty dogs, reached his extreme point with fifteen, and returned with five. A good Eskimo dog will drag 100 pounds at the rate of 10 to 20 miles a day.

It was found that in approaching the edge of the glacier toward the north the travelers got involved among numerous crevasses, causing endless trouble to circumvent them, so that it was advisable to keep on the plateau of the glacier. He reached the northeast coast of Greenland at a place which he named Independence Bay; and from the height called Navy Cliff he obtained an extensive view of lands to the northward with no ice caps, and therefore probably islands.

Peary returned home in September, 1892, and earned sufficient funds for his second expedition by means of lectures and articles for the press. He had made a very thorough reconnoissance in 1891-92, by which he had tested all his equipments and got well acquainted with the nature of the country. He now resolved to proceed upon his final effort to complete the work he had set himself to achieve. He sailed in July, 1893, with a party numbering fourteen, including Mrs. Peary and her maid, with the intention of erecting the house in Bowdoin Bay, on the shores of Whale Sound. Peary's intention was to commence sledging operations in March, two months earlier than in 1892, and to make for Independence Bay by a route between the previous outward and return routes, so as to avoid the crevasses of the northwest and the fogs of the higher plateau. Eight Mexican donkeys have been taken as an experiment and fitted with snowshoes, as has been done with horses in Alaska. On reaching Independence Bay it is intended to send one party southward to Cape Bismarck and the other north-

ward to connect with Lockwood's farthest. But it appears that Peary is also bitten with the "beating the best record" mania, and thinks of pushing due north with the object of reaching the highest latitude attainable. It is to be hoped that this fancy will not be allowed to mar the real work of the expedition, which is to complete the outline of Greenland.

Mr. Peary is again accompanied by the hardy young Norwegian, Eivind Astrup, who was with him throughout his first journey.

The *Falcon* steamer is to sail next June and proceed to Peary's quarters in Whale Sound; but it is not certain whether he will return or resolve to continue his work during another year. His decision will probably depend on the extent of his explorations this year and on the amount of work he will have completed. We shall all look out for the particulars of his achievement with the deepest interest. For my own part, I look upon Peary as an ideal explorer. He chose one of the greatest and oldest of the geographical problems that remain to be solved, and he set to work as if he really intended to find the solution. Every detail of equipment was thoughtfully considered, gear was tried and tested before being used, a brilliant preliminary journey over the inland ice was made. All was done in the workmanlike style of a true discoverer. I therefore believe that Peary will succeed. I am sure that he deserves success.

I now come to the saddest part of my Arctic story. Next to northern Greenland, the most interesting part of the unknown region is the land on the western side of the north part of Baffin Bay, between Smith Sound and Jones Sound, and extending along the north side of Jones Sound to the west and north. It was named Ellesmere Land by Sir Edward Inglefield, who saw it from the deck of the *Isabella* in 1852. It is called Uming-mak (the land of the musk oxen) by the Eskimos. No one, so far as we know, has ever landed between Jones Sound and Smith Sound. But in August, 1851, the *Intrepid* and *Pioneer* went up Jones Sound for 40 miles, and Sherard Osborn gave a very interesting account of the cruise. Two of his officers landed on a small island at their farthest point, and found Eskimo remains, abundance of vegetation, and some reindeer antlers. In the following year Sir E. Inglefield entered the sound in bad weather, but did not effect a landing. This is all we know of Ellesmere Land south of Smith Sound.

The absence of knowledge respecting Ellesmere Land, and the comparative ease with which its eastern coast may be reached, induced an accomplished and adventurous young Swede, named Alfred Björling, to turn his attention to its exploration. His original plan was to proceed up Baffin Bay in a St. John's whaler, and to land as near as possible to Cape Sabine, within Smith Sound. During the next ten weeks he proposed to travel by boat and sledge through Hayes Sound toward the Victoria Archipelago, or North Kent. Björling is a botanist, and he believed that this region, while quite unknown geograph-

ically, would offer an exceptionally rich field for botanical researches, because its position makes it a connecting link between Greenland and Arctic America. His return journey was to have been directed either to Cape Warrender or along the east coast of Ellesmere Land to a spot where he could be picked up by a returning whaler.

This was a well-conceived plan, provided that proper arrangements were made with a whaler. There is no reason why geographers and naturalists should not spend ten weeks of the summer on such useful work, if properly equipped, and if a vessel will engage to call for them before returning home, at a prearranged spot. Björling received a grant from the Vega exploring fund and the proceeds of subscriptions, and left Stockholm in the spring of 1892.

Alfred Björling was born in 1871, and always cherished an ardent desire to make discoveries in the Arctic regions. In order to prepare himself for this work, he wandered through extensive tracts of the mountainous region of northern Scandinavia during 1887 and 1888, and he was the first to ascend the peak of Kebnekaise, the highest mountain in Sweden. In the summer of 1890 he accompanied a Swedish expedition to the west coast of Spitzbergen, made valuable collections of Arctic plants, and assisted in the hydrographical and topographical work. In the following year Björling went to Greenland in one of the Danish vessels, and from Upernavik he made a voyage with Eskimos in an umiak along the coast of Melville Bay inshore, as far northward as the Devil's Thumb. He returned to Sweden in the autumn.

Björling was only 21 years of age when he became the leader of the Ellesmere Land expedition. His companion, Evald Gustaf Kallstenius, was born in 1868, and since 1886 he had been a student of zoology at the University of Upsala, but he had not been in the Arctic regions before. The two young explorers did not succeed in making an arrangement with a whaler at St. Johns, Newfoundland, and, after much difficulty, Björling bought a small schooner of 37 tons, called the *Ripple*, for \$650. He succeeded in persuading three men to form a crew, with himself and his companion. A Dane named Karl Kann entered as skipper, an Englishman named Gilbert Dunn formed the crew, and the cook was a North Briton, named Herbert Macdonald. Owing to the long delay in getting the *Ripple* ready for sea, Cape Walsingham was not sighted until July 24, and on the 28th she arrived at Godhavn, having behaved very well in the ice of Dans Strait. Björling purchased at Godhavn a fowling piece and a rifle with ammunition, some provisions and clothes, and a boat. He was provided, before leaving Stockholm, with scientific instruments. He left Godhavn on August 3.

Some anxiety for the gallant young Swedes began to be felt when Lieutenant Peary started on his second expedition last July, and he was requested to obtain information respecting their proceedings, and if necessary to go to their relief. In November, 1893, the whaler *Aurora* returned from Baffin Bay with a report of the loss of the *Ripple*. On

June 17, 1893, the *Aurora* was in the north water of Baffin Bay, and sighted a wreck on the most southeastern of the Cary Islands. A boat was sent on shore, and the schooner *Ripple* was found driven on the beach, and almost buried in ice. Not far from the wreck there was a heap of stones covering the dead body of a man, probably the Dane, Karl Kann. Close by there was a large cairn, in which a tin pot was found, containing open letters from Björling. It appears that he reached the Cary Islands on August 16, 1892, so that the voyage from Godhavn occupied a fortnight, and he crossed Melville Bay in a single day. On the following day the *Ripple* was driven on shore while they were engaged in taking provisions on board from the depot of Sir George Nares, apparently with the intention of wintering on the coast of Ellesmere Land. Up to this time all appears to have gone well, but the unforeseen calamity of the loss of their vessel must have destroyed all their anticipations of success. They were obliged to remain several weeks at the Cary Islands owing to bad weather; but eventually Björling⁴ resolved to undertake the voyage to Cape Clarence or Cape Faraday on the western side of Baffin Bay, in an open boat, buoyed with the hope of meeting Eskimos. In his letter he said that he hoped a whaler would visit the Cary Islands in the following summer, and that he would consequently try to return with his people by July 1, 1893. He added, addressing the captain of the supposed whaler, "I shall be very much obliged to you if you would go to Clarence Head (50 miles off), where I shall leave in a cairn information relative to our fate during the winter. Our provisions, if I can not find Eskimos, will not last beyond January 1. We are now five men, of whom one is dying." The date is October 12, 1892. The *Aurora* found that Clarence Head could not be approached in June within 20 miles, and she made no further attempt to comply with Björling's request later in the season.

The conduct of the two heroic lads was admirable throughout. There was the usual risk and danger of Arctic work in their project, but no more, before they lost their vessel. Their message is most touching. Not a sign of fear, not a word of complaint, but the simple words of brave men, most pathetic in their simplicity. There is one circumstance which is worthy of notice. The eastern side of Baffin Bay is within 20 miles of the Cary Islands, and friendly Eskimos are well known to have settlements there. Yet Björling and Kallstenius chose to go in an open boat to the northern side, which is 50 miles off, and where the presence of Eskimos was uncertain. There can only be one reason. The western side was Ellesmere Land, the appointed place of their work, and even in their dire extremity they resolved to go whither duty pointed. It was not foolhardiness, nor thoughtless enthusiasm, but a sense of duty, which pointed the way. One of the most experienced of our Arctic officers thus wrote on the subject: "It is evident that Björling must have had good sterling qualities, to induce two Englishmen to

throw in their lot with him. As they could have left him at the Danish settlements, it would appear as if he was a born leader, and might have become a great man if he had had patience to wait until he had gained experience. However, very little would be done in the world without the enthusiasm of youth. The experience of age can not be combined with it, so that the latter will never have all the say. Yet a good many victims is the result, and in this case that result is much to be deplored."

When the news brought back by the *Aurora* reached Sweden there was an idea of a relief expedition. But in the end of 1893 a circular from Mr. Robert Stein, who is connected with the United States Geological Survey Office at Washington, announced his scheme for exploring the whole polar area, and for reaching the pole by a system of gradual approaches. He proposed to establish a station, to serve as a permanent base of operations, at Cape Tennyson, on the northern shore of Jones Sound. Here he intended to place fifteen men always provisioned for two years. Thence he would push forward secondary stations into the unknown area, each with five men. Mr. Stein intended to form the first station in Jones Sound, and he also undertook to conduct a search for the relief of the missing Swedish explorers. Baron Nordenskiöld promised a subscription of \$2,000 in consequence, and the importance of the Stein expedition was very much enhanced. Funds were, however, much needed. I therefore made an appeal for subscriptions in the *Times*, on April 7. But immediately afterwards I was amazed to hear that Mr. Stein had postponed his expedition for another year. ❧

I nevertheless opened a "Björling relief fund," and subscriptions were received at the society's rooms with the object of assisting Baron Nordenskiöld in any measures he might adopt for the relief of his gallant young countrymen. At our meeting on April 9 I made an urgent appeal to the fellows for subscriptions. Several came forward, including many Arctic officers, who are never deaf to such appeals, and I am happy to say that I have been enabled to forward the sum of £84 10s. to Baron Nordenskiöld at Stockholm. But the abandonment of his design by Mr. Stein has left but little time for other measures to be matured. Mr. Nilson has been sent out in the whaler *Eclipse* from Dundee in the hope of reaching Clarence Head; and Dr. Ohlin, with the same object, has proceeded to St. Johns, Newfoundland, whence he is to go to Baffin Bay in June, on board the *Falcon*, the steamer that is to bring back Peary's party.

These arrangements may suffice if the only object is to ascertain the fate of the lost explorers, but if their relief and rescue are intended, it is necessary to dispatch a special steamer for the purpose. A vessel engaged in other work, such as whale fishing or attendance on the Peary expedition, might be induced to touch at Clarence Head, but she might not be able to reach the shore during the time she could allow

for that object, and she could not wait beyond a certain time. But a vessel sent for the relief service alone would wait for opportunities, and make a thorough and efficient search. It therefore becomes necessary to consider whether the sad duty of ascertaining the fate of those gallant youths, and their companions, alone remains; or whether there is any hope of their having survived.

If Björling fell in with a party of friendly Eskimos, there is no reason why he and his companions should not have survived through two winters, if animal life were abundant around their encampment. This, therefore, is the question, whether there is a reasonable probability of Eskimos being met with near Clarence Head. Many years ago, when I was serving in the Arctic regions, it was assumed that the western side of Baffin Bay, north of Lancaster Sound, was uninhabited. In 1851 Sherard Osborn found vestiges of Eskimos in Jones Sound, and when I landed near Cape Warrender, with Sir Erasmus Ommanney, in the previous year, I came upon several stone graves. It was supposed that these remains were very ancient, possibly representing the original migration of the people now settled in northern Greenland. But in 1853 Sir Edward Inglefield found a party of Eskimos in the very harbor where I had landed in 1850, proving that, though wanderers had left their vestiges in the remote past, people of the same race still frequented the region in question. Their remains were also found by the expedition of Sir George Nares on the western side of Smith Sound. Captain Buddington, who commanded the *Polaris* expedition after Hall's death, met with Eskimos at Port Foulke who had certainly wandered round the whole northwestern side of Baffin Bay from Lancaster Sound. The information collected by Dr. Franz Boas from the Eskimos in Baffin Land is more detailed. They occasionally cross Lancaster Sound from Admiralty Inlet to the neighborhood of Cape Warrender, but not often, because they have no boats or canoes, and the sound is seldom frozen over. On reaching the coast of North Devon, they go across the land with their sledges, and in four days reach the coast of Jones Sound, at a place where a long narrow promontory juts out toward Ellesmere Land called Nedlung. The promontory becomes an island at high tide, and there is a channel of open water throughout the winter. In the spring this becomes a large open space clear of ice, frequented by enormous quantities of seals. Farther north, on the coast of Ellesmere Land, which abounds in reindeer and musk oxen, there was another small colony of Eskimos. These facts are certainly encouraging. Björling would not have landed at Clarence Head until the middle of October, which is against his chances; but on the other hand, he would not then be more than 10 or 12 miles from the Eskimos, if they were still in Ellesmere Land.

On the whole there is ground for hope; and it is discreditable to abandon the unfortunate explorers to their fate. The two Swedish lads are the stuff of which heroes are made, and every civilized people

must be interested in their rescue. British subjects are with them, whom we are bound to befriend. Most certainly a special steamer ought to be dispatched for their relief. But the time is very short. Hundreds would gladly subscribe their mites, and the funds could have been raised if there had been a year or so to collect it in. But there is barely a month. The only hope was that a few very rich people might be induced to come forward and save the credit of their country. I felt very strongly that a vessel ought to be dispatched, and I therefore made every effort, and left no stone unturned to obtain the necessary funds. But I am sorry to say that I was not successful. Our sole hope is now in the efforts of Mr. Nilson on board the whaler *Eclipse*, and of those in the *Falcon*. The *Falcon* will sail from St. Johns early in July, under the command of Mr. Henry G. Bryant, the recording secretary of the Geographical Club of Philadelphia. It is hoped that Peary's headquarters at Bowdoin Bay will be reached by July 25, but as Peary and his inland party will not then have returned, the *Falcon* will have about a month to spare for an independent cruise, before embarking the Peary expedition in the first days of September. In a letter I have just received from Mr. Bryant he assures me that he takes a deep interest in the fate of the young Swedes, and his plan includes a landing at Clarence Head and other points, and a search for records left by Björling and Kallstenius. Mr. Bryant also contemplates the exploration of the channel leading west from Jones Sound. I have only just received these particulars from Mr. Bryant, which place the chances of relief for the missing explorers in a brighter light. I heartily wish all possible success to the Peary auxiliary expedition and its gallant leader. Dr. F. A. Cooke, who was with Peary in 1891-92, proposes to go up Baffin Bay with a party of excursionists on board the steamer *Newfoundland*, owned and commanded by Capt. J. A. Farquhar, leaving New York on June 25, and intending to return on September 10. Perhaps Captain Farquhar may be induced to visit Clarence Head.

I must take this opportunity of expressing my thanks to Mr. Trevor-Battye for his enthusiastic efforts to promote the dispatch of a relief vessel; as well as to Captain Haserick and to Mr. William Pine Coffin, who both felt deeply the shame of leaving the gallant explorers to their fate, and were ready to help, and did help, with the utmost zeal and ardor in so good a cause. Mr. Trevor-Battye, failing the relief expedition, is about to start in the steamer *Saxon*, of 150 tons, in company with Mr. Mervyn Powys, to make a thorough ornithological as well as geographical examination of the little-known Kolguev Island, I believe under Lord Lilford's auspices. Mr. Trevor-Battye has studied under Mr. Coles, and the council has granted him the loan of instruments necessary for navigation. To my mind Mr. Trevor-Battye is cut out for a successful explorer. A hunter of elk on ski in Sweden, of moose and wapiti in the Rockies, a salmon fisherman in the Far West, of powerful physique and great powers of endurance, he is also a naturalist,

an artist, and an accomplished author. It is to the training and encouragement of such men that the society must look, if we are to have great travelers in the future to advance our science and to do honor to our country.

Circumstances have obliged us to pay very special attention to Arctic questions in the past year; but the great meeting which assembled to hear Dr. Murray's paper, on the 27th of last November, is our witness that the Antarctic regions have not been forgotten. All the scientific societies in the United Kingdom and on the Continent are now of one mind as to the importance of Antarctic exploration, and they are convinced that it must be a Government undertaking. It is half a century since Sir James Ross returned, and the time has come for renewing the work which he commenced so admirably. The arguments of Dr. Murray must have brought conviction to the minds of all who had not previously studied the subject. An expedition is necessary for magnetic observations alone. Professor Neumayer wrote to Dr. Murray that "it is certain that without an examination and a survey of the magnetic properties of the Antarctic regions, it is utterly hopeless to strive, with prospects of success, at the advancement of the theory of the earth's magnetism." Dr. Murray thus summed up the work of a modern Antarctic expedition: "To determine the nature and extent of the Antarctic continent, to penetrate into the interior, to ascertain the depth and nature of the ice cap, to observe the character of the underlying rocks and their fossils, to take magnetic and meteorological observations both at sea and on land, to observe the temperature of the ocean at all depths and seasons of the year, to take pendulum observations on land, to bore through the deposits on the floor of the ocean at certain points to ascertain the condition of the deeper layers, and to sound, trawl, dredge, and study the character and distribution of marine organisms." All these observations are earnestly demanded by the science of our day for many purposes. Science demands a steady, continuous, laborious, and systematic exploration of the whole southern region with all the appliances of the modern investigator.

Enlightened by the exhaustive and most interesting paper of Dr. Murray, and encouraged alike by his enthusiasm and by the sound sense of his remarks in favor of the renewal of Antarctic exploration, our council appointed a committee with instructions to report upon the best means of achieving the objects set forth by Dr. Murray. Our Antarctic committee consisted of Sir Joseph Hooker, one of the two survivors of Sir James Ross's expedition; of Sir George Nares, the only living naval captain who has navigated the Antarctic Ocean; of Captain Wharton, the hydrographer; of Admiral Sir Erasmus Ommanney, who has long been a warm advocate of such an enterprise; of Admiral Sir R. Vesey Hamilton, one of our best Arctic authorities, who has also written on the subject of Antarctic navigation of Dr. Murray and myself.

The committee in its report enumerated the scientific results of Antarctic research, especially dwelling on the necessity for an accurate study of terrestrial magnetism. The experiences of early navigators in approaching the pack edge are then reviewed, and it is shown that Sir James Ross alone boldly entered it, with a view to passing through it, on two occasions, with success. In January, 1841, he forced his way through it in four days, reaching an open sea, discovering Victoria Land, and penetrating to the seventy-eighth parallel. On the second occasion he entered a pack several hundreds of miles in width, and he was forty-two days getting through, but he again succeeded. In 1843, on his third attempt, it was too late in the season when he entered the pack, and the young ice was forming rapidly. If it had been December instead of March he might have effected more. The committee then contrasts the conditions of navigation in the Arctic and Antarctic regions. In the north there are fields of ice of vast extent, often fixed for months in one place by intricate channels. The danger of long detention, arising from being beset in such ice, is not so serious in the Antarctic regions. But there are other dangers which are equally formidable. In gales of wind and in fogs, and even in calms, sailing vessels are in much danger, when involved in the pack, from the swell caused by heavy gales, and when it is impossible to avoid collisions with huge masses of ice. On such occasions a sailing vessel is helpless.

But as screw steamers would, of course, be employed on any new Antarctic expedition, these dangers would be very much reduced and a great saving of time would be effected. Calms occur, and there are often adverse winds when there is clear weather. At such times sailing vessels would be beating up 20 miles while a steamer might make 100. With steam it might be possible to do in one season all that which, in the cases of Wilkes and Ross, occupied three. A steamer would be in little danger from bergs except in fogs, and in heavy gales she could lie to in safety under their lee, instead of drifting at the mercy of wind and waves. She would also be better able than a sailing vessel to double the pack. The weak point of a steamer in the pack would be during a gale of wind. She might avoid collision with the ice better than a sailing vessel, but not altogether. But specially adapted screw steamers would no doubt facilitate Antarctic navigation, and remove many of the difficulties which had to be encountered by sailing vessels.

Having fully considered the exigencies of Antarctic navigation, the committee recommend that the expedition should consist of two vessels as well strengthened against the ice as were the *Erebus* and *Terror*, fitted with steam power, and specially protected aft. It is indispensable that officers and crews should be under naval discipline, and a full commission of three years would be necessary for the performance of the work. Apart from the valuable scientific results of an Antarctic expedition, the committee dwell upon the excellent effect that all such

undertakings, in which our country has been prominent, have invariably had on the navy, by maintaining the spirit of enterprise.

Having been adopted by our council, the report of our Antarctic committee, together with Dr. Murray's paper, was transmitted to the Royal Society, with an urgent request that that learned body would take the subject of the renewal of Antarctic discovery into serious consideration, with a view to its being brought before Her Majesty's Government in a memorial presented by the Royal Society, with the cordial assent of every scientific body in the United Kingdom. I understand that a committee has been appointed by the council of the Royal Society, and that the important question is receiving mature and careful consideration. The fellows may rest assured that no efforts on the part of our council will be wanting, and that the duty of promoting the renewal of Antarctic exploration will be borne in mind. If men of science are unanimous, both as to the importance of the work and the best method of executing it, and if they are backed by enlightened public opinion, the Admiralty will be only too glad to take the subject into favorable consideration, and difficulties raised by the treasury will be overcome. But unanimity and the support of public opinion are absolutely essential to success.

I have devoted the body of my address to work within the polar regions. I will not, however, omit to refer to the labors of others in regions which, through their exertions, may become the main subjects of future addresses. You have recently heard an account of the results of the journey of Mr. and Mrs. Littledale, which are in many respects remarkable. It was a very hazardous adventure; it covered several hundreds of miles of entirely new ground, and very careful observations were taken all along the route, which have been embodied in a valuable map. The additions made by Mr. Littledale to our knowledge of the famous route to China followed by Marco Polo are of the first importance.

Of no less interest is the journey into the Hadramaut Valley accomplished by Mr. and Mrs. Bent, an account of which was presented to us a week ago. They were accompanied by an excellent surveyor, deputed by the government of India, and by a botanist from Kew, while their own archaeological notes, photographs, and sketches are of exceptional value. These experienced travelers were so interested in the strange and almost unknown country of Hadramaut that they hope to return to continue their explorations in Arabia.

In Africa there has been, and continues to be, abundant activity, as the monthly pages of our journal have shown. We have already heard a very full account of Dr. Gregory's expedition to Mount Kenia, and we hope shortly to have full details of the expedition into new country north of the Tana River, led by Mr. Astor Chanler, accompanied by Lieutenant von Höhmel. Mr. Scott Elliot is actually exploring the Ruwenzori region, and we have helped to equip other young African

travelers who hope to open up new ground. Mr. Coryndon, a friend of Mr. Selous, has already started for the country lying between the west shore of Lake Tanganyika and the Kongo, where he will remain for at least a year. Dr. Donaldson Smith, a young American gentleman, leaves in a few days for Somali Land, whence he will push southward to Lake Rudolf, thus connecting the discoveries of Count Teleki with those that have been made farther north.

How valuable a service is being performed by our indefatigable map curator, Mr. Coles, in giving instruction to intending explorers, is shown by the work that has been done by his pupils within the last two years. In Africa Major Leveson and Mr. F. A. Lamb have done surveying work on the Anglo-German boundary commission, Dr. J. W. Gregory has surveyed and mapped the Mount Kenia region, Mr. Teed is now surveying in the territory of the Royal Niger Company, Captain Gallwey has been at work in the Oil Rivers Protectorate. Lieut. S. Vandeleur, of the Scots Guards, has made an exceedingly well-executed route survey in Somali Land, checked by observations for latitude. Mr. G. F. Scott Elliot is at work in the Ruwenzori region. In Asia Mr. Conway has made surveys and a map of the Karakoram glaciers, and Mr. Littledale has done valuable work in central Asia and on the Hoang-Ho. In America Mr. C. W. Anderson has been working in British Guiana, and our traveling students, Mr. G. B. Grundy and Mr. Cozens Hardy, have surveyed, one the battlefield of Platea, the other a part of Montenegro.

I must not omit to refer to the admirable work accomplished by our librarian, Dr. Mill, in the survey of the English lakes, in which he has opened up a hitherto unknown part of our country, although a part which is under water. At one of our meetings in June Dr. Mill will explain to us some of the more interesting results of his limnological investigations.

On several occasions during the session I have regretted the absence of my illustrious predecessor, Sir Henry Rawlinson, on whom the mantle of Sir Roderick fell in 1871. I especially missed him on the occasion of Colonel Sawyer's paper on the Bakhtiari country being read; and, indeed, I had a faint hope that he might once more appear among us on that occasion, to brighten the discussion by his profound knowledge and unrivaled powers of exposition. Sir Henry was one of the best of our presidents from every point of view, and I do not know his equal in giving life to an apparently dull subject, and in awakening an interest in geographical details by enriching them from the abundant stores of his historical memory. I shall never forget the rapt attention with which the audience listened to his account of the route taken by the gypsies on their way toward Europe from the valley of the Indus. He is unrivaled in showing the dependence of history on a knowledge of geography, and though he is often missed by those who

remember the time when he presided here, he can never be replaced. I still indulge the hope of seeing him among us before the session is over.

In conclusion, it is my duty to announce the retirement of Mr. Douglas Freshfield from the post of secretary, and that he has declined to allow himself to be put in nomination as a member of the new council. Mr. Freshfield was my colleague from 1881 to 1888, and for the last six years he has been senior secretary of the society. A renowned climber and Alpine explorer, he now holds the honorable post of president of the Alpine Club. But he is not a mere climber. He is well versed in the historical literature of the Alps, as is shown by his papers on the Alpine notes of Leonardo da Vinci in 1884, and on the pass of Hannibal in 1886. He was also the author of sketches in the mountains of Ticino. Having exhausted the Alps, Mr. Freshfield turned to the Caucasus, and our Proceedings have been enriched by four of his papers describing with a master hand the physical aspects of that little-known range, and his own well-planned and successful ascents. He also published a work on Central Caucasus and Bashan. Mr. Freshfield gave up much of his time to the society, and was indefatigable in his supervision of the work of the departments, and initiated our large and valuable collection of photographs. He introduced the use of photographic slides at our evening meetings. He took a special interest in educational questions, and the society's arrangements with the universities of Oxford and Cambridge owed much to his active and zealous aid. He read a paper of great importance at the British Association meeting of 1866, on "The place of geography in education." In that paper he truly remarked that much of the literature of physical science was rendered unreadable by the absence of the art of letters in its producers. The classics, he added, are the authors and models of the art of clear and condensed expression for European literature. And this reminds me that one of Mr. Freshfield's highest qualifications for the post of our secretary was that he was a classical scholar. How often have I deplored the loss of this qualification through having gone to sea so young! Mr. Freshfield conducted a good deal of correspondence, both private and official, the results of which were very conducive to the best interests of the society. As an example, I may mention his letters to the India office, to which were due the establishment of an excellent understanding with the departments in India, and to our being regularly supplied with geographical information which was previously withheld. He was joint editor of the three latest editions of *Hints to Travellers*, taking the subject of outfit as his own part of the work. For these varied and important services the warm thanks of our council and of the society are justly due to Mr. Freshfield. Although he retires, by his own desire, from any further official connection with the society, he will, I am sure, continue to take a warm interest in our proceedings, and to be an active and zealous, though independent, member of our body.

We have had heavy losses this year from the deaths of distinguished fellows, whose obituaries have appeared in the numbers of our Journal. Among them were several dear friends of my own, and I can not help mentioning how deeply we have all felt the loss of our late foreign secretary, Gen. Sir Beauchamp Walker.

I have to thank Captain Wharton, the hydrographer, for the account which follows of the work that has been done during the year by our naval marine surveyor, to whose hard work navigation and geography owe so much; and Mr. C. E. D. Black for his abstract of the work of the Indian surveys during the past year.

The magnificent work prepared by a commission, under the auspices of the Italian Government, as Italy's contribution toward the celebration of the fourth centenary of Columbus, has just reached me. In the name of the fellows of this society, I have warmly congratulated our brother geographers in Italy on its appearance. A review of the great Colombian work follows this address.



THE PHYSICAL CONDITION OF THE OCEAN.¹

By Capt. W. J. L. WHARTON, R. N., F. R. S.

You will not be surprised if, having called upon an hydrographer to preside over this section, he takes for the subject of his review the sea. Less apparently interesting, by reason of the uniformity of its surface, than the land which raises itself above the level of the waters, and with which the term geography is more generally associated, the ocean has, nevertheless, received much attention of later years. In Great Britain, especially, which has so long rested its position among the nations upon the wealth which our merchant fleets bring to its shores, and upon the facilities which the sea affords for communication with our numerous possessions all over the globe, investigation into the mysteries, whether of its ever-moving surface or of its more hidden depths, has been particularly fascinating. I purpose, therefore, to attempt a brief survey of our present knowledge of its physical condition.

The very bulk of the ocean, as compared with that of the visible land, gives it an importance which is possessed by no other feature on the surface of our planet. Mr. John Murray, after a laborious computation, has shown that its cubical extent is probably about fourteen times that of the dry land. This statement appeals strongly to the imagination, and forms, perhaps, the most powerful argument in favor of the view, steadily gaining ground, that the great oceans have in the main existed in the form in which we now see them since the constituents of the earth settled down into their present condition.

When it is considered that the whole of the dry land would only fill up one third of the Atlantic Ocean, the enormous disproportion of the two great divisions of land and sea becomes very apparent.

The most obvious phenomenon of the ocean is the constant horizontal movement of its surface waters, which in many parts take well-defined directions. These great ocean currents have now been studied for

¹Address to the geographical section of the British Association, Oxford, 1894. Published by the British Association, also printed in the *Geographical Journal*, September, 1894, and in *Nature*, August 16, 1894.

many years, and our knowledge of them is approaching a point beyond which it is doubtful whether we shall ever much advance, except in small details. For though, while indisputably the waters continually move in each great area in generally the same direction, the velocities vary, the limits of the different streams and drifts vary, mainly from the ever-varying force and direction of the winds.

After long hesitation and much argument, I think it may be now safely held that the prime motor of the surface currents is the wind. Not, by any means, the wind that may blow, and even persistently blow, over the portion of water that is moving, more or less rapidly, in any direction, but the great winds which blow generally from the same general quarter over vast areas. These, combined with deflection from the land, settle the main surface circulation.

I do not know if any of my hearers may have seen a very remarkable model, devised by Mr. Clayden, in which water disposed over an area shaped like the Atlantic, and sprinkled over with lycopodium dust to make movement apparent, was subjected to air impelled from various nozzels, representing the mean directions of the permanent winds. It dispelled the last doubt I held on the subject, as not only were the main currents reproduced, but the smaller effects and peculiarities of the Atlantic drifts were produced with surprising accuracy.

There is a small current, long shown on our charts, but which I had always regarded with suspicion. I refer to the stream which, after traveling from the Arctic Ocean southward along the east coast of Greenland, turns sharply round Cape Farewell to the northward into Davis Straits, where it again doubles sharply on itself to the southward. This is exhibited in the model in all its details, and is evidently caused by the pressure of the water forced by the mimic Gulf Stream into the Arctic region, where it has no escape except by this route, and is pressed against the land, round which it turns as soon as it can. This is, no doubt, the explanation of the real current. The very remarkable winter equatorial current, which runs in a narrow belt eastward, just north of the main stream traveling west, was also reproduced with extraordinary fidelity. The winds, however, that are ordinarily considered permanent vary greatly, while in the monsoon areas the reversal of the currents caused by the opposite winds exercise a great influence on the movements of the water far beyond their own limits, and anything like a prediction of the precise direction and rate of an oceanic stream can never be expected. The main facts, however, of the great currents can be most certainly and simply explained in this manner. The trade winds are the prime motors. They cause a surface drift of no great velocity over large areas in the same general direction as that in which they blow. These drifts after meeting and combining their forces eventually impinge on the land. They are diverted and concentrated and increase in speed. They either pour through passages between islands, as into the Caribbean Sea, are pressed up by

the land, and escape by the only outlets possible—as, for example, the Strait of Florida, and form a great ocean current like the Gulf Stream—or, as in the case of the Agulhas current and the powerful stream which runs north along the Zanzibar coast, they are simply pressed up against and diverted by the land, and run along it with increased rapidity. These rapid currents are eventually apparently lost in the oceans, but they in their turn originate movements of a slower character, which on again passing over shallow water or on meeting land develop once more into well-defined currents.

We find an analogous state of things on the western side of the Pacific, where the Japan current is produced in a similar manner. The fact that on all western shores of the great oceans toward which the trade winds blow we find the strongest currents running along the coast, is almost enough of itself to prove the connection between them.

The westerly winds that prevail in higher northern and southern latitudes are next in order in producing great currents. From the shape of the land they in some cases take up and continue the circulation commenced by the trade winds; in others they themselves originate great movements of the water. Compared to the great circulation from this source the effect of differences of temperature or of specific gravity is insignificant, though no doubt they play their part, especially in causing slow under circulation, and in a great degree the vertical mixing of the lower waters. No drop of the ocean, even at its greatest depth, is ever for one moment at rest.

Dealing with minor points, the American officers of the Coast and Geodetic Survey have found after long and patient investigation that the velocity of the Gulf Stream in its initial and most marked part, the Strait of Florida, is greatly affected by the tide, varying as much as one-half its maximum rate during the twenty-four hours. These American investigations are of greatest interest. They have extended over the whole area of the Caribbean Sea and its approaches, the Gulf of Mexico, and the Gulf Stream proper and its vicinity. In no other part of the ocean has observation of this detailed character been carried out, and they throw a great light on oceanic circulation. The *Blake*, the vessel specially fitted for the purpose, has during the several years in which she was employed on this work anchored in over 2,000 fathoms water, or a depth of considerably more than 2 miles, a feat which would a short time ago have been deemed impossible. One great point that has come out very strongly is the continual variation in the strength and direction of the currents and the varying depths to which the surface current extends.

Eastward of the chain of the Windward Islands the general depth of the surface movement may be said to be about 100 fathoms, below which tidal influence is very distinct. There is also a very plain backward flow of water, at depths which vary, caused by the submarine ridge which connects the Windward chain of the West Indian Islands.

These observations also generally support what I have already mentioned: that the velocity of a current depends on the strength of winds, possibly thousands of miles distant, which have given the original impetus to the water, and this, combined with tidal action when the current approaches or runs along a coast, will always cause uncertainty on the resultant velocity.

Dealing for yet another moment with the Gulf Stream, there are two points which have not been much dwelt upon, but which have a great effect on its power of bringing the modifying influence of its warm water as far as our shores. The first is the prevention of its spreading, as it leaves the Strait of Florida, by the pressure of the portion of the equatorial current which, unable to get through the passages between the Windward Islands, is diverted to the north of the Bahamas and bears down on the eastward side of the Gulf Stream proper, compressing it between itself and the cold water flowing southward along the American coast, and at the same time adding to its forces and maintaining its high temperature. The second is that by the time the Gulf Stream has lost its velocity as a current, in about the vicinity of the Bank of Newfoundland, it has arrived in the region of the westerly winds, that is, of winds whose average direction is from west, whose influence, causing a surface drift somewhat comparable to that of the trade winds, bears the water onward to the British islands and Norway. Without these prevailing westerly winds the warm water of the Gulf Stream would never reach these shores.

The depth to which the surface currents extend in other parts is little known. Direct observations on undercurrents have been rare. In the first place, it is not an easy observation to make. Apparatus has generally to be improvised. This has usually consisted of some form of flat surface lowered to the required depth and suspended in the water by a buoy, which presents to the resistance of the upper stratum a very much smaller area than that of the surface below. More perfect machines have been devised, notably that used by the Americans in their West Indian experiments. These, however, are delicate and require so much care and experience in working, and so much time is wanted for such observations, that under the pressure of the more urgent requirements on surface movements in the interests of navigation very little has been done. The *Challenger* made some observations on the depth of the equatorial current in mid-Atlantic, but they were not very conclusive for lack of suitable appliances. They, however, tended to show that below 100 fathoms there was but little current.

It has been calculated theoretically that winds blowing steadily in one direction with the ordinary force of the trade winds would in 100,000 years by friction between the particles put the whole of a mass of water 2,000 fathoms deep, not otherwise influenced, into motion in that direction; but the direction and force of the trade winds are ever changing, and the actual strong currents of the ocean are not in the

trade-wind areas, but are the result of these drifts meeting one another and being compressed by the conformation of the land. We can not therefore expect this theoretical effect to be realized.

One instance of the underrunning of one current by another is brought very plainly to our notice in the North Atlantic to the east of the Great Banks of Newfoundland, where the icebergs borne by the Arctic current from Baffin Bay pursue their course to the southward across the Gulf Stream running eastward. These great masses of ice, floating with seven-eighths of their volume under the surface, draw so much water that they are all but wholly influenced by the undercurrent. A large berg will have its bottom as much as 600 or 700 feet below the surface. The only reason that these bergs continue their journey southward is the action of the cold undercurrent.

It was my good fortune to be ordered in 1872 to undertake a series of experiments of the currents and undercurrents of the Dardanelles and Bosphorus. They proved most interesting. It was well known that a surface stream is almost continuously passing out of the Black Sea through the Bosphorus into the Sea of Marmara, and again through the Dardanelles into the Mediterranean. Certain physicists, of whom Dr. W. Carpenter was one, were, however, of opinion that a return current would be found under the surface running in the opposite direction, and this I was enabled to demonstrate. Though from the imperfection of our apparatus, which we had to devise on the spot, we were unable to exactly proportionate the quantities of water moving in the two directions, we found, whenever the surface current was rushing southwestward through these straits, that for a certain distance, from the bottom upward, the water was in rapid motion in the opposite direction. It was an astonishing sight to behold the buoys which supported a wooden framework of 36 square feet area, lowered to depths from 100 to 240 feet, tearing up the straits against a strong surface current of as much as 3 and 4 miles an hour. It was as perfect an ocular demonstration of a counter undercurrent as could be wished, and the Turks, who watched our proceedings with much suspicion, were strongly of opinion that the devil had a hand in it, and only the exhibition of the Sultan's firman saved us from interruption. In the investigation of these currents we found, as usual, that the wind was the most potent agent. Though the surface water from the Black Sea is almost fresh, and the bottom water of the heavy Mediterranean density of 1.027, it was found that when calm had prevailed the surface current slackened, and at times became nil, while the undercurrent responded by a similar slackening.

The ordinary condition of wind in the regions of the Black Sea and Sea of Marmara is that of a prevalent northeast wind. This causes a heaping up of the water on the southwest shores of those seas, precisely where the straits open, and the surface water therefore rapidly escapes. These straits no doubt present abnormal characters, but, so

far as surface currents are concerned, the long series of observations then made convinced me of the inadequacy of differences of specific gravity, which were here at a maximum, to cause any perceptible horizontal flow of water. I have said that we were unable to define by direct observation the exact position of the dividing line between the opposing currents, but the rapid change in the specific gravity at a certain depth, which varied on different days, gave a strong indication that the currents changed at this point.

A Russian officer, Captain Makaroff, afterwards made similar experiments in the Bosphorus, but with more perfect appliances, and he found that at the point where the specific gravity changed the currents also changed.

I have been anxious to obtain similar observations at the Straits of Babel Mandeb, the southern outlet of the Red Sea, where somewhat similar conditions prevail. Here the winds are governed by the monsoons. For half the year the wind blows from the north down the whole length of the sea, causing a surface flow outward into the Gulf of Aden and a general lowering of the whole level of the sea of about 2 feet. For the other half of the year the wind at the southern end of the sea is strong from the southeast, causing a surface set into the Red Sea, over which the general level of the water rises, while the northerly wind continues to blow throughout the northern half. At either of these times I think it is highly probable that there is an undercurrent in the opposite direction to that at the surface, but unfortunately the sea disturbance is great and observations are very difficult. Observations were, however, made by Capt. W. U. Moore in *H. M. S. Penguin* in 1890, but at a time when the change of monsoon was taking place. The result was peculiar, for it appeared that at a depth of about 360 feet the movement of the water was tidal, while the surface water was moving slowly in one direction—a result generally similar to that obtained by the Americans in the West Indies—but the direction of the tidal flow was directly opposite to what might have been expected, viz, the water ran in while the tide fell, and vice versa. More observations are, however, needed here before any certain conclusions can be formed.

The depth of the ocean is the next great feature which demands attention. On this our knowledge is steadily, though slowly, increasing. The whole of it has been gained during the last fifty years. Commenced by Sir James Ross, whose means were very small, but who nevertheless demonstrated that the so-called unfathomable ocean was certainly fathomable everywhere, the sounding of the ocean has continuously proceeded. The needs of submarine cables have constantly demanded knowledge in this particular, and the different cable companies have had a large share in ascertaining the facts. Expeditions whose main object has been to obtain soundings have been sent out, Great Britain and the United States taking the first place; but most

maritime nations have aided. In the immediate past the additions have mainly been from the soundings which Her Majesty's surveying ships continually take whenever on passage from one place to another, from the work of our cable companies, and from United States vessels. We have as a result a very fair general knowledge of the prevailing depths in the Atlantic, but of the Indian and Pacific oceans it is very fragmentary. We have enough to give us a general idea, but our requirements increase as years roll on. It is a vast task, and it may be safely said will never be completed, for we shall never be satisfied until we know the variations of level under the water as well as we know those on the dry land.

It is hopeless to do more than to briefly sketch the amount of our knowledge. First, as to the greatest depths known. It is very remarkable, and from a geological point of view significant, that the very deepest parts of the ocean are not in or near their centers, but in all cases are very near land. One hundred and ten miles outside the Kurile Islands, which stretch from the northern point of Japan to the northeast, the deepest sounding has been obtained of 4,655 fathoms, or 27,930 feet. This appears to be in a deep depression, which runs parallel to the Kurile Islands and Japan, but its extent is unknown, and may be very large. Seventy miles north of Puerto Rico, in the West Indies, is the next deepest east known, viz, 4,561 fathoms, or 27,366 feet—not far inferior to the Pacific depth; but here the deep area must be comparatively small, as shallower soundings have been made at distances 60 miles north and east of it. A similar depression has been sounded during the last few years west of the great range of the Andes at a distance of 50 miles from the coast of Peru, where the greatest depth is 4,175 fathoms. Other isolated depths of over 4,000 fathoms have been sounded in the Pacific—one between the Tonga or Friendly Islands of 4,500 fathoms, one of 4,478 fathoms near the Ladrões, and another of 4,428 fathoms near Pylstaart Island, all in the Western Pacific. They all require further investigation to determine their extent. With these few exceptions the depth of the oceans so far as yet known nowhere comes up to 4,000 fathoms, or 4 sea miles, but there can be little doubt that other similar hollows are yet to be found.

The sea with the greatest mean depth appears to be the vast Pacific, which covers 67,000,000 of the 188,000,000 of square miles composing the earth's surface. Of these 188,000,000, 137,000,000 are sea, so that the Pacific comprises just one-half of the water of the globe and more than one-third of its whole area. The Northern Pacific has been estimated by Mr. John Murray to have a mean depth of over 2,500 fathoms, while the Southern Pacific is credited with a little under 2,400 fathoms. These figures are based on a number of soundings, which can not be designated otherwise than very sparse.

To give an idea of what remains to be done I will mention that in the eastern part of the Central Pacific there is an area of 10,500,000 square

miles in which there are only seven soundings, while in a long strip crossing the whole North Pacific, which has an area of 2,800,000 square miles, there is no sounding at all. Nevertheless, while the approximate mean depth I am mentioning may be considerably altered as knowledge increases, we know enough to say that the Pacific is generally deeper than the other oceans. The immensity, both in bulk and area, of this great mass of water is difficult to realize, but it may assist us when we realize that the whole of the land on the globe above water level, if shoveled into the Pacific, would only fill one-seventh of it. The Indian Ocean, with an area of 25,000,000 square miles, has a mean depth, according to Mr. Murray, of a little over 2,000 fathoms. This also is estimated from a very insufficient number of soundings. The Atlantic, by far the best-sounded ocean, has an area of 31,000,000 square miles, with a mean depth of about 2,200 fathoms.

The temperature of this huge mass of water is an interesting point. The temperature of the surface is most important to us, as it is largely on it that the climates of the different parts of the world depend. This is comparatively easy to ascertain. We know so much about it that we are not likely to improve on it for many years. We are quite able to understand why countries in the same latitude differ so widely in their respective mean temperatures, why fogs prevail in certain localities more than others, and how it comes about that others are subject to tempestuous storms. On the latter point nothing has come out plainer from recent discussion than the fact that areas where great differences of surface temperature of the sea prevail are those in which storms are generated. It is a matter of observation that in the region south of Nova Scotia and Newfoundland many of the storms which travel over the Atlantic to this country have their rise. An examination of surface temperature shows that in this region the variations are excessive, not only from the juxtaposition of the warm water of the Gulf Stream and the cold water of the Arctic current flowing southward inside of it, but in the Gulf Stream itself, which is composed of streaks of warm and colder water, between which differences of as much as 20° F. exist. The same conditions exist south of the Cape of Good Hope, another well-known birthplace of storms. Here the Agulhas current of about 70° F., diverted by the land, pours into the mass of water to the southward colder by some 25°, and the meeting place is well known as most tempestuous. Southeast of the Rio de la Plata is another stormy area, and here we find the same abnormal variations in surface temperature. Yet another is found off the northeast coast of Japan with the same conditions. These differences are brought about by the mingling of water carried either by the flowing of a powerful current turned by the land into a mass of water of different temperature, as is the case off the Cape of Good Hope, or by the uprising of lower strata of cooler water through a shallow surface stream, as appears to be the case in the Gulf Stream.

A remarkable point recently brought to light by the researches of Mr. John Murray in Scotch lochs is the effect of wind on the surface temperature. It has been observed that wind driving off a shore drifts the surface water before it. This water is replaced by the readiest means, that is to say, by water from below the surface rising to take its place. As the lower strata are in all cases cooler than the surface a lowering of the temperature results, and we find in fact that near all seashores off which a steady wind blows the water is cooler than farther to seaward. This has an important bearing on coral growth, and explains why on all western coasts of the great continents off which the trade winds blow we find an almost absolute dearth of coral, while on the eastern coasts, on which warm currents impinge, reefs abound, the coral animal flourishing only in water above a certain temperature.

Observations of the temperature of the strata of water between the surface and bottom have been of late years obtained in many parts. Compared with the area of the oceans they are but few, but our knowledge steadily increases every year. The subject of the vertical distribution of temperature has not yet been thoroughly investigated in the light of the whole of the information which we now possess, but Dr. Alexander Buchan has been for some time devoting his spare time to the task, and it is a heavy labor, for the data obtained here and there over the world by different ships of all maritime nations are very difficult to collect and to appraise; but I understand that before long we shall have the result, which will prove very interesting, in the last volume of the *Challenger* series. It will readily be understood that observations on temperatures at great depths require great care. In the first place, the thermometers must be most carefully manufactured. They must be subjected to rigorous tests, and they must be carefully handled during the operation. All observations are not of the same value, and the discussion therefore presents considerable difficulty and demands much discretion. In the meantime we can state certain known facts. We have learned that the depth of the warm surface water is small. In the equatorial current between Africa and South America, where the surface is of a temperature of 78° , at 100 fathoms it is only 55° , a difference of 23° , and a temperature of 40° is reached at 400 fathoms. In this region, so far as knowledge goes, the fall in temperature as we descend is most rapid; but, generally speaking, the same variations prevail everywhere. In the tropical Pacific the temperature falls 32° from the surface, where it stands at 82° , to a depth of 200 fathoms, 40° being reached at from 500 to 600 fathoms below the surface. Below the general depth of from 400 to 600 fathoms the temperature decreases very slowly, but there is considerable variation in the absolute amount of it when we get to great depths in different parts of the ocean.

One of the most interesting facts that has been recognized is that in inclosed hollows of the ocean the bottom temperature is apparently **much less than that of the stratum of water at a corresponding depth**

in the waters outside the submarine ridge that forms the inclosing walls, separating them from deeper areas beyond, and is, in all cases that have been observed, equal to that on the ridge. From this fact we are enabled to supplement our imperfect knowledge of depths, because if in a certain part of an ocean we find that the temperature at great depths is higher than we know exists at similar depths in waters apparently connected, we can feel certain that there is a submarine ridge which cuts off the bottom waters from moving along, and that the depth on this ridge is that at which is found the corresponding temperature in the outer waters. As a corollary we also assume that the movement of water at great depths is confined to an almost imperceptible movement, for if there was a motion that we could term, in the ordinary acceptation of the word, a current, it would infallibly surmount a ridge and pour over the other side, carrying its lower temperature with it. A notable instance is the bottom temperature of the North Atlantic. This is nowhere below 35° F., although the depths are very great. But in the South Atlantic at a depth of only 2,800 fathoms the bottom temperature is but a little above 32° F., and we are therefore convinced that somewhere between Africa and South America, though soundings do not yet show it, there must be a ridge at a depth of about 2,000 fathoms. We also come to the same conclusion with regard to the eastern and western portions of the South Atlantic, where similar differences prevail. Again, the few temperatures that have been obtained in the eastern South Pacific show a considerable difference from those in the South Atlantic, and we are compelled to assume a ridge from the Falkland Islands to the Antarctic continent.

It is interesting that the investigation into the translation of the great seismic wave caused by the eruption of Krakatoa in 1883 led to a similar and entirely independent conclusion. The wave caused by the explosion in the Straits of Sunda reached Cape Horn, where by good chance a French meteorological expedition had erected an automatic tide gauge, but instead of one series of waves being marked on the paper there were two. A little consideration showed that the South Pole having directly interposed between Sunda Straits and Cape Horn, the waves diverted by the land about the pole would arrive from both sides. One wave, however, made its appearance seven hours before the other. Study showed that the earliest wave coincided in time with a wave traveling on the Pacific side of the pole, with a velocity due to the known depth, while the later wave must have been retarded in its journey via the South Atlantic. The only possible explanation is that the wave had been impeded by comparatively shallow water. The evidence from bottom temperature was then unknown, and thus does one branch of investigation aid another.

In the Western Pacific the water is colder, a few bottom temperatures of a little over 33° F. having been found in the deep trough east of the Tonga Islands; but the North Pacific, though the deeper ocean—

of enormous area and volume—is apparently again cut off by a submarine ridge. The northwestern part of the Indian Ocean is for similar reasons assumed to be divided from the main body, the shallower water probably running from the Seychelles to the Maldivé Islands.

Mr. Buchan has pointed out why some parts of oceans, deep and vast though they be, are, when cut off from communication with others, warmer at the bottom. Water can only sink through lower layers when it is the heavier, and though a warmer surface current becomes from evaporation denser, its heat makes it specifically lighter than the strata below. It is only when such a current parts gradually with its heat, as in traveling from tropical to temperate regions, that it sinks and slowly but surely carries its temperature with it, modifying the extreme natural cold of the bottom layers. In the North Atlantic and Pacific we have such a condition. The great currents of the Gulf Stream and Japan current as they flow to the north sink, and in the course of ages have succeeded in raising the bottom temperature 3 or 4 degrees. In the southern seas this influence is not at work, and directly connected with the more open water around the South Pole, there is nothing to carry to the abysmal depths any heat to raise them from their normal low temperatures, due to the absence of any heating influence. The ice masses around the South Pole have probably little or no effect on bottom temperature, as the fresher, though colder, water will not sink; and, as a matter of fact, warmer water is found at a few hundred fathoms than at the surface. The lowest temperature ever obtained was by Sir John Ross in the Arctic Ocean in Davis Strait at a depth of 680 fathoms, when he recorded a reading of 25° F. This probably requires confirmation, as thermometers of those days were somewhat imperfect. In the great oceans the greatest cold is found on the western side of the South Atlantic, where the thermometer stands at 32.3° F., but temperatures of 29° F. have been obtained of recent years east of the Faroe Islands, north of the ridge which cuts off the deeper waters of the Arctic from the Atlantic.

Though scarcely within the limits of my subject, which is the sea itself, I must say a few words on the sea floor. The researches carried on in the *Challenger* revealed that, while for a certain distance from the continents the bottom is composed of terrestrial detritus, everywhere in deep water it is mainly composed of the skeletons or remains of skeletons of the minute animals that have lived in the water. In comparatively small depths we find remains of many shells. As the depth increases to 500 fathoms or so we get mainly the calcareous shells of the globigerinæ, which may be said to form by far the greater part of the oceanic floor. In deeper water still, where pressure, combined with the action of the carbonic acid, has dissolved all calcareous matter, we find an impalpable mud with skeletons of the siliceous radiolaria of countless forms of the greatest beauty and complexity. Deeper still, i. e., in water of, speaking generally, over 3,000 fathoms, we find a

reddish-colored clayey mud, in which the only traces of recognizable organic remains are teeth of sharks and cetacea, many belonging to extinct species. What the depths of these deposits may be is a subject of speculation. It may be that some day, as mechanical appliances are improved, we shall find means of boring, but up to the present no such operation has been attempted.

On the specific gravity of the water of the sea I can say but little except that it varies considerably. It is not yet known for certain how far the specific gravities observed at various points and depths remain appreciably constant. In localities where evaporation is great and other influences do not interfere it is evident that the specific gravity of the surface will be high; a consideration which observations confirm, but there are many complications which require more observation before they can be resolved. In some few places repeated observations permit deductions, but taking the sea as a whole we are yet very ignorant of the facts bearing on this point.

The waves which forever disturb the surface of the sea demand much study. The greatest of these, and the most regular, is the tidal wave. On this many powerful intellects have been brought to bear, but it still presents many unsolved anomalies. Lord Kelvin and Professor Darwin have demonstrated that the tidal movement is made up of many waves depending upon different functions of the moon and sun, some being semidiurnal, some diurnal. The time of transit over the meridian, the declination of both bodies, create great variations; the changing distance and position of the moon and the position of her node also have great effect, while the ever-varying direction and force of the winds and the different pressure of the atmosphere play their part, and sometimes a very large part, on what is somewhat loosely known as the meteorological tide. The amplitude of the oscillation of the water depending upon each of the astronomical functions varying for every point on the earth, the effect is that, each having a different period, the resulting mean movement of water has most astonishing variations. In some places there is but one apparent tide in the day; in others this phenomenon occurs only at particular periods of each lunation, while in the majority of cases it is the movements of each alternate tide only that appear to have much to do with one another. Though after long observation made of the times and ranges of tides at any one spot they can now be predicted with great accuracy for that particular place by the method of harmonic analysis, perfected by Prof. G. Darwin, the meteorological tide excepted, no one can yet say what the tide will be at any spot where observations have not been made.

Observations all over the world have now shown that there is no part where the tidal movement is so regular and simple as around the British Islands. This is more remarkable when it is found that the tides on the other side of the Atlantic—at Nova Scotia, for instance—are very complicated. The minor tides, which in most parts of the world,

when combined in one direction, amount to a very considerable fraction of the principal lunar and solar tides, and consequently greatly increase or diminish their effects, are in Great Britain so insignificant that their influence is trifling; but why this should be I have never yet found anyone to explain. Nevertheless there are many very curious points about our tides which are plainly caused by interference, or, in other words, by the meeting of two tidal waves arriving from opposite directions or from the rebound of the tidal waves from other coasts. This effect, also, it has been so far found impossible to predict without observation. On our southern coasts, for instance, in the western part the tide rises about 15 feet, but as it travels eastward the range becomes less and less until, about Poole, it reaches a minimum of 6 feet. Farther east again it increases to Hastings, where the range is 24 feet. Yet farther east it again gradually diminishes. This is due to the reflection from the French coast, which brings another wave which either superposes itself upon or reduces the effect of the main tide advancing up the English Channel; but the details of such reflection are so complex that no one could forecast them without more knowledge than we possess. There can be little doubt that to this cause—reflection—is mainly due the variations in the amount of mean range of tide which are found on many coasts at different parts; and as these reflected waves may arrive from great distances and be many in number, we may cease to wonder at the extraordinary differences in range of tide which prevail, though it will be understood that this is wholly separate from the varying heights of each successive tide or of the tide at different parts of each lunation, or at different times of the year, which depend upon the astronomical influences.

The actual height of the tide in deep water is small, but on passing into shallow water when approaching a shore, and especially when rolling up a gulf of more or less funnel shape, it becomes increased by the retardation caused by friction and by compression laterally, and hence the height of the tide on a coast affected by other causes is greater than in the open sea. The oceanic tide wave is supposed to be from 2 to 3 feet in height, but as this has been assumed from observations made at small oceanic islands where, although the magnifying influences mentioned are at a minimum, they still exist, we wait for precise information until some means of actually measuring the tide in deep water is devised.

The waves due to wind, though not so far-reaching in their effects as the majestic march of the tide wave, are phenomena which are more apparent to the traveler on the ocean. The deep sea in a heavy gale presents, perhaps, the most impressive manifestation of the powers of nature which man can behold, and doubtless many of us have experienced feelings that may vary from awe and wonder to sheer delight, according to the temperament of each individual, at for the first time finding himself face to face with this magnificent sight, though I rather

fear that discomfort is the prevailing feeling that many carry away. The height to which storm waves may arise has never been very satisfactorily determined. Apart from the difficulty of the task and the small number of people who will address themselves to it when they have the chance, it is but rarely that any individual sees really abnormal waves, even though he may be at sea all his life. Different heights for what are called maximum waves have been recorded, and they vary from 40 to 90 feet from crest to hollow. All we can say is that the most probable figure is about 50 or 60 feet. These great storm waves travel very far. In some cases they convey a warning, as their velocity always far exceeds that at which the storm is traveling. In others they intimate that a gale of which no more is seen has occurred somewhere—it may be many miles distant. When they have traveled beyond the limits of the wind which raised them they lose the steepness of slope which characterizes them when under its influence and become an undulation which is scarcely noticed when in deep water. On approaching shallow water, however, they are again apparent, and the “rollers” that occur unperiodically at various places in latitudes where gales never occur would seem to be caused by such waves, originating in areas many thousands of miles distant. Such appears to be the origin of the well-known rollers at Ascension and St. Helena, where the rocky and exposed nature of the landing has caused this phenomenon to be especially noticed.

Other rollers are, however, undoubtedly due to earthquakes or volcanic eruptions occurring in the bed of the sea. Many of the great and sudden waves which have caused devastation and great loss of life on the shores of western South America are referable to this cause. Observations to enable the focus of such a disturbance to be traced have generally been lacking, but it is probable that where the wave has been large the point of origin has not been far distant. In one notable instance the conditions were reversed. The point of origin was known, and the distance to which the resulting wave traveled could be fairly satisfactorily traced. This was the great eruption in the Straits of Sunda, in August, 1883, which locally resulted in the disappearance of the major part of the island of Krakatoa, and the loss of nearly 40,000 lives on the neighboring shores of Java and Sumatra by the huge wave which devastated them. The records of automatic tide gauges and the observations of individuals enabled the waves emanating from this disturbance to be followed to great distances. These waves were of great length, the crests, arriving at intervals of about an hour, and moving with a velocity of about 350 miles an hour, were about that distance apart. The waves recorded at Cape Horn were apparently undoubtedly due to the eruption and traveled distances of 7,500 miles and 7,800 miles in their course on either side of the south polar land. They were only 5 inches in height above mean level of the sea, while the waves recorded at places on the southern part of Africa, at a distance of about 5,000 miles from the scene of the eruption, were from

1 to 2 feet high, the original long waves being of an unknown height, but probably did not exceed 10 or 15 feet. No other such opportunity of testing the distances to which great waves may travel has ever occurred, and as such a catastrophe as gave rise to them could scarcely be repeated without similar loss of life, it may be hoped we shall not live to see another, interesting though the discussion of the numerous phenomena were.

The movement of the particles of water due to the tide wave extends to the bottom of the deepest water, and doubtless plays an important part in keeping up a constant motion in the abysses, but the depth to which the action of the surface waves originating in wind reach is still but little known by observation. If, however, we study the contour of the bottom off the shores of land exposed to the full influence of the great oceans, we are struck by the very general rapid increase of slope after a depth of about 80 to 100 fathoms (500 to 600 feet) has been reached. It appears probable that this is connected with the depth to which wave action may extend, the fine particles brought down by rivers or washed from the land by the attrition of the breakers being distributed and gradually moved down the slope. When we examine banks in the open sea, we find, however, that there are a great many with a general depth of from 30 to 40 fathoms, and the question arises whether this may not be the general limit of the power of oceanic waves to cut down the mass acted upon when it is fairly friable.

The question has an interesting bearing on the subject of the ever-debated origin of coral atolls, for this is the general depth of many large lagoons; and granted that the sea can cut down land to this depth, we have at once an approach to the solution of the problem of the formation of bases of a suitable depth and material upon which the coral animal can commence operations. This question also awaits more light, and I merely offer this remark as a suggestion. It is, however, somewhat remarkable that in recent cases of volcanic islands piled up by submarine eruptions, they have all been more or less rapidly washed away, and are in process of further diminution under the surface.

Observations on the mean level of the sea show that it constantly varies, in some places more than others. This subject has not yet been worked out. In some localities it is plainly due to wind, as in the Red Sea, where the summer level is some 2 feet below that of winter, owing to the fact that in summer the wind blows down the whole length of the sea, and drives the water out. In many places, as in the great estuary of the Rio de la Plata, the level is constantly varying with the direction of the winds, and the fluctuation due to this cause is greatly in excess of the tidal action. In others the cause is not so clear. At Sydney, New South Wales, Mr. Russell found that during eleven years the level was constantly falling at about an inch a year, but by the last accounts received it was again stationary.

The variations in the pressure of the atmosphere play an important part in changes of sea level. A difference of 1 inch in the barometer

has been shown to be followed by a difference of a foot in the mean level of the sea, and in parts of the world where the mean height of the barometer varies much with the seasons and the tidal range is small, this effect is very marked.

Of any secular change in the level of the sea little is known. This can only be measured by comparison with the land, and it is a question which is the more unstable, the land or the water—probably the land, as it has been shown that the mass of the land is so trifling, compared with that of the ocean, that it would take a great deal to alter the general mean level of the latter.

All the points connected with the sea that I have had the honor of bringing before you form part of the daily observation of the marine surveyor when he has the chance, but I can not refrain from also mentioning other duties, which are indeed in the present state of our knowledge and of the practical requirements of navigation, the principal points to which he has to pay attention, as it may explain why our knowledge on so many interesting details still remains very imperfect.

Working as we do in the interests of the vast marine of Great Britain, the paramount necessity of good navigational charts requires that the production of such charts should be our principal aim. It is difficult for a landsman and difficult even for a sailor who has never done such work to realize the time that is necessary to make a really complete marine survey. The most important part, the ascertainment of the depth, is done, so to speak, in the dark—that is to say, it is by touch and not by sight that we have to find the different elevations and depressions of the bottom of the sea. In making a map of the land an isolated rock or hill stands up like a beacon above the surrounding land, and is at once localized and marked, but a similar object under the sea can only be found by patient and long-continued sounding, and may very easily be missed.

When it is considered that marine surveying has only been seriously undertaken for about one hundred years, with a very limited number of vessels, we shall, I think, understand how in the vast area of the waters, taking only those bordering the shores, many unsuspected dangers are yearly discovered. Very, very few coasts have been minutely surveyed, and, setting aside for a moment the great changes that take place off shores where sandbanks prevail, I should be sorry to say that even on our own coasts charts are perfect. Yearly around Great Britain previously unknown rocks come to light, and if this is the case at home, what are we to think of the condition of charts of less-known localities! Our main efforts therefore are directed to the improvement of charts for safe navigation, and the time that can be spared to the elucidation of purely scientific problems is limited. Nevertheless, the daily work of the surveyor is so intimately connected with these scientific problems that year by year, slowly but surely, we add to the accumulation of our knowledge of the sea.

THE ORIGIN OF THE OLDEST FOSSILS AND THE DISCOVERY OF THE BOTTOM OF THE OCEAN.¹

By W. K. BROOKS,

Professor of Zoology in the Johns Hopkins University.

In the *Origin of Species* Darwin says that the sudden appearance of species belonging to several of the main divisions of the animal kingdom in the lowest known fossiliferous rocks is at present inexplicable and may be truly urged as a valid objection to his views.

If his theory be true, he says that "it is indisputable that before the lowest Cambrian stratum was deposited long periods elapsed, as long as, or probably far longer than, the whole interval from the Cambrian age to the present day, and that during these vast periods the world swarmed with living creatures. Here," he says, "we encounter a formidable objection; for it seems doubtful whether the earth, in a fit state for the habitation of living creatures, has lasted long enough. To the question why we do not find such fossiliferous deposits belonging to these assumed earliest periods prior to the Cambrian system I can give no satisfactory answer."

On its geological side this difficulty is even greater than it was in Darwin's day, for we now know that the fauna of the Lower Cambrian was rich and varied; that most of the modern types of animal life were represented in the oldest fauna which has been discovered, and that all its types have modern representatives. The paleontological side of the subject has been ably summed up by Walcott in an interesting memoir on the oldest fauna which is known to us from fossils, and his collection of one hundred and forty-one American species from the Lower Cambrian is distributed over most of the marine groups of the animal kingdom, and except for the absence of the remains of vertebrated animals, the whole province of animal life is almost as completely covered by these one hundred and forty-one species as it could be by a collection from the bottom of the modern ocean. Four of the American species are sponges, two are hydrozoa, nine are actinozoa, twenty-nine are brachiopods, three are lamellibranchs, thirteen are gas-

¹From the *Journal of Geology*, July-August, 1894; Vol. II, No. 5.

teropods, fifteen are pteropods, eight are crustacea, fifty-one are trilobites, and trails and burrows show the existence of at least six species of bottom forms, probably worms or crustacea. The most notable characteristic of this fauna is the completeness with which these few species outline the whole fauna of the modern sea floor. Far from showing us the simple unspecialized ancestors of modern animals, they are most intensely modern themselves in the zoological sense, and they belong to the same order of nature as that which prevails at the present day.

The fossiliferous beds of the Lower Cambrian rest upon beds which are miles in vertical thickness, and are identical in all their physical features with those which contain this fauna. They prove beyond question that the waters in which they were laid down were as fit for supporting life at the beginning as at the end of the enormous lapse of time which they represent, and that all the conditions have since been equally favorable for the preservation and the discovery of fossils. Modern discovery has brought the difficulty which Darwin points out into clearer view, but geologists are no more prepared than he was to give a satisfactory solution, although I shall now try to show that the study of living animals in their relations to the world around them does help us, and that comparative anatomy and comparative embryology and the study of the habits and affinities of organisms tell us of times more ancient than the oldest fossils and give a more perfect record of the early history of life than paleontology.

While the history of life as told by fossils has been slow and gradual, it has not been uniform, for we have evidence of the occurrence of several periods when modification was comparatively rapid.

We are living in a period of intellectual progress, and among terrestrial animals cunning now counts for more than size or strength, and fossils show that, while the average size of mammals has diminished since the Middle Tertiary, the size of their brains has increased more than 100 per cent; that the brain of a modern mammal is more than twice as large, compared with its body, as the brain of its ancestors in the Middle Tertiary. Measured in years the Middle Tertiary is very remote, but it is very modern compared with the whole history of the fossiliferous rocks, although more of brain development has been effected in this short time than in all preceding time from the beginning.

The later paleozoic and early secondary fossils mark another period of rapid change, when the fitness of the land for animal life, and the presence of land plants, brought about the evolution of terrestrial animals.

I shall give reasons for seeing, in the Lower Cambrian, another period of rapid change, when a new factor—the discovery of the bottom of the ocean—began to act in the modification of species, and I shall try to show that, while animal life was abundant long before, the evolution of animals likely to be preserved as fossils took place with comparative rapidity, and that the zoological features of the Lower Cambrian are of

such a character as to indicate that it is a decided and unmistakable approximation to the primitive fauna of the bottom, beyond which life was represented only by minute and simple surface animals not likely to be preserved as fossils.

Nothing brings home more vividly to the zoologist a picture of the diversity of the Lower Cambrian fauna and of its intimate relation to the fauna on the bottom of the modern ocean than the thought that he would have found on the old Cambrian shore the same opportunity to study the embryology and anatomy of pteropods and gasteropods and lamellibranchs, of crustacea and medusæ, echinoderms and brachiopods, that he now has at a marine laboratory; that his studies would have followed the same lines then that they do now, and that most of the record of the past which they make known to him would have been ancient history then. Most of the great types of ancient life show by their embryology that they run back to simple and minute ancestors which lived at the surface of the ocean, and that the common meeting point must be projected back to a still more remote time, before these ancestors had become differential from each other.

After we have traced each great line of modern animals as far backward as we can through the study of fossils, we still find these lines distinctly laid down. The Lower Cambrian crustacea, for example, are as distinct from the Lower Cambrian echinoderms or pteropods or lamellibranchs or brachiopods as they are from these of the present day, but zoology gives us evidence that the early steps in the establishment of these great lines were taken under conditions which were essentially different from those which have prevailed, without any essential change from the time of the oldest fossils to the present day, and that most of the great lines of descent were represented in the remote past by ancestors, which, living a different sort of life, differed essentially, in structure as well as in habits, from the representatives of the same types which are known to us as fossils.

In the echinoderms we have a well-defined type represented by abundant fossils, very rich in living forms, very diversified in its modification, and therefore well fitted for use as an illustration. This great stem contains many classes and orders, all constructed on the same plan, which is sharply isolated and quite unlike the plan of structure in any other group of animals. All through the series of fossiliferous rocks echinoderms are found, and their plan of structure is always the same. Paleontology gives us most valuable evidence regarding the course of evolution within the limits of a class, as in the crinoids or the echinoids; but we appeal to it in vain for light upon the organization of the primitive echinoderm or for connecting links between the classes. To our questions on these subjects, and on the relation of the echinoderms to other animals, paleontology is silent, and throws them back upon us as unsolved riddles.

The zoologist unhesitatingly projects his imagination, held in check only by the laws of scientific thought, into the dark period before the times of the oldest fossils, and he feels absolutely certain of the past existence of a stem from which the classes of echinoderms have inherited the fundamental plan of their structure. He affirms with equal confidence that the structural changes which have separated this ancient type from the classes which we know from fossils are very much more profound and extensive than all the changes which each class has undergone from the earliest paleozoic times to the present day. He is also disposed to assume, but, as I shall show, with much less reason that the amount of change which structure has undergone is an index to the length of time which the change has required, and that the period which is covered by the fossiliferous rocks is only an inconsiderable part of that which has been consumed in the evolution of the echinoderms.

The zoologist does not check the flight of his scientific imagination here, however, for he trusts implicitly to the embryological evidence which teaches him that still farther back in the past all echinoderms were represented by a minute floating animal which was not an echinoderm at all in any sense except the ancestral one, although it was distinguished by features which natural selection has converted, under the influence of modern conditions, into the structure of echinoderms. He finds in the embryology of modern echinoderms phenomena which can bear no interpretation but this, and he unhesitatingly assumes that they are an inheritance which has been handed down from generation to generation through all the ages from the prehistoric times of zoology.

Other groups tell the same story with equal clearness. A lingula is still living in the sand bars and mud flats of the Chesapeake Bay under conditions which have not effected any essential change in its structure since the time of the Lower Cambrian. Who can look at a living lingula without being overwhelmed by the effort to grasp its immeasurable antiquity; by the thought that while it has passed through all the chances and changes of geological history, the structure which fitted it for life on the earliest paleozoic bottom is still adapted for a life on the sands of the modern sea floor?

The everlasting hills are the type of venerable antiquity; but lingula has seen the continents grow up, and has maintained its integrity unmoved by the convulsions which have given the crust of the earth its present form.

As measured by the time-standards of the zoologist lingula itself is modern, for its life history still holds locked up in its embryology the record, repeated in the development of each individual, of a structure and a habit of life which were lost in the unknown past at the time of the Lower Cambrian, and it tells us vaguely but unmistakably of life at the surface of the primitive ocean at a time when it was represented by minute and simple floating ancestors.

Broadly stated, the history of each great line has been like that of the echinoderms and brachiopods. The oldest pteropod or lamelli-branch or echinoderm or crustacean or vertebrate which we know from fossils exhibits its own type of structure with perfect distinctness, and later influences have done no more than to expand and diversify the type, while anatomy fails to guide us back to the point where these various lines met each other in a common source, although it forces us to believe that the common source, once had an individual existence. Embryology teaches that each line once had its own representative at the surface of the ocean, and that the early stages in its evolution have passed away and left no record in the rocks.

If we try to call before the mind a picture of the land surface of the earth we see a vast expanse of verdure stretching from high up in the mountains over hills, valleys, and plains, and through forests and meadows down to the sea, with only an occasional lake or broad river to break its uniformity.

Our picture of the ocean is an empty waste, stretching on and on with no break in the monotony except now and then a flying fish or a wandering sea bird or a floating tuft of sargassum, and we never think of the ocean as the home of vegetable life. It contains plant-like animals in abundance, but these are true animals and not plants, although they are so like them in form and color. At Nassau, in the Bahama Islands, the visitor is taken in a small boat, with windows of plate glass set in the bottom, to visit the "sea gardens" at the inner end of a channel through which the pure water from the open sea flows between two coral islands into the lagoon. Here the true reef corals grow in quiet water, where they may be visited and examined.

When illuminated by the vertical sun of the Tropics and by the light which is reflected back from the white bottom, the pure, transparent water is as clear as air, and the smallest object 40 or 50 feet down is distinctly visible through the glass bottom of the boat.

As this glides over the great mushroom-shaped coral domes which arch up from the depths, the dark grottoes between them and the caves under their overhanging tops are lighted up by the sun, far down among the anthozoa or flower animals and the zoophytes or animal plants, which are seen through the waving thicket of brown and purple sea fans and sea feathers as they toss before the swell from the open ocean.

There are miles of these "sea gardens" in the lagoons of the Bahamas, and it has been my good fortune to spend many months studying their wonders, but no description can convey any conception of their beauty and luxuriance. The general effect is very garden-like, and the beautiful fishes of black and golden yellow and iridescent-cobalt blue hover like birds among the thickets of yellow and lilac gorgonias.

The parrot fishes seem to be cropping the plants like rabbits, but more careful examination shows that they are biting off the tips of the gorgonias and branching madrepores or hunting for the small crustacea

which hide in the thicket and that all the apparent plants are really animals.

The delicate star-like flowers are the vermilion heads of boring annelids or the scarlet tentacles of actinias, and the thicket is made up of pale lavender bushes of branching madrepores, and green and brown and yellow and olive masses of brain coral, of alcyonarians of all shades of yellow and purple, lilac and red, and of black and brown and red sponges. Even the lichens which incrust the rocks are hydroid corals, and the whole sea garden is a dense jungle of animals, where plant life is represented only by a few calcareous algæ so strange in shape and texture that they are much less plant-like than the true animals.

The scarcity of plant life becomes still more notable when we study the ocean as a whole. On land herbivorous animals are always much more abundant and prolific than the carnivora, as they must be to keep up the supply of food, but the animal life of the ocean shows a most remarkable difference, for marine animals are almost exclusively carnivorous.

The birds of the ocean, the terns, gulls, petrels, divers, cormorants, tropic birds and albatrosses, are very numerous indeed, and the only parallel to the pigeon roosts and rookeries of the land is found in the dense clouds of sea birds around their breeding grounds, but all these sea birds are carnivorous, and even the birds of the seashore subsist almost exclusively upon animals such as mollusca, crustacea, and annelids.

The seals pursue and destroy fishes; the sea elephants and walrus live upon mollusks; the whales, dolphins and porpoises and the marine reptiles all feed upon animals and most of them are fierce beasts of prey.

There are a few fishes which pasture in the fringe of seaweed which grows on the shore of the ocean, and there are some which browse among the floating tufts of algæ upon its surface, but most of them frequent these places in search of the small animals which hide among the plants.

In the Chesapeake Bay the sheephead browses among the algæ upon the submerged rocks and piles like a marine sheep, but its food is exclusively animal, and I have lain upon the edge of a wharf watching it crunch the barnacles and young oysters until the juice of their bodies streamed out of the angles of its mouth and gathered a host of small fishes to snatch the fragments as they drifted away with the tide.

Many important fishes, like the cod, pasture on the bottom, but their pasturage consists of mollusks and annelids and crustacea instead of plants, and the vast majority of sea fishes are fierce hunters, pursuing and destroying smaller fishes, and often exhibiting an insatiable love of slaughter, like our own bluefish and tropical albacore and barracuda. Others, such as the herring, feed upon smaller fishes and the pelagic pteropods and copepods; and others, like the shad, upon the minute organisms of the ocean, but all, with few exceptions, are carnivorous.

In the other great groups of marine animals we find some scavengers, some which feed upon micro-organisms, and others which hunt and destroy each other, but there is no group of marine animals which corresponds to the herbivora and rodents and the plant-eating birds and insects of the land.

There is so much room in the vast spaces of the ocean, and so much of it is hidden, that it is only when surface animals are gathered together that the abundance of marine life becomes visible and impressive; but some faint conception of the boundless wealth of the ocean may be gained by observing the quickness with which marine animals become crowded together at the surface in favorable weather. On a cruise of more than two weeks along the edge of the Gulf Stream I was surrounded continually night and day by a vast army of dark-brown jelly-fish (*Linerges mercutia*), whose dark color made them very conspicuous in the clear water. We could see them at a distance from the vessel, and at noon, when the sun was overhead, we could look down to a great depth through the center-board well, and everywhere, to a depth of 50 or 60 feet, we could see them drifting by in a steady procession like motes in a sunbeam. We cruised through them for more than 500 miles and we tacked back and forth over a breadth of almost a hundred miles, and found them everywhere in such abundance that there were some in every bucketful of water which we dipped up; nor is this abundance of life restricted to tropical waters, for Haeckel tells us that he met with such enormous masses of *Limacina* to the northwest of Scotland that each bucket of water contained thousands. The tendency to gather in crowds is not restricted to the smaller animals, and many species of raptorial fishes are found in densely packed banks.

The fishes in a school of mackerel are as numerous as the birds in a flight of wild pigeons, and we are told of one school which was a wind-row of fish half a mile wide and at least 20 miles long. But while pigeons are plant eaters, the mackerel are rapacious hunters, pursuing and devouring the herrings as well as other animals.

Herring swarm like locusts, and a herring bank is almost a solid wall. In 1879 three hundred thousand river herring were landed in a single haul of the seine in Albemarle Sound; but the herring are also carnivorous, each one consuming myriads of copepods every day.

In spite of this destruction and the ravages of armies of medusæ and siphonophores and pteropods the fertility of the copepods is so great that they are abundant in all parts of the ocean, and they are met with in numbers which exceed our power of comprehension. On one occasion the *Challenger* steamed for two days through a dense cloud formed of a single species, and they are found in all latitudes, from the Arctic regions to the Equator, in masses which discolor the water for miles. We know, too, that they are not restricted to the surface, and that the banks of copepods are sometimes more than a mile thick. When we reflect that thousands would find ample room and food in a

pint of water, one can form some faint conception of their universal abundance.

The organisms which are visible in the water of the ocean and on the sea bottom are almost universally engaged in devouring each other, and many of them, like the bluefish, are never satisfied with slaughter, but kill for mere sport.

Insatiable rapacity must end in extermination unless there is some unfailling supply, and as we find no visible supply in the water of the ocean we must seek it with a microscope, which shows us a wonderful fauna made up of innumerable larvæ and embryos and small animals, but these things can not be the food supply of the ocean, for no carnivorous animal could subsist very long by devouring its own children. The total amount of these animals is inconsiderable, however, when compared with the abundance of a few forms of protozoa and proto-phytes, and both observation and deduction teach that the most important element in marine life consists of some half dozen types of protozoa and unicellular plants; of globigerina and radiolarians, and of trichodesmium, pyrocystis, protococcus and the coccospheres rhabdospheres and diatoms.

Modern microscopic research has shown that these simple plants, and the globigerinæ and radiolarians which feed upon them, are so abundant and prolific that they meet all demands and supply the food for all the animals of the ocean. This is the fundamental conception of marine biology. The basis of all the life in the modern ocean is found in the micro-organisms of the surface.

This is not all. The simplicity and abundance of the microscopic forms and their importance in the economy of nature show that the organic world has gradually taken shape around them as its center or starting point, and has been controlled by them. They are not only the fundamental food supply, but the primeval supply, which has determined the whole course of the evolution of marine life.

The pelagic plant life of the ocean has retained its primitive simplicity on account of the very favorable character of its environment, and the higher rank of the littoral vegetation and that of the land is the result of hardship.

On land the mineral elements of plant food are slowly supplied, as the rains dissolve them; limited space brings crowding and competition for this scanty supply; growth is arrested for a great part of each year by drought or cold; the diversity of the earth's surface demands diversity of structure and habit, and the great size and complicated structure of terrestrial plants are adaptations to these conditions of hardship.

At the surface of the ocean the abundance and uniform distribution of mineral food in solution; the area which is available for plants; the volume of sunlight and the uniformity of the temperature are all favorable to the growth of plants, and as each plant is bathed on all sides

by a nutritive fluid, it is advantageous for the new plant-cells which are formed by cell-multiplication, to separate from each other as soon as possible, in order to expose the whole of their surface to the water. Cell-aggregation, the first step toward higher organization, is therefore disadvantageous to the pelagic plants, and as the environment at the surface of the ocean is so monotonous, there is little opportunity for an aggregation of cells to gain any compensating advantage by seizing upon a more favorable habitat. The pelagic plants have retained their primitive simplicity, and the most distinctive peculiarity of the microscopic food supply of the ocean is the very small number of forms which make up the enormous mass of individuals.

All the animals of the ocean are dependent upon this supply of microscopic food, and many of them are adapted for preying upon it directly, but a review of the animal kingdom will show that no highly organized animal has ever been evolved at the surface of the ocean, although all depend upon the food supply of the surface.

The animals which now find their home in the open waters of the ocean are, almost without exception, descendants of forms which lived upon or near the bottom, or along the seashore, or upon the land, and all the exceptions are simple animals of minute size. A review of the whole animal kingdom would take more space than we can spare, but it would show that the evidence from embryology, from comparative anatomy, and from paleontology all bears in the same direction and proves that every large and highly organized animal in the open ocean is descended from ancestors whose home was not open water but solid ground, either on the bottom or on the shore. Embryology also gives us good ground for believing that all these animals are still more remotely descended from minute and simple pelagic ancestors, and that the history of all the highly organized inhabitants of the water has followed a roundabout path from the surface to the bottom and then back into the water. When this fact is seen in all its bearings, and its full significance is grasped, it is certainly one of the most notable and instructive features of evolution.

The food supply of marine animals consists of a few species of microscopic organisms which are inexhaustible and the only source of food for all the inhabitants of the ocean. The supply is primeval as well as inexhaustible, and all the life of the ocean has gradually taken shape in direct dependence upon it. In view of these facts we can not but be profoundly impressed by the thought that all the highly organized marine animals are products of the bottom or the shore or the land, and that while the largest animals on earth are pelagic the few which are primitively pelagic are small and simple. The reason is obvious. The conditions of life at the surface are so easy that there is little fierce competition, and the inorganic environment is so simple that there is little chance for diversity of habits.

The growth of terrestrial plants is limited by the scarcity of food, but there is no such limit to the growth of pelagic plants or the animals

which feed on them, and while the balance of life is no doubt adjusted by competition for food this is never very fierce, even at the present day, when the ocean swarms with highly organized wanderers from the bottom and the shore. Even now the destruction or escape of a microscopic pelagic organism depends upon the accidental proximity or remoteness of an enemy rather than upon defense or protection, and survival is determined by space relations rather than a struggle for existence.

The abundance of food is shown by the ease with which wanderers from the land, like sea birds, find places for themselves in the ocean, and the rapidity with which they spread over its whole extent.

As a marine animal the insect *Halobates* must be very modern as compared with most pelagic forms, yet it has spread over all tropical and subtropical seas, and it may always be found skimming over the surface of mid-ocean as much at home as a *Gerris* in a pond. I never found it absent in the Gulf Stream when conditions were favorable for collecting.

The easy character of pelagic life is shown by the fact that the larvæ of innumerable animals from the bottom and the shore have retained their pelagic habit, and I shall soon give reasons for believing that the larva of a shore animal is safer at sea than near the shore.

There was little opportunity in the primitive pelagic fauna and flora for an organism to gain superiority by seizing upon an advantageous site or by acquiring peculiar habits, for one place was like another, and peculiar habits could count for little in comparison with accidental space relations. After the fauna of the surface had been enriched by all the marine animals which have become secondarily adapted to pelagic life, competition with those improved forms brought about improvements in those which were strictly pelagic in origin, like the siphonophores, and those wanderers from the bottom introduced another factor into the evolution of pelagic life, for their bodies have been utilized for protection or concealment and in other ways, and we now have fishes which hide in the poison curtain of *Physalia*, crustacea which live in the pharynx of *Salpa* or in the mouth of the menhaden, barnacles and sucking fish fastened to whales and turtles, besides a host of external and internal parasites. The primitive ocean furnished no such opportunity, and the conditions of pelagic life must at first have been very simple, and while competition was not entirely absent the possibilities of evolution must have been extremely limited and the progress of divergent modification very slow so long as all life was restricted to the waters of the ocean.

There can be no doubt that floating life was abundant for a long period when the bottom was uninhabited. The slow geological changes by which the earth gradually assumed its present character present a boundless field for speculation, but there can be no doubt that the surface of the primeval ocean became fit for living things long before the

deeper waters or the sea floor, and during this period the proper conditions for the production of large and complicated organisms did not exist, and even after the total amount of life had become very great it must have consisted of organisms of small size and simple structure.

Marine life is older than terrestrial life, and as all marine life has shaped itself in relation to the pelagic food supply, this itself is the only form of life which is independent, and it must therefore be the oldest. There must have been a long period in primeval times when there was a pelagic fauna and flora rich beyond limit in individuals, but made up of only a few simple types. During this time the pelagic ancestors of all the great groups of animals were slowly evolved, as well as other forms which have left no descendants. So long as life was restricted to the surface no great or rapid advancement, through the influences which now modify species, was possible, and we know of no other influences which might have replaced them. We are therefore forced to believe that the differentiation and improvement of the primitive flora and fauna was slow, and that, for a vast period of time, life consisted of an innumerable multitude of minute and simple pelagic organisms. During the time which it took to form the thick beds of older sedimentary rocks, the physical conditions of the ocean gradually took their present form, and during a part, at least, of this period the total amount of life in the ocean may have been very nearly as great as it is now without leaving any permanent record of its existence, for no rapid advance took place until the advantages of life on the bottom were discovered.

We must not think of the populating of the bottom as a physical problem, but as discovery and colonization, very much like the colonization of islands. Physical conditions for a long time made it impossible, but its initiation was the result of biological influences, and there is no reason why its starting point should necessarily be the point where the physical obstacles first disappeared. It is useless to speculate upon the nature of the physical obstacles; there is reason to think one of them, probably an important one, was the deficiency of oxygen in deep water.

Whatever their character may have been they were all, no doubt, of such a nature that they first disappeared in the shallow water around the coast, but it is not probable that bottom life was first established in shallow water, or before the physical conditions had become favorable at considerable depths.

The sediment near the shore is destructive to most surface animals, and recent explorations have shown that a stratum of water of very great thickness is necessary for the complete development of the floating microscopic fauna and flora, and it is a mistake to picture them as confined to a thin surface stratum. Pelagic plants probably flourished as far down as light penetrates, and pelagic animals are abundant at very great depths. As the earliest bottom animals must have depended

directly upon the floating organisms for food, it is not probable that they first established themselves in shallow water, where the food supply is both scanty and mixed with sediment; nor is it probable that their establishment was delayed until the great depths had become favorable to life.

The belts around elevated areas far enough from shore to be free from sediment, and deep enough to permit the pelagic fauna to reach its full development above them, are the most favorable spots, and paleontological evidence shows that they were seized upon very early in the history of life on the bottom.

It is probable that colony after colony was established on the bottom and afterwards swept away by geological change like a cloud before the wind, and that the bottom fauna which we know was not the first. Colonies which started in shallow water were exposed to accidents from which those in great depths were free; and in view of our knowledge of the permanency of the sea floor and of the broad outlines of the continents, it is not impossible that the first fauna which became established in the deep zone around the continents may have persisted and given rise to modern animals. However this may be, we must regard this deep zone as the birthplace of the fauna which has survived, as the ancestral home of all the improved metazoa.

The effect of life upon the bottom is more interesting than the place where it began, and we are now to consider its influence upon animals, all whose ancestors and competitors and enemies had previously been pelagic. The cold, dark, silent, quiet depths of the sea are monotonous compared with the land, but they introduced many new factors into the course of organic evolution.

It is doubtful whether the animals which first settled on the bottom secured any more food than floating ones, but they undoubtedly obtained it with less effort, and were able to devote their superfluous energy to growth and to multiplication, and thus to become larger and to increase in numbers faster than pelagic animals. Their sedentary life must have been favorable to both sexual and asexual multiplication, and the tendency to increase by budding must have been quickly rendered more active, and one of the first results of life on the bottom must have been to promote the tendency to form connected corals, and to retain the connection between the parent and the bud until the latter was able to obtain its own food and to care for itself. The animals which first acquired the habit of resting on the bottom soon began to multiply faster than their swimming allies, and their asexually produced progeny, remaining for a longer time attached to and nourished by the parent stock, were much more favorably placed for rapid growth. As the animals of the bottom live on a surface, or at least a thin stratum, while swimming animals are distributed through solid space, the rapid multiplication of bottom animals must soon have led to crowding and to competition, and it quickly became harder and harder for new forms.

from the open water to force themselves in among the old ones, and colonization soon came to an end.

The great antiquity of all the types of structure which are represented among modern animals is therefore what we should expect, for after the foundation of the fauna of the bottom was laid it became, and has ever since remained, difficult for new forms to establish themselves.

Most of our knowledge of the sea bottom is from three sources: From dredgings and other explorations, from rocks which were formed beyond the immediate influence of continents, and from the patches of the bottom fauna which have gradually been brought near its surface by the growth of coral reefs, and from all these sources we have testimony to the density of the crowd of animals on favorable spots. Deep-sea explorations give only the most scanty basis for a picture of the sea bottom, but they show that animal life may thrive with the dense luxuriance of tropical vegetation, and Sir Wyville Thomson says he once brought up at one time on a tangle, which was fastened to a dredge, over twenty thousand specimens of a single species of sea-urchin. The number of remains of paleozoic crinoids and brachiopods and trilobites which are crowded into a single slab of fine-grained limestone is most astounding, and it testifies most vividly and forcibly to the wealth of life on the old sea floor.

No description can convey any adequate conception of the boundless luxuriance of a coral island, but nothing else gives such a vivid picture of the capacity of the sea floor for supporting life. Marine plants are not abundant on coral islands and the animals depend either directly or indirectly upon the pelagic food supply, so that their life is the same in this respect as that of animals in the deep sea far from land.

The abundant life is not restricted to the growing edge of the reef, and the inner lagoons are often like crowded aquaria. At Nassau my party of eight persons found so much to study on a little reef in a lagoon close to our laboratory that we discovered novelties every day for four months, and our explorations seldom carried us beyond this little tract of bottom. Every inch of the bottom was carpeted with living animals, while others were darting about among the corals and gorgonias in all directions; but this was not all, for the solid rock was honeycombed everywhere by tubes and burrows, and when broken to pieces with a hammer each mass of coral gave us specimens of nearly every great group in the animal kingdom. Fishes, crustacea, annelids, mollusca, echinoderms, hydroids and sponges could be picked out of the fragments and the abundance of life inside the solid rock was most wonderful.

The absence of pelagic life in the landlocked water of coral islands is as impressive and noteworthy as the luxuriance of life upon and near the bottom.

On my first visit to the Bahama Islands I was sadly disappointed by the absence of pelagic animals where all the conditions seemed to be peculiarly favorable.

The deep ocean is so near that, as one cruises through the inner sounds past the openings between the islets which form the outer barrier, the deep blue water of mid-ocean is seen to meet the white sand of the beach, and soundings show that the outer edge is a precipice as high as the side of Chimborazo and much steeper.

Nowhere else in the world is the pure water of the deep sea found nearer land or more free from sediment, and on the days when the weather was favorable for outside collecting we found siphonophores and pteropods, pelagic mollusks and crustacea and tunicates and all sorts of pelagic larvæ in great abundance in the open water just outside the inlets.

Inside the barrier the water was always calm, and day after day it was as smooth as the surface of an inland lake. When I first entered one of these beautiful sounds, where the calm, transparent water stretches as far the eye can reach, while new beauties of islets and winding channels open before one as those which are passed fade away on the horizon, I felt sure that I had at last found a place where the pelagic fauna of mid-ocean could be gathered at our door and studied on shore. The water proved to be not only as pure as air but almost as empty. At high water we sometimes captured a few pelagic animals near the inlets, but we dragged our surface nets through the sounds day after day only to find them as clean as if they had been hung in the wind to dry. The water in which we washed them usually remained as pure and empty as if it had been filtered, and we often returned from our touring expeditions without even a copepod or a zoea or a pluteus.

The absence of the floating larvæ is most remarkable, for the sounds swarm with bottom animals which give birth every day to millions of swimming larvæ. The mangrove swamps and the rocky shores are fairly alive with crabs carrying eggs at all stages of development, and the boat passes over great black patches of sea-urchins crowded together by thousands. The number of animals engaged in laying their eggs or hatching their young is infinite, yet we rarely captured any larvæ in the tow net, and most of these we did find were well advanced and nearly through their larval life.

It is often said that the water of coral sounds is too full of lime to be inhabited by the animals of the open ocean, but this is a mistake, for the water is perfectly fit for supporting the most delicate and sensitive animals, and those which we caught outside lived in the house in water from the sounds better than in any other place where I ever tried to keep them, and instead of being injurious the pure water of coral sounds is peculiarly favorable for use in aquaria for surface animals.

The scarcity of floating organisms can have only one explanation. They are eaten up, and competition for food is so fierce that nearly every organism which is swept in by the tide and nearly every larva which is born in the sounds is snatched by the tentacles around some hungry mouth.

Nothing could illustrate the fierceness of the struggle for food among the animals on a crowded sea bottom more vividly than the emptiness of the water in coral sounds where the bottom is practically one enormous mouth. The only larvæ which have much chance to establish themselves for life are those which are so fortunate as to be swept out into the open ocean, where they can complete their larval life under the milder competition of the pelagic fauna, and while it is usually stated that the larvæ of bottom animals have retained the pelagic habit for the purpose of distributing the species, it is more probable that it has been retained on account of its comparative safety.

These facts show that competition must have come quickly after the establishment of the first fauna on the bottom, and that it soon became very rigorous and led to severe selection and rapid modification; and we must also remember that life on the bottom brought with it many new opportunities for divergent specialization and improvement. The increase in size which came with economy of energy increased the possibilities of variation and led to the natural selection of peculiarities which improved the efficacy of the various parts of the body in their functions of relation to each other, and this has been an important factor in the evolution of complicated organisms.

The new mode of life also permitted the acquisition of protective shells, hard-supporting skeletons, and other imperishable parts, and it is therefore probable that the history of evolution in later times gives no index as to the period which was required to evolve from small, simple pelagic ancestors the oldest animals which were likely to be preserved as fossils.

Life on the bottom also introduced another important evolutionary influence—competition between blood-relations. In those animals which we know most intimately, divergent modification, with the extinction of connecting forms, results from the fact that the fiercest competitors of each animal are its closest allies, which, having the same habits, living upon the same food, and avoiding enemies in the same way, are constantly striving to hold exclusive possession of all that is essential to their welfare.

When a stock gives rise to two divergent branches, each escapes competition with the other so far as they differ in structure or habits, while the parent stock competing with both at a disadvantage is exterminated.

Among the animals which we know best, evolution leads to a branching tree-like genealogy, with the topmost twigs represented by living animals, while the rest of the tree is buried in the dead past. The connecting form between two species must therefore be sought in the records of the past or reconstructed by comparison. Even at the present day things are somewhat different in the open ocean, and they must have been very different in the primitive ocean, for a pelagic animal has no fixed home, one locality is like another, and the compet-

itors and enemies of each individual are determined in great part by accidents. We accordingly find, even now, that the evolution of pelagic animals is often linear instead of divergent, and ancient forms, such as the sharks, often live on side by side with the later and more evolved forms. The radiolarians and medusæ and siphonophores furnish many well-known illustrations of this feature of pelagic life.

No naturalist is surprised to find in the South Pacific or in the Indian Ocean a *Salpa* or a pelagic crustacean or a surface fish or a whale which was previously known only from the North Atlantic, and the list of species of marine animals which are found in all seas is a very long one. The fact that pelagic animals are so independent of those laws of geographical distribution which limit land animals is additional evidence of the easy character of the conditions of pelagic life.

One of the first results of life on the bottom was to increase a sexual multiplication and to lengthen the time during which buds remain united to and nourished by their parents, and to crowd individuals of the same species together and to cause competition between relations. We have in this and other obvious peculiarities of life on the bottom a sufficient explanation of the fact that since the first establishment of the bottom fauna, evolution has resulted in the elaboration and divergent specialization of the types of structure which were already established rather than the production of new types.

Another result of the struggle for existence on the bottom was the escape of varieties from competition with their allies by flight from the crowded spots and a return to the open water above; just as in later times the whales and sea birds have gone back from the land to the ocean.

These emigrants, like the civilized men who invade the homes of peaceful islanders, brought with them the improvements which had come from fierce competition, and they have carried everything before them and produced a great change in the pelagic fauna.

The rapid intellectual development which has taken place among the mammals since the Middle Tertiary, and the rapid structural changes which took place in animals and plants when the land fauna and flora were established, are well known, but the fact that the discovery of the bottom initiated a much earlier and probably more important era of rapid development in the forms of animal life has never been pointed out.

If this view is correct the primitive fauna of the bottom must have had the following characteristics:

(1) It was entirely animal, without plants, and it at first depended directly upon the pelagic food supply.

(2) It was established around elevated areas in water deep enough to be beyond the influence of the shore.

(3) The great groups of animals were rapidly established from pelagic ancestors.

(4) The animals of the bottom rapidly increased in size and hard parts were quickly acquired.

(5) The bottom fauna soon produced progressive development among pelagic animals.

(6) After the establishment of the fauna of the bottom elaboration and differentiation among the representatives of each primitive type soon set in and led to the extinction of connecting forms.

Many of the oldest fossils like the pteropods are the modified descendants of ancestors with hard parts, and there is no reason to suppose that the first animals which were capable of preservation as fossils have been discovered, but it is interesting to note that the oldest known fauna is an unmistakable approximation to the primitive fauna of the bottom.

The Lower Cambrian fossils are distributed through strata more than 2 miles thick, some, at least, of them showing by their fine grain and by the perfect preservation of tracks and burrows which were made in soft mud, and of soft animals like jelly-fish, that they were deposited in water of considerable depth. The sediment was laid down slowly and gently in water so deep as to be free from disturbance and under conditions so favorable that it contains the remains of delicate animals not often found as fossils.

While the fauna of the Lower Cambrian undoubtedly lived in water of very considerable depth, it was not oceanic but continental, for we are told by Walcott that "one of the most important conclusions is that the fauna of the Lower Cambrian lived on the eastern and western shores of a continent that in its general configuration outlines the American continent of to-day." "Strictly speaking, the fauna did not live upon the outer shore facing the ocean, but on the shores of interior seas, straits or lagoons that occupied the intervals between the several ridges that ran from the central platform east and west of the main continental land surface of the time.

This fauna was rich and varied, but it was not self-supporting, for no fossil plants are found, and the primary food supply was pelagic. Animals adapted for a rapacious life, such as the pteropods, were abundant, and prove the existence of a rich supply of pelagic animals. All the forms known from the fossils are either carnivorous, like the medusae, corals, crustacea, and trilobites, or they are adapted, like the sponges, brachiopods, and lamellibranchs, for straining minute organisms out of the water or for gathering those which rained down from above, and the conditions under which they lived were very similar to those on the bottom at the present day.

Walcott's studies show that the earliest known fauna had the following characteristics: It consisted, so far as the record shows, of animals alone, and these were dependent upon the pelagic food supply for support. While small in comparison with many modern animals, they were gigantic compared with primitive pelagic animals. The species were few, but they represent a very wide range of types. All these types have modern representatives, and most of the modern types are

represented in the Lower Cambrian. Their home was not the bottom of the deep ocean, but the shores of a continent under water of considerable depth.

The Cambrian fauna is usually regarded as a halfway station in a series of animal forms which stretches backward into the past for an immeasurable period, and it is even stated that the history of life before the Cambrian is larger by many fold than its history since. So far as this opinion rests on the diversity of types in Cambrian times, it has no good basis; for if the views here advocated are correct the evolution of the ancestral stems took place at the surface, and all the conditions necessary for the rapid production of types were present when the bottom fauna first became established.

As we pass backward toward the Lower Cambrian we find closer and closer agreement with the zoological conception of the character of primitive life on the bottom. While we can not regard the oldest fauna which has been discovered as the first which existed on the bottom, we may feel confident that the first fauna of the bottom resembled that of the Lower Cambrian in its physical conditions and in its most distinctive peculiarities—the abundance of types, and the slight amount of differentiation among the representatives of these types—and we must regard it as a decided and unmistakable approximation to the beginning of the modern fauna of the earth, as distinguished from the more ancient and simple fauna of the open ocean.

THE RELATIONS OF PHYSIOLOGY TO CHEMISTRY AND MORPHOLOGY.¹

By GIULIO FANO.

Owing to advances in methods of research, to the increase in the aggregate of facts acquired by science, and to the ever more thorough study of scientific systems concerning living beings, we have become more and more exacting as to the interpretations—always, unfortunately, doubtful—to be given to physiological facts. We have sought to replace the theory of vital force by a physico-chemical theory of life; to put in the place of a mysterious and impalpable entity a confusion of material elements, which in their turn assume mysterious and imponderable characters as soon as we attempt to define them in any way.

But while it is true that the fundamental doctrine of physics and chemistry could not itself stand a searching analysis, yet there is no doubt that it represents in the hierarchy of science the higher grade of development now attained by our methods of investigation. The rapid progress of these branches of science is probably chiefly due to the relative simplicity of the problems with which they have to deal, but in any case they are considered as the rational basis of a considerable number of researches undertaken by physiology for the purpose of defining scientifically the phenomena of life. Let us not forget, however, that physics and chemistry have yet far to go before they become free, if indeed they ever do, from the shackles of empiricism; before they are able to reduce every phenomenon to the simple expression of time, space, and force, and to the derivatives therefrom—energy, velocity, and mass; and that under the names attraction, affinity, conductivity, etc., are hidden things no less obscure than are the phenomena of life. However this may be, since we can not conceive of a mechanical basis of psychic facts, we ought nevertheless to admit that, with the exception of consciousness, all expressions of function, infinite and complex as they are, may be comprehended among physico-chemical phe-

¹An inaugural address given at the commencement of the physiological course at the Institute for Higher Instruction at Florence. Translated from the *Revue Scientifique*, 1894, Vol. II, 4th ser., pages 257-264.

nomena, if we allow that the physics and chemistry involved have special characters of their own, and that they frequently are mechanical in their operations, and that the effects produced by them are of a quite peculiar nature.

It was in accordance with the natural development of human thought that physiologists should first be led to examine the physical phenomena of life, or to look to physics for explanations by analogy, and that, in spite of the most serious objections, it was only later that they took up the chemical side of biological questions, trying to give a conception of them based upon the mechanism of atoms. In short, it may be said that since that has been done many problems of physiology are treated from the standpoint of chemistry, and that we resort to that science for what many believe to be the latest intelligence concerning the manifestations of life.

A quite characteristic example of the development of the general ideas that controlled and still control physiology is found, among many others, in the theory which attempts to account for a phenomenon of great interest, and now much studied, that of inhibition. You know that by inhibition we designate the arrest of a functional act induced by an antagonistic act, but not, as in paralysis, by suppressing totally or in part the conditions producing the phenomenon. We have a well-known example of it in the action of the pneumogastric nerve upon the heart. Whenever that nerve is excited by a sufficiently powerful stimulant, the movements of the heart cease, returning again as soon as the excitation is withdrawn or the force of the nerve exhausted. In this case we have produced by means of an excitant a nervous vibration, which, elaborated in certain ganglia situated in the substance of the heart, neutralizes the action of the excito-motor cells. This conclusive experiment, first made in 1846 by the brothers Weber,¹ encountered objections based, it must be confessed, upon a prejudice arising from the systematic notions then in vogue. At that time physiology was at a period of its history when, imbued by somewhat crude material conceptions, it was alleged that everything could be simplified so as to reduce every movement to a reflex act. So it was denied that there could be found in our organism any other than sensory and motor fibers.

We ought to add that the philosophical tendency of that time had great force, for among those who refused to allow that the experiment of Weber had any special importance were two of the most illustrious names of modern physiology.² But other acts of restraint were found besides the inhibition of the heart, so that the opposition could no longer be maintained, especially when it was found that in the nervous centers themselves there occur inhibitory processes, in which, as we

¹ E. H. Weber. "Ueber Eduard Weber's Entdeckungen in der Lehre von den Muskel-contraction," *Archiv für Anatomie und Physiologie (Müller's Archiv)*, Berlin, 1846, page 483.

² Schiff, Molesch. *Unters.*, VI, page 201, 1859, and VII, page 401, 1861.

shall presently see, we must look for the definite physiological basis of thought.

One of the first explanations proposed for inhibition in the realm of theoretical physiology was, as might have been expected, purely physical in its character. It was thought that its phenomena might be considered as analogous to those classed under interference. You know that the union of two sounds may produce silence, and that from two rays of light we may derive darkness. This occurs when the waves that theoretically constitute their material basis meet in such a way that the summit of one wave corresponds to the hollow of another so that they mutually neutralize each other. The beats and the rings of Newton are phenomena of interference. Lauder Brunton,¹ following the footsteps of Bernard² and of Romanes,³ tried with much skill to bring the phenomena of inhibition into the same category as those we have just cited. It would be very interesting to follow the learned investigator in his defense of his doctrine, but I shall limit myself to stating that he founded his theory upon the supposition, which appears very probable in view of certain considerations, that in inhibition the nervous vibrations follow two paths of unequal length, then unite in a single one in which the parted waves again meet with opposite phases and consequently neutralize each other. As you will observe, this doctrine recalls at once the acoustic tubes invented by Herschel and then successfully constructed by Quineke and König.⁴

In short, Lauder Brunton holds that movement, sensation, inhibition, or stimulation are not absolute, but merely relative terms. According to him the same cell may exercise inhibitory or excito-motor functions, according to the length of the waves of impulsion that pass to or from it, according to the distance which these impulsions traverse and the velocity with which they travel. The English experimenter endeavored also to find a morphological basis for his doctrine in the two prolongations, one straight and the other spiral, with which certain nerve cells are provided. This hypothesis is, as you see, inspired solely by physical conceptions which demand a structural form, but, however ingenious it may be, it does not account for the facts, and we now admit that acts of inhibition are processes essentially chemical in character.

Permit me to lay some stress upon this argument, for it will afford us an opportunity of touching upon several questions of fundamental importance in physiological studies.

From a chemical point of view the functions of a living being may be included in two great categories. The first embraces the destructive, analytic, catabolic, or disintegrating acts by which the individual in

¹T. Lauder Brunton. "On the nature of inhibition and the action of drugs upon it," *Nature*, London, 1882-83, XXVII, pages 419, 436, 467, and 485.

²Bernard. *La chaleur animale*, Paris, 1876, page 371.

³G. J. Romanes. "On the locomotor system of medusæ," *Phil. Trans.* 1877, CLXVII, 730.

⁴Tyndall. *Lectures on Sound*. American edition, page 261.

question liberates energy in the form of heat, electricity, etc.; the second embraces synthetic, anabolic, or restorative acts by which there becomes accumulated in the tissues under the form of explosive or reserve materials the force necessary for the functions that develop or reestablish the dynamical and histological losses they have suffered.

Living matter is, to use a comparison of Hering,¹ like a copper wire immersed in a solution of sulphate of copper, which, when conducting an electric current, loses on the one hand a portion of its substance by solution, on the other accumulates an additional amount of metal. These antagonistic functions have within our organism a close correlation, being united in an intimate solidarity from which results that dynamic and material stability that gives to a tissue its morphological character. This solidarity has, in my opinion, among its other controlling conditions, a very important chemical basis.²

You know that exercise develops organs and that this fact is confirmed throughout the entire sphere of our functions. Thus it is that muscles enlarge in consequence of repeated movements, that glands increase in size when obliged to perform unusual work, that in other terms function develops the organ through which it acts. We here enter upon a functional circle which might in logic be called a vicious circle, but which gives admirable results from a teleological point of view.

In a word, while an organ develops by exerting its functions, this very development makes it more and more capable of performing those functions. This relation, universally recognized, finds its application in the doctrine of evolution and helps much to explain to us those marvelous progressions and differentiations of structure by which amorphous protoplasm is transformed into a complex organism. But when we say that an organ develops by executing its functions, or that function makes the organ, we content ourselves with enunciating a fact without explaining the mechanism to which it is due. Let us try, however, to throw light on some of the conditions that determine the above-mentioned relations between an organ and its function.

We are able to determine with considerable accuracy the stimulants that cause an organ to act, and that these are found partly in the environment of the organism, partly in the interstitial blastema that surrounds the tissues, partly within the elements of the tissues. All our activities may therefore be classed as reflex acts, pseudo-automatic acts and automatic acts properly so called. We also know that the processes of molecular destruction that form the chemical basis of our functional acts are frequently followed by a corresponding and proportional amount of work of restoration, but we are ignorant of the nature of the internal impulses that cause the tissues to restore them-

¹Hering. *Zur Theorie der Vorgänge in der lebendigen Substanz*, Prag, 1888.

²Fano. "De quelques bases physiologiques de la pensée," *Revue de philosophie scientifique*, Vol. IX, page 193, 1890.

selves. Now, from some of my studies, it seems to me that one may conclude that stimulants to the nutritive activities for organic restoration consist, in certain cases, at least, in the by-products, the scoriæ, the cinders that result from functional activity.

These catabolic products gradually accumulate in the tissues and pass from thence into the blood, which, continually circulating, transports them to the glands, by which they are again worked over and finally eliminated. It appears that it is precisely these by-products, produced by our tissues when in activity, that give to nutritive phenomena the impulse that excites to a renewal of the energy spent in function, which leads the organ accomplishing a work to develop and adapt itself to new demands of the individual and the environment. In order to understand my assertion it must be remembered that the tissues are never completely at rest; that, on the contrary, as to material matters they are constantly changing and are being ceaselessly, though slowly, consumed; even when they show no internal evidence of function. Yet the by-products occurring during this apparent functional repose do not suffice to properly maintain, or rather are not suitable for setting up, this work of reconstruction, since an inactive organ decreases, atrophies, and may be reduced to a rudimentary state. When, on the contrary, it remains active, it maintains itself in nutritive equilibrium, and increases in proportion to its greater or less functional activity. This arises, at least in part, from the fact that the by-products of the function excite to restorative work greater in amount than the destruction that occurred during the period of activity. In fact, if an organ that only occasionally acts does not atrophy, it is because that during its action it establishes such a stimulation to nutrition that it compensates not only for the losses occasioned by activity, but also for those occurring during repose. Thus scientific sanction is given to a fact of daily experience, viz: that an organ is kept in good nutritive condition by a proper alternation of work and rest. It is also seen why increased activity of the function of an organ leads to its hypertrophy. Increase of work produces, indeed, such an amount of nutritive stimulation that, as a logical consequence of what has been said, the losses that preceded the period of activity as well as those which arise from it will not only be made good, but restored with usury, and the organ will consequently be in a better nutritive condition than before. That is of course within physiological limits, for excessive activity leads to those phenomena of auto-intoxication which are collectively designated under the term fatigue.

It is likewise certain that the chemical mechanism which I have now briefly sketched out for you includes but one side of the question, and that it is necessary to consider another which concerns itself with morphological phenomena. The chemical elaborations by which tissues develop give rise to molecular polarizations, from which results the structure of living beings.

We may thus suppose that structural adjustments are formed keeping pace with the fundamental improvement of the nervous centers which are working and developing, such adjustments becoming manifest as special modifications of the nerves.¹

Besides the basis of a chemical nature of which I have spoken, destructive and constructive phenomena owe their reciprocal solidarity to the nervous system, which combines with each other the different organs and tissues, and, modifying their respective attitudes, unites them in a homogeneous and stable whole.

That the nervous system presides over destructive functions has long been known. We know, indeed, that almost all the movements of our organism originate from impulses that start from the motor centers and induce modifications of form accompanied by manifestations of energy due to an increase in the destructive processes in the contractile tissues. Thus when a motor nerve is stimulated it produces in muscle an exaggerated chemical action that leads to a destruction of the contractile tissue. In other terms, a motor nerve is an analytic or catabolic nerve.

Let us consider now the processes of inhibition. We have already stated that the fibers of the pneumogastric nerve that supply the heart muscle, have an inhibitory function, and can not for that reason be placed in the same category as the motor or catabolic fibers. We will now say, on the other hand, that there are many facts that show that inhibition is the result of an increase in the synthetic processes of organic restoration, and hence relates to a diminution of catabolic acts, a decrease of molecular destruction.²

In this way the energy set at liberty by impulses acting on the motor nerves serves to increase the destructive acts in the interior of the tissues, and manifests itself externally under the form of motion, heat, electricity, etc. On the contrary, that set in motion by the inhibitory

¹ Janzi, "Les faits et les inductions de l'histologie moderne dans le système nerveux," *Revue expérimentale de pathologie mentale et de médecine légale*.

² W. H. Gaskell. "Ueber die elektrischen Veränderungen, welche in dem ruhenden Herzmuskel die Reizung des Nervus vagus begleiten," *Beiträge zur Physiologie*. Carl Ludwig's Festschrift, Leipzig, 1887, page 114.

Fano et Payor. "De quelques rapports entre les propriétés contractiles et les propriétés électriques des oreillettes du cœur," *Archives italiennes de biologie*, T. IX, page 143, 1888.

W. H. Gaskell. "On the structure, distribution, and function of the nerves which innervate the visceral and vascular systems," *Journal of Physiology*, Cambridge, 1886, VII, 1.

Hering, *loc. cit.*

J. S. Burdon Sanderson. "Elementary problems in physiology," Report of the British Association for the Advancement of Science, 1889, page 604.

Fano, *loc. cit.*

Herzen. "Le rôle psycho-physiologique de l'inhibition, d'après M. Jules Fano," *Revue Scientifique*, T. XLVI, page 239, 1890.

Fano. "De la chimie respiratoire chez les animaux et chez les plantes," *Archives des sciences médicales*, Vol. XVIII, No. 1, 1894.

nerves, serves to overcome the chemical affinities opposed to the synthetic formation of great molecular complexes, and, setting up restorative chemical processes, causes the diminution or cessation of functional acts of a disintegrating chemical character.

In addition to these phenomena of inhibition, which we may term peripheric, there are others of a central origin brought to light by the investigations of Setchenow, Guyon, Golsy, and others. These have shown that the nervous centers may exert a strong inhibitory action upon reflex acts in general, and even, according to some experiments of my own, upon the automatic activities of the medulla oblongata. This restraining action of the nervous centers is closely connected with the problem of the physiological basis of thought.¹ In fact, the inhibitory processes oppose such a resistance to the nervous vibrations passing through the brain that impressions are necessarily arrested for a long time within the sphere of the sensorium, and may thus induce that associated series of conscious phenomena that lies above the sphere of mere sensation or motion. Besides, the restorative chemical character of the processes of inhibition explains to us the phenomena of memory, without which we would be unable to understand consciousness. The intensity of the psychical act is therefore in direct proportion to the force of the restraining act. It would take too long to refer, even in passing, to the importance of inhibition in all psychical operations. We will merely allude to the fact that education, which contributes to form the character of the child, is valuable in proportion as it trains the capacity for controlling the instinctive impulses of human nature.

Thus it is that, starting from the arrest of the movements of the heart, we may, by a gradual succession of facts and deductions, finally attack one of the most difficult, and certainly one of the highest, problems of physiology—that of the functional basis of thought. We can thus prove that both the simplest acts of the vegetative life of a tissue, as well as the most complex psychical manifestations of a superior organism, have for their essential basis chemical processes of the same nature.

But we must not boast too much over these results; for while, in the concrete case we have cited, chemical antagonism helps to explain the relation between inhibition and movement, chemistry can not usually reveal the *modus operandi* of a functional act.

From the chemical processes of our organism there are, as we have already said in another form, effects derived of two kinds—either liberation of energy in actions attended with the disengagement of heat or its accumulation in processes during which such disengagement does not take place. But if we were acquainted with the innumerable reactions that take place in our organism, which for the greater part are entirely unknown to us, we would yet have to find out how the energy

¹Fano (Giulio). Saggio sperimentale sul meccanismo dei movimenti volontari nella Testuggine palustre. Reale Istituto di studi Superiore, Firenze, 1884.

developed by them is transformed into function; how, in the complicated mechanism of our tissues, it comes to manifest itself in the form of heat, electricity, muscular movement, secretion, and nervous activity. Is not the same coal burned in the different engines? Yet how many varied effects may be manifested by these different causes! Although the chemical basis of their function may be the same, does not that function remain invariable, even when the nature of the fuel consumed in the furnace varies? Consider the immense variety of metabolisms of animals and plants; compare that with the admirable functional unity of these beings, and tell me if that does not suffice to show how slight is the importance of chemical work in the development of a special function.

All this appears to me to be forgotten by those who, impelled by that enthusiasm for system now so much in vogue, see in every organic function a chemical fact and nothing else. We, on the contrary, recognize truly that chemical action is the cause of the energy displayed, but we can not forget that function is self-determined, transforming that energy and presenting it under an infinite number of manifestations.

The admirable researches of Raoul Pictet¹ show clearly the share that in functional acts ought to be ascribed to chemical reactions and that which should be given to the organization of the tissues. This experimenter has recently shown that a very low temperature—100° below zero—stops all chemical reaction, no matter what; even sulphuric acid and nitric acid no longer combine with soda, potash, and ammonia. These experiments show that at absolute zero heterogeneous bodies no longer react upon each other, whatever may be their affinities, for the reason, according to Pictet, that they have attained the limit of cohesion, and that no sufficient force brings the atoms near enough to each other to get them within the sphere of each other's activity. If, on the other hand, we keep living things in a refrigerating apparatus for a long time, it may be observed that after thawing they again resume their functions in an absolutely normal manner.² Pictet thus obtains a complete restoration of the manifestations of life in bacilli and seeds kept at 200° below zero. Vibratile cilia that have supported a temperature of 90° and fish that have been so frozen as to form a solid mass with the ice in which they are embedded and have become as brittle as glass may also be recalled to life.

These experiments are of great importance, inasmuch as they demonstrate that an arrest of chemical activity in the tissues does not destroy the potential conditions of life, and that the latter finds the basis for its continuity rather in the organization of the body, that is in its structural mechanism. To use a somewhat crude illustration, the usual relation of chemistry to the functional activity of a living being is like that of

¹ Raoul Pictet. "Essai d'une méthode générale de synthèse chimique," *Archives des sciences physiques et naturelles*, T. XXVIII, page 397, 1892.

² Raoul Pictet. "La vie et les basses températures," *Revue Scientifique*, T. LII, page 577, 1893.

coal to the work performed by a steam engine. By cooling the animal we may extinguish the fire in the furnace; its functions are suspended, but the mechanism that causes it to move is not, after all, destroyed, for if we again heat the organism which we have been cooling it will behave as the engine does when we relight its fire; the being on which we are experimenting will again resume its movements. "If we could," says Pictet,¹ "create an organized structure quite complete, but dead, physicochemical conditions would be sufficient to develop all the phenomena of vegetable life. Let us at once admit," he continues, "that psychic phenomena could never be produced nor explained by the simple movement of organized matter." It is a strange fact that diastases and the poisons known as ptomaines, unlike organized matter, appear to be much injured by great cold and lose their specific activities. Thus low temperatures effect a remarkable distinction between microbes and diastases, marking clearly the difference between chemical actions under the influence of organization and those not so controlled.

Let us further observe how processes which in the interior of living tissues constitute the chemical basis of function, likewise occur externally in reactions which have their origin in life as well as in dead tissues. These are processes that do not always lead to exactly similar chemical results, but which have a similar general catabolic character by which the very complex organic molecule, by means of oxidation or successive divisions, by hydration or reduction, mounts the scale of organic compounds and becomes by degrees more and more simple.

The difference lies in this, that in living beings the kinetic effect resulting from chemical affinity manifests itself in a thousand diverse activities, while in dead tissues it is transformed almost wholly into heat, other forms of movement, more particularly those of a functional character, being totally arrested.

This occurs because in dead tissues catabolic action likewise attacks the structural mechanism, and this makes the working of the organic machine impossible, while in the living organism the products that by their decomposition induce functions are, under normal conditions, almost wholly those inclosed within differentiated protoplasts, and if sometimes this activity is also exercised upon the tissues, they are rapidly and fully restored by metabolic processes.

In short we ought to again recall that the chemistry of the tissues not only supplies fuel for the mechanical substratum of our functions, but is also used in constructing and restoring the organism. These assimilating processes are controlled by the special elective attitudes of each of the elements, and if they also have a chemical basis they yet find their determining cause in a long history of external reactions and internal adaptations by which is explained the gradual development of living beings and the place which an organism has fixed for itself in the hierarchy of organic forms.

¹Loc. cit., page 585.

But here we enter the very obscure domain of the origin and development of life. You know how much the determining causes of heredity and evolution have been discussed, and how the Darwinian laws, although remaining fundamentally the same, have been profoundly modified as far as regards the conditions of their development. While, for example, it would seem that we must not admit the hereditary transmission of acquired characters in animals, the study of the development of plants tends to change our too absolute ideas as to the relations between autogeny and phylogeny and to give to evolution a periodic character established by heredity,¹ and by the influence of time and the environment.

At all events it is always organization, independently of the causes by which it was or is determined, that fixes and molds the activities of an organism, although, in the causal succession of phenomena, functional differentiations precede morphological differentiations, and are sometimes manifested in a tissue whose details can not be shown by our present means of investigation. Besides, even the so-called amorphous protoplasm is developed little by little into a very complex whole, and it is even thought that it may be considered as a colony of microorganisms.²

The cell, according to this theory, loses its fundamental character of morphological unity and is supposed to be made up, like a higher organism, of a multitude of very much smaller units that probably differ from each other. Finally let us, with these, go beyond the world actually cognizable by the senses, let us imagine an internal web made up of unities still more minute and more simple that bear the same relation to organized forms as molecules do to inorganic matter. The structure of these elements and the morphological relations that unite them ought not, however, to be considered as the bed through which flows the torrent of life, but as the mechanism which elaborates and develops its manifestations.

We know, besides, that the morphological element has no stable basis, and that it even becomes modified according to the various functions it has to perform. Thus it is that the anatomical changes of an element may sometimes inform us as to the condition of its nutrition, whether it has been in action or remained long at rest, and whether there are developing within it those mysterious processes by which a cell prepares for reproduction. From all this it clearly results that by the study of conditions and of the morphological modifications that determine, accompany, or follow a functional act, much more than by chemical researches, we can perhaps some day explain many a weighty problem of physiology, if not those fundamental processes character

¹ M. E. Heckel. "La Périodicité évolutive des animaux et des végétaux," *Revue scientifique*, T. LII, page 649, 1893.

² R. Altmann. "Die Genese der Zelle." *Beiträge zur Physiologie*. Carl Ludwig's Festschrift, Leipzig, 1887, page 235.

istic of a living being by which energy is accumulated and manifested, transformed and given its special developments. For these morphological facts express, as we have already said, elective activities slowly accumulated in the infinite past which, associating themselves with the present chemical activities, give results that are unexpected in proportion as we are ignorant of the intimate nature of the organization.

Thus Pfeffer,¹ after having observed that active bacilli are attracted by peptone, by asparagine, by chloride of sodium, in short by many substances, while the zoospores of ferns are attracted by malic acid, and those of mosses by sugar of milk, and that the trillionth part of a milligram is sufficient to produce that attraction, grants that the observer might be led to conclude that there was here an act of volition rather than a simple chemical phenomenon. Because of this and of many other observations of a similar character, some authors regard the elective action of molecular organisms as the rudimentary expression of tastes and proclivities as well as the origin of certain idiosyncrasies and of the more or less localized action of certain poisons, so that even in the most simple phenomena of the nutritive activity of a tissue we encounter a problem of selection indissolubly bound up with that of thought, the origin of which is probably closely connected with that of life.

To this may be added that not only do the chemical actions that occur in an organism have a peculiar quality; the conditions under which they occur are also special and peculiar to living beings—that is to say, to organization and its products. We can indeed reproduce some of these chemical processes that occur in the web of our tissues, but to obtain similar results we are obliged to employ very strong electric currents or reagents of such power that they would destroy any organism, no matter what. In organized beings, on the contrary, these effects are obtained at a temperature equal to or but a little above that of the environment, at ordinary atmospheric pressure, under the influence of currents so slight as to be hardly demonstrable, and by using chemical affinities of the most feeble power.

What we have said hitherto, while indicating the limits of physiological chemistry, detracts in no way from its great and real importance. It is sufficient to mention the new spheres for investigation now opening—the metabolism of the tissues, the action of the blood glands, and of the sympathetic nerve, auto-intoxication and immunity—to show how vast is the field of practical action open to chemical research. It gives us occasion to note how organisms in their manifold adaptations use these affinities according to their varied conditions of existence, and how the chemical forces adapt themselves to the production of colors, to the distillation of perfumes, to the accumulation of substances, which, like explosives, amass in small volume a large amount of virtual energy; to the elaboration of materials of all kinds for the mechanical needs of

¹Pfeffer. "De Irritabilité chez les plantes," *Archives des sciences physiques et naturelles*, T. XXX, page 397, 1893.

the organism, for the nutritive necessities of life, for the æsthetic exigencies of sex. In all this chemistry has an immense field of fruitful research before it, and we shall find in the phenomena of living beings the desired instructions for making life easier, for improving and defending it, for rendering it sufficiently productive to permit us to practice that social altruism that nature herself now prevents us from attaining. But this field is now and will remain more practical than theoretical, more utilitarian than scientific, because, even if the complicated processes going on within the crucibles of life were well known to all, life itself would always remain for us unknown and impenetrable. But this ought not to deter us; we shall keep on trying and testing, accumulating facts, pushing as far as possible our analytical researches, convinced that we should be content to seek truth without acquiring the whole of it.

As you see, we are to-day already quite far from the systems in vogue a few years ago, and, knowing more, we realize more clearly how slight is the scope of our knowledge; for with increased knowledge comes an enlargement of our conception of the complexity of the phenomena of life; the horizon of the unknown widens out in vast relative proportions. For this reason permit me to believe that the moment is not yet at hand when the facts developed within the living organism can receive an astronomic sanction, and let me recall to you what was said by Galileo, the founder of the experimental method, the regenerator of natural philosophy: "I have always held him extremely rash who attempts to measure by human capacity all that nature can and will do, since there is not, on the contrary, a single effect in nature, however small it may be, that can be entirely understood by the most penetrating intelligence. This idle presumption of wishing to understand everything must necessarily arise from never having understood anything; for if he had ever applied himself to perfectly understand any one thing, and had really appreciated what constitutes knowledge, he would know that in the infinity of other conclusions he does not understand one."¹

We ought, when experimenting, to always have these words in mind; for if it is true that we ought to keep our attention firmly fixed upon a fact until we have acquired a clear and limpid perception of it, it is none the less so that before interpreting it we ought to consider its entire surroundings, remembering that it is not isolated, but, on the contrary, a simple facet, infinitely small, of a preeminently complex whole. Let us not imitate the presumptuous physiologists that achieve success by the apparent clearness of their explanations, giving the pupil the agreeable illusion that he can learn much, quickly, and without fatigue. This, unfortunately, is a too general tendency, and we often see how, in their desire to warp the phenomena of life to the limits of their own

¹Galileo (Galilei). *Dialogo dei due massimi sistemi del mondo*, Firenze, 1842, vol. 1, page 114.

intelligence, they construct systems much more ingenious than veracious, and then display them before a public that only applauds readily constructed automata presented to it as living beings. I must confess that I always look with extreme distrust upon systems. I can not forget that if they have a didactic importance they never correspond exactly to the truth, especially in what concerns living beings, so complex in their great simplicity. Technical necessities often oblige us to separate functional elements from each other; but we then ought to seek to reunite them, because it is from their union that springs that resultant complex of reciprocal influences that constitutes a living organism. Thus to the cool, impartial, and sagacious work of the experimenter the physiologist must bring the assistance of a high philosophical culture and a certain breadth of intuition and imagination, that faculty which Tyndall¹ lauds as one of the most powerful aids to human progress. "Without imagination," says he, "we could not make a step beyond the animal world; we could hardly reach its confines. I do not here allude to that irregular power that plays capriciously with facts, but to that orderly, disciplined capacity whose only function is to create the ideas imperiously demanded by the intellect."

Certainly, looked at in this way, the goal of physiology is very difficult to reach, and I should be the last to remind you of it, being myself unequal to the task. But inability to attain an ideal ought not to prevent you from having it constantly before your eyes, from clinging to and proclaiming it, in hopes that others with greater powers than yourself may reach it. High ambitions are allowed to all, provided that they are sincere and disinterested, and I do not think that doubt can be entertained of the sincerity of a lover of physiology, particularly in this age of sharp struggle for material existence.

¹Tyndall. Notes on Light, Paris, 1875, page 46. [NOTE BY TRANSLATOR.—The passage here cited does not appear in any English or American edition of Tyndall's Lectures on Light. It is probably taken in substance, though not in exact form, from some passages in his lecture "On the scientific use of the imagination," a translation of which was published in Paris bound up with the Lectures on Light.]



THE WORK OF THE PHYSIOLOGICAL STATION AT PARIS.¹

By E. J. MAREY,
Member of the Institute of France.

Physiology has for its domain all organized nature. It seeks to penetrate the secret of life in all beings. It is the guide of natural history, which ought not only to describe the forms of animals and of plants, but also to ascertain the kind of life and the functions peculiar to each species.

The older naturalists understood that their science had this scope; the zoologists, for example, when they described the species of animals, noted at the same time the habitat, method of locomotion, kind of food, and manner of reproduction of each.

This way of studying and teaching the natural sciences was kept up so long as people were content to observe the exterior of animals and the external manifestations of their life; but, in proportion as the anatomy of living beings was more profoundly studied, the naturalist's task became harder; for a knowledge of the conformation of the different organs awakened a desire to understand the functions of each. From this moment a division of labor became necessary. Those who applied themselves more especially to the anatomical description of organized beings were called naturalists and those who specially studied the functions of life physiologists.

If such a separation were permanent, if the two parallel sciences were not united at certain points, both would suffer. Zoology would then be only a dry catalogue of animal forms whose meaning would be unexplained, while physiology, confined to laboratories and reduced to experimentation upon mutilated animals, would teach us less how these animals live than how to make them die.

Is it not possible to combine these natural sciences without hindering the development necessary for each? I wish to show you that this can sometimes be done and that it affords us the highest intellectual satisfaction, that of comprehending the marvelous harmonies of living

¹A lecture delivered at the College of France. Translated from *Revue Scientifique*, December 29, 1894, and January 8, 1895; fourth series, Vol. II, pages 802-808, and Vol. III, pages 2-12.

nature. In order to unite zoology and physiology it is necessary that these two sciences should have methods in common and should apply them under the same circumstances, which should neither be in the gallery of the zoologist nor in the laboratory of the vivisector.

During our epoch the natural sciences have made such progress as has quite transformed them. The physiologists of to-day use new methods and instruments of precision which enable them to study the phenomena of life with an exactitude formerly obtained only by physicists. This apparatus, first intended to be used in vivisection, is undergoing a gradual change and is tending to become applicable for use upon animals and to man himself while in perfect health and in the exercise of their normal functions.

On their side the zoologists, in addition to the menageries in which they bring together living animals of all kinds and all countries, have found, in the employment of the aquarium and in the establishment of maritime zoological stations, the means of observing in its natural surroundings the fauna of the sea and even that of fresh water. The moment seems to have arrived when the natural sciences may be made to profit by these two kinds of progress, and when we may direct toward a common end efforts too long divergent.

It is with this intention that the Physiological Station was established.

In order to show the resources of this institution and the developments it ought to have, permit me to first recount the evolution of the schemes of investigation for the application of which it was established.

I.

Daughter of anatomy, physiology was at first obliged to use the scalpel. It was while dissecting living animals that Asellius, Harvey, Charles Bell, and so many others made their grand discoveries. But the number of phenomena accessible to pure observation is necessarily limited, so physiologists had to borrow from the physicists their methods and their instruments in order to discover new facts. Thus the mercurial manometer was used by Magendie to measure the pressure of the blood at the different points of the vascular system; the delicate thermometers of Walferdin enabled Claude Bernard to show the unequal distribution of temperature in the organism, to recognize the effect which nerves have upon these variations of temperature, and to establish the foundations of a general theory of vasomotor nerves. M. Pasteur himself, whose discoveries have given a new impetus to physiology and medicine, would never have been able to support his doctrines by such weight of evidence had he not conceived and created new methods and appliances.

For many long years I have devoted my time to developing and perfecting physiological apparatus. Struck with the importance of movement in most of the functions of life, I wished to make it possible to

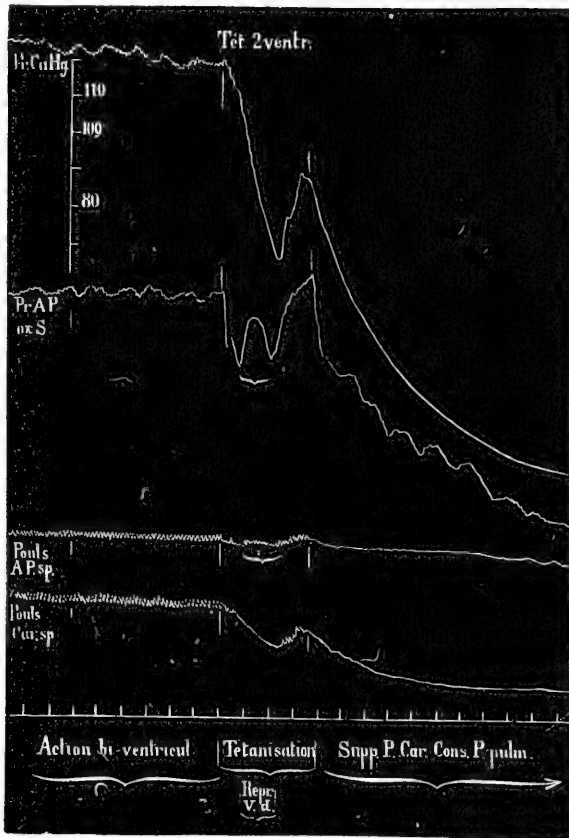

1



2

FIG. 1.—Simultaneous tracings showing the pressure of the blood and the arterial pulsations under the action of digitaline.

FIG. 2.—Tracing showing the diminution in the volume of a finger in consequence of the contraction of its vessels.

register and measure this fugitive phenomenon, and for that purpose I had recourse to the tracing apparatus which occupies to-day an important place in our laboratories. Thus M. François-Franck, who continues with so much talent my teaching at the College of France, makes much use of the graphic method. Those of you who follow his work have often seen him examine at the same time upon the same animal, seven or eight different vital movements, registering them by tracings placed one above the other so as to make apparent the reciprocal relations of all the phenomena that occur during the course of an experiment.

Fig. 1, Pl. XLVI, taken from the beautiful memoir of M. Franck upon the action of digitalin, is an example of these multiple registrations. The five tracings shown upon this plate are, from above downward, as follows: First, that of a mercurial manometer indicating the pressure of the blood in the carotid artery; second, that of another manometer showing the variation of pressure in the pulmonary artery; third, that of a sphygmoscope giving the pulsations of the pulmonary artery; fourth, that of another giving the carotid pulse; fifth, the lower line, giving, in seconds, the time occupied by the experiment. Reference lines traced upon this sheet show the effects produced at the same moment in the four tracings by a stimulus that causes a tetanus of the heart. A simple inspection of this figure teaches us all the variations that tetanus of the heart produces in the general and in the pulmonary circulation with a precision that the most attentive observation could not attain.

In a special work¹ I have described most of the tracing instruments, paying special attention to those which do not require preliminary vivisections, but record the action of organs by their exterior manifestations. We can thus, in both man and other animals, record the pulsations of the heart and arteries, the respiratory movements of the thorax and of the abdomen, the phases in the displacement of respired air, the contractions of the muscles, with the various degrees of force which they develop, the variations of caliber occurring in small vessels, etc. Modern physiologists pay particular attention to perfecting and multiplying these apparatus already so widely applied and of a much greater range of application than had at first appeared possible.

In fact this apparatus not only records the phenomena for which it was directly invented, but permits us to ascertain indirectly other facts. Thus the myograph, invented at first for recording the movement of muscles, makes known indirectly the velocity of the transmission of force in the motor and sensitive nerves, in the columns of the spinal cord, and even in the different layers of the cortex of the brain.

For the nervous acts of organic life, such as the contraction and relaxation of vessels, of which we do not even have any conscious knowledge, physiologists also possess a veritable myograph in the graphic apparatus that records the changes of volume of organs.

¹ *La Méthode graphique*: Paris, G. Masson, 1885.

Many improvements have been made in this apparatus during recent years. Quite recently two pupils of M. François-Franck, MM. Hallion and Comte, have conceived a small instrument very simple and easy of application. On introducing a finger between two air-cushions connected with a graphic apparatus it is seen that this finger constantly changes its volume, swells when its vessels dilate and diminishes as they contract. Any pain felt by the subject under experiment, a simple sensation of heat or cold, any emotion, even if slight, is soon followed by notable contraction of the vessels of the finger; that is to say, by a lowering of the curve that is traced. (See fig. 2, Pl. XLVI.)

We even find that in certain maladies an excitation not perceived by the subject may give rise to a vascular contraction, which shows that the seat of production of the vascular reflex is different from that of conscious sensation.

The possibility of transmitting to considerable distances by means of air tubes the movements it is desired to record has much enlarged the field of application of the graphic method.

Thus we may in the case of a running man or a galloping horse note the succession of footfalls or the cadence of the hoofs. In a flying bird we may record the various phases of the action of its muscles, the trajectory of a point of its wing, and the reactions thus effected upon the mass of its body. But these experiments, although very carefully made, give but a partial knowledge of the complicated acts of animal locomotion. Another method, more prompt and more simple, records these movements in a much more perfect manner. This is chrono-photography.

I had the honor two years ago to make known to you the origin and developments of this method. Since then I have improved it and applied it to the study of the most varied phenomena. All these applications have been set forth in a little volume recently published.¹ It will be sufficient to say that besides the phenomena of physics and mechanics, in which chrono-photography does most valuable service, this method enables us to analyze the kind of locomotion used by most species of animals, mammals, reptiles, birds, insects, fishes, etc. It may even be used to register the movement of microscopic creatures.

Chrono-photography may therefore be considered as the most perfect form of the graphic method. It is especially important when we have to deal with very extensive or complicated movements, or, indeed, when a movement has not sufficient force to actuate the tracer of an instrument.

A record of the mechanical forces developed by animals may be obtained by other apparatus, such as dynamographs, some of which measure efforts of traction, others efforts of pressure, and these, by the way, must, like balances, be more or less strongly constructed according to the amount of force to be applied.

In order to give a complete idea of the physiological apparatus we should also cite the instruments used to measure the electric currents

¹ *Le Mouvement*, Paris, G. Masson, 1894.

by which nerves and muscles are stimulated, or to determine the characteristics of the electricity generated by animals. The numerous improvements introduced by M. d'Arsonval in the determination of temperatures and the measurement of the calories generated by an animal according to its height, species, and the physiological conditions in which it is placed, should be here mentioned.

All these apparatus also tend to become registers, and this makes their indications comparable with each other and permits us to assemble in a single graphic table the curves of all sorts of phenomena. All tend likewise to be applicable to man and to animals under normal conditions without disturbing in any way the functions they are intended to investigate.

The zoologist, then, as well as the experimental physiologist, may investigate in different species of animals the variation of function in an organ corresponding to its variation of form. It is here, as I have before said, that union may be effected between the two sciences, long separated from each other.

II.

Physiologists and naturalists ought to seek not only unity of method, but also a favorable field for their joint investigations. The classical physiological laboratory is not well adapted to anything but vivisections, while space, open air, and unobstructed light are indispensable for the study of living creatures. It often happens that it is difficult to secure all the conditions necessary; it is hardly possible to study the physiology of insects except in the country; marine animals must be studied at some maritime station with all the necessary instruments.

It is, however, possible to set up near cities an experimental station fulfilling the principal conditions just noted. The Physiological Station is the first establishment of this kind; it already affords many resources not elsewhere found; and is, besides, susceptible of important developments that may be made from time to time as the need for them is felt. But in bringing this establishment to its present state many difficulties were encountered which it may be useful to briefly consider.

In 1864, at the time when the graphic method of recording certain physiological phenomena seemed sufficiently developed to permit an analysis of the different kinds of movements, I attempted to use it for determining the mechanism of locomotion in different species of animals. The movement of the wings of insects was quite easy to catch, and besides, the theory of this kind of locomotion had been established by a true synthesis, using artificial apparatus, in which a motion of translation was effected by agitating mechanical wings. This first success made me think that the problem of the flight of birds, the details of which almost completely elude direct observation, might be elucidated by the same method, and that tame birds to which suitable apparatus had been fitted would, when flying in an inclosed space, record the move-

ments of their own wings, together with the reactions which such movements produced upon their own bodies.

An artist's studio, No. 14 rue de l'Ancienne Comédie, furnished me the large room necessary for my purpose. This studio, 15 meters long by 12 wide and 8 high, was well lighted. It was easy to set up within it the workbench of a mechanic, cages for animals, and glass cases for the instruments, already so numerous, required for physiological researches. In this way, an old theater which had accommodated the Comédie Française in its early days, and was afterwards the studio in which Horace Vernet painted his great heroic pictures, became in turn a shelter for science, and was the first laboratory established by private enterprise for physiological experimentation.

Many advantages were already combined in this first establishment. They were certainly superior to those which I found later at the College of France when I entered it as professor. Much time is saved if the construction of the instruments, together with the incessant modifications of them required by this kind of experimentation, can be supervised in the same apartment in which the experiments themselves are conducted.

With carefully tamed buzzards, with pigeons, and with ducks, I succeeded in registering the movements of flight, the frequency and character of the wing strokes, the contraction of the muscles, and the reactions produced upon the body of the bird.

This study conducted me to that of the resistance of the air, which made it necessary to construct a whirling table 6 meters in diameter, in order to determine the pressure of air on different surfaces for different velocities of rotation.

This apparatus, also supplied with special registers, gives us an opportunity of analyzing the movements of walking in man, and was used in the beautiful experiments of my pupil and lamented friend, G. Carlet.

As might have been expected, the space was soon found insufficient for studying the locomotion of man. On a circular path 20 meters at most in diameter it was impossible to walk otherwise than slowly, incessantly hampered by the curve of the circle. Open roads were necessary for the study of walking and running, and horizontal or variously inclined footways were required for the determination, by means of the portable odograph, of the influences that cause variations in the cadence and length of steps. I often had to go far in order to find all the necessary conditions.

Later, attempting to determine the best means of utilizing the muscular force of man and animals, I had to compare the amount of work expended in the traction of carriages, both with rigid and slightly elastic traces, and upon different kinds of ground. In the neighborhood of the grounds of the Luxembourg there were certain avenues paved in different ways. I here experimented with carriages drawn at different

velocities, following them and carrying the registering apparatus, surrounded by an importunate crowd of curious people.

At another time, wishing to ascertain the effect which gymnastic training has upon the movements of the heart and on respiration, I had to transport my apparatus to the École de Joinville, to which M. Hillairet kindly offered me access.

Finally, in order to determine the succession of the movements of the horse, I had to go to the riding schools of Paris to find the means of making the necessary experiments.

The annoyance of shifting about so continually was but slight as compared with the grave disadvantages of carrying long distances delicate instruments whose slightest derangement made the journey useless. From that time I had but one desire, that of finding a spacious ground where I might unite a workshop, a laboratory, and an experimental field. I soon thought that my wishes were about to be realized.

In 1878, the Universal Exposition had just been closed, and General Farre, then minister of war, who was interested in my experiments on the gaits of men and horses, offered to place at my disposal some ground in the Champ de Mars which was in a few months to be turned over to the war department. This was the large space where now stands the Eiffel Tower. An officer of engineers examined the place and at the end of a few weeks sent me a plan showing a perfectly level circular track 500 meters in circumference, passing through the groups of trees there planted, and touching the edges of the two lakes. At certain times of the day this track was to be given up to experiments. I yet have this plan which gave me a certain transitory joy. In a few weeks it happened that by a certain arrangement between the General Government and the city the grounds were assigned to the latter and I thought for a time that all was lost.

But the municipal council of Paris, which has given so many proofs of its interest in science, was soon to gratify my wishes beyond my hopes.

Upon the motion of its president, M. de Hérédia, the municipal council placed at my disposition a spacious ground at the Parc des Princes, and voted an annual allowance of 12,000 francs to maintain the new establishment. The General Government on its part, upon the request of M. Jules Ferry, granted the sum necessary for the construction of the buildings. Finally, to add to these resources, I transferred to the new locality the laboratory for advanced studies which I had been conducting at the College of France, as well as all the apparatus and instruments that I had made during more than twenty years.

Such was the origin of the Physiological Station, which is already known to many of you. Those who may do me the honor to visit it will not find there monumental constructions, but slight buildings which during the summer season admit of the employment of a considerable number of workers and are arranged for all sorts of studies.

I have there been able to resume, under new and quite exact conditions, my studies of the flight of birds, experimenting upon a great number of different species. By means of chrono-photography it has been possible to obtain a series of the successive phases of a wing stroke in the form of instantaneous photographs, as many as one hundred per second being recently obtained. Thus, in a wing stroke so rapid that the eye can not follow it, the apparatus shows with perfect precision more than twenty successive phases, passing from one to another by almost insensible transitions.

The gaits of the horse have been determined, not only as regards the successive beats of the feet, but in a complete manner; that is to say, by fixing the entire series of actions and reactions that are involved.

The great circular and perfectly level track permits us to analyze the walking and running paces of man as well as his various physical exercises, and to determine the conditions most favorable to the proper utilization of muscular force. These studies have been conducted with regard to their practical application, either for the amelioration of the condition of the soldier or for the improvement of the methods of physical education. In these researches I have been greatly aided by the officers of the army and by my former assistant, M. Demeny, who, up to recent years, performed his duties with much skill.

I would not speak of the experiments made at the Physiological Station on a great many physical and mechanical phenomena, such as the fall of bodies, the resistance of the air, the vibrations of strings, the movement of liquids, the measurement of forces and of work, etc., were it not that these studies are intimately connected with the physiology of movement.

In fact, in the locomotion of man and of terrestrial animals the mechanical actions of the muscles consist in displacing the center of gravity of the body, either by lifting its weight or by imparting to it a movement of translation. From these actions in various directions we can deduce the amount of work expended. In aerial locomotion the action of the muscles communicates a similar amount of movement, both to the body of the animal and to the mass of air struck by the wings. The same division occurs in different kinds of locomotion upon the ground and in the water.

The experiments already made at the Physiological Station have given the approximate value of the work expended in the different kinds of locomotion. These determinations have been checked by two different methods; on the one hand, by measuring the forces and the quantities of movement by means of registering dynamometers; on the other, by estimating the forces acting at each moment by the acceleration imparted to the mass of the body.¹ The results derived from these two sources show variations of but slight importance, that will certainly disappear when the methods of analyzing movements and forces shall be perfected.

¹ See *Le Mouvement*, Chapter IX.

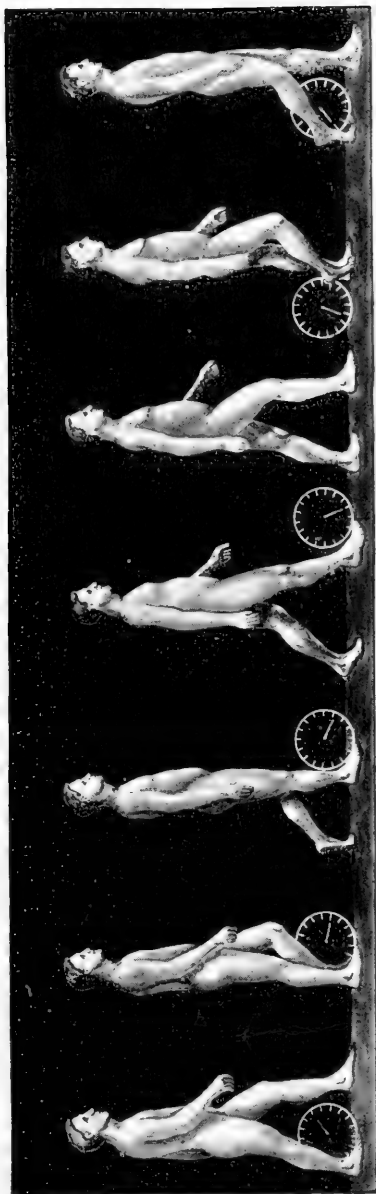

SUCCESSIVE PHOTOGRAPHS OF A PERSON WALKING, DONE BY CHRONOPHOTOGRAPHY UPON A MOVABLE FILM.

The order is from left to right. The interval of time occurring between two successive positions may be read upon the chronometric dial whose divisions correspond to $\frac{1}{4}$ of a second. Its needle turns in a direction opposite to the motion of the hands of a watch.

1
2
3
4
5
6
7
8
9
10
11
12
13
14
15
16
17
18
19
20
21
22
23
24
25
26
27
28
29
30
31
32
33
34
35
36
37
38
39
40
41
42
43
44
45
46
47
48
49
50
51
52
53
54
55
56
57
58
59
60
61
62
63
64
65
66
67
68
69
70
71
72
73
74
75
76
77
78
79
80
81
82
83
84
85
86
87
88
89
90
91
92
93
94
95
96
97
98
99
100



1



2

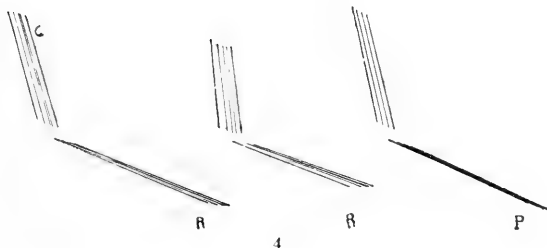
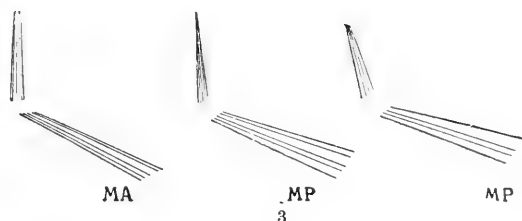

FIG. 1.—Arrangement used to determine by chronophotography the movements of the lower jaw.
 FIG. 2.—Successive positions of the lower jaw during the opening of the mouth.
 FIG. 3.—Movements of the lower jaw during mastication on the incisors, MA, and on the molars, MP.
 FIG. 4.—The lower jaw drawn backward, RR, and pushed forward, P.

At any rate these experiments have clearly shown that muscular forces behave in their final result like other mechanical forces.

New problems are now placed before us; let us examine them.

III.

The analysis of the movements of man and animals may be made from different points of view. It is, indeed, not sufficient to determine the external characters of the movement; the important matter is to ascertain the mechanism by which that movement is effected and to distinguish the part played by the different portions of the locomotor apparatus, muscles, articular surfaces, and osseous radii.

To adapt it for these different researches chrono-photography may be employed in different ways,¹ sometimes using a movable plate and sometimes a fixed plate.

When it is wished to record the movements as a whole, it is necessary to use chrono-photography on a movable plate, for it gives a series of entire images of the subject in action. Thus Pl. XLVII, which shows seven different attitudes of a person taking a step in walking, gives the necessary information concerning the velocity and the extent of the displacements of the body and the limbs as well as the state of contraction or relaxation of certain muscles shown in relief under the skin. But in order to be well understood these independent images should be placed in their relative positions, and this is done by means of a series of successive tracings, examples of which will shortly be given.

This laborious and delicate operation makes the analysis of movement a long process; this may, however, be shortened in certain cases. It was just because I wished to get, at a single exposure, a photographic outline of a movement that I conceived the idea of chrono-photography upon a fixed plate. With this method it is true the images of a moving man or an animal are reduced to a few brilliant points and lines, but this is generally sufficient to mark the action of the limbs in the different gaits.

It is not only in locomotion properly so called that movements occur that are of scientific interest; mastication, respiration, speech, expression of the countenance, partial movements of the limbs, hands, or feet are of no less interest.

Suppose, for example, that it is desired to ascertain the movements of the lower jaw by chrono-photography on a fixed plate.

The teeth of the lower jaw, first well wiped, are placed in one of those metallic molds full of wax, which dentists use for taking impressions. Upon this solid base there is fixed a bright metallic rod (fig. 1, Pl. XLVIII), whose angular curvature exactly follows that of the lower jaw. This rod, placed outside of the jaw, shows clearly upon a small piece of velvet that forms for it a dark background (fig. 2, Pl. XLVIII).

¹ See *Le Mouvement*, Chapters IV and VII.

If a series of successive photographs is taken upon a fixed plate during the act of opening or closing the mouth, the figure thus obtained gives all the positions successively occupied by the bright rod, and consequently all the displacements of the lower jaw itself. Now it will be seen that, by reason of the sliding of the condyles of the jaw in the glenoid cavities, the center of movement is found very low upon the ascending ramus near the angle (fig. 3, Pl. XLVIII).

In movements of mastication this line takes different positions according as we chew upon the incisor or upon the molar teeth. It has still other movements during speech or in displacement of the chin either forward or backward (fig. 4, Pl. XLVIII).

In these experiments chrono-photography gives us a true sketch of the movements, and as the length of the bright rod is exactly equal to that of the lower jaw its end traces out exactly the form of that part of the glenoid surface upon which the condyle slides. This experiment already shows us the necessary interdependence between the forms of organs and the forms of movements. It would be curious to follow out in a series of animal species this anatomo-physiological parallel.

It should be noted that these experiments were made under very simple conditions and that it was not necessary to use the chrono-photographic apparatus.

In this case it was of but little importance to find the velocity and phases of movement of the lower jaw; it was only desired to determine the successive positions of the jaw at the different degrees of opening the mouth, a perfect equality in the intervals of time separating the different images being unnecessary. Besides, these experiments were made in winter, with a diffused and quite feeble light, a long exposure (about one-fourth of a second) being necessary. The procedure was as follows:

An ordinary photographic apparatus provided with a pneumatic shutter was trained upon the subject of experiment. This subject having his head firmly supported from behind so as to fix it, opened his mouth at several successive degrees of wideness, stopping an instant after each, so that a photograph might be taken. The figure thus obtained differs in no respect from that which the chrono-photographic apparatus might have given, except that the intervals separating two successive images are arbitrary.

When it is wished to determine the trajectory of a point, an ordinary photographic apparatus is also sufficient. In this case the shutter is held open during the entire movement, and if the point is brilliant and shown upon a dark background it traces its trajectory in the form of a continuous line. It is in this manner that I was able to determine the character of the movement of the atlas upon the axis, according to the trajectory made by a brilliant point fixed upon the occiput.

The movements of the ribs during respiration are determined in a similar manner. These movements are very complex because of the



1



2

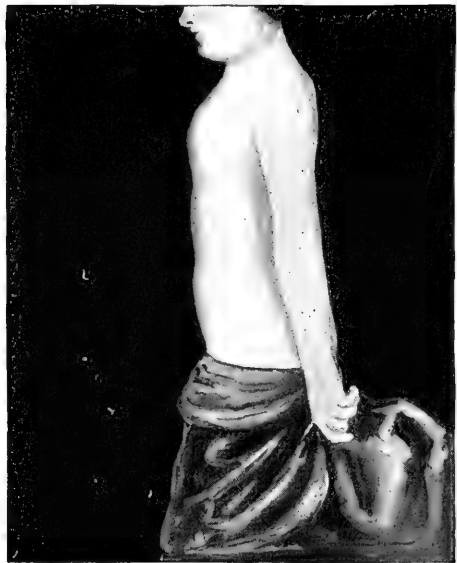

3

FIG. 1.—Arrangement used to determine the trajectory made by the lateral movement of the ribs.
FIG. 2.—Arrangement used to determine the trajectory of the different parts of the anterior surface of the thorax.
FIG. 3.—Type of respiration in a woman without a corset.

curvature of the ribs, the unequal flexibility of their cartilages, and their multiple articulations both with the bodies and transverse processes of the vertebræ and with the sternum and costal cartilages. Without points of reference observation of the movements of the ribs was absolutely impossible; the nature of these displacements has therefore been heretofore determined according to certain theoretical considerations. Experimentation gives, on the contrary, very exact results.

A series of small, black rods (fig. 1, plate XLIX) presses loosely upon the walls of the chest, each resting upon a rib by one of its extremities and bearing near this point a very brilliant pearl. An ordinary photographic apparatus is turned toward the subject of experiment, who, strongly illuminated, is placed before a black background. If the exposure lasts during the entire respiratory movement we obtain fig. 1, in which each of the brilliant pearls has traced the movement of the subjacent rib. At the first glance it is seen that each rib has its own special movement.

This is not the place to analyze the mechanism of this movement. I may say, however, that among the divers opinions which have been held by authors that of Chabry accords the best with the results of the experiments.

If it is required to know the nature of the movement of the anterior wall of the chest, we apply upon that wall the series of rods and obtain the trajectory of each of the points of that wall from the epigastrium to the superior part of the sternum. We then see that the epigastrium has but a slight upward movement, while the sternum moves obliquely upward and forward.

Similar researches repeated upon different species of animals would doubtless give interesting results as to the comparative physiology of respiration considered from a mechanical point of view.

Another very important study is that of respiratory types. It has been supposed that women breathe especially by means of the upper part of the thorax (superior costal type), and men by the diaphragm (abdominal type). Hutchinson has shown these two types by tracing on a wall the silhouette of a man and that of a woman in the two extreme states of inspiration and expiration. But the hand has not time to trace the profile of the thorax and of the abdomen during the few instants in which inspiration reaches its extreme limits; besides, if the subject stops his respiratory movements a moment, nothing proves that the thorax and the abdomen keep the respective positions which they had in normal respiration.

Photography replaces with advantage the tracing of the silhouettes. An ordinary apparatus provided with a pneumatic shutter is trained upon the subject. A picture is taken during inspiration, another during expiration, and we thus obtain a double contour for all parts of the trunk displaced. We thus show that in a woman without a corset respiration occurs as it does in a man—that is to say, that the thorax and the abdomen both take part in it.

Not only does chrono-photography afford a means of studying the kinematics of movements, it also furnishes an indication of the work performed in certain muscular acts.

A distinguished engineer, M. Frémont, has just made at the physiological station a study of the work performed in hammering iron upon an anvil. On a movable film M. Frémont took the series of attitudes assumed by the blacksmith in the successive movements given to the hammer.¹ By chrono-photography on a fixed plate there was shown the trajectory of the hammer and its successive positions at definite instants, the intervals between which were measured by a chronographic dial.

By such a figure we can estimate the forces acting upon the mass of the hammer at each instant by means of the acceleration given to that mass. We also obtain a measure of the work, since it shows the velocity of the hammer at the moment it is about to strike the iron.

In most physiological acts forces and work should be measured by another method—that is to say, by the dynamograph. I have described under the name of dynamographs certain instruments that show the forces of pressure or traction applied to them by means of a stylus that traces the curve of variations of these forces.² I have also shown how the results obtained from these instruments may be synchronized with those obtained from chrono-photography, so that we may know at each phase of a footfall, for example, what force the foot exerts upon the soil in a vertical direction. If a traction dynamograph indicates the force developed by the same act, we may by combining these different data obtain all the information necessary to understand the mechanism of locomotion in different animals.

The number of experiments necessary may seem to you excessive, but the invention of methods, the care required to secure their precision, their first application to the analysis of movements and to the measure of forces constituted the most arduous part of the task. Already our records accumulate; the field of possible comparisons enlarges every day, and at the same time the interest in anatomophysiological comparisons increases. I wish to give you some examples of these comparisons.

IV.

If we wish to study locomotion in different types of mammals so as to elucidate the variety of their forms by the special movements characteristic of each we must first ascertain all the anatomical and physiological elements necessary for such a comparison.

Drawings and plates will not suffice as anatomical material. It is necessary to use natural organs, skeletons, articulations, preparations, or casts of muscles. Now, thanks to the ready assistance of various

¹ These studies will shortly be published by M. Frémont.

² See *Le Mouvement*, page 142.

anatomists, I have been able to collect a portion of the specimens necessary for the study of certain common species of mammals.

I have also been able to collect, in the physiological department, chrono-photographs and sketches of the movement of the same species.

Plates L and LI show a series of thirty-six photographs of a dog taken while making a step. For such a slow gait the number of pictures is greater than necessary, for a more rapid one all would be required. In the present case it will be sufficient to compare every four pictures to follow the phases of the movement. As the chronometric dial is used to measure the intervals of time between two successive attitudes, so the space passed over by the animal is measured by a mark fixed in the ground. This mark consists of a small white rod set up on the course. At the commencement of the experiment the dog is behind the rod, at the end he has passed it. The actual distance traversed is read off upon a metric scale.

Plate LII shows a sheep walking. The number of photographs is reduced to nine, and the time between the first and last, as shown by the chronometric dial, is twenty-five sixtieths of a second. The progression of the animal is estimated by his approach to the chronometer.

To obtain these pictures a dark background is used. This is not necessary when a movable film is employed; then a light background will answer, as shown in plate LIII, which represents a galloping horse. As this was quite a long series, it was not possible within the space of a column of text to show the entire set of movements; about half are shown from the moment when the horse leaves the ground to that when the two diagonally opposite feet are on the ground.

It is sometimes desirable to take pictures of an animal from different aspects; chrono photography upon a movable plate is easily adapted to such work. It is possible to follow in any gait of an animal the series of movements of his limbs.

But the dimensions of the pictures obtained by printing from the original negatives are too small to be directly utilized. Arrangements must be made to more easily examine and measure the displacements made by the different portions of the same limb during the step of any gait. For this we proceed as follows:

We commence by enlarging by means of a projection apparatus each of the little images which we wish to compare. Plate LIV shows one of these enlargements. It is limited to five diameters, so as to accommodate the page, but it is better to nearly double those dimensions.

If we wish, for example, to study the movement of one of the hind legs we trace the contours of that leg on a sheet of transparent paper, using as guides in applying this paper to the picture the line of the ground and a fixed point upon that line. Having traced the first image of the series we proceed to the second, placing the transparent paper exactly over the guides, and thus obtain (fig. 1) the series of successive positions occupied by the hind leg of a horse while walking, from the first raising of the foot to its final return to the ground.

In this representation of attitudes the leg is supposed to occupy successive planes superposed upon each other, so that the last image covers partially those which precede it. The contours covered by the following image are represented by dotted lines.

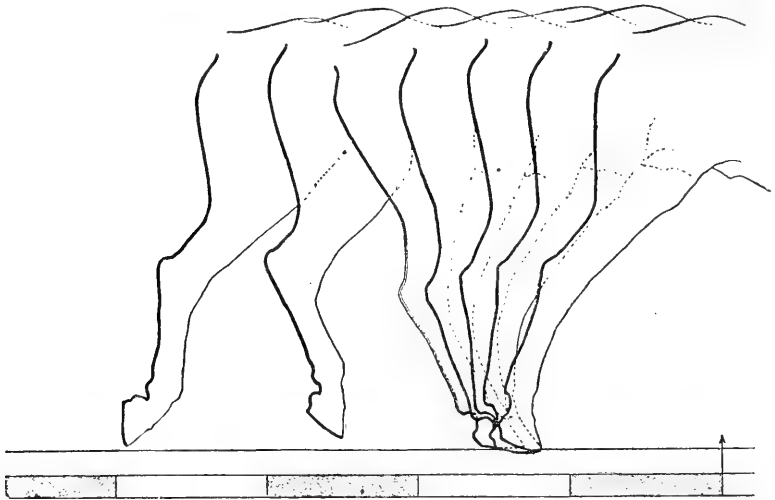

FIG. 1.—Attitudes and successive positions of the right hind leg of a horse during a step in walking.

Repeating this same operation for another species of animal, we obtain (fig. 2) the series of attitudes of the hind leg of a dog walking, and (fig. 3) a similar series for a sheep. In these last two figures an attempt has been made to represent by dotted lines the contours of the

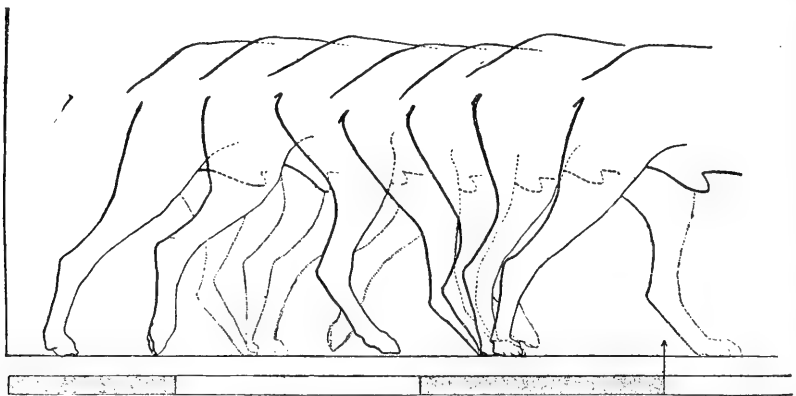
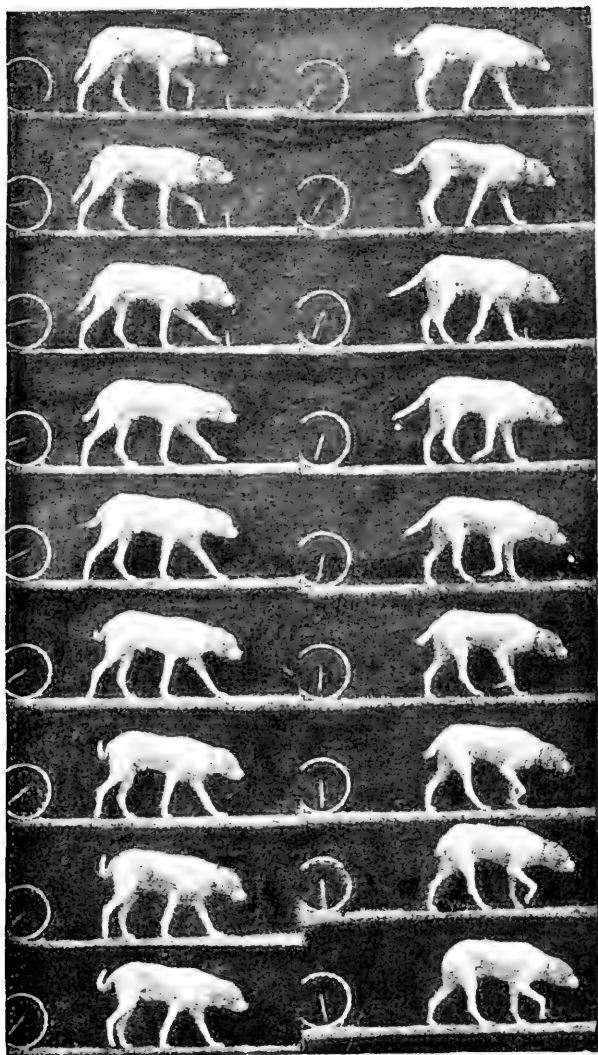

FIG. 2.—Attitudes and successive positions of the right hind leg of a dog during a step in walking. The dotted lines show the positions of the left hind leg.

left hind leg, so as to show the alternation of movements between the two legs.

At the first glance it is seen that in different species of animals the length of the step in relation to the height is very different. This inequality is much greater in rapid gaits and in certain animals of small stature.



DOG WALKING; 36 PHOTOGRAPHS TAKEN DURING A SINGLE STEP.

The first is at the upper left-hand corner, 1st column, Plate L; the last at the lower right-hand corner, 4th column, Plate LI. Total duration of the step, $\frac{3}{55}$ of a second.

(See also Plate LI.)

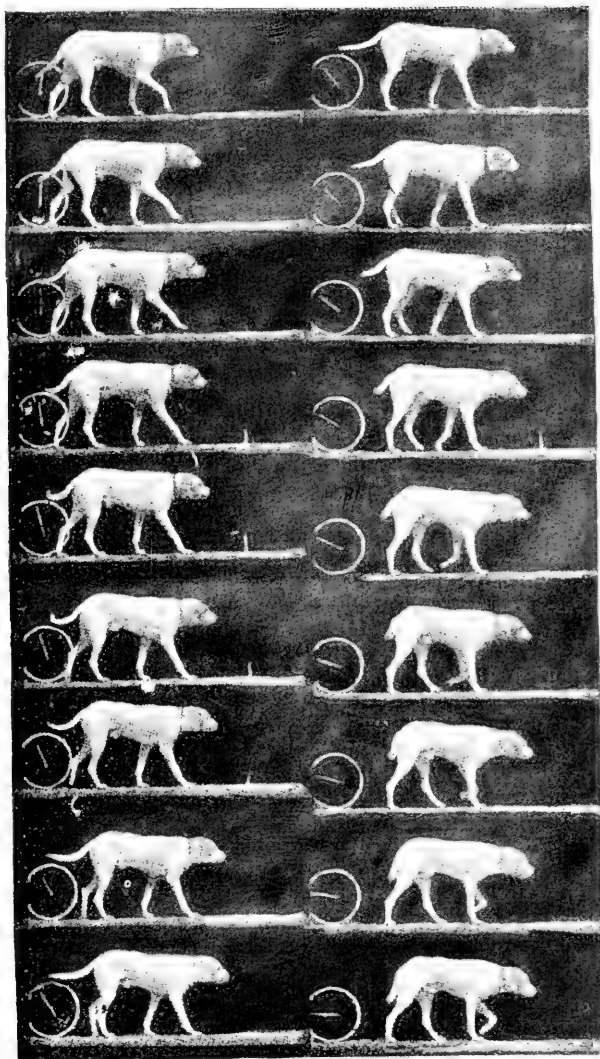

DOG WALKING; 36 PHOTOGRAPHS TAKEN DURING A SINGLE STEP.

The first is at the upper left-hand corner, 1st column, Plate L; the last at the lower right-hand corner, 4th column, Plate LI. Total duration of the step, $\frac{1}{10}$ of a second.

(See also Plate L.)

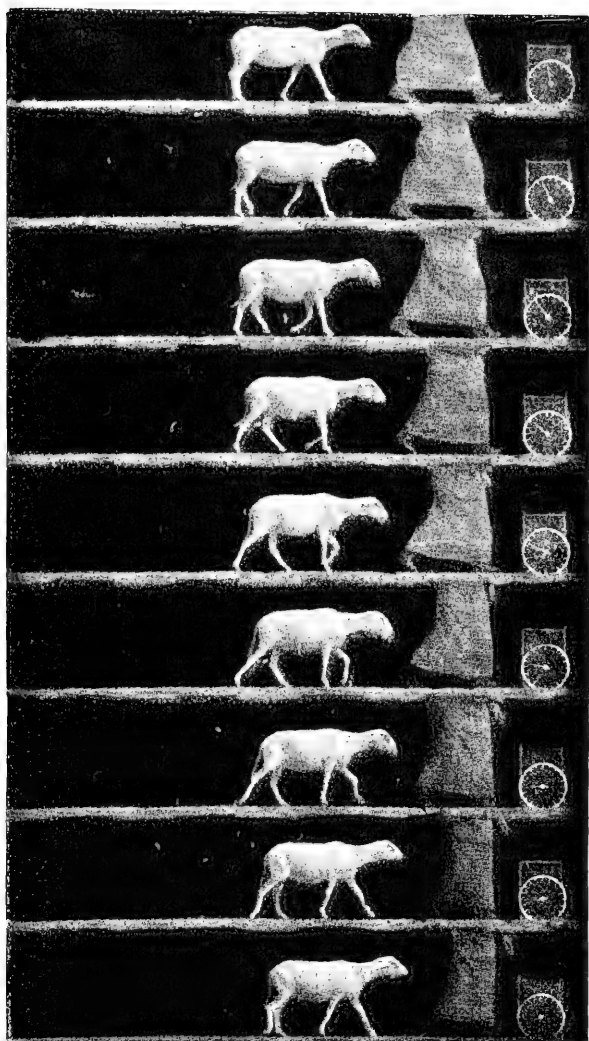

SHEEP WALKING.

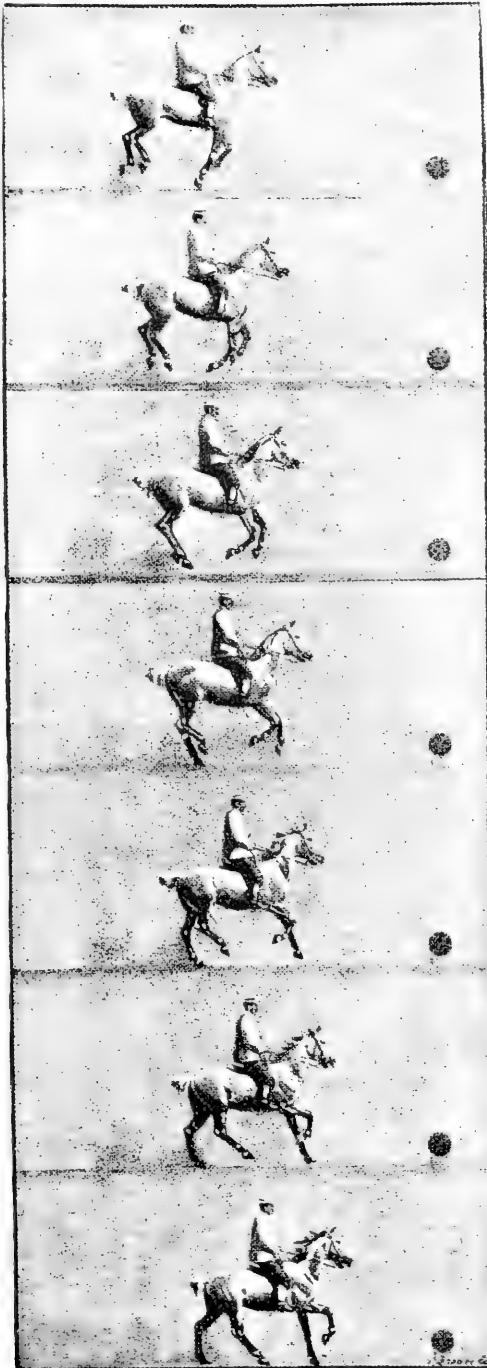

HORSE GALLOPING.

The figures follow from above downward.

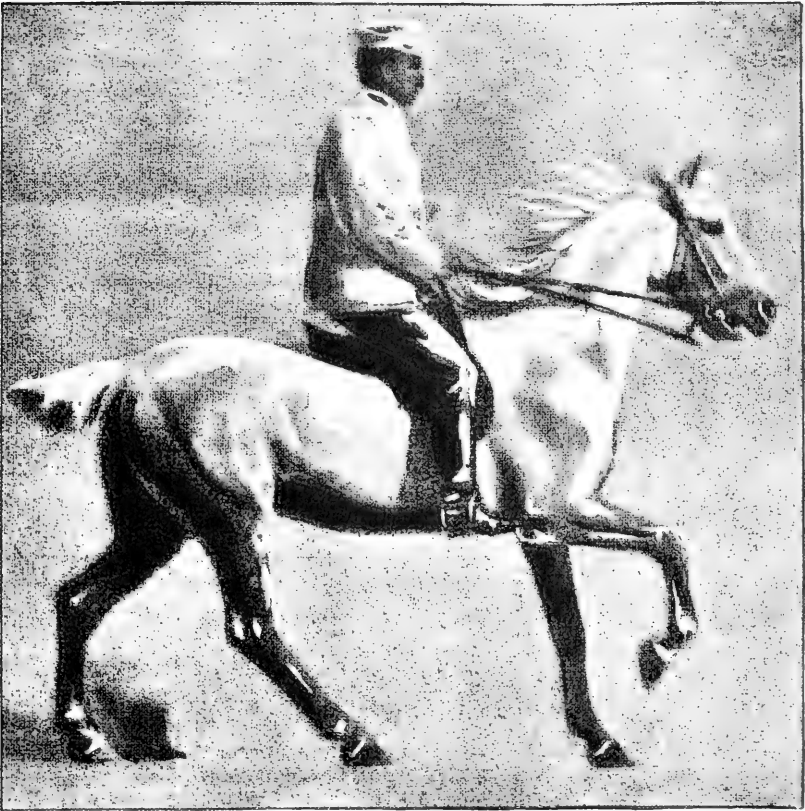

PHOTOGRAPH OF A GALLOPING HORSE ENLARGED TO 5 DIAMETERS.

The picture enlarged is the last one of Plate LIII.

But I can not enter into detail regarding these special comparative studies which show analogies and differences between various species of animals in accordance with their anatomical structure.

The absolute fidelity of these chrono-photographic outlines allows us to estimate the value of certain analyses of the movements of limbs made by different authors. The most exact are certainly those of Vincent and Goiffon. We can not too greatly admire the sagacity of these authors who have given so faithful a representation of the movements of the horse in slow gaits.

Finally, these same pictures permit us to determine the action of certain muscles at different phases of the gaits. By starting from the successive attitudes of the limbs we reach the physiological mechanism of the movements under consideration.

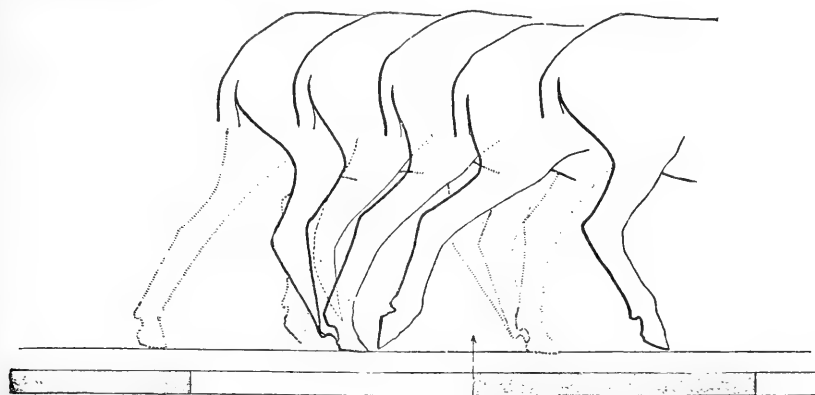

FIG. 3.—Attitudes and successive positions of the right hind leg of a sheep during a step in walking. The dotted lines show the positions of the left hind leg.

The sagacity of physiologists has often been tried by these obscure questions. Maissiat¹ more than anyone else has attempted to elucidate the part played by muscles in the walk of man. He has done in this respect all that can be done by subtle observation joined to a profound knowledge of the laws of mechanics.

But in questions of this kind the keenest intelligence can not attain the precise results that are obtained by an exact method. Already, by using localized electrization, Duchenne, of Boulogne, has shown in man the special functions of the individual muscles; he has shown that in the various acts of locomotion the muscles are associated by groups, synergistic or antagonistic, and that each movement is a resultant of these combined forces.

More powerful methods allow us to now elucidate these questions.

Upon the photographs of an animal in motion we may mark the origin and insertion of muscles which we have learned from our anatomical specimens, and, joining these insertions by one or more marks,

¹ Jacques Maissiat, *Études de physique animale*, 4^o, Paris, 1843.

we will have for each attitude of a limb the length shown by each muscle visible in the figure under consideration. We can easily follow upon the series of photographs the phases of the shortening or lengthening of these muscles—that is to say, their contraction or their relaxation. We may finally trace the curve or change of length of these different muscles according to time, and compare the relations which exist between certain muscular acts and the reactions imparted to the body of the animal.

As soon as we know the action of the different muscles during the different phases of movement of an animal, we shall have the greater part of the data necessary for understanding the mechanism of locomotion. Now, this knowledge can not be acquired by simple observation, for the most sustained attention concentrated on the action of a single muscle, can with difficulty catch the phases of activity and of repose even for the slowest gait. How, then, can we hope to catch the action of all the muscles of the limbs at all phases of a rapid gait?

Such is the general plan for the study of comparative locomotion which I have just undertaken. This long task is as yet but little advanced, but the results which it promises are worth all the efforts which it will cost.

V.

Certain minds value science only for its practical application. To such we may recall what the Physiological Station has already done and show what it may be expected to do. The physician may seek there new means for the diagnosis of certain maladies and for investigating the effects of their treatment; the soldier may study there the proper regulation of marching so as to diminish fatigue and use to greater advantage the bodily forces; the educator of youth may learn how to logically direct gymnastic exercises; the artist, how to represent more truthfully the scenes that he wishes to depict; the agriculturist, how to use to the best advantage the strength of animals; the artisan, how to more quickly acquire the skill necessary for his professional labors. It seems that the utilitarian side of physiology has up to the present time been the best appreciated.

But science has also other functions; it gives a lofty satisfaction to the mind by causing us to comprehend the marvelous harmonies of nature. The astronomer who knows how to calculate the movement of the stars, to measure their distance, estimate their masses, and even determine their chemical composition, must have a more lively intellectual pleasure than the ordinary contemplator of the starry vault. There is no doubt that zoology and physiology, mutually elucidating each other, give us a grander conception of the animal kingdom by showing its action in all its beauty.

I imagine that this evolution of the natural sciences will be effected, as may be said, of itself, by the patient and methodical collection of

anatomical facts and experimental determinations. And since we are considering here only the comparative physiology of animal locomotion, I believe that it is easy to point out the successive stages which ought to lead to this result.

First, the animal forms should be grouped according to the type of motion peculiar to them, so as to bring into notice their general anatomico-physiological relations. This we have now begun to do, and it is already evident that many of these relations depend upon ordinary laws of mechanics. These relate to muscles, bones, and articular surfaces. As regards this I can only summarize here what I have given elsewhere with more detail.¹

The relation existing between the form and the functions of muscles is as follows: The extent of the movement of a muscle is in proportion to the length of its red fibers; its force is proportional to the cross-section of such fibers; the work it can perform is proportional to its weight.

These relations, the first of which was established by Borelli, can easily be verified upon the muscles of a single animal. They explain also why, in two different species, homologous muscles have different anatomical characters; it is because the functions of the muscles differ in the two species.

It will be seen that in order to carry further the anatomico-physiological relation it will be necessary to determine with great precision the functions of each muscle and the peculiarities of its movements; it is precisely for that purpose that the experiments have been undertaken which I have cited above.

The form and length of the bones correspond to that of the muscles attached to them, and to which they seem subordinated, as is shown by the beautiful experiments of Fick; the configuration of the articulations shows the character of the movements which they permit.

Let us consider, for example, the form of the head of the humerus in different animals. We see that it has a spherical curvature in man, monkeys, and lemurs, in which animals movements in every direction are allowed; that it is cylindrical in ruminants and pachyderms whose anterior limbs move backward and forward, parallel to the axis of the body; elliptical in birds whose wings move with unequal amplitude in two directions perpendicular to each other. It is impossible not to see that there is, between the form of the articular surfaces and the movements, a necessary relation which permits us, when we know the characteristics of the movement, to predict what will be those of the organ, and vice versa.

A long habit of comparing with each other the skeletons of different animals enabled Cuvier to recognize among the different bones of an animal certain relationships which he called the subordination of characters. A bone of a certain form implied the existence of certain

¹ La Machine Animale, Chapter VIII.

characteristics in the other pieces of the skeleton. Our great naturalist could therefore, to repeat an expression that has become classical, restore from a single bone the entire skeleton of the animal to which that bone belonged.

Without the long practice of a Cuvier, we may, by taking for our guide anatomico-physiological relations, arrive at determinations of a similar kind which may seem astonishing to those who do not know the theory by which they are reached.

I have shown that it is sufficient to see the wing of a bird, or even the bones of the forearm of that wing, to deduce the dimensions of the sternum.¹ These relations have not, as far as I am aware, been indicated by anatomists. They are as follows: Birds with small wings have the sternum long and narrow; those with the large wings have that bone broad and short. This relation is easy to verify on the skeletons of birds in zoological collections. The considerations which led me to predict this are as follows:

In watching the flight of birds it is seen that large-winged species have wing beats of but slight extent. This is because the large surface of their wings finds a strong resistance in the air. Species that have but little wing surface have, on the contrary, wing beats of great amplitude in order by motor work and by the length of the path described to make amends for the feeble resistance. Having such dissimilar movements, these two kinds of birds ought to have corresponding differences in the great pectoral muscles that lower the wings. In the first these muscles are large and short; in the second, long and slender. But the sternum, in the lateral fossæ of which these muscles are inserted, must correspond in its form to that of the muscles themselves. It must therefore be broad and short in the first type of birds, long and narrow in the second. All sorts of intermediate forms exist between these two extremes.

A comparison of the skeletons of birds shows that it is really so. Still, gallinaceous birds seem to offer an exception to the rule; they have a sternum too short for the small surface of their wings. But in these species the great length of the coracoid bones really prolongs the sternum, so that the exception to the general rule is only apparent.

The same kind of relations led me to predict, from the conformation of the muscles of the calf, a curious peculiarity of the skeleton of the negro. Comparing the calves of the negro with those of the white man it is seen that in the first the gastrocnemii are much longer and more slender, which allows us to conclude that the muscles have less force but more range of motion in the black race. Now, to get the same results of work expended in walking, it is necessary that the muscles should act upon a longer lever; or, to state it otherwise, that the distance should be greater between the end of the calcæneum and the center of movement in the ankle joint. Measurements show that this predic-

¹ La Machine Animale, Chapter VIII.

tion is correct; the difference in the length of the calcaneum in the two races is enormous, the ratio being as 7 is to 5.

The constant examination of the physiological relations existing between the form of the locomotor organs and the type of locomotion in the different species of animals is the directing idea of the studies that are pursued at the Physiological Station. There is no doubt that every advance in our knowledge of the movements of locomotion will bring out more clearly the perfect harmony that exists between an organ and its function.

VI.

I have tried to show by examples the happy effect of a union between comparative anatomy and physiology. Anatomy alone may reveal certain unexplained relations between organs—the law of the subordination of characters is of this nature—but the law of harmony between organs and their functions is deduced from acquaintance with the physiological activities of each part of the body; it does not content itself with simply stating the fact, but explains it, and thus completely satisfies the mind.

This is not yet all. Naturalists have always sought to ascertain how the conformity between an organ and its functions is actually brought about. From this research originated the doctrine of final causes which has, in our days, been replaced by more satisfactory hypotheses tending to show that the different types of animals have been evolved during the progress of ages by the action of forces effecting a closer and closer adaptation to the varying conditions in which they are placed. This is the doctrine of transformism or evolution.

But how shall we explain, in its turn, this evolution by the action of natural forces? Certain zoologists, like Buffon and Lamarck, admit that exterior influences may, in a more or less direct way, induce modifications of organs; others, such as Darwin and Wallace, hold that certain variations are transmitted by heredity when their effect is such as to better adapt the beings that possess them for living in the conditions in which they are placed, and to better fit them to resist agencies that cause their destruction.

Twenty years ago, in discussing these two hypotheses,¹ I ventured to hope that experimentation might decide this question, or at least assign an equitable part to the different factors of evolution. The eminent surgeon, J. Guérin, struck at seeing, after luxations, a tendency to the formation of a new joint with cartilages, synovial membrane, and ligaments, said "Function makes the organ." This aphorism expresses the ideas of Lamarck and Buffon; certain pathological cases amount, indeed, to actual experiments, and show that, in a living being, mechanical forces may bring about an adaptation of organs resulting in a change in their functions.

¹ *La Machine Animale*, page 105.

Guided by certain theories it occurred to me that the muscular system might also be modified and the form of a muscle changed by altering the range of its movements. The result, as we shall see, has confirmed my anticipations.

Let us take up again the well-marked example of the unequal length of the gastrocnemii muscles in the white man and in the negro. If the white man, as we have said, has the shorter calf, it is on account of the shortness of his calcaneum. Suppose that the length of the calcaneum in an animal is diminished. If the muscle adapts itself to the new conditions of work it ought to diminish in length.

The rabbit is well adapted for such an experiment. It has a very long calcaneum, and consequently the extensor muscles of the foot have very long, red fibers. I resected in a rabbit a third of the length of the calcaneum, and placed the limb operated upon in a plaster cast until the bone was entirely united. The animal was then set free in a large yard, where soon it was running about with as much agility as its companions. At the end of a year the rabbit was killed and it was seen that upon the side operated upon the muscles had become modified in accordance with the theory. The red fibers were reduced to about a third of their length and replaced by tendon. A comparison of the sound limb with that operated upon showed this change in a striking manner.

I made an experiment which was the converse of this by an operation upon a kid. In this species only the ungual extremity of the foot strikes the ground, and the calcaneum, always raised, moves but slightly in walking. The resection of this bone had, therefore, but little effect either upon the mode of locomotion of the animal or upon the character of its muscles.

Finally M. W. Roux has given numerous examples of the modifications of the muscles of man after partial anchyloses which reduced, more or less, the range of movements. He has shown in a great number of autopsies a diminution in the length of the red fibers and their replacement by tendon. This diminution in length was always proportional to the reduction which had occurred in the range of movement.

The adaptations of muscles to mechanical conditions experimentally created by mutilations is then well established. It is more than probable that similar adaptations may be obtained in the length of the muscles of animals by placing them in conditions where they would be forced to make movements more extensive than those of their normal life, by obliging them, for example, to leap or climb to get their food. I will shortly cite some facts of this kind.

But even if it is shown that in an individual the muscles and the skeleton become adapted to conditions of work, this would not be sufficient to explain transformism. It is, in fact, necessary, in order to cause a variation of species, that the modification acquired by individuals should be transmitted to their descendants by heredity.

Now, except in certain rare cases, the effects of the mutilation of peripheral organs are not transmitted to the offspring. But it is not the same with lesions that affect the nervous system. This fact has been well established by the experiments of Brown-Sequard. In guinea pigs this eminent physiologist saw curious deformations of the limbs and exophthalmia produced as a consequence of nervous lesions; and these modifications may be transmitted hereditarily throughout a long series of generations. It seems that in such cases the traumatism has affected function at its very origin; that is to say, in the organ placed at the head of the physiological hierarchy.

There is, indeed, an evident subordination among the different parts of the organism; the nervous system conceives acts and directs them to be carried out; the muscles perform these acts; the bones and the articulations bear the strains. May we not suppose that some new exterior circumstances excite in an unaccustomed manner the nervous system of an animal so that new conditions bring about new acts and consequently lead to a modification of organs? The modifications thus produced would be transmissible by heredity as in the experiments of Brown-Sequard. We might thus explain the transformation of animals during the lapse of ages: The variations of the environment create new needs and excite to new acts, affecting first the nervous system, which gradually modifies the organs subordinate to it.

Thus in the course of the past two centuries the breed of race horses has diverged markedly from its primitive form. The excitation to more rapid and more energetic muscular action is the cause of the modifications revealed by comparative anatomy, which are in great part hereditarily transmitted.

Jonathan Franklin states that kangaroos bred in captivity, having no longer as in their natural habitat to bound over the tall grass, begin to use their fore limbs for walking and running, while they lose in part the robust character of their tails and the power of their hind legs. M. Tegetmeier¹ states that rabbits, although imported into Australia in quite recent times, have already shown notable modifications, and have acquired by climbing trees habits which they did not have in the country of their origin. These facts and other similar ones should be rigorously investigated. The physiological and anatomical modifications of all such cases should be determined with precision, so as to ascertain if they correspond. If these modifications are real and their hereditary transmission is well established the theory of evolution will be experimentally demonstrated.

You see how many questions present themselves and how vast is the experimental field in which the Physiological Station may be used. I hope that I may have inspired you with a desire to seek a solution to all these problems. The task is long and difficult, but it is not beyond the scope of the experimental methods at our disposal.

¹ In Land and Water, London, 1892.

As for myself, I am no longer at an age when great projects are possible. It is my desire to associate in my enterprise those who may have the time and the necessary force to continue it. For this reason I ask you to make use of the resources of the Physiological Station. You will find there means of study applicable to the most varied subjects and sometimes even pecuniary subsidies, too often wanting to workers.

Nothing conduces more to the development of science than the association in the same work of men whose knowledge and aptitudes differ. Physicists, machinists, anatomists, and physiologists mutually enlighten and supplement each other. The animal organism will offer to them a valuable field of study, for in its physical and mechanical phenomena it gives simple and admirable solutions of an infinity of problems.

This idea that different branches of knowledge should be brought together is not a new one; it has been considered in the organization of our great establishments for superior instruction, but the combination is not made in an effective manner; physicists, chemists, and mathematicians work near each other, but they do not work together. And this results from the very necessities of teaching, which, in order to secure clearness of exposition and good methods, must necessarily present each branch of science as isolated from the others and sufficient unto itself.

The fusion of different sciences can not be effected at this time except in matters of research; this promises important discoveries, but we must not ask of it the material for regular teaching. The Physiological Station is simply an establishment for original research, where I invite you to unite your efforts and your learning for the resolution of the problems that I have just concisely placed before you. If you respond to my appeal, each of you, I am sure, will find it to his profit.

As for myself, I shall owe you the gratification for which I am most ambitious, that of having been useful.

THE METHOD OF ORGANIC EVOLUTION.¹

By ALFRED R. WALLACE.

I.

The modern doctrine of organic evolution may be said to date from the great French naturalist Buffon, who, more than a hundred years before the publication of the *Origin of Species*, clearly indicated his belief in the mutability of specific and generic forms, although, owing to the power of the church in his day, he was often obliged to veil his opinions under the guise of hypotheses, which, as they were opposed to religion, of course could not be true. Yet he occasionally speaks very plainly, as when he says:

“Nature, I maintain, is in a state of continual flux and movement;”
and again—

“What can not nature effect with such means at her disposal? She can do all except either create matter or destroy it. These two extremes of power the Deity has reserved for Himself only; creation and destruction are the attributes of His omnipotence. To alter and undo, to develop and renew—these are powers which He has handed over to the charge of nature.”

Dr. Erasmus Darwin held similar views, which he developed at great length, and in doing so anticipated many of the arguments afterwards elaborated by the celebrated Lamarck, that changes in species were caused both by the direct action of the environment, by the use and exercise by animals of their several organs, and more especially by the effects of effort and desire leading to the development of parts and organs calculated to gratify those desires. The great French naturalists Geoffrey and Isidore St. Hilaire² adopted these views with certain modifications, as did a limited number of German naturalists; while they were popularly set forth with much knowledge and literary skill by the late Robert Chambers in his *Vestiges of Creation*. Somewhat later the general theory of evolution was explained and illustrated by Herbert Spencer with so much power and completeness as to compel its acceptance by most thinkers; but neither he, nor any of the great

¹ From the *Fortnightly Review*, February and March, 1895, Vol. LVII, new series, Nos. 138, 139; by permission of the Leonard Scott Publication Company, New York.

² Etienne Geoffroy-Saint-Hilaire is the proper name of the author in question.—ED.]

writers who had gone before him, had been able to overcome the difficulty of explaining the process of organic evolution, since no one had been able to show how the wonderful and complex adaptations of living things to their environment could have been produced by means of known laws and through causes proved to exist and to be of sufficient potency. Alike for naturalists, for men of science in general, and for students in philosophy, the method of organic evolution remained an insolvable problem.

Considering that this state of opinion prevailed up to the very date of publication of the *Origin of Species*, the effect produced by that work was certainly marvelous. A considerable body of the more thoughtful naturalists at once accepted it as affording, if not a complete solution, yet a professional theory, founded upon incontrovertible facts of nature, demonstrating a true cause for specific modification, and affording a satisfactory explanation of those countless phenomena of adaptation which every preceding theory had been powerless to explain. Further consideration and discussion only increased the reputation of the author and the influence of his work, which was still further enhanced by his *Animals and Plants under Domestication*, published nine years later; and when this had been fully considered—about twelve years after the publication of the *Origin*—a large proportion of naturalists in every part of the world, including many of the most eminent, had accepted Darwin's views, and acknowledged that his theory of natural selection constituted—to use his own words—"the main but not the exclusive means of modification." The effect of Darwin's work can only be compared with that of Newton's *Principia*. Both writers defined and clearly demonstrated a hitherto unrecognized law of nature, and both were able to apply the law to the explanation of phenomena and the solution of problems which had baffled all previous writers.

Of late years, however, there has arisen a reaction against Darwin's theory as affording a satisfactory explanation of organic evolution. In America, especially, the theories of Lamarck are being resuscitated as of equal validity with natural selection; while in this country, besides a considerable number of Lamarckians, some influential writers are introducing the conception of there being definite positions of organic stability, quite independent of utility and therefore of natural selection; and that those positions are often reached by discontinuous variation—that is, by spurts or sudden leaps of considerable amount, which are thus "competent to mold races without any help whatever from the process of selection, whether natural or sexual."¹ These views have been recently advocated in an important work on variation,² which seems likely to have much influence among certain classes of naturalists; and it is because I believe such views to be wholly erroneous and

¹ Francis Galton. "Discontinuity in evolution," *Mind*, Vol. III, page 367.

² William Bateson, M. A. *Materials for the Study of Variations, Treated with Especial Regard to Discontinuity in the Origin of Species*, 1894, pages xv and 598.

to constitute a backward step in the study of evolution that I take this opportunity of setting forth the reasons for my adverse opinion in a manner likely to attract the attention not only of naturalists but of all thinkers who are interested in these problems.

Before proceeding to this special discussion it may be well to illustrate briefly the essential difference between the theories of Darwin and those of his predecessors and oponents, by a few examples of those cases of adaptation which are insoluble by all other theories, but of which natural selection gives an intelligible explanation.

The Darwinian theory is based on certain facts of nature which, though long known to naturalists, were not understood in their relations to each other and to evolution. These facts are: Variation, rapid multiplication, and the resulting struggle for existence and survival of the fittest. Variation is the fundamental fact, and its extent, its diversity, and its importance are only now becoming fully recognized. Observation shows that when large numbers of individuals of common species are compared there is a considerable amount of variability in size, form, color, in number of repeated parts, and other characters. Further, that each separate part which has been thus compared varies, so that it may be safely asserted that there is no part or organ that is not subject to continual variation. Again, all these variations are of considerable amount—not minute, or infinitesimal, or even small, as they are constantly asserted to be. And, lastly, the parts and organs of each individual vary greatly among themselves, so that each separate character, though sometimes varying in correlation with other characters, yet possesses a considerable amount of independent variability. The amount of the observed variation is so great that in fifty or a hundred adult individuals of the same sex, collected at the same time and place, the difference of the extreme from the mean value of any organ or part is usually from one-tenth to one-fourth, sometimes as great as one-third, of the mean value, with usually a perfect gradation of intervening values.

The multiplication of individuals of all species is so great and so rapid that only a small proportion of those born each year can possibly survive; hence the struggle for existence, the result of which is that, on the average, those individuals which are in any way ill fitted for the conditions of existence die, while those better fitted live. The struggle is of varied character and intensity—either with the forces of nature, as cold, drought, storms, floods, snow, etc.; with other creatures, in order to escape being devoured, or to obtain food, whether for themselves or for their offspring; or with their own race in the competition for mates and for the means of existence; while as regards all these forms of struggle mental and social qualities are often as important as mere physical perfection, and sometimes much more important. The fact already stated, of the large amount of variability in most species, has been thought by some to show either that there can be no such severe

struggle as has been suggested, or that the characters which vary so much can be of little importance to the species, and can not therefore determine survival. But in making these objections two considerations have been overlooked. In the first place, we always compare adults, and an enormous amount of destruction has already taken place during the earlier stages of life. The adults therefore are already a selected group. In the second place, the struggle is very largely intermittent, owing both to the occurrence only at long intervals of the most adverse meteorological conditions, while the diversity of these conditions leads in each case to the selection of a different characteristic. An exceptionally severe winter will destroy all which are deficient in one set of characters, while a long drought, or scarcity of some particular kind of food, will weed out those deficient in another set of characters. Thus in any one year there will exist numbers of individuals which are doomed to speedy destruction under some one of the special adverse conditions which are constantly recurring; and it is this, probably, that explains why there is so much individual variation continually present, although the central or typical form remains unchanged for very long periods. This typical form is that which, under existing conditions, survives all the periodical or secular adverse changes, during which the outlying or extreme variations of whatever kind are sooner or later eliminated. It is for want of giving full weight to the essentially intermittent nature of the struggle for existence that so many writers fail to grasp its full significance and continually set forth objections and difficulties which have no real importance.

We are now in a position to estimate the efficiency of Darwin's theory in explaining the wondrous and complex adaptations that abound in the organic world, as compared with that of Lamarck or of his modern supporters. And first let us take the simple case of the adaptation of fleshy and juicy fruits to be eaten by birds, causing what seems at first sight an injury to the species, but which is really most beneficial, inasmuch as it leads to the wide dispersal of the seeds, and greatly aids in the perpetuation of the plants which produce such fruits. To what possible direct action of the environment can we impute the production of fleshy or juicy pulp, with attractive color and with small, hard-coated seeds, in the innumerable fruits which are devoured by birds, through whose bodies the seeds pass in a state fitted for germination? There is here a combination of characters calculated to a certain end, a definite adaptation. If we suppose that in an early stage of development ancestral fruits which happened to be a little softer than others were eaten by birds, how could that circumstance increase the softness, develop juice, and produce color in future generations of the trees or bushes that sprang from the seeds so dispersed? And if we assume that these several characteristics are positions of "organic stability," acquired through accidental variation, we have to ask why the several kinds of variation occurred together, or why neither of them occurred

in the numerous species in which to be eaten by birds would be injurious instead of beneficial.

But if we begin at the same stage and apply the Darwinian theory, we find that the whole process is easy of explanation. It is an observed fact that fruits vary in softness, juiciness, and color, and seeds in the hardness or hairiness of their integuments. Any variation of primitive fruits in either of these directions would therefore be beneficial, by attracting birds to eat them and so disperse the seeds that they might reach suitable stations for development and growth. Such favorable variations would therefore be preserved while the less favorable perished.

Now, ask the same questions as to the production of the innumerable modes of dispersal of seeds by the wind, from the simple compressed form and dilated margins of many small seeds to the winged seeds of the ash and maple, and the wonderful feathery parachute of the thistle and the dandelion. Or again, inquire as to the wonderful springed fruits which burst so as to scatter the small seeds, as in some of the balsams; or yet again, as to the sticky glands of the sundews, and the small water traps of the bladder wort; and a hundred other equally strange adaptations to some purpose of use to the species, but whose development has no relation whatever to any possible direct action of the environment, though all of them are explicable as the result of the successive preservation of such variations as are known to occur, acting at various intervals, and by means of successive modifications, during the whole period of the development of the group from some remote ancestral form.

The modern advocates of Lamarckism content themselves with such simple cases as the strengthening or enlarging of organs by use, the hardening of the sole of the foot by pressure, or the enlarging of the stomach by the necessity for eating large quantities of less nutritious food. These, and many other similar modifications, may doubtless be explained by the direct action of conditions, if we admit that the change thus produced in the individual is transmitted to the offspring. That such changes are transmitted has, however, not yet been proved, and a considerable body of naturalists reject such transmission as improbable in itself, and at all events as not to be assumed without full and sufficient proof. But even if accepted it will not help us to explain the very great number of important adaptations which, like those already referred to, are quite unrelated to any direct action of the environment. Having thus cleared away some preliminary misconceptions, and stated in briefest outline the main features of the law of natural selection, we may proceed to consider the objections of those modern writers to whose works we have already referred.

Mr. Bateson's large and important volume consists mainly of an extensive collection of cases of variation of a particular kind, which have been met with throughout the whole animal kingdom, and have

been recorded in all parts of the world. These are arranged systematically under nearly nine hundred numbered headings, and are in many cases well illustrated by characteristic figures. The character and morphological relations of these variations are often very fully discussed with great knowledge and acuteness, and some original views are set forth which are of interest both to morphologists and physiologists. So far as this part of the work is concerned the present writer would feel himself quite incompetent to criticise it, but would welcome it as presenting in a convenient form a great body of interesting and little-known facts. But the book goes far beyond this. The first words of the preface tell us that "This book is offered as a contribution to the study of the problem of species;" and in a lengthy introductory and shorter concluding chapters this problem is discussed in some detail, with the view of discrediting the views held by most Darwinians; while a new theory, founded upon the facts given in the body of the work, is set forth as being a more probable one. It is therefore necessary to give some account of the nature of the facts themselves, as well as of the particular theories they are held to support.

Darwin distinguished two classes of variations, which he termed "individual differences" and "sports." The former are small but exceedingly numerous, the latter large but comparatively rare, and these last are the "discontinuous variations" of Mr. Bateson to which reference has been already made. Darwin, while always believing that individual differences played the most important part in the origin of species, did not altogether exclude sports or discontinuous variations, but he soon became convinced that these latter were quite unimportant, and that they rarely, if ever, served to originate new species; and this view is held by most of his followers. Mr. Bateson, however, seems to believe that the exact contrary is the fact, and that sports or discontinuous variations are the all-important, if not the exclusive, means by which the organic world has been modified. Such a complete change of base as to the method of organic evolution deserves, therefore, to be considered in some detail.

The difficulty which seems to have struck Mr. Bateson most, and which he declares to be of "immense significance," is that while specific forms of life form a discontinuous series, the diverse environments on which these primarily depend shade into each other insensibly, and form a continuous series (p. 5). Further on this objection is again urged in stronger language: "We have seen that the differences between species are specific, and are differences of kind, forming a discontinuous series, while the diversities of environment to which they are subject are on the whole differences of degree, and form a continuous series; it is therefore hard to see how the environmental differences can thus be in any sense the directing cause of specific differences, which by the theory of natural selection they should be" (p. 16). Again, at page 69, he urges that the essential character of species is

that they constitute a discontinuous series, and he asks "Is it not then possible that the discontinuity of species may be a consequence and expression of the discontinuity of variation?" He then states that on the received hypothesis, "Variation is continuous, and the discontinuity of species results from the operation of selection." This, however, is not quite a correct statement of the received hypothesis if "discontinuous" is used in Mr. Bateson's sense, as including every change of color which is not by minute gradation, and every change in number of repetitive parts—as of vertebrae, or of the joints of an antenna, or the rings of a worm—which is not by a gradation of the part from a minute rudiment. Such changes of color or in the number of parts are admitted by all Darwinians as, in many cases, constituting a part of that individual variation on which modification of species depends. It is, however, on the supposed rejection of this class of variations by Darwinians that he bases what he terms "an almost fatal objection" to their theory.

Returning, however, to the supposed overwhelming importance of discontinuous variation, we pass on to the last chapter of the book, headed "Concluding reflections," and we read: "The first object of this work is not to set forth in the present a doctrine, or to advertise a solution of the problem of species," and then follows immediately a further discussion of this very theory of discontinuity, which is set forth as a doctrine, and as a help to the solution of that problem. We are told that the difficulties of the accepted view "have oppressed all who have thought upon these matters for themselves, and they have caused some anxiety even to the faithful;" it is urged that "the discontinuity of which species is an expression has its origin not in the environment, nor in any phenomenon of adaptation, but in the intrinsic nature of organisms themselves, manifested in the original discontinuity of variation;" that, "the existence of sudden and discontinuous variation, that is to say, of new forms having from their first beginning more or less of the kind of perfection that we associate with normality, is a fact that disposes, once and for all, of the attempt to interpret all perfection and definiteness of form as the work of selection." And then comes the positive statement "the existence of discontinuity in variation is therefore a final proof that the accepted hypothesis is inadequate" (p. 568), and after several more pages of illustration and argument, the final conclusion is reached that "it is quite certain that the distinctness and discontinuity of many characters is in some unknown way a part of their nature, and is not directly dependent upon natural selection at all."

Before going further it will be well to make a few observations on these very definite and positive conclusions at which Mr. Bateson has arrived; and it must be remembered that this volume deals only with one portion of the subject even of discontinuous variation, which is itself, if we exclude monstrosities, only a small fragment of the whole subject of variation. The impression that will be produced on those

who have given special attention to the relations of living organisms to each other and to their inorganic environment will be that of an academic discussion, dealing to a large extent with words rather than with the actual facts of nature. The author's main point that species form a discontinuous series, and that specific differences can not, therefore, have been produced by any action of the environment, because that environment is continuous—an argument which, as we have seen, he dwells upon and reiterates with emphasis and persistency—rests wholly upon the obvious fallacies that in each single locality the environment of every species found there is the same, and that all change of environment, whether in space or time, is continuous. To take this latter point first, nothing can be more abrupt than the change often due to diversity of soil, a sharp line dividing a pine or heather clad moor from calcareous hills; or to differences of level, as from a marshy plain to dry uplands; or, for aquatic animals, from the open sea to an estuary, or from a nontidal stream to an isolated pond. And when, in the course of geological time, an island is separated from a continent, or volcanic outbursts build up oceanic islands, the immigrants which reach such islands undergo a change of environment which is in a high degree discontinuous.

Even more important, perhaps, is the fact that everywhere the environment as a whole is made up of an unlimited number of sub-environments, each of which alone, or nearly alone, affects a single species, as familiarly included in the term "their conditions of existence." The mole and the hedgehog may live together in the same general environment, yet their actual environments are very different, owing to their different kinds of food, habits, and enemies. The same thing applies to the rabbit and the hare, the rook and the crow, the ring snake and the viper; and still more when we look at animals of greater diversity, as the otter and the badger, the dung beetle and the cockchafer, and a hundred others that might be quoted. Now, though all these creatures may be found together in the same area, each of them has its own "environment," to which it must be adapted in order to maintain its existence. Many species, however, live, as it were, on the borders of two distinct environments, as when they obtain different kinds of food at different periods, being then exposed to different enemies and varied climatic effects. In such cases, it is easy to see that a small modification of structure might enable them advantageously to change their habits, and thus obtain what would be practically a different environment. This is well seen in those closely allied species which have somewhat different modes of life, as the meadow pipit (*Anthus pratensis*) and the tree pipit (*Anthus arboreus*), the former having a long, nearly straight claw to the hind toe, a more slender bill, and a rather greener tinge of coloring, all modifications suited to its different habits and distinct physical surroundings. Here we have an example in nature of how environments, even when continuous as a

whole, may become quite discontinuous in relation to two species differing in very slight characters. Darwin dwelt much upon this phenomenon of new species being formed when any body of individuals seized upon vacant places in the economy of nature, and by means of comparatively slight variations became adapted to it. It is what we see everywhere in the world around us.

It thus appears that what is evidently supposed to be a very powerful argument, leading to the conclusion that discontinuous variations as a class are those which are of vital, if not exclusive, importance in the production of new species, entirely breaks down when confronted with the facts of nature. It does not, however, follow that because an unsound a priori argument has been used to call attention to these variations, and because they have been set before the world in a way to suggest that their importance in relation to the origin of species is a new discovery calculated to revolutionize the study of this branch of biology, they are therefore of no value in this connection. We will therefore now proceed to consider them on their own merits as possible factors in the process of organic evolution. For this purpose we must briefly indicate the nature of the variations so laboriously recorded in this volume.

These consist of what are termed meristic variations; that is, variations in the number or position of parts which occur in series, whether linear, bilateral, or radial. Such are the variations in the number of segments of annulosa and arthropoda, such as worms, leeches, centipedes, etc.; in the antennæ and legs of insects; in the vertebræ, ribs, teeth, nipples, limbs, and toes of vertebrates; in the rays of starfish, encrinites, and allied animals. The ocelli and other symmetrical markings on the wings of butterflies are also recorded, as well as numerous malformations when these affect serial or symmetrical organs.

On carefully looking through the cases of variation in this volume, we are struck with the large proportion of them which exhibit more or less deformation or want of symmetry, culminating in the various kinds of monstrosity. In Chapter III, on the variations of vertebræ and ribs, we find vertebræ imperfectly divided in snakes and frogs. Numerous cases of abnormalities in human vertebræ are given, usually exhibiting asymmetry or deformation, and similar variations are found in the anthropoid apes, but here there is apparently more of regularity and symmetry. The greatest amount of this kind of variation occurs in the sloths, as might be expected when we consider that they are the most abnormal of mammals as regards the cervical vertebræ. In Chapter VIII numerous cases of supernumerary mammae are recorded, almost all of which are unsymmetrical. The variations in the number or form of the horns in sheep, goats, and deer recorded in Chapter XI show them to be usually more or less irregular.

Nearly a hundred pages are devoted to the digits (fingers and toes) of mammals and birds, about one hundred and forty cases of variation

being recorded. Almost the whole of these present, more or less, want of symmetry, while a large proportion, as the double-handed and double-footed children and the six or seven toed cats, can only be classed as monstrosities.

In succeeding chapters the variations in the antennæ and leg joints of insects; in the radial parts of medusæ and encrinites; in the medial structures of fish, insects, mollusks, etc., which become sometimes double; in the eyes and coloration of flatfish; in duplicate or branching legs of insects and crustaceans; in extra limbs of batrachia; and, lastly, double monsters, are all discussed at great length, and are illustrated by a number of very interesting woodcuts. But almost the whole of these can only be classed as malformations or monstrosities which are entirely without any direct bearing on the problem of the "origin of species."

Nothing can better show the small value of the book from this, which is the author's own, point of view than the large amount of space devoted to the various monstrosities of the hands and feet of man and of some of the mammalia. Not only throughout all mammals, but also in the case of birds, reptiles, and amphibia, five is the maximum number of the toes or fingers. These may vary in size or in proportions, they may be reduced in number by coalescence, or by the loss of the lateral digits; they may be strangely modified in form and function, as in the flappers of the whale or in the wing of the bat, yet never once in the whole long series of land vertebrates do they exceed five in number. Yet we have six, seven, or eight fingered, double-handed, or double-footed children; similar malformations in monkeys; six and seven toed cats; four, five, or six toed pigs; double-footed birds, and other monstrosities, described at great length, and all their peculiarities discussed in the most minute detail and from various points of view, in a work presented to us as "a contribution to the study of the problem of species." Many of these malformations have been observed among animals in a state of nature, and, in fact, Mr. Bateson believes that they occur as frequently among wild as among domesticated animals. Considering how rarely the former cases can be observed, they must be everywhere occurring; yet in no single instance do they seem to have established themselves as a race or local variety on however small a scale. Yet we know that in the case of the six-toed cats, and probably in other cases, they are easily transmissible; and we must therefore conclude that all these irregularities and monstrosities are in a high degree disadvantageous, since when subject to free competition with the normal form in a state of nature they never survive, even for a few generations.

As the volume we are discussing is entirely devoted to variations in the number or position of the serial parts of organisms in relation to the origin of species, it becomes necessary to lay some stress upon the very familiar, but apparently overlooked, fact that, among all the higher

types of life at all events, the most stable of all characters, and the most permanent during long periods of evolution, and throughout changes which have led to the production of a marvelous variety and abundance of specific forms, are these very characters of the number and relative positions of serial organs; whence it follows that variations of this kind can only have led to specific changes at enormously long intervals, and that, as a general rule, they can have had nothing whatever to do with the origin of an overwhelming majority of living species.

First we have the four limbs of vertebrates, which, among all the marvelous variety of form and function, on land, in the water, or in the air, is never exceeded, and appears to have been fixed at a very early stage of the development of the vertebrate type. Equally fixed, and extending through a still vaster range of modifications of specific forms, are the six legs and four wings of true insects, which, as in vertebrates, may be reduced but never increased in number. Still more extraordinary, because less obviously connected with the main structure and functions of the organism, is the limitation and permanence in the number of the subdivisions of limbs and other appendages. There is no obvious reason why in land vertebrates the divisions of the hand and foot should never exceed five, yet not only is this number the maximum, but it may be considered the normal number of which all others are reductions, since it still prevails largely in the marsupials, rodents, carnivores, primates, and lizards; and the five-toed land vertebrates (excluding birds) are probably far more numerous than those with a lesser number.

In birds there are only four toes as a maximum, and comparatively few have a smaller number. But we have here a peculiarity in the numbers of the toe joints which does not occur in any other vertebrates. These form a series in arithmetical progression, the hind toe having two and the others three, four, and five joints in regular order; and this rule is very nearly universal, the only exceptions being in some of the swifts and goatsuckers, whose habits render the feet of comparatively little importance, while their general organization is of a somewhat low type.

Coming to insects, we again find the legs consisting of a limited number of parts, and, strangely enough, this number is again five—the coxa, trochanter, femur, tibia, and tarsus. The tarsus, however, is subdivided into small movable joints, and these, too, are five as a maximum, but in certain groups are reduced to four, three, or two. The five-jointed tarsus is, however, the most prevalent, and in the enormous order of Coleoptera or beetles, comprising at least one hundred thousand described species, fully half belong to families which have the tarsi five-jointed. Even the antennæ, although they vary greatly in the number of joints, yet in numerous large groups comprising many thousands of species, they have the number of joints constant. Another indication of the tendency of serial parts to become fixed in number, is the typical limitation of the

cervical or neck vertebrae of mammalia to seven joints. This number is wonderfully constant, being the same in the long necks of the giraffe and camel and the very short necks of the hippopotamus, porpoise, and mole, the only exceptions in the whole class being some of the sloths, which have from six to ten, often varying in the same species, and the manatee, which has six.

Now, if we consider the enormous extent of these fixed numerical relations of important parts of the organism in the higher vertebrates and in insects, both as regards the number of living species affected—perhaps 99 per cent of the whole—and as regards their range in time, throughout the whole of the Tertiary and Secondary, and even a considerable portion of the Paleozoic periods, and if we take account of the vast number of extinct species, genera, and families needful to complete the various lines of descent from the earliest known forms, presenting the same numerical relations to those now living, we shall be able to form some conception, however inadequate, of the overwhelming frequency and importance of variations in the size, form, proportions, and structure of the various parts and organs of the higher animals, as compared with variations in their number. No doubt in the earlier stages of organic development numerical variations were more frequent and more important, as they are now among the lower forms of life; but at a very early period in geological history the main numerical relations of the essential parts of the higher organisms became more or less fixed and stable, and have in many cases remained unchanged through a large proportion of the period comprised in the geological record. The four limbs of vertebrates were already established in the fishes of the Devonian period, as were the four wings and six legs of true insects in the cockroaches and archaic orthoptera of the Carboniferous; and almost all subsequent changes have resulted from modifications of these early types. The earliest mammals of which we have sufficient knowledge have the typical five-toed feet, and the earliest birds appear to have had the same progressive series of toe joints as now prevails.

We are thus irresistibly led to the conclusion that, among all the possible forms of variation now occurring, those affecting the number of important serial parts among higher organisms are those which have the least possible relation to whatever modification of species may now be going on around us, or which has been going on during a large portion of geological time. Yet it is to variations of this nature, a large proportion of which are mere malformations or monstrosities, that the bulky and learned volume we are discussing has been devoted. The author of this book puts forward these malformations and irregularities, mixed up with a proportion of normal variations, under the misleading name of "Discontinuous variations," as if they were something new, and had been ignorantly overlooked by Darwin and his followers; and he loses no opportunity of telling us how important he thinks they are, what difficulties they enable us

to overcome, and how they are the beginnings of the establishment of a sure base for the attack on the problems of evolution. In so doing he has entirely failed to grasp the essential features which characterize at least 99 per cent of existing species, which are, slight differences from their allies in size, form, proportions, or color of the various parts or organs, with corresponding differences of function and habits, combined with a wonderful amount of stability in the numerical relations of serial parts, extending sometimes only to genera, but more usually to families, tribes, orders, or even to whole classes of the higher animals. It is differences of the former kind that do actually characterize the great majority of species;¹ they affect those organs which vary most frequently and most conspicuously in the individuals of every fresh generation, and they constitute that individual variation on which Darwin always relied as the essential foundation of natural selection, and which his followers have shown to be far more abundant and of far greater amount than he was aware of; and, lastly, they afford amply sufficient material for the continuous production of new forms. Rarely in the history of scientific progress has so large a claim been made, and been presented to the world with so much confidence in its being an epoch-making discovery, as Mr. Bateson's idea of discontinuous variation corresponding to and explaining the discontinuity of species; yet more rarely has the alleged discovery been supported by facts which, though interesting in themselves, are for the most part quite outside the general conditions of the complex problem to be solved, and are therefore entirely worthless as an aid to its solution.

Before leaving this part of the subject we may note the extension of definite numerical relations to plants as well as to animals. In dicotyledons we have a typical five-petaled flower, or a corolla with five divisions, a character which prevails in irregular as well as in regular flowers, and often when the stamens are not a multiple of five, as in mallows, bignonias, and many others. Some form of five-parted flower prevails throughout many extensive natural orders, and comprises probably a considerable majority of all dicotyledonous plants. A three or six parted flower is almost equally a characteristic of monocotyledons, prevailing even among the highly specialized and fantastically formed Orchideæ and Irideæ, thus again demonstrating how large a portion of the specific modifications of organisms are independent of variations in number, but depend wholly upon variations in the size, form, color, and structure of the various parts and organs.

Other matters of importance in Mr. Bateson's work, together with some theories recently advanced by Mr. Francis Galton, will be discussed in the concluding portion of this article.

¹Mr. Bateson, however, makes the extraordinary statement that "it is especially by differences of number and by qualitative differences that species are commonly distinguished" (p. 573). Species makers know too well that, among the higher animals at all events, it is not so.

II.

In the first part of this article the misconception which underlies the main body of Mr. Bateson's work has been discussed in some detail. We will now deal with some of the minor objections to the views of most Darwinians, which are to be found in his lengthy introduction; after which the validity of Mr. Francis Galton's doctrine, as to positions of organic stability (also held by Mr. Bateson), will be considered. And first, we note that he uses the usual misleading terms "minute," "minimal," "imperceptible," and "insensible" (p. 15) as applied to the individual variations on which Darwin relied, although he has himself given figures of beetles and earwigs showing that such variations are enormous—greater, indeed, than in the illustrative cases I have given in my Darwinism.¹

A strong attack is made on the theory of the utility of specific characters. It is admitted that an enormous amount of evidence has been collected, and that "the functions of many problematical organs have been conjectured, in some cases perhaps rightly;" yet he adds, "whole groups of common phenomena are still almost untouched even by conjecture." He tells us that "many suggestions have been made as to the benefits which edible moths may derive from their protective coloration, and as to the reasons why unpalatable butterflies in general are brightly colored" (p. 11); but neither here nor elsewhere is any hint given that more than "suggestions" have been advanced. Considering that this is the one branch of the subject in which natural selection has been shown to be an actual working reality in nature by the experiments of Jenner Weir, Butler, Stainton, and Belt, the observations of Bates and Fritz Müller, and especially by the elaborate investigations of Professor Poulton, it was hardly fair to pass the subject by as if nothing had been done but pure conjecture. He also ignores the continuous advance that is being made in determining the utilities of the innumerable modifications in the forms and arrangement of the leaves and other of the nonfloral appendages of plants by Kerner, Lubbock, and many other observers; as well as the light thrown on color and marking as specific characters in the higher animals by the consideration of the value of distinctiveness for purposes of recognition, a character of life-preserving value in the case of many animals, and in all of great importance to reproduction, and an essential factor in the differentiation of species. It is, therefore, not correct to say, "But as to the particular benefit which one dull moth enjoys as the result of his own particular pattern of dullness as compared with the closely similar pattern of the next species, no suggestion is made." The suggestion has been made (Darwinism, p. 226), and has been accepted as at all events a good working hypothesis by many naturalists. On this question of the utility of characters which are constant characteristics

¹See Proceedings of the Zoological Society, 1892 (pp. 59-23) [592-3?], in a paper by W. Bateson and H. H. Brindley.

of the species, but whose utility is not apparent to the casual observer, Mr. Bateson uses very strong language. Referring to the case of two ladybirds, the small *Coccinella decempunctata* being exceedingly variable, both in color and spotting, the larger *C. septempunctata*, very constant, he says, "To be asked to believe that the color of *C. septempunctata* is constant because it matters to the species, and that the color of *C. decempunctata* is variable because it does not matter, is to be asked to abrogate reason" (p. 572). I fear that I myself must be in this sad case, for though I have not been asked to believe this unreasonable thing, yet I do believe it. Of course I may be wrong and Mr. Bateson right, but how is it that he is so absolutely sure that he is right?

Before proceeding further we may briefly notice that Mr. Bateson seems to imply that the "meristic," or numerical variations, to which he has devoted his volume, are altogether ignored by Darwinians in their adoption of "individual variations" as opposed to "sports" for the main materials on which natural selection works. But this is altogether erroneous. No doubt they would reject nine-tenths of Mr. Bateson's cases as being simply monstrosities, which neither have nor could ever have had any part in the production of new species; but they always recognize that genera, and even species are sometimes characterized by a difference in the number or arrangement of serial parts—as of vertebrae, ribs, teeth, or markings, and that therefore variations of this kind are sometimes, though comparatively very rarely, the material on which natural selection works. As development seems almost always to have proceeded by reduction from large and indefinite numbers of serial parts to the minimum number compatible with the maximum of utility, an increase in number occurring now may be, as is usually considered, a form of reversion, though Mr. Bateson denies that there is any such thing in nature. This diminution in number may have occurred either by a gradual diminution in size and ultimate disappearance, as when limbs of the higher animals have been lost, in whales, the apteryx, snakes, etc.; or it may sometimes have been abrupt, which means that the rudiment of the part ceased to develop at an early embryonic stage. Either mode is quite in harmony with the views of Darwinians, and not very much seems to be gained by terming the former "continuous" and the latter "discontinuous," especially when this last term is held to include almost every kind of monstrosity.

We have now to consider an equally important, though as I consider an equally unsubstantial, novelty—the view that there are "definite positions of organic stability," which alone are sufficient to mold races "without any help whatever" from natural selection. This view appears to have originated with Mr. Francis Galton, and was first stated in his work on Natural Inheritance, and again in his Royal Society paper on "Thumb and finger marks." The same view is adopted by Mr. Bateson; and in an article on "Discontinuity in evolution" in *Mind* (Vol. III, pp. 362, 372) Mr. Galton approves of Mr. Bateson's work, and restates his latest views on the subject, and these I now propose to consider.

Although Mr. Galton begins by the consideration of races only, that is, of well-marked forms below the value of species, yet later on he applies his theory to the evolution of species and of all higher groups. Speaking of discontinuous or, as he terms it, transilient variation, he says: "A leap has taken place into a new position of stability. I am unable to conceive the possibility of evolutionary progress except by transilience, for, if they were mere divergences, each subsequent generation would tend to regress backward toward the typical center, and the advance which has been made would be temporary and could not be maintained" (l. c., p. 368.) Mr. Galton has before implicitly admitted that there is such a thing as natural selection, yet in this passage he reasons as if it had no existence, and that regression to mediocrity would occur just the same with it as without it. For the essence of natural selection is that it preserves and thus increases favorable variations by destroying the unfavorable; but this statement by no means expresses the real power of selection, which may be better illustrated by saying that it destroys about 99 per cent of the bad and less beneficial variations and preserves about the 1 per cent of those which are extremely favorable. With such an amount of selection how can there be any possible "regression backward toward the typical center" when any change in the environment demands an advance in some special direction beyond it as the only means of preserving the race from extinction? Well did Darwin say that unless the universal struggle for existence "be thoroughly ingrained in the mind, the whole economy of nature, with every fact on distribution, rarity, abundance, extinction, and variation will be dimly seen or quite misunderstood." Almost all the misconceptions of popular writers against Darwinism arise from the want of this constantly present recollection; and as capable and instructed writers, such as Mr. Galton and Mr. Bateson, as well as capable, but uninstructed writers, such as Lord Salisbury, alike suffer in this respect, it is needful to again state obvious facts which may serve to drive home the overwhelming importance of this factor in evolution.

Let us suppose an animal which lives ten years and produces 10 young (5 pairs) each year, a moderate allowance even for many mammals and birds. A little simple arithmetic will show that if none died for five years there would be 6,480 pairs in place of the 1 pair, or 6,480,000,000 in place of 1,000,000, as the case might be. But it is evident that such an average rate of increase for all animals could not go on for even one or two years, as no country could supply them with food. We will suppose, then, that only 1 pair, instead of 5, survive each year to breed the next year; but if this goes on for the ten years of the life of the first pair we shall still have 512 pairs instead of each pair, a number which is equally impossible. Let us, then, suppose that only one-fiftieth part of those born survive, that is, that only 1 individual lives to breed out of 5 successive broods of 10 each; even then, at the end

of ten years, we shall have a population two and a half times as great as at first, or, more exactly, if we began with 1,000,000 individuals, then in ten years we should have 2,593,743. This is probably something like what happens. Forty-nine fiftieths of those born never live to breed, yet the population increases steadily so long as conditions are moderately favorable, the surplus being got rid of at uncertain intervals by recurrent unfavorable conditions, so as to keep the number of individuals on the average about stationary. Looking at it in another way, we find that, beginning with 100 individuals whose offsprings each year amount to 500, of which only 10 survive to breed, then during ten years about 8,000 will have been born, making, with the original hundred, 8,100, out of which only the 100 fittest, or nearly the fittest, will survive, to be again weeded out every successive ten years, or thereabouts. Without making some numerical estimate of this kind it is impossible to realize the severity of the struggle continually going on in nature and the resultant elimination of the unfit. With the above figures (which would have to be enormously greater with many species) we see that for every 80 born only 1, on the average, survives to breed. With such an amount of selection it is evident that whenever it happened that the mean point, or "typical center" of the curve of variation, ceased to be the most advantageous point in relation to the whole conditions of existence, then a new typical center would rapidly be produced by the elimination of all which diverged from it to any injurious extent. There could not possibly be regression from the new typical center unless the inevitable survival of the fittest in a rapidly increasing population can be gotten rid of.

We are now in a position to discuss Mr. Galton's theory, that there are certain variations which possess "organic stability," and that these are the real factors of evolution "without any help whatever from the process of selection." And first, what is the exact character of these stable variations which form races and ultimately new species by their own inherent force of stability? Is the stability in relation to the actual conditions of the environment or altogether independent of those conditions? If the former, how did it come to be in harmony with them? If this harmonious relation depends upon a mere chance coincidence, we have to consider the comparative rarity of these large or discontinuous variations, and that only a small proportion of them have the alleged character of "stability." Moreover, this class of variations is generally a variation in a single part or organ, and Herbert Spencer (as well as many other writers) has argued forcibly that modifications of single characters would in all cases be useless unless accompanied by the correlative modifications of a number of other characters. I have myself shown that in the case of individual variations this is no difficulty, because all characters are varying more or less in every generation, and thus the needful harmonious relation between the different organs or parts can be easily maintained; but in

the case of these large and rare variations the difficulty is an overwhelming one. And we must always remember that these alleged "stable" variations, from the first moment of their appearance, can not possibly escape from the action of natural selection. As, roughly speaking, only about 1 per cent of each generation survives to breed, this new form, however stable in itself, can not become part of that 1 per cent unless the particular variation which characterizes it is either beneficial or entirely harmless. But in the latter case it is difficult to see what constitutes its superiority over the rest of the species which, year by year, by means of this intensely severe process of elimination, is kept in harmony with the environment. If the stability consists in greater health, vigor, reproductive power, or intelligence, all these qualities have already been developed to the fullest needful extent, and these superior individuals will be selected in the usual way. But if—as a second alternative—these alleged stable variations are supposed to have some kind of inherent stability independent of the environment, then, stability notwithstanding, they would inevitably soon succumb under the terrible eliminating power which year by year leaves only about 1 per cent of the most fit to survive. There is really no escape from this dilemma: If your new variety is among the 1 or 2 per cent of the most fit, then it does not need this purely imaginary quality of "organic stability" in order to survive; if it is not among this small body of the most fit—that is, of the best adapted to the whole conditions of existence of the species or race—then, any other quality notwithstanding, it will certainly not survive.

The term "organic stability" has really no meaning except that of harmonious adaptation to the environment as tested and maintained by natural selection. To talk about new races or species being produced "without any help whatever from natural selection" can, under the actual conditions of the terrestrial universe, only mean that there is an inherent developmental power which modifies organisms in definite ways, and in more perfect harmony with the environment than has been or can be brought about by natural selection, thus keeping these modified organisms always ahead of the rest. They may thus be said to be independent of survival of the fittest, because they and their offspring always are the most fit, and therefore always survive! On this theory evolution goes on by the production of new races complete and ready formed, and in perfect harmony with the environment whenever that environment undergoes a change. But no evidence is offered for such an extraordinary developmental power being always at work and always able to produce adaptation to an ever-changing environment. Such a power would be hardly different from the old special creation, or than the preordained harmony of the philosophers; and it would, moreover, have rendered unnecessary and unintelligible that rapid multiplication and consequent enormous expenditure of life which now prevails. It would equally render unnecessary that won-

derful property of individual variability, whose only use would then be to enable man to improve his domestic animals and cultivated plants. We should thus have two rival systems at work, and we might almost imagine Mr. Sullivan's cosmic spirits—William and James—to be realities, and that each had been experimenting in organic development on our earth in order to see whose scheme was the most satisfactory.¹

As evidence of the actual existence of this hypothetical "organic stability," Mr. Galton adduces the patterns in thumb and finger marks, which he has so carefully studied. In his Royal Society paper on this subject he tells us that these marks fall into definite groups and can be systematically classified, and he actually describes and figures twenty-five distinctive patterns arranged under three very distinct classes. He then urges that these fundamentally distinct classes are strikingly analogous to genera in biology, and as the patterns are so insignificant in every way that they can in themselves be neither useful nor ornamental, and can therefore never have been the subjects of selection, they prove, he thinks, "that natural selection has no monopoly of influence in forming genera, but that it could be wholly dispensed with, the internal conditions acting by themselves being amply sufficient to form them." And it is from the case of these finger marks that he considers the reality of positions of organic stability has been proved, and that they are "competent to mold races without any help whatever from the process of selection."

At first sight this may appear to be sound reasoning, and to be fatal to some of the claims of the Darwinians, but further examination will show that it is a pure fallacy arising from the vague use of terms, and from comparing quite different things as if they were of the same nature. The fallacy depends on applying the terms of classification in systematic biology to groups of single objects which have no real relation with the genera and species of the naturalist. The essential character of a species in biology is that it is a group of living organisms, separated from all other such groups by a set of distinctive characters, having relations to the environment not identical with those of any other group of organisms, and having the power of continuously reproducing its like. Genera are merely assemblages of a number of these species which have a closer resemblance to each other in certain important and often prominent characters than they have to any other species. It will be more intelligible and more instructive if we confine ourselves to species as the unit of comparison with Mr. Galton's groups of stable finger patterns, in order to show the fundamental differences between them. And first we see that Mr. Galton classifies the marks themselves, not the individuals who possess the marks. He tells us that the very same general varieties in these marks are found in English, Hindoos, and negroes, and, presumably in all other races; and, further, that he has "failed to observe any correlation between the patterns and

¹ See Strand Magazine, Vol. IV.

any single personal quality, whether mental or physical." All this is entirely different from either specific or generic characters, whose essential feature is that they are found in every normal individual of the genus or species, and are always correlated with other characters. In his first paper on this subject (in 1890), Mr. Galton said he had reason to believe that the patterns are to some extent hereditary, but that he had no evidence of it; while in his paper on "Mind," four years later, he could still only say that "they are to be looked upon" as having "a slight tendency toward transmission by inheritance." But the very essence of specific and generic characters is that they are strictly transmitted by inheritance. Yet, again, whatever difference of opinion there may be as to the utility of all the characters which distinguish species, everyone will admit that many are useful, and especially that the general assemblage of characters that fit each species for a somewhat different mode of life from its nearest allies, must certainly be useful. But the very essence of Mr. Galton's argument as to these finger prints is that they are not and can not be in any way directly useful. How, then, can the manner in which these patterns may be grouped furnish us with any argument whatever as regards such totally diverse things as generic or specific characters, and still less as regards genera and species themselves?

The fact is, no doubt, that these patterns are the direct result of the laws of growth of the tissues of the skin. The limited number and definite character of these patterns are probably the mechanical incidental results of these laws, under the ever-varying conditions of development in each individual. A good analogy would be found in snow crystals, of which about a thousand varieties have been recorded, which may, however, all be grouped under five classes, while each snow fall usually produces crystals of one class. Here we have the fixed and definite laws of the crystallization of water, so modified by conditions of moisture, temperature, motion, and perhaps electric state of the atmosphere, as to lead to this wonderful variety of the product, yet always subject to the law of crystalline symmetry and to systematic grouping under definite classes; just as in these finger prints we have a more limited variety of forms, which also can be grouped under a few classes. But neither the one nor the other has any real bearing upon the problem of the nature and origin of the genera and species of living organisms. A study of the distribution of the stars over the surface of the heavens, or of the interlacing ripple marks upon the sea-beach, would no doubt show that these objects might also be the subject of classification; and from the point of view of elucidating the origin of species, they would be about as useful, or as worthless, as the study of finger marks.

Of course, there are many varieties or races, both among animals and plants, which continually reappear, and which in some cases are known to reproduce their like, and these undoubtedly have an appearance

of stability. Such are the light and dark colored varieties in many insects and in some mammals and birds, the hairy or smooth varieties of plants, specially banded or colored land shells, and many others. Whenever any of these variations are not injurious under the actual conditions of existence of the species they may persist in considerable numbers, and thus appear to be stable. But others which are comparatively rare may be just as stable organically, as shown by the case of white mice, pigeons, etc., which increase to any extent under domestication. In a wild state they never do so, and the obvious reason is that either the conspicuous color or something correlated with it is injurious. In flowers white varieties are frequent, and they occur in all degrees of abundance or rarity, and this indicates, in all probability, various degrees of hurtfulness. If in any case the white color were not at all injurious as compared with that of the type, it would almost always, by the operation of Delbœuf's law, tend to increase to nearly an equality with the parent form, and as this equality so rarely occurs we must conclude that in most cases the variety, of whatever kind, is to some extent injurious.¹ From the usually limited number of individuals presenting these discontinuous variations, we may therefore draw an important conclusion which has hitherto been overlooked. It is that not only do such variations afford no support to the theory of a special "organic stability" capable of producing races, species, and even genera, without any aid from natural selection, but they furnish a strong, if not conclusive, argument against it, since any which did possess such exceptional stability and were in no degree injurious would long since have become equal in numbers to the type of the species.

A few words are here necessary as to the very common misconception that extreme Darwinians do not recognize the importance of the organism itself and of its laws of growth and development in the process of evolution. For myself, I may say that no one can be more profoundly impressed by the vast range, by the complexity, by the mystery, by the marvelous power of the laws and properties of organized

¹ For a statement and popular demonstration of Delbœuf's law see *Habit and Intelligence*, by J. J. Murphy, 2d ed., page 241. Briefly, the law is that if a species produces a variety, in however small a proportion annually, and if the variety produces its like in the same proportion as does the species, and if it is neither beneficial nor hurtful to the species, then the variety will increase, rapidly at first and more slowly afterwards, till it approaches to equality in numbers with the species. From this law it follows that, as varieties are usually very much less numerous than the species, this must be due to one of the following causes: Either (1) the variety has but recently originated, and has not had time to increase, or (2) the variety has ceased to be produced by the species, or (3) it does not reproduce its like so completely as does the species, or (4) it is disadvantageous to the species. The first two suppositions are improbable, and can only account for a very small proportion of the varieties which are greatly inferior in numbers to the species; the other two are antagonistic to any special "organic stability," which must therefore, in the great majority of cases, be rejected as being both unproven and opposed to the facts.

matter, which constitute the very foundation of all life, and which alone render possible its countless manifestations in the animal and vegetable worlds; while those who have read Weissmann's account of the complex processes of development of sperm and germ cells, in his volume on *The Germ Plasm*, must feel sure that he, at all events, can have no inadequate conception of their importance.

What Darwinians deny is, as I understand the question, that these laws themselves serve to keep the completed organism in close adaptation to the fluctuating environment, instead of merely furnishing the material which is required for that adaptation. In our view, the fundamental laws of growth and development, through the agency of rapid multiplication and constant variability, provide the material on which natural selection acts and by means of which it is enabled to keep up the adaptation to the environment (which alone renders continuous life and reproduction possible) during the constant though slow changes, whether inorganic or organic, by which, in the course of ages, the effective environment of each species becomes more or less profoundly modified. Thus, and thus alone, we believe, are new species produced in strict adaptation to the new environment. So far as rendering possible and actually leading to growth, reproduction, and variation, the fundamental laws are supreme. In securing the development of new forms in adaptation to the new environment, natural selection is supreme. Hence arises the real distinction—though we may not always be able to distinguish them—between specific and nonspecific or developmental characters. The former are those definite though slight modifications through which each new species actually became adapted to its changed environment. They are, therefore, in their very nature useful. The latter are due to the laws which determine the growth and development of the organism, and therefore they rarely coincide exactly with the limits of a species. The more important of these latter characters are common to much larger groups, as families, orders, or classes, while others, depending partly on complex and fluctuating influences, are variable even within the limits of a species. Of this kind are the finger prints, which, like many other minute details of form or structure, vary from individual to individual.

I have now, I think, shown that the two most recent efforts to establish new methods of organic evolution as either complete or partial substitutes for natural selection—that is, for the survival of the fittest among the individual variations annually produced—have completely failed to establish themselves as having any relation to the actual facts of nature. Mr. Bateson's discontinuous variations were long ago rejected by Darwin as having no important part in the formation of new species, while recent and ever-growing proofs of the generality and the magnitude of individual variability render these larger and rarer kinds of variation of even less importance than in his time. Mr. Galton's theory of organic stability, which is essential to the success

of discontinuous variations, has been shown to be founded upon a comparison of things of a totally dissimilar nature, and, further, to be absolutely unintelligible and powerless unless in strict subordination to natural selection.

The reason why two writers of such extensive knowledge and undoubted ability have so completely failed in dealing with the great problem of the modification of organic forms has been clearly indicated during the course of this discussion. It has arisen from the fact that they have devoted themselves too exclusively to one set of factors, while overlooking others which are both more general and more fundamental. These are the enormously rapid multiplication of all organisms during more favorable periods, and the consequent weeding out of all but the fittest in what must be on the whole stationary populations. And acting in combination with this annual destruction of the less fit is the periodical elimination under recurrent unfavorable conditions of such a large proportion of each species as to leave only a small fraction—the very elect of the elect—to continue the race. It is only by keeping the tremendous severity of this inevitable and never-ceasing process of selection always present to our minds and applying it in detail to each suggested new factor in the process of evolution that we shall be able to determine what part such factors can take in the production of new species. It is because they have not done this that the two authors whose works have been here examined have so completely failed to make any real advance toward a more complete solution of the problem of the origin of species than has been reached by Darwin and his successors.



THE PART PLAYED BY ELECTRICITY IN THE PHENOMENA OF ANIMAL LIFE.¹

By M. ERNEST SOLVAY

Biological research must be guided in the direction of physics and chemistry, and, in my opinion, we must set out with this profound conviction—that *the phenomena of life can and should be explained solely by the working of the physical forces which control the material universe, and that among these forces electricity plays a predominant part.*

It is with a view to contribute to the verification and development of this thesis by observation and by study of the facts of experiment that I have determined to found a spécial institute for research.

I would now address myself to all those who, in the future, and even after I shall have ceased to live, shall undertake researches in the laboratories which are about to be opened; I would try to state the character of the answers which I foresee are to be looked for from their labors to the great problem, as I understand it, of the nature of life. Having meditated much upon this problem, I believe that I have found some new points of view which it may be useful to make known to those who enter upon experimental researches in this direction. I aim at establishing a close correlation among the facts by tracing them back always to the foundation of physical principle. I introduce hypothesis when needful, as a lever, as a tool with which to open a new path for investigation. The future will show to what extent my views are true, or how far I have been mistaken.

I.

PRINCIPLES OF PHYSICO-CHEMISTRY.

I.—OF THE CONSERVATION AND TRANSFORMATION OF ENERGY—SPECIFIC CHARACTER OF ELECTRICAL ENERGY.

We know that in every case of chemical combination the quantity of heat disengaged, with positive or negative value, is equal to that which would be necessary and sufficient to decompose into its constituents

¹ Extracts from an address delivered by M. Ernest Solvay, at Brussels, on the 14th of December, 1893, on the occasion of the public gift to the city of Brussels of the Institute for Physiological Research, founded by M. Solvay.

Translated by J. W. Mallet.

the substance formed. . . . It seems permissible to assume that, in every case of chemical combination, electrical energy may exist before thermic energy, and that the latter may be but the result of a transformation of the former; that, if this way of looking at the facts is but partially sustained by experiment, the reason is to be found in our working under conditions which cause the immediate transformation, in whole or in part, of electricity into heat.

In support of this mode of looking at the facts let us notice that electricity is capable of decomposing a substance without sensibly raising its temperature, while this is far from being true in regard to heat; hence the product of an electrolysis is much greater than that of a dissociation due to heat alone. It follows that electricity appears to us as endowed with a peculiar and specific character, of which we shall have to take account. . . .

II.—OF THE RELATIONS EXISTING BETWEEN THE PHENOMENA OF PHYSICS AND OF CHEMISTRY—UNITY OF THE PHYSICAL FORCES.

. . . We may, it seems to me, explain all phenomena, both physical and chemical, by assuming that every mass of matter (particle, molecule, or atom) is endowed with a specific character which is a mathematical function of its temperature, of its pressure, and of its potential energy or its electrical state.¹

Expanding this proposition, here stated in its most general form, we recognize that it affords us the means of explaining, not only the attractive force acting between the parts of matter of the same kind, but also and equally well the special elective power which characterizes the chemical force called affinity; that it enables us to interpret the variations which this latter force exhibits under the influence of changes in temperature, pressure, or previous electrical state (dissociation, action in the nascent state, etc.); that in short this very function of which we are speaking must be the expression of the physical force called cohesion or of the chemical force known as affinity, according as the substances brought together are identical or different in nature.

All phenomena, physical and chemical, are thus blended, and fall into two great classes:

- (1) Endothermic phenomena, which consume, absorb, or render latent a certain quantity of external energy; and
- (2) Exothermic phenomena, which set free a part of the energy existing in the potential state in the ingredients which unite in the formation of a new body.

Let us go back now to what has been said (in I) as to the preappearance of electrical energy in the act of chemical combination.

If it be true that chemical and physical phenomena present no essential points of difference, and are but the manifestations of a single and

¹ Since the potential energy may be expressed as electrical energy.

identical aggregate of causes, have we not ground for supposing, by reason of analogy, that in every exothermic physical phenomenon the energy set free appears, or tends to appear, first under the form of electricity? That if we have not hitherto succeeded in completely revealing it in this form, it is because the very circumstances of our experiments have occasioned its transformation.

If this conjecture be vindicated we shall be authorized to regard all the phenomena of nature, whatever they may be, as manifestations of electricity, without deciding beforehand anything as to the essential nature of this force.

This is the form under which the idea presents itself to my mind of the unity of the forces of nature.

II.

OF THE LIVING MOTOR.

I.—OF THE NATURE OF THE LIVING MOTOR.

- - - Among the essential characteristics presented by the animal kingdom, one of the most striking is unquestionably the faculty of automatic locomotion, which has been called motivity.

The study of this distinctive quality leads us quite naturally to the most general consideration of the phenomena of life in their connected aggregate, so that we may conveniently take this as our starting point when we propose to unfold the part taken by the forces of inanimate nature in connection with the phenomena in question. Since motivity is essentially inherent in the nature of the living animal organism, we may say that an animal is a motor; further than this, we have good reason to believe that an animal is an electric motor, as I will now try to show.

Proceeding by the method of exclusion, we see at the outset that motivity can not arise from a dynamic transformation of potential energy of the kind presented to us in a hydraulic motor, for we perceive neither a reservoir of liquid nor a fall capable of being turned to account.

Neither can the cause we seek be found in a purely thermic transformation of the same kind as that exhibited by gas engines, hot-air engines, and steam engines, to which contrivances no one would think of comparing a muscle.

On the other hand, electricity lends itself to a satisfactory solution of the problem before us, a solution to which it will be well that we give our attention, at any rate until the future shall have revealed to us the existence of some other as yet unthought-of mode of transformation of energy, if so be that such a mode exist.

Laying aside, then, finally, on the evidence before us, the supposition of hydraulic action, let us examine more closely the two other hypoth-

eses, and let us especially compare the yield in mechanical energy of a thermic or electric motor with that of a living motor.

We know that the most highly approved thermic motors do not give more than about $8\frac{1}{2}$ per cent of useful effect; the theoretic limit to the yield of steam engines is 17 per cent, and to that of gas engines 21 per cent. On the other hand, let us look back to the experiments of Hirn and Helmholtz. We find that we must assign to the yield of a muscle a mean value of more than 30 per cent.

It is impossible, as we see, to compare with this useful effect the far inferior yield of the thermic motors of human contrivance; the difference is so great that, without reference to certain physical impossibilities pointed out by Hirn, it suffices to make us give up the hypothesis of a thermic cause, in the sense in which we have just spoken of it. The idea of electrical transformation presents itself in quite a different light, since in this case the yield in dynamic effect is much greater and is comparable to that of the living motor.

II.—OF THE SEAT IN THE ANIMAL BODY OF ELECTRICAL MANIFESTATIONS. ELECTROGENIC APPARATUS.

- - - Oxidation of organic matter takes place in all the living cells. It takes place even in the blood and in the lymph at the expense of the chemical constituents carried forward by these fluids and not as yet endowed with organized structure. All the tissues take part in this process of internal combustion. All must thus contribute to the supply of energy necessary to the living being.

But the relative importance of each of the tissues varies greatly in this respect. To convince ourselves of this we need but, for instance, contrast the physiology of muscular tissue with that of connective tissue.

The preponderant importance of the part played by muscular tissue is manifest; we know, in fact, that when work is being done the muscles come in for some 70 or 80 per cent of the total oxidation taking place in the animal economy. The glands, which represent apparatus composed of cells of great vital activity, also undergo rapid oxidation. Internal oxidation is for us the source of electricity. This process goes on chiefly in the muscles and in the glands; hence we give to these portions of the whole organic structure the name of electrogenic apparatus.

It is interesting to notice that the tissues which are the seat of most active oxidation, as the muscles and the glands, are richly provided with nerves, while those in which oxidation is feeble, as the cartilages and connective tissue, are but poorly supplied by the nervous system.

May we not use this fact—a very important one, in my opinion—to establish an analogy between each animal organism, simple or complex, *amaba* or man, and the cell or single element of a voltaic battery? Thus the readily oxidizable tissues, forming the electrogenic apparatus,

would play the part of the negative plate, the fluids producing oxidation and hydration that of the positive plate; the nerves would serve to close the circuit.

We should thus recognize in the economy of the living animal the chemical duality necessary for the production of electrical energy; should we not, consequently, be justified in considering this organism as a true physiological battery? If so, we ought to follow up the comparison, and try to understand how this battery works; what is the nature and what the extent of its circuit; what are the causes which make its discharge to vary, and finally, what becomes of the energy which it develops.

III.—OF THE PHYSIOLOGICAL VOLTAIC BATTERY.

In every battery the existence of available electrical energy is manifested only in so far as the electricity is able to flow off by appropriate conductors to parts of the apparatus where it may be utilized or transformed.

In default of such an arrangement—in the case, for instance, of a battery short-circuited by means of a conductor of low resistance—we perceive nothing but a development of heat, which seems to be the immediate result of the transformation of energy which occurs, but which, in accordance with what we have said as to the preappearance of electricity, may here again be regarded as a secondary phenomenon.

To justify the use of the expression physiological battery or pile, we have at the outset to prove that there exist in the animal organism lines of least electrical resistance (or behaving as such) capable of giving direction to the electricity disengaged, of conducting and distributing it.

But I have good reason for believing that this part devolves upon the nerves, and that wherever they are developed and ramified they gather up a part of the electricity produced by the electrogenic apparatus and convey it to points where it reappears unaltered or transformed.

The slight oxidizability of nervous tissue and its great functional importance lend, moreover, support to this mode of looking at it.

In what way does the propagation of electricity in the nerves take place? This question is certainly destined to occupy a large place in the programme for the experimental work of the institute. To answer it there will be need, it seems to me, for seeking first of all to complete our knowledge of the constitution itself of the nerve fiber, afterwards to study very closely the electro-physical properties of nerve tissue, to investigate under what influences its electrical resistance varies, to determine finally the nature of the process itself by which the nerve current is propagated toward the organs where it is utilized. The inmost nature of this process is as yet unknown to us, and I do not understand that it is to be regarded as identical with the propagation of electricity in a metallic conductor. I limit myself then, for the

present, to a single remark on this point—already proved to be true—namely, that manifestations of nerve action are always accompanied by variations of electrical condition.

I will not enlarge further upon these questions, important as they are, so as not to go beyond the plan of a merely general statement of views.

No one among you, moreover, can have overlooked the great interest of the researches of which these points will form the subject in the new institute.

IV.—OF THE PART PLAYED BY THE NERVES IN THE PHENOMENA OF STIMULATION.

Muscle and nerve respond to stimulation of mechanical, thermic, chemical, or electrical origin, but the last of these is attended with especially remarkable results.

Electrical influence is in fact by far the most powerful and extended in its effect, whether it be applied directly to the muscular tissue or, above all, if it be applied to a nerve.

On the one hand, if a muscle be directly stimulated by a shock, a drop of acid, or a prick with a sharp point, we produce but a limited local effect, while, on the contrary, if we act through the medium of a nerve we call forth generalized effects, whatever be the stimulus made use of, and it is the whole muscle that contracts as if each of its parts were electrified.

To obtain the same result without having recourse to a nerve as medium it would be necessary to apply the stimulus simultaneously to all the elementary fibers of the muscle.

These facts have a double bearing: they seem to justify the idea of attributing to the nerves the part of conductors, and show also that electricity is the form of energy which lends itself better than any other to propagation to a distance and to distribution in the living organism.

V.—OF MUSCULAR CONTRACTILITY.

Although stimulation gives rise to electrical manifestations it does not follow that the appearance or presence of electricity is necessarily dependent upon the occurrence of external stimulation.

I am much rather inclined to believe that the physiological electric battery is always in a state of activity, and that a muscle works—that is to say, gives out energy produced by this battery—even when it accomplishes no external work.

A muscle is an elastic body, more or less stretched, capable of being progressively contracted by the electric current up to the point of producing an external mechanical effect. As the current diminishes the muscle relaxes; as the current increases it contracts, and we may say that its *tonus*, or intensity of contraction, is some function of the quantity of electrical energy employed.

On the other hand, it seems evident that it is in consequence not of a static but of a dynamic action that the muscle as an organ maintains its state of contraction. It behaves like a spring upon which a jet of water constantly plays, and not like a spring loaded with a weight.

In the former of these two cases the dynamic stress, constantly kept up, is exerted against work, which involves expenditure of the moving fluid and, consequently, a certain amount of energy. In the same way the sustained contraction of a muscle also demands a continued supply of energy.

The physiological battery operates, then, to furnish this energy even when the muscle is at rest, and as no external work is accomplished in this condition all the energy furnished is transformed into heat.

It would be easy to multiply illustrations of this condition of special equilibrium; we find it notably exhibited in the case of a ball supported on a jet of water and in that of a soaring bird, which contends with the action of gravity by the rhythmic strokes of its wings.

VI.—OF THE VARIABILITY IN YIELD OF ENERGY BY THE ANIMAL ORGANISM.

It is easy to see that the quantity of energy consumed must increase when the state of rest is followed by that of activity from whatever cause, during which external and internal work are superadded to that of the *tonus* existing during muscular repose. The reaction of the organism is not constant; it varies in intensity with the condition of sleep, of wakefulness, and of work. - - -

It must be, then, of absolute necessity that the yield or output of energy of the physiological battery can regulate itself in due proportion, so that there shall never be either excess or deficiency.

Where shall we find the seat of this regulating action if it be not in the nervous system itself, with the importance of which as an apparatus of stimulation we have already taken note?

Assuming that the nervous system is not the producer of energy, but that its function is only to distribute it, must we not hence conclude that by means of its stimulating power it can modify, hasten, or retard this distribution?

VII.—OF THE GENERAL REASON FOR THE EXISTENCE OF THE NERVOUS SYSTEM.

We may picture to ourselves simply enough, in general principle, the reason for the existence of the nervous system if we represent a nerve as the main path by which electrical energy is carried from the point at which it originates to a nerve center and from thence to an organ of expenditure.

In proportion as we ascend in the scale of matured animal forms or in that of embryonic stages of development, and as we study more and more perfect organisms, we observe the muscular and nervous systems develop in extent and at the same time increase in the complexity of their structure and functions. In proportion as the embryo undergoes

development the nerve fiber elongates and becomes the seat of increased electrical resistance.

Thus the nervous network ceases to be able to carry more than a continually diminishing part of the total energy. The greater part, forced to undergo utilization at the seat of its production, gives to the muscular fiber its peculiar character and brings about its contractility or tonicity, as we have seen (in V). - - -

If we reflect upon the stage of progressive evolution of an inferior animal, or upon one of the earlier phases of development of an embryo, we understand that in proportion as nerve trunks take their rise in the neighborhood of each other differences of electric potential, existing between certain points of these trunks, tend to give rise to new trunks, superadded to the former, and the presence of which helps to render electrically dependent upon each other the different parts of the electrogenic system.

Let these *anastomoses* be multiplied *ad infinitum*, without losing sight of the fundamental idea of the system, and we shall be able, as it seems, to succeed in explaining the governmental order which reigns throughout the whole nervous system, from the smallest sporadic ganglia to the brain, which is itself the center of centers.

VIII.—OF THE PART PLAYED BY SENSORY EXCITATIONS.

Let us now investigate how the nervous system may play the part of stimulator while drawing its functional energy from the reaction of the whole organism, and how it comes to regulate the operation in all its variations of the physiological battery.

Nothing seems to stand in the way of our looking on the series of multiplied nerve trunks which constitute the nervous system of one of the higher animals as closely analogous to an ordinary system of wires for the distribution of electrical energy, in which whole series of apparatus for the consumption of this energy (lamps, electric motors, etc.) are branched off from a great source of production of electricity at a central station.

We may assume all of these pieces of apparatus for the utilization of the current to be regulated by instruments electrically connected with the central source of power, which instruments themselves consume in their operation a certain share of the available energy, and represent so many secondary derivations of energy from the system. Finally, to complete this ideal scheme, we may imagine each of the pieces of apparatus for the utilization of the current to be furnished with an "annunciator"—an instrument operated electrically—which shall give notice to the regulating apparatus of anything going wrong at the point at which such instrument is placed.

The aggregate of all the regulating apparatus in such a system forms, to my eyes, an image of the brain, and the instruments which give notice of what may occur at the various outlying points in the system are but the analogues of the organs of sense.

Moreover, nothing prevents the parts of such a system being arranged so as to produce apparent automatism; such would be the impression conveyed by the innate character of the reflex actions arising from the structure conferred upon the system.

As for the sense impressions, the predominant part assigned them in such a distribution of energy will be to act upon the regulating apparatus, and by their means to modify the conditions of output of energy.

As the effect of influences from without acting upon the organism will be to oppose or to favor organic activity in those parts where such influences have long tended to favor such activity, the organs of special sense will have been formed and developed, and will have become the normal stimulators of vital action.

In such a system, provided the normal organism be not called upon for more than a part of the energy which it can produce, the actual production must essentially correspond with the demand for it; the physiological battery has, in the sensory organs, a true regulating apparatus capable of adjusting the amount of vital oxidation to the direct or indirect excitations which come from the environment; the whole matter appears as if the stimulations of sense impressions set up conditions more favorable for the genesis of energy by increasing nerve conductivity, perhaps by a swelling up and consequent increase of contact or compression of the material of the axis cylinders. The flow of energy thus produced at the seat of excitation will necessarily be returned like an echo to the other end of the line, acting upon the muscle in which energy is utilized, and the increase of muscular contraction will be the physiological expression of this echo in the muscle of the signal given by the sense impression. - - -

III.

THE MECHANISM OF VITALITY.

I.—OF THE CHARACTERISTICS OF VITAL ACTIVITY.

Having thus pictured to myself the conditions of the working of the nervous system in a living animal, working which is dependent upon the distribution of electric energy generated by physicochemical reactions in the protoplasm, I have been led to examine how it is possible to conceive of the origin of vitality in this system; that is to say, the origin of the reactions producing electricity in the very heart of the primitive protoplasm.

Reasoning from one inference to another, I have come to propose in definite form the following thesis:

Life is essentially characterized by the existence of a system of continuous reactions, the necessary elements of which are ceaselessly reproduced and which take place in the midst of an appropriate medium.

It presents itself to us, therefore, not only in the complex organism, but even in the last result of its structural subdivision in the single cell, in which it still exhibits the same essential character by which it is sufficiently defined.

It is not limited by particular morphological conditions. Organic form and structure may vary almost endlessly with a condition of the medium without the essential character of vitality thereby disappearing.

In order that this vital reaction may take place three general conditions are necessary: First, the simultaneous presence together of the prime materials essential to the reaction; secondly, a particular state of distribution of these prime materials, from which may result the heterogeneity indispensable to the progress of the reaction, and, finally, such arrangements as shall permit the energy liberated by the reaction to be consumed, utilized, or transformed, either on the spot or outside the field of the reaction.

II.—OF OXIDATION IN THE ORGANISM.

Among the chemical phenomena, varied as they are, which the living organism presents to us there is one, that of oxidation, which is distinguished from all the rest by its generality of extent and its preponderant importance; we may even say that, so far as the higher animals are concerned, oxidation is the essential chemical phenomenon of life and the others are but of secondary character. - - - The principal seat of vital activity is to be found in protoplasm submitted to the action of oxygen. It is protoplasm which forms cells; it is by it that they live and are nourished. As for the protoplasm itself, it derives its material from the various forms of food, solid, liquid, and gaseous, which are thus the prime source of the energy developed in the organism. - - - But before broaching the subject of chemical change as it occurs in the organism let us first consider a simple phenomenon, and one with which we are familiar; we shall thus make clearer the statement which is to follow.

When we plunge a piece of perfectly pure and homogeneous zinc into acidulated water, as long as the metal remains isolated in the liquid we observe no reaction, save that at the first moment of introduction a difference of electric potential is immediately established, but all is limited to this.

If, on the other hand, we connect the zinc with the acid by a substance less oxidizable than this metal, immediately an electric current is set up and reaction between zinc and acid takes place.

Simple contact then does not suffice to bring about reaction; it can but produce a sort of orientation of tension, or, if one please so to put it, a new state of equilibrium of the particles, in which there come in an electro-motive force and a counter electro-motive force equal and opposed thereto.

When the circuit is completed by means of a nonoxidizable or less oxidizable substance this equilibrium is made an end of by doing away with the counter electro-motive force, as a path of escape is offered to the electricity; but the electric flow or current thus established constitutes an available form of energy, which may be used to liberate zinc if we cause such current to act by a suitable arrangement upon an easily decomposable zinc salt.

On condition, then, that we provide by a supply of supplementary energy for the inevitable losses of effect resulting from these successive operations, we see that it is possible to form a cycle of reactions corresponding at all points to our definition of vitality.

If, then, this definition give a true statement of the facts, must we not come to recognize in the *vital cycle* the image of that which we have just sketched. - - -

Let us consider a culture medium capable of maintaining the life of a given cell by furnishing it with all the constituent material it requires, and let us observe that in order to suitability of the medium for the cell the former must contain at least the chemical elements which occur as constituents of the latter.

As long as the cell is absent this medium may be compared to the voltaic battery with circuit unclosed, which we have taken as an example by analogy. Like this latter, and by virtue of the same natural laws, it will present a state of equilibrium, due to the existence of two opposite electrical forces—a kind of state of virtual combination between the electro-positive and electro-negative constituents—but no chemical change will disturb its original homogeneity.

Let us now suppose that the living cell is introduced. As soon as equilibrium is overthrown displacements of electricity are set up, combinations and decompositions take place, and the vital circulation of energy and matter is established.

To explain what has thus occurred we must assume, it seems to me, that the first result of the introduction of the living germ or cell has been to offer to the electricity conducting paths, or in other words, to bring about what I will call *odogenesis*.¹ The first effect of vitality would seem to be that of a contact action, allowing of chemical change being energetically produced by favor of the short circuits offered to the electrical energy engendered.

III.—OF THE PART PLAYED BY THE LIVING CELL.

Nevertheless, how can this take place, since the medium we have under consideration continues inactive, the cell introduced reacting only with the stratum of this medium with which it is in immediate contact?

To explain this it is essential to remark that from the quite special point of view at which we are just now placing ourselves we must

¹ Odogenesis, the creation of a path, from *ὁδός* and *γένεσις*.

logically think of the cell as chemically forming a part of the medium by which it is surrounded, since it draws from thence, and continues to draw from thence, the materials from which it is made up. The cell, although distinct from the medium, is but a fraction of it. The chemical medium thus extends to the cell which lives in it; the latter in finding its way into the former has but set up a *selection* among the constituent elements.

The fundamentally electro-positive materials go to form the substance of the cell itself; the oxygen, or its electro-negative equivalent, remains in the portion of the medium which is in intimate contact with the matter of the cell, whether on the outside or on the inside of the morphological element which it constitutes.

It follows then, clearly, from this remark that the cell is, properly speaking, but the *means of reaction* presented to the medium, and, further, that the path for electric conduction that we are looking for must exist between the cell and the fractional part of the medium which is in direct relation with it.

IV.—ON THE PART PLAYED BY SELECTIVE ELECTROLYSIS IN THE PHENOMENON OF CELL NUTRITION.

But before we concern ourselves with this point we ought to look into the phenomenon of cell nutrition and ask ourselves how it is that in the complex medium that surrounds it on all sides the cell is able in some way to choose the elementary particles which suit it; by what directive influence these particles take up their positions and arrange themselves in such a way as to become integral parts of an organized structure; whence finally comes the impulse which determines the *special course* of the vital circulation of matter and energy, allowing the cell, on the one hand, to assimilate such or such a determinate constituent from the medium, while *at the same time* it gives up, on the other hand, some constituent which has just before formed a part of its structure?

It is easy to reply to these questions if we go back to the inorganic reaction between zinc and acid, and take it as a new subject of comparison, imagining now the zinc to be in a finely divided condition. We have seen that in this case the acid, ready to combine with the zinc, is held in check by the electricity set free at the first moment of contact, this electricity counterbalancing or neutralizing its chemical affinity.

We have the same state of things before us in the growing cell surrounded by a nutrient medium. The albuminoids of the plasma correspond to the finely divided zinc; the oxygen represents the acid of the mineral illustration.

When this oxygen, kept in the inactive state by favor of the albuminoids with which it is virtually associated, makes its way with them into the domain of the cell and comes in contact with albuminoid materials of the same kind, but more readily oxidizable for reasons

which we shall see further on, it at once enters into combination with them. It thus sets free new portions of albuminoid matter from the virtual combination which it had formed with them, and these immediately take advantage of the electricity produced by the oxidation to raise their own electric potential to such a point that they may be able in consequence to take their places in turn in the structural edifice of the cell thus endothermically built up. It is in this way that, quite naturally, the cycle of reactions is established which constitutes the rotation of changes in the living machine.

The mechanism which we have just explained shows how the chemical changes which represent the nutrition of the cell take place in the inmost recesses of the living substance itself, from atom to atom and from molecule to molecule, producing, in place and step by step with their occurrence, the electric energy needed for each ensuing reaction.

Following out this order of procedure, the cell may be said to withdraw from the surrounding medium the nutrient materials which are adapted to the different parts of its own substance by its proper affinity, which I will call *selective electrolytic power*, but which is merely the resultant of the previous electrical condition of the constituents concerned. The dropping out of the one constituent necessarily incites the reentrance of another precisely similar constituent. Thanks to the continuity of the rotational change going on, each particle of the cell passes in succession, all other things being equal, through the same phases of condition with that which has preceded it, from the moment of its admission to the substance of the cell up to the moment when it becomes separated from it. Before being introduced into the substance of the cell the atom must leave the *virtual combination* in which it was held. It is precisely the disappearance of the atom which precedes that furnishes to the one which follows it the exact amount of energy required to effect its *selective electrolysis* or its liberation from the state of virtual combination. Thus we shall have concordance, referring to the possibilities of the case, between what the one lacks in order to leave the medium and enter into the substance of the cell and that which the other provides when it frees itself from the combination in which it has been held in order to engage itself in one more powerful; and, on the whole, quantitatively speaking, there will be a certain available excess of energy on the latter side. It follows from this that the points of accretion, howsoever distributed as to position in the protoplasm, always retain their identity both in composition and structure; and, as the same causes everywhere bring about the same effects, the whole cell must reproduce itself indefinitely with maintenance of its identity if the nutrient medium remain on its part constant in character and the process of transformation go on. - - -

The preceding hasty sketch sufficiently shows, I think, that it is legitimate to compare, as I have done at the outset, the mechanism of

vital activity to that of a single element of a voltaic battery, when once we recognize in the living cell the special part which I have assumed it to play. - - -

I believe that these general considerations will suffice to render intelligible, and in a provisional way to justify, the mode in which I conceive of the mechanism of life, with the aid of the physical and chemical forces of nature only, and without invoking any mysterious or extraneous cause. - - -

[The remainder of M. Solvay's discourse is devoted to an examination of the phenomena of animal growth, reproduction, evolution (modification of species), and psychical activity, in the light of the views which he holds and advocates. But it is not possible to present this latter part of the discourse in intelligible abstract within the limits assigned, and reference must be made to the original in its complete form.

The author concludes by saying: "I await now, as the result of the most rigorous course of experiment pursued in the broadest and most extensive manner, an impartial and thorough examination of the scheme which has been the subject of much of my thought for so many years."

Any one interested in the line of thought and of research suggested by this discourse would do well to address a request for a copy of the original discourse *in extenso* to M. Ernest Solvay, sénateur, 43 Rue des Champs Elysées, Bruxelles, Belgium.—J. W. M.]

THE INFLUENCE OF CERTAIN AGENTS IN DESTROYING THE VITALITY OF THE TYPHOID AND OF THE COLON BACILLUS.¹

By JOHN S. BILLINGS and ADELAIDE WARD PECKHAM.

During the last year a series of researches upon the influence of light, of desiccation, and of the products of certain micro-organisms upon the vitality of some of the pathogenic bacteria has been carried on in the laboratory of hygiene of the University of Pennsylvania by Dr. Adelaide W. Peckham, in accordance with a general scheme for such investigation prepared by Dr. S. Weir Mitchell and Dr. Billings, the director of the laboratory, and with the aid of a grant from the Bache fund.

That direct sunlight kills or stops the growth of certain bacteria has been known since 1877, when Downes and Blunt presented to the Royal Society a report on "Researches on the effect of light upon bacteria and other organisms."² Since that date a number of papers on this subject have been published, the most important one in relation to the typhoid bacillus being that of Janowski in 1890.³ The first series of experiments by Dr. Peckham was made with the staphylococcus pyogenes aureus, the object being mainly to determine the best methods of investigation.

Photobacteriographs were made by Buchner's method, namely, by placing a square of black paper, or of glass of different colors, upon the bottom of a plate containing inoculated agar-agar during insolation; but although the protected portion was visible after fifteen minutes' insolation and incubation for twenty-four hours, and sharply defined after two hours' insolation and incubation as before, no accurate estimate could be made of the difference in the destructive power of different periods of insolation. Successful photobacteriography requires inoculation of large quantities of bacteria, in order that the colonies may be set so closely together that a ground-glass appearance

¹[An article under this title by the same authors was printed in *Science*, February 15, 1895.]

²*Proc. Roy. Soc.* 1877, Vol. XXVI, page 488.

³*Zur Biologie der Typhus Bacillen*, *Centralbl. f. Bakteriol.*, etc., VIII, 1890, pages 167, 193, 230, 262.

is produced, in which case counting of the colonies is practically impossible.

For this reason the following method was used for each of the three organisms, the staphylococcus pyogenes aureus, the bacillus coli communis, and the bacillus typhi abdominalis.

To obtain an accurate measure of the effects produced by lights of different intensity or of different colors, it is necessary to insure, as far as possible, that the bacteria to be experimented on shall be uniformly distributed in the culture media. Tubes containing each 10 c. c. of bouillon were inoculated with one drop of a bouillon culture and then placed in an incubator for twenty-four hours. A small quantity of sterilized gravel was then added to the culture tube and it was thoroughly shaken, after which 10 c. c. of a one-half per cent salt solution was added and the culture drawn into a Nuttall's dropping apparatus. From this one-twentieth of 1 c. c. of the bouillon culture was dropped into a tube of melted agar-agar, which was slowly and thoroughly agitated, and the contents were then poured into a Petri dish, carefully leveled on a leveling tripod over ice water. In the first method used the Petri dishes were found to be so uneven on the bottom that the layer of medium under the protective square was often very thick or very thin as compared with that about the circumference of the plate, and therefore comparisons made between the center and the circumference would be in almost every case unreliable. To overcome this difficulty just one-half of the plate was shaded with black paper or colored glass.

The plates were then exposed to sunlight bottom upward, so as to allow the sun to shine as directly as possible on the inoculated agar-agar. At intervals of fifteen minutes a plate was removed and placed in the incubator. The temperature of the plates during insolation was always below 34° C., as shown by a thermometer with a blackened bulb which was placed in the sun and the temperature noted every fifteen minutes. Sunny, still days were utilized for insolation, beginning at 10 a. m., during the months of October, November, and December. After insolation the plates, and also a noninsolated control plate, were incubated for twenty-four hours.

The colonies were counted in the following manner: A No. 1 eyepiece was divided into fields (as done by Nuttall in counting tubercle bacilli) by introducing a disk of black cardboard which had a square opening divided into four parts by two hairs placed at right angles. This eyepiece and an objective of low power were used in counting. The percentage of germs destroyed by insolation was estimated from the mean of four counts taken on both the insolated and the protected halves of the plate. By this method an accurate statement can be made regarding the difference in protective power given by the different colors, not from simple observation, but by comparison of a definite number of colonies counted.

The following table shows the comparative effect of the blue rays and of complete shadows on the growth of the organisms experimented on:

Percentages of organisms destroyed in the insolated half of the plate as compared with the protected half.

Time exposed.	Typhoid, shaded with—		Colon, shaded with—		Aureus, shaded with—	
	Black paper.	Blue glass.	Black paper.	Blue glass.	Black paper.	Blue glass.
	<i>Per ct.</i>	<i>Per ct.</i>	<i>Per ct.</i>	<i>Per ct.</i>	<i>Per ct.</i>	<i>Per ct.</i>
15 minutes.....	17	7	25	13
30 minutes.....	28	14	15	29	38
45 minutes.....	33	30	25	32	55	34
60 minutes.....	34	32	71	35	54
75 minutes.....	65	24	83	56	72	51
90 minutes.....	63	38	88	59	72	41
105 minutes.....	90	35	97	60	80	48
120 minutes.....	98	52	99	52	90	50

From this series of experiments the following results were obtained:

Insolation for fifteen minutes destroys to a slight extent each of the three organisms experimented upon. Two hours' insolation destroys 98 per cent of the germs and from three to six hours kills all. The colon bacillus is more easily destroyed by insolation than is the typhoid bacillus. Exposure to diffuse daylight, to gaslight, or to the incandescent electric light produces little effect. Red, orange, yellow, and green light produce little effect during two hours insolation; while the blue and violet rays kill nearly as rapidly and as certainly as full sunlight. Insolation from six to eight hours lessens the number of colonies under the protective square to a slight extent, for the colors red, orange, yellow, and green.

Plates were made in the same manner and exposed to diffused light for periods varying from fifteen minutes to two days. The exposure was made on clear sunny days in the light part of a room. In this experiment the result was negative, the number of colonies on the two sides of the plate being approximately the same.

An ordinary gas-burner and an incandescent light were each used as the source of illumination. The plates were placed bottom upward in a dark room near the light used. Illumination for sixteen hours with gas produced no effect on the growth of the organism as shown by counting of the colonies.

Illumination for four and one-half hours with an incandescent light also gave negative results.

A series of experiments was made with tubes of bouillon inoculated with the different organisms and then inclosed in larger tubes containing fluids of different colors—red, orange, yellow, and blue—which were exposed to sunlight with control tubes, one placed in water and the

other in a similar tube covered with black paper. The materials used for making the colored solutions were corallin, chromate and bichromate of potassium, and methylene blue. From these tubes plates were made, and the number of colonies counted.

It was found that an increase in the number of colonies continued to the eighteenth day, the number being greater in the colon and aureus cultures than in the typhoid. The colonies then began to decrease, and on the fifty-eighth day the plates contained but few colonies. In this experiment, as in the last, plates made from culture tubes placed in blue fluid showed fewer colonies.

Since the presentation of the above results, with details, charts, and tables, to the National Academy, in April, 1894, Dr. Dieudonné has published, in the *Arbeiten aus dem Kaiserlichen Gesundheitsamte*, a paper on the effects of sunlight on bacteria, in which he reports results substantially the same, and obtained by almost the same methods as those of Dr. Peckham.

Sunlight not only weakens or kills the typhoid and the colon bacillus, but it affects culture media so as to render them less capable of supporting the growth of these organisms. Dr. Peckham found that sterile bouillon insolated from one to ten days and then inoculated with the bacillus typhi abdominalis showed no diminution in the number of colonies as compared with a control plate made from a similar culture not so exposed. Twenty days insolation and then inoculation with the typhoid bacillus showed great decrease in the number of colonies on all the plates; some of them were sterile. Insolation of forty days, and inoculation in the same manner, gave very few colonies for each plate, probably the same as the number of germs introduced—i. e., there had been no development. Bouillon insolated fifty to sixty days and inoculated gave sterile tubes. This insolated bouillon after inoculation and incubation remained perfectly clear, and plates made after a week of incubation gave no more colonies than those made at the end of twenty-four hours. Its reaction was alkaline, but not intensely so.

Insolated agar-agar.—Of twenty-three tubes of agar-agar insolated twenty days and then inoculated with the bacillus typhi abdominalis, all except one remained sterile, and neither the bacillus typhi abdominalis nor the bacillus coli communis grew when inoculated in stripes on these plates. Of seven tubes of agar-agar insolated forty days and then inoculated with the bacillus of typhoid, all remained sterile. On four of these plates mold appeared after some days. Of seven tubes of agar-agar insolated forty days and then inoculated and incubated as before, all remained sterile.

Insolated gelatin.—Of ten gelatin tubes insolated forty days and then inoculated with the bacillus typhi abdominalis, six remained sterile, two contained a few colonies of bacillus typhi abdominalis, and two were contaminated.

The insolated bouillon was then kept in diffuse daylight for forty days and again inoculated with the typhoid bacillus. Within twenty-four hours the tubes of bouillon became turbid and plates made from them showed innumerable colonies.

It is difficult to account for the effect of insolation on culture media. Roux in his experiments on anthrax found that insolation of bouillon for two or three hours rendered it unsuitable for germination of the spores, but if the bacilli were introduced they would thrive. He attributes this alteration to some chemical change which the culture media undergo during the insolation. He found also that if the insolated media were kept in the dark or in diffuse daylight for a time, the original nutritive qualities were restored and germination of spores would take place. Geisler and Janowski observed the bactericidal properties of insolated media, but the latter could find no chemical alteration in such media.

Percy Frankland in his chapter on action of light on micro-organisms¹ concludes from the results obtained by many investigators "that the effect is due to a process of oxidation possibly brought about through the agency of ozone or peroxide of hydrogen, or both; that all apparently direct low temperature oxidations require the presence of water. And inasmuch as the bactericidal action of light is unquestionably a case of low temperature oxidation, there is the strongest presumptive evidence, as well as weighty experimental evidence, that moisture, which practically means the possibility of the presence of peroxide of hydrogen, or of some similar material, is essential for its manifestation."² Westbrook³ found that old broth cultures of the tetanus bacillus in an atmosphere of hydrogen were not in the least affected by exposure to sunlight, either in regard to their virulence or their rapidity of growth on reinoculation.

When the same culture was sealed up in the presence of air the micro-organisms were not only killed, but the material was completely harmless when inoculated into white mice. It was however, possible to obtain vigorous and virulent growths from cultures which had been made quite innocuous by the action of the sun. Oxygen was used up in the process. Under ordinary circumstances one might be tempted to explain the effect of sunlight in destroying bacteria by the drying of the organisms exposed to it, especially in the case of those bacteria which do not form spores, but our experiments show that desiccation

¹Micro-organisms in water, page 890.

²Gelatin, to which were added different amounts of the peroxide of hydrogen, was inoculated with the bacillus typhi abdominalis and poured into plates. Those plates in which more than one part of the peroxide to 5,000 of gelatin was used were sterile.

³Some of the effects of sunlight on tetanus cultures, Jour. of Pathol. and Bacteriol., III, Nov., 1894, page 71.

for months has little effect on the vitality of the typhoid or of the colon bacillus. To determine the influence of desiccation upon these organisms, and also upon the staphylococcus aureus, the following experiments were made:

Bouillon cultures of the bacillus typhi abdominalis, the bacillus coli communis, and the staphylococcus aureus were roughly dried on threads 1 cm. long and then desiccated, a portion being placed in a vacuum, another portion in a desiccator over sulphuric acid, and a third in a closet; all were kept in the dark. The result of the desiccation under the three different conditions is as follows:

Bacillus typhi abdominalis.—Lived in a vacuum from December 30 until July 24, or 207 days; in a desiccator over sulphuric acid from January 3 until July 24, or 213 days; in a closet from December 18 until July 24, or 229 days.

Bacillus coli communis.—Lived in a vacuum from November 29 until May 30, or 183 days; in a desiccator over sulphuric acid from January 3 until July 24, or 213 days; in a closet from December 30 until May 30, or 152 days.

Staphylococcus aureus.—Lived in a vacuum from November 29 until July 24, or 207 days; in a desiccator over sulphuric acid from October 25 until April 19, or 178 days; in a closet from February 13 until July 24, or 162 days.

It will be seen from these experiments that the organisms experimented on endure desiccation for five months, or more, without losing their vitality, and hence the slight evaporation which may have occurred in the insolation experiments had probably no influence on the results.

It is evident that sunshine must exercise considerable influence in destroying bacteria on the surface of soil, streets, etc., exposed to its influence, but its action is almost confined to the surface, as appears from the results obtained by Esmarch in attempts to disinfect bedding and clothing by this agency. While the light from an incandescent electric lamp has little germicidal effect, that from a powerful arc lamp produces effects similar to those of sunlight, and it has been proposed to use this means to disinfect the walls of infected rooms. The bacillus of tuberculosis appears to be more quickly destroyed by light than the typhoid or the colon bacillus, being killed by exposure to simple diffused daylight in about a week,¹ and this fact should be borne in mind in advising measures to prevent the diffusion of this organism.

The investigations upon the typhoid and the colon bacilli referred to in this paper were undertaken as part of a general scheme of inquiry to ascertain the agencies which tend to destroy the typhoid bacillus when it is introduced into a source of water supply, as, for example, into a running stream. An important part of this investigation relates

¹Ueber bacteriologische Forschung: Vortrag in der ersten allgem. Sitzung des X. internationalen Congress, 1890.

to the influence of the common water bacteria or of their products upon the vitality of the typhoid bacillus.

A research relating to the influence of the common water bacteria or of their products upon the vitality of the typhoid and colon bacilli was then undertaken. Three series of experiments were made, the first to ascertain whether the typhoid and colon bacilli would grow on media containing the products of growth of the water bacteria; the second to verify the first, to meet any objection that might be raised as to the sterilization by heat of the medium in which the water organisms had grown, as the opinion has been advanced that some products of the activity of bacteria are either volatile or rendered inert by high temperatures. The third experiment was made to find whether the two organisms would grow with the water bacteria. These series of experiments were conducted in the following manner:

(1) Forty-four varieties of bacteria obtained from the water of the Schuylkill River were used in the first experiment. A pure culture of each organism was inoculated upon slanted tubes of agar-agar and allowed to attain a luxuriant growth. The tubes were then thoroughly sterilized in the steam sterilizer, the reaction was taken, and the medium was again slanted. A set of these tubes was then inoculated with the bacillus typhi abdominalis, and a second set with the bacillus coli communis. As a result of this research it was found that the typhoid and colon bacilli grew upon these tubes in every instance, the growths varying in thriftiness from luxuriant ones on some tubes to transparent films on others.

(2) In the second series which were made to verify the first—that is, to find whether the products of the activity of water bacteria in the medium used would retard or prevent the growth of the typhoid and colon bacilli—the water bacteria were inoculated into Erlenmeyer flasks of bouillon, each containing 70 c. c., and placed in the incubator. After being incubated from fifteen to twenty days the cultures were filtered through porcelain, the reaction was taken, and the filtrate was run into sterilized tubes. Two sets were made as before and inoculated with the typhoid and the colon bacilli, respectively. These tubes were then incubated for twenty-four hours, and from them gelatin tubes were inoculated and poured into Petri plates. In each of these inoculated filtrates the two organisms grew in a characteristic manner and multiplied for at least four days.

(3) In the third experiment thirty-nine varieties of the water bacteria were inoculated into tubes, each containing 10 c. c., of sterilized tap water and 5 drops of sterilized bouillon. Two sets of tubes were made as before, and each set inoculated with one of the organisms which was being tested, and each tube contained a different variety of water bacteria. From these tubes gelatin plates were made each day for more than twelve days. Both bacilli gave characteristic colonies with each of the water organisms except two, which had apparently an antagonistic

effect upon their development. They were both members of the subtilis group. In other members of this group this peculiarity was absent. The typhoid bacillus in several instances outlived its associate organism. In one instance a gelatin plate made from a tube of sterilized bouillon inoculated with the typhoid bacillus and a water bacterium one hundred and sixty days previously, gave characteristic colonies of the bacillus typhi abdominalis.

MODERN DEVELOPMENTS OF HARVEY'S WORK IN THE TREATMENT OF DISEASES OF THE HEART AND CIRCULATION.¹

By Dr. T. LAUDER BRUNTON, F. R. S.

This annual meeting in memory of Harvey is usually associated with feelings of pleasure and happiness, for it was intended by its immortal founder to commemorate the benefactors of the college and to encourage good fellowship among us.

Such commemoration of those who have benefited the college in the past, although it necessarily recalls many who have passed away, is, notwithstanding, on ordinary occasions, pleasant instead of painful, because the feeling of loss through their death is completely overpowered by the recollection of the good they have done in their lifetime. To-day the case is very different, for the first thought that must needs occur to everyone present here is that on this occasion last year our late president showed for the first time what seemed to be imperfect fulfilment of his duty to the college by being late in his attendance at the meeting. Perhaps nothing else could have shown more clearly his deep concern for the welfare of the college and his thorough devotion of every faculty of mind and body to its interests than the fact that no duty, no pleasure, and no press of occupation could tempt him to leave one iota of his work in the college undone. The only thing that did keep him back was the hand of death, which, although at the last meeting he and we knew it not, was already laid upon him. Though his death was less happy than that of the great Harvey, inasmuch as he lingered on for days instead of hours after he was first struck down, yet their deaths were alike in this respect that, up to the time of the fatal attack, each was in the full possession of his faculties, each was in the enjoyment of his life. Like Radeliffe and Mead, like Halford and Baillie, and like many other distinguished fellows of this college, the greatness of Clark is to be estimated not by the published works which he has left behind but by the influence he exerted on his con-

¹The Harveian oration, delivered at the Royal College of Physicians on October 18, 1894, by Dr. T. Lauder Brunton, F. R. S. Printed in *Nature*, No. 1304, Vol. L, October 25, 1894.

temporaries. For the very estimation in which his professional skill was held led to his whole time being taken up in giving advice and prevented him from having the leisure to work out or record the results of the pathological and clinical observations which both his youthful publications and his later career showed him to be specially fitted to make. I might say very much more about him, but it has already been said much better than I could possibly do it by yourself, Mr. President, in your annual address and in the eloquent and heart-stirring words which you addressed to the college on the occasion of your taking the presidential chair rendered vacant by the death of Sir Andrew Clark.

But while we were saddened to-day by the death of our late president we hope to be gladdened by the presence among us again of one whom we all reverence not only as a former president of this college, but as one of the greatest leaders of clinical medicine in this century, Sir William Jenner. Like Harvey, Sir William Jenner is honored by his college, by his country, by his sovereign, and by the world at large. In times of trial and danger the lives of the royal children were committed to the keeping of Harvey by his king, and to-day the care not only of her own life but of that of her nearest and dearest is committed to Sir William Jenner by his sovereign in the full and well-grounded assurance that in no other hands could they be more safe. The great clinician, Graves, wished to have as his epitaph, "He fed fevers;" but Jenner has advanced much beyond Graves, and by showing us how to feed the different kinds of fevers has saved thousands of valuable lives. To-day this college is acknowledging his right to rank with Sydenham, Heberden, Bright, and Garrod by bestowing upon him the Moxon medal for clinical research. In numbering Sir William among its medalists the college honors itself as well as him, and in acknowledging the great services he has rendered, it is, on this occasion, acting as the mouthpiece of the medical profession not only in this country, but in the world at large.

It was with the wish to keep green the memory of the benefactors of the college that this oration was instituted by Harvey, and not at all with the intention that it should be devoted to his own praise. But Harvey stands out so high above all others that it is only natural that in the numerous orations which have been yearly given before the College of Physicians, the subject-matter should have been to a great extent confined to a consideration of Harvey and his works. On looking over many of these orations I find that everything I could say about Harvey—his person, his circumstances, his character, and his works—has already been said so fully and eloquently that I could not add to it anything further, nor could I hope to express it even so well. I purpose, therefore, to consider to-day some of the modern developments of Harvey's work, more especially in relation to the treatment of diseases of the heart and circulation. There is, I think, a certain advantage in this also, inasmuch as one is apt by considering Harvey's work only as

he left it to overlook the enormous extent to which it now influences our thoughts and actions, and thus to comprehend its value very imperfectly.

As he himself says, "From a small seed springs a mighty tree; from the minute gemmule or apex of the acorn, how wide does the gnarled oak at length extend his arms, how loftily does he lift his branches to the sky, how deeply do his roots strike down into the ground!"¹

How very minute is the gemmule from which has sprung everything that is definite in medical science, for this gemmule is no other than the idea which Harvey records in these simple words, "I began to think whether there might not be motion, as it were, in a circle."

Out of this idea has grown all our knowledge of the processes of human life in health and disease, of the signs and symptoms which indicate disease, of the mode of action of the drugs and appliances which we use and the proper means of employing them in the cure of disease. In the works that have come down to us we find that Harvey developed his idea physiologically in several directions. He discussed its application to the absorption and distribution of nourishment through the body, the mixing of blood from various parts, the maintenance and distribution of animal heat, and excretion through the kidneys. How far he developed it in the direction of pathology and therapeutics we do not know, as the results of his labors on these subjects have, unfortunately, been lost to us by the destruction of his manuscripts during the civil war.

We are proud to reckon Harvey as an Englishman by birth, but he is far too great to belong exclusively to any country; men of various nations and scattered all over the face of the earth acknowledge him as their teacher, and have played, or are playing, a part in developing his discovery in its various branches of physiology, pathology, pharmacology, semeiology, and therapeutics. Americans, Austrians, Danes, Dutchmen, Frenchmen, Germans, Italians, Norwegians, Russians, and Swedes have all shared in the work, and so numerous are they that it would be impossible for me to name them all. Stephen Hales, however, deserves special mention, for he was the first to measure the pressure of blood in the arteries, and the resistance offered to the circulation of the blood by the capillaries was investigated by Thomas Young, a fellow of this college, who ranks with Harvey, Newton, and Darwin as one of the greatest scientific men that England has ever produced, and whose undulatory theory has been as fertile of results in physics as Harvey's idea of circulation has been in physiology and medicine.

Harvey's desire that those who had done good work should not be forgotten was founded upon his knowledge of mankind, and of the tendency there is to forget what has already been done by those who have gone before us. The opposite condition often prevails, and the past is glorified at the expense of the present. But sometimes the present is

¹The Works of W. Harvey, Sydenham Society's edition, page 320.

wrongly glorified at the expense of the past, and past work or past benefits are forgotten.

Good examples of this are afforded by physiological views regarding the action of the vena cava and pulmonary veins and the causation of the cardiac sounds. Harvey appears to have thought that the vena cava and pulmonary veins were simply dilated passively by the passage of blood into them; but the fact that they possess a power of independent pulsation was known to Haller,¹ and was brought prominently forward by Senac,² who regards the vena cava as the starting point of the whole circulation. He says: "The vena cava is therefore the first motor cause which dilates the cavities of the heart; it fills the auricles, and extends their walls in every direction."

These observations appear to have been almost forgotten until they were again made independently a few years ago,³ and in one of the latest and most accurate physiological treatises which now exist the description of the cardiac cycle is nearly the same as that given by Senac. "A complete beat of the whole heart, or cardiac cycle, may be observed to take place as follows:

"The great veins, inferior and superior venæ cavæ, and pulmonary veins are seen, while full of blood, to contract in the neighborhood of the heart; the contraction runs in a peristaltic wave toward the auricles, increasing in intensity as it goes."⁴

The pulsation of these veins, however, can not be a constant phenomenon, or it would have been noticed by such a keen observer as Harvey.

The sounds of the heart were discovered by Harvey, or at least were known to him, for he speaks of the sound caused in the esophagus of the horse by drinking, and says: "In the same way it is with each motion of the heart, when there is a delivery of blood from the veins to the arteries, that a pulse takes place and can be heard within the chest." This observation remained, as far as we know, without any further development until the time of Laennec, who introduced the practice of auscultation; but it was a fellow of this college, Dr. Wollaston,⁵ who first discovered that the muscles during contraction give out a sound; and although many observations were made regarding cardiac murmurs by Corrigan, Bouillaud, and Piorry, it was chiefly by fellows of this college, Dr. Clendinning, Dr. C. J. B. Williams, and Dr. Todd, that the question was finally settled, and the conclusions at which they arrived are those now accepted as correct, viz, that "the first or systolic sound is essentially caused by the sudden and forcible tightening of the muscular fibers of the ventricle when they contract; and that the second sound which accompanies the diastole of the ventricle

¹ Haller. *Elementa Physiologiae*, 1757, Tome I, pages 410 and 399.

² Senac. *De la Structure du Cœur*, Livre IV, Chapter III, page 24.

³ *Proc. Roy. Soc.*, 1876, No. 172.

⁴ M. Foster. *Text-book of Physiology*, 6th ed., Part I, Chapter IV, page 231.

⁵ Wollaston. *Phil. Trans.*, 1810, page 2.

depends solely on the reaction of the arterial columns of blood in the semilunar valves at the arterial orifices."¹

Yet in recent discussions regarding the origin of cardiac sounds little mention has been made of the work of this committee; and, indeed, I first learned of the value of the work from a German source, Wagner's *Handwörterbuch der Physiologie*.

The importance of these observations in the diagnosis of heart disease it would be hard to overestimate. But diagnosis alone is not the aim of the physician, whose object must be to prevent, to cure, or to control disease. A knowledge of physiology may greatly help us to prevent disease, not only of the heart and vessels, but of every member of the body. The control and cure of disease may also be effected by diet and regimen, but it is undoubtedly in many cases greatly assisted by the use of drugs, and is sometimes impossible without them. Harvey knew that drugs applied externally are absorbed and act on the body,² so that colocynth thus applied will purge and cantharides will excite the urine; but the action of drugs when injected into the blood appears to have been tried first by Christopher Wren, better known as the architect of St. Paul's than as a pharmacologist. According to Bishop Spratt, "He was the first author of the noble anatomical experiment of injecting liquors into the veins of animals, an experiment now vulgarly known, but long since exhibited to the meetings at Oxford, and thence carried by some Germans and published abroad. By this operation divers creatures were immediately purged, vomited, intoxicated, killed, or revived, according to the quality of the liquor injected. Hence arose many new experiments, and chiefly that of transfusing blood, which the society has prosecuted in sundry instances, that will probably end in extraordinary success."³

The method originated by Wren, of injecting drugs into the circulation, was skillfully utilized by Magendie for the purpose of localizing the particular part of the body upon which the drugs exerted their action, and he thus conclusively proved that the symptoms produced by strychnine were due to its effect on the spinal cord. His experiments showed that the rate of absorption from various parts of the body varied enormously, and, through the teaching of Christison, led to the introduction into practice by Dr. Alexander Wood of that most useful aid to modern therapeutics, the hypodermic syringe.

The first quantitative experiments on the effect of drugs upon the circulation were made, to the best of my knowledge, by James Blake, in 1844, in the laboratory of University College, at the suggestion of the late Professor Sharpey, with the hemodynamometer of Poiseuille, which had then been recently introduced.

¹ Report of committee consisting of C. J. B. Williams, R. B. Todd, and John Clendinning, "Brit. Assoc. Rep. for 1836," page 155.

² The Works of William Harvey, Sydenham Society edition, page 72.

³ The History of the Royal Society of London for the Improving of Natural Knowledge, by Thomas Spratt; late lord bishop of Rochester.

In speaking about the work of Blake and Sharpey, who are both dead, one requires to use the greatest care not to unduly detract from the merit of one by ascribing more to the other; but those who knew Professor Sharpey's enormous range of knowledge, his readiness to put it all at the disposal of others, and the influence he exerted upon all who came in contact with him, as well as his unselfishness in making no claim whatever to what was justly his due, will at once recognize how greatly Blake was indebted to Sharpey. More especially is this the case when we consider that, although the credit for the observations themselves belongs to Blake, yet after the impetus which Sharpey gave him had passed away, he did very little more during the course of a long life. It seems all the more necessary to commemorate Sharpey on this occasion, because he has left comparatively few writings behind him, and anyone who should judge by them alone of his influence upon physiological progress in this country would grievously underestimate it; for Sharpey was above all a teacher, and his work was written not with pen and ink on paper or parchment, but was engraved upon the hearts and minds of his pupils and friends. Upon two of these, especially, has Sharpey's mantle fallen, and to Burdon-Sanderson and Michael Foster we owe a revival of experimental physiology in this country, a revival of the method which Harvey not only used in making his great discovery, but also employed to demonstrate the truth of it to the rulers of this land. By their writings, by their lectures, by their original experiments, by their demonstrations, and by the pupils they have trained, Burdon-Sanderson and Michael Foster, under the auspices of Acland and Humphrey, have diffused among the medical men of this country a knowledge of physiology so extensive and exact as could only be found before their time among those who had made a special study of the subject. Yet more than to them, more than to anyone else since the time of Harvey, do we owe our present knowledge of the circulation to Carl Ludwig. He it is who first enabled the pressure of blood in the arteries to record its own variations automatically, so that alterations could be noticed and measured which were too rapid or too slight to be detected by the eye. To him also we owe the plan of artificial circulation, by which the changes in the functions of the organs and in the vessels which supply them can be observed quite apart from the heart, lungs, or from the nervous system.

Like Sharpey, Ludwig is a great teacher, and like the great architects of the Middle Ages, who built the wonderful cathedrals which all admire, and the builder of which no man knows, Ludwig has been content to sink his own name in his anxiety for the progress of his work and in his desire to aid his pupils. The researches which have appeared under these pupils' names have been in many instances, perhaps in most, not only suggested by Ludwig, but carried out experimentally with his own hands, and the paper which recorded the results finally written by himself. In the papers which have appeared under his pupils' names we find their obligations to the master recorded in such terms as "unter

Mitwirkung." But no one except those who have worked with him can understand what such cooperation meant.

The graphic method introduced by Ludwig for the purpose of measuring the blood pressure was adapted by Volkmann to the registration of the pulse in man, and the same method has been modified and rendered more easily applicable at the bedside by Marey and Chauveau, to whom we chiefly owe our knowledge of the modifications in the form of the apex beat and of the pulse curve. It is to Ludwig and his scholars, however, that we owe the greater part of our knowledge of the mechanism of the circulation and of the varying distribution of the blood in various parts of the body.

The effect of emotion upon the heart was carefully noted by Harvey, who says: "For every affection of the mind which is attended with pain or pleasure, hope or fear is the cause of an agitation whose influence extends to the heart."¹

Not only was Harvey well acquainted with the fact that the beats of the heart vary very much in strength and force, but he also knew that the circulation in various parts of the body may be very different at one and the same time. He says:

"It is manifest that the blood in its course does not everywhere pass with the same celerity, neither with the same force in all places and at all times, but that it varies greatly according to age, sex, temperament, habit of body, and other contingent circumstances, external as well as internal, natural or nonnatural. For it does not course through intricate and obstructed passages with the same readiness that it does through straight, unimpeded, and pervious channels. Neither does it run through close, hard, and crowded parts with the same velocity as through spongy, soft, and permeable tissues. Neither does it flow and penetrate with such swiftness when the impulse (of the heart) is slow and weak, as when this is forcible and frequent, in which case the blood is driven onwards with vigor and in large quantity.

"And what, indeed, is more deserving of attention than the fact that in almost every affection, appetite, hope, or fear, our body suffers, the countenance changes, and the blood appears to course hither and thither? In anger, the eyes are fiery and the pupils contracted; in modesty, the cheeks are suffused with blushes; in fear and under a sense of infamy and of shame, the face is pale, but the ears burn as if for the evil they heard or were to hear; in lust, how quickly is the member distended with blood and erected."²

Harvey's great contemporary, Milton, though so violently opposed to him in politics, would certainly not remain in ignorance of Harvey's work, and he has noted the changes in the color of the face produced by emotions. In describing the behavior of Satan on his journey from hell to Paradise, he says:

Thus while he spake, each passion dimm'd his face,
Thrice changed with pale—ire, envy, and despair,
Which marr'd his borrow'd visage.³

¹ "The Works of William Harvey," Sydenham Society's edition, page 70.

² *Ibid.*, pages 128-129.

³ *Paradise Lost*, by John Milton, Book IV, page 85.

But although these facts were known to Harvey so long ago, it is only in comparatively recent years that the mechanism by which they are brought about has been investigated, and it is only within the last decade that physiologists have begun regularly to believe that the cardiac muscle has a power of rhythmic pulsation independent of its nerves, although Harvey had noted that when the heart was cut into small pieces the fragments would still continue to pulsate. We may fairly, indeed, compare the movements of the heart, as regarded by physiologists of the present day, to those of a horse, which is capable of going independently, although its pace may be slowed or accelerated by the reins or spur of the rider. The power of the vagus to act as a rein to the heart, and slow its movements or stop them altogether, was first noted by Edward and Ernest Heinrich Weber, while the effect that it sometimes has of accelerating instead of slowing, like the effect of shaking the reins of the horse, was observed by Schiff, Moleschott, and Lister.

The accelerating nerves of the heart, and the position of the nerve center from which they spring, were more thoroughly investigated by von Bezold,¹ while the power of the vagus to weaken as well as slow the heart was observed by Gaskell. The position of the cardiac center, which, like the rider, regulates the movements of the heart, was located in the medulla oblongata chiefly by Ludwig and his scholars. Like the heart, the vessels also are regulated in diameter by the nervous system in accordance with the wants of the body generally; and the effect upon the vasomotor nerves, which when cut allow them to dilate and when stimulated cause them to contract, was discovered by Bernard, Brown-Séguard, and by our countryman, Waller; while the power of other nerves to cause immediate dilatation was discovered by Bernard, Eckhardt, and Ludwig in the submaxillary glands, penis, and peripheral vessels, respectively.

The heart when cut out of the body still continues to beat, and the transmission of excitation from one cavity to another was experimented on by Paget, although removed completely from the influence of the central nervous system, and the vessels have a somewhat similar power of independent contractility. The alterations produced in the circulation generally and locally by the contractile power of the vessels and the changes caused in the vessels by the central nervous system by peripheral stimulation of the nerves or by variations in the quality of the blood have formed the subject of a series of researches extending over many years, and though originated and in many cases entirely conducted by Ludwig have appeared to a great extent under the names of his pupils. The starting point of these investigations was an examination of the changes in the blood as it flowed through isolated organs, with the view of ascertaining in what manner the combustion by which the animal heat

¹Von Bezold. Untersuchungen über die Innervation des Herzens, 1863. Leipzig: Engelmann.

is maintained was effected in the body. While keeping up the circulation of blood through the vessels of muscles severed from the body, Ludwig and Sezelkow¹ observed variations in the flow which appeared to indicate contractile power in the vessels themselves. This research was carried on under Ludwig's direction by various of his scholars in succession, Alexander Schmidt, Dogiel, Sadler, myself, Hafiz, Lépine, A. Mosso, von Frey, and Gaskell. Their observations, as well as those of Cohnheim and Gunning, have shown that the muscular fibers of the arterioles, not only in the muscles but throughout the body generally, have a power of independent and sometimes rhythmical contraction and relaxation. Their contractility is, however, controlled by the central nervous system in accordance with the wants of the body generally, for the amount of blood contained in the body is insufficient to fill the whole of the vascular system at once, and when the vessels are fully dilated, as they are after death, we find that nearly the whole of the blood of the body may be contained in the veins alone. It is therefore necessary that when one part of the body is receiving a larger supply of blood another should be receiving a smaller supply; and the functions of the vaso motor centers have been well compared by Ludwig to the turncocks in a great city, who cut off the water supply from one district at the same time they turn it on to another. Thus it is that when the brain is active the feet may get cold, and Mosso has shown this in an exceedingly neat manner by placing a man on a large board delicately balanced at its center, and demonstrating that whenever the man began to think the increased supply of blood to his brain caused the head to go down and the heels to rise up. A similar condition was indicated by Mayow, who gave a different explanation. He said that the vital spirits were not able to be in the same place at once, and therefore it happens that if a man eats a heavy meal he is apt to become drowsy, because the vital spirits descend from the brain to the stomach in order to carry on digestion; and, on the other hand, if a man thinks vigorously after dinner the vital spirits have to leave the stomach to go to the brain, and consequently digestion is imperfectly performed. If we substitute the word blood for vital spirits we have an exact expression of present physiological ideas.

Ubi stimulus ibi affluxus was an old doctrine and expressed a great truth. Wherever the need for increased nourishment or increased supply of oxygen exists in the healthy body, thither does the blood flow in larger quantities than usual. If the glands are active their blood supply is greatly increased, as was shown by Bernard, and a similar occurrence takes place in the contracting muscle, as has been shown by Ludwig and his scholars. The vessels of the intestines and of the skin, with their numerous glands, have their caliber regulated by the vasomotor nerves which proceed from the center in the medulla oblon-

¹Ludwig and Sezelkow. Henle and Pflügers Zeitschrift, 1863, Vol. XVII, page 106 and vide page 122.

gata. This center acts most readily upon the vessels of the intestine, and rather less readily on those of the skin. In consequence of this, when the center is irritated, the vessels of the intestine contract and drive the blood through the skin, so that it is warmer than before, and it is only when the stimulation is very great that the vessels of both contract so that the skin receives less blood than normal and becomes colder than before. But if the vessels of the skin and intestine are both contracted, where does the blood go? This question was put by Ludwig, and answered by the experiments which he made with Hafiz. It is evident that if the heart be stopped while the blood pressure is being measured in the artery of an animal the pressure will fall regularly and steadily, because the blood is flowing out all the time through the arterioles and capillaries into the veins. One would naturally expect that if the arterioles were contracted by irritation of the vasomotor centers in the medulla the fall of blood pressure would either not take place at all or would be very much slower than before; but on trying the experiment, Ludwig and Hafiz found to their surprise that the blood pressure fell almost as quickly as when the vasomotor center was left alone, and the vessels of the skin and intestine therefore remained uncontracted. In other words, the vessels which supply the muscles of the body and limbs are capable of such extension that when fully dilated they will allow the arterial blood to pour through them alone nearly as quickly as it usually does through the vessels of the skin, intestine, and muscles together. This observation, it seems to me, is one of the greatest importance, and one that has hardly received as yet the attention which it merits.

It is obvious that contraction of the cutaneous vessels, such as occurs upon exposure to cold, will drive more blood through the muscles, and as oxidation goes on more rapidly in them the result will be increased production of heat.

The experiments I have just mentioned show that the vessels of the muscles are not controlled by the vasomotor center in the medulla oblongata in the same way as those of the intestine and skin. How far their vascular centers may be associated with those for voluntary movements, which have been so admirably localized by Ferrier in the cerebral cortex, still remains to be made out. The circulation through the muscles is indeed a complex phenomenon, and it was shown by Ludwig and Sadler to depend upon at least two factors having an antagonistic action. When a muscle is thrown into action, it mechanically compresses the blood vessels within it, and thus tends to lessen the circulation through it, but at the same time the stimulus which is sent down through the motor nerve, and which calls it into action, brings about a dilatation of the vascular walls, and thus increases the circulation through the muscle.

When the amount of blood is measured before, during, and after stimulation of its motor nerves, it is sometimes found that the flow is

diminished, at others that it is increased, the alteration depending upon the comparative effect of the mechanical compression of the vessels of the muscles just mentioned, and upon the increase of their lumen by the dilatation of their walls. It invariably happens, however, that after the muscle has ceased to act, the flow of blood through the muscle is increased. This increase is quite independent of any alteration in the general pressure of blood in the arteries, and it occurs when an artificial stream of blood, under constant pressure, is sent through the muscle. The dilatation in the muscular vessels, as indicated by the increased flow of blood, and consequent change of color in the frog's tongue, was observed by Lépine after stimulation of the peripheral ends of the hypoglossal and glossopharyngeal nerves, and the actual changes in the vessels themselves were observed microscopically by von Frey and Gaskell.

The dilatation of muscular vessels on irritation of peripheral nerves was thus brought into a line with the dilatation noticed in the vessels of the submaxillary gland by Bernard, and in the corpora cavernosa by Eckhart. It is evident that alteration in the size of such a huge vascular tract as the muscular arteries must influence, to a great extent, the blood pressure in the arteries generally, and it is equally evident that the changes induced in the condition of the blood pressure by muscular action may be of two kinds, either a rise or a fall. If the arterioles are compressed by the muscles so that the flow through them is impeded, the general blood pressure will rise. When this effect is more than counteracted by the dilatation of the arterioles themselves under nervous influence the general blood pressure will fall, for the blood will find an easy passage through the vessels from the arteries into the veins. We can thus see how readily a rise or fall in the general blood pressure may be induced by exercise of the muscles. If they contract suddenly or violently they will tend to compress the arterioles, and raise the blood pressure, while quite easy contraction will have little effect in compressing the arterioles, and these, becoming dilated, will allow the blood pressure to fall.

But there is still another factor which may tend to increase the blood pressure during severe muscular exertion, viz, a quickened pulse for stimulation of the nerve fibers extending from the muscles to the central nervous system greatly accelerates the beats of the heart. In this respect stimulation of the muscular nerves differs from that of the cutaneous and visceral nerves, inasmuch as the latter tend rather to slow than to quicken the pulse. The peculiar effect of the muscular nerves upon the heart would, indeed, appear to be a provision of nature for the purpose of maintaining an exceedingly active circulation during the active calls upon nutrition which violent exertions entail. Muscular exercise, therefore, has a special tendency to raise the blood pressure in the arterial system, and consequently to increase the resistance which the left ventricle has to overcome. Moreover, in the case of the

intestinal vessels there is a special provision made for preventing their contraction from causing too great a rise of arterial pressure. This consists in the depressor nerve, which passes from the heart and tends to produce dilatation of the abdominal vessels, and thus prevent any undue pressure occurring within the heart from their excessive contraction.

In the case of the muscles, we have no such nerve. Its place seems to be taken by the dilating fibers which occur in the motor nerves. As I have already said, however, this effect of dilatation in the muscular vessels may be at first more than counteracted by mechanical compression at the commencement of exertion, and thus the blood pressure in the arteries, and the resistance which it opposes to the contraction and emptying of the ventricle, may be unduly increased.

As a general rule the distention of any hollow muscular organ is attended with great pain. How great is the suffering when obstruction of the bowel prevents evacuation of its contents; or when a calculus, in its passage down the gall duct or ureter, forcibly distends their wall. One of the severest tortures of the Middle Ages was to distend the stomach with water, and the Emperor Tiberius could imagine no more awful punishment for those whom he hated than to make them drink wine, and at the same time, by means of a ligature, to prevent the distended bladder from emptying itself. The heart is no exception to this rule, and distension of its cavities brings on most acute physical suffering. Its inability to empty itself is a question of relative and not of absolute power; for a strong heart may be unable to work only against enormously increased resistance in the peripheral arterioles, while the heart, weakened by degeneration, may be unable to empty itself in face of pressure little, if at all, above the normal.

When the contractile power of the heart is not, as it is in health, considerably in excess of the resistance opposed to it in vessels, but only nearly equal to it, a slight increase in the resistance may greatly interfere with the power of the heart to empty itself, and bring on pain varying in amount from slight uneasiness to the most intense agony in angina pectoris. This is indeed what we find for a heart whose nutrition has been weakened by disease of the arteries, and consequent imperfect supply of blood to the cardiac muscle is unable to meet any increased resistance if this should be offered to it, and pain is at once felt. In such cases, unless they be far advanced, we find precisely as we might expect, that walking on the level usually causes no pain, but the attempt to ascend even a slight rise, by which the muscles are brought into more active exertion, brings on pain at once. Yet here again we find, as we should expect, that if the patient is able to continue walking the pain passes off and does not return. These phenomena would be inexplicable were it not for Ludwig's observations on circulation through the muscles, but in the light of these observations everything is made perfectly intelligible. Walking on the flat, by

causing no violent exertion of the muscles, produces no mechanical constriction of the vessels, and thus does not increase the blood pressure. The greater exertion of walking up a hill has this effect, but if the patient is able to continue his exertions, the increased dilatation of the vessels—a consequence of muscular activity—allows the pressure again to fall and relieves the pain.

As muscular exertion continues and the vessels of the muscles become dilated, the flow of blood from the arteries into the veins will tend to become much more rapid than usual. The pressure in the arterial system will consequently fall, but that in the veins will become increased, and unless a corresponding dilatation occurs in the pulmonary circulation, blood will tend to accumulate in the right side of the heart, the right ventricle will be unable to empty itself completely, shortness of breath will arise, and even death may occur. At first the right side of the heart is affected, and the apex beat disappears from the normal place and is felt in the epigastrium, but the left ventricle also becomes dilated, though whether this is simply through nervous influence tending to make it act concordantly with the right, or for some other reason, it is at present impossible to say. Severe exertion, even for a few minutes, may produce this condition in healthy persons,¹ and when the exertion is overcontinued it may lead to permanent mischief. More especially is this the case in young growing boys, and it is not merely foolish, it is wicked to insist upon boys engaging in games or contests which demand a long-continued overexertion of the heart, such as enforced races and paper chases extending over several miles. Intermittent exertion, either of a single muscle or of a group of muscles, or of the whole body, appears to lead to better nutrition and increased strength and hypertrophy, but overexertion, especially if it continues, leads to impaired nutrition, weakness, and atrophy. If we watch the movements of young animals, we find that they are often rapid, but fitful and irregular and varied in character, instead of being steady, regular, and uniform. They are the movements of the butterfly, and not of the bee. The varied plays of childhood, the gambols of the lamb, and the frisking of the colt are all well adapted to increase the strength of the body without doing it any injury; but if the colt, instead of being allowed to frisk at its own free will, is put in harness, or ridden in races, the energy which ought to have gone to growth is used up by the work, its nutrition is affected, its powers diminished, and its life shortened. The rules which have been arrived at by the breeders of horses ought to be carefully considered by the teachers of schools, and by the medical advisers who superintend the pupils.

In youth and middle age every organ of the body is adapted for doing more work than it is usually called upon to do. Every organ can, as it is usually termed, make a spurt if required; but as old age comes on this capacity disappears, the tissues become less elastic, the arteries

¹ Schott, Verhandl. des IX Congresses in Med. zu Wien, 1890.

become more rigid and less capable of dilating and allowing freer flow of blood to any part whether it be the intestine, the skin, the brain, the muscles, or the heart itself. Mere rigidity of the arteries supplying the muscles of the heart will lessen the power of extra exertion, but if the vessels be not only rigid, but diminished in caliber, the muscles of the limbs and the heart itself will be unfit even for their ordinary work, and will tend to fail on the slightest overexertion. This fact was noticed by Sir Benjamin Brodie, who, when speaking of patients with degenerating and contracted arteries, such as lead to senile gangrene, said:

“Such patients walk a short distance very well, but when they attempt more than this the muscles seem to be unequal to the task, and they can walk no farther. The muscles are not absolutely paralyzed, but in a state approaching to it. The cause of all this is sufficiently obvious. The lower limbs require sometimes a larger and sometimes a smaller supply of blood. During exercise a large supply is wanted on account of the increased action of the muscles; but the arteries being ossified or obliterated, and thus incapable of dilatation, the increased supply can not be obtained. This state of things is not peculiar to the lower limbs. Wherever muscular structures exist the same cause will produce the same effect. Dr. Jenner first, and Dr. Parry, of Bath, afterwards, published observations which were supposed to prove that the disease which is usually called angina pectoris depends on ossification of the coronary arteries. . . . When the coronary arteries are in this condition they may be capable of admitting a moderate supply of blood to the muscular structure of the heart, and as long as the patient makes no abnormal exertion the circulation goes on well enough; when, however, the heart is excited to increased action, whether it be during a fit of passion, or in running, or walking upstairs, or lifting weights, then the ossified arteries being incapable of expanding so as to let in the additional quantity of blood, which under these circumstances is required, its action stops and syncope ensues; and I say that this exactly corresponds to the sense of weakness and want of muscular power which exists in persons who have the arteries of the legs obstructed or ossified.”¹

But the syncope and stoppage of the heart mentioned by Brodie are not the only consequences of impaired cardiac nutrition. The heart may be still able to carry on the circulation, but the patient may suffer intense pain in the process. The outside of the heart was found by Harvey to be insensible to light touches, but the inside of the heart appears to be much more sensitive either to touch or pressure.

A knowledge of the mode of circulation of blood through the muscles enables us to understand not only the pathology of angina pectoris, but the rationale of various methods of treating patients suffering from angina pectoris or other forms of heart disease. In most cases our object is a twofold one—to increase the power of the heart and to lessen the resistance it has to overcome. In some cases we require also to aid the elimination of water which has so accumulated as to give rise to œdema of the cellular tissues or dropsy of the serous cavities. In our

¹Lectures on Pathology and Surgery, by Sir Benjamin Brodie, London, 1846, page 360.

endeavors to produce these beneficial changes in our patients we employ regimen, diet, and drugs, and it is evident that as in one case the condition of a patient's heart may be very different indeed from that in another, the regimen which may be useful to one may be fatal to the other. We have already seen that sudden and violent exertion may raise the blood pressure and so lead to intense cardiac pain or to stoppage of the heart and instant death, while more gentle exercises, by increasing the circulation through the muscles, may lessen the pressure and give relief to the heart.

The methods of increasing the muscular circulation may be roughly divided into three, according as the patient lies, stands, or walks. First, absolute rest in bed with massage;¹ second, graduated movements of the muscles of the limbs and body while the patient stands still; third, graduated exercises in walking and climbing.

The second of these methods has been specially worked out by the brothers Schott, of Nauheim, and the third is generally connected with the name of Oertel. It is obvious that in cases of heart disease where the failure is great and the patient is unable even to stand, much less to walk, where breathlessness is extreme and dropsy is present or is advanced, the second and third methods of treatment are inapplicable. It is in such cases that the method of absolute rest in bed, not allowing the patient to rise for any purpose whatever, hardly allowing him to feed himself or turn himself in bed, proves advantageous. The appetite is usually small, the digestion imperfect, and flatulence troublesome; and here an absolute milk diet, like that usually employed in typhoid fever, is often most serviceable, being easily taken and easily digested, while the milk sugar itself has a diuretic action and tends to reduce dropsy. But while simple rest prevents the risk of increased arterial tension and consequent opposition to the cardiac contractions which might arise from muscular exertion, such benefits as would accrue from muscular exertion and increased circulation would be lost were it not that they can be supplied artificially by massage. This plan of treatment, although it has only recently been revived, was known to Harvey, who narrates the case of a man who, in consequence of an injury—of an affront which he could not revenge—was so overcome with hatred, spite, and passion that “he fell into a strange disorder, suffering from extreme compression and pain in the heart and breast, from which he only received some little relief at last when the whole of his chest was pommelled by a strong man, as the baker kneads dough.”²

This was a very rough form of massage, but the same kneading movements which Harvey described have been elaborated into a complete system, more especially by Ling, in Sweden, and made widely known in America and this country by S. Weir Mitchell and Playfair.

¹Practitioner, Vol. LI, page 190.

²The Works of William Harvey, Sydenham Society's edition, page 128.

One might naturally expect that kneading the muscles would increase the circulation through them in somewhat the same way as active exercise, but, to the best of my knowledge, no actual experiments existed to prove this, and I accordingly requested my friend and assistant, Dr. Tunncliffe, to test the matter experimentally. The method employed was, in the main, the same as that devised by Ludwig and employed by Sadler and Gaskell under his direction. The results were that during the kneading of a muscle the amount of venous blood which issued from it was sometimes diminished and sometimes increased; that just after the kneading was over the flow was diminished, apparently from the blood accumulating in the muscle, and this diminution was again succeeded by a greatly increased flow exactly corresponding to that observed by Ludwig and his scholars.

The clinical results are precisely what one would expect from increased circulation in the muscles, and cases apparently hopeless sometimes recover most wonderfully under this treatment. For patients who are stronger, so that confinement to bed is unnecessary, and who yet are unable to take walking exercise, Schott's treatment is most useful, and it may be used as an adjunct to the later stages of the treatment just described, or as a sequel to it. Here the patient is made to go through various exercises of the arms, legs, and trunk with a certain amount of resistance, which is applied either by the patient himself setting in action the opposing muscles or by an attendant who gently resists every movement made by the patient, but graduates his resistance so as not to cause the least hurry in breathing or the least oppression of the heart. Perhaps the easiest way of employing graduated resistance is by the ergostat of Gärtner, which is simply an adaptation of the labor crank of prisons, where the number of turns of a wheel can be regulated in each minute and the resistance, which is applied by a brake, may be graduated to an ounce. The objection to it is the uniformity of movement and its wearisome monotony. Oertel's plan of gradually walking day by day up a steeper and steeper incline, and thus training the muscles of the heart, is well adapted for stronger persons, but when applied injudiciously may lead, just like hasty or excessive exertion, to serious or fatal results. In Schott's method stimulation of the skin by baths is used as an adjunct, and this may tend to slow the pulse, as already mentioned. But in all these plans the essence of treatment is the derivation of blood through a new channel, that of the muscular vessels, and the results in relieving cardiac distress and pain may be described in the same words which Harvey employs in reference to diseases of the circulation: "How speedily some of these diseases that are even reputed incurable are remedied and dispelled as if by enchantment."¹

There is yet another consequence of the circulation to which Harvey has called attention, although only very briefly, which has now become

¹ The Works of William Harvey, Sydenham Society's edition, page 141.

of the utmost importance, and this is the admixture of blood from various parts of the body. After describing the intestinal veins, Harvey says: "The blood returning by these veins and bringing the cruder juices along with it on the one hand from the stomach, where they are thin, watery, and not yet perfectly chylified; on the other, thick and more earthy, as derived from the faeces, but all pouring into this splenic branch, are duly tempered by the admixture of contraries."¹

Harvey's chemical expressions are crude, for chemistry as a science only began to exist about a century and a half after Harvey's death, yet the general idea which he expresses in the words which I have just quoted is wonderfully near the truth.

Two of the most important constituents of the blood are chloride of sodium and water. Chloride of sodium is a neutral salt, but during digestion both it and water are decomposed in the gastric glands, and hydrochloric acid is poured into the stomach, while a corresponding amount of soda is returned into the blood, whose alkalinity increases *pari passu* with the acidity of the stomach. Part of this alkali is excreted in the urine, so that the urine during digestion is often neutral or alkaline. Possibly some of it passes out through the liver in the bile, through the pancreas and intestinal glands into the intestine, where, again mixing with the acid chyle from the stomach, neutralization takes place, so that neutral and comparatively inactive chloride of sodium is again formed from the union of active alkali and acid. But it is most probable that what occurs in the stomach occurs also in the other glands, and that it is not merely excess of alkali resulting from gastric digestion which is poured out by the liver, pancreas, and intestine, but that these glands also decompose salts, pour the alkali out through the ducts, and return the acid into the blood.

We are now leaving the region of definite fact and passing into that of fancy, but the fancies are not entirely baseless, and may show in what directions we may search out and study the secrets of nature by way of experiment. For what is apparently certain in regard to the decomposition of chloride of sodium in the stomach, and probably in the case of neutral salts in the pancreas and intestine, is also probable in that important though as yet very imperfectly known class of bodies which are known as zymogens. Just as we have in the stomach an inactive salt, so we have also an inactive pepsinogen, which, like the salt, is split up in the gastric glands, and active pepsin is poured into the stomach. But is the pepsin the only active substance produced? Has no other body, resulting from decomposition of the pepsinogen, been poured into the blood while the pepsin passed into the stomach? Has the inactive pepsinogen not been split up into two bodies, active when apart, inactive when combined? May it not be fitly compared, as I have said elsewhere, to a cup or glass, harmless while whole, but

¹The Works of William Harvey, Sydenham Society's edition, page 75.

yielding sharp and even dangerous splinters when broken, although these may again be united into a harmless whole?¹

This question at present we can not answer, but in the pancreas there is an indication that something of the kind takes place, for Lépine has discovered that while this gland pours into the intestine a ferment which converts starch into sugar, it pours through the lymphatics into the blood another ferment which destroys sugar. Whether a similar occurrence takes place in regard to its other ferments in the pancreas, or in the glands of the intestine, we do not know, nor do we yet know whether the same process goes on in the skin, and whether the secretion of sweat, which is usually looked upon as its sole function, bears really a relationship to cutaneous activity similar to that which the secretion of bile bears to the functions of the liver. There are indications that such is the case, for when the skin is varnished, not only does the temperature of the animal rapidly sink, but congestion occurs in internal organs, and dropsy takes place in serous cavities, while in extensive burns of the skin rapid disintegration of the blood corpuscles occurs. It is obvious that if this idea be at all correct, a complete revolution will be required in the views we have been accustomed to entertain regarding the action of many medicines. In the case of purgatives and diaphoretics, for example, we have looked mainly at the secretions poured out after their administration for an explanation of their usefulness, whereas it may be that the main part of the benefit that they produce is not by the substances liberated through the secretions they cause, but by those returned from the intestine and skin into the circulating blood.

How important an effect the excessive admixture of the juices from one part of the animal body with the circulating blood might have was shown in the most striking way by Wooldridge. He found that the juice of the thyroid gland, though it is harmless while it remains in the gland, and is probably useful when it enters the blood in small quantities in the ordinary course of daily life, yet if injected into the blood will cause it to coagulate almost instantaneously and kill the animal as quickly as a rifle bullet. What is powerful for harm is likewise powerful for good in these cases, and the administration of thyroid juice in cases of myxœdema is one of the most remarkable therapeutic discoveries of modern times. Since the introduction by Corvisart of pepsin as a remedy in dyspepsia, digestive ferments have been largely employed to assist the stomach and intestine in the performance of their functions, but very little has been done until lately in the way of modifying tissue changes in the body by the introduction of ferments derived from solid organs. For ages back savages have eaten the raw hearts and other organs of the animals which they have killed, or the enemies they have conquered, under the belief that they would thereby obtain increased vigor or courage; but the first definite attempt to cure

¹ Practitioner, Vol. XXXV, August, 1885.

a disease by supplying a ferment from a solid nonglandular organ of the body was, I believe, made in Harvey's own hospital by the use of raw meat in diabetes.¹ It was not, however, until Brown-Séguard recommended the use of testicular extract that the attention of the profession became attracted to the use of extracts of solid organs. Since then extract of thyroid, extract of kidney, extract of supra renal capsule have been employed; but even yet they are only upon their trial, and the limits of their utility have not yet been definitely ascertained.

But yet another therapeutic method has been recently introduced which bids fair to be of the utmost importance, the treatment of disease by antitoxins. The discovery by Pasteur of the dependence of many diseases upon the presence of minute organisms may be ranked with that of Harvey, both in regard to the far-reaching benefits which it has conferred upon mankind and for the simplicity of its origin. The germ of all his discoveries was the attempt to answer the apparently useless question, "Why does a crystal of tartaric acid sometimes crystallize in one form and sometimes in another?" From this germ sprung his discovery of the nature of yeast and of those microbes which originate fermentation, putrefaction, and disease. These minute organisms, far removed from man as they are in their structure and place in nature, appear in some respects to resemble him in the processes of their growth and nutrition. They seem, indeed, to have the power of splitting up inactive bodies into substances having a great physiological or chemical activity. From grape sugar, which is comparatively inert, they produce carbonic acid and alcohol, both of which have a powerful physiological action. From inert albumen they produce albumoses having a most powerful toxic action, and to the poisonous properties of these substances attention was for a while alone directed. But it would appear that at the same time they produce poisons they also form antidotes, and when cultivated without the body and introduced into the living organism they give rise to the production of these antidotes in still greater quantity.

The plan of protection from infective diseases which was first employed by Jenner in smallpox is now being extended to many other diseases, and the protective substances which are formed in the body and their mode of action are being carefully investigated. The introduction either of pathogenic microbes or of toxic products appears to excite in the body a process of tissue change by which antitoxins are produced, and these may be employed either for the purpose of protection or cure. By the use of antitoxins tetanus and diphtheria appear to be deprived of much of their terrible power. But it seems probable that a similar result may be obtained by the introduction of certain tissue juices into the general circulation. It was shown by Wooldridge that thyroid juice has a power of destroying anthrax poison, and it seems probable that increase of the circulation of certain organs will

¹ Cf. *Nature*, 1893, Vol. XLIX, 121.

increase their tissue activity, will throw their juices or the products of their functional activity into the general circulation, and thus influence the invasion or progress of disease. As I have already mentioned, we are able to influence the circulation in muscles both by voluntary exertion and by passive massage, and we should expect that both of these measures would influence the constituents of the blood generally, and such, indeed, appears to be the case, for J. K. Mitchell¹ has found that after massage the number of blood corpuscles in the circulation is very considerably increased.

Had time allowed it, I had intended to discuss the modifications of the heart and vessels by the introduction of remedies into the circulation, the power of drugs to slow or strengthen, to quicken or weaken the power of the heart, to contract or relax the arterioles, to raise or lower the blood pressure, to relieve pain, or to remove dropsy; but to do this would require time far exceeding that of a single lecture. Moreover, the methods and results were admirably expounded to the college by Dr. Leech in his Croonian lecture, and I have therefore thought I should be better fulfilling the wish of Harvey that the orator of the year should exhort the fellows and members of the college to search out the secrets of nature by way of experiment by directing their attention to fields of research which have received at present little attention, but promise results of great practical value. Lastly, I have to exhort you to continue in mutual love and affection among yourselves; and it seems to me that the best way of doing this is to direct your attention to the examples of Harvey and of our late president, whose death we deplore to-day. They were beloved by their fellows while they lived, their loss was lamented when they died, and they have left behind them an example not only of goodness; but of courage. Harvey, seated speechless in his chair, distributing rings and parting gifts to his friends while awaiting the approach of death, and Andrew Clark, steadfastly determining to continue at work and die in harness, in spite of the hemoptysis which seemed to threaten a speedy death, afford us noble examples which ought to encourage us to follow the directions of the venerable Longfellow, who, taking the organ Harvey studied to symbolize such courage as Harvey and Clark showed, says:

Let us, then, be up and doing,
With a heart for any fate;
Still achieving, still pursuing,
Learn to labor, and to wait.

¹American Journal of Medical Science, May, 1894.●

ANTS' NESTS.¹

By Dr. AUGUST FOREL.

A nest is a temporary or permanent, naturally or artificially formed hiding place, which serves as a dwelling for an animal and its family or for a more numerous society of animals. The nest is also intended, at the same time, for protection against enemies and against the inclemency of the weather and of the temperature. There are, however, not only purely natural nests (such as natural caves and hollows) and purely artificial nests (such as blackbirds' nests), but also, in many cases, mingled forms, where natural hiding places are completed by artificial help. Nests may also be divided into transient or season nests and permanent nests.

Now, in the case of animals which live in large societies, such as beavers, wasps, and ants, the nest becomes a complicated building or labyrinth. There are also elaborate and rough primitive nests.

The ants, or Formicidæ, form a great family of the insect order of the Hymenoptera. They number upwards of two thousand known species, distributed throughout the whole earth, which form about one hundred and fifty genera. All species of ants live in societies, and almost all display a peculiar so-called polymorphism; that is, every species consists, not only of a female, usually winged, and a male, usually winged, differing extremely from each other in the whole structure of their bodies, but also of other individuals without wings, which are offspring of the female sex, and are called "workers." The division, however, goes still further in certain species, the "worker" caste being subdivided into two kinds—differing greatly in their physical structure—"workers" and "soldiers." Between these there are species with intermittent workers, the largest of which resemble the "soldiers;" that is, form a phylogenetic precursor to the "soldiers."

Most of the female and male ants are winged, and copulate in the air or in the tops of trees; but at least one of the sexes is always winged. The new colonies are almost invariably founded by a pregnant female, or by several such, as has already been stated by Huber, and

¹Translation of *Die Nester der Ameisen*. Von Dr. August Forel, professor in Zurich. *Neujahrsblatt der Naturforschenden Gesellschaft zu Zurich*, 1893.

has been clearly proved in recent years by MacCook, Lubbock, Blochmann, and others. These females live many years (eight to twelve years, according to Lubbock's experiments), and always remain prolific without renewed copulation. They are the mothers of the whole so-called ant colony, which, consequently, lasts many years and does not die out annually like the wasp colony. It follows from the facts stated that the ants must have permanent nests, and that these nests must display great variety, both of which inferences are correct.

The ants have, moreover, the peculiarity of changing their abode from time to time in order to move to a new one. They understand how to change their dwelling and how to build anew.

Many species of ants understand likewise how to colonize; that is, how to build new nests at a certain distance from their dwellings without leaving their old nest. It is in this way that mighty colonies, with numerous nests, are founded, resembling, to use Huber's words, the cities of one and the same empire. I have counted as many as two hundred immense nests standing close together in our European *Formica exsecta* NYL., and MacCook has counted as many as sixteen hundred still larger nests of one and the same colony of *Formica exsectoides* FOREL in the Alleghanies of North America. These latter ant kingdoms have, in all probability, a population of 200,000,000 to 400,000,000 inhabitants, all forming a single community and living together in active and friendly intercourse, while they are on hostile terms with all other colonies of ants, even those of the same species. Certain kinds of ants which live in trees form similar kingdoms by occupying numerous trees of the same forest.

In addition to this, ants frequently construct annexes to their nests—covered ways, subterranean passages, stations, and flying camps—in order to protect the plant lice which serve them as milk cows, and also for other purposes.

It is further to be remarked that there are courageous, warlike kinds of ants, whose nests are, consequently, open and easily discovered, while other kinds are timid and live in concealment, in many cases, because their colonies consist of only a few individuals. There are, besides, ants with good eyes, which make their nests above ground, and even on the boughs of trees, while there are blind and half blind kinds which live hidden deep underground.

As I have formerly asserted (*Fourmis de la Suisse*, 1874), the chief feature of ant architecture, in contradistinction to that of the bees and the wasps, is its irregularity and want of uniformity—that is to say, its adaptability, or the capacity of making all the surroundings and incidents subserve the purpose of attaining the greatest possible economy of space and time and the greatest possible comfort. For instance, the same species will live in the Alps under stones which absorb the rays of the sun; in a forest it will live in warm, decayed trunks of trees; in a rich meadow it will live in high, conical mounds of earth.

I will attempt to make a classification of the nests of ants, corresponding approximately to that which I formerly made with a view simply to giving an outline of the variety of the dwellings of ants. Of course, taking into consideration the above-mentioned features of ant architecture, it is impossible to be systematic.

I.—TAKING ADVANTAGE OF EXISTING CAVITIES.

Many ants use as nests simply the clefts and crevices of rocks and the space between two stones. They wall up and barricade the exterior of the clefts with sand, pebbles, and dry vegetable particles; they divide the surface, more or less, into chambers, and leave only one or a few doors (holes) open, to allow themselves egress. Many species of the genus *Leptothorax* live in this way, in small colonies, and *Plagiolepis pygmaea* LATR., *Cremastogaster sordidula* NYL., *Prenolepis longicornis* LATR., etc., in larger colonies, in the same manner.

Some such species have adapted themselves specially to mankind and occupy the walls of our houses. They know how to avail themselves there of the space between the stones; they bite away the mortar with all their might and carry it away in order to procure for themselves safe and warm lodgings in the neighborhood of our domestic stores, which they pillage thoroughly at the first opportunity. Such ants which have adapted themselves to the walls of our dwellings are *Lasius emarginatus* LATR., *Monomorium pharaonis* L. (imported into seaports from the Tropics), *Pheidole megacephala* FABR. These insects, as is well known, become house nuisances.

But other natural cavities are also made use of, especially those made by other insects. The species of *Leptothorax* and *Colobopsis* with us, those of *Polyrhachis* and *Cremastogaster* in tropical countries, know how to make use of the cavities of galls which have been abandoned by the gallfly for their nests.

Fig. 1, Plate LV, represents a stem gall from Delagoa Bay, South-east Africa, one-sixth smaller than the natural size, which was inhabited by a colony of *Polyrhachis gerstaeckeri* FOREL, and which was sent to me by our countryman, the missionary physician, Dr. Liengme, living there. The *Polyrhachis* had affixed some of their weaving to the inside, B. The egress opening made by the gallfly was the door of their nest. Cavities made by bark beetles in wood are used among us as nests by the species of *Liometopum* and *Lasius*, and especially by *Lasius brunneus* LATR., *Formica fusca*, etc. In the same way the space between the outer layers of the bark of trees (especially the conifers), the under side of the bark of dead trees, the under side of beds of moss, etc., are used as nests by the species of *Leptothorax* and other small ants. Ants also live frequently in hollow fruits, potatoes, and, above all, in large tropical fruits. Mr. Ortgies found the little *Brachymyrmex heeri* FOR. in the lower part of the pots of the tropical orchids in the Zurich hothouse, which were filled with moss, etc. My friend and colleague, Pro-

fessor Stoll, found the nests of *Camponotus atriceps* SM., race *stercorarius* FOREL, constantly under the dried excrement of cattle, and even inside of it, in Guatemala.

Père Camboué, in Antananarivo, Madagascar, sent me a stalk of *Solanum auriculatum*, the soft marrow of which, excavated and divided into compartments, served as a nest for *Technomyrmex albipes* SMITH. In this case the gnawing capacity of the ants had made the natural object serviceable. A portion of this nest is represented in fig. 2, two-thirds of natural size.

Dr. Göldi, in Rio de Janeiro, sent me several specimens of *Camponotus cingulatus* MAYR., a very handsome, rather large ant, as the regular inhabitant of the hollows (internodes) of the bamboos there. Père Camboué, in Antananarivo, sent me *Prenolepis ellisii* FOREL from the hollow stalks of one of the Malvaceæ, in which it lives. Major Yerbury, of Ceylon, sent me, by Mr. Wroughton, *Camponotus reticulatus* ROGER, with its nest, which was also in a hollow stalk. Mr. Wroughton, divisional forest officer at Poonah, India, sent me the nests of a very small ant, *Cardiocondyla wroughtonii* FOREL, which he had found in the space between the two surfaces of the leaves of a tree (*Eugenia jambolana*), the parenchym of which (the green of the leaf between the exterior membranes) had evidently been devoured by a very small caterpillar. This nest of *Cardiocondyla wroughtonii* is represented in fig. 3 by Mr. L. Schröter.

The well-known ant nests in the hollow acacia thorns of tropical lands also belong to this class; but more on this subject hereafter.

2.—EARTH NESTS.

Earth is the most usual material for the nest building of ants. It is well known (Gould, Huber, etc.) that the ordinary earth structures (mounds) of many of our ants are created by the workers mining under ground after rainy weather, bringing the wet particles of earth to the surface of the ground and pressing them into walls and vaults by means of their mandibles and forelegs, using at the same time blades of grass, etc., as pillars and inside walls. In this way are made the well-known labyrinths, which I myself have watched innumerable times. It is, however, an unsolved problem whether really, as Huber thought, water alone always suffices as cement for the earth or whether it is not in some cases mixed with a secretion of the glands of the ants. The great firmness of certain structures, for instance those of *Lasius flavus*, gives some probability to the latter supposition, particularly when we consider the fragile character of the structures of other kinds of ants.

Earth nests may be divided into three classes:

(a) *Nests which are entirely excavated.*—In this case passages and chambers are simply excavated in the ground, without the particles of earth which are dug out being worked up into an artificial upper structure; they are merely thrown away. There are many kinds of ants

which mine only in this way, as, for example, *Ponera contracta* LTR., *Myrmecocystus*, all the *Dorylides*, *Aphanogaster subterranea* LTR., and, in general, most of the blind and half-blind species. Besides these many other species do it occasionally, such as *Formica fusca* L., *Formica rufibarbis* F., *Tetramorium caespitum* L., species of *Myrmica*, etc.

One variety of the mined nests consists of those in which the ants heap up the excavated earth in banks around the openings of the nest so that crater-shaped openings are the result. This occurs most frequently in sandy soil. These banks are not genuine upper structures, although they often resemble them closely. We find them in the case of *Messor structor*, *Messor barbarus*, species of *Pheidole*, *Acantholepis frauenfeldi*, *Pogonomyrmex*, etc. A peculiar variety of this class is formed by the crescent-shaped mounds of *Messor arenarius* FAB., first noticed by me in the South Tunis desert near Cabes, which consist of coarse but very perishable globes of sand. At certain times the apertures of the *Messor* nests are, in addition, surrounded by mounds composed of the hulls of the seeds which have been gathered, which hulls have been thrown out of the nests. The little *Cardiocondyla elegans* EM. and *stambuloffii* FOREL make small nests in the sand on the seashore.

The subterranean structures of some kinds of ants are, in certain cases, extremely interesting. Certain species dig passages which go down very deep and branch off laterally, forming subterranean corridors, and in many cases leading to root plant lice (*Lasius flavus*) or serving for other purposes. The underground hunts of the species of *Dorylus*, or visiting ants, are partially carried on in this manner. These are blind robber ants, which carry on an underground hunt after all conceivable ground insects, as I myself have observed in Tunis. They are also called "visiting ants," because they frequently make a sudden attack at night upon dwelling houses and destroy all the vermin in them.

The species of *Messor* (Europe), *Pogonomyrmex* (America), and *Holcomyrmex* (India) construct under ground, at a considerable depth (often at the depth of a yard), very large chambers or granaries, in which they store the seeds which they have gathered. In the same way the species of the American genus *Atta* excavate extremely deep and extensive passages and make immense chambers, in which they store the leaves which they have cut from trees, in order to lay off upon them the fungus gardens from which they supply themselves with food. This discovery, which was first made by Belt and subsequently declared by MacCook to be incorrect, has been recently confirmed by Dr. Möller, of Blumenau, in its full extent and by superb experiments.

A great deal of interest is likewise attached to the underground hunts carried on by the ants of the genus *Lobopelta* in India, after the termites, according to the careful observations of Mr. Wroughton. They feed upon these white ants, and pursue them in their own pas-

sages. I conjecture that the same thing is true of the various species of the genus *Leptogenys*, and that they use their long, thin, pointed, sickle-shaped jaws, which bear a strong resemblance to a curved needle, to pierce the termites, which they then devour by the aid of their comparatively powerful under jaw.

(b) *Nests under stones.*—As is well known, wherever there are stones on dry declivities, etc., innumerable ants' nests are found under them. The stone serves as a roof, under which are the most beautiful corridors and chambers. Under these lies the mined nest. The stone serves, above all, to produce a speedy warming by means of the rays of the sun. The ants under it are always in the highest story, in damp or cool weather, as soon as the sun shines or begins to penetrate. As soon as the sun disappears the insects go below. They also go below when the sun shines too strong.

The same species which mine, and which build earthen structures above ground, also live under stones as soon as they find any. The stone must be neither too small and thin nor too thick and large. Stones of 2 to 15 centimeters in thickness are the most desirable, according to the size of the ants and the extent of their colonies. They allow the best regulation of the heat for the brood.

The species of *Lasius*, *Formica*, *Myrmica*, *Tetramorium*, *Plagiolepis*, *Pheidole*, *Camponotus*, *Aphanogaster*, *Bothriomyrmex*, *Tapinoma*, and other genera, are found in swarms under stones among us in Europe. There are few genera of ants that never live under stones.

(c) *Earth structures above ground.*—Many kinds of ants are excellent masons, but by no means all. It is easier to mine than to construct walls, vaults, and pillars.

I advise everyone who wishes to see one of the most beautiful displays of animal instinct and animal intelligence to equip himself with an umbrella, and with patience, on some warm day in May, when it begins to rain after a drought, or when it has just stopped raining, to repair to a meadow, and there, with the greatest perseverance, to watch attentively the surface of the ant-hills and the actions of their occupants. He must at the same time watch closely individual ants and their work. He will then admire the skill and foresight of these insects, and will see how the little architects and masons understand how to turn every blade of grass, every stalk, every leaf, to account, by means of their earth mortar, in the erection of vaults, pillars, walls, etc. In this manner are made those no less numerous than wonderful earth labyrinths which serve the ants in our meadows as conical superstructures. Our fig. 9 represents a fragment of the mound of an earth nest of *Lasius niger*. It can be seen how blades of grass and leaves are used in the masonry as pillars, arches, etc. The drawing, which is two-thirds of the natural size, was made by Mr. L. Schröter, like all the others, from the original piece, which I had hardened with a solution of silica. I need not add that a mined nest always lies under the superstructure

of the mound-building ants. What purpose does the latter serve? Judging from my own observations, the same purpose as the stones, to wit, to procure warmth for the brood. The grass springs up in May, and with it the ant mounds. These afford protection against the dampness and the shade of the primeval forest; for such is a meadow to the ants. Up there, under the roof of the mound, the rays of the sun are felt. We have in Europe a small ant (*Tapinoma erraticum* LATR.) whose perishable earth structures, first described by me, can, to all appearance, serve no other purpose. It builds hastily around the blades of grass a comparatively very high and steep mound of earth, which consists of little more than the upper, superficial, thin vault. Inside there are often only a few wretched thin chambers, especially where the grass is thick. The ants hold their brood partly in their upper jaws, partly lay them on leaves. They crowd together under the mound to warm themselves in the rays of the sun. After the harvest the mounds of the *Tapinoma* disappear, while those of the other ants remain standing. The latter, however, also become more and more flattened as autumn approaches. Our fig. 12 represents the perpendicular cross section of a nest of *Tapinoma erraticum* LATR., from Vaux, Canton Vaud, Switzerland, which was strengthened and preserved by me by means of a solution of silica, and is now in the Entomological Museum of the Federal Polytechnikum. Mr. L. Schröter has drawn the nest of two-thirds of the natural size. D, the temporary earthen cupola; Min, the beginning of the underground mined structure.

Among us mounds of earth with labyrinths are built by all the species of *Lasius*, with the exception of *Lasius fuliginosus* LTR., *brunneus* LTR., and *emarginatus* OL.; also by *Tetramorium caespitum*, the species of *Myrmica*, several of *Formica* and *Camponotus*, and the species of *Tapinoma*; and in Tunis by *Monomorium salomonis*, *Aphanogaster striola*, *sarđoa*, *testaceopilosa*, *crocea*, etc. The best artist is the most common of all ants, *Lasius niger* L., which swarms in all our gardens. This ant also constructs covered passages along the stalks of plants, where in this way it walls up its plant lice and cochineal kermes in artistic stalls. The species of *Myrmica* frequently build earthen stalls around the plant lice on the stalks of plants without putting them in communication with the ant-hill by a covered way.

In the island of St. Thomas I saw earthen structures made by *Solenopsis geminata* F. In Australia the large species of the genus *Myrmica*, which are 20 to 28 millimeters long, build immense nests of earth.

A seed-harvesting ant in Colorado, *Pogonomyrmex occidentalis* CRESSON, builds a very peculiar and isolated variety of the earthen mounds. It plasters or paves the whole upper surface of its earthen mound uniformly and in mosaic with a layer of small white stones, which, according to MacCook's observations, it frequently brings from a great depth in the ground. The still unknown object of this paving is prob-

ably the same as that of the earthen mounds in general. It is extraordinary that the little paving stones are placed side by side with great regularity like a street pavement, while the interior of the cupola contains no stones whatever. MacCook has even seen upon these mounds stones containing fossil remains and native gold. Mr. Henry de Saussure, of Geneva, made similar observations before MacCook among the genuine *Pogonomyrmex barbatus* i. sp., SMITH, but did not publish them.

3.—WOOD NESTS.

There are also woodcutters among the ants, and in not a few cases the same species knows how to make earthen structures and how to hollow out wood, as, for instance, our *Camponotus ligniperdus* LATR.

The best woodcutters are those species of the genus *Camponotus* MAYR, which have a short, broad head, rounded off in front, especially the subgenus *Colobopsis* MAYR.

These ants frequently bore with their short, powerful jaws into the very hardest wood, and construct secure and elegant labyrinths for themselves in it. This is the case with *Camponotus pubescens* in Wallis and Tessin, and *Camponotus marginatus*. The latter bores into the softer layers of the wood when they are somewhat decayed and lets the harder part remain, so that its nests are more concentric around the center of the bough or trunk in their arrangement. I have noticed them in cherry trees and Paulownias.

The smaller and very timid species of *Colobopsis* build themselves nests in the hardest wood. These nests open outward by only a very few small apertures, which are concealed by the irregularities of the bark of the tree. These apertures are kept closed by the head of a "soldier" sentinel, who permits only friends to enter. The soldier's head is broadened and rounded off in front, evidently for this very use. The rounded surface (front view in fig. 11, magnified ten times) is rough, of a dull-brown color; the feelers are planted back of the rounded surface, so that the latter presents no hold and blocks up the entrance to the nest like a living stopper. I first observed this fact among our *Colobopsis truncata* SPIN. at Vaux, Canton Vaud (fig. 13, drawn four-thirds of the natural size), but the similar structure of the head and the habit of living in trees, which characterize the other species of *Colobopsis*, lead us to infer that they live in the same way.

Fig. 13 represents a portion of the original piece of a nest of *Colobopsis truncata* discovered by me in a very hard, dead bough of a pear tree. B is the bark of the pear tree; Ch is the chambers and passages of the nest; O is the exterior opening of the nest; behind it, in the gallery of egress of the nest, stands a *Colobopsis* "soldier" as a sentinel, keeping the door closed with his head. At W are seen two *Colobopsis* workers, one hastening toward the door from the outside, the other standing in the nest. The soldier will go back into the nest for a moment in order to let the first worker come in (I have noticed this

among the living ants). That the part played by the *Colobopsis* "soldiers" is that of a living stopper is further proved by the fact that there are comparatively few of them, and that in contrast to the workers they hardly ever go out. Fig. 19 represents a "soldier," still more magnified, standing at the door of egress.

Those species of *Camponotus* which live in a similar way, such as *Camponotus marginatus* LATR., display the beginning of a similar rounded surface on the front part of the head, and always have a large-headed sentry at the door.

Leptothorax acervorum F. cuts small, very simple nests, spread out flat, with few chambers in the outer layer (the cork layer) of the bark of the tree. Fig. 5 represents such a nest two-thirds of the natural size in the bark of a fir.

4.—COMBINED STRUCTURES.

The structures heretofore described are combined in a variety of ways.

For instance, the hollow stalk of a large *Arcangelica* is filled from top to bottom by *Lasius niger* with small earthen chambers and occupied by them. Decayed trunks of trees are made use of by ants which elsewhere build in the ground, excavated, and worked up into nests by *Lasius niger*, *Lasius flavus*, *Formica fusca*, *Myrmica lewinodis*, etc. Here wood dust and earth are used as mortar in the construction of chambers and galleries. *Formica rufa* L. excavates the softer portions of the wood in half-decayed trunks of trees and builds in them labyrinths which form a part of its nests.

Lasius brunneus LATR. lives habitually in half-rotten trunks of trees and beams, after excavating the moist, decayed wood. It also lives in decayed woodwork in our houses, as do likewise frequently *Lasius umbratus* NGL.

The architecture of the group of forest ants, *Formica rufa* L., *pratensis* DE GEER, *truncicola* NYL., *exsecta* NGL., and *pressilabris* NYL., as well as of their North American relatives, *F. exsectoides* FOREL, *integra* NYL., *obseuripes* FOREL, etc., is, however, more imposing and more interesting.

These ants mine the ground, but cover their nests with dry vegetable matter of the most varied kinds—pine and fir cones, dry leaves and pieces of wood, snail shells, little balls of rosin; blades of grass, in a word, with every kind of round and cylindrical materials. With these they build the well-known immense mounds, with their singular framework and the indescribable interior labyrinth, the most thoroughly perforated part of which is in the middle, at about the level of the ground. Earth serves partially as cement. The openings of the nest are carefully closed with small pieces of wood at night or when it is raining. They are opened by the workers in the morning and generally in warm, fine weather.

The mound is gradually enlarged and strengthened by materials dragged to it. It protects the interior perfectly against cold and rain.

Formica rufa i. sp. of the fir woods uses chiefly fir leaves; *Formica pratensis* of the meadows builds flatter mounds and uses more pieces of wood and blades of grass, pieces of dry branches, etc.; *Formica exsecta* uses more particles of dry leaves, etc.; *Formica sanguinea* LATR. builds mounds composed of the above-mentioned materials and earth; its work is partly that of a carpenter and partly masonry; the latter, however, which is executed by the "slaves" (*Formica fusca*), usually prevails.

It is impossible for us to describe everything, and we refer our readers to Huber's admirable description of the way in which the forest ants and the earthen-mound ants build their nests. It may well be said that almost every species—either in earthen structures, in wood nests, or in combined structures—has its peculiarities with regard to the quality of the material, the fineness of the grain, the shape and arrangement of the mound and the labyrinth, the comparative thickness of the walls, the size of the chambers, etc., so that the species may frequently be known by the structure.

Still the ants often rob one another's nests, and this frequently renders it difficult to recognize the architect.

There are species, it is true, whose architecture can hardly be distinguished, as, for instance, the little species of *Myrmica*.

5.—PASTEBOARD NESTS AND SPUN NESTS.

I have already, in the Mittheilungen of the Swiss Entomological Society, Vol. VIII, part 6, 1891, given some information with regard to the singular nests which are now to occupy our attention. A well-known European species, *Lasius fuliginosus* LATR., builds peculiar pasteboard nests, which Huber erroneously thought to be excavated in wood, while Meinert, Mayr, and others, including myself, have demonstrated their true nature beyond a doubt. They are composed of the finest particles of wood dust or of earth and small stones, which, by means of a viscous substance secreted by the ants, are worked up into so strong a pasteboard (see Forel, Fourmis de la Suisse, pp. 181-187) that the partitions between the excavations are extremely thin (as thin as visiting cards). These nests are mostly found in hollow trees. That they are not excavated, but are composed of pasteboard, I have clearly shown by microscopic cuts. Meinert first called attention to the fact that in *Lasius fuliginosus* the glands of the upper jaw are extraordinarily large, and conjectured that they are the glands which secrete this viscous substance (cement). In fact a comparative physiological study of this gland which Wolff ("The smelling organ of bees") erroneously designated as the smelling-mucous gland, shows that a discovery which has been misinterpreted by Wolff is of special value. The substance secreted by this gland, both in bees and in ants, and

also the secretion of the posterior glands of certain ants (the *Dolichoderides*, with whom it serves as a weapon for smearing the faces of their enemies), is immediately decomposed at the first contact with the air, with a violent production of gas bubbles and the development of an aromatic odor which is very peculiar. As soon as this chemical decomposition is completed the residue of the secretion is transformed into a resinous, viscous mass, which is very sticky. There is no doubt in my mind that the viscous substance formed in this way is not a smelling mucus, as Wolff by a very far-fetched explanation, which is untenable for many other reasons, would have it, but forms the cement with which the nests and many other things are welded together.

What is still too little known, however, is the manner in which a genuine phylogenetic evolution converts this gland cement gradually into spun threads. The pasteboard of *Lasius fuliginosus* LATR. is very rich in wood dust or earthy matter and very poor in cement, so that it is very brittle. There is a drawing of it in my Fourmis de la Suisse, Pl. II, figs. 32 and 33. The pasteboard which *Liometopum microcephalum* Pz. manufactures in the innermost hollow of venerable but, nevertheless, strong, handsome, hard, large trees, and which is also composed of wood dust, is somewhat less brittle. They make it in oaks, poplars, apricot trees, etc., in southeastern Europe. Mayr gives a drawing of it, taken from a photograph, in the Proceedings of the Imperial Royal Zoological and Botanical Society of Vienna, June 1, 1892, Vol. XLII, Pl. V, fig. 7. A great many species of the genera *Cremastogaster* LUND and *Dolichoderus* LUND build only pasteboard nests on the boughs of trees, and these nests vary very much in their nature. In some cases the pasteboard is harder and more brittle, resembling wood, as among the species just described; in other cases it is thinner and more elastic or flexible, but at the same time has much greater power of resistance, and is much more like paper or pasteboard, like that of wasps. *Cremastogaster stollii* FOREL, of Guatemala, builds very peculiar galleries of pasteboard along the trunks of trees between the projecting portions of the bark. They were discovered in these galleries by my friend, Professor Stoll, who communicated this circumstance to me. In *Cremastogaster ranavalona* FOREL, of Madagascar, the pasteboard of the inside of the large, round, tree nest, is thicker and more brittle; that of the outer portion is always thinner, more elastic, and finally, in the outermost layers, even perforated, having a reticulate appearance, somewhat like loosely woven packing cloth. The nest of *Cremastogaster ranavalona* is represented in my "Formicides de Madagascar" (from Granddier's Natural History of Madagascar, Vol. XX, part 28, Pl. VI, fig. 4, 4a, and 4b, and Pl. VII). The nest of *Dolichoderus bispinosus* OLIV., which is composed of the seed hairs of a tree of tropical America (the wool tree, *Bombax ceiba* L.) woven together with gland cement, is very similar in appearance to the outer portions of this nest, but still more coarsely perforated and more net like. Fig. 18 represents a small piece

of this substance microscopically magnified. Fib represents the vegetable filaments, which are only moderately dismembered, so that their structure may easily be seen; Cem is the ant cement, the color of which varies from yellowish to brownish, and which can be recognized by its shapelessness and its color; Mesh represents the empty meshes of the network. Thanks to the coarseness of the substance, which is, consequently, in an almost unseathed and unpulverized state, the ant cement can be better distinguished from vegetable building matter in this case than in the other kinds of ant pasteboard.

Fig. 15 represents, in one-third the natural size, the photographed nest of *Dolichoderus bituberculatus* MAYR, of Bangkok, which was sent to me by the late lamented and well-known turner, Mr. Heinrich Sigg, of Zurich. This nest is composed of a compact (not perforated) but fine-grained pasteboard, greatly resembling that of the nests of the common wasp (*Vespa germanica*), but stronger. A section of the nest was taken off perpendicularly in order to show the structure of the interior. The nest is resting in its natural position on the bough where the ants had placed it. It can be seen how the small branches and leaves of the tree, glued together with pasteboard, are incorporated into the nest, and how the main bough serves as an axle to support the structure. It can be further seen how the labyrinth, constructed of pasteboard, is built more or less concentrically around the bough.

Some species of the genera *Camponotus* (*C. chartifex* SMITH, *traili* MAYR, *fabricii* ROGER, etc.), in South America, and *Polyrhachis*, in the East Indies, manufacture a very similar pasteboard. Fig. 4 represents a nest of *Polyrhachis mayri* ROGER, of Ceylon. The whole nest of most of the species of *Polyrhachis* consists of a single cavity of the size of a walnut or of a hen's egg, while the nests of other ants are, for the greater part, divided into chambers and passages. The egg-shaped nest of *Polyrhachis mayri*, which I received from Major Yerbury, of Ceylon, through Mr. Wroughton, stands simply like the cocoon of the silk-worm, on a leaf. The pasteboard of which it is composed resembles that of a *Cremastogaster* nest, but is very weak and fragile, being made of vegetable particles slightly glued together with gland cement. A silk thread has never yet been discovered in any of them. The cement is in the form of yellow or brownish flakes and crosspieces, precisely like that of *Dolichoderus bispinosus* (fig. 18, the colored parts), while the vegetable matter is entirely compact (without meshes) and more finely dismembered, though still recognizable in its structure (not pulverized); the walls of the nest are about half a millimeter thick.

Polyrhachis scissa ROGER, of Ceylon, builds its nest of exactly the same materials; but it is irregularly formed, and is attached to leaves rolled around galls, the crevices of which are closed with pasteboard.

I have received similar pasteboard nests of *Dolichoderus gracilipes* MAYR and of a species of *Cremastogaster* fixed upon leaves, from Ceylon, through Major Yerbury.

The nest of the *Polyrhachis jerdonii*¹ FOREL which I received from Ceylon through Major Yerbury is very interesting. This species builds upon leaves small nests, the wall of which greatly resembles in appearance the shell of many *Phryganeidae* larvæ. Pebbles, and especially small fragments of plants, are cemented together by a fine web or woven together, and form a rather soft and tough web-like nest wall of a bright greyish-brown color. Fig. 17 gives a microscopic picture of this nest wall. We see here unmistakable small fragments of plants (Schol.) bound together in a web by peculiar silk threads (Gesp). These silk threads are found, upon a closer examination, to be of very irregular thickness, often branching, and in many cases issuing from a thicker crosspiece. Upon calling in the aid of the still more magnified web of *Polyrhachis dives* SM. (also from the East Indies), in fig. 7, there can be no doubt that a viscous substance secreted by the glands, similar to that which we have seen used as glue by the ants previously described, is here simply drawn out into threads. In fig. 7 are seen the thicker crosspieces of a still more shapeless mass of cement and the more finely spun threads drawn transversely out of them.

Polyrhachis dives, however, no longer needs any foreign material. It makes its nest wall out of pure silk web, exactly like coarse spun yarn or the web of the caterpillar. The web is of a brownish yellow, and is fixed between leaves, which are lined with it and bound together. Mr. Wroughton, of Poonah, India, sent me such a nest, simply between two leaves.

A still finer, softer silk web, finer and thicker than the finest silk paper, very soft and as pliable as the finest gauze, though much thicker, of a brown color, is produced by *Polyrhachis spinigera* MAYR. Fig. 16 presents a microscopic picture of it. Here we find no more crosspieces, but only silk threads. They are, however, still irregular, of varying thickness, spun across each other into a web. This web is fixed in a wonderful manner in the ground, where it forms the lining of a funnel-shaped cave, which is widened out into a chamber at the bottom. The honor of the discovery of this highly interesting nest is due to Mr. Wroughton; he found it in Poonah, India. Mr. L. Schröter made the somewhat schematic drawing of the nest, in its natural position, from

¹ *Polyrhachis jerdonii* (workers) n. sp. 4½ millimeters in length, short and broad; related to the *Polyrhachis argentea* MAYR, but still shorter, without silvery down, with a much less arched thorax sharply edged at the side, the abdomen sharply edged in front, with red mandibles, antennæ, and legs (except the tarsi). The other parts are of a dull black, thickly and irregularly punctate-reticulate, and with very fine, yellow, sparse, recumbent, and almost no erect hair. The head is wider than long, and broadens out very much behind. The clypeus is short, without flaps in front, not carinate; the laminae diverge behind. The scape of the short frontal antennæ is somewhat in the shape of an S, and hardly extends beyond the back of the head. Scales between the spines, with a convex, emarginated upper border. Spines just like those of *Polyrhachis argentea*. The sculpture of the head is like the meshes of a net, with a dotted background. The body is dotted like a thimble.

an original sketch by Mr. Wroughton (fig. 8). We refer the reader to the drawing and to the explanation of the plates.

The large nest constructed in the foliage of trees, between the leaves, by *Æcophylla smaragdina* FABR., one of the most common ants of tropical Asia and tropical Africa, forms, however, the prototype of spun ants' nests. A great number of leaves are fastened together by a fine, white web, like the finest silk stuff. This web, apart from the color, has exactly the same appearance, both to the naked eye and under the microscope, as that of *Polyrhachis spinigera*. The leaves are usually fastened together by the edges. The nest is large, and the large, long very vicious, reddish to greenish worker ants live in it, with their grass-green females, their black males, and their whole brood. They form very populous colonies in the branches of the trees. Fig. 10 represents a portion of the nest of *Æcophylla smaragdina*, with the web and the borders of the leaves which are fastened together.

Now, how do the ants spin? This has, unfortunately, so far as I know, never yet been observed sufficiently closely. Not even the way in which the pasteboard of our European ants is made has been discovered. *Lasius fuliginosus* has never consented to work before my eyes. At all events, the spinning of *Æcophylla*, which works in broad daylight, ought to be the first to be seen, and, in fact, the only minute observations on this subject known to me, by E. H. Aitken, in the Journal of the Bombay Natural History Society, 1890, Vol. V, No. 4, page 422 ("Red ants' nests"), now lie before me.

Aitken saw how *Æcophylla* fastened two leaves together. A worker went to the base of the two leaves, at the point at which they began to separate, placed his hind legs, which are furnished with sharp claws, upon one of the leaves and drew the other leaf toward him with all his might with his upper jaw. If the distance was too great, from two to five ants chained themselves together for this task, each grasping the body of one of the others, the first holding one leaf with his mandibles, the last seizing the other leaf with the claws of the tarsi. While the edges of the two leaves were held as close together as possible, simply by these chains of ants working side by side, with the application of all their strength in the utmost tension, as if by india-rubber bands, Aitken saw other ants zealously engaged in binding the edges of the two leaves together with strong silk threads or ropes, which they spun closer and closer together the nearer the leaves approached each other. When a sufficient number of leaves had been fastened together in this way by their edges, the whole was rendered waterproof by a compact silk web, and was divided into chambers and passages by a similar web. Aitken is a reliable and accurate observer. This highly interesting observation of his is entitled to full credit. Only one thing is wanting to it, to wit, the information from what part of the body of the ant the silk thread issues. This must likewise be observed.

In my opinion, however, there is no doubt that the silk thread of *Ecophylla* and of the spinning species of *Polyrhachis*, like the cement of the other species of *Polyrhachis*, many of *Cremastogaster* and *Dolichoderus*, *Lasius fuliginosus*, etc., is formed from the so-called mouth saliva, and most probably from the secretion of the glands of the upper jaw. The cells of these glands, at least in *Ecophylla*, are large and numerous.

6.—SYMBIOSIS AND KINDRED RELATIONS BETWEEN ANTS AND PLANTS.

By symbiosis, in the more restricted sense, is meant the mutual services of two organisms living together, which, by a defensive alliance in the struggle for existence, are so dependent upon each other that the one can not thrive well without the other. The formation of special morphological characteristics is usually combined with genuine symbiosis. There are, besides, all possible forms of imperfect symbiosis, displaying transitions to parasitism, etc., above all, however, those in which only one of the two organisms is really dependent upon the other. For example, the small beetles *Lomechusa* and *Atemeles* can not live without their ant host. On the other hand, the ant can exist very well without such guests, and merely eats the secretion from the hair clusters of the beetles as a dainty (see Wasmann's elegant Observations on the Biology of the Guests of the Ants). There are, however, cases of still more imperfect, counterfeit symbiosis, where one organism entirely ignores the other, and, lastly, casual relations which are erroneously regarded as symbiotic.

The relations of certain ants to certain plants give rise to very peculiar forms of nests, of which we will speak briefly.

(a) *Genuine symbiosis*.—Dr. Fritz Müller, of Blumenau, South Brazil, has discovered the real relation of the *Cecropia* trees (the imbauba of the Brazilians) to *Azteca instabilis* SMITH. The ant genus *Azteca* FOREL, which is related to *Liometopum* MAYR, contains several American species, but the biology of *Azteca instabilis* only is known. Prof. A. F. W. Schimper (The Varying Relations between Plants and Ants, Jena, 1888) has given us in his excellent work his own observations in South Brazil, which substantially complete those of Müller.

Azteca instabilis lives only in the hollow trunks of certain species of *Cecropia*, especially *Cecropia adenopus*, which trunks are divided into chambers by transverse compartments; but Schimper has discovered a species of *Cecropia* on the Corcovado, which never contains ants, while *Cecropia adenopus* and others, as soon as they have grown somewhat large (1 year old), are always inhabited by *Azteca instabilis*. The following is now further ascertained:

The pregnant females of *Azteca instabilis* seek out for themselves a certain very thin and soft spot in the trunk of the *Cecropia*, which always has the same situation in every internode, bore into it, and thus get into the hollow, where they deposit their brood, if they are not

attacked by parasites (ichneumon flies). The opening then closes, but is subsequently opened again by the worker ants. This thinned spot is an adaptation of the plant to the ant; it does not occur in the *Cecropia* which is free from ants (that is to say, the corresponding bud depression is not changed in texture and is not atrophied). On the underside of the stem of the leaf of *Cecropia adenopus* and others is a peculiar hair cushion, which is constantly secreting albuminous, egg-shaped particles (Müller's corpuscles). These secretions are eagerly collected and devoured by the *Azteca*; they are one of their chief articles of food (ascertained through Fritz Müller). The *Cecropia* which is free from ants has none of Müller's corpuscles. The species of *Cecropia* are much frequented in Brazil by the leaf-cutting ants (species of *Atta*) and are terribly injured by them, as has been repeatedly ascertained by Belt and others. All those which contain *Azteca* colonies are spared, because the vicious *Azteca* pursue the *Atta* furiously and drive them away.

All this is well ascertained. The plant, by an undoubted adaptation, gives the ant food and lodging. The ant, in return, defends the plant from its worst enemy. This symbiotic relation did not, of course, arise all at once. Schimper found a *Cecropia* which is not inhabited by the *Azteca* until later, and probably also less regularly. This *Cecropia* has also, it is true, thinned boring spots, but they are not formed until later, and it has not as yet any Müller's corpuscles. Last year in Bulgaria I watched in oak woods and in old trees in general *Liometopum microcephalum* Pz., of Europe, which lives in trees. The trunks of the trees are there, too, covered with ants, which attack fiercely all that approach them. We have not in Europe any species of *Atta* that cut leaves, but, on the other hand, we have so many more beetles and other insects which delight to destroy the old oaks. I was charmed at seeing near Aetos the finest oak forest that I have ever beheld, with real, superb giants. Almost all of them were inhabited by *Liometopum* colonies, whose running workers covered all the trunks of the oaks. I have no doubt that these fierce ants, whose carnivorous habits Emery has described, drive away the enemies of the oak. The symbiotic relations of the *Azteca* and the *Cecropia* were probably formed from these simpler relations. *Liometopum* lives only in trees; the trees, however, do not display the least adaptation to that ant.

Belt and Schimper have further proved, as to *Acacia sphaerocephala* WILLD. and *A. spadicigera* CHAM. and SCHLECHT, of Central America, that ants of the genus *Pseudomyrma* LUND not only always live in the hollow thorns, but, owing to a peculiar adaptation of that plant greatly resembling that of the *Cecropia*, find sugar and albuminous food upon them. These two species of *Acacia* possess so-called extrafloral nectaries, which furnish the ants with sugar, and on the points of their leaves Belt corpuscles rich in albumen (resembling the Müller corpuscles of the *Cecropia*), which supply them with albumen. Still a closer direct obser-

vation of the reception of the food by the ants is as yet wanting here. The *Acacias* which are free from ants do not possess these peculiar arrangements.

(b) *Imperfect symbiosis*.—Belt has ascertained that the species of *Pseudomyrma* which inhabit *Acacia* thorns are fierce, warlike creatures, and keep every foe at a distance from the plant, including the leaf-cutting *Atta*, the forest destroyers of America. The adaptation of the ant to the plant is ascertained as soon as it is proved that the respective species always lives and can thrive only in the corresponding plant. This has recently been sufficiently demonstrated in the case of *Pseudomyrma flavidula* and *Pseudomyrma belti*. With all this, however, it is not yet proved that all *Acacias* inhabited by ants contribute anything on their part to this arrangement. In fact, this is not yet proved in the case of many species; in others, it is very doubtful or improbable, because, on the one hand, there are many hollow *Acacia* thorns without ants (Mr. Wroughton has sent me such from India), and because, on the other hand, many species of ants of the genera *Pseudomyrma*, *Sima*, and *Cremastogaster* frequently inhabit these thorns, and frequently make their nests in some other way. These hollow thorns with the round aperture, which the ants make use of, and which are very similar in appearance to that of the gall in fig. 1, have been often depicted, and we do not, therefore, think it worth while to reproduce them here. I found a thorn of *Acacia fistula*, which had been brought from Somali Land by Prof. C. Keller, and which was inhabited by *Cremastogaster chiarinii* EMERY, divided inside by pasteboard into a few small chambers. In the case of *Cremastogaster chiarinii* EM., *C. acacia* FOREL, and *C. ruspolius* FOREL, there appears to be an adaptation of the ant to the plant.

We must now speak of the celebrated pseudobulbs of the epiphytic plants of the genera *Myrmecodia* and *Hydnophytum* of the Sunda Islands. Fig. 14 represents, in half the natural size, the photographed cross section of *Hydnophytum montanum*, which, with other magnificent specimens of this plant and of its relative, *Myrmecodia*, which has often been sketched, was sent to me recently from Java through the kindness of my friend and colleague, Dr. Ad. Frick, of Zurich. The enormous bulb of this plant, which lives as a parasite upon trees, is always pierced by a hollow labyrinth, as represented by the cross section in our figure. Now, this hollow labyrinth, according to the observations of Forbes, Beccari, Treub, and others, as well as that of *Myrmecodia*, is always inhabited by ants, which issue from little openings near the point of departure of the roots and fiercely attack every one who approaches, so that the natives are very unwilling to fetch these plants. Three species of ants, *Iridomyrmex cordatus* SMITH, *Cremastogaster deformis* SM., and *Pheidole jarana* MAYR, were found in *Myrmecodia* and in *Hydnophytum*. While, however, *Iridomyrmex* seems to make its appearance always in these plants only, *Pheidole*

javana is very widespread in the Sunda Islands, and makes its nests in other ways besides. Emery is, therefore, of the opinion, which is doubtless correct, that *Pheidole* merely robs the nests of *Iridomyrmex* occasionally and is not adapted to the plant. On the other hand, Emery regards *Cremastogaster deformis* as the constant guest of the *Hydnophytum*. In all the Myrmecodia and *Hydnophytum* bulbs that I received in alcohol through Dr. Frick there was a colony of the smaller, darker Javanese variety of *Iridomyrmex cordatus* SMITH (Var. *Myrmecodie* EMERY), including males, a few pregnant females, and numerous larvæ and pupæ. All the specimens of the plant had the same hollow labyrinth, looking like a nest built by ants. It must be added that the genus *Iridomyrmex* is very closely related to *Azteca* and *Liometopum*, but comprises many species which build nests of earth.

Now, Treub has ascertained (*Annals of the Botanical Garden of Buitenzorg*, Vol. VII, 1888, p. 191) that Myrmecodia raised from seeds in hothouses and in the botanical garden of Buitenzorg develop the whole hollow labyrinth in their bulbs, to complete maturity, without the presence of ants, just as well as those which, in a state of freedom, possess ants. At the same time the plants thrive admirably. This proves that the labyrinth is produced by the plant, and not by the ants, though Beccari repeatedly found severed bundles of vessels in the compartments. Treub has, consequently, resorted to other attempts at an explanation, and has regarded these singular cavities as the breathing organs of the plant, and connected them with the interior irrigation of their web (the compartments have a very watery web), which, in view of the epiphytic situation of the plant upon trees with little foliage, is plausible. My own opinion, however, is that Beccari's observations are correct, and that the ants lend their aid by connecting some of the cavities by bored passages, as the natural cavities do not all appear to me to have a natural communication with each other, such as the ants require. Furthermore, the founders of the colony, the mother females, must first bore in. At all events, only the adaptation on the part of the ant is well ascertained—that is to say, in the case at least of *Iridomyrmex cordatus*, which finds its exclusive, beautiful, and secure dwelling in the plants of the genera *Myrmecodia*, *Hydnophytum* (and *Dischidia*?). Botanists say that these plants furnish no special food to the ants, at least nothing has been found corresponding to the Müller's corpuscles of *Cecropia*. Since, however, most of the *Dolichoderi* keep no plant lice, but lick up the secretions of plants, or devour insects, a closer investigation of the mode of feeding of *Iridomyrmex cordatus* would probably bring some interesting facts to light. Besides, Treub's observations do not prove by any means that the plant does not form the labyrinth for the purpose of serving as a dwelling for the ants. The fierce inmates certainly afford it protection against its enemies. We must investigate, as Schimper did for *Cecropia*, whether there are kindred species of plants, not inhabited by ants, with or without similar

labyrinths. It remains surprising enough, in spite of Treub's later explanation, that so small a plant forms such a colossal bulb, with such cavities, to which a particular species of ant has so evidently adapted itself. It seems to me that the possibility of an adaptation on the part of the plant can not yet be decisively denied, and that we should await further investigations into the biology of *Iridomyrmex cordatus* and *Cremastogaster deformis*. The fact that in the botanical garden at Buitenzorg Myrmecodia thrives without *Iridomyrmex* (Treub) proves nothing, because, in the first place, the conditions of the struggle for existence are entirely different there from those of the primeval forest; and, in the second place, because other ants frequently take possession of their dwellings in the Myrmecodia bulbs, and act as their representatives. Treub found no dangerous foes of Myrmecodia in the botanical garden, but in the forest it can be eaten or otherwise destroyed by mammals or other animals which are kept at a distance by the ants. Skepticism is necessary and good, but denial and rejection are not good without sufficient reasons.

In a shrub in Borneo, *Clerodendron fistulosum* BECCARI, Beccari constantly found a *Colobopsis*, which Emery has named *Colobopsis clerodendri*. Here the plant, which, like the *Cecropia*, has hollow internodes, likewise forms a round attenuated spot in its walls, which is bored through by *Colobopsis*, and serves it as a door. The plant also possesses innumerable extrafloral nectaries (that is to say, glands producing a sugary liquid, which lie, not in the flowers, but in other places). Still, I am not yet entirely convinced, in this case, that there is an adaptation on the part of the plant, because the species of the genus *Colobopsis*, so far as hitherto known, are shy and cowardly, and would, consequently, furnish no protectors to the plant. The similarity of the shape of the head of the soldier of this species seems to me to indicate that he stops up the round opening of the nest in the stalk of the *Clerodendron*, with his head, in the same manner that the soldier of our European *Colobopsis truncata* stops up the door of his wood nest. All investigations on this subject, as well as on the ant's mode of feeding, are still wanting.

There are, besides, a number of similar incomplete or doubtful relations, noticed especially by Beccari, as, for example, that of the palms of the genus *Korthalsia* to *Camponotus hospes* EMERY and *korthalsie* EMERY; that of plants of the genus *Triplaris* to various ants which inhabit their stalks, etc.; but minute investigations of them are still wanting. The future will yet bring us many surprises.

(c) *Casual relations*.—We have already become acquainted with these in that kind of nest in which the ants make use of natural cavities. Hollow acacia thorns are also frequently used as dwellings by ants which elsewhere make their nests in an entirely different way. Thus, Mr. Wroughton once, in an exceptional case in India, found *Sima nigra* JERDON living in an acacia thorn.

7.—COMPOUND NESTS.

In the Communications of the Swiss Entomological Society, Vol. III, part 3, 1869 (Observations on the habits of *Solenopsis fugax*), I first called attention to the fact that two hostile species of ants can live in nests which are regularly intercalated. In my "Fourmis de la Suisse" (1874), I showed that such relations occur very frequently and more or less accidentally among many species of ants, especially under stones that are well adapted to nests and greatly in demand; while, in *Solenopsis fugax* LATR., "double nests" form a very ordinary, in fact, the most ordinary, occurrence, at least in our meadows. Wasmann (The Compound Nests and Mixed Colonies of Ants, Münster i, W., 1891, Aschendorff's) has corroborated and supplemented my observations on this subject. Instead of the name "double nests," used by me, he has introduced the more correct expression "compound nests" (to be translated into French by "nids composés"). In fact, these nests are not unfrequently threefold, and even fourfold—that is to say, the nests of from three to four different and hostile species of ants are built into each other, without, however, having any open communication with each other. If the partitions are destroyed, war ensues immediately. The worker of *Solenopsis fugax* is a puny, yellowish ant, hardly 2 millimeters in length, but the females grow to an imposing size, and look like giants by the side of the workers. This species is in the habit of digging its nests in the thick walls of the nests of the ants of the larger species, and in such a manner that, wherever there is room, large halls are constructed (fig. 6, S), in which the females and the males are comfortably lodged with their large pupæ and larvæ, while small passages connect these halls. Extremely small passages, not visible in the figure, afford the workers exclusively admission to the chambers of the host ant (fig. 6, F01). According to my observations and those of Wasmann, *Solenopsis fugax* lives like a thief and little robber, at the expense of its involuntary host. The little workers make their way through extremely small passages to the pupa and larva heaps of the large ants and devour them from underneath without being seen, thanks to their small size. They also devour openly the forage supplies, as well as the dead and sick individuals, of the larger species (mostly *Formica fusca* L., but also *Formica rufa*, *F. pratensis*, *F. sanguinea*, *Polyergus rufescens*, *Lasius niger*, etc.).

Fig. 6 represents a fragment of a double nest of *Formica fusca* and *Solenopsis fugax* from the Zurich Mountain. By means of dissolved shellac, which I poured upon the nest in fine weather, and then allowed to dry, I succeeded in making it firm enough to be able to take it out without injuring it. The fine-grained, polished interior walls of the *Solenopsis* cavities are seen, in contrast to the coarse-grained and more spacious *Formica* chambers. As the ants take up the moist earth with their mandibles in the form of small lumps, and then work it into shape with their jaws and forelegs, in order to construct their masonry with

it, and as, moreover, the large *Formica* works with much coarser particles than the puny *Solenopsis*, the different character of the walls is at once explained.

I have already explained the frequent occurrence of imperfect, more accidental compound nests of other species of ant, by ascribing them to the acquisition of favorable localities, especially the underside of stones. From this competition frequently arise very murderous underground wars, which I have often watched. I have noticed closely, in glass apparatus, how they are carried on. The ants mine toward each other. A battle begins where their work happens to meet. The conqueror forces his way into the gallery of the conquered. The latter, however, hastens, after he has retired a few millimeters or centimeters, as the case may be, to stop up his gallery thoroughly with earth. The victor does not then, by any means, always succeed in again finding the entrance to it, but, in many cases, mines by the side of it, and thus partial interappings of the nests arise. The galleries of *Solenopsis fugax* are often broken through by the large ants. The little robbers are, however, in the first place, very courageous and combative; and, in the second place, they know how to mine rapidly and how to barricade rapidly, and by this means to make a skillful use of all the partitions, as I have been enabled to observe directly in the glass nest. The digging and fighting spirit is at its highest pitch among the ants in the first half of the summer, when the nests have to be enlarged for the brood. It then ceases, and truces follow; in the autumn there is abundant space for all, and peace prevails. It is not without reason that the females and males of *Solenopsis fugax* do not swarm until September, when the swarming time of their host ants (July=August) has long been past. They can then, in spite of their size, go to the upper surface of the nest and swarm undisturbed, as I have seen myself, whereas they could not have done so earlier without great danger.

A peculiar variety of the compound nest is formed by the dwelling of the guest ant *Formicoxenus nitidulus* NYL., with *Formica rufa* and *Formica pratensis*, which I first discovered in a fragmentary condition, and which Adlerz subsequently found and described more fully. *Formicoxenus* hunts the large *Formica*, and even follows it up closely throughout its changes of abode, as Wasmann first noticed, and as I have verified. By *Formica*, on the other hand, it is merely tolerated and superciliously ignored. The peaceable guest constructs in the walls of the nest of its large host ant little chambers and passages, which are, however, only imperfectly closed, and open freely into the chambers of the *Formica*. In these little chambers lie the brood of the *Formicoxenus*. The *Formicoxenus's* mode of subsistence is still unknown.

8.—NESTS OF MIXED COLONIES.

The mixed colonies of the slaveholding ants and parasite ants (*Polyergus rufescens* LATR., *Strongylognathus testaceus* SCHENK and *S. huberi* FOREL, *Anergates atratulus* SCHENK, *Xenomyrmex stollii* FOREL) have

nests which always display the architecture of the working ant (slave or host), and have no further interest for us here. When *Polyergus rufescens* seizes *Formica rufibarbis* and keeps it as its slave, its nest resembles a larger nest of that species; if, on the other hand, it enslaves *Formica fusca*, its nest looks like the nest of *Formica fusca*, because the so-called slave or auxiliary ants are the only builders.

The case appears to be somewhat different in the rare, natural, fortuitous mixed colonies (*Formica pratensis* or *truncicola* or *exsecta*, with *Formica fusca*; *Tapinoma erraticum* with *Bothriomyrmex meridionalis*) discovered by me (Fourmis de la Suisse), as well as in *Formica sanguinea* LATR., which almost always keep slaves, but notwithstanding also work themselves. Here the nest assumes a mixed architecture, as both species of ant work on it, each in accordance with its instinctive art. And yet they do not interfere with each other. Each species understands how to combine its work harmoniously with that of the other, although the methods of the two are often very different, as, for instance, with the mason ants, *Formica fusca* and *Formica pratensis*, which work more like carpenters with their little branches and cross-pieces. *Fusca* unites the wooden rafters of *pratensis* by means of moist earth, and the whole lasts very well. I have also caused many artificial mixed colonies to be founded between *Formica sanguinea* and *F. pratensis*, etc., have even discovered naturally established colonies of these two latter species, and have investigated their mixed architecture.

9.—MIGRATORY NESTS.

Belt (The Naturalist in Nicaragua, 1874) was again the first to discover the hitherto-unknown nest of the American migratory ants (*Eciton*). He found in the forest an immense ant ball, from which all the robber columns issued, and in which all the brood lay. Here was a genuine nomad nest, a living nest without a house. Sceptical as we had been with regard to the other discoveries of the genial Belt, we remained so respecting this one, too, until I succeeded, in the year 1885, in interesting Fritz Müller's younger brother, Dr. Wilhelm Müller, who was residing at that time at Blumenau with his brother, in this question. Dr. W. Müller has published the results of his very interesting observations in the first volume of Kosmos (1886, p. 81: Observations on Migratory Ants). That which bears upon our subject may be summed up as follows: The larger species of *Eciton*, which have eyes (*hamatum* F., *foreli* MAYR, *quadriglumis* HALID. [= *legionis* SM. = *lugubre* ROGER], etc.) do not build or excavate any nests. They live a wandering life and merely occupy with their extremely numerous colonies spacious, naturally sheltered places, such as hollow trees or shrubs, in which they live rolled up together in immense clusters (one cluster of ants and brood, measured by Dr. W. Müller, which did not compose half the colony, measured in an etherized state 5,600 cubic centimeters). The larvæ and pupæ first collected by Dr. W. Müller and examined by me

lie at liberty among the ants, and are carried by them. The robbing expeditions are undertaken in the daytime, and the booty is carried to the migratory nest, where it serves chiefly as food for the larvæ. When one locality has been sufficiently pillaged the whole colony migrates to another resting place. These latter migrations with bag and baggage, that is to say, with the brood, take place exclusively at night.

Far less is known about the nests of the blind species of *Eciton* and the entirely blind migratory ant genera *Dorylus* and *Ænictus*, whose workers had previously, like the male of *Eciton* (*labidus*), been classed as separate genera (*Typhlopone* WESTW. and *Typhlatta* SMITH), because their connection with the previously described males was not yet known. I have myself seen *Dorylus juvenculus*, at Gabés, South Tunis, hunting under ground. The winged males of *Dorylus juvenculus* FAB. (*badius* GERST.), *Eciton hetschkoï* MAYR, and *Ænictus wroughtonii* FOREL have been seen creeping out of the ground in company with workers and flying away. The very nest of *Dorylus helvolus* was dug up by Trimen, who found the female. Nothing more definite, however, is known. Are the plundered nests of other ants used for the moment as migratory nests? Are there here nocturnal migrations, too, and not robbing expeditions only? The future must tell us. At all events, judging by the observations made up to this time, including my own, *Dorylus* and *Ænictus* appear to prefer the neighborhood of human habitations, and to fight under ground with other ants.

10.—ROAD BUILDING.

Certain European ants, *Formica rufa*, *F. pratensis*, and *Lasius fuliginosus*, build genuine roads in our meadows. The finest and best finished are those of *Formica pratensis* DE GEER. A meadow, as has already been said, is a primeval forest to the ants. If the ants are like *Formica pratensis*, rather large, and if they are compelled, like that species, to drag home all kinds of timbers as building materials, as well as animal booty, a meadow, which otherwise furnishes them with the finest hunting grounds, presents terrible obstacles. *Formica pratensis* is awkward; we need only notice what inexpressible difficulty it has in making its way with a load through the thicket of blades of grass in a meadow, how constantly the load is getting wedged between them, and what incredible patience and perseverance the insect displays in the effort to go forward to understand the object of the roads. The road building of *Formica pratensis* presents one of the most wonderful displays of animal instinct that I know of. Several such roads radiate with great regularity from one of the larger nests of this species lying in a meadow; I have counted from three to eight and even twelve of them (so large a number is rare and occurs only in the case of very large nests). It can be seen that these roads lead mostly to trees or shrubs on which the ants climb up in multitudes in order to milk the plant

lice. The road itself is kept very clean, is from 2 to 4 centimeters in width, and is made more or less concave laterally. Not only is no movable object allowed upon it, not only is it kept always clean and in good order, but the ants, with the expenditure of incredible toil and strength, saw off with their mandibles every blade of grass that attempts to grow in the road, as they previously sawed off all those which were in existence when it was first constructed. Where the tufts of grass are too thick and strong, they go around them, it is true; but the roads usually run comparatively straight to their destination. Many of them are gradually lost in the grass; but as a rule they can be followed to a distance of 20, 30, 40, and in many cases 50 meters from the nest. One must watch long, closely, and above all in the spring, to see and understand the road building, and to avoid the impression that the road, as certain authors have thought, comes into existence of itself through the footsteps of the ants. These roads are very numerously frequented. All the building materials and forage are first dispatched to the nearest road, so that they may be carried comfortably from there to the nest. As *Formica pratensis* has very defective powers of smell, and is not skillful in finding its way, the roads are also of great advantage to it in this respect. There are only two directions on them, and it is no longer compelled to search laboriously for the right way. It can be seen, too, how rapidly and confidently the ants move to and fro on their roads, in contrast to their behavior in the grass. (Compare Forel: Collections of Swiss Zoology, Vol. IV, No. 4, 1888.)

The agricultural ants of Texas (*Pogonomyrmex barbatus* SMITH, *P. molefaciens* BUCKLEY) make a large clearing around their nests, according to Lincecum and MacCook, and numerous roads, in addition, by sawing off the blades of grass, like our *Formica pratensis*.

11.—REVIEW—THE ANT WORLD—LANDSCAPE TYPES OF THE ANTS' NESTS—POLYCALIC COLONIES.

Even among us in Switzerland, a close investigation of the meadows, the dry declivities of the mountains, the clearings of the woods and thickets suffices to show us speedily that almost everything is invaded by the structures of ants. Where there are no actual nests there are underground passages and galleries, open roads, covered ways, or, at least, the inhabitants of neighboring nests, who are scouting around and contending with one another for the possession of the plants containing plant lice and cochineal kermes, of the trees, the flowers, and the insect plunder. I have even seen young birds which had just slipped out of the nest killed and devoured by *Formica pratensis* in spite of the frantic rage of the parent birds. The ants certainly, no less than men, fancy themselves the lords of creation, for, thanks to their social organization, their numbers, and their courage, they have few foes to fear; their most formidable enemies are always other

ants, just as men are for other men. In the tropical world the struggle for existence is much fiercer than with us, and the ants, with their immense number of species, play a much more important part. Their nest structures there, too, are correspondingly far more varied, and display far more singular and complicated adaptations as the results of the fight for life. The future will develop many still more astonishing discoveries.

We will now only give a glance at the most ordinary ant structures with respect to the nature of the ground.

In the meadows we find, above all, the mound structures of earth, but side by side with them the mixed mounds of *Formica pratensis*, *sanguinea*, and *pressilabris*, together with pure excavated nests. On detritus and declivities, we find chiefly nests under stones, and the same upon mountains generally. In the forest we find the mighty mounds of *Formica rufa*, *exsectoides*, and *exsecta*, frequently gathered into large, united kingdoms, containing many nests (polycalic colonies), and also the tree nests of *Lasius fuliginosus*, *L. brunneus*, *Camponotus herculeanus*, *Liometopum microcephalum*, etc. Genuine, that is to say free, tree nests of pasteboard or web in the boughs of trees do not occur in Europe. Lastly, in the forest clearings, the edges of the woods, and in thickets we find a rich mixture of the three above-named landscape types with respect to ants' nests. The meadow type, the forest type, and the detritus or declivity type are here mingled pellmell.

The nest structure in the desert, as I have been enabled to learn by observation in southern Tunis, forms a peculiar type. There all is excavated in the sand. There are neither mounds nor stones, but at most hillocks of sand around the openings of the nests.

My object has been merely to give, by the aid of drawings, a clear view of our present knowledge of the nest building of the ants and to communicate some new facts in connection with it. I trust that I have succeeded.

To conclude, it is a pleasure to me to express my warmest thanks to my friend Mr. Ludwig Schröter for his successful drawings; to Professor Schröter for his kind assistance, his suggestions, and his advice; and to the persons who procured me my excellent materials, especially my friends, Mr. Wroughton, Dr. Frick, Professor Emery, Dr. Liengme, and Professor Mayr.

EXPLANATION OF PLATES LV, LVI.

Fig. 1. A gall, inhabited by *Polyrhachis gerstäckeri* FOREL, from Delagoa Bay, South Africa; collected by Dr. Liengme. One-sixth less than the natural size.

A. The gall from the outside; op., the egress opening of the gall producer, used by the ants.

B. Longitudinal section through the gall, showing the cavity and its filling of web and a half partition.

Fig. 2. Longitudinal cross section of the stalk of *Solanum auriculatum*, from Antananarivo, Madagascar, inhabited by *Technomyrmex albipes* SMITH; collected by Père Camboué. The marrow of the stalk has been divided by the ants into chambers. Two-thirds natural size.

- Fig. 3. A leaf of *Eugenia jambolana*, the cellular tissue of which, between the two surfaces, has been eaten out by a worm, and which has then been inhabited by *Cardiocondyla wroughtonii* FOREL. Collected at Poonah, India, by Mr. Wroughton. Two-thirds natural size.
- Fig. 4. Pasteboard nest of *Polyrhachis mayri* ROGER, half open, showing the interior; resting upon a leaf. From Ceylon; collected by Major Yerbury. Two-thirds natural size.
- Fig. 5. A nest of *Leptothorax acervorum* FAB., excavated in the cork layer of the bark of a fir; spread out flat. Cross section along the plane of the nest; an opening at *a*. From Switzerland. Two-thirds natural size.
- Fig. 6. Piece of a double nest of *Formica fusca* L. and *Solenopsis fugax* LATR., collected by me near Zurich and preserved by impregnation with shellac. Two-thirds natural size.
- W. The plane of separation in the walls of the nest of *Formica*.
 For Excavations of *Formica fusca* (recognizable by the coarser grain and the greater width).
 S. Excavations of *Solenopsis fugax*, made in the walls of the nest of *Formica*, recognizable by the fine grain.
 S.o. Openings of the passages which connect the larger chambers of *Solenopsis*.
- Fig. 7. Web of *Polyrhachis dives* SM., from the East Indies. Microscopic enlargement; Hartnack, System IX.
- Fig. 8. Nest of *Polyrhachis spinigera* MAYR, from Poonah, India; from a sketch by Mr. R. C. Wroughton, divisional forest officer at Poonah. The nest lies under a stone and is excavated in the ground, but is lined with a fine web, as Mr. Wroughton has repeatedly verified. The figure represents an imaginary cross section, somewhat smaller than the natural size.
- St. The stone.
 Gr. The ground.
 W. The web.
 Op. The opening for ingress and egress.
 Cell. The nest excavation.
- Fig. 9. Fragment of the mound of a ground nest of *Lasius niger* L., from Zurich. We see how blades of grass and leaves are used as pillars, arches, etc., in the masonry. Two-thirds natural size.
- Fig. 10. Nest web of *Ecophylla smaragdina* FABR., received from India, through Mr. Wroughton. We see from this fragment how the leaves of a tree are united into a nest by means of the web. W., the web. Two-thirds natural size.
- Fig. 11. Flat surface of the head of a soldier of *Colobopsis truncata* SPIN., from Vaux, Canton Waadt, Switzerland, seen from the front, and magnified ten times.
- Man. Upper jaw.
 C. Cheeks.
 F. Forehead.
- Fig. 12. Perpendicular cross section of the nest of *Tapinoma erraticum* LATR., from Vaux, Canton Waadt, Switzerland. Preserved by me by means of impregnation with silica. Two-thirds natural size.
- D. Temporary mound of earth.
 Int. Interior of the nest, with its natural framework of blades of grass.
 Min. Beginning of the underground excavated part of the nest.
 Gr. Cross section of the ground.
- Fig. 13. Cross section of a fragment of a nest of *Colobopsis truncata* SPINOLA, excavated in the wood of a dead, but extremely hard, pear tree. Found by me at Vaux, Canton Waadt, Switzerland. Four-thirds natural size.
- Ch. Excavations of the nest in the wood.

Fig. 13—Continued.

B. Bark of the bough of the pear tree.

O. Opening of the nest outward, and head of a soldier of *Colobopsis truncata*, who is guarding this opening, or, rather, who is keeping it closed with his head, as with a stopper. The soldier is standing in the egress passage, which is seen in cross section.

W. Two workers of *Colobopsis truncata*, one in the nest, the other outside, hurrying to the entrance, where the soldier, drawing back, will make room for him for a moment.

Fig. 14. Cross section of the pseudo bulb of *Hydnophytum montanum*, received from Java, through Dr. A. Frick, of Zurich. Photographed in one-third of the natural size. The stalk, the leaves, and the root of the plant are also seen (see text).

Fig. 15. Pasteboard nest of *Dolichoderus bituberculatus* MAYR, on the bough of a tree. Received from Bangkok, Siam, from the late well-known turner, Mr. Sigg, of Zurich. In order to show the interior labyrinth, a portion of the nest has been removed by a flat, perpendicular cut. Photographed in one-third of the natural size.

Surf. Surface of the cut and inner labyrinth.

U. s. Natural upper surface of the nest.

Br. A small branch of the main bough, cut through and inclosed in the nest. The nest rests upon the main bough.

Fig. 16. Web of *Polyrhachis spinigera* MAYR, from Poonah, India; received from Mr. Wroughton. Microscopic enlargement; Hartnack, System IX. (Compare fig. 8, Gesp.)

Fig. 17. Nest wall of *Polyrhachis jerdonii* FOREL, from Ceylon; received from Major Yerbury, through Mr. Wroughton. Microscopic enlargement; Hartnack, System VII.

Fl. Small flakes of vegetable matter.

Web. Spun net of the ants, by means of which these flakes are joined together in a web.

Fig. 18. A piece of the nest pasteboard of *Dolichoderus bispinosus* OLIV., from tropical America; received through Professor Emery. Microscopic enlargement; Hartnack, System IV.

Fib. Vegetable fibers (of *Bombax ceiba* L.) of which the nest pasteboard is composed.

Cem. Ant cement, or lac, by which the vegetable fibers are glued together or fastened (of a bright yellowish or brownish color).

Mesh. Empty meshes left by the nest walls between them.

Fig. 19. (See text, p. 487.)

N. B.—All the figures, except fig. 8, were drawn or photographed (figs. 14 and 15) from nature by Mr. L. Schröter. I myself drew only fig. 11 and the ants in fig. 10.

The originals of figs. 1, 2, 3, 4, 7, 10, 14, 15, 16, 17, and 18 are in my collection; those of figs. 5, 6, 9, 12, and 13 are in the entomological collection of the Museum of the Federal Polytechnikum (my former collection of European ants' nests).

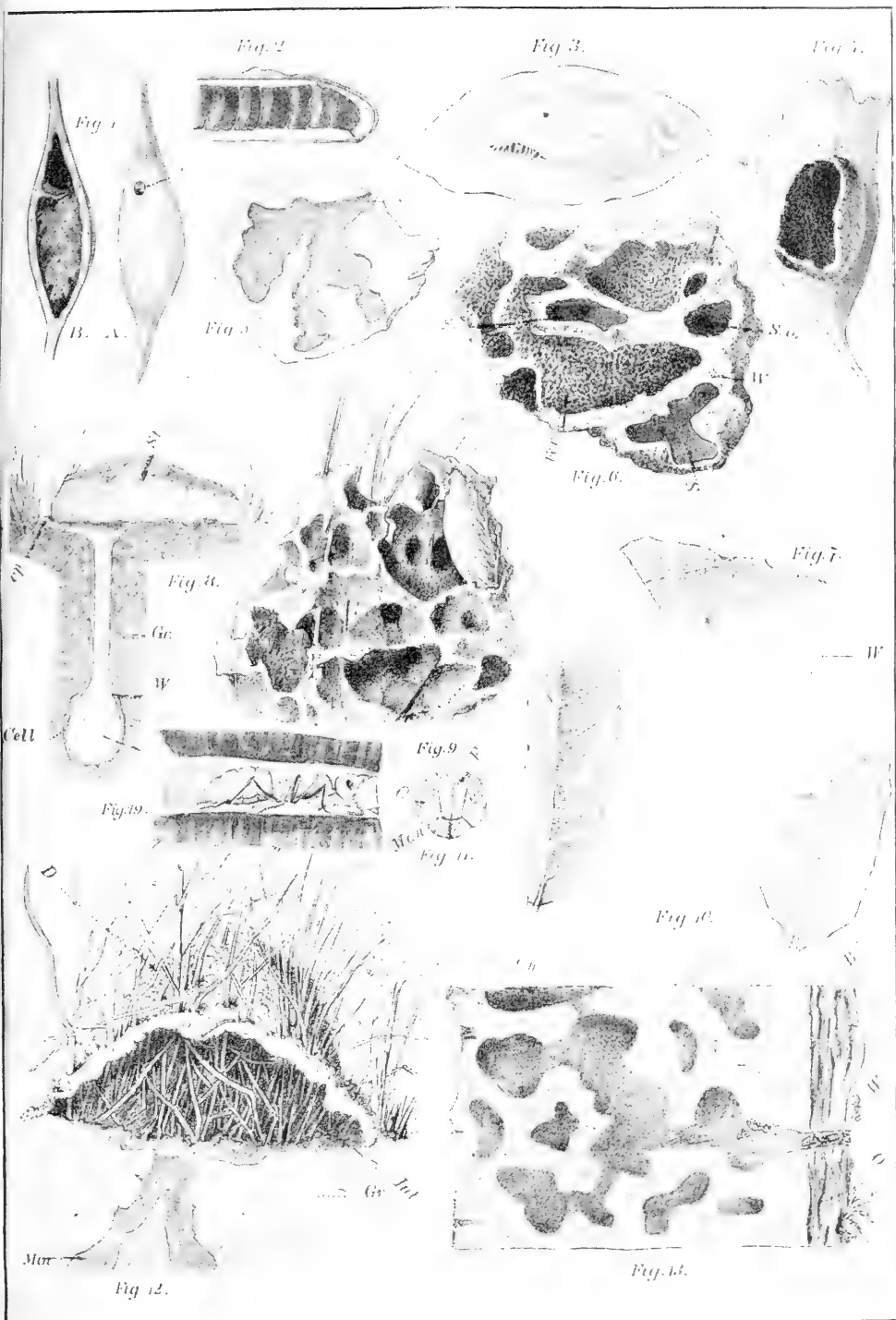

ANTS' NESTS.

(For explanation of figures see page 503.)

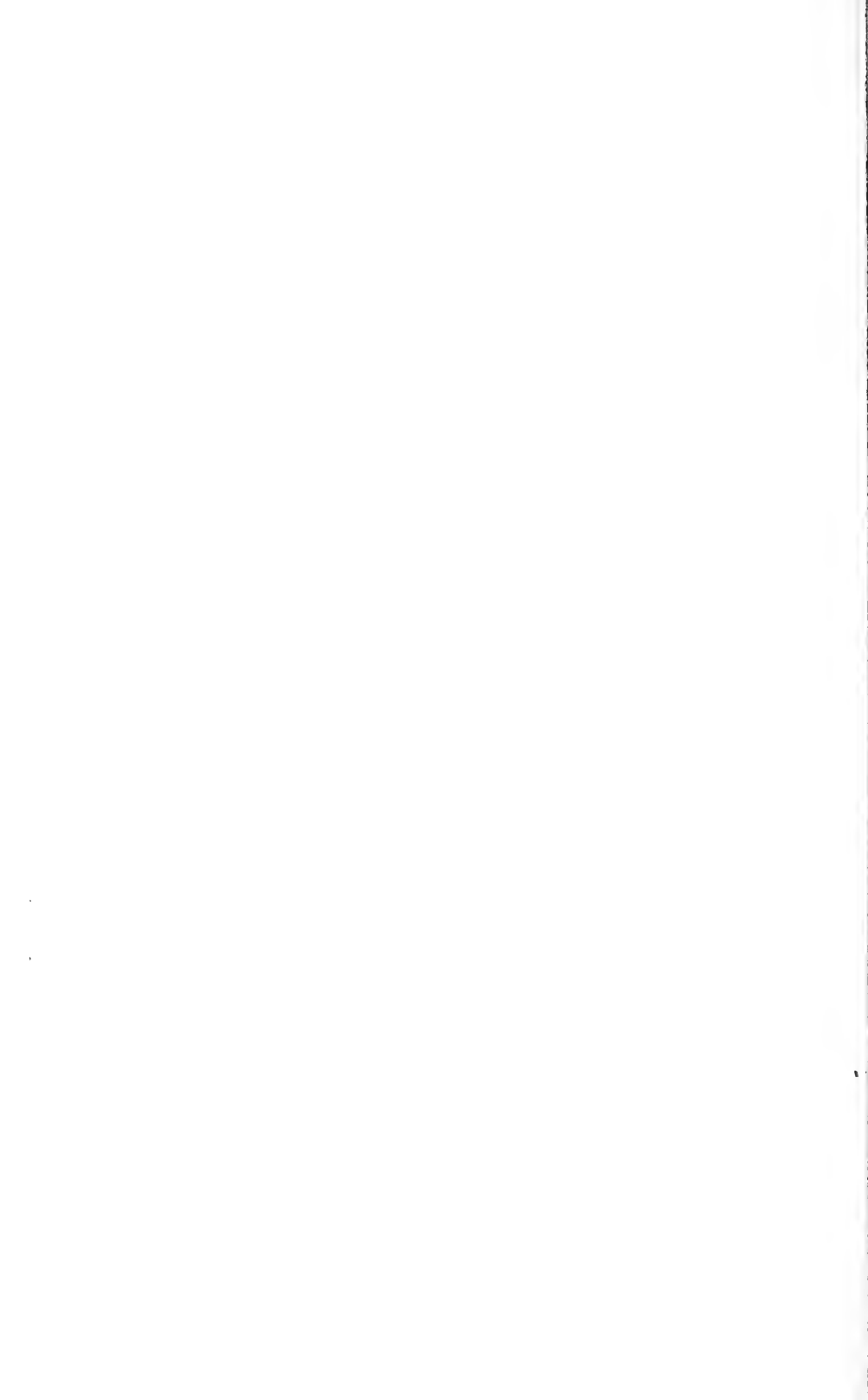



ANTS' NESTS.

(For explanation of figures see page 505.)

THE EVOLUTION OF MODERN SOCIETY IN ITS HISTORICAL ASPECTS.¹

By R. D. MELVILLE.

The key to the enigma of the universe is found in the doctrine of evolution. Far from being the purely modern theory, as which it is so generally regarded, it is merely a redevelopment of the theory of a certain school or system of Brahman philosophy—that of Kapila, which dates from at least five hundred years before Christ. This system “assumes the existence of a primordial matter from all eternity, out of which the universe has, by successive stages, evolved itself.” So our theory of evolution is no new idea after all, though perhaps much more definite and particular than that of the Eastern philosophers.

To the physical, animal, vegetable, and even mineral worlds, the doctrine of evolution equally applies, and its significance is not confined to a necessary connection between the terms “evolution,” “man,” and “monkey,” so often nowadays found unalterably associated in the minds of the ignorant. The doctrine is a fundamental conception of all science—mental, moral, and physical.

In the last of these divisions, viz, physical, with which our subject starts, from the *Amœba*, the lowest existing form of animal life (the single-celled protoplasm), to the human being, the highest existing development of protoplasmic organism and the most complex and complete creation in nature, all is the history of evolution. The history of the individual, with which our inquiry more particularly deals, is a particular example of the universal history of the human family—the story of the evolution of mind. And the story of mental evolution is the history of the evolution of morals.

As we run up the scale of organism, passing from the simple to the more and more complex, we are forcibly struck by the at once close connection and yet wide separation between mere animal and human life. Organically and physically the same, the separation lies in that mental constitution, using the term in a higher and more strictly philosophical sense. Yet, where the physical ends and the mental begins is impossible definitely to determine.

¹From the *Westminster Review*, March, 1895, Vol. CXLIII, No 3; by permission of the Leonard Scott Publication Company, New York.

It is the history of that mental constitution in its development that we propose here to trace in its general aspects. That history is the story of the evolution of society.

To trace the evolution of society is to trace the growth of mind subsequently to the evolution of the individual. Our task, however, is somewhat easier than it has been in the earlier stages of our inquiry. We have larger facts and stronger evidences, while the periods of time to be considered are infinitely more adapted to the grasp of the ordinary mind. Instead of dealing with thousands and tens of thousands of years, as ciphers, we work with centuries and decades. We employ analysis, synthesis, and criticism; but our materials are larger. We do not require such minute analysis, such exact synthesis, or such critical discrimination as were necessary in earlier investigation.

Society, as we shall use the term here, must be understood in its widest significance—that aggregation of bodies of individuals, which bodies in themselves constitute a “society” (in a secondary sense), a “polity,” or a “state.” Each of those secondary societies or states, which go to form the widest conception of society as a whole, are, in our enlarged subject, as the individual is to the community in which he is placed. We said that the individual was the highest point reached in the evolution of organism. Society as a whole is the highest point attained in the evolution of the individual, which is merely a further stage in the evolution of mind.

Dr. H. D. Traill, whose name must be familiar to all in the field of intellectual investigation, says: “Every civilized society is in the nature of an organism, the shape and direction of whose evolution depends in part upon the action of internal forces and in part upon the influence of surroundings.” The fundamental principles of evolution—“struggle for existence, adaptation to environment, survival of the fittest”—all apply here, just as to the individual animal life.

The study of evolution in all its branches is the study of history; but history of different kinds. The study of the evolution of society is history in its highest and truest sense. It is the study of man in his advance from barbarism to civilization, from civilization to culture, and of the principles and institutions which have aided his upward march and developed his present character. In it we read the story of progress. We see it, to use the common but appropriate metaphor, like a little spring, bubbling up from the rocky soil, ever in danger of being dried up. It moves on—a tiny rivulet—whispering and gurgling, yet ever enlarging as it goes. The rivulet becomes a stream; the opposing pebbles become great stones; the stream grows to a river, a great volume of water, deep, strong, and irresistible, cutting out channels for itself, overcoming all obstacles, leaping, circling, and falling, till, as Kingsley puts it—

Strong and free, strong and free,
The flood-gates are open;
Away to the sea,

and the tiny rivulet, swelled to a mighty river, "loses itself in the infinite main." It is difficult for us to realize that the man of the present day—the bridger of ocean and air, the transcendental student of the infinite, the scientific explorer of the universe—is "the selfsame being, the same in form, in mind, in destination, as the poor, creeping, untutored savage who ages ago, in his weakness and ignorance, looked upon the little earth around him as the whole of creation, upon the ocean as he knew not what, reaching he knew not where; and who stood gazing with mingled fear and admiration as the fires of heaven alternately rose and set, glimmered, and faded away."

This is the conception of man—the individual, the protoplasm of society—with which we enter upon our investigation; in the present instance, a mere sketch.

Originating in the individual, society is represented in its first stage by the family. This, as we know, formed the basis of the Hindoo community, the Grecian State, the Roman State; and we have analogous evidence to prove that it was the foundation of all other earlier communities besides. This was society in its patriarchal stage.

In our present investigation it is advisable to proceed upon certain definite lines. We shall better attain our object now by tracing, by general indication, the gradual growth and development of manners, customs, religion, laws, industry, arts, learning, literature, scientific knowledge, and institutions. These, in the order enumerated, I conceive to be the outcome of social evolution. In its earliest stage—the patriarchal—only the first two or three of these characteristics existed or could exist in any definite form. Manners, customs, and religion, in however crude a form, exist wherever we have the nucleus of a society. Laws, as such, were a later development, their place in early communities being filled by custom—an arbitrary code sometimes marvelously allied to natural justice, at other times subverting all modern conceptions of that moral law. The rule of life at this period was, generally, "might is right," the only rule practicable in an age when, according to the philosopher Hobbes, all men were in a state of hostility to each other, and each man took as he was able, by the strength of his arm.

The nature and general treatment of our subject enable us to pass over the first beginnings of anything like a concrete society, and take up the thread at that point where laws and commerce, being added to customs, manners, and religion; were beginning to mold the whole body of society into something like a definite form. Arbitrary customs, primitive manners, religious forms and ceremonies are now modified and improved. The unwritten law of custom is now expressly stated as law, and the first real step is taken in the practical organization of society. We find this situation realized in Rome at the time of the republic, at and for some time after the publication of the famous Decemviral Code known as the Twelve Tables. At the same time intercourse with aliens, for sale and barter and exchange of commodities, begins to exercise a

marked influence upon social development. From this point our course is clear. We can not enter into particulars; that is impossible here; neither can we trace, even in barest outline, the course of the history of the world and its peoples. It is, however, generally understood that the history of society—social, moral, and political—is the history of European peoples; and of these the course of progress is traced in the history of a certain few. Not that we can exclude Asiatic, African, or American races from the conception of society as a whole, but only in so far as these have advanced a certain length, while our inquiry is from the lowest to the highest position yet attained, we must leave these lagging societies behind, and follow that portion of the human race in the van of the army of progress. Our course is marked by many great landmarks, impossible to be mistaken, and every one significant in a peculiar degree. These landmarks are social revolutions. A certain writer (Edgar Quinet, I think, but can not at this time verify) said that “great revolutions are the prominent and enduring landmarks on the highway of the world, far raised above all surrounding objects pointing the progress not of particular nations but of the human race.”

Our first halting stage is on the ruins of the Roman Empire.

The social question and society as we understand it to-day had its rise in the feudal system. And this, for so long a net about the feet of the world, was yet a benefit in disguise of an evil adapted to the age in which it flourished. As snow enveloping the earth in a mantle of white renders all external things bleak, bare, and unpromising, yet under its cold covering keeps warm and living the seeds that, when the due time comes, will burst and beautify the face of nature, so the feudal system enveloped society for nine centuries in a cloak of darkness; yet underneath it nourished the spirit and the principles which, when the time arrived, burst forth and blossomed into rational institutions and made the world what it is to-day. But the feudal system had its rise when Rome had lost her greatness and been humbled in the dust; when the Roman character as much resembled the ancient conception of old Cato the Censor as an Anglo-Saxon of the Conquest resembles an Englishman of the present day.

When, in course of time, Roman conquests embraced every part of the then civilized world and every king or prince yielded obedience to her authority, then was the time that sealed her fate. The old Roman character was sapped and enervated by wealth and luxury. The Roman conquests were maintained by mercenaries, her public offices and funds were filled and controlled by aliens and self-seekers. Abandoning herself to ease, yet with the lust of conquest still as strong as ever, she intrusted her rule to the hands of a few and watched the course of events. Her Empire, spreading on every side, at last overbalanced itself. She was drawing her life from her extremities. As these fell or rotted away by corruption she grew weaker and weaker. Her officers,

left practically to their own discretion and resources, worked for their own advantage. The rights of her people were one by one invaded. Taxes were levied, growing heavier as the luxury and vice of those in authority grew greater. At last all unity was lost, and the last scene of the last act came. Rome tried to rise to the occasion, but her strength had left her. Barbaric hordes poured in upon her from every side and engulfed her. "On the ruins of the splendid temple now stood the hut of the savage, and in place of the polished and once noble Roman now stalked the Ostrogoth, the Visigoth, and the Saxon."

In the fusion of the Roman and Teutonic elements the feudal system was born. The Roman Empire on its death bequeathed a precious legacy to the world—a mighty intellectual influence, a noble literature, and a system of law which changed the destiny of society. It is said that many people do more by their death than by their life. The reason is obvious. So it is with institutions and societies. Had Rome lived, her rapid degeneracy would have polluted the world to all time. But she died in time for her past greatness to be remembered and exalted and for her shame to be forgotten.

After this the wave of progress swept over France and Germany and across the English Channel, till it found a barrier and a basin in the British Islands. In its course it left the places over which it swept damp and dreary, but with a freshly moistened soil fitted to produce great crops.

From the eleventh to the seventeenth centuries Britain is spoken of, and truly, as "the keystone of history" and the battlefield of freedom; and, to quote from an anonymous writer of vivid style, "the march of religion, of liberty, and of improvement was . . . over the soil of Britain."

The second great landmark in our course is the Norman Conquest; chiefly significant in its fusion of the elements which formed the character of a nation second to none in power and wealth and influence at any period of the world's history. This is no mere boast. The impartial observer can not fail to acknowledge the peculiar characteristics, partly due to circumstances, partly to environment, and largely to nature, which have enabled the British to win and hold an empire in comparison to which that of Rome almost sinks into insignificance. There was among the legacies bequeathed by Rome to the world one destined to have a greater influence upon its fortunes than all the others combined. This was Christianity, or the Church.

It is understood, of course, that, speaking generally, all these progressive influences worked through one great factor—knowledge. The progress of this agency was slow but sure. After the fall of Rome it was opposed by a vast wall of ignorance and barbarism, and for centuries was at work unseen. It attacked the foundations of the barrier, working silently, gradually making a passage, ever enlarging the same, and as the passage got wider the stream grew fuller and stronger, till

at last the huge fabric, undermined, came crashing to the ground, opening to view vast vistas and expanses hitherto undreamed of.

In the beginning of the ninth century Britain, in common with the rest of Europe, entered upon a long period of social darkness, which continued almost unbroken until the fourteenth century—we might almost say to the middle of the fifteenth century.

During all this time scarce a ray of light broke through the dark mists of ignorance to throw ever so slight a light upon the chains of feudalism.

This system was introduced into England by William the Conqueror in the eleventh century, primarily to preserve his own sovereign power, secondarily to secure national liberty, by putting a check upon the strength of his great nobles, who in wealth and followers might with some reason attempt to match their power against that of the King. But in England the system, harsh as it was, never obtained the same complete ascendancy as over the peoples of the Continent; never so completely obliterated the individual to the advantage of a select few. Even at that early period the prerogatives of the sovereign were hedged in by certain restrictions. For instance, after the Conqueror, we have what is known as the Charter of Liberties, granted in the year 1100 by Henry I expressly limiting the regal prerogatives, and declaring the liberty of the laws, the people, and the church. Further, it had as an end the repression or restraint of unlimited feudal rights amongst the nobles, where they tended toward cruelty or oppression. To run on a little way, and passing over the reigns of the unfortunate Stephen and the hasty but too late repentant Henry II, and the chivalric Cœur de Lion, we meet the first great landmark in our own history after the Norman Conquest. This was the reign of the infamous John, whose name is even yet a byword for cruelty and craft, scarcely less significant than that of Nero or Borgia.

Through his reckless disregard of anything like rights, whether natural or granted by charter under the sacred seal of the sovereign oath, John brought about that which has been to our country what the Twelve Tables was to Rome, the Magna Charta—"the foundation," to use the words of Livy in regard to the former, "of all law, both public and private." At this time, too, we note the meeting of the first national assembly of elected representatives in Britain, summoned by Stephen Langton, archbishop of Canterbury, at St. Albans. Its object was to reform the abuses rampant under the rule of John. It was based on the charter of Henry I, which we have already mentioned. The sphere of this paper does not allow us to enter into the details or terms of the Charta, beyond stating that they aimed at the restraint of feudal oppression, the impartial administration of justice, and the recognition of the right of every individual to the protection of the laws. No doubt, the system inaugurated by the Magna Charta was rude, unscientific, and incomplete; and further, it can not with any truth be

designated as a "popular" victory, according to our modern sense. The barons at that time were the only "people." The justices they sought to have remedied, though affecting high and low, still primarily affected themselves. Their honor, or their power, was threatened by the sovereign's arbitrary dispensation or disregard of justice, whether coming directly to themselves or through their dependents. But the Magna Charta of 1215 is important, inasmuch as it was the source of what are at the present day the stable elements in the British national life and character—the unsubduable love of liberty, the system of limited monarchy, self-government, and universal representation. These are the characteristics which have gone to form that great unwritten and arbitrary code, the British constitution.

After this little digression we must go back and take up the thread we have dropped. The significance of what we have just been regarding will be evident, if not now, at any rate before we have finished.

The tenth century found Europe enveloped in almost total intellectual darkness. Italy and Great Britain, destined (the first again) to become afterwards the home of the arts, sciences, and culture, at this time slept, overcome by pernicious fruits of servitude. France and Germany were, if anything, intellectually brighter. Here and there a faint gleam served to make the darkness visible. "Compared with the seventh and eighth centuries, the tenth," says Hallam, "was an age of illumination." Still, this chrysalis condition of society continued. The twelfth century shows, in France particularly, some sign of an awakening mind. In this century, literature—the index of the mental condition—had its second birth. The chief sources of intellectual progress at this time were, as enumerated by Hallam, (1) the institution of universities; (2) cultivation of modern languages, followed by the multiplication of books and the extension of the art of writing; (3) the investigation of the Roman law; and (4) the return to the study of the Latin classics. These are due in large measure to the growth of what is known as scholasticism, originating, it is supposed, in the ninth, but more generally attributed to Roscelin, of Compiègne, in the twelfth century.

About this time the universities of Paris and Bologna were founded, and a little later those of Oxford and Cambridge. From these points the light of knowledge was diffused over the world till, from a few tiny glimmering sparks, arose in time a brilliant illumination. The dark clouds of ignorance and superstition were gradually melted and dispersed as the strong sun of reason rose higher and higher in the intellectual sphere.

This brings us down, in a very general way, to the beginning of the fifteenth century, the period known in history as the revival of learning, and, a little further on, to our third great landmark in the road of social progress—the fall of Constantinople, in 1453, and its far-reaching effects, constituting what we understand by the Renaissance.

This period is important and significant in the history of the evolution of society. Europe now began to shake off the fetters of ignorance. From this time onward progress is by leaps and bounds. Certain events contributed much to the general awakening of intelligence and inquiry. These were the momentous invention of printing by Gutenberg, of Strasburg; the discovery of America in 1492; the voyage of Vasco da Gama in 1498, and, latest and greatest, the Reformation of 1517. The Reformation is our fourth landmark, another of our intellectual revolutions, and this brings us to an interesting and important inquiry. We said a little earlier that what was destined to be the greatest influence bequeathed by Rome was Christianity, to which we shall refer generally, since we are dealing with Europe, as the church. For fifteen hundred years this power had existed, and now it asserted itself. Where during all this age of social darkness was this revolutionizing power? Alas! that I have to say it, like many another great and noble power, debased, distorted, prostituted! That which should have been to society through all this time what the pillar of cloud and fire was to the wandering Israelites, a guide and a support, was a snare and a pitfall. The church—religion—was made to serve as a cloak to worldly sin and ambition. For these ends, while attempting to maintain an outward appearance of purity, it fostered superstition and ignorance. Till at last Luther arose, preceded, like the first and greatest of all reformers, Christ, by his forerunner, Erasmus. This is the greatest and most significant of all our landmarks. It marks a mighty revolution, fiercer and more thorough than any succeeding ones. It was a mighty stimulus to intellectual growth and social development. Till now it had been the world and the church; from now it was the world with the church.

A real society can only exist where the rights of every individual member as such are recognized and protected. Nor can this be until the individual has recognized his own position and his own rights. This was what the Reformation effected. In Britain the despotic reign of Henry VIII, the feeble reign of Edward VI, the bloody and bigoted reign of Mary, and the beneficial and epoch-marking reign of Elizabeth, all tended indirectly toward this result. The rapid growth of the spirit of liberty, and intolerance of oppression in the guise of sovereign care, is markedly manifest in our fifth great landmark and revolution—the overthrow of the monarchy in Britain and the establishment of the commonwealth. We see here, what we have not seen before this event, a power of combined action and unity among the people. This was what was required before they could ever hope to cope with hereditary individual or oligarchical authority.

And here let us pause and look back over the rough and stony road we have come along. We see from our higher elevation and with our clearer vision the great expanse of time covered with the feudal mists of the Middle Ages; yet where we can distinguish anything at all we

see men, as Campbell puts it, "Yoked to the brutes and fettered to the soil." We hear the ceaseless tumult of war, see from every point the lurid glare from burning homesteads, or the dead, black emptiness of devastated fields.

Although we say that indirectly the feudal system was a benefit to the world in the end, yet, regarding it in itself, we can not but acknowledge its evil effects at the time of its greatest power. It tended to obliterate the individual; to choke all spirit of independence, of pride or patriotism, in the people; to elevate a few at the expense of the many. What there was of pride or patriotism was rather a blind devotion to a particular head, and where the pride or patriotism of that head inclined, there the devotion of his servants followed.

Yet the people themselves were to blame for this unnatural state of society. They, in common with their masters, were under the despotic rule of custom, styled by Pindar "King over all mortals." If they made no effort to free themselves, it is not likely their masters would do it for them.

In this connection we have Shelley's splendid lines, in his Ode to Liberty:

He who taught man to vanquish whatsoever
Can be between the cradle and the grave,
Crowned him the King of Life. Oh, vain endeavour!
If, on his own high will, a willing slave,
He has enthroned the oppression and the oppressor.

In the Middle Ages, too, when life depended practically on the produce of the soil, the constant warfare and feud formed an insuperable obstacle to social progress. When the summer was far advanced, the air clear and warm, and everything giving token of the time when the face of the country should have been golden with ripe, waving corn, and the air melodious with the songs of the reapers, then perchance there would be a wide expanse of blackened fields and ruined homesteads. The lord's bugle had summoned his vassals from the plow, and the harrow lay rusting and neglected.

Improvement can only come when men have time and liberty to think. I would especially emphasize the significance of the latter of these terms—viz, liberty. Prof. Sheldon Amos, in his treatise on the Science of Law, has very well expressed what I am desirous of impressing here. "It implies," he says, "rest, meditation, imagination, slow and steady culture of the faculties, combinations and associations for all sorts of purposes, and especially that slowly formed belief in the certain power of carrying resolutions into action on which so much of human greatness depends. Liberty, in itself, is a negative term denoting absence of restraints; on its positive side it denotes the fullness of individual existence." This privilege was, all the time of which we are treating, in the hands of a few secluded hermits—dead to the world, yet living factors in its history. Under the protection afforded them by ignorance and superstition in the cloak of religion, these pursued their labors and their studies unheard, unheeded, and unseen.

Industries at this time there were none, to bring the people together and let them feel "the beating of the selfsame heart in each." War and religion were the only professions. Cultivation of the soil was often an impossibility; hence poverty and pestilence stalked everywhere, feasting on thousands of victims.

I hear even now the infinite fierce chorus,
 The cries of agony, the ceaseless groan,
 Which, through the ages that have gone before us,
 In long reverberations reach our own.

* * * * *

Is it, oh Man, with such discordant noises,
 With such accursed instruments as these,
 Thou drownest Nature's sweet and kindly voices,
 And jarrest the celestial symphonies ?

Yet there were, latterly, small communities, outside the power of the feudal lord, which formed the nucleus of future towns. It is there we must look for all the intellectual advancement, for the theoretical and practical organization of society upon a basis more in keeping with man's mind and mission. Their growth was rapid and their influence proportionate. Little by little the conception of a state was altered from that of a sovereign, omnipotent and divine, fountain of all mercy and justice, and a people, a collection of atoms, whose duty it was to support the sovereign in whatever caprice might lead him to perform, to that of a people, a collection of individuals, whose combined desires were represented and executed in the will and actions of a sovereign.

This is the modern conception of society, and brings our view somewhat beyond the point at which we last halted—the establishment of the commonwealth in Britain.

From now our view becomes so extended that we must either restrict ourselves to a bare outline or swell our investigation beyond all proportions.

European states now began to assume a more definite form. Still they were far from agreeing with our present-day conceptions of what a state should be. Louis XIV, in France, was rising to the height of his power. His subjects, carried away by enthusiasm and repeated victory, were devoted to him. But it was not a true devotion; it was a false enthusiasm. For all his magnanimity—and he had much—the people had no more power than before. Louis lavished gifts, encouraged commerce and art, and rewarded men of letters. Yet all the power was vested in the King. Success depended on the King's favor and caprice. All these efforts were spasmodic and ill-timed; many were fruitless, and their failure but increased the general confusion. It was impossible that, in a period of constant warfare and continual change, there could be any consistency or definiteness in the aims of society. The age of Louis XIV represents the state of Europe in the seventeenth century—an age of unrest, warfare, and diplomacy,

yet we must say development. The conditions then existing—the interrupted harvests, the overwhelming taxes, the constant drain upon the manhood of the countries, the capture and recapture of towns, and all the horrors, external and internal, consequent on war entered upon for the gratification of the caprice or pride of an individual—all tended toward a better and truer condition of society. Every additional impost, every new levy, was a step nearer the recognition by the people of their true position and their proper rights; toward drawing them together in the bonds of social unity; toward the downfall of tyranny in the guise of custom.

While the progress of society on the Continent was impeded by war and dissension, it was steady and uninterrupted in Britain. Not that we were without dissensions too. But our warfare was of such a nature that it tended to draw the people together for common ends. The civil war of 1642 and the revolution of 1688 were mighty factors in our own social history and that of the world at large. These were essentially contests between the Crown and the people, between arbitrary power and individual right. And these events are of the greater significance in that they could ever have happened. The victory was there won by unity and the courage of the conviction of the goodness of the cause. For the time, all private or sectarian animosities were forgotten. Bishop, noble, squire, merchant, artisan, and plowman, High Churchmen, Low Churchmen, Nonconformists, and Quakers, worked together for a common end—liberty, the inalienable right of each and all.

While this was going on in Britain, Europe looked on askance. But it was only that species of half admiration and half fear with which the community regards an individual who is the first to venture to do what no one else would dare. Soon others will follow; it only needs example. So it was in the seventeenth century. Hence the significance and influence of British history of that time. When the crisis was passed, and men once more allowed their petty jealousies and animosities to have sway, they found themselves upon a new footing. They knew their own rights and the rights of the sovereign, and the limits of these. Moreover, they were flushed with victory and full of conscious strength. The effects were rapid. Towns arose, commerce developed, industries increased, wealth multiplied, and comfort spread. Societies, associations, guilds, and councils began to exercise an influence, representing in miniature the theory of the state.

In political government, too, a great end was achieved by more thorough representation.

Under the new conditions, learning and culture began to thrive enormously. Britain took the lead in social progress, and she has ever since retained it.

The eighteenth century is in Britain a record of intellectual and, with it, social progress. The barriers of custom and prerogative were ever falling before the conviction of natural right and equity. On the

Continent progress was much slower. But the crisis could not be long delayed. The dark and smooth surface of society but served to conceal the current underneath.

Still waters run deep.

The close of the eighteenth century marks the end of what is known in history as the ancient régime. It was signalized by the most drastic and, in its immediate effects, the greatest social revolution we have to deal with. It was the bursting of the pent-up storm of misery. It was preceded by a fearful calm. Then the tempest broke out, relentless and irresistible. It spared neither old nor young, father, mother, brother, sister, husband, wife, or child. It cared nothing for associations and sentiments, the work of genius, or the toil of years. As the whirlwind swept across the country—shrieking as if in mockery *liberté* and *égalité*, it left in its track ruin and desolation.

Robespierre, Danton, and Marat, like death angels, guided the storm, yet were powerless to control it.

The Revolution did its work cruelly, but thoroughly. Every vestige of the old was swept away—king, crown, home, and kindred. Men could start afresh on a new system. The tempest of the Revolution in France reached Britain only as a great ground swell. Society there was agitated, but nothing more. Had it been one hundred years earlier, I tremble to think what our country might have been to-day. Kingsley says, "The human race owes more to the eighteenth century than to any century since the Christian era. This may seem," he goes on to say, "to be inconsistent with my description of the very same era as one of decay and death. But, side by side with the death there was manifold fresh birth; side by side with the decay there was active growth; side by side with them, fostered by them, though generally in strong opposition to them, whether conscious or unconscious."

Again, in another place, Kingsley remarks: "We shall find throughout the eighteenth century a stirring of thought, an originality, a resistance to circumstances, which would have been impossible had circumstances been the true lords and shapers of mankind. Had that latter been the case, the downward progress of the ancient régime would have been irremediable."

Yet again, talking of the French Revolution, he says that one of the doctrines then specially proclaimed was that "in each man there is a God-given individuality, an independent soul, which no government or man has a right to crush, or can crush, in the long run."

The eighteenth century drew to a close in storm and darkness. Society was moved to the roots—strained and torn. But when a new century dawned the clouds of revolution were dispelled before the sun of liberty, and all gave token of a glorious noon. And men were not mistaken.

This brings us to our furthest and our highest point. From the height now attained we have an almost boundless view over the ages that have gone before, and we can survey them with the tranquillity of the scientific observer.

The progress of society, the gradual emancipation of the individual, the steady development of mind and resource, and the spread of their influences to all classes of society, had its active rise in the fifteenth century. By the seventeenth century the development had assumed marked forms and signally asserted itself. By the eighteenth century it had grown to proportions against which the old order of things could not possibly hold out, and it inaugurated the nineteenth century with a revolution of society more direct, drastic, and immediate, if not more thorough or momentous, than the Protestant Reformation.

The political history of the present century—which is always the reflex of the internal social workings—is a record of universal awakening. This undoubtedly was hastened by Napoleon's vast attempt to restore despotism. The whole of Europe, upon which the influences we have been tracing had been long working, was roused into action. Napoleon staked the cause of despotism at Waterloo, and lost. Shortly before this Holland had shaken off the foreign yoke; Greece, once more, for a brief space, something like her old self, after Missolonghi and Navarino, regained her independence from the Turks; shortly after, Belgium was declared free; and, later still, we follow the noble efforts for freedom in Italy, under the patriot Garibaldi; and we behold them crowned with success. Surely these events—revolutions in a secondary sense—are deeply significant. They were the natural fruits of the forces at work from the earliest period of human history.

The influences in Britain at this time were no less marked, though they were not characterized by the same violence. That stage had been passed two centuries before. The changes were of a semipolitical character, in which sense I mean that they more immediately concerned the people themselves than their relations with the rest of the world. Social and parliamentary reform formed the basis of the agitations. The immense increase of wealth and spread of knowledge had thrown open the roads to places hitherto jealously guarded. The common bond of individuality and natural freedom had been irrefragable. It was no longer mere birth that ranked before worth. Thus united, society became molded into a solid and clearly defined body.

Intellectual progress in the seventeenth century was great; more so in the eighteenth. But the nineteenth century has surpassed all in the purity and clearness of its intellectual sky and the intensity of its intellectual sun.

This is amply evidenced by the paramount importance attached to education and the universal desire for the same; the enormous increase and perfection of industries; the growth of vast cities; the extent of international relations, political and social; the spread of and height

attained in all the fields of higher intellectual investigation in science, art, and literature; in the current thought of the day; in all these questions now vexing and wearing us—social, religious, and economic.

I have purposely refrained from doing more than mentioning the most outstanding points in our subject of investigation. In no place have I gone into particulars. Our field is so vast that our view can only be general. I might have treated the subject from a purely sociological point of view. But that might have been too technical and uninteresting; and besides, when we think of it, sociology is merely a generalization of the evidences of history. We have sketched, or at least indicated, the growth and influence of customs, manners, religion, laws, industry, commerce, science, literature, and art, and their respective points of beginning and ending. We have seen the human atom develop into the human unit, the single-celled social protoplasm grow into the complex and multiform organization of present society. In tracing the evolution of society we have traced the evolution of the individual; we have traced the evolution of mind. One fact must have been patent to us all along, and that is the measure in which the individual acts upon society and in which society reacts upon the individual. I know that I am throwing myself open to opposition when I say that the whole history of the human race is a record of constant, though varying, advance. The world is working toward an end of self-realization; to this all is tending. Every revolution, every reformation, every change is a necessary step to this end. It is our destiny that impels us.

The world to-day has reached a position never hitherto attained. Our standards and conceptions of morality are higher and truer and our methods surer. Sin and vice still exist; some say as heinous as ever. That is not so. Not only is there less sin and vice, but what there is is only equally heinous with that of past ages in that our higher standards and sensibilities are the more easily shocked. Our means of restraining vice and crime, of alleviating misery, and of securing happiness are more universal and efficient.

All this is the outcome of our truer conception of man's place in nature and position *inter se*.

If anyone doubts the truth of our conceptions and the actuality of things, he has only to look around upon the world of yesterday and of to-day to see the waste moorland converted into rich fields or thriving cities; to watch the busy throng of workers, all eager with what they may imagine to be their own concerns, but nevertheless each in his sphere, however humble, contributing his quota to the general fund. Selfish, some will say! True, there is much self-seeking, much selfishness, but we must form our conclusions from the feelings and acts of the combined community, not from those of the individual. The individual contributes to them, but the combination is a modification.

We have seen the human thing become a human being. We have witnessed the triumphs of mind over matter and circumstances. We

may fitly close by quoting those spirit-stirring and appropriate lines of Campbell:

Eternal Nature, when thy giant hand
 The wave upheaved and fixed the trembling land,
 When life sprang startling at thy plastic call,
 Endless her forms, and man the lord of all—
 Say, was that noble form, inspired by thee,
 To wear eternal chains and bow the knee?

Was man ordained the slave of man to toil,
 Yoked to the brutes, and fettered to the soil,
 Weighed in the balance with a tyrant's gold?
 No, Nature has cast us in a heavenly mould.
 She bids no wretch his thankless labour urge,
 And, trembling, take the pittance and the scourge.

* * * * *

Tyrants, in vain ye trace the wizard ring,
 Ye can not limit Mind's unwearied spring.



MIGRATION AND THE FOOD QUEST: A STUDY IN THE PEOPLING OF AMERICA.¹

By OTIS TUFTON MASON.

THE STRUGGLE FOR EXISTENCE.

In the struggle for existence our species has waged a double contest, the one against decay, disintegration within the human body or the society; the other against destructive forces from without.

The chief contest for the inner man has been to appease the insatiable cravings of hunger and thirst.

The chief contest for the outer man has been to resist the blistering rays of the sun, the biting frost, the pelting storm, savage beasts, and still more savage men. For this latter contest man created clothing for the body, the home for the family, the camp for the clan, the fortress and armor and weapons against the beasts and the enemy.

The elements of activity in this double contest were:²

1. The exploitation of the earth for materials and resources.
2. The transformations of materials and the subjugation of force.
3. Transportation and conveyance, the carrying industry.
4. Barter, commerce, and exchange, the pursuit of wealth.
5. The arts of consumption and enjoyment.

The activities just mentioned divide themselves into two sorts with relation to place—the stationary industries and the migratory activities. We shall attend now only to the latter.

MIGRATION AND ITS MOTIVES.

By migration is meant intentionally or unintentionally leaving a spot and not returning to it. This term is frequently confounded with those movements throughout the year which have been called "the circle of activities," the ground covered being the sphere of influence or total culture area. This sort of orbital or annual movement has had much to do with those permanent migrations of which we are now speaking.

¹ A paper read before the Anthropological Society of Washington, May, 1894.

² See the author's *Origins of Invention*, Lond., 1895, Scott.

The law of the circle of employments and of permanent migration may be called the maxima and minima of effort—that is, men have always bestirred themselves the year round and moved about the world on lines and to places where there seemed to be promise of the greatest comfort and security for the least effort on their part.

In this paper especial attention will be paid to this maxima and minima in relation to the food quest, though it will be seen that following this line conducts also to the best results in the other activities mentioned and to the supply of other needs.

Migration is caused not by one motive, but by all possible motives. Collect all the influences and wants that have actuated individuals in going about. These same, acting on a family, a set of men, a horde, a clan, a people, have caused migration. They have acted by compulsion and by attraction, from within and from without, through nature and through man.

Taking these motives for change of habitation all in all, they may be sharply divided into two classes, the attractive and the repulsive forces. Some migrants are drawn, allured, enticed to move. They go because they want to; nobody compels them. They have in themselves the energy, the ambition, the vigor, the desire to go, and these are the peoples that have dominated the earth.

Other migrants are crowded, driven, compelled to move. They are afraid or too weak to stay where they are. Such people are cowardly or unfortunate, retrogressive, dying out. They shrink into the suburbs of the world.

Uniting these concepts of attraction and repulsion with the notion of subjective and objective causes of struggle, we have a quadruple set of migratory forces working together or apart:

A. Subjective motives, *vis ab infra*.

1. Desire, hope, appetite, ambition, energy.
2. Weakness, fear, aversion, cowardice.

B. Objective motives, *vis ab extra*.

3. Advantages, supplies, comforts, satisfactions, acting a fronte or a tergo.
4. Discomforts, compulsions, failure of resources, a fronte or a tergo.

Accidents, superstition, calamities play their part with substantial causes in this composite set of motives.

According to the laws of mechanics, bodies move in the lines of least resistance, with momentum proportioned to the *vis a tergo*. They have no souls, no desires; they do not move, but are moved.

With animals and men the case is different. They move in a parallelogram of forces.

1. In the lines of least resistance in front.
2. In the lines of greatest pressure behind.
3. In the lines of greatest desire within.

4. In the lines of greatest pull, or attraction, or supply from without.

5. In the lines of greatest effort or volition subjectively viewed.

After all, it is the cheerful, hopeful migration, stimulated by desire and encouraged by propitious surroundings, allurements, and forces, that effects new cultures. Doubtless shipwrecked mariners, lost wanderers, and outcasts have now and then left a happy thought or suggestion upon receptive aboriginal minds; but these random surf beats are not what Tennyson calls—

The great waves that echo round the world:

FOOD AREAS AND FOOD SUPPLY.

The greater part of the earth's surface was sterile and repellent as abiding place to primitive man or to the living forms upon which he depended, to wit:

The deep sea, out of sight of coastal plains and meadows.

The arid deserts, barren to man and plant and beast.

The mountain tops, then as now, inaccessible and unproductive.

The frigid zones, above the lines of food and furs.

The great plains and prairies, away from waterways.

The dense forests, jungles, tundras, and swamps.

But all of these were provocative of migration and long journeys.

Both man and his purveyors had to walk at first in those terrestrial paths which had been marked out by Nature and provisioned for his journeys. By following the trails of supply he got into the green pastures and encamped by the still waters that invigorated him. It so happened that the trade winds and gulf streams were conterminous with the marine feeding grounds; that the inland rivers, bays, and lakes on which he could journey with greatest facility were the catchment basins of surrounding fertile lands and the feeding ground of innumerable creatures yielding food to him in largest abundance.

The rich meadows and valleys were the debris of degradation. Their loam was once on the inaccessible tops of mountains and was only halting a little way on its journey to the great littoral feeding grounds. It was on this stream of dry land between mountain and shore that great herds of ruminants were developed, and to them early men were attracted for the easiest and most abundant means of support.

The greatest natural food supply for the least effort, with few exceptions, was in the water. This saying is true for all the five elements of activity of which I have spoken previously, to wit:

1. *Exploitation.*—The easiest food to take for human aliment is in the waters. It frequently comes to man's hand spontaneously.

2. *Transformations.*—The early manufactures, arts, industries, and divisions of labor over the products of the sea are more varied than those of hunting or gleaning.

3. *Transportation.*—By far the easiest primitive conveyance of man and transportation for the products of his activities were by water, and even now water transport is the cheapest.

4. *Barter*.—The oldest form of money, the world over, is shells from the water. For the most part primitive folk do not go far away from the water and the greatest cities are most accessible thereto.

5. *Consumption*.—The preparation and serving of sea food, in variety, in persistence throughout the year, in relation to cooking, drying, salting, and smoking, answer the demands of human desire as well as either of the others mentioned. And much of it is eaten raw.

FOOD AND MIGRATIONS IN AMERICA.

In the *North American Review* of October, 1869, and January, 1870, the Hon. Lewis H. Morgan wrote upon Indian migrations over the continent of America as influenced by existing physical conditions, principally food supply.¹ Because the region about the mouth of the Columbia River was possessed of the most abundant materials of this character, Mr. Morgan made that the starting point of migration over the continent and worked out a scheme for the movements of the principal stocks of aborigines.

I propose to take up the investigation of the distinguished ethnologist by the aid of such new light as the studies of twenty-five years have acquired. At present we may leave the question of the spread of stocks in America to the eminent gentlemen of the Bureau of Ethnology and to other scholars who are on the list of honorary members of our Anthropological Society, and inquire whether there be a practicable route from Indo-Malaysia to the Columbia River or to any other point near by on the North Pacific Coast.²

THE ROADS TO AMERICA.

There are two possible routes from Asia to America, one of which has been often discussed; the other is, so far as I am aware, to be now for the first time proposed.

The first mentioned is the Arctic or hyperborean route, across that culture region, or *oikoumenē*, which I have elsewhere denominated the interhemispheric area. It is the land of dogs and reindeer, of snow and snowshoes, of fur clothing, marine and Arctic mammal food, underground dwellings, birch trees, and the arts springing therefrom, skin and bark boats, harpoons, sleds, all the way uninterruptedly from East Greenland to the Land of the Midnight Sun, in Norway. This might be called the land or the snow-and-ice route.

The route which I now propose might have been nearly all the way by sea. It could have been a continuously used route for centuries. Until interrupted by later civilizations, it might have been traveled over for thousands of years. It lies absolutely along a great circle of

¹Cf. Merriam's *Dept. of Agriculture Bulletins*, his address in the *Nat. Geog. Mag.*, VI, and Allen's *Geographical Distribution of Mammals*, *Bul. Am. Mus. Nat.*, IV, 199-244, with Powell's linguistic map, in regard to the coexistence of certain families of animals and plants with families of aborigines.

²Cf. J. W. Powell, linguistic map, VII, *Ann. Rep. Bur., Ethnol.*; and D. G. Brinton, *The American Race*, N. Y., 1891, Hodges.

the earth, the shortest and easiest highway upon the globe. I omit here the supposed route from Europe to Greenland, simply because it demands certain geological changes, all of which the writer is now trying to avoid; also those lines straight across the parallels from Polynesia, because the food supply was inadequate and the motives not apparent. Migrations of this sort are not denied or affirmed; they are simply laid aside for the present.

A HYPOTHETICAL CASE.

The Haida Indians of British Columbia annually voyage as many as 500 miles southward to Puget Sound to lay in a supply of dried clams and oysters for their own consumption and for trade.

Let us imagine a company of them or of their ancestors, no matter how many centuries ago, setting out from the Indian Ocean in an open boat no better than the one they now employ, and governed by the same commonplace motives. The peoples that our Haida would have to encounter now, or, better, those among whom the investigator would have mingled four hundred years ago, would have been—

1. Malay-Polynesians, who would have transported him to the confines of Japan.

2. The Japanese, and many hundreds of years ago the primitive Koreo-Japanese or their ancestors, or the primitive peoples of the islands and peninsula. Their plate armor and hexagonal weaving he would encounter as far as numbers 8 to 10 on the map.

3. Riding astride of reindeer, drawn by dogs or reindeer, in bark canoes and dugouts, and at times in canoes lashed together or walking on snowshoes, the traveler might have gotten as far as Norton Sound.

4. The Eskimo would have been his companions from Plover Bay in Asia to Cook Inlet, or to East Greenland, and their dress, often in Asiatic reindeer skin, as well as the identity of their industrial apparatus, would have prevented any shock in passing to the other side of the world.

5. As soon as Mount St. Elias was reached and the area of the great cedars was encountered, the traveler would again enter a dugout canoe, whose lines and means of locomotion would not be strange to him. He would see men clad in plate armor, wearing grèaves on their legs as they did in Japan. All sorts of fishing apparatus and traps, and even the tales they told him, would appear familiar.

6. On the Columbia, the salmon-eating peoples would seem old time friends. The canoe, pointed at both ends under water, would remind him of the Amoor, and hereabout he would meet the northern division of the Uto-Aztecan stock, in whose company he might travel as far south as the borders of Chiriqui.¹

7. With the Maya, the mixed tribes of the isthmus, the Chibcha, and the Aymara-Kechua tribes he would complete his journey, passing through the lands of potters and stonecutters.

¹D. G. Brinton, *The American Race*, N. Y., 1891, p. 118.

In order to make the problem of their voyaging as simple as possible, let us not at present imagine any submergence of the ocean bed nor any geological nor physiographical changes, nor any accidents out of the daily human experience. We may be allowed to restore to the waters and to the land such creatures as we know to have been destroyed out of them in recent centuries by the exigencies of enormously multiplied populations and the demands of modern commerce, but no more. It will make our inquiry much simpler and more scientific if we have no experiences introduced or imagined that any man may not repeat at his leisure as in a laboratory.

The separate marine inclosures or areas in the progress of a migration from the Indian Ocean to the Columbia River and southward about a great circle of the earth are roughly—

1. The Indian Ocean, especially that part of its drainage toward the east.
2. The Indo-Malayan archipelago.
3. The South China Sea and parts adjacent.
4. The East China and the Yellow Sea.
5. The Japanese and the Tartary Sea.
6. The Okhotsk Sea and its environs.
7. The Bering Sea and its drainages.
8. The Alaskan sea and British Columbia islands and coast lands.
9. Vancouver island and the Columbia basin and the head waters of the Mississippi drainage on the west.
10. The great interior basin of the United States.
11. The Pueblo region.
12. Mexico.
13. Central America.
14. Colombia and Ecuador.
15. Peru, its coast, mountains, lake region, and the head waters of the Amazon.
16. The basin of the La Plata.

This general line is a great circle of the earth. On a Mercator map the straight lines are commonly taken for shortest distances, which they are not. Again, it so happens that the great circle here mentioned is the principal earthquake and volcanic line and the natural boundary of the Pacific Ocean.

NECESSARY CONDITIONS.

The conditions into which the candid student would be bound to inquire concerning such a route would be the following:

1. *Food supply.*—Could our imaginary Haida crew of men and women travel, say, from the Andaman and Nicobar islands to the Columbia River, a distance of 10,000 miles, and live on the natural resources all the way? Are the situations and movements of this food supply such as to toll or invite wandering people steadily and continuously onward?
2. *Conveyance.*—Were the aboriginal means of conveyance in vogue in the Malay Polynesian area adequate to such a journey? Could the

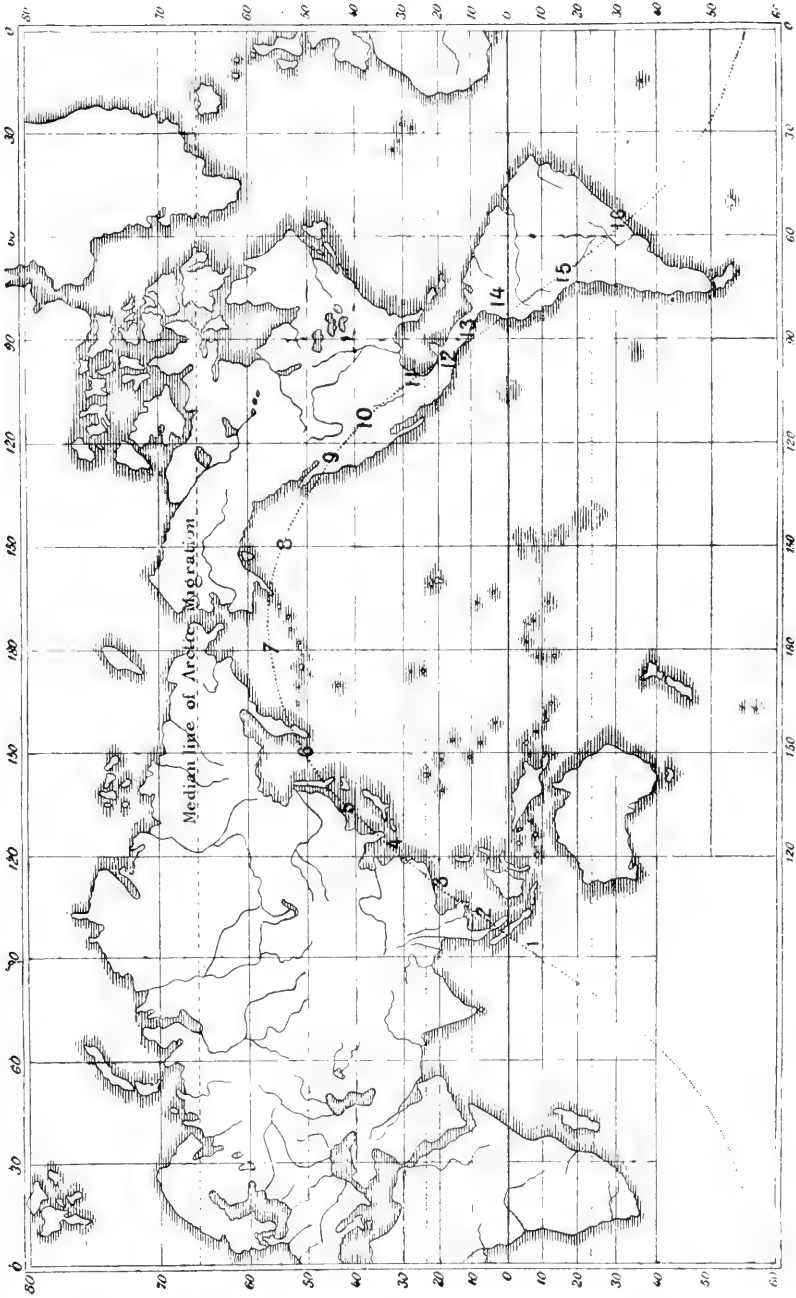

MAP OF THE WORLD, SHOWING THE GREAT CIRCLE OF FOOD SUPPLY AND LINE OF ARCTIC MIGRATION.

modern Haida great canoe, the East Indian or the Malay-Polynesian craft stand such a trip? Are there landlocked seas all the way, such as East Indians, Malays, and Haidas paddle in at home, at the present moment? Had either people, before contact with whites, the appliances and the skill for such an excursion?

3. *Currents and highways*.—In which direction do the ocean currents move along the route indicated—toward America or from America?

4. *Winds and temperature*.—What winds blow along the Asiatic coast, about Bering Sea, and the archipelagos of the northwest American coast? What is the effect on the atmosphere of the winds which blow from these currents and from the Tropics in respect of climate in the countries along the route? Would these winds gradually move peoples toward or away from America? If a boat without a crew were set adrift in the South China Sea, to what point would it drift? What series of isotherms are included in this area?

5. *Suggestions and barriers*.—Are there any insurmountable barriers to our Haida Indians or Malays—that is, what would be the most difficult places for them to pass by reason of distance from land to land, exposure to open sea or adverse winds, failure of provisions, or greater allurements in other directions?

6. *Blood*.—Admitting that the aborigines of America are from the Eastern Continent, what peoples of the Old World are most like those of the New, anatomically and anthropometrically, by which is meant in skeleton, in muscular development, height, weight, physiognomy, color of the hair, eyes, skin, etc.?

7. *Social structure*.—The aborigines of the Western Continent had a social structure built up on the gentile system, practicing endogamy as regards the tribe and exogamy as regards the clan. Now, should our Haida Indians find any peoples about the Indian Ocean or elsewhere along the route who had the very same or nearly the same social structure?

8. *Language*.—What testimony does language bear to the kinship of American aborigines with Eastern peoples? To what languages in the Eastern Continent are the American tongues nearest akin? Does the present condition of the language problem close the door of inquiry concerning migration from Asia to America?

9. *Arts*.—In the arts of practical life and the arts of pleasure, what similarities should our company of Haida Indians find? It is freely admitted and indisputable that similarities arise in these respects by stress of the earth and stress of a common brotherhood of man; but such similarities are more or less functional or general or coördinated. The more that things or customs agree in minute structure, the more specifically are they akin and have had the selfsame originators. In other words, the greater the similarity, the less the probability of diverse origins. Are there any arts so akin structurally as to make the theory of independent origin improbable?

10. *Remains and historic evidence.*—What relics of primitive occupation should our voyagers encounter that would remind them of home, and what testimony have we of such aboriginal peoples? Or, to put the question in another form, if one of our distinguished archaeologists, Morse or Putnam or Holmes, or an historian, such as Brinton, made the journey with the Haidas, would he come across any shell heaps, abandoned dwelling sites or work places, or ancient documents entirely inexplicable by the present inhabitants, but quite plain to one skilled in the antiquities of our own continent?

11. *Religion and folklore.*—What is the testimony of comparative mythology concerning the inhabitants of the spirit world and their conduct as believed in throughout the several neritic areas mentioned? In the cult of these regions what similarities exist in sacred places—houses, images, and worships? What folk customs seem to be akin?

12. *Modern witnesses.*—Not only trained ethnologists, but naval officers, navigators, travelers, and missionaries are constantly testifying and declaring their convictions of the commerce and blood relationship between the two sides of the Pacific. Any one of these witnesses might be entirely inadequate; but what weight is to be given to the cumulative testimony?

In brief, the conditions demanded for aboriginal communication are the following:

1. Abundant supply of food and clothing all the way.
2. Easy means of transportation and conveyance.
3. Impelling oceanic currents and highways.
4. Favoring winds and temperature.
5. Encouragements rather than discouragements, invitations and not barriers.
6. Resemblances of ethnic kinships.
7. Similarities in social structures and functions depending on kinship.
8. Homologous types in language.
9. Similarities in arts otherwise inexplicable.
10. The favorable witness of archaeology and history.
11. The same traditions, folklore, mythology, and cults.
12. The confirmatory testimony of ethnographers, travelers, observers, etc.

Let us examine them in order.

A DEFINITE PROPOSITION.

In order to test the foregoing questions the following concrete hypothesis is advanced for examination:

That during the centuries in which Europe was working out of her earliest stone age into her renaissance, certainly for three thousand years or more, America was being steadily and continuously peopled from Asia by way of its eastern shores and seas from the Indian Ocean. Sub-

sidary movements in the way of offshoots from this migration, contributions to it, and barriers to its progress were effected up and down the rivers and in the seas of India, China, Mongolia, and Siberia. That such a movement was practicable, consider the following arguments:

I.—ABUNDANCE OF FOOD.

In each of the areas mentioned there are a great number of species of food plants and animals; the individuals of many species are of great size, and of all the species there is prodigal quantity.

In the Indian Ocean and South China seas the animals are tropical and the natives are expert in their capture.

In East China Sea and Japan Sea are inexhaustible supplies of shad, herring, mackerel, cod, and local species. Besides these, food plants, water fowl, and marine invertebrates still abound for every need of the people.

Before the Russians began their operations in northeastern Asia the peninsula of Kamchatka supported 60,000 inhabitants; but under their rule the using up of the food supply and the introduction of fatal diseases decimated that number. At the present time the sea of Okhotsk would yield salmon and other aquatic food in abundance for any aboriginal needs; and prior to one hundred and fifty years ago the Rhytina afforded the absolute maximum of aliment for the least effort. There was also no limit to subsistence in Bering Sea. Furthermore, no sooner do we approach the latitude where the rigors of the climate demand extra clothing and fuel for the body than we find marine mammals and land mammals superabounding. Whale, seal, walrus, and sea lion in the water, and elk and reindeer and bears on land, are even more serviceable than the fish, for they are house and furnace and clothing and food all in one. In no region of the world do food-fishes and land and sea mammals exist so abundantly and so accessibly.¹

II.—THE NAVAL POSSIBILITIES.

To investigate the second topic, namely, the possibilities of such a voyage or journey with the appliances at hand, it will be necessary to inquire as to—

1. Its length and directness.
 2. The quality of the ships and other modes of conveyance.
 3. The ability of the mariners and native travelers.
 4. The depth of water and the character of land routes.
 5. Whether the environment is such as savages are accustomed to.
1. *Length and directness.*—All modern steamships travel on the great

¹Cf. U. S. Nat. Museum bulletins of London Fisheries Commission; Reports, etc., U. S. Fish Commission; Report Japanese Commission, World's Columbian Exposition. The writer acknowledges his obligations to Dr. G. Brown Goode and Dr. Tarleton H. Bean for information on these points.

circles of the earth as the shortest distance between two points. The Canadian Pacific steamers skirt the Aleutian chain on the way to Victoria from Yokohama. A great circle of the earth between the Straits of Malacca and the Columbia's mouth passes through every one of the shallow food-stocked areas named, and, continuing onward, is in touch with the buffalo feeding grounds at the sources of the great rivers, with the pueblo region, Mexico and Central America, and the highlands of Peru and Ecuador. The Aztecs, Mayas, Chibchas, and Kechuas were the antipodes of the ancient inhabitants of the Malay Archipelago.

2. *Modes of conveyance.*—As for the ships, it will be admitted that the aborigines of this continent were possessed of every form of boat known in the Eastern Continent except the outrigger canoe—kaiak, umiak, pirogue, bark canoe, coracle, skin float, raft, and reed float. They were singularly poor in appliances for land travel south of the dog and snow line; indeed, they kept to the waters closely. By a system of portages they had connected the Arctic Ocean and the Columbia's mouth with the Atlantic and the Gulf of Mexico. On our great circle, in areas 14 and 15 on the map, the American camel assumes the rôle of burden bearer.

Upon the Asiatic side the aborigines have been greatly disturbed by Russians, Japanese, and Chinese; but in the Malay Peninsula are craft as varied and as effectual, and the lines of the vessels are strikingly like to those of our western coast; and the natives now journey from Bering Straits southward to Japan by dogs and on snowshoes.

3. *Mariners and native travelers.*—When Europeans visited the Indian Ocean and the Pacific these waters were covered with hardy navigators. I am even tempted to suggest that the turning aside of a stream of pre-Malays, who were the Phœnicians of the Orient, by the Mongoloid intrusion from inland may have led to the peopling of the archipelagoes of the Pacific after America was fairly settled and a northward migration was interrupted.

4. *Water and land routes.*—All the way from the Straits Settlements to Vancouver, as will be seen by the *Challenger* map and the British Admiralty charts, we have shallow water. There is a broad bench constituting the marine feeding ground, where the series of outlying islands and archipelagoes fence in the neritic areas. The conditions are perfect. And inland, where navigation is the least perilous, food becomes the more abundant.

5. *Nature of environment.*—Each one of these environments is within the capabilities of savages. The landmarks were their light-houses; the inlets were their harbors innumerable; the grass and the color of the water were their barometers; the mammals, fishes, and birds were their pilots. They were scarcely subjected to the terrors and dangers of the fathomless sea.¹

¹ For the land journey from Japan to Bering Strait consult Reindeer, Dogs, and Snowshoes, by Richard J. Bush, N. Y., 1871.

III.—OCEAN CURRENTS AND FOOD SUPPLY.¹

In following this line of enormous food supply our voyagers would be materially aided by the ocean currents. The equatorial stream of the Pacific flows westward between the Tropic of Cancer and the Micronesian archipelagoes. On reaching the South China Sea it is split, a part going southward and westward into the Indian Ocean and a part northward and eastward, like our Gulf Stream, skirting the outer rim of the seas that I have mentioned all the way to the Columbia River. Within these seas counter currents and eddies help to equalize the temperature of the adjacent lands. The effect of this Kuroshiwō, as the ocean current is called, is much greater upon the food supply than upon the people. Bringing millions of tons of tropical silt and low sea forms in its stream, this Nile of the Pacific deposited them over the bed of the landlocked areas, acting like a top-dressing upon soil and a feeder of the aquatic food fauna. The lowering of temperature northward naturally would give the migrants an increased advantage in life's struggles as the climate became more stimulating, fecundating, and strengthening.

IV.—PREVAILING WINDS AND FOOD.

As for the prevailing winds, the trades blow westward in the Tropics. On reaching the Pacific shore they would follow some such law as that of the waters, but during the months of May to October the simoom from the Indian Ocean pushes northeastward and drives the trades along Asia northeastward. As we proceed the ocean current is spread out, and the winds blowing from warmer latitudes exert their benign influences on the coast of southeastern Alaska, British Columbia, and the State of Washington. The temperature of the whole route is equalized.²

¹ Cf. Die unfreiwillige Wanderungen im grossen Ozean. O. Sillig, Petermann's Mitteil., vol. 36, Nos. 7 and 8.

² 1. The annual isotherm -20° to -10° C. I shall call the Arctic area. It includes (1) Arctic America, sweeping below the circle at Hudson Bay; (2) Greenland above 75° north; (3) Arctic Asia, and pushing down to Jakutsk, in Siberia.

2. The annual isotherm -10° to 0° C., including Alaska south of the strait, northern Canada, southern Greenland, Lapland, northern Russia, the northern Altaian piedmont, Okhotsk Sea, Kamchatka. It is the interhemispheric ethnic area.

3. The annual isotherm, 0° to $+10^{\circ}$ C., including southeast Alaska, British Columbia, southern Canada to New York, southern tip of Greenland, middle or blonde Europe, Mongoloid Asia, northern Japan, southern Saghalien, southern Kamchatka.

4. 10° to 20° C., United States, temperature rising west to Rockies by long curve and then southward by precipitous curve; Mediterranean or Melanchroic Europe, central Asia, China, and Japan.

5. 20° to 30° C., the tropical world, interior basin of the United States, northern Africa, Mesopotamia, Afghanistan, India, Farther India.

The summer temperature of the Yukon region is that of Saghalien, Korea, Japan, and China.

The isobar of Hongkong passes along Japanese Isles, around the shore of Okhotsk Sea, across Bering Strait, and crosses America just north of Vancouver.

V.—ENCOURAGEMENTS AND DISCOURAGEMENTS.

Morgan says that barbarians, ignorant of agriculture and depending upon fish and game for subsistence, spread over large areas with great rapidity. Under the operations of purely physical causes they would reach in their migrations the remotest boundaries of a continent in a much shorter time than a civilized people, with all the appliances of civilization.¹

The same is true of the seas so long as they are unimpeded. Even after the first occupancy new peoples constantly wedge themselves in, as they have done in Columbia, Washington, Oregon, and California.

Two things would modify the track of migration which we are discussing, to wit:

1. The intrusion into the neritic areas along the Asiatic side of peoples that were sedentary and who assumed ownership of them, turning the highways into possessions and blocking further progress of migration. This intrusion ended at the North with Russia and the United States, 1728-1894. The white race in 1498 first set its greedy eyes upon the east, and Magellan died on the Philippines in 1521.

2. The intrusion of foreign elements into the stream of northeast movement. To continue the figure of the Haida voyagers, supposing they had replaced, as they went from sea to sea, any who died, whether men or women, with recruits from the shore. In a long voyage the complexion of the crew on arriving at Victoria would be greatly modified; also they may have left at the mouths of the Canton, Yangtze, Yellow, and Amoor rivers one or more pairs of their passengers. All of these things would have been perfectly natural to do.

But supposing that instead of a single canoe load of fifty Indians there were a stream of canoe loads flowing for thousands of years, when the eastern part of Asia was like the west coast of America fifty years ago; then colonies would be dropped in every favorable place and the peopling of eastern Asia would go on from the sea up the rivers and not from the land down the rivers. These peoplings may be described as waves, and we might speak of—

1. The American wave leaving the Japanese shell heaps.
2. Eskimo, Aleut, Jenessai, Ostyak wave.
3. Hyperborean Asiatic wave, peopling Siberia.
4. Aino wave, quite as likely to have followed our route as any other.
5. Mongoloid waves from inland seaward, ending in permanent industrial settlements and the cessation of migrating.

Imagine eastern Asia at the beginning of our era, or a thousand years before that, the abode of teeming populations of aborigines, living, moving, trading along these landlocked highways abundantly provided with food. They were fishers and hunters. Contemporaneously, in the

¹ Morgan in Beach's Indian Miscellany, Albany, p. 159.

Nile Valley, in Syria and Mesopotamia, in China and India, cereal, pastoral, and mechanical industries have been developing. Many of the peoples practicing them push to the east; they divide the coast. The aborigines disappear; they leave their shell heaps and move northward, then eastward and westward, following the winds and currents, and take the shortest and most inviting path onward.

There came to the eastern side of America three hundred years ago the nations of Europe. They crossed the continent and circumnavigated it. They severed our aboriginal Pacific Coast culture in many places:

1. The Russians in Bering Sea nearly severed the native commerce of the two hemispheres.

2. The Hudson Bay Company enlisted the movements of the Indians in their behalf and destroyed the aboriginal migrations and commerce.

3. The American fur traders projected their operations between the stocks of Oregon and California.

4. These were followed by explorers, settlers, and miners in our century.

5. The transcontinental railroads and the creation of independent states obliterated all vestiges of former aboriginal movements.

VI.—THE RACE PROBLEM.

The opinion of such scholars as Morgan and Brinton as to the uniqueness and homogeneity of an American breed or race is not gainsaid, but surely the last word has not been said upon this theme. It can not be denied, however, that this race is a mixed one fundamentally, and that there enter into it varied anthropometric characters. This is not only true of the living tribes, but of the bones from the graves. It has even been averred that Polynesians may have crossed from the Pacific archipelagoes, moved northward and mixed with long-headed northerners, forming a mesocephalic type.

Now, I would beg leave to suggest a different solution for these mysteries: Following the most abundant food supply along the seas in which primitive men were best equipped to obtain it, following currents of earth forces that would furnish incitement and even motive power, the ancestors of Malays, Polynesians, and Indians could have come from the equator to America, traversing for nearly the entire distance a series of landlocked seas of shallow water, abounding in food supply of fish and birds and marine invertebrates, and part of the way with innumerable vertebrates, as we have seen.

As to cranial index, the Eskimo are among the longest-headed peoples of the world, ranking with Abyssinians, Caroline Islanders, Hotentots, and some Polynesians. Most Americans are mesocephalic, as are the Malay-Polynesians, but the northern Mongoloids are the shortest-headed people in the world. In nasal index Topinard places

the redskins next to the yellow races of Asia, and in his general scheme the redskins follow the Polynesians.¹

VII.—THE PROBLEMS OF SOCIOLOGY.

All the tribes in America except the Eskimo were found living under a peculiar system of relationship. Each tribe was endogamous, but it was split into gentes that were exogamous. Connected with this was a system of classific relationship, descent in the female line, and other social and political regulations that were new to the explorers. Morgan found that each great ethnic group had its own marital and political system, and these he has classified in his monumental work. He says: "The system of the Seneca-Iroquois Indians of New York is identical, not only in radical characteristics, but also in the greater portion of its minute details, with that of the Tamil people of south India." It is not to be supposed that the Tamil and the Iroquois are for that reason brothers. But they are in possession of a common social expression that came to them both from a common source.

VIII.—AMERICAN AND ASIATIC LANGUAGES.

Linguistically speaking, the Bering Strait is not the dividing line of two continents, since the Eskimo extend also into Asia, having, according to some, gone over from America. Contiguous to the Eskimo in America are the Athapascan family on the west and the Algonquin family on the east. Contiguous to the Eskimo in Asia are the Chukchis, and these are joined to other unclassified peoples. Now, the Chukchi language and the Athapascan language and the other Asiatic and American languages are noted for their lexical and grammatical differences and not for relationships.

But there were one hundred and twenty separate families of languages in America. The peculiar family system of the American aborigines, restricting marriage in the tribe, was more conducive to the rapid multiplication of languages than any other that could be devised. In that dispersive, centrifugal period of human history which preceded the invention of a written language changes must have gone on rapidly. Furthermore, philologists have not had the material upon which to work in forming a solid theory of linguistic relationships, and the latest researches do not justify the assertion that the American languages stand alone in morphology.

While it is true that identity of language is a good proof of the kinship of peoples, in the present state of knowledge the lack of proof of identity is no disproof of relationship or acquaintance in times remote, or proof of nonrelationship by consanguinity or contact.

¹For a résumé of modern schemes of mankind, see the author's "Accounts of Progress," in Smithsonian Annual Reports, 1885 to 1893. The writer does not now discuss the pristine home of the human species.

IX.—SIMILARITIES IN ARTS.

To attempt in a short address to elucidate the whole subject of similarities in arts along the two shores would consume too much time.¹ The speaker will sufficiently orient himself in the minds of his readers by saying that there was scarcely an original fundamental idea developed upon the Western Hemisphere. Every one of the industrial and æsthetic arts here can be matched by one from Asia or Oceanica. The differences are varietal, regional, tribal, special, natural. Many American arts also tally with those of prehistoric Europe, but these also came from that common ancestral source that supplied both Europe and Asia and America.

There is nothing unnatural or improbable in the supposition that the original migrants to a country should lay aside an art on the way and pick it up again in succeeding generations. Tribal memories do not die because demands cease or resources temporarily fail. This does not controvert Tylor's proposition, that a people that has acquired an art never loses it. I am now speaking of a stream of migration starting out from the equator and passing northward out of one culture area of mineral, vegetal, and animal supply, and of aerial, marine, and terrestrial conditions, and moving northward into and through a series of different supplies and conditions as far as there is a motive, and then repeating the process southward on another continent. This would require centuries. In one region a peculiar exigency evokes the art of working in hard stone; in a series of regions beyond, the absence of material, or of the proper tools, or of a demand for the product, interrupts or converts this art into something else. By and by the descendants of this people come upon new quarries, demands, and appliances. The art or folklore breaks forth again in such striking similarity to the old as to raise the inquiry among ethnologists whether some unfortunate castaway may not have been thrust ashore here and taught all the people a foreign art. This is highly improbable. The naturalists have no difficulty of accounting for such occurrences in nature, and they call them atavism. Technical atavism, or the revival of an industry that has lived in tradition,² then may and does account for the recurrence of some ancient Asiatic arts in America and of the same art in America in regions wide apart.

X.—THE WITNESS OF ARCHÆOLOGY.

Archæology has begun to bear testimony upon these possible migrations. Morse discovered shell heaps in Japan, and his researches were followed up by Kanda upon the stone implements. The ancient

¹ The author is preparing for publication an illustrated paper on the arts of the two sides of the Pacific, in which the matter will be minutely discussed.

² This is excellently illustrated by Rae, in *Jour. Anthropol. Inst.*, Lond., 1878, Vol. VII, pp. 130, 131, with reference to the Eskimo house.

Japanese stone implements are identical with the American in technique and strikingly similar in shape. Even the æsthetic forms are wrought in precisely the same manner. It is well known that several waves of aboriginal occupation preceded the present Mongol dynasty in China, and students are waiting with interest to know more about them and the paths by which they entered the celestial domain.

XI.—RELIGION AND FOLKLORE.

I think that all American myths point to northern origin. They are filled with stories of the sea; but there is little ground now, in the infancy of the science of folklore and mythology, upon which to build theories.

I mention in passing the Easter Island images, the New Zealand and other Polynesian wood carvings, and the general suggestion of the Northwest totem devices in the Japanese areas.¹

Father Morice says that the western Déné about Stuart Lake, in British Columbia, have a tradition that "days were formerly so very short that sewing the edge of a muskrat skin was all that one woman could do between sunrise and sunset."² Boas says that the Kwakiutl on the Pacific coast of British Columbia tell of a place where the sun does not shine, where there are no trees, and where people ride in boats made of skins. These people tell of a place where the trees are all hollow in the middle so that they carry water in the trunks. As a matter of fact, though it may not count for much, the same tribe make gashes in a plank and convert it into a box with invisible joints precisely as the Chinese work in bamboo.

On the other hand, no northern tribe has the slightest conception that they have relatives in the south.

Boas, who has studied the west coast myths more than anyone else, points to their Asiatic origin.

XII.—THE TESTIMONY OF ETHNOGRAPHERS AND OTHERS.

Finally, and I do not think that such cumulative evidence is to be despised, all intelligent travelers are struck with the similarities existing between our west coast Indians and existing eastern Asiatics. It is true that those who have noted these resemblances have resorted to untenable theories to account for them, but false theory and good empiric data are not incompatible. It is well known that our Eskimo have peopled a portion of northeastern Asia, following the dominating instinct for aliment and comfort. The proposition I wish to defend is that this close connection between the two continents has existed for thousands of years, during which the contact between western America and eastern Asia was more and more close and extended and

¹ Cf. J. G. Frazer, *Totemism*, Edinb., 1887, Black.

² *Tr. Canad. Inst.*, Toronto, 1894, IV, page 12.

unbroken as we proceed backward in time. Or, to put the matter in another shape, there never was known to history a day when the two continents were not intimately associated. The evidences of the past seem to confirm the opinion that as we go backward in time the geographic conditions were more favorable and the contact more intimate.

In conclusion, the author has not here undertaken to do more than to clear the way for a specific study of the civilizations of America and those of eastern Asia.

Such a study will require a great deal of patient inquiry on the part of students cooperating systematically and scrupulously only to know the truth. The investigations of Dr. Walter Hough show that the fire drill, consisting of a vertical revolving shaft and a horizontal hearth piece, exists uninterruptedly from Australia to Tierra del Fuego, and that besides this common apparatus, on the contrary, in the Malay area, have also been invented the fire plow, the fire saw, and the fire syringe. Wherever the better modes of fire making have superseded, as in Japan, the carpenter goes on boring holes with reciprocating motion between his palms.

Dr. Hough's studies in plate armor point to its existence in the entire stretch from Japan to the Columbia. If anyone will study carefully Von Schrenk's *Reisen und Forschungen im Amur-Lande*, third volume, and compare the figures and plates with similar illustrations from the Aleutian Islands or east Greenland, he will at every turn be arrested by seemingly useless similarities. The curious ivory ornaments on the sea otter hunter's wooden hat, made at great cost, are only explained by the patterns cut from bark and attached to their clothing. The same odd fashion is in full play in east Greenland. The harpoon of the east Greenlander and the central Eskimo, with line hole through the toggle head effected by two diagonal holes bored in the flat side, is almost precisely that of the Gihak. The canoe of bark pointed at both ends below the water line is identical on the Amur and the Kootenay, and so on.

The author protests against closing the door of investigation peremptorily, believing that it is the privilege of all to open any question anew. He desires to lay aside for the present any arguments relying upon continents that have disappeared, upon voyages across the profound sea without food or motive, upon the accidental stranding of junks, or upon the aimless wandering of lost tribes. These may all have entered into the problem of the aboriginal life of America. They are historical and geological questions and must be decided by the methods of these two sciences. It is here essayed to show that when the continent of America was peopled, it was done by men and women purposely engaged in what all sensible people are now doing, namely, trying to get all the enjoyment possible out of life for their efforts, and that the present condition of the earth and of peoples offers all the opportunity necessary for such peopling.

THE GUANCHES: THE ANCIENT INHABITANTS OF CANARY.¹

By CAPT. J. W. GAMBLER, R. N.

Much has been written of late and much said of the merits of the Canary Islands as health resorts, but as yet the attention of the general public does not seem to have been drawn to the extremely interesting problems as to the remote past of the human race which a study of the manners and customs of the ancient inhabitants of these islands affords. Various spots on the face of the earth have been claimed by scientific men as the cradle of the human race, and different nations adopt different names for the three or four recognized types which have been discovered in long barrows and round barrows, in caves, and deep under the soil; but practically it comes to the same thing, by whatever name they may be known, if we can only identify these people with others bearing the same structural peculiarities, and this, as regards the Guanche race of the Canary Islands, we are enabled to do. We trust, therefore, that the following remarks and sketches may enable those who are unable to visit those extraordinarily interesting places in person to form some idea of what our earliest ancestors, or at least their contemporaries, were like.

The habitations of these ancient people, who were of what we call the Iberian race, were mostly caves excavated in the sandstone rock, which crops out in some parts of these otherwise almost entirely volcanic islands. But the stone implements of ruder form, preserved in the museum of Las Palmas, were no doubt the workmanship of people long ago antecedent to those who scooped out these very symmetrical caves. Who or what they were is lost in the dim uncertainty of the past, and nothing but their bones and their skulls and their rude implements remains to us. In some few instances the caves were hollowed out of the easily worked tufa, or volcanic deposit; but as to the great majority of these caves in the tufa it may be said that they are merely accidental holes utilized by the earliest aborigines, and are not nearly so interesting as the sandstone dwellings. As to these sandstone caves, it must have been a most laborious work for people to produce them whose only tools were implements of stone. It may be accepted as a generally well-ascertained fact that in some of these caves we are actu-

¹From *The Antiquary*, Nos. 49, 50, 51, new series, Vol. XXIX, January, February, March, 1894.

ally standing in the cave homes of those inhabitants of our globe who lived in the Paleolithic age—that is, the age of the unpolished stone; the age immediately succeeding the most primeval race of which we have any trace at all; a race whose antiquity is measured by the light of modern science as coexistent with the last glacial epoch, and which possibly existed even before that period. Nor is this, in the case of the people we wish to describe, mere supposition, for by anthropometrical observation, as well as by craniology (the twin sciences of human measurements of bones and skulls), we are brought face to face with the fact that in the slow and eternal evolution of the human race certain structural peculiarities belong to these early races whose remains we find in these islands, which have either been modified to suit an altered environment or have entirely disappeared, as no longer necessary either in the struggle for existence or in the enjoyment of life—the two most potent factors in all the complex processes of evolution.

As regards this structural alteration, it may be briefly said that a certain peculiarity in the elbow joint—which doubtless served some purpose



Fig. 1.

PERFORATED ARM-BONES OF THE GUANCHES.

to our arboreal progenitors, but which in parts of Europe where races have been more rapidly mixed, or where civilization has made more rapid strides, and consequently the process of evolution become more determined, has ceased to exist—existed among the Guanches, and is still found among their descendants to this day in a proportion far exceeding that

in any other known race. In England, in our days, this peculiarity is practically extinct—in some parts of the world it reaches 2 per cent of the population—but here, among the Guanches, it has been ascertained by actual observation to reach to the astonishing number of 20 per cent, showing a race who have been so little intermixed and so direct in descent from the Stone age as it would be difficult to find except in the most isolated parts of the world, among races such as the Aztecs, or the inhabitants of some of the Pacific Ocean islands, or among the natives of Australia. This is one of the peculiar interests of the Guanche race.

This sketch of the arm bones shows the peculiar bone structure referred to above. It should be observed that the ordinary arm bone has no hole in it at all. (Fig. 1.)

Again, the craniology of these people has been identified by Dr. J. Cleasby Taylor, the resident English physician at Las Palmas, as proving their Iberian descent, belonging as they did to the Dolichocephalic branch of the human race. So that, whether the Guanches owe their origin to some primordial race of men coexistent with the earliest genesis of man, or whether they brought these strongly marked structural characteristics from Berber or other mainland races, does not affect the question of their antiquity.

The skulls illustrated (Figs. 2, 3) are drawn from specimens in the collection of the museum of Las Palmas. The first is a purely Iberian type, belonging to one of the three or four great divisions of the human race—those large groups or nationalities which had gradually formed from out of the primordial and half-simian swarms that had preceded them. These Iberians inhabited the greater part of western Europe in an infinitely remote period, probably toward the termination of the last glacial epoch, which some would place at eighty to ninety thousand years ago. These men lived and died among the gigantic animals now extinct; among mammoths, the giant elk of Iceland, the cave bear, and so forth. In England and in most parts of western Europe (except Germany, where they never penetrated) the remains of this race have been found in what are termed the long barrows, as distinguished from the round barrows, which belonged to the round-headed, a stronger race, who gradually eliminated the weaker. This long-headed race are known as the Iberian; they inhabited the Basque provinces, Spain, northern Africa, Sicily, Sardinia, Corsica, and the Canary Islands, and it is the same race who, by some yet unsolved problem, found their way to Mexico. These Iberians, however, gradually gave way before the stronger races—the Aryan, the Scandinavian, and the Ligurian—but in these remote Canary Islands they lived on less molested, less influenced by more dominant races, and hence have transmitted to a comparatively recent time their structural peculiarities. For this reason



Fig. 2.

DOLICHOCEPHALIC SKULL.

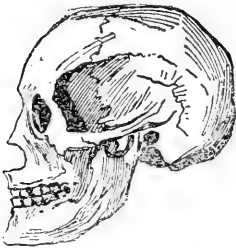

Fig. 3.

BRACHYCEPHALIC SKULL.

the caves and places of sepulture, which the Spanish discovered here in the early part of the fifteenth century, still retained the remains of the most ancient race known to us—still indicated their modes of life, and brought down the manners and habits of the Stone period to within three hundred years of our time.

A glance at the two skulls as drawn here will show the difference between the two types of skull. The first, it will be observed (an ancient Guanche skull of the Iberian race), is long behind, low in front, and has the jaw hardly at all advanced from a perpendicular line down from the eye-socket. This, in scientific parlance, is the Dolichocephalic and orthognathic type—that is, long-headed and weak, or slightly protruding chin. The other skull, it will be at once seen, is of a different type—rounder, bolder, with more frontal development, and with the jaw coming well forward. This is called the Brachycephalic

and prognathic type, two words describing the above properties. Now, these Brachycephalic types of the human race are those that have superseded the weaker race almost all over Europe, and it is from these that the great Anglo-Saxon, Scandinavian, and, generally speaking, Teutonic and Latin races have come. Of course, there existed intermediary types, brought about by intermarriage; but these are few, and in the eternal process of evolution the stronger naturally prevailed.

The mummified head, of which we give a sketch, is that of an ancient Iberian. It is quite impossible to assign a date to any of these Guanche mummies, for they have no accompanying writing of any kind, and have left no record behind them. (Fig. 4.)

The mummies of the Canary Islands present some very interesting peculiarities, and have been found in great numbers in the caves that have been used indifferently as places of sepulture and as the abodes of the living. The art of embalming must have been learned from stray



Fig. 4.

HEAD OF A GUANCHE MUMMY.

Egyptians or Phœnicians, and there is a legend that in the thirteenth century before Christ the then Egyptian ruler sent a colony to these islands, who settled here. The Guanche mummies, however, differ from the Egyptian in several respects. The bodies were sewn up in many folds of goatskin (twenty to twenty-five in some cases), and the legs were sometimes bent back and doubled onto the breast. The bodies, after a little preparation, were sun-baked, and were then sewn up with lumps of balsam laid in the folds. They have been found in a perfect state of preservation, though many can not be less

than 3,000 years old. Up to what date the Guanches continued to mummify their dead it is difficult to say, but there is reason to suppose that the practice has been extended here far longer than anywhere else in the world. All their dead were not, however, mummified. The lower orders of the people were buried in cairns, the body laid on a heap of lava and covered over with stones. Thousands of these have been found, and have afforded most valuable anthropometrical information.

Our sketch shows the mummy of a young woman of the early type, long headed, and with nonprojecting jaw. She must have been about 5 feet 1 inch, and apparently in perfect proportion. She was a mother, and her infant baby was found in the case with her, and still lies near her. The covering skins have been opened for examination. (Fig. 5.)

We must picture to ourselves the ancient Iberians slowly giving up cannibalism, slowly learning to use fire, which the volcanoes of these islands, that were active until recent days, must have early taught them to apply to some purpose; or we must think of them as struggling with gigantic animals, which by constant warfare through thousands, possi-

bly millions, of years they finally exterminate, and we must watch them gradually improving in such rude arts of fashioning stone as we know them to have possessed. Then the next stride would have been by making their cave homes, employing still better implements of stone, polishing basalt, and shaping many things which indicate both skill and imagination in their design, and so on, until they begin to adopt pastoral habits, to breed flocks and herds, and with some gradually dawning ideas of what we term modesty, stitching the skins of their goats and sheep into garments. Thus slowly these islanders drift on, forming themselves into families, and into village communities, and unconsciously evolving some patriarchal kind of government; take to having one wife, and one only; discover and enforce those main principles of virtue to which even all our civilization has added nothing, namely, courage, truth, and chastity. We must also picture to ourselves that in other parts of the world infinitely more rapid strides were being made; for whilst these ancient Canarians were only beginning to polish their basalt hatchets, the Etruscan and pre-Hellenic races, the

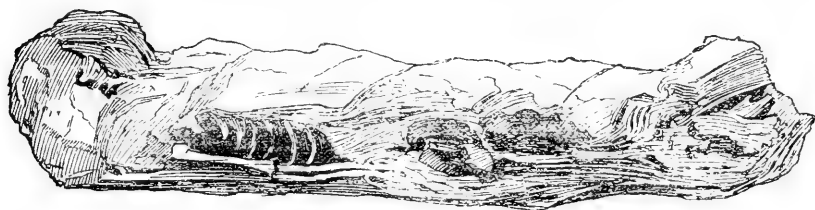

Fig. 5.

GUANCHE MUMMY.

Ligurians and our own Celtic ancestors, were already fashioning bronze; Homer's heroes were fighting, and were being buried at Hissarlik; and warriors, whose mythical names seem to have reached our day, were conquering still earlier races in our own islands. And still greater changes soon took place among more forward races in Europe and Asia. Iron was supplanting bronze; the mythical personages of pre-Hellenic days were giving way to historical men and women; civilization was rushing forward; the perfect government of early Greece was forming itself; dynasties in Egypt were rising and falling; the Phœnicians were peopling Spain, and driving out, or becoming identified with, the Iberians of that land; and even the Celts in our islands were giving way before the powerful red-haired, strong-jawed Scandinavians. But here in Canary things stood still. The people were apparently perfectly content with their own mode of life, and lived on in their cave dwellings, undisturbed by the strife and bloodshed which inevitably accompany civilization.

The sketches we give illustrate the rude stone implements used by these people in excavating their cave homes, the very same caves that

are still inhabited by the islanders of this day. They were held in one hand and used as we use a pick; but from the shape of one of these sketches it will easily be observed that a hammer-shaped instrument was also used. These all belong to the Paleolithic age. They are generally chipped roughly out of blue lias, weighing 4 or 5 pounds each. A larger kind weighed as much as 8 pounds. (Fig. 6.)

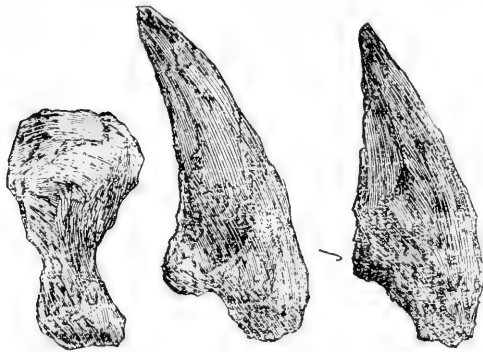

Fig. 6.

PALEOLITHIC IMPLEMENTS.

The next group belong to the Neolithic age, and it would seem that in this age greater precision of workmanship was obtained in cave making, as is only natural with improved instruments. What interval of time elapsed between these periods is naturally merely conjecture. These neolithic instruments are generally of lava or some hard trap. They were smaller, and many were of the ordinary spear and arrow head form found all over the world. (Fig. 7.)

But now we come to a classic period in this Guanche life. For though they remained untouched by what was going on in the world, the world itself already began to feel a deep interest in these "Fortunate Islands," especially the Greeks and Phœnicians, to whose influence it is not to be doubted the islanders owed some advance in their ceramic art, and possibly improvements in their mode of life. For these were the islands of the Hesperides, and the peak of Teneriffe was the Atlas that bore up the heavens; and to these very islands Homer made Jupiter send Menelaus as a reward for all his wrongs and all that he had suffered. They were the Elysian Fields, "those blessed isles where the bitterness of winter is unknown, and where the winds of the ocean forever freshen the balmy air." This, too, is the home of Plato's vanished Atlantis, his ideal republic.

It thus becomes a strange speculation as to how around the lives of these simple islanders, people only half emerged from the actual condition of primordial man, the most exquisite myths and the most deeply suggestive legends of old days have grouped themselves. Here were a people who scarcely knew vice. Paid vice was unknown; and the Spaniards record with wonder that they never lied! But to return

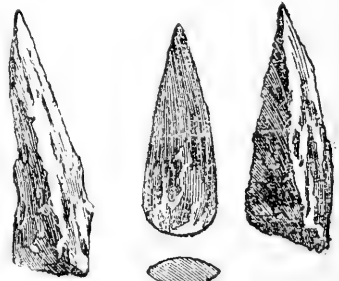

Fig. 7.

NEOLITHIC IMPLEMENTS.

It thus becomes a strange speculation as to how around the lives of these simple islanders, people only half emerged from the actual condition of primordial man, the most exquisite myths and the most deeply suggestive legends of old days have grouped themselves. Here were a people who scarcely knew vice. Paid vice was unknown; and the Spaniards record with wonder that they never lied! But to return

to the historical: In later days Pliny, historian of Pompeii, mentions an expedition sent to "the Fortunate Islands," which brought back its "golden apples" (oranges), and alludes to those wonderful dragon trees, whose age has been computed by Humboldt as not less than 10,000 to 12,000 years. One of these enormous trees stood within recent times at Orotava. It was the largest tree probably in the world, and was considered especially sacred. It was the meeting place of all the islanders on religious and political occasions. We give a sketch of it, which has been copied from a small original sketch in the museum at Las Palmas, taken before the tree was destroyed in 1868 by a storm. But before this nearly two-thirds of the tree had already been cut



Fig. 8.

THE OLD DRAGON-TREE OF OROTAVA.

upward of thirteen hundred years after Pliny's account of them these islands are lost to sight, emerging again by their re-discovery in the first years of the fourteenth century, when a Norman of the name of Bethencourt once more visited their shores and took possession of them in the name of the King of Spain. . . .

We would draw attention to the peculiarly Egyptian type of face of one of

the women given in our sketches. (Fig. 9.) Both these women belong to cave-dwelling families, and though neither can be said to be a real Guanche, as none of that race now exist, still it can easily be seen in comparing them that the type has been transmitted in a much higher degree in the one than in the other. No one with ordinary observation can fail to be struck by the peculiarly "native" gait and gesture of the present dwellers in the caves. There is distinctly something un-European



Fig. 10.

CAVE-DWELLER OF CANARY.

(Spanish type)



Fig. 9.

CAVE-DWELLER OF CANARY.

(Egyptian type.)

in all their gestures, and they seem to have reverted to the modes of sitting, the expression of face, and possibly the voice of their Guanche ancestors, precisely as in the United States we see people

of pure British descent developing or reproducing the features and walk of the red Indian—the high cheek bone, thin hooked nose, arched instep, slouching gait, and nasal intonation. But alas! if the physical qualities of their Guanche ancestresses have been transmitted, their purity and sweet gentleness have not been so successfully handed down.

When the Spanish invaded these islands they found a condition of affairs that must have been quite ideal and possibly unique in the world's history. To the simplicity of the savage these people had added all the highest virtues; indeed, viewed from the standpoint of nineteenth-century morality, it is a mere travesty to describe the customs and habits of the Guanches as in any way pertaining to what we are pleased to consider as civilization. The men were brave, a lie was an unheard-of crime, and the treachery and fraud of the Spaniards a revelation to them. The women were notoriously chaste. Men had but one wife, and paid the profoundest respect to their fathers. Their food was simple—the flesh of goats, with milk and fruit, and gofio (still the main food of the islands), which consists of the grain of barley crushed and roasted and mixed with milk or with water, according to their circumstances. Life in every form was as precious as it is to a Brahmin, and they looked with horror on those whose vocation it was to destroy it. As is the case in China to this day, a butcher was an outcast, generally a criminal, who expiated the enormities of his crimes by having to imbue his hands in the innocent blood of animals.

The consequence of this extended humanity was that the very birds of the air in these islands were tame, and the astonished Spaniards saw, not unmixed with awe and superstition, nature's most timid creatures playing amongst the feet of the children. These people had no professional priests, and in consequence had no idols and no fetich. They believed in one Supreme Being, in future punishment and rewards, and all their God asked of them was a pure life and a reverent attitude of mind.

Social problems among the Guanches seem to have been most admirably thought out. So as to insure an equality of wealth, the land was distributed at the death of the head of a family. There also existed a peculiar order of self-directing Sisters of Mercy among them, devoted to a simple life of nourishing the poor and needy, clad like all the rest in their garb of goatskin, and only distinguishable from their lay sisters by lives of abnegation. They remained vestal to the end of their days, and were rightly esteemed to have merited, and were believed to have earned, the highest reward hereafter. And as there was no pelf for the priests, there was naturally no building set apart for mystic rites and ceremonies. They built dolmens, as we see them in Wales, Cornwall, or at Stonehenge, and here the people assembled and knelt in circles with their hands lifted to heaven in silent prayer.

As regards the ancient language of the Guanches, it is generally accepted that the traces of it are very obscure. Very learned treatises have been written on the subject, with the usual result that most of these doctors disagree. That the Spaniards found several languages in existence is beyond doubt, and some authorities maintain that that spoken in the island of Teneriffe was the only true Guanche language in existence at that time. But the most rational solution of this babel of tongues is that the languages spoken in the different islands were dialects of the same mother tongue, which tongue must have been of Berber origin. Sir Edmund Scory (temp. Elizabeth of England) says: "The language of the old Guanches, which remayneth to this day among them in this Island in their towne of Candelaria, alludeth much to that of the Moores of Barbary." The root of the language was Aryan, but it is, or has been, so intermixed and overlain by many others that very little of it is really known: and that little is a very puzzling subject to the philologist. Upward of a thousand words, however, are known to us, and from these may be gained a very fair view of their religious, social, and moral tenets. Thus the word *Acaman*, also appearing as *Ataman* and *Atuman*, and meant indifferently, God, the sky, or the sun, showing that the Giver of Light was their primitive conception of a God, the usual sun worship of all early religions. Another title of the Deity was *Acquayaxerax*, or "The Sustainer of All," an exquisitely poetical designation. Their belief had nothing in common with the Jehovistic idea. The Guanches seem to have had some dim idea that their God was part and parcel of His own works, inseparable from them—coexistent and coeternal with nature. This may be inferred from the fact that God was also known in Guanche as *Guarirari*, or "The Indweller of the Universe." But again, on the other hand, He was also known in one of the islands as *Achahuerahan*, "God the Creator," bringing it back to the old difficulty. The word *Achimaya*, "mother," is of special interest, as it seems to contain the germ root for that sweetest of all words in so many and widely divergent languages. There is clearly some connection between "maya" and *mater*, and the "maia" of Buddha. Here, also, is a curious resemblance: *Haran*, "a fern," which by the ordinary change of *h* into *f* becomes "faran." *Cabuco*, "a goat fold," resembles "caper" or "capra" in Latin. The name for the moon, *Cel*, seems to contain the germ of the Greek *σελήνη*. Another curious resemblance is found in the word *Magada*, "a virgin;" Gothic, *Magath*; old German, *Magad*; modern German, *Magd*; English, *Maid*. A prefix to this word, *Hari*, meant a vestal virgin, *Harimagada*. Is this *Hari* the same word as the German *Heilig*?

Perhaps an entire sentence may be of interest, for which, together with the preceding Guanche words, I am indebted to a paper on the language of the ancient natives of these islands by the Marquis of Bute: "*Achoran, nun habee, Sahagua reste quagnat, sahur banot gerage*

sote," which is translated: "I swear by the bone of him who has carried the crown to follow his example and to make the happiness of my subjects." "*Janaga quayoch, archimencen no haya dir hanido sahec chungra petut*"—"The powerful Father of the Fatherland died and left the natives orphans."

These sentences give an idea of the language to which these ancient races were accustomed, and also point out how poetical were their ideas.

In many respects this primitive language seems to have been singularly fortunate, for the Marquis of Bute observes as to their verbs, "There is only conjugation, and it seems to be beautifully developed, as though upon a purely logical basis, like an ideal generated from a philosopher's thought."

As regards the cave dwellings, though many are scattered throughout all the islands of the Canary group, the chief are at Atalaya, in the Grand Canary, about 7 miles from the port and town of Las Palmas. This City of Caves is situated on a peculiar-shaped lime and sandstone hill, which projects into a wild, rugged valley, overlooking a great expanse of country, the sea lying far below, and the main mountain range of the island, some 7,000 to 8,000 feet high, rising behind. The road to it, after leaving the modern and excellent Spanish carriage road, is rough and fatiguing, and is probably as ancient a track as has been ever trod by human feet. Over this road for countless thousands of years these troglodytes have traveled on their way up from fishing in the sea or from the cultivation of the lower lands, and over these same tracks still travel their half-breed descendants in search of work in the towns and the vineyards.

The hill of Atalaya forms two round heads, both honeycombed with ancient caves, which vary in size, the smallest not more than 8 to 10 feet square and 6 feet high; the largest, with two apartments, both of which may measure 18 feet by 12 or 14, and 8 or 9 feet high. It is evident that in many cases existing natural caves were utilized, being squared off inside and shaped to suit the convenience of the inhabitants, but many others are entirely the work of man, scooped out with infinite pains from the solid sandstone rock. The most primitive races of all probably did none of this scooping, but were content to live in the natural caves in the same way as their simian brethren.

Some idea of the extent of the cave communities may be formed when it is stated that even to this day, with many hundred caves empty or utilized as storehouses, there can not be less than 1,500 inhabitants in Atalaya, besides numbers of goats, pigs, donkeys, and mules, who are also provided with cave accommodation, without trespassing on the sleeping room of their masters, as in Ireland. Many of these cave rooms are very comfortably furnished and are inviting to look at. Some are particularly clean, well whitewashed, and the floors thoroughly swept, whilst beds with snow-white covers and little tables with rough

lace work on them for cloths, a few books, the inevitable Madonna, some candlesticks, and the always picturesque pottery give an air of refinement that we may search for in vain in the coarse homes of too many of our own peasantry. As to the healthiness or comfort of these dwellings, of course it is a matter of habit. The only ventilation is the door, and as that is tight shut at night it seems difficult to understand how the people can breathe. There must also be a considerable disregard of les convenances as to their habits, for apparently both sexes of all ages occupy the same room. The sanitary arrangements, it need hardly be said, leave much to be desired. There is a staggering simplicity and freedom in their treatment.

The present dwellers are very gentle and extremely ignorant. The men go out all day to look for work or work in their own little patches



Fig. 11.

POT-MAKING BY CAVE DWELLERS—ATALAYA.

of cultivation; small terraces of reclaimed land walled up below. The women all work at pottery, using no wheel, and reproducing the simpler patterns, as are found in the tombs of thousands of years ago. The clay used is very strong and has much adhesive power. It bakes into a fine dark red. They now never color their pottery, nor do they mark it with the stamps, as in the old days. Many of the best shapes are lost and those that remain are strictly utilitarian.

As to their personal appearance, among these cave dwellers may often be seen strikingly handsome faces; their forms are good and their movements graceful. It has been said that they are often rude to visitors, and carry the importunity of begging (for they are insatiable beggars) to the limits of rudeness and menace. It certainly is unadvisable for ladies to go there alone.

Music appears to be little known among them. They have no musical instruments, and apparently no airs that are popular in the sense of general. Still one hears them crooning away in a peculiarly melodious manner and always in a minor key. Some among the wealthier have elaborate costumes, which they don on Sunday. The headdress (the handkerchief) is discarded on these occasions, and the hair is drawn back and tied in a lump behind, with large flowers placed low down on their necks, an arum lily, or a bunch of the wild geranium, which grows in such profusion all over the islands.



Fig. 12.

OVEN FOR BAKING POTTERY—ATALAYA.

a great event among the cave dwellers. Large numbers of people sally forth for days before collecting brushwood of all kinds, and great heaps are piled up in the open space before the public oven, where all the pottery to be baked is also collected. A roaring fire is soon produced, and the different pieces of pottery are thrust into the flames, and are then moved about by

The periodical baking of their pottery is

means of a long pole of hard wood to insure their being evenly

baked. Some kind of red glaze is put onto those which it is wished to decorate, but the greater part are baked without any glazing matter. It is an extremely busy scene, with a great deal of shouting and screaming, everyone giving instructions and orders, to which no one else pays the least attention. No one person seems to be in command, and all kinds of interlopers crowd in to give advice or to cram sticks into the oven.



Fig. 14.

HEADRESS, PESTLE, AND HANDMILL.

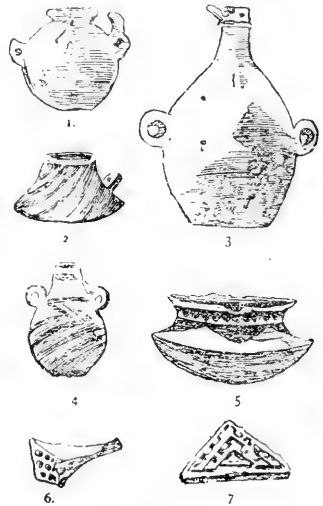

Fig. 13.

ANCIENT GUANCHE POTTERY.

But the ancient Guanche pottery (selections from the collection in the museum of Las Palmas are here given) had much elegance, variety of form, and diversity of pattern. No. 1 is an example of an ordinary water jar, and No. 2 of a curiously shaped bowl with a handle. No. 3 is a fine double-handled water jar, 20 inches

high, with a lid of the same ware. No. 4 is a small ornamented jar of the same character. No. 5 is a bowl 5 inches across, which is of much interest, as showing the influence of early Etruscan art. Nos. 6 and 7 are seals for stamping early pottery; they are made from lava.

The other Guanche remains of which we give sketches are also taken from the same museum. They have not previously, so far as we are aware, been figured in any book or journal, though similar objects are to be found in several European museums. It is not a little remarkable and not very creditable that our great ethnological collection at the British Museum has not a single relic of the Guanche race.

In this next group (fig. 14) No. 1 represents a headdress or coronet worn by the ancient Guanche women. It consists of a wide thong of leather, upon which white shells are rudely riveted. No. 2 is a pestle and mortar. The mortar is of blue lias, and about a foot in diameter; the pestle is of a hard grayish-yellow stone. No. 3 represents a small stone hand-mill for grinding barley; it is 14 inches in diameter.

In the upper part of the last sketch (fig. 15) are shown some sling stones, weighing from 4 to 6 ounces, as well as two hand-throwing stones, which weigh $1\frac{1}{2}$ and 2 pounds respectively. Next to them is a sling of leather. The other articles are a variety of bone needles and a comb of hard wood.

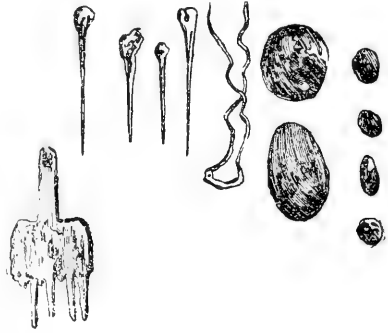

Fig. 15.

THROWING-STONES, SLING, NEEDLES, AND COMB.



PSYCHOLOGY OF PRESTIDIGITATION.¹

By ALFRED BINET.

Everyone of us, whether aware of it or not, has experienced illusions of the senses; they do not always tell the truth. The eye, the ear, deceive us, and even the hand, that we instinctively extend to test the evidence of our other senses, has often played us false, though, to speak more accurately, it is the mind and not the senses that is at fault. The senses make known but one thing, the sensations. The eye merely communicates the different shades of light or color; the hand, sensations of contact and movement. The mind interprets these sensations, draws conclusions, and with these conclusions constructs exterior objects endowed with numberless properties. When we say this is a chair, a table, a dog, a house, we not only indicate what the eye has perceived, but we reason it out. Yet if this automatic and rapid reasoning be at fault we have had an illusion of the senses.

Prestidigitation is an art which has in view a singular aim, that of seeking out and developing all influences which could lead us to be deceived in what we see. A person witnessing experiments in prestidigitation and understanding nothing of the means employed is easily made to believe that he sees an object in one part of the room when it is really elsewhere; he sees that which does not exist and sees not that which really does exist.

One can readily understand the interest of the psychologist in the study of the means employed to produce these illusions, for it enlightens us as to the process by which the mind perceives exterior objects, and makes known likewise the weak points of our knowledge. Before entering into the details of our analysis it may be well to determine by certain general considerations the nature of the error produced by the art of the prestidigitator.²

¹Translated from *Revue des Deux Mondes*, October 15, 1894.

²We have borrowed the principal elements of this study from the old works of Jacques Ozanan, Guyot, Decremps, Ponsin, and from the more recent books of Robert Houdin. Some authors, Mr. James Sully (*Illusions des Sens et de l'Esprit*) and Mr. Max Dessoir (*Open Court*, 1893), have treated the question from a psychological point of view, and we have borrowed from them useful indications. We have above all tried to give the reader a clear idea of the performance of these tricks by consulting professionals and requesting them to execute before us, in different conditions, tricks in which they very obligingly showed us that which they are in the habit of carefully concealing. We will cite with pleasure among these benevolent coadjutors Messrs. Arnould, Dickson, Méliès, Pierre, and Raynaly.

I.

Mr. James Sully, the eminent English psychologist, has made a distinction with regard to the illusions of the senses which presents real philosophical value. The illusions of the senses, he says, should be divided into two categories, the active illusions and the passive illusions. The passive illusions are general; they are those which are experienced under the same conditions by all individuals; they are inherent in our psychic organization, and no one can escape them. It is a law that we see objects in a perpendicular position, notwithstanding the fact that their image is reversed upon the retina of the eye. A stick plunged into the water has to us the appearance of being broken. From these errors, common to all, we must distinguish those Mr. Sully calls active, those that are productions of the spontaneous activity of the mind; these remain individual unless they take the epidemical form. They are the result of our temperament, the state of our mind and our belief. Hence it is by an active illusion that while awaiting a person on the roadway we fancy we recognize him in a person approaching in the distance.

Without going so far as to say that all belonging to the active illusions present a certain gravity, it must not be forgotten that it is illusions of this kind and not the others that are near relations to the hallucinations of madness.

Unquestionably illusions of prestidigitation form a part of the passive illusions, and, as it were, normal, which dominate all well-constituted persons. Subsequent analysis will confirm this affirmation, in showing on which precise point the error of the senses bears. Mr. Max Dessoir has discussed this question à propos of an interesting experience. He supposes an illusionist taking an orange, and after having shown it to those around him, throws it up into the air and then catches it in his hand as it descends. He repeats this performance once, twice, and the third time, after having placed the orange in his pocket without the knowledge of those looking on, he makes a pretense of again throwing it up in the air. Mr. Dessoir thinks, and we think with him, that many of those present misled by this action would believe they again saw the orange being tossed into the air as on the two other occasions, and would be greatly astonished at not seeing it descend as they had reason to believe it would. What is the nature of the illusion in such a case? What name must be given to it? To see an object in a place where in reality it is not, is an hallucination. Mr. Dessoir has good reason to discard this injudicious interpretation. The word hallucination, as we have frequently observed, must be used only with reference to an illusion that can have no explanation in exterior things; it is a disorder of the senses, not a normal error. If the spectators believe they see the orange, then they yield, as we will explain, to a pretense on the part of the conjurer; they give themselves up to

the illusion, without troubling themselves to investigate it, which would only destroy the appearance and therefore the pleasure.

It must be observed that the greater part of these illusions which owe their existence to the art of prestidigitation must have for a necessary condition the cooperation of the public, or at least their willingness to oblige.

The public do not go to the prestidigitators for the purpose of picking to pieces, as it were, a scientific experiment. They ask only one thing—to be deceived; that is to say, to experience that astonishment, that slight cloudiness of ideas or intellect which the sight of a phenomenon contrary to all natural laws excites within us. In order that this particular mental state should be produced one must give one's self up to the illusion, and not endeavor to lay hold of the mechanism which produces it. If by chance we discover the secret of the trick we must keep the discovery to ourselves, as propriety demands. We would not dream of such a thing as questioning the prestidigitator while in the exercise of his profession, nor of taking precaution to see through his magical performances. If the magician places his hands behind his back at a critical moment we would not call out to him as did the fox in the fable, "I beseech of you, sir, turn round." The reserve of the first instance comes from a sentiment of discretion; that of the other from a certain timidity. These illusionists are well aware of this; as for instance when they wish to have a certain card chosen from the pack they invariably address themselves to a lady, as a woman is much more given to reserve than a man; and should she perceive the fraud, she dare not raise her voice to demand an explanation for fear of attracting attention to herself: her timidity makes her the artist's accomplice. For that matter the magician has more than one means of mastering a skeptical and unyielding public. In performing a trick he goes through one part of it before one person and to complete it he turns to another who has as yet seen nothing of the first part. It is necessary for the same person to witness the entire trick in order to understand how it is done. Thus one person is made to mark a piece of money and another farther away is to keep it, who, not having seen it marked, is not aware that it has been changed.

With regard to those who are requested to come upon the stage in order to examine closely the actions of the magician, they exercise a control essentially deceptive. The prestidigitator takes particular care only to choose those from the audience whose countenance express artlessness and simplemindedness, when they are not confederates. The magician allows these witnesses to see only as much as it is convenient for him to have them see; they are also at liberty to do, whether they be aware of it or not, only that which he wishes them to do, and can not undertake to find out anything for themselves without the artist's permission. This is the conclusion arrived at lately in a curious contest. One of the audience wished absolutely to know what

was going on behind a screen, and on being called upon the platform he raised the screen, and immediately great excitement was evinced on the part of the artist and his assistants; a hand-to-hand combat ensued, and it ended in a law suit. The audacious offender was made to pay heavy damages for having exceeded the rights the magician had granted him. One may judge by this example how difficult it would be to make scientific observations at a public representation. Notwithstanding the difficulties of control, the public is the dupe of the illusions presented to him only in a certain degree, as he considers the fact that he is attending a seance of prestidigitation; if it is impossible for him to understand the secret of a trick, this would not be a reason for him to believe that the laws of nature had been overthrown. Should a nutmeg appear suddenly as if it sprang from the artist's finger ends, without the spectator being able to understand how it was done, he would not from this believe it possible for nutmegs to spring from one's finger ends. The illusion exists, we may say, only for the sense of sight; our reason contradicts it.

II.

In seeking to analyze the different processes by which the illusion is produced in these feats of sleight of hand, and the spectator prevented from discovering the truth, we find it most difficult to give clear and satisfactory definitions, as there exists not only one process, but many, and they are of a very complicated nature. The illusion of each trick is not merely the result of one single cause, but of many, so insignificant that to perceive them would be quite as difficult as to count with the naked eye the grains of sand on the seashore. I will not enter too much into detail, but will confine myself to exposing the principal artifices resorted to by the prestidigitator. The illusions of the senses which we will study may be divided into two principal groups, positive and negative. Modern researches in hypnotism have familiarized us with the term and with the phenomena they indicate. We know that the positive illusions with which we will begin our description consist in seeing that which does not exist; they give rise to appearances without reality. Persons in a hypnotic state have these illusions; they are one of the very first steps of this artificial condition of the mind.

A person hypnotized can be commanded to see anything by the person who hypnotizes him. For instance, he says: "Here is a bird!" in a persuasive or commanding tone of voice. Immediately the subject imagines a bird is in the room; he sees it, he touches it, he hears it sing, catches hold of it with awkward but expressive gestures, and goes through other like performances caused by the suggestion of a bird. We cite this example of hypnotic illusion because there is a resemblance between it and the illusions of the prestidigitator by the important fact of its being the result of the influence of one mind over another. But

lay aside this fundamental resemblance and what a difference we find between the two cases! When we wish to surround a hypnotized person with illusions the operation is one of the greatest simplicity. We merely pronounce a word in an authoritative tone to make the illusion a reality to him. "Here is a bird," we say, and without further explanation the subject sees a bird as if it were in reality present. The prestidigitator must resort to a more subtle means of arriving at the same end; he must deceive the spectators without their being aware of the deception that is being practiced upon them.

The first necessary condition for all these operations is holding the attention of the audience. Before commencing a trick the operator should endeavor to have the attention of each one of the spectators, in order that their minds may enter into relation with his. This is what in hypnotism is called "entrer en rapport," giving a convenient term to a phenomenon the existence of which is certain, but the nature of which it would be most difficult to define. We all know how to attract and retain the attention of a person with whom we wish to speak. It is instinct with us. We were never taught the different insignificant means employed to arrive at this end, such as raising the voice, placing the hand upon the shoulder, or making use of an interjection. We all know that a great deal depends upon the personality of the individual; for instance, there are some who find it impossible to hold the attention of an audience or even of an individual, while there are others who by the mere utterance of a few words, such as "I do not know" or "I beg pardon," command immediate attention. The prestidigitator who has doubtless never reflected upon the means he uses to hold his audience, nevertheless knows well how to exercise this influence to attract the eyes and close attention of everyone present to his hands, his eyes, or to whatever part of his body it is necessary for his project that they should be attracted.

Robert Houdin makes an observation the truth of which will be readily recognized by those who are accustomed to speak in public and to enter into communication with a large concourse of individuals. He says that the first and most important quality of the prestidigitator is to possess a steady eye; certain people have a timid, vague expression, and while conversing with them should one look them frankly and steadily in the face they feel embarrassed and turn away their heads as if they dreaded the intimacy of such looks. This timidity of expression is contagious; it is a great stumbling-block to conversation, and prevents the orator from exercising any influence over his hearers. The prestidigitator, says Robert Houdin, must have a frank, bright, penetrating glance, which he must concentrate boldly upon the eyes of the spectators in such a manner that their eyes become riveted on his, and a feeling of mutual sympathy arises. When the artist accomplishes this he can at will turn the eyes of his audience in whatever direction he sees fit.

The means employed to produce positive illusions is the making use of feint or pretense.

The feigning of an action is the mere outline of the action. A feint is made of taking something from the table; the hand is extended toward the table as if to remove the object. A feint is made of throwing an orange into the air, when in reality it is still retained in the hand. Feigning an action consists in performing only the first part of a well known and expressive action, and the end is concealed; the hand is hidden, for example, behind a table, a screen, or behind the body during this second part of the act, which must be executed with dexterity. The spectator not anticipating anything of the sort, having seen the first part of the action completed, but not the second, although he is not aware of it, believes the operation to be correctly and completely executed. The psychologist is not at a loss to explain the mechanism of these operations, which rests upon the laws of habit or the laws of association of ideas. When one of two actions or two perceptions, which as a rule follow one another, presents itself to our eyes, our mind is so constructed that the presence of the one act, or the one perception, irresistibly suggests the other. From the time we perceive the first act we suppose the second, because it is the logical consequence, or simply the habitual accompaniment. We do more than suppose it; we represent it so vividly to ourselves we believe we see it.

These explanations are more directly applicable to sleight of hand, which is the basis of prestidigitation. Sleight of hand consists in completely concealing an object in a sudden and brusque manner before the astonished gaze of the lookers on and in giving the idea that it was suddenly transferred to a certain place, when in reality it has not been removed. The prestidigitator takes an object in his right hand, a piece of cork, an egg, a piece of money, it matters not what, provided it can be easily handled. He holds the object up to view and then makes a pretense of slipping it into his left hand, and he imitates the action so cleverly that everyone present is persuaded that it is no longer in his right hand, but reposing in his left. Not only are they persuaded that he has made the exchange, but they fully believe that they saw him do it, and more than one will be willing to vouch for the truth of it on the testimony of their eyes. The illusion for those who do not know how it is done and have not attempted to analyze it is absolutely irresistible. It misleads not only children and ignoramuses, but grown men and renowned scholars. I myself have known men accustomed to scientific observation completely duped by these tricks. The savages, as Robert Houdin relates, do not escape these illusions any more than the civilized inhabitants of the globe, and they explain them to themselves in attributing to the prestidigitator a supernatural power. Even animals, we may add, are sensible of these illusions. I have frequently experimented upon dogs by juggling away sugar plums, which excites their interest sufficiently to make them attentive to the tricks.

The art of sleight of hand is not dependent upon caprice, but is governed by fixed laws known for more than a hundred years, and which can no longer be modified. Nowadays one learns to juggle just as to dance or to play upon the piano. The manipulation of the fingers is most complicated, and to be able to perform these feats without the assistance of a box, or a string, with only one's own dexterity to aid, is the highest aim of the prestidigitator. It is not only necessary to practice before the looking glass for days or weeks, it requires years to become an expert in this art. We do not consider it as straying from our subject in thus giving a rather minute description of this sleight of hand; the illusions which are the result are purely psychological. Many people believe the magician conceals the objects he makes use of in his sleeves; this false opinion has been frequently contested, but it is nevertheless tenacious. The truth of the matter is that apart from such experiments as the "vanishing cage," etc., the sleeves are rarely used by professionals. One of the most famous conjurers, Bosco, worked with his arms perfectly bare.

Almost every operation consists in retaining the object in one hand and making believe it is resting in the palm of the other.

It is necessary for a prestidigitator to practice a very long time before he becomes an expert in thus retaining objects in his hand. He begins by practicing with small objects, such as nutmegs, dimes, nickels, small corks, and afterwards with more voluminous objects, as billiard balls and eggs. There are different ways of retaining the objects in the palm of the hand with the hand open; and the professionals distinguish several different ways of accomplishing this feat. Sometimes the palm of the hand is alone used, and at others the first joints of the fingers. A nutmeg, for instance, can be held between the root of the middle finger and that of the ring finger, and there are many other ways; each one has his preference. The difficulty appears to be to slip the object supposed to disappear to the place where it is to be held. It is held up at first for the inspection of the audience between two fingers, and these fingers should move slowly so as to propel the object into its place of concealment.

The number of objects that can be held in the palm depends greatly upon circumstances; it varies as the objects are real or imitation, whether they are attached together by a cord, whether they have been juggled, whether the wand or a handkerchief must be held in the hand, or whether the hand must be open or be half closed.

In the trick that is called "hunting the pieces" (*la chasse aux pièces*), twelve pieces at one time are held in the hand, but the hand is almost closed. A good prestidigitator can hold in his hand at once five 5-franc pieces with the hand hanging loosely at his side in a perfectly natural position and with which he is able to gesticulate, "*couper le jeu*," etc. This being granted, we will now give a complete description of a feat of sleight of hand, chosen from among several varieties.

I borrow this description from Poncin, who is really the classical author of this art: "Take a regular juggler's ball (small size) between the thumb and index finger of the right hand. Bend the index finger, which will make it draw back and cause the ball to roll a little, which ought then to rest upon the first joint of the middle finger. Bring the ring finger inside the hand so as to make a greater space between it and the middle finger. Roll the ball with the thumb into the space, raise the ring finger, and the ball should be then just between the joints of the middle and ring fingers and near the roots of both."

This trick will never be perceived, because it is invisible to the audience, the back of the hand being turned toward them, and although the object is in the palm, the hand appears relaxed expressive of inactivity and repose. But what would augment the illusion considerably, and give it even an irresistible effect, is that while juggling the ball in the right hand we make a gesture as if placing it in the left hand; we then bring both hands together, describing a half circle if it be necessary to augment the distance, and therefore give more time to the securing of the ball in the palm, and as soon as the fingers of the right hand touch the palm of the left hand, we close the left hand, as if holding an object which we did not wish to let fall. This gesture suffices to make those looking on believe the object is really in the left hand; and the illusion will be all the more perfect if the artist shows himself a good comedian. Our advice is to repeat the act frequently before a mirror in order to become expert in its performance. Moreover, the effect of the act is increased by the words with which he accompanies it, his affirming that the object is in his left hand, the manner of looking at his left hand, and, in fact, his whole expression of countenance, all go to increase the force of the illusion. Of course it is necessary not to overdo it by putting too much zeal in the action of the hand, or wearing an unnatural expression of countenance, as this would only arouse suspicion in the minds of the audience.

There exists another artifice, to which we may have recourse to heighten the effect of the trick, which is for the artist to treat his audience to a little set speech he has all prepared for the occasion, and which has on the minds of the audience an effect most favorable to the illusion. If the artist announced beforehand that a nutmeg would disappear while he was bringing both hands together their eyes would become so fixed on the movements of his hands as to cause him no little embarrassment, and no doubt some among them would perceive the fraud. To throw them off the scent, he envelops the trick in a sort of mystery. He announces to them, for example, that by squeezing a nutmeg in his right hand he has the power to melt it, and cause it to evaporate and disappear; everyone present, of course, knows this to be impossible, but such is the power of the human speech that we are almost compelled to give our best attention to the act the magician announces he is about to perform, and in consequence we keep a close

watch on his right hand when he finishes juggling, but while he was juggling and making a pretense of passing the nutmeg into the right hand, when he was holding it secretly in the left hand, we had only looked on mechanically. This part of the operation remained in shadow, as it were; it is perceived in a semiconscious manner, as an act void of all importance, and the illusion that results becomes all the stronger, no one being aware of the exact moment in which it was produced.

All these details go to show that positive illusions produced by a pretense or feint have peculiar qualities of their own; the illusion is not a durable one, as that of the bent stick in the water—the false appearance lasts only for a moment. We would not say, while looking on at the performance, “I see the ball passing from one hand to the other;” we would say “I saw it; I am positive that it passed”—an illusion of memory rather than of the senses.

III.

We meet with another class of illusions in the tricks of the prestidigitators, to which we may give the name of negative illusions, in contrast with the preceding ones. The first and best examples of these singular illusions have been made known to us through hypnotic experiments. These illusions consist in not seeing, in not hearing, in not feeling, and which abolish the perception, be it either of an object or of a class of objects. We place, for instance, before the person hypnotized a real, material, tangible object. Suppose it to be a person assisting at the experiment; the subject is commanded not to see this person, and the command is sufficient to cause the disappearance of the person—of his becoming invisible, as it were. This last class of illusions is much more difficult to understand than the first. Authors have not given, it must be admitted, a perfectly satisfactory explanation of it. We do not know what is taking place in the mind of the subject hypnotized who is commanded not to see a person immediately in front of him. We have difficulty in understanding the process by which the person hypnotized, while being perfectly sincere with himself and not in any way “making believe” or endeavoring to play a joke, can arrive at that state of not being able to see a person immediately in front of him with whom he is well acquainted. Negative illusions are frequent in seances of prestidigitation; we will endeavor to ascertain how a person perfectly sane and in possession of all his faculties is prevented from seeing objects placed immediately before his eyes.

The objects from which it is necessary to divert the attention of the lookers-on vary according to circumstances. In certain feats it is a corner of the conjurer's table. In other tricks it is a goblet or a pack of cards. As a rule it is the hands of the prestidigitator himself, to which the too close attention of the audience must not be given. It must be

understood that it is not always an easy matter to escape the vigilant watch of the spectators. They come to the performance to see, and from the moment the curtain rises and the artist appears on the stage all eyes are riveted upon him, and as he is entirely surrounded by light, how is it possible to prevent the spectators from directing their attention to the particular spot where the illusion is to be produced?

To accomplish this the prestidigitator has recourse to a psychological law, of which he no doubt knows nothing, and which he has never heard explained. Prestidigitation rests on psychology. We have just shown how the law of association of ideas explains positive illusions. Those that come under the head of negative illusions are explained by this other law, which can be expressed thus: We have a tendency to perceive only exterior objects which attract our attention. All perception is optional with us; numerous sensations are constantly vibrating our organs of sense; we neglect the greater part of them, because they are of no interest; we fix our attention only on certain ones, the significant ones; these alone traverse the threshold of our mind; they become the objects of our reasoning, suggest to us past events, and play a part in our interior life. Although each one's individual attention is more particularly attracted by this or by that, for instance, this one is apt to be more observant of forms, that one of color, and so on, yet there are certain rules of perception which are general; a priori we can designate certain objects which command our whole attention and certain others which are only perceived with the corner of the eye and neglected and quickly forgotten. This uniformity of reactions before the same spectacles is known to prestidigitation and it profits by it. When it is particularly important that certain peculiarities of a trick be not observed, even in the broad light, matters are so arranged that the attention of the spectators is drawn to another point at the decisive moment or an appearance of insignificance is given to the act, which produces a relaxation of attention. The attention is thus distracted and deadened; these are the two principal means of rendering invisible a spectacle which is perfectly visible to all eyes.

The distraction of the attention will be easily understood by a few examples. When the eyes of all the spectators are directed toward the artist he may easily divert their attention to another point by himself looking in a perfectly natural manner toward this point; should he turn to the right all the spectators will obediently follow his gaze. It is understood, though, he must not turn too quickly; it is best to make the movement slowly and naturally. This is the A B C of the art. Should the artist wish to play a trick with the right hand let him turn toward the left; to conceal a movement made by the left hand he must turn to the right. Thus the attitude of his body indicates to the spectators in which direction their attention should be directed. The mere fact of speaking causes the removal of attention. Mr. Max Dessoir has already observed that when the artist takes up a pack of

cards all eyes are fixed upon his hands; let him speak and immediately every eye flies to his face and give his hands the opportunity of profiting by the occurrence to go through maneuvers which are witnessed by no one.

There is still even a surer method of diverting the eyes and attention of the spectators by performing some act which of itself will interest them or hold their attention. In tricks of importance some such movement is always arranged beforehand. For instance, an object is deposited in an impressive manner on the corner of the table, and the artist announces that this object will be used in the execution of the trick. Suppose it to be a hat through which he proposes to pass a handful of silver; irresistibly all eyes become riveted on the hat and do not see the hand which in the meantime lays hold of an object concealed behind the table in a secret pocket or drawer; or he announces that he will make an object appear upon a certain piece of furniture on which he taps with the magic stick and gives a little discourse similar to this one Robert Houdin delivered: "You all doubtless are aware of the power of the magic wand, with which one has merely to tap gently upon an object in order to cause to appear whatever one wishes; behold, for example, we will try to make it produce not here (he taps the table with the stick), but here (he taps his hand) a crystal ball; here it is!" His object in tapping on the table was to attract the attention of the audience to the table, so they will not see his hand which he places in his pocket for the purpose of getting the ball, which he keeps hidden in his palm until the desired moment. There is a simpler method of diverting the attention of the audience without using the magic wand, a mere remark on the part of the prestidigitator is sufficient. A prestidigitator writes me: "In a little discourse which I deliver with great seriousness, I exclaim, in designating a certain place at a distance from my table: 'Authentic pieces, which are not here, demonstrate with evidence——' At these words, 'which are not here,' the eyes of the spectators turn from me to look where I tell them there is nothing." The diverting of the eyes is still more certain and even necessary and fatal when the artist takes the precaution to perform some little interesting act. I borrow this novel example from Robert Houdin. The prestidigitator declares he is about to divide a glass ball in two. This ball, he affirms, showing it, is of pebble; it is heavy and very hard; but hard as it is he hopes to divide it. During this time he throws the ball up in the air and catches it in its descent to attract the attention of the spectators. "It would be an impossibility," observes Robert Houdin, "for the eyes of the audience not to follow it in its ascension."

In the same order of ideas we will cite some experiments which take place in succession, one after the other, in order to enable the artist to prepare the following experiment at the very moment when the whole attention of the audience is fixed upon the trick which has just been concluded.

In an amusing trick, called the birth of flowers, the prestidigitator makes bouquets appear in different objects, in his buttonhole, in a box, in a glass, in a hat; and at the moment that the flowers appear in one of these objects, and the audience is suffused with admiration and wonder, the prestidigitator profits by their attention being directed from him and places a bouquet in the next object to which he wishes to call their attention.

In fact, in many tricks played with cards in which it is necessary for one of the spectators to choose a card, it is customary to ask him a question which will necessitate his answering, and thus for a moment divert his attention from the hands of the artist. Mr. Arnould gives a curious example: "In a little trick with cards, which I have submitted to you," he writes us, "it is necessary for me to know the fourth card of the pack; everyone is looking at my hands; I am sitting down; there is no means of turning my body in order to conceal the movement I wish to make from the audience (the operation consists in gently raising the card in order to see its face); there is no pretext for my touching the cards. I hold myself in readiness and put this point-blank question to the spectator immediately in front of me: 'Can you count up to 60?' The person addressed of course looks at me in amazement, not exactly knowing how to take my question; the others in the audience, much amused, look in his direction; this all occupies about one second, ample time for me to look at the card."

The greatest variety of tricks can be played in this manner. We will leave it to the ingenious mind to discover new ones. The prestidigitator has very seldom to himself invent; the tricks he plays are like the classical pieces at the Theatre Français, accompanied by traditions which indicate in the minutest possible manner what is to be done at a given moment to remove the gaze of the spectators, and the means are so powerful that scarcely anyone escapes their influence.

Instead of diverting the attention there are ways of making the audience lose interest just when the most important and decisive part of the trick is being accomplished, and the means employed are numerous. In certain cases to hide a movement, it must be made brusquely, by surprise, so that no one would have time to prepare attention; the movement must be so rapid that the eye will have no time to follow it in detail. There are some interesting observations to make on the tricks of dexterity. Certain tricks performed by the hands appear as perfect enigmas when they are performed with great rapidity. Mr. Raynaly performed at our laboratory "*le saut de coup des deux mains*," and such was the rapidity with which he accomplished this trick and such the force of the illusion that after having seen him repeat it twenty times not one present could detect the secret. Mr. Raynaly held in his hands a pack of cards; he first made us notice that the bottom card was a face card, for instance, the king of hearts; when suddenly we perceived a slight movement of the hands and there before our eyes

the king was transformed into the ace of spades. There were four of us present—men accustomed to observation. We were dumfounded and absolutely unable to understand how it was accomplished. The disappearance of the cage was also performed for our benefit by Mr. Arnould. This trick also produced a most curious illusion, though not so forcible as the preceding one. We can not dispute the fact that the rapidity with which the movement is made is the cause of its invisibility. The proof is that should the artist consent to go through the operation slowly we would have no difficulty in detecting the mechanism. But at the same time it must be observed that the question is very complex. The invisibility is not dependent solely upon the short duration of the sensation received by the eye. Numerous experiments have been made in late years in order to measure the time necessary to perceive a letter or a color. The experiment has been made by placing the observer behind an aperture, the opening and closing of which can be regulated. To perceive and recognize a letter it requires some hundredths part of a second. In witnessing a trick the difficulty of perception is even greater than to recognize a letter or color, for we must be able to understand and divine the mechanism of an act often very complicated, as "*le saut de coup des deux mains.*" The time this operation occupies, though much longer than would be necessary for us to perceive a color (it occupies fifteen hundredths of a second), is not sufficient for the spectator to grasp it. There are, then, two causes which concur to produce the illusion—the rapid movements of the hands and the complicated and inexplicable character of the operation. From the time this second cause of the illusion is done away with the illusion disappears. The artists, whose names I have just mentioned, having been good enough to decompound their movements, I could afterwards, when they went through the trick with their accustomed rapidity, account for each movement of their hands; I saw the movement because I had learned to know it, and consequently I knew the exact points to which I should pay the most attention.

It is by considerations of this sort that we explain what I will call "the screen system." There are an indefinite number of tricks in which to render an object invisible we hide it entirely, absolutely, by placing it behind another object which forms a screen. At first sight it seems impossible that the spectators do not suspect the artifice. But they do not, as in everyday life we are constantly losing sight of the object at which we are looking, and we fill up these short eclipses of the object by a rapid reasoning; if, for instance, while watching a little child playing at ball we suddenly lose sight of its hand, it would seem ridiculous for us to conclude that the child had suddenly become one-handed. A detailed mental image which remains constantly alive completes the sensation and prevents our taking note of the gap. The artifice of the prestidigitator consists in taking advantage of such gaps; he surrounds himself with certain material conditions which, for a very short space

of time, hide his hands or the objects he holds, without our noticing the interruption in the course of our perception, and it is during these interruptions that the decisive act is executed.

Let us suppose, for example, that the prestidigitator in a certain trick wishes to substitute one card for another, which is called "filer la carte." To conceal this operation he proceeds as follows: He stands not behind the table, but in front of it, between the audience and the table, which of course necessitates his turning a little when he places the card upon the table. This slight change of position conceals his hand and enables him to change the cards. There are many secret movements made by the prestidigitator on returning to the stage after having been among the audience. His back being turned, it is very easy for him to substitute other objects for those confided to him. Often, also, the artist arranges matters so that at a certain part of the trick it become necessary for him to go to the other end of the hall in order to procure an important object, and during this time the substitution is made; sometimes, also, to give himself more time, he pretends to be eagerly looking for something which he has not in reality let fall. There is a trick during which pretended search a watch is wrapped in paper and placed in a double-bottomed box. Better still, the substitution can be made by confiding the object to an aid and then asking him for it again. For instance, it is a live bird with which we have just concluded a trick; we give it over to the "servant," telling him to replace it in its cage, and then, as if on second thought, we say, "No; hand me the bird; I wish to use it in a new trick." The aid, who has had his back turned for one moment, and, moreover, whose movements no one thought of watching, has made the exchange. A live bird was given to him; he gives in its place a dead one, and afterwards the spectators will be astonished to perceive the substitution, inasmuch as they fully believed that the bird had not been out of their sight. Another example of substitution similar to the preceding one: An object has been borrowed by the magician, which he wraps up under the spectators' eyes, and he wishes to replace it by a similar object—that is to say, similar only in appearance, as it is one of his "trick" objects which he has secretly placed in the crown of a hat. The prestidigitator says simply: "I place the object in this hat; or, rather, I will confide it to this person." In saying the first words he rapidly introduces the little object into the hat and takes out the one already there. He does the act in a careless, negligent way, even avoiding casting his eyes into the hat, and the consequence is that when he changes his mind the spectators are not aware of the secret action.

In many tricks it is convenient to hide the hand at times behind a screen or some other object. Should we wish to relieve ourselves of a handkerchief, for instance, which we have in our hand, we draw near an armchair and let the handkerchief fall behind it, without the audience knowing that the chair has for a moment hidden the prestidigi-

tator's hand and he has profited by it. The table which the artist uses is of the greatest service to screen his hands. This table is nearly always provided with a pocket and other contrivances on the side turned from the audience, in which the objects he wishes to make disappear fall without the slightest noise, and from which objects can be taken without the knowledge of those looking on. The prestidigitator passes his hand carelessly in making a gesture, and, without arresting the movement behind the table, takes the object from the pocket or relieves himself of it, as the trick requires. This process is so simple that it suffices to mention it to have it understood; but one would never suspect the services it can render. It is very easy when one has confidence in one's self to place the hand which holds the object unaffectedly on the edge of the table; one has only to open the fingers slightly and the object falls noiselessly into the pocket, and the trick is done. The simpler the means the less suspicion it arouses.

There are even cases when we may conceal an object as large as 15 centimeters in diameter. This object, which is called a "bullet," is of black hard wood; it is hollow, and has in it a little hole just large enough to pass the finger through. The bullet, which should be filled with all sorts of objects beforehand, should be surreptitiously introduced into a hat borrowed from one of the audience, in order that the prestidigitator may transform it into a horn of plenty. It is not an easy matter to conceal the ball on account of its dimensions; but the hat is used for the purpose of covering it and no one perceives it. Behold how Robert Houdin describes this classical trick: "The hat is held in the right hand with four fingers only, the middle being left at liberty. The operator goes behind the table, at the same time talking and gesticulating in such a way with the hand that holds the hat that the hand becomes reversed and placed a little above the ball or bullet. In this position the left arm is put forward on one pretext or another to take something from the front of the table. In accordance with this movement the body comes forward a little, and the right hand is lowered to the level of the table; the middle finger is then inserted in the bullet, raises it, and introduces it subtly into the hat." Necessarily the spectators can not suspect any of these maneuvers, which are made under the hat and which are hidden from them. A curious feature is that the spectators do not perceive that the aperture of the hat has been hidden for a moment, and the artist has profited by it to introduce something into it. Another manner of concealing objects frequently resorted to is in passing them from one hand to another. Should we wish to introduce a box, a puppet—no matter what the object happens to be—into a handkerchief just borrowed from one of the audience, the handkerchief is held in the left hand, the object is held in the right, and with a very natural gesture the handkerchief is passed into the right hand, or the object in the same way placed in the left. The gesture is so insignificant that it awakens no suspicion; and, on the

other hand, it is impossible for the spectator to see the trick, as the hand remains constantly closed.

The magic wand is of great service in tricks of this kind, as the very fact that the wand is in the hand is reason enough for the hand remaining partly closed, and therefore making it possible to conceal many objects in its palm. Moreover, the prestidigitator does not hold the wand in his hand all the time; when it becomes necessary for him to use both his hands in presenting an object to the view of the spectators, he lays his magic stick on the table; a moment afterwards he takes it up and raps with it as a signal that the illusion is about to take place. These movements appear to have so little significance that the spectators have not only neglected to look at them but they don't really perceive them. Nevertheless, they are decidedly important. In placing the wand on the table the prestidigitator relieves himself of the embarrassing object; taking up the wand, he possesses himself of another object. The lookers-on have seen nothing and suspect nothing.

IV.

The preceding analysis demonstrates how very difficult it is, even for an intelligent observer, to see everything that takes place in front of him. To see everything it is not only necessary to open the eyes wide, for the human eye is not like the photographer's plate, which reflects without discernment all the details of the reality. The mental perception of objects is subjected to influences which cause certain objects to be seen correctly, others not to be perceived, and still others which do not exist are so vividly imagined that we believe we see them. To complete our study we thought it would prove interesting to have recourse to photography, which to-day is the natural, almost indispensable, accompaniment of visual observation. Thanks to the cooperation of Mr. Georges Demeny, Professor Marey's clever assistant, we have not been compelled to content ourselves with one or two isolated examples. Mr. Demeny, with the aid of the new chronophotographic apparatus willingly photographed several tricks of prestidigitation. This apparatus, of which a description was given at the Academy of Sciences, is capable of taking as many as thirty instantaneous photographs of one movement; each one of these photographs is separated from the other by an equal space. The series of the experiment gives at the same time the form of the phenomenon and the length of time it occupies. It is well known that chronophotography has found numerous applications in the domains of physical and natural sciences. It is to photography we owe the analyzing of many complex movements which, on account of their rapidity, escaped the analysis of the eye, for instance, the flying of a bird, the different gaits of the horse, the step of man while running or walking, and in general, all physical exercises.

Two artists, Messrs. Arnould and Raynaly, consented to execute before the apparatus their very best tricks with cards and with juggling balls. We thus photographed "le saut de coupe d'une main, et de deux mains," "le filage," "le rayonnement," "la carte à l'œil," and also the vanishing cage, nutmeg, egg, etc. Each of these tricks, which occupies about a second, often less, was detailed by a dozen photographs. The egg trick, which takes exactly a second and a half, can be studied in a series of fifteen photographs, each of which is as complete in every detail as if the artist had sat for it alone.

On examining this photographic collection we are surprised at not finding the illusion so forcible as when the trick is executed before our eyes; in looking over, for example, the numerous pictures which indicate the position of the hands in "un saut de coup," we seize the mechanism of this complicated operation, but we can not understand how the illusion was produced. This series of photographs revealed to Mr. Raynaly, who had executed the trick, a detail which he had not perceived before. During "le saut de coupe," which he performs in about fifteen hundredths of a second, he places one of his hands in front of the cards to screen them from view; but the whole trick is executed with such rapidity that the spectator does not perceive this action, and, what is still more curious, the artist himself was not aware of it. The photographs of the artist juggling an egg has also curious results; one can follow attentively the successive attitudes of his hands in pretending to pass the egg from the right to the left. We have not for one moment the impression that the exchange has actually been made. We are even surprised to see that the pretended movement resembles the real movement only at a distance. Not in one of the pictures has the hand the natural movement it should have in laying hold of an object; the trick is done so rapidly that a gross imitation is sufficient to give the illusion. If the photographic proof destroys so completely the illusion, it is because it does away with all the adjuncts necessary for the illusion which we have enumerated: The rapidity of the trick, the little discourse given by the artist, the manœuvres which cause a diversion or a diminution of attention, etc. Thanks to photography, we can make a division between these elements of all perception which are so often confounded the one with the other: Brute sensation and the interpretation of the mind.

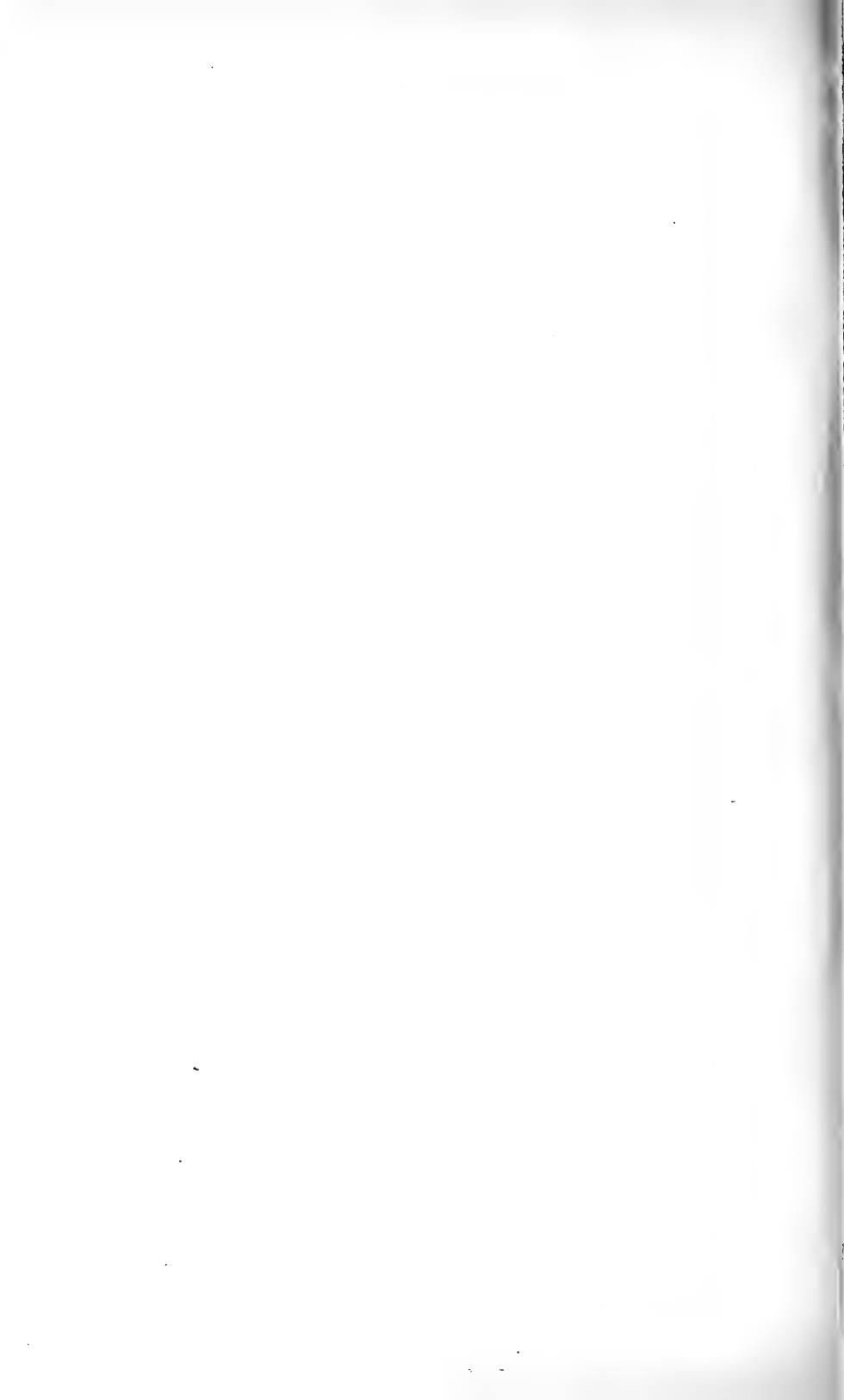

A DISCOVERY OF GREEK HORIZONTAL CURVES IN THE MAISON CARRÉE AT NIMES.¹

By WM. HENRY GOODYEAR.

Forty-four years have passed away since Francis Cranmer Penrose, then an architect just beginning life, published, with the aid and cooperation of the Dilettanti Society of London, his epoch-making work on the Principles of Athenian Architecture. It was, therefore, in 1851 that the world of science was first advised of a series of facts regarding the construction of the Parthenon and other temples of the Greeks which are still a perpetual source of wonder and of speculation to the specialist, to whose knowledge even the existence of these facts is still very closely confined.

The observations and measurements of Penrose were undertaken in 1845, and were completed in 1846 and 1847. Up to those years the Greek temple was supposed to be what to the superficial observer it appears to be. Its horizontal lines were supposed to be level and were consequently supposed to be straight; its vertical lines were supposed to be perpendicular; its corresponding and apparently equal dimensions were supposed to be equal, and its corresponding spaces and distances were supposed to be commensurate. To discover an exact mathematical ratio in its main proportions was the constant effort of the archaeologist. The mathematical ratios had not been discovered exactly; but this was thought to be the fault of the modern and not the fault of the Greek.

On a sudden the measuring rod of Penrose revealed that no two neighboring capitals or abaci of the Parthenon are of corresponding size, that the diameters of the columns are unequal, that the intercolumnar spacings are irregular, and that the metope spaces are of irregular width. His plumb line showed that none of the apparently vertical lines are really perpendicular. The columns all lean toward the center of the building. The side walls also lean to the center. The pilasters or antæ at the angles of the building lean forward. The architrave and frieze lean backward and away from the imaginary perpendicular. The cornice and the fillet between the frieze and architrave, as well as the acroteria and antefixa, have their faces inclined forward of the imaginary perpendicular. Finally, the main horizontal

¹ From *The Architectural Record*, Vol. IV, No. 4 (1895).

lines of the building are constructed in curves which rise in vertical planes to the center of each side, but these curves do not form parallels.

Three main facts appear throughout all these various phenomena: First, an unquestionable purpose and intention, whatever the purpose and intention may have been; second, an avoidance of all exact ratios in proportions, of all exact correspondences in the presumably equal objects, sizes, and spaces, and of all mathematically straight, mathematically perpendicular, and mathematically parallel lines; third, an avoidance of all such irregularities as are easily detected, or as are obtrusively conspicuous to the eye.

As regards the curves, they are inconspicuous to the eye unless sighted for from some one angle of the building and along the line of the steps, or of the exterior line of the stylobate (the platform on which the temple rests). As viewed even from such an angle, they are so delicate as not to be obtrusively conspicuous. As seen from other points of view, especially opposite the center of the ends or sides of the building, they may be detected by close observation, but there is no point of view from which the eye is not naturally disposed to discount the effect as one of perspective. As there are no straight lines, but only delicate curves when straight lines are viewed in perspective, it is natural for the eye to discount the effect of a delicate curve; for this is what the eye constantly does when the actually straight line is curved by natural perspective. As regards the appearance of inclination in the columns, we have the testimony of Mr. Penrose that he was months in Athens before he could determine by the eye without plumbing which way a given column leans, and this fact will describe the delicacy of other deviations from the perpendicular.

As regards the variations in size of presumably equal objects, or of spacing in presumably equal distances, it may be said that none of them can be definitely asserted to exist on purely ocular testimony, and that the surveyor's work is necessary not only to determine their amount, but even to determine their existence. Here again the difficulty in definite ocular detection depends on the fact that all objects of exactly corresponding size vary in apparent size according to the point of sight. Hence, when an element of delicate irregularity of size or spacing is artificially produced it is impossible for the eye to avoid discounting this irregularity into perspective effect. Let it be noted here that I do not use the words "perspective effect" as necessarily implying an increase in effect of magnitude. If a Parthenon capital nearer to the eye be smaller than one next to it, and farther away from the eye, the effect in so far would be to diminish apparent distance between the two capitals, but this would still be an illusive effect of perspective appearance, because the ordinary effects of perspective would prevent the eye from appreciating an exact equality of size if it had existed. Then, again, if a spectator be facing two unequal adjacent capitals at exactly equal distances from each, in which case they



TEMPLE OF THESEUS AT ATHENS.



GREEK TEMPLE AT EGESTA, SICILY.
From a photograph showing the curves of the entablature.



would naturally appear equal, the difference of size indicates to the eye a deflection in the line of the building, or, in other words, the spectator appears, in so far, to be nearer to the large capital than he is to the smaller one.

I.

We will now specify some of the maximum cases of irregularity according to the measurements of Penrose, which are given in feet and decimals of a foot. The curve of the Parthenon entablature on the flanks, about 228 feet in length, is 0.307 (decimals of a foot). At the sides of the building it is 0.171 in something over 100 feet. (The flattest curve in Greek art is the entasis of the Erechtheum columns, which is 0.0195 in 21 feet.) The Parthenon columns lean 0.228 in 30 feet, an inclination of one unit in 150 units. In other words, as the columns lean to the center of the building they would, if sufficiently prolonged in height, meet at a height of 5,856 feet above the level of the pavement. The antæ have a forward lean of 1 unit in 82, and the acroteria and the antefixæ have a forward lean of 1 in 25. A maximum deviation in spacings of the metopes is 0.325; the measurements of these spaces being 4 feet and over. The maximum deviation in intercolumnar spacings is over 2 feet, but this amount of deviation is only found at the angles where the columns next the corner are that much nearer the corner. At these points the spacings narrow from 8 feet and a decimal to 6 feet and a decimal. Aside from the angle columns the maximum intercolumnar deviation on the north flank is 0.136, in measurements which are all over 8 feet with decimal variations. A maximum deviation in the diameters of columns (of corresponding lines and sizes) is 0.23 in measurements giving diameters of 5 feet and a decimal. A maximum deviation in size of the capitals is 0.312 in measurements of 6 feet and a decimal.

These instances will give an idea of the amount of actual irregularities according to actual measurement, and we will add that instances of two adjacent measurements being equal are almost absolutely unknown. We can occasionally trace some scheme in the variations by comparing two halves of one end, or one side of the building, but when such a scheme appears it does not repeat itself in any two different series of measurements on one side or one end of the building. For instance, in the metopes of the east front the spaces widen from the angles toward the center, but this does not hold of the intercolumnar spacings, where the only perceptible scheme is that which makes the corner intercolumniations narrower by 2 feet and a fraction.

That all these remarkable deflections and irregularities were intended has been proven by masonry measurements and masonry observations. Penrose places the maximum deviation, due to error or carelessness in the Parthenon masonry, at one-fiftieth of an inch. The two ends of the building are of equal width within that fraction. The difference of 0.02 (inch decimal) in 101 feet points out "the degree of error which may

have arisen from inaccuracy of workmanship in the Parthenon." To quote his own words again: "In the measurement of modern or even Roman buildings an attempt to obtain the original measurements of considerable distances to the thousandth part of a foot would be fallacious, but in a building of the best Greek workmanship it can be done satisfactorily if proper care be taken to select such measurements as have been least exposed to the action of the weather, for, owing to the perfect jointing of the stones, the errors occasioned by any small shifts, which may have arisen from earthquakes or the violence of human agency, can be corrected most satisfactorily." To illustrate the refinement of masonry jointing he mentions the observation of Stuart that the stones of the steps under the columns of the Parthenon have actually grown together. "On breaking off parts of two stones at the joint he found them as firmly united as though they had never been separate." This is explained as due to molecular attraction of two surfaces ground together to a very smooth finish, on the principal which explains why two panes of glass may adhere to one another. For an account of the methods by which this wonderfully fine fitting and jointing were obtained, the work I am quoting must be consulted.

II.

Although the ultimate topic of this paper is the discovery of Greek horizontal curves in the Maison Carrée at Nimes, which I made in 1891, I have considered it necessary not only to include an account of the existence of the Greek curves themselves, but also a rather explicit mention of all the irregularities connected with them; not only because incommensurate intercolumnar spacings and leaning faces and members are included in my observations at Nimes, but also because the existence of the Greek horizontal curves is one of a series of facts whose startling significance and importance can not be wholly grasped until all of them are made known. This point again reacts on the importance of all observations which tend to supplement or accent certain explanations of any one set of these phenomena as against some certain other explanation. It will presently appear that my discovery at Nimes has the result of agitating the still undetermined purpose or purposes of the Greek optical refinements in masonry, and that it tends to minimize the importance of the explanations offered by Penrose in favor of those which have been offered by certain other students. It also, as we shall see, throws a strong side light on the probable Egyptian origin of the Greek curves, and thereby again tends to throw new light on their purpose on account of certain peculiar features of the Egyptian examples.

We will, therefore, draw nearer to my ultimate aim by degrees, and by considering in the next place the history of the discovery of the Greek horizontal curves, whose confirmation and detailed demonstration it was the great mission of Penrose to accomplish.



ILLUSTRATIONS SHOWING THE CURVES OF THE STYLOBATE OF THE PARTHENON.
From photographs.



The measurement of the horizontal curves was the greatest achievement of Penrose, but their existence was not his discovery, as many of the facts were which I have just enumerated. In all cases it is the measurements of Penrose which have established the facts as not being accidental and as being in masonry construction; but the observation which discovered the curves was made in 1837 by Mr. John Pennethorne, and in the same year and about the same time the curves of the Parthenon were noticed by two German architects, Hofer and Schaubert. These gentlemen were the first to publish the discovery in 1838. This publication appeared in a Viennese architectural journal, the *Weiner Bauzeitung*.

What is the peculiar constitution of the modern eye which had overlooked the existence of these curves till 1837? What is the peculiar constitution of the modern reader who had anxiously been conning his Vitruvius since 1500 without considering the passage in which this Roman author directs the construction of these curves? Why is it that when Wilkins made his excellent translation of Vitruvius in 1812 he added a footnote to the passage on the curves to say that "this great refinement suggested by physical knowledge does not appear to have entered into the execution of the works of the ancients"? Why is it that Wilkins did not do in 1812 what Pennethorne did in 1837—that is, test the author by the buildings?

Here at least are the facts. It is forty-four years only that the world of science has had the proper measurements of the Greek temples. Stuart and Revett had measured the whole Parthenon as far back as 1756. Lord Elgin and his workmen had had their scaffolds on it in the early nineteenth century, and yet the curves had not been seen. It was not even known until 1810 that the Greek columns had an entasis. This was the discovery of Cokerell, but he did not notice that all lines of the entire building exhibited a similar refinement. Donaldson discovered in 1829 the lean of the columns, but it was left for Penrose to discover the inward lean of the door jambs and forward lean of the antæ and the inclined faces of the entablature.

Let us, then, emphasize for a moment the discovery of Pennethorne as leading to all the later ones, and crowning all the earlier ones, and let us relate the way in which he made it. Mr. John Pennethorne, who was then a young architect, had first visited Athens in 1832, and he did not then make this discovery. In 1833 he made a trip to Egypt and was astounded to find in the Theban temple of Medinet Habou a series of convex curves in the architraves of the second court. On his return from Egypt he visited Athens a second time in 1835, again without observing the existence of the curves in Athens. It appears that after his second return to England the passage in Vitruvius attracted his attention. He says that he saw no reason to doubt the implications of the passage in Vitruvius, and thus was led to make a third visit to Athens and reexamine the Parthenon. Thus was the discovery made.

It should no doubt be added that the long sides of the Parthenon have lost the main central portions of their entablatures by the gunpowder explosion of the seventeenth century, and that consequently the curves can not be studied here. At the ends of the building, which are shorter, it is not so easy to notice the curve of the entablature. The most favorable location for the observation is on the long sides of the stylobate. Here, then, is the place to point out that this platform of the temple and also the temple steps had been covered by rubbish down to 1837, and that observations of the curves on their lines had been previously impossible in the Parthenon. But we may also point out that the Theseum at Athens has its long sides and upper entablatures intact. Here at least the curves might have been noticed before 1837. The curves have since been noticed in a number of other ruins which had been visited by students and measured before 1837. The laying bare of the stylobate of the Parthenon in 1837 assisted the discovery of Pennethorne, but it does not explain why some other student had not previously made the observation for the Theseum and for numerous other temples.

The reader will notice that I am working gradually toward an explanation of the fact that the curves of the Maison Carrée, in southern France, were not noticed as being in construction until 1891. We have a parallel fact for the Athenian temples. Those buildings had been studied and carefully measured for a period of over eighty years before their curves were noticed. In 1756 were begun the measurements of Stuart and Revett; in 1837 were made the observations of Pennethorne and Hofer.

What, then, is the explanation for the oversight of these phenomena in either case? Clearly there are two. The modern eye is dull and blunted as compared with the eye of the Greek. People look, but they do not see. But, above all, the effect is discounted by the eye. Whatever may have been the purpose of the Greek curves, there are only two possible effects. From certain points of view (it may be from all points of view) a perspective enlargement—from other points of view an optical mystification, if not a perspective enlargement.

We will illustrate the direct perspective effect of enlargement by assuming a point of view opposite the center of one of the sides or of one of the ends of the building. From such a point of view the lines will fall in perspective on either side, and as their change of direction is purely an optical effect, in which each point of the line changes position according to its distance from the eye, it follows that this line must be a curve downward in each direction away from the center. On this head we can have only one opinion from all experts in curvilinear perspective.

We will illustrate the optical mystification by assuming a standpoint opposite one of the angles of the building. I will not assert absolutely that there is a perspective increment from this position. It is my opinion that the already recognized principles of curvilinear perspective

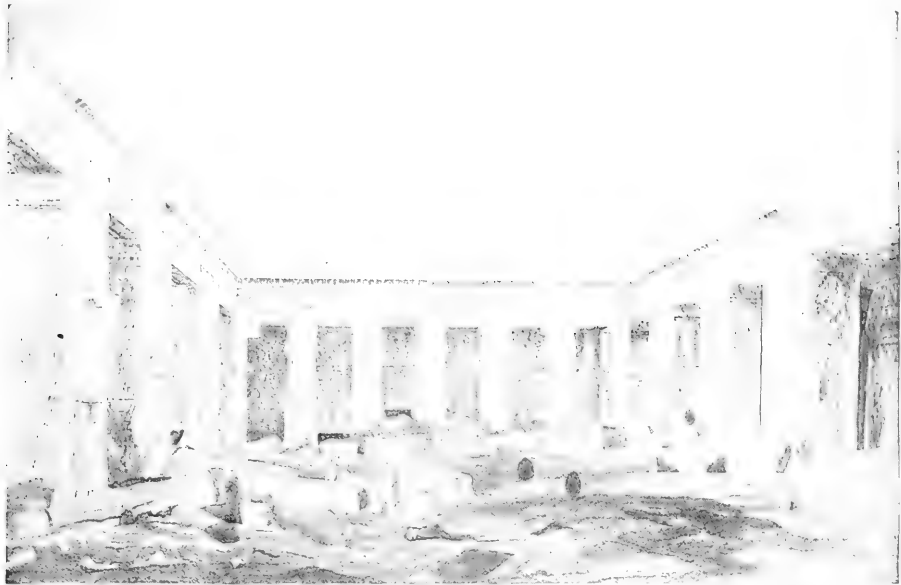

THE INNER TEMPLE COURT AT MEDINET HABOU.

From the drawing by Mr. John Pennethorne.

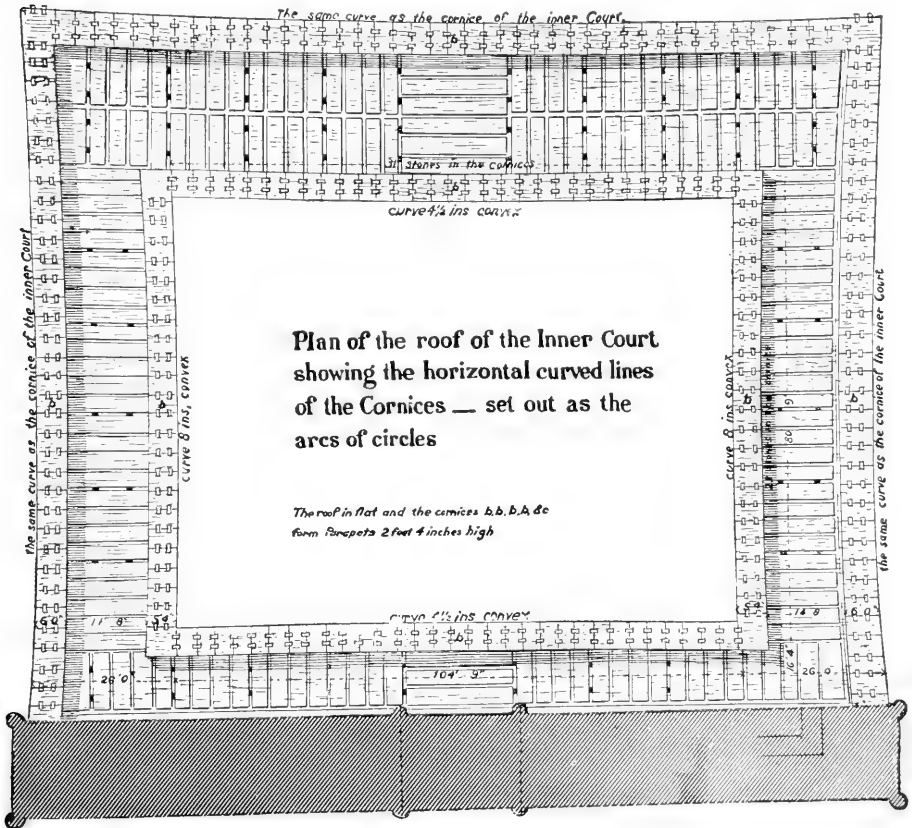

PLAN OF THE ROOF OF THE INNER COURT AT MEDINET HABOU.

may involve this position, but it would be a position so far not familiar to experts, and I prefer not to debate it here. I will, however, most positively assert that from the given point of view one of two results must follow, either a direct perspective increment, or else an optical mystification owing to the contradictory optical effects of two sets of phenomena—one of which effects is artificial, while the other effect is natural.

For our present purpose it makes no difference whether optical mystification or perspective increment, or both, are the results of the Greek horizontal curves. My present argument is simply to the end that in either case the effect is discounted by the eye. The cause is therefore not perceived.

We may therefore assign three causes for the long failure of the modern eye to detect the Greek horizontal curves: First, inferior sharpness of vision and inattention to art forms. It is admitted that Greek art and Greek taste were superior to our own. This amounts to admitting that the Greek eye was more acute and more highly trained. Second, the effects of the curves, whether they be perspective effects or simply mystifications, or both, tend to prevent the detection of the underlying facts and causes. Third, the curves are so delicate as not to be obtrusive to the eye under any circumstances.

We are prepared therefore to understand why the curves of the *Maison Carrée* have not been noticed sooner.

I have so far carefully avoided making any reference to the purpose of the Greek curves. I have only asserted that they have certain results, without debating the question whether these results were intended. It will now bring us nearer to our ultimate topic and aim if I announce my own observations for horizontal curves in Egyptian temples and connect them with those of Mr. Pennethorne, which I have mentioned for the Theban temple of Medinet Habou.

III.

It is, then, a fact to be once more noted that the discovery of curves in Greek temple construction was preceded by a discovery of curves in Egyptian temple construction and that the same person made both discoveries. It is also a fact to be noted that the curves of the Greek temples (as so far discussed) are curves in elevation, curves in the direction of the altitude, while the curves at Medinet Habou are curves in plane, convex to the line of vision. They are curves lying in horizontal planes as distinct from curves lying in vertical planes. It would appear reasonable, considering the growing conviction of scholars that Egyptian art and culture had in many important ways influenced the Greeks, that any theory as to the purpose of the Greek curves should be a theory which would also include Egyptian curves in its explanation, but this has not been the case, strange to say. The reasons for this are not only curious but they are also important to our argument,

Mr. Pennethorne's discovery of the curves at Athens was not immediately published by him, aside from a pamphlet printed for private distribution, nor was it published by him for many years. His own publication was delayed until 1878, twenty-seven years after the publication of Penrose, and forty-one years after his own discovery. This delay appears to have been owing to lack of encouragement in his special studies and to the abandonment for many years of his chosen career. He tells us that he took up the pursuit of agriculture soon after his return to England. Most curious of all, he did not know until 1860 that the curves which he first discovered had been measured by Penrose in 1846. It was not till 1860 that the work of Penrose published in 1851 came to his knowledge. It was not until 1878 that he announced the curves at Medinet Habou, and meantime all the theories so far made known as to the curves of the Parthenon had made their appearance and had been advanced without this important knowledge. Not only that; when Mr. Pennethorne did publish, it was in a book on *The Optics and Geometry of Ancient Architecture*, which costs a large sum (\$35), and which, being a specialist book devoted to Greek architecture, has apparently so far not come to the notice of one single Egyptologist. There is not a single book, guidebook or any book otherwise known to me, which relates to Egypt which mentions the curves at Medinet Habou. I have never met an Egyptologist who knew of their existence, and it appears to have been reserved for me to make the first observations and measurements for curves in three courts—at Luxor, in the great court at Karnak, and in the court at Edfou.

Mr. Pennethorne tells us in 1878 that he did not, when in Egypt, give the further attention to the subject and attach the importance to it which it deserved, but the temple at Edfou where I have observed the curves was not cleared out till twenty-seven years after Pennethorne was in Egypt. Down to 1860 this temple was covered by an Egyptian village. The courts of Luxor were not cleared out till 1891, the year when I was in Egypt, and no one could have previously made measurements there. As for the court of Karnak, it is still buried in rubbish and observations can only be made in an imperfect, but I think convincing, way on the lines of the architrave.

It is, however, a most significant thing that the curves at Medinet Habou are generally unknown in 1895 to the world of science and of travel. They amount on the short side of the court to 8 inches deflection in the architrave in a length of 80 feet 9 inches, and, on the long side, to $4\frac{1}{2}$ inches in a length of 104 feet 9 inches. They can be sighted on the roofs of the portico with the greatest ease and are most positively wholly constructive and not accidental, as already shown by Pennethorne. And yet I am acquainted with at least one very sharp-sighted architectural expert who has been in this court without noting the curves and I am acquainted with many travelers who have not noticed them. Is it not, then, clear that all these persons have discounted the effect of the curve? What this effect is for standpoints

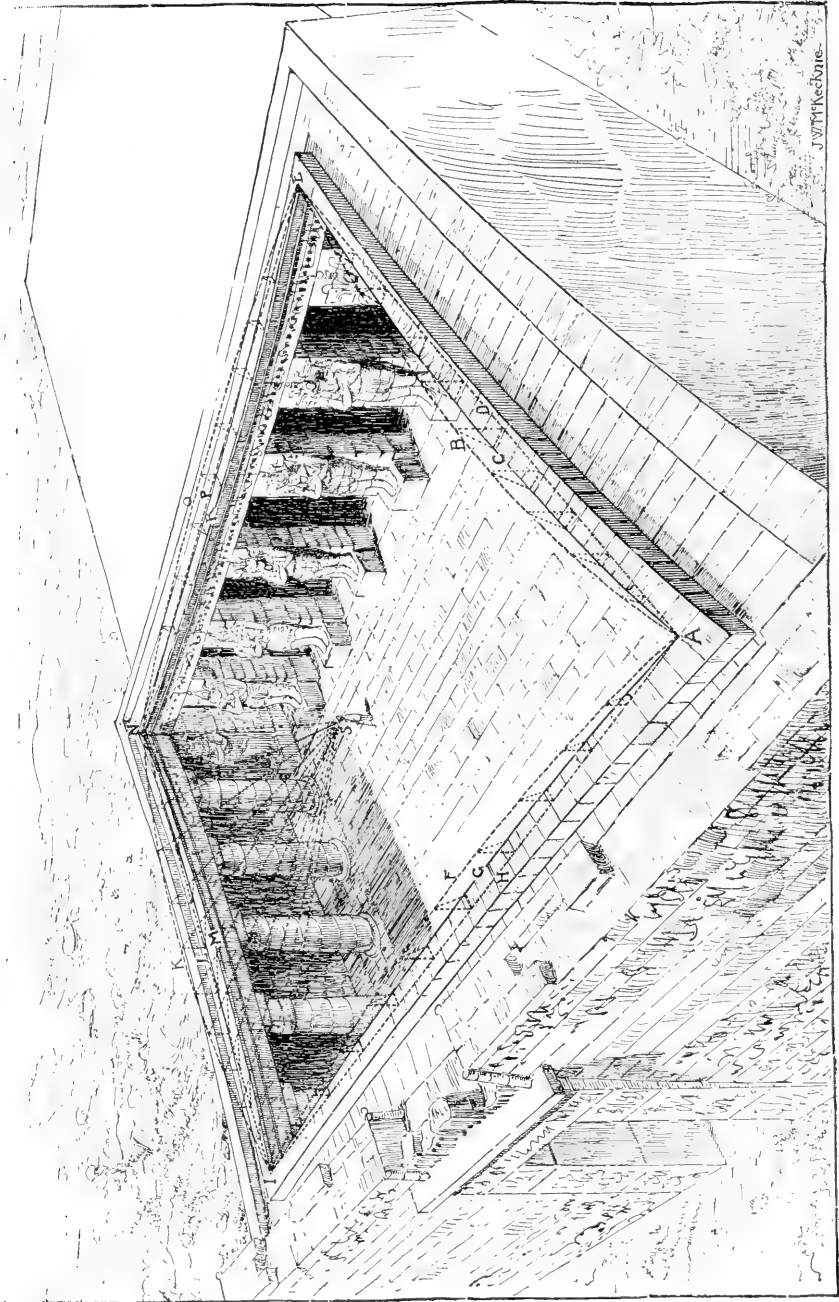

BIRD'S-EYE VIEW OF THE INNER TEMPLE COURT AT MEDINET HABOU.
The lines A, F, I, J, K, N; N, O, E, and A, B, F, show the optical effects of the cornice curves from various points of sight. Drawn by John W. McKecknie.

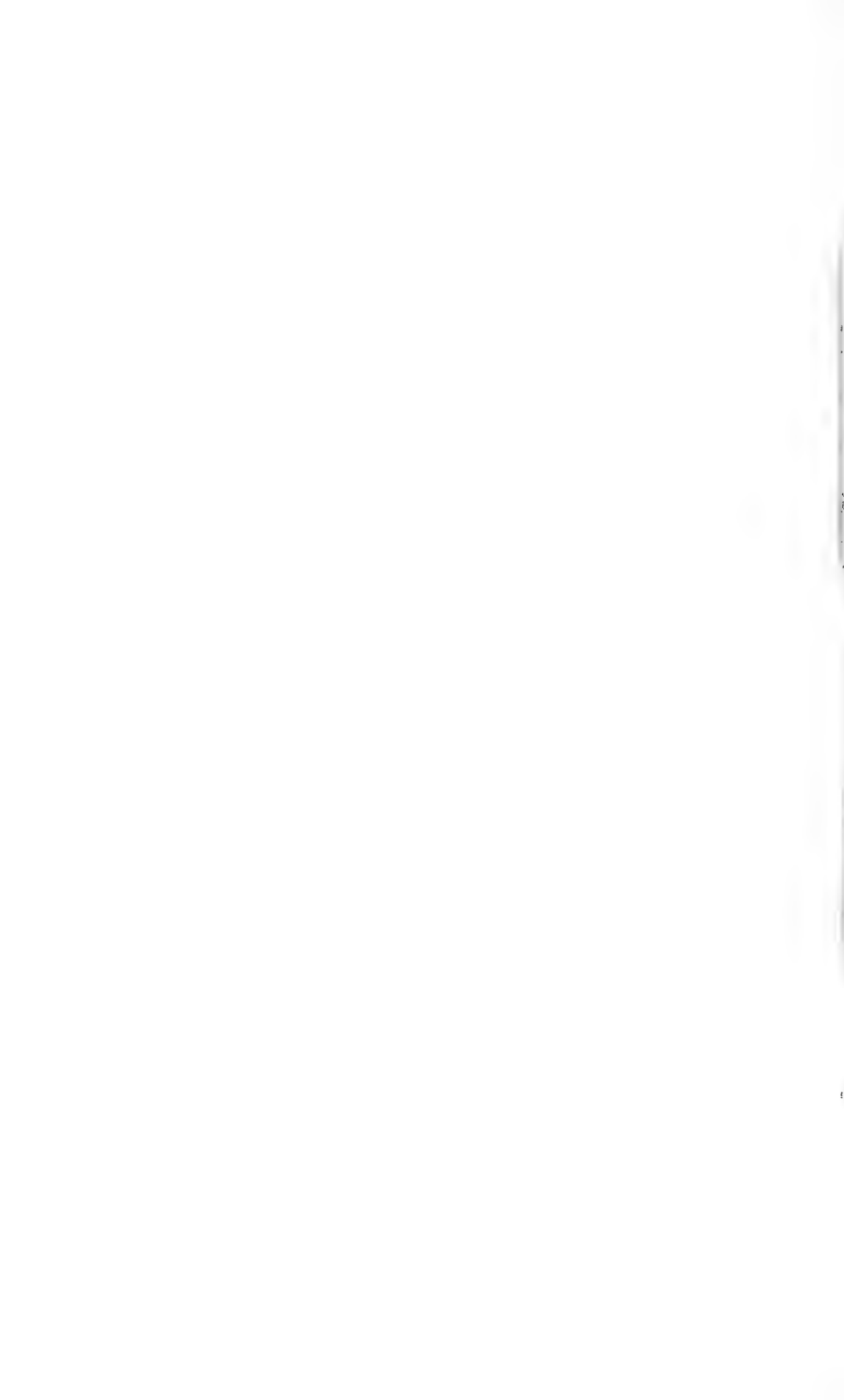

nearly opposite the center of any one side for that given side is indicated by one of Mr. John W. McKecknie's drawings herewith. This gentleman is an expert and instructor in perspective and the reader may be assured that there are no uncertain theories whatever involved in this picture. Remember, we are not debating whether the Egyptian architect intended this effect. We are not even debating at this moment whether the construction is accidental. We are concerned with the actual optical effect of the given phenomenon. All architectural lines which are curved in horizontal planes, convex to the position of the spectators, produce the effect of curves in elevation, as shown by the diagram. At an angle of 45 degrees, 8 inches curve in plan gives an effect of 8 inches curve in elevation. Inside the angle of 45 degrees, the apparent height increases rapidly and is something enormous on near approach, according to the dictum of another expert in perspective. In order to relate our text to the diagram we are speaking of points of vision opposite or nearly opposite the center of any one side of the court. In such a position the natural downward direction of the architrave in perspective is exaggerated by two causes—first, there is the exaggeration in height at the center; second, the receding line of the convex curve gives the effect of an extra downward bend to the line, as shown by the bird's-eye view.

There is a similar result from other points of view, possibly complicated by optical mystifications due to the contradiction between effects of natural perspective and the effects of artificial arrangement. The grand fact remains that a convex curve of 8 inches in 84 feet in the architraves at Medinet Habou has passed wholly unnoticed by an enormous number of modern travelers, and that it is wholly unknown to Egyptologists as far as I am aware. I should be able to name several such, and the absence of literary mention in books on Egypt, which are generally so quick to point to connections with Greece where they are obvious, is something phenomenal. I will not say at present that the Egyptian builder intended an optical illusion, but I will definitely say that he did produce one. Certainly not one man can gainsay me who has been in this court without perceiving the curves, and among those men is the leading perspective expert of this country.

IV.

All these explanations seem to me of value as helping us to understand why the convex curves in the architraves of the Maison Carrée at Nimes were not measured or noticed as in construction till the year 1891, when I had the pleasure of making this discovery. We understand, for instance, that scholars had studied and measured the Parthenon for all the years between 1756 and 1837 before its curves were noticed, and we understand that the existence of curves in plan in ancient architecture had been wholly overlooked, as distinct from the existence of curves in elevation.

No doubt an occasional student or observer has noticed these curves

in the Maison Carrée and set them down to the score of masonry displacement, a fact so common in old buildings that the first thought of every architect and builder would naturally be that the timbers of the roof had thrust out the cornice and that the curve was not in the original construction. This is why I took pains to arm myself, when at Nimes, with certificates from the official architect of the city and from his predecessor in office, the latter being especially familiar with the roof and upper masonry of the Maison Carrée, to the effect that these curves are in the masonry construction, although these gentlemen had not previously observed the fact.

Herewith are the certificates:

"The undersigned, Eugene Chambaud, ex-architect of the city of Nimes, after examining the curved lines of the Maison Carrée with Mr. Goodyear, has verified the existence of these curves as being in the said construction, with the proviso that the curve on the east flank has been exaggerated by a thrust of the roof timbers, but also verifying the fact that there has also been a curve on this side in the original construction, considering that the line of bases in the engaged column is curved on this side as it is on the other, and that there has been no thrust here; considering also that the movement (owing to thrust) is far from having been sufficiently great to produce the curve of the cornice. He considers the theories of Mr. Goodyear regarding the perspective effects of the curves as a reasonable one, and remarks that the theory regarding the perspective effect of a convex curve is new but possible. He has observed with him that the variations of intercolumnar spacing on three sides of the monument would undoubtedly have a perspective effect, according to Mr. Goodyear's ideas. The joints of the cornice on the west side where there is a curve of $11\frac{1}{2}$ centimeters, as measured by Mr. Goodyear, are intact with one exception, which is not important for the question of the curve.

"E. CHAMBAUD.

"NIMES, *February 23, 1891.*"

"FEBRUARY 20, 1891.

"The measures herewith have been taken with the assistance of Mr. Augière, architect of the city of Nimes. He witnesses to having observed the curves with Mr. Goodyear, and he verifies the fact that there has been no thrust in the cornice of the west flank. As professor of perspective he wishes to say that he considers the theory of Mr. Goodyear regarding the perspective effect of a convex curve in plan new but reasonable. As to the effect of a concave curve in plan it is familiar to experts in perspective.

"A. AUGIÈRE."

I must add that on one side of the Maison Carrée the curve has been exaggerated by a subsequent movement of the masonry, and that on this account I confined myself in measurements for the cornice to that side where the masonry is in thoroughly good condition. For measuring the cornice curve I employed tin roofers, who scaled the building by ropes and dropped a plumb line to the pavement below. The curves of the cornice, wholly due to masonry construction, are in horizontal planes convex to the position of the spectator, and measure about 5 inches.

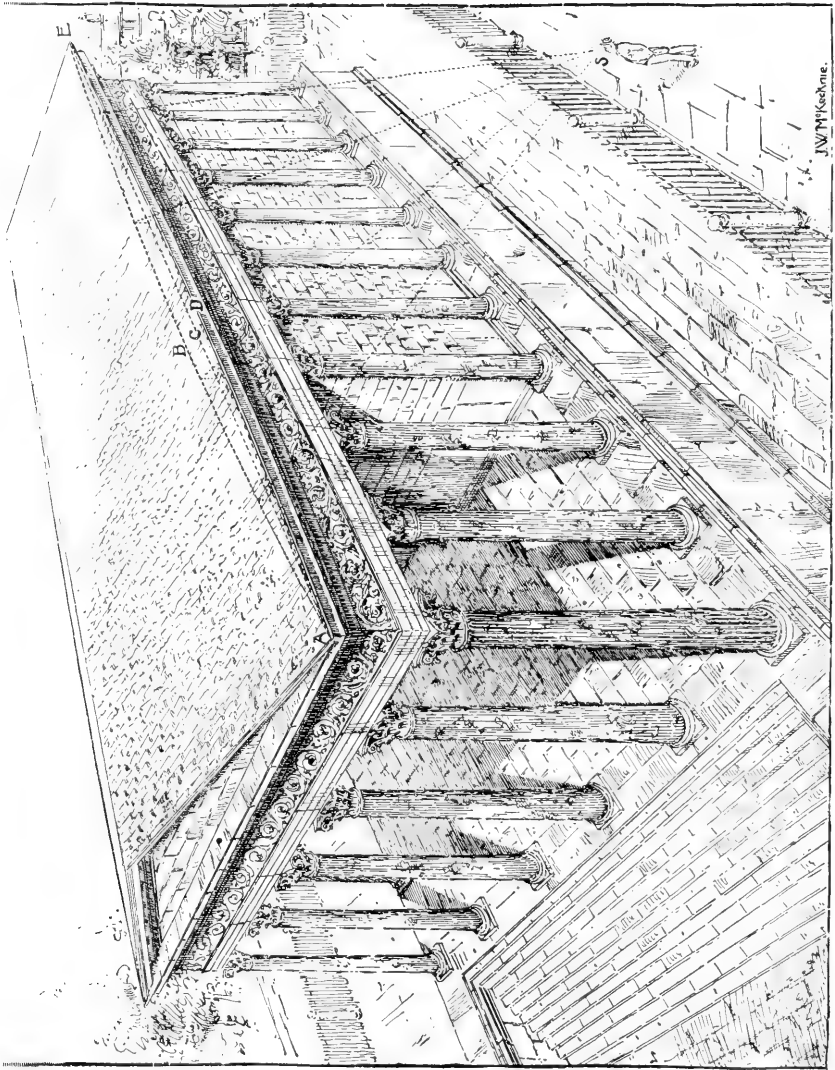

BIRD'S-EYE VIEW OF THE MAISON CARRÉE, SHOWING THE OPTICAL EFFECT OF THE CORNICE CURVE.
A, B, E, the actual curve; A, D, E, the optical effect from standpoint S. Drawn by John W. McKeen.



I also made measurements on the line of the stylobate which show slight corresponding curves in the line of the temple wall, and of its engaged columns along the plinth line. I have no hesitation in saying that even on the line of bases of the engaged columns resting on the stylobate there are slight convex curves in both temple walls on the long sides. It is also certain that the great increase of the curve above was obtained by leaning out the walls and engaged columns at the center.

It now remains to say what is the importance of this observation on the Maison Carrée: First, it overthrows the presumption of scholars that the Greek curves were unknown to the time of the Roman Empire, whose taste has been so far considered too coarse for this refinement. This observation, therefore, carries the history of the Greek curves from the time of the fifth century before Christ, down to the time of the second century after Christ. It extends the life of this Greek refinement seven centuries later than as previously known. Second, it reopens the question as to the purpose of the Greek curves. The explanations which have been previously offered must be revised or supplemented to some extent, because the explanations previously offered have referred to curves in elevation and not to curves in plan.

This brings us back to the explanations so far offered for the Greek curves. We have seen that the German architect Hoffer was the first to announce the Parthenon curves in publication. This was in 1838. Hoffer's explanation was that the curves of the upper lines were intended to accent and exaggerate the effects of curvilinear perspective and thus give increased dimensions to the building when seen from a point of view facing the center of either side, but he also considered them as giving life and beauty to the building, and as superior to the more monotonous and colder effects of mathematically straight lines. This latter view is the one which has mainly figured in the standard compendiums of the Germans; for instance, in those of Kugler, of Schnaase, and of Jacob Burckhardt. It has not been abandoned by the publication of Thiersch,¹ whose essay is the only contribution to the optical and mathematical questions involved, aside from those of Pen-

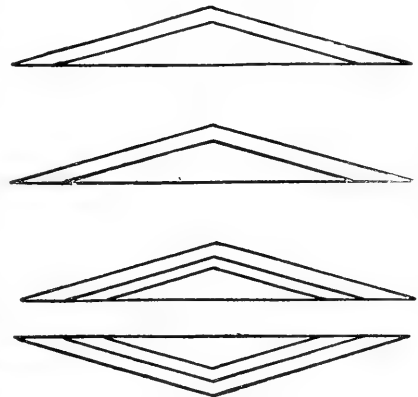

Fig. 1.

DIAGRAMS ILLUSTRATING THE OPTICAL DEFLECTION OF STRAIGHT LINES BELOW THE ANGLE OF A GABLE.

The upper line appears to be curved downward and is really straight. The line next below appears to be straight, but is, in fact, curved upward. In the two lowest diagrams the lines which appear to curve away from one another are, in fact, straight and parallel.

(From Thiersch, *Optische Täuschungen auf dem Gebiete der Architectur.*)

¹Optische Täuschungen auf dem Gebiete der Architectur.

rose and Pennethorne. Thiersch, however, in the main accents and develops the point of view of Penrose. The views of the latter as to the theory of the curves have naturally been most familiar to English and American students, and as his measurements are our only authority for the facts, his theories have naturally been generally accepted by his English and American readers. The explanation of Penrose moves from the accepted fact that there is a tendency to optical downward deflection in the straight line of an entablature below the angle of a gable or pediment. It is his theory that these lines of the entablature were accordingly curved upward in order to counteract this defection. As to the curves of the flanks, Penrose regards them as a consequence incident originally on the methods pursued for the entablatures under the pediments, and then adds:

“We may attribute the use of this refinement to the feeling of a greater appearance of strength imparted by it, to the appreciation of beauty inherent in a curved line and to the experience of a want of harmony between the convex stylobates and architraves of the front and the straight lines used in the flanks of the earliest temples. And further, if we may suppose the first examples of its application on the flanks to have occurred in situations like those in which the two temples above mentioned (*viz*: the Parthenon and Olympian Jupiter Temple) are built, the presence of a delicate, but not inappreciable curve in what may be considered as Nature’s great and only horizontal line may possibly have combined with other causes to have suggested its use.”¹

Although Penrose is distinctly of the view that the hardness and dryness of modern copies of Greek architecture are due to the absence of these refinements, his effort is in each case of the various refinements quoted at the opening of this paper to look for an optical correction as distinct from an optical illusion; and yet for the most important curves of all, *viz*, those of the long sides of the temple, he does not even suggest that an optical correction was needed.

We come finally to the views of Boutmy, *Philosophie de l’Architecture en Grèce*, 1870, who returns to and revives the idea of Hoffer of a perspective illusion, but still confining his explanation to an effect from one point of view, *viz*, that opposite to the center of the sides or ends of a temple.

Now, the importance of the observation of curves in the *Maison Carrée* is that they were not applied to the pediments at all, but exclusively to the sides. The theory of an optical correction is therefore insufficient, and the theory of a perspective illusion appears to be the only one left us; but this theory has never previously been announced as an explanation for the construction of curves in plan convex to the point of vision. It is, however, clear that all curves in plan convex to the line of vision produce an effect of curves in elevation. I am indebted to Prof. William R. Ware, of Columbia College, for the information that

¹The line referred to is that of the sea along the horizon.



THE MAISON CARRÉE AT NIMES.

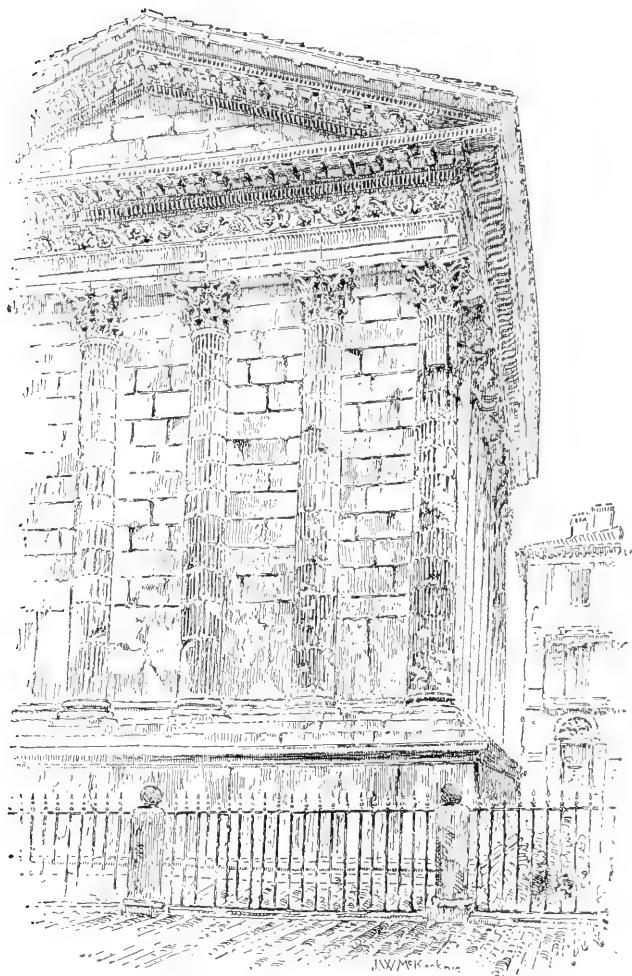

THE MAISON CARRÉE AT NIMES.

From a photograph taken for the author to show the curve of the cornice.

at an angle of 45 degrees a curve of 5 inches in plan, when not perceived by the eye, will produce an effect of 5 inches curve in elevation. From all points of view further removed the effect will be less, but the builders of the Maison Carrée and of the second court of Medinet Habou seem to have purposed to make this good by making the curves correspondingly heavier to begin with.

In the Parthenon the curve is under 4 inches in 228 feet. At Medinet Habou the heaviest curve is 8 inches in less than 100 feet, and at Nimes it is nearly 5 inches in about 100 feet.

To the above points we must now add the general revision in the attitude of archaeology to the question of curves in ancient architecture, which is probably involved in my observations for curves in plan in the courts at Karnak, at Luxor and at Edfou. The conservatism and habits of repetition in Egyptian art would under any circumstances make it

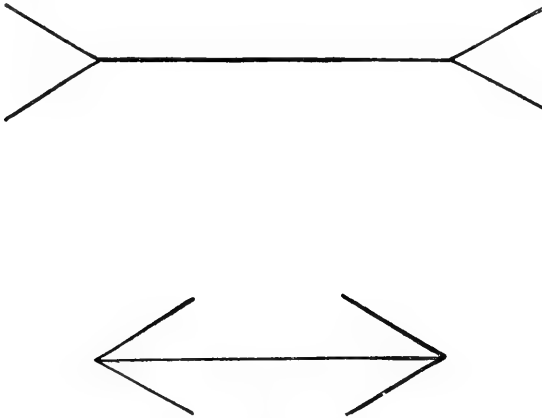

Fig. 2.

DIAGRAM SHOWING AN OPTICAL EFFECT OF INEQUALITY OF STRAIGHT LINES WHICH ARE, IN FACT, OF EQUAL LENGTH.

(By John W. McKeeknie, perspective expert.)

highly improbable that the curves in Egyptian architecture were confined to the one temple of Medinet Habou, but we have seen that, owing to the late announcement by Pennethorne (1878) and the general oversight by Egyptologists of this announcement, their existence even here is still generally unknown to science. A few words, then, as to my own observations in Egypt. My trip here was made in the interest of other studies and the subject of lotus ornament and its influence on Greek patterns. My measurements and observations were consequently hurried and imperfect. Still, here are the facts. Although the great court at Karnak is so filled with rubbish that one can climb in several places to the top of the architraves, I am able to announce, as far as these architraves are concerned, that curves convex to the court are visible. At Luxor the columns of the largest court on two sides have leaned forward so far as to threaten downfall and have been shored up

accordingly by beams during and since the excavations not quite completed in 1891. Measurements taken by me in all three courts at Luxor show curves in all lines of columns at the bases, all convex to the centers of the courts, varying from $1\frac{1}{2}$ to 7 inches. It is clear at Medinet Habou that the lower curves in the lines of the basis and in the lines of columns near the bases were comparatively slight and that the curve was obtained in the architrave and cornice (as it was at Nimes) by leaning forward the center column. This would explain the movement of the masonry which has required the column at Luxor to be shored up by timbers.

All earthquakes and other forces tending to disintegrate these buildings, such as pulling down and destroying the accessible parts of the temple, would tend to exaggerate the lean of the center columns and bring about the threatened downfall now imminent at Luxor. My observations at Edfou point the same way. On all four sides of the

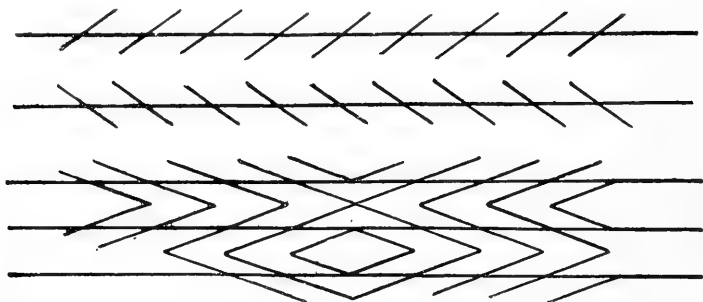

Fig. 3.

DIAGRAMS SHOWING AN OPTICAL EFFECT OF CURVES AND OBLIQUITIES IN LINES WHICH ARE IN FACT STRAIGHT AND PARALLEL.

(From Thiersch, *Optische Täuschungen auf dem Gebiete der Architectur.*)

court I have measured curves in the line of the bases of $1\frac{1}{2}$ inches on each side of the court. Very heavy curves—of 10 inches in one case—appear in the cornice lines, but the cornices have moved forward and the original lean of the center columns has been exaggerated by accidental tipping. The joints of the columns have parted at the rear, and it will require careful examination and survey at Edfou to show how much of the upper curve is due to movement of the masonry and how much is due to construction. One main fact remains to be mentioned for Egyptian temples. Although their curves have so far been utterly ignored and neglected, excepting by Pennethorne and myself,¹ the existence of other perspective illusions is admitted for Egyptian temples by Egyptological experts.

It is noted by a number of authors that the temples were generally built with pavements rising toward the sanctuary and with roofs grad-

¹I must make an exception for Prof. Allan Marquand, of Princeton, who has briefly noticed in the *American Journal of Archaeology* the discovery of Pennethorne at Medinet Habou.

ually lowered in the same direction, and that this was done for perspective illusion. Maspero is one of the authorities who mentions this. Mentions are also made of this by Rawlinson and by Prof. Reginald Stuart Poole.

V.

Although these various observations point to a perspective purpose in the Egyptian and Greek curves, I do not wish to appear to antagonize the view that optical refinements were used in Greek architecture to correct optical illusions, for I believe that they may have been so used; but I wish to point out that the theories which are confined to correction are insufficient to meet all the facts, and that the theories which have considered the creation of optical illusions to have been one purpose of the refinements are now materially strengthened.

The existence of a temple at Nimes having curves on the flanks without having them in the entablature of the pediments tends to antagonize the view of Penrose that the correction of a downward optical deflection below the pediment was the first cause of the introduction of the curves in Greek architecture. The temple of Neptune at Paestum is quoted by Penrose, in support of his view, as having only curves under the pediments, but strange to say, this temple at Paestum has been subsequently announced by Jacob Burckhardt to have convex curves on its flanks in horizontal planes.¹ This observation is also quoted by Thiersch. Thus I close my paper by pointing out that we have at Paestum one ancient Greek precedent for the curves in plan at Nimes, and that both point to Egyptian influence. The city of Nimes was settled by a colony of Alexandrian Greeks from Egypt. It appears therefore probable that the curves in Greece were derived from Egypt and had the same purpose, but that the curves in the Egyptian courts were generally changed to curves in vertical planes by Greek art. This was a more refined expedient for attaining the same end, less conspicuous in buildings using colonnades for exterior porticoes as distinct from buildings using colonnades for the interiors of courts. It is comparatively easy to sight for a bulging curve on the exterior of a building, but more difficult to sight for it in the interior of a court. I was not able, for instance, to sight for the curve at Medinet Habou without going on the roof of the portico, but at Nimes I was able instantly to sight for the bulge on the long sides from the level of the street. These facts, therefore, coincide with the view that the general purpose of the curves in Greek art was connected with the wish to have them inconspicuous, and that the curves at Nimes represent either a direct influence from Egypt or the coarser taste of the Roman period. On the other hand, the flank curves of the Neptune temple of Paestum, which is a very early Greek building, will represent the period of direct Egyptian transmission to Greece.

¹ Der Cicerone.

It is generally conceded that Vitruvius drew his matter from earlier Greek authors whose works have perished, and that he did not always fully comprehend the ideas of his sources. I have omitted any argument concerning his direction that the stylobate curves are to prevent an effect of "alveolation" (i. e., downward deflection) at the center of the stylobate. The only modern author who has attempted to explain this direction by optical theories is Thierseh. This author gives his reasons for supposing that a spectator standing near an angle of the stylobate and below the level of its platform might experience an optical effect of downward deflection in the lines of the stylobate which an upward curve would correct, but inasmuch as a bulging curve in plan could not correct this effect for the standpoint near the angle, I have not considered his theory in this paper, and I only mention it as giving one more illustration of the new light thrown on the Greek refinements by the discovery of curves in horizontal planes. There are very valuable remarks in Boutmy's work as to the general unreliability of Vitruvius for a comprehension of the Greek curves, and one purpose of this paper is to accent the value of Boutmy's contribution to the philosophy of Greek architecture. His work also contains quotations from Greek authors on the optics of architecture, showing that intentional optical illusions and intentional optical corrections were alike familiar to them.

There is one thing more to be said before I close. The credit for the original suggestion that there is a historic connection between the Greek curves and those of Medinet Habou belongs to Mr. Pennethorne, as does the credit for both discoveries. The wholly original part of this paper as regards historic facts is that which points to the fact that two classic buildings—one early Greek at Paestum and one late Roman at Nimes—show convex curves in plan which are identical in character with the curves in Egypt. The wholly original part of this paper as regards observations is that which relates to Nimes, Karnak, Luxor, and Edfou. The wholly original part of this paper as regards the effect of the Greek horizontal curves is that which shows the optical results in actual historic buildings of convex curves in horizontal planes. I am willing to leave the question of purpose to the expert and to the general reader.

THE METHODS OF ARCHÆOLOGICAL RESEARCH.¹

By Sir HENRY HOWORTH, K. C. I. E., D. C. L., M. P., F. R. S., F. S. A.

I should forfeit your good opinion of me if I did not confess to feeling embarrassed by the position in which, by your favor, I find myself. The honor and distinction of filling a chair which has been occupied by so many better men than myself is qualified with every doubt and difficulty. When I look round this room I see before me not only those gifted with greater knowledge than I possess, but who have had greater opportunities, and have not had the work which they love continually interfered with by manifold cares and duties. You will accept this as my apology for the disinterested and elementary remarks which I shall impose upon you.

In selecting a subject on which to address you I have felt it would not be profitable or interesting to merely index the progress of archæology during the last twelve months, nor to condense the county history of Shropshire into a necessarily dry and compressed guide to local antiquities which you must know better than I can know. I have thought it more profitable to devote a little time to considering some of the methods of archæological research, as they have been enlarged and developed in late years, and to condensing some of the more general conclusions that have been reached, and more especially to illustrate them from my own desultory studies.

The Archæological Institute has always been a most catholic mother. In her ample lap she has welcomed every kind of fruit which the cornucopia of research has poured out to illustrate the drama of human life. Her aim and object have been, as far as possible, to give a picture of the sometimes gay and sometimes gloomy procession which our race has formed as it has tramped along the avenues of time from the land of mist and cloud to the land of darkness. Every fact, however recorded, whether preserved in words or graven in the universal language with which the ruins of art are enshrined, has been welcome. It has taught the lesson that history means something more than philosophy teaching by examples; it means painting the pictures of the past, and piecing together the broken pieces which have escaped its heavy foot

¹Address delivered (as president) at the Shrewsbury meeting of the Archæological Institute, July 24, 1894, and printed in *The Antiquary*, London, September, 1894.

into a mosaic, in which we may see how our fathers lived, as well as what their aims and ideals were; how far they had progressed in making life tolerable and decorating it with sunshine, as well as unriddling the meaning of the terribly tragic chapters in which we read how mighty empires, in which greatness and glory were combined, and in which prosperity seemed anchored as firmly as one of the brave oaks of your own country, were leveled to the ground, their people slaughtered and destroyed, their palaces and temples reduced to dust, and their fertile fields once more occupied by the pelican and the jackal. It was once the custom to despise some of these lessons. The antiquary was a connoisseur, whose studies were dominated by taste and not by knowledge. To admire, to study, and to review the masterpieces of Greek art; to do the same with the masterpieces of the Italian renaissance—these were his aims, Phidias and Michael Angelo his ideals. It was only when the tide was flowing highest that it was deemed profitable to study it. Hence why the collection and the museums gathered in former centuries are so wanting in historic value. They represent the phases of taste as applied to the acts of other days, and the various measures and standards which this change of taste has created, sometimes inspired by nature alone, and sometimes by nature bewigged and bepowdered. We have advanced from this position. We have learned that the ebb as well as the flow of the tide is of supreme interest to us, perhaps of even more interest. Hence, while we admire and rejoice in some masterpiece like the Hermes of Praxiteles, we are constrained to devote a corresponding study to the rude bas-reliefs from the temples of Copan, and the ruder and more homely products of the old stone men.

We can scarcely realize that hardly a generation has gone by when, at the British Museum, it was the fashion to admit only classical antiquities as worthy of collection, and that the priceless treasures dug up by Faussett and Rolfe were treated as rubbish, unworthy of a place in that sanctuary of the arts, and had to seek a home in a provincial museum. Fifty years ago a man who had devoted his time, his purse, and his knowledge to creating a worthy department of British antiquities would not have been rewarded with the Order of the Bath, but would have been treated by the students of so-called high art as a barbarian and a phillistine, fit only to consort with people like you and me. We have changed all this, but its mischievous results still remain. If we go to the British Museum we shall find the noblest collection of Greek art in the world. Taken altogether it is quite unapproachable, thanks to the labor, the zeal, and the taste of many good men, and notably of the late and the present curators of that department. But when we turn to Rome—Rome, the mother of modern Europe; Rome, the Britain of old days, the great type of practical good sense in government; the Rome whose roads and bridges, whose colonies and towns, whose laws and municipal institutions are only rivaled by our own, and which ruled the world for a thousand years and more—where are we to

look for an adequate picture of the life her citizens led and of the vast colonial dependencies she controlled? We have a few busts; we have a room devoted to the antiquities of Roman Britain, and then we find the mistress of many legions and the mother of us all treated everywhere as a sort of Cinderella to her more favored sister of Greece, a mere outhouse and barn attached to a Greek palace. Our contention is that there ought to be in our great museum, if not a special department of Roman antiquities, at least special room devoted to them worthy of the fame of Rome and of its importance in human history. For many of us who love art, but also love history, it is quite as important to know what were the surroundings of Tiberius and of Marcus Aurelius as of Pericles and Alexander the Great. What is true of the earlier Rome is much more true of Byzantine Rome, the Rome of the Mosque of St. Sophia, the Rome which inspired St. Mark's at Venice and the glorious buildings at Ravenna and Spoleto, which shook hands with the East, and by this means wedded fresh ideas to those which were becoming stagnant. Because Gibbon entitled his work the Decline and Fall of the Roman Empire, we have acquired an entirely mistaken perspective in regard to the part played by Byzantium in the history of art. Byzantium lived, thrived, and flourished for a thousand years after the Goths had taken Rome. Nor are the code of Justinian, the histories of Procopius and Constantine, and the magnificent buildings dating from this time and scattered all over the Ægean, signals of decay and decrepitude, but the reverse; and yet where are we to look for an adequate collection of objects to illustrate Byzantine art, its rich barbaric sarcophagi, its enamels, silver plate, etc.

My object in naming these things is to point a moral. I am afraid the old Adam, if he be not still among us, has left his shadow behind, and there remains much for the great and powerful society to urge and to press. Archæology is the study of history by its monuments, and not a branch of aesthetics. Let us by all means guard our taste and accumulate the highest and best, but let us also be eclectic and catholic, and realize that the highest and best of all phases of art are of supreme value; and, further, that what we mean by history is not only the history of kings and armies, of great nobles, and great philosophers and of the arts they patronized, but also that of the crowd, by whose continuous labor the world has been, and continues to be, subdued, and whose homely and prosaic surroundings have a dramatic interest of their own. If this be one great lesson which the wider horizon of modern archæological study has taught us, another and an equally important one is that of the continuity of art. What Herbert Spencer and Darwin have pressed upon the students of natural history, we antiquaries learned long before in regard to art, namely, that there are no jerks and jumps in its history, but a continuous flow, and not only a continuous flow, but something more. It was formerly the notion that when art took an apparently new departure, and became rejuvenated

after a long period of stagnation, it was a spontaneous movement from within. We now know that in almost every case this rejuvenescence was due to contact with some new ideas which came in from the outside. A new graft into the old tree was the real source of better fruit.

Let us take some examples. When the Mongols, who were then masters of China, conquered Persia, they imported great numbers of Persian workmen, and the result was a complete change in the decoration of Chinese porcelain. The vases made by the Moors at Majorca and Valencia were probably the immediate daughters of the art fabrics of Egypt, and were certainly the mothers of Italian majolica. The blaze of flowers and ribbons which suddenly broke out this year in the hats and bonnets of English women, without any apparent motive, can be traced to the influence of a famous city on the banks of the Seine, where an explanation of the change is forthcoming. The Japanese are said to have lost their eye for color and form because their old art has changed recently for the worse. They have been, in fact, inoculated with European taste, as they have been flooded with European products. The story is apparently universal. We see the river come out of its mountain fountain and flow down blue and sparkling. Presently we find the color of its water change to milky white, and realize an explanation when we trace the new color to some affluent watering another soil which has come and joined its waters; and sometimes, as in the case of the Rhone after it enters Lake Geneva, the milky and the blue streams flow side by side, as the new bonnets and hats of every fantastic shape and color are mingled with older and more chaste designs on older and more sensible people. The great lesson of all this is continuity.

Again, to take another illustration from natural history, a lesson of these later times in archaeology has been that of "survival." We find all kinds of archaic survivals—in our speech, in our fairy stories, in our clothes, everywhere, in fact—crystallized bowlders of older strata of human life, which have been preserved accidentally in another matrix, and to those who are willing to read their lesson, reflecting unmistakable features of another time. When we see the Italian peasant going on pilgrimages to different altars of Our Lady to be cured of different human ills, are we not reminded of the similar practices in an age when Venus and her shrines were scattered over the same country, and each shrine had its own Venus, just as each altar has its own "Lady" endowed with different healing powers? How curious it is to go to a Kermis in some old Dutch town, such as Middleburg, or Delft, to see the women with their curiously shaped lace caps, and to be told that it is quite possible to distinguish the Roman Catholic families from the the Protestant ones, the distinction in the caps having arisen in the fiercer days of the sixteenth century. We may then examine the bags full of curiously shaped and colored cakes sold in the booths, and see the roundabouts and rude swing boats loaded with perfectly sane people, many of them 60 or 70 years old; and then turn to Tenier's great

pictures at Amsterdam, and see precisely the same cakes and the same roundabouts figured there! Are not the wooden houses colored with red ochre which dot the *Chrisenier* the very same as were introduced by the Dutch there in the grand old days of the Norwegian herring fishing in the seventh century? Are not the bull fights in Spain direct survivals of the exhibitions in the circus, no doubt introduced everywhere by the Romans, just as Spain was the most essentially Roman of all the colonies?

Have we not our own fossil customs everywhere? The aldermen and the common councilors of London when decked in their state robes might be living in the Plantagenet times, and the beef-eaters in the time of Henry VIII. The two ridiculous buttons at the back of our coats and the bands we barristers wear are useless relics of once useful garments, the one dating from the time when there was necessity for buttoning back the flaps of the long coats when George III was king and the other remains of the long collars of King James's time. Are not our judges' wigs directly traceable to the baldness of Louis XIV? These useless things, like the many useless and monstrous and offensive adjectives used by cabmen and sometimes by schoolboys, are mere survivals of things once usefully put on. The games played by the school children in the gutter preserve the ritual of primeval worship and the social customs of primeval times. Hence, as I have always urged, it becomes important and interesting not only to trace the origin of things, but also their final departure. Our dictionary makers are the most diligent hunters of the first usage of words. Would it not be wise if they were also to record the last use of the obsolete words, the dying flicker of a living light? The very fact we are referring to has sometimes perverted archaeological reasoning. Because the Shetland islanders still use stone lamps and cups, it does not follow, as some have urged, that a Stone Age in Britain is entirely a mistake. It only means, of course, that in remote corners the very old art has lived on, just as in the names of the old mountains and rivers the language of the earliest inhabitants has frequently been preserved. These touches of poetry in our very prosaic lives are as much fossil relics of an old historical horizon as the fossils which have been found by the German geologists in the far-traveled limestone boulders which strew their country, and belong to an age not directly represented in the solid strata of the district. The lessons we are discussing are notably prominent in the more recent works on philology, in which loan words and terms foreign to the language have been carefully sifted out, and we have thus been enabled to find not only the origin of many arts and customs but the stage and culture at which different connected races had arrived at the time when they separated. This we can do by comparing their common names for homely or other objects. The same with folklore, and the same with the rituals of different religions, all of them being among the most conservative institutions. This multiplication of avenues by

which to approach the thoughts and works of the old men has no doubt made our inquiry more complicated and difficult; but it has at the same time made the materials almost inexhaustible, and the possibility of solving problems once deemed insoluble much more hopeful.

Let us now turn to some of the concrete results which our more powerful analysis has enabled us to compass. In the first place, we have learned that it is a mistake to confuse art with race. We can not change our race—that is indelibly stamped upon us by nature. But art—art of every kind—including language, is not an inheritance from nature, but is as much acquired as are our hats and coats. We learn all our arts. Hence, we must be perpetually on our guard against the fallacy that because art has taken a new departure, therefore we are in the presence of a new race.

Archæology is a science which can only be profitably studied on inductive methods. Of this a very notable proof is the discussion on the "Origin of man," a subject upon which there was much speculation twenty-five years ago. It has not the same living interest for us now. The fact is we realize that materials are wanting at present to enable us to carry the study very far in this direction, and the newly fledged hopes of a quarter of a century ago have not fructified. The origin of the human race, so far as archæological research goes, is absolutely beyond our ken, and those who are determined to reach some result in this direction must go to the geologists for their facts and for their arguments. The moral for the archæological vista is this: We can take up the various specialized and elaborated civilizations which men have produced and trace them up to simpler and less specialized forms. We can separate the tangle created by their mutual influence upon each other, and trace the enormous changes due to the gradual introduction of new ideas and new processes, of new weapons and new tools. We can trace the complicated pedigree until we reach an age when all men used very similar materials and had very similar arts. The cramping influence of having to use these often stubborn materials compelled a monotony of form and of ornament which is in itself bewildering. Eventually we reach a stage where it is most difficult to discriminate among races or their characteristics by their art alone. For example, the polished stone axes left by the Caribs, those found in some parts of Europe and those found in some parts of eastern Asia, are almost indistinguishable. Yet, how widely separated these races are in every respect! We may thus be only too easily deceived in supposing that we are getting nearer to the solution of the problem of the origin of man when our goal is the inevitable one, that with his primitive weapons primitive man in many latitudes was constrained to surround himself with very similar surroundings. A corrective to this is very speedily reached when we turn to other fields of research, such as language and mythology, and physical constitution. We can trace back the languages of Egypt, of Babylonia, of India, and China for a long

distance beyond the occurrence of regular annals in those countries—back, in fact, to the Stone Age in each, and similarly with the mythology, and the result is that, instead of apparently reaching a common origin and common elements in them, the gap between them seems to get wider as we go further back, until we have to confess that if there was a common fountain to the various streams it must have been at a period so remote that we have no material at present by which to trace them to it. The men who wrote the *Book of the Dead*, those who wrote the *Epic of Sargon the First*, those who wrote the *Vedas*, and those who wrote the Chinese classics, if they were descended, as we believe, from common parents, must have been isolated from each other for a long period in order to become so differentiated at such an early date. These are only mere samples.

If we range further afield we shall find the same lesson meeting us everywhere. It is said that among the Indians of North and South America there are ninety languages spoken which are unintelligible to each other. The same problem meets us in the Caucasus, in Siberia, in Indo-China, and elsewhere. The existence of these languages is a perpetual warning to us to be careful of dogmatizing. How can we explain them except by postulating a long period, during which they have been gradually diverging from each other? We can not measure this period by any scale or measure. When we compare Icelandic with Norwegian, and remember how long ago it is that Iceland was colonized—when we compare the Mongol language, still spoken by the Buriats in Mongolia, with the language of the letters of the Mongol Khans written to the French kings in the thirteenth century, we shall have a measure of the slowness with which these changes sometimes accrue. If it has taken sixteen centuries to convert Latin into the various Roman languages how long has it taken for the diversion of the various Aryan forms of speech from one original language, and how much longer to converge the Aryan, Semitic, and other families of language upon a common mother? The very question is full of romantic difficulty, and assuredly we are a long way from any satisfactory answer to it. The evidence of language and mythology is supplemented and confirmed by that of the physical features of our race—features which seem to be so conservative and so difficult to alter. If we examine the very earliest human pictures which have been preserved in the tombs of Egypt we shall find representatives of the various races which then bordered the valley of the Nile, and we shall find that in the features and physique they are undistinguishable from the tribes still occupying the same districts. The Negro, the Nubian, the Coptic Fellaheen, the Semetic inhabitants of Palestine and Arabia, are there pictured as we know them now.

The earliest monuments of Babylonia similarly discriminate clearly the various types of men in Mesopotamia. It is so, also, with the early monuments of China, of India, of Mexico, and Peru, and of the borders of the Mediterranean, and this evidence of the monuments is

supported by the shapes and contours of the skulls which have been found in the earliest graves, and which show not merely sporadic variation, but variation affecting great classes. All this assuredly requires us to postulate a long period during which fresh changes were incubating and were being carried forward. We have no means of knowing how long this was. We can only very naturally conclude that since so little change has taken place during the last four thousand years in the languages, the customs, and physical features of so many different races, we must go back a long way if we are to explain the differences as they exist.

We have no chronology of any kind for these misty regions. Dates entirely fail us. In Egypt and in Babylonia anything like positive chronological data fail about 2500 B. C., while, as you know, the Bible dates are, before a certain period, not only based upon those of Babylonia, but they have been preserved in an entirely different shape in the Masoretic, the Samaritan, and the Septuagint versions, and there is no means of rectifying them. All we can say is that the Masoretic numbers, upon which Archbishop Ussher's chronology was based, and which was the basis of the calculation in the margins of our Bibles, are the least trustworthy of all, and can be shown to be sophisticated and altered. If I may be pardoned for referring to a work of my own in this behalf, namely, that which I have entitled *The Mammoth and the Flood*, I claim to have shown that all the evidences we possess—geological, paleontological, and archaeological—converges with singular force upon one conclusion, namely, that at the verge of human history there was a great and widespread catastrophe, which overwhelmed a large part of the temperate regions of the earth and which caused great destruction of men and animals. This widespread catastrophe has left its mark upon the traditions of many and widely scattered peoples. It possibly accounts for the isolation of many races in our own day, notably in districts without great natural frontiers, which isolation is due, in all probability, to the destruction of all intervening links between the various human colonies which survived. It is a remarkable proof of this catastrophe that whereas man is the most elastic of creatures in his capacity for facing and overcoming difficulties, there is, nevertheless, an absolute gap in his history in large areas in Europe unbridged by any remains or by any evidence. How are we to explain this? Once man has occupied the ground he is not likely to abandon it entirely and suddenly. Wherever we find one set of men driving out and superseding another, we have evidence of gradual change (of overlapping). In the hill forts of Dorset we have Roman remains mixed with those of Britons. In the Kentish cemeteries we have Roman remains mixed with Saxon. In the case before us, however, it is not only human art which shows a gap, but a whole fauna suddenly changes. Not a single mammoth or a rhinoceros has ever occurred with the remains of a domesticated animal. Since

there are no traces of a transition, it is clear one set of men and animals did not absorb the other. To myself this sudden hiatus and gap means the occurrence of some sudden and widespread catastrophe which desolated a wide area, and destroyed its living creatures in great numbers, and the recolonization of the wasted area by migration from elsewhere. To this great catastrophe the traditions of mankind go back, as do the geological reference we can collect. It forms the great divide in early human history.

We must not, however, be misled. Some wild writers have argued as if human beings were quite different in kind before and after the divide. I see no evidence whatever of this. The human skulls found with the remains of extinct animals by Lund in the caverns of Brazil have all the characters of Indian skulls, while those found with the extinct animals in Europe have the characters of European skulls, thus showing that at this period the native races of America and of Europe had already been differentiated, and it is extremely probable that the so-called paleolithic, or as I prefer to call them, the antediluvial men of Europe did not belong to one race, but to several races. Those who find certain resemblances to simian skulls in those of antediluvial man overlook the power of drawing shown in the etchings of animals on pieces of bone found in the French caves, which is quite unmatched in after times until we reach a much later period, while the harpoons, the needles, etc., are most skillfully fashioned. Whether the simian origin of man be a factor or not, it is clear we have no evidence in archaeology as yet to bridge the gap. If we want a key to the whole position we must turn our backs upon civilized man and explore the fertile fields of ethnography and the multiform types which we find among savage and semisavage races. Many of these have survived from the time before the great catastrophe, which did not in fact affect the Tropics. In these latitudes we can find abundant material to study, showing how man with very rude tools fashioned for himself very respectable surroundings. These various tribes of savages are generally ignored when we study history and archaeology. No greater mistake could be made. Assuredly they present us with survivals on a great scale by which we can measure and test the phases of human progress in its earlier stages, and some time, perhaps, we may be able to get them all into one pedigree, and to show how a real continuity combines them all. Two lessons of great moment we may learn from them. One is that all these varieties of language, of ornament, of dress must have taken a very long time to develop; and, secondly, when we come into actual contact with them we are struck by the further fact that they are desperately conservative. The so-called mug money which marks one of the very early chapters of our archaeological history still survives in northeastern Africa. The ornaments and the customs of ancient Egypt may be still found living in western Soudan and among the tribes of Ashanti, while, if we turn to Australia and Tasmania, we

shall find human arts still in their very infancy, and so far as we know and can judge, the arts of these races have remained unchanged and unaltered since those primitive times, when the Australians first introduced the dog into Australia, which means, when the Australian animals were still living, while we shall find among the very backward Bushmen and Eskimos a power of drawing animals, etc., comparable with that of the cave men, and languages remarkable for their structure and capacity.

A third lesson which we learn is that it is quite possible, and in fact an everyday occurrence, for two civilizations which have reached very different stages to coexist alongside of each other contemporaneously in the same area. The Australian and the Englishman live alongside of each other, as the Lapp and the Norwegian; nay, to come nearer home, as the gypsy and the sedentary Oxford professor; and we are led from this fact to the induction which has been too often forgotten or overlooked, that the same thing must always have been. We talk of a Stone age, of a Bronze age, and of an Iron age, and these are excellent terms when we apply them to some particular area like Scandinavia, to which they were first applied; but they are misleading when universally applied. Many savages are still living, or were quite recently, in the Stone age, the Shell age, or the Wooden age, like the Australians, the Marquesan Islanders, and the Indians of the Amazons, while alongside of them were living the emigrants from Europe, who were not only living in the Iron age, but had learned to harness steam to iron, and to multiply human labor tenfold. Not only so, but it is obvious in such cases that there may be a great jump in civilization from a very low to a very high step on the ladder without the necessity, or the possibility even, of intermediate steps. A Bronze age or a Copper age is not at all unlikely to intervene between the hewers of rude stones or of polished stones in the Pacific and in many parts of America and their adoption of iron; and, in fact, it may be said that the stage we sometimes associate with Paleolithic man (very wrongly, as I think), namely, that in which the Tasmanians and Australians lately lived, may be immediately followed by an Iron age. I say wrongly, because we can not argue that the men who lived in our prehistoric caves and were contemporaries of the mammoth, whose portrait they scratched on ivory, were the same race as the low type of men discovered in Tasmania. Diogenes was a philosopher, and not a dog, as he called himself, although he lived in something very like a kennel, and the men who invented and elaborated the Vedanta philosophy, although living with the simplest surroundings, are not to be measured with the untutored and unreclaimed wild hunters of the Kurdish Mountains, among whom the arts of life are at least as much advanced.

Let us now apply this lesson a little more concretely to the complicated story of human progress. If we take our archæological telescope and look back through the avenues of time, we shall reach a period

when the great civilizations of the world were still incubating, and when in Europe, in north Africa, and in Asia the many scattered tribes were living very much as we can see tribes living now in savage countries, some by hunting, some by fishing, and some, no doubt, leading a pastoral life. This stage in Europe and its borders is marked archæologically by what we call the paleolithic or antediluvian man. Some have compared him with the Eskimo, because the Eskimo, like him, has artistic instincts and can draw well, and because his surroundings are supposed to have been of an Arctic character. All this is very doubtful and, in fact, misleading. So far as we know, the cave man of Europe was completely exterminated, as his companions, the mammoth and the hairy rhinoceros, were, and has left no descendants. His remains as found in the caves are cased with stalagmite, which effectually separates them from their successors. The immigrants who succeeded them are recognized by their long, narrow skulls, by their employing domesticated animals and cultivated plants, and by their burying their dead in long barrows. Whence they came we can not positively say, but we may reasonably conjecture it was from some country where the animals and plants just named were indigenous in the wild state. In their graves in Britain no metal objects have been found, no tangled or barbed arrowheads, while the pottery is of the rudest character, marked by cylindrical shapes.

In one respect these long mounds present us with a puzzle. We can hardly doubt that among barbarous races few things are more likely to have been closely studied and more important than the ritual of burial, and yet we find the practices of burial and of cremation both in vogue. It has been thought that the two practices were, in fact, contemporary from the commencement. In this I can not agree. In the south of England burial was almost universal among the long barrow men. In Scotland, on the contrary, cremation; but Mr. Anderson has shown that even there burial seems to have preceded burning, and it seems to me that burning the dead bodies was distinctly an innovation introduced by the men who had succeeded those with the long heads, and that originally it was unknown among these men. Again, there is another curious distinction, which is apparently a superficial one. When stone was not to be had the bodies were laid in the ground in a more or less crouching attitude and covered in. Otherwise, chambers were built up of bowlders or other rough stones, which were approached by long galleries open to the outside, apparently simulating underground dwellings, in which whole families or clans were buried. These again were supplanted when the new men with round heads came in by stone boxes or cists closed all round, the introduction of which was, in general, coincident with that of burning, although there was undoubtedly some overlapping. Who, then, were these long-headed men? The early long-headed race of Britain has, according to fair evidence, left its trace in Europe in the long-headed, dark-skinned, black-

haired Basques, and in Britain itself they seem to have survived in the Silurians of Glamorganshire (described by the Roman writers) and in the small black haired people of south Wales and parts of Ireland. Traces of the Basque language have been said to be found in the Celtic languages, but this particular branch of the field has been hitherto very little explored, nor have the local place names in those districts where the race may be supposed to have survived. Here, then, we seem to have a clue which points to the men with the long heads having come from the southwest. The Basques have their nearest relations in north Africa, where a race which buried and did not burn its dead once occupied the country, whose remains are still to be found among the Berbers and the Kabyles of the Atlas range and among the Guanches of the Canary Islands. And these races of the Atlas take us on again to the valley of the Nile, where the early Egyptians are now recognized to have had close relations of blood, etc., with them, and who were, as you know, almost fanatically devoted to the practice of burial, as contrasted with burning in disposing of their dead. In this behalf it is curious to remember the distribution of the so-called cromlechs, which are merely chambered tombs of another form. They are found all round the northern part of Africa, in Spain, in the maritime parts of Gaul, and all over Britain, where they have not been displaced by the plow and harrow. They abound in Holland and occur again in Scandinavia, specimens of their primitive stock having migrated from west to east in Europe along the seaboard. This line of migration leads us to the Nile Valley as a goal, and it seems to some of us that the earliest inhabitants of that valley were first cousins of our long barrow men. There, under favorable conditions of a pure climate and access to the necessary tools and weapons of culture, there developed a race which, although unacquainted with metals, produced a wonderful culture—that of the Egyptians of the old empire.

We have as yet found no traces of a beginning of this culture on the spot, and until quite recently, when Professor Petrie has made some remarkable discoveries at Coptos, which may throw some light on this issue, we seem to have in the monuments of the fourth and fifth dynasty every kind of excellence we associate with Egyptian art fully developed, including its hieroglyphical writing, its strange mythology, etc., and all the while Egypt was still in what the Scandinavian antiquaries describe as the Stone age.

Whether this art was imported with the race which developed it in the Nile Valley, or was entirely indigenous, we do not know. It may be that it was the discovery of the ancestors of the tribes who are now represented by the Bishirins, Hadandowahs, and other wild tribes of the eastern Soudan, or by the Berbers of the Atlas range, who border the Nile Valley on either hand, and must have done so for a very long period. One thing seems clear, that for a very considerable period the art of the Nile Valley was isolated, and does not seem to have affected

that of its neighbors. To us this art is supremely interesting, because we can trace its progress step by step through manifold vicissitudes for four thousand years.

Let us now return again to our own country. The long-headed people here were displaced very largely by a race with round heads, who burned their dead and put their ashes in beautifully constructed urns, and then deposited them in stone cists or boxes in round or saucer-shaped mounds and not in long barrows. As we have said, there was considerable overlapping between them and their predecessors, who adopted in some cases their customs, including that of burying in round mounds or barrows. The shape of the skulls of these new men shows us what a profound racial difference there must have been between them and their predecessors. They apparently came from another direction, and with different surroundings. So far as we know, they were the first wave of that migration of tribes from the east which have successively followed each other in Europe, and are represented by the earlier Celts in central and southern France, and large parts of Spain, and by the Irish and Scottish Gaels, just as their art remains proved the round-headed folk to have mingled with their predecessors, the Basques. If we follow our maps eastward, and track the steps of those races who burned their dead, we shall find them linked step by step—if not by race by a certain relationship in their arts—to the early dwellers in Mesopotamia. There a similar development to that we all know so well in the Nile Valley, and likewise in the Stone age of culture, took place in the valleys of the Euphrates and the Tigris. Here, however, we seem to have evidence that the culture was not homegrown, but there are reasons for believing that the men who founded the earliest known communications with Chaldea brought with them the arts by which we know them from the Elamitish Mountains to the east, whence they seem to have sent colonies westward into Mesopotamia and eastward into China. This curious and most interesting induction is one of the most important discoveries of recent years. It enables us to link the culture of the furthest east to that of the west, and it also enables us to conclude that the arts are not the peculiar heritage of any one race, for here we seem to be compelled to admit that the foundation of that culture which we call Aryan or Indo-European is really to be traced to the now despised Turks and Finnish races. It was a race very nearly akin to the Turks and Finns which certainly invented the cuneiform writing, and apparently developed the earliest religious system in Chaldea. From this race it was directly learned by the Semitic races, whose original home was Arabia, and whose enterprise and vigor distributed them far and wide. One thing we must remember, that so far as our present evidence goes, the arts of Babylonia were as different from those of the Nile Valley as were the language, mythology, and the appearance of the people.

These Semitic peoples founded the successive kingdoms of Babylonia and Assyria, but it was the Phœnicians who were chiefly instrumental in multiplying and distributing the wares which the older men of Mesopotamia had made. They were to be found trading and trafficking everywhere from far-off Britain to far-off Thule, and still farther to that land of mist and snow where the griffons were supposed to guard the gold deposits of Siberia. Their settlements and trading ports were to be found all over the Mediterranean. These same Phœnicians were also great metallurgists, and if not the discoverers of bronze, which added so much to the resources of the early craftsman, they were so far as we know the great distributors of the knowledge of the making and also of the materials of bronze.

Let us revert once more to northern Europe, and notably to our own country. It was during its occupation by round-headed people that the use of bronze was first introduced here. Gold was apparently their own discovery, but bronze, I believe, was an imported art, and had nothing to do with the introduction of a new race. The bronze workers, as we know from the numerous hoards which have occurred, and also from the numerous molds which have been found, were traveling tinkers and metallurgists, such as the metal workers of Finland still are, and as the mediæval goldsmiths in Scotland were. The weapons, ornaments, and tools are of the same type, differing in slight details only from one end of Europe to the other, and showing that the art was spread over a wide area occupied by many races, and it seems to have spread from the Mediterranean lands, perhaps by the agency of those traders who took Baltic amber to Greece and Italy, and who in the first instance were probably the Phœnicians. It is curious that this bronze culture should have advanced to very different stages of style and elaboration in different areas. In Spain it advanced only to a small degree, as we may learn from the explorations of my friends, the brothers Siret; in England and France considerably farther; in Scandinavia and Hungary farther still, and I would suggest as an explanation that the reason is that in Spain and the western countries bronze was displaced by iron at an earlier date. Thus, while in Scandinavia we have no reason to suppose that iron was used until about the Christian era, in Britain it must have been used several centuries earlier. Thus the later and more developed bronze culture of Denmark and Hungary corresponded in age and was synchronous with the earlier use of iron in Britain, and probably also in Gaul and Spain, and hence it represents a later and more developed art. As I have said, the introduction of bronze was the introduction of a new art, and not a new race, and it is a great mistake for people to talk of the bronze folk as if they were something different to the men who used stone.

The next art revolution in these latitudes did, however, mean the importation of a new stock. This was coincident with the introduction

of iron. This problem as it presents itself in Britain, is one of the great puzzles of early archaeology, for it means a great deal more than the mere introduction of iron for the cutting of weapons and tools; it means the introduction of an entirely new style of ornament, a style of ornament apparently quite indigenous, consisting of the most graceful scrolls, known as trumpet scrolls, of endless variety and taste. Alongside of this we have the most wonderful skill in metallurgy. Nothing can exceed the delicate manipulation with which the old artificers fashioned the objects of manifold shape, and of entirely new designs—bone trappings, shields, helmets, swords and dagger sheaths, spoons, mirrors, etc., and the dexterous way in which they ornamented them with enamel, which they were, apparently, the first to discover and to apply. These objects have occurred in the greatest number in Great Britain, and in Ireland; but they have also been found in Belgium, in eastern France, and in certain parts of Switzerland, such as La Teue, etc., and it would seem, therefore, that they reached us by some migration down the Rhine. One important fact about this art is, that we know its relative date. We know that it was living when the Romans conquered Britain. The remains of the early Roman conquerors are found mixed with objects of this date in the hill forts of Dorsetshire, etc., and the descriptions of Cæsar apply to this chariot-eering people. Not only so, but it survived the Roman Conquest in that part of these islands untouched by the Roman Conquest—namely, in Ireland. The art of Ireland, until it was displaced and sophisticated by the Norsemen, was a mere development and growth of this art, and it is found abundantly displayed in the ornaments illustrated by Westwood in his work on Irish MSS. How long it has flourished here before the Roman Conquest, and at what date it displaced the art of the Bronze people we do not know. As I have said, this same art is found in the Rhine Valley, and in Switzerland; it is not found in Denmark and Germany, where the objects of the Iron age have an entirely different history. Nor, again, is it found in western France, nor in Spain, and the only avenue, therefore, by which it can have reached Britain is that suggested by my very acute friend, Mr. Arthur Evans, namely, the valley of the Rhine. In his original and suggestive memoir on this subject, he traces this art to Switzerland. There it seems to have incubated and developed itself in contact with the art of the Etruscans, with which at some points it has some analogy; but as a whole its inspiration is not Etruscan, but it goes back further to that primitive Mediterranean art which, for lack of a better name, we call Mykenean—the art of the Homeric poems. It is in the Mykenean objects that we find the same scrolls and the same dexterous manipulation of metal, and the use also of enamel. The distinction, of course, is that the use of iron has meanwhile been introduced. This, however, was only for cutting objects; the ornaments, the sword sheaths, the

shields, helmets, mirrors, etc., all continued to be made of bronze. The introduction of iron merely displaced the kind of metal, and did not affect the art.

To revert for a sentence or two, the people who developed and used this later Celtic art also used coins. These coins have been traced partially to the coinage of Philip of Macedon, large quantities of whose gold staters were probably taken back by the Gauls after their invasion of Greece. The gradual sophistication of these Greek models has been traced and followed out by Sir John Evans with his usual ingenuity and acumen. On another side we seem to have evidence that Druidism, which differed from the old polytheistic religion of the Gauls and Germans, which was related to the religions of Rome and Greece, was imported from the far East, and, having apparently reached Thrace, was carried back with them by the Gauls who had invaded Greece, and who thus acquired the notions of metempsychosis, etc., and I am not at all sure that the old notion of Godfrey Higgins, which has not had many adherents lately, is not true that Druidism was largely the outcome of the teaching of the Buddhist monks, who, we know, penetrated into Persia and Syria, as they spread their ideas and the artistic instincts of India all the further east from Japan to Java. But to return to Europe. The art I have been describing, which has been styled Neo-Celtic by Sir A. Wollaston Franks, who has done so much to illustrate it, was imported by a new wave of population, to which the name Belgic has been given, and whose original home was apparently in Switzerland and South Germany. This race is now best represented by the Welsh, but we must not forget that it also had large colonies in Ireland, where Neo-Celtic art became predominant and where it outlived the Roman domination elsewhere. In Great Britain, as on the Continent, this art was displaced, as so much of the art of the world was, by the Romans, itself a daughter of Greece. It is not my purpose to discuss such a well-known subject as Roman art. I would only point out to you how the newer school of archæology has shown that Roman art was very largely the art of the Roman provinces, and not so much Italian. Alexandria was a great center of the silversmiths' and other artistic metal work; Treves and Cologne and Lyons and Clermont of pottery, of glass, and also of metal work; and there can be no doubt that Greece, both continental and insular, continued to be under the Roman domination a fertile mother of sculpture, architecture, etc.

Rome was the great assimilator and distributor of these various provincial wares, as her language became the *lingua franca* of half the known world; her laws embodied and displaced other forms of jurisprudence; her generous Pantheon welcomed the foreign gods, and her military system mixed and mingled the natives of very different countries and climates. I would like to say, by the way, how necessary it is that we should have a complete survey of Roman Britain such as has

been so well begun at Silchester, and how much some of us long to see the spade put into your own Uriconium. When the Roman capital was removed to Byzantium new and fresh ideas were apparently developed, or perhaps old ones which had been localized there were distributed in all directions. In one direction Parthians and Sassanians drank at the well, and it is not possible now to say whether the embroideries, the damasks, the silver bowls, etc., which we associate with these Eastern people were Byzantine or not. In another direction the art of Byzantium spread all over the Teutonic world. The art we call Teutonic is really Byzantine. The tribes which were planted on the various frontiers of the Empire and were largely in its service and its pay were all directly indebted to Byzantium for their art. Hence, why we find the same art with slight local differences among the Goths of the Crimea, the Lombards in Italy, the Burgundians in Austria and Switzerland, the Alemanni on the Rhine, the Merovingians in Gaul, the Angles and Saxons in Britain, the Visigoths in Spain, the Vandals in Africa, and the earlier Scandinavians in Denmark and Scandinavia. The cloissonee jewelry, the interlaced dragon patterns, etc., all of which have such a common likeness, have an equally common likeness with the work which we can trace to the Queen of the Bosphorus; and as Lindenschmidt was never tired of preaching, there is no Teutonic art. The art of all the Teutonic tribes who founded the modern States of Europe was in reality the art of Byzantium, and this was so in later times also. The art of the Carlovingian Empire and of the later Anglo-Saxons was the art of the exarchate of Ravenna, just as the art of southeastern Europe, as preserved in the churches of Kief, was the direct daughter of Constantinople. The enamels, the bronze work, the ivories, the illuminations in books, the jewelry, etc., are all directly traceable to the same opulent mother.

But it was among the Arabs that the seeds of Byzantine art flourished and thrived the most. The Arabs themselves in regard to art were always a sterile race. Like their own sands, they do not seem to have had the instinct for art; but they had the instinct of government, and at Bagdad, at Cairo, and at Granada they founded communities which are as famous as any in the world's history. They had the Semitic instinct, too, for making money, and, having made it, for spending it freely as munificent patrons; but they initiated nothing. When we speak of Arab art we mean the art of Byzantium, which had a curious renaissance of its own under the impulse of fresh ideas gathered together from every wind of heaven by the enterprise of these Arab traders, who crossed all the known seas from China to the Straits of Gibraltar. Caesarea, Antioch, Damascus, and Alexandria, the mother of Cairo, were Byzantine cities with flourishing arts before the Arabs annexed them, and, so far as we know, the arts of Damascus and Cairo were the daughters of Byzantine art. The mosques of St. Sophia and of Omar were Christian churches before they became the models for the stately build-

ings of the later caliphs. Embroidery, pottery, and glass and metal working, including damascenert and bronze casting, all passed from Byzantine craftsmen to those of Arabia, and the chief development they received was in response to the injunctions of the Prophet against the making of graven images and of painted representations, which compelled those employed by the Arabs to devote their energies to developing conventional ornamentation and so-called arabesque work. Their contact with the Chinese and the Hindoos enabled them in pottery, and probably also in bronze work, etc., to supplement the lessons they learned nearer home with fresh lessons from the farthest East. Then came a curious phase. As is often the case in the modest life of our homes, the daughter, having outgrown her mother's teaching, returned some of the lessons, and in turn became the fruitful mother of new ideas and of new inspiration. From Egypt and from Syria art workmen found their way to Venice and Pisa and other Italian towns, and started men along new roads by presenting them with new models. The glass, the brass work, and the pottery of Venice, when Venice headed the renaissance of the industrial arts, were all the children of eastern workmen imported by the rich Republic. Another wave of Mohammedan art influence passed through north Africa into southern Spain and its islands. There the lustered wares known as majolica had, if not their origin, their great development, and thence they were transplanted to Italy. The fine tiles which the Moors made were widely imitated, as their azulejos by the Spaniards; and thence also largely came the astrolabes, the clocks, and other inventions which Arab science had produced.

One feature in the panorama we have hastily traced is obvious, namely, that it has been the nations and the peoples with great mercantile enterprise who have not only been rich enough to patronize but who have also been in contact with fresh ideas which have given art its new departure. The Flemings at Bruges and the Hanse traders all over the Baltic accumulated and developed ideas which they picked up at Novgorod and in the far-off districts of Perm, etc. On the other hand, the Venetians and the Genoese had their factories all over the Black Sea and among the isles of Greece. They shook hands there with the caravan traders from China and from the far countries of Siberia, and had to supply each other in return with objects suitable to their taste and needs. The Mongols were masters of the greater parts of the Asiatic world. Their ruthless conquests drove the artificers of Persia into India and into Egypt, and in either country a great rejuvenescence of the arts took place at the same time in the same style, and it is a most curious piece of history, as well as interesting in art, to compare the tombs of the caliph at Cairo with those of the Pathan sultans at Delhi. Then the Mongols themselves became civilized and settled, and their artificers crowded back and brought new ideas with them, and at Tebriz and Sullania erected buildings and decorated them in a manner previously unattained. Not only so, but

the great masses of workmen were transported eastward and westward under the control of the same exacting masters, and thus the designs on Chinese porcelain—phœnixes and dragons, etc.—invaded Persia, and similarly the Chinese learned how to make what we call blue and white porcelain, which they did not know until the time of the Ming dynasty.

To take one more illustration: We can not wander about the glorious ruins of your county—such ruins as Wenlock Priory—without being reminded of the sermon in every stone. We realize how much we owe to Gregory and to Augustine, who planted Christianity here, as well as to Benedict and St. Bernard, and their indomitable disciples and scholars, who reared aloft high standards of purity and simplicity of work and of duty in a community which was disintegrated under the influence of a barbarous soldiery and of brutal and uneducated manners. We are further reminded, as we can almost hear the jingling spurs and iron-encased feet of the knights tramping down the aisles, that it was the romantic enterprise of the crusading nobles, prelates, and monks which brought back the genius of Gothic architecture to Europe, and the taste for poetry, for sentiment, and for art, which they had learned from the Saracens, followers of Saladin, and it was very largely their handiwork that flooded western Europe with new ideas, which blossomed into magnificent forms in our ministers, and the equally fresh and novel ideas which Froissart and Chaucer and Malory enshrined in immortal verse and prose; and if we turn over the medal and look on the other side we shall realize the reflex influence of the crusades upon the East.

I do not propose to carry this disintegrated story further. My purpose and object have been to press home as a universal factor of human progress the element of continuity which we all concede in regard to particular cases, and also to press home the lesson that we can not do justice to our subject if we limit our horizon, as we are apt to do, to our parish, our county, or our island. These are only outlying pieces of much larger areas, and the true way of studying and profiting by the study of art is not only to be catholic but to be continually conscious of its interdependence and continuity. Lastly, one lesson let us carry away with us, lest we forget the humility which becomes the students of the venerable past. If it is true that we are the heirs of all the ages it is true also that the memory of much of our inheritance is blighted and sophisticated. It is not exhilarating to our vanity and self-respect to think that human progress is not a continual growth—that men reach levels very often which those who come after can not emulate. The men who built the Parthenon no less than the unknown architects of so many of our great ministers, the artificers who manufactured the lovely embroideries, the matchless tiles, the radiant decorations of the Alhambra and the Taj at Agra, have left no heirs, and we are mere scholars sitting at their feet. Our strength is not great enough to bear

the lamps which they carried in so many ways. Every generation of men, it may be, has its triumphs; yet it is not altogether reassuring to think that in the great meeting in the happy hunting grounds beyond the screen of night it will not be the nineteenth century which will occupy the foreground. Homer will still lead the procession of the poets, Socrates of the moral philosophers, Phidias of the sculptors, Raphael of the painters; and not only so, but we shall have to give place to many unknown and unchronicled masters of their crafts in the days of old. When that day comes I know not what I shall say to the archaeological giants, whose disciple alone I can claim to be, for my presumption in addressing you in this incoherent fashion, save to remind them that if the men of Shropshire have not all the gifts of their forefathers, they still command the virtues of patience and long suffering, of urbanity and kindness; and I may be allowed to conclude with the hope that the sun may continue to shine brightly on your homes—
Floreat Salopia!

THE ART OF CASTING BRONZE IN JAPAN.¹

By W. GOWLAND, A. R. S. M., F. C. S., F. S. A.

Late of the Imperial Japanese Mint.

The art of casting bronze has been practiced by almost all nations from very early times. In Europe at a remote period, long before the dawn of history, we have numerous examples of the skill of primitive man as a founder of bronze. Weapons of defense and implements of the chase are the chief specimens of his earliest work; but later, when other wants arose beyond the bare necessities for his existence, we find, together with these, objects for personal adornment and domestic or ceremonial uses.

In Asia the earliest practice of the art is shrouded in the mists of extreme antiquity. Certain bronze figures from Chaldea are attributed to a period not later than 2000 B. C., and, although of very archaic form and rude execution, indicate that the casting of bronze must have been followed in that country even for many centuries before that remote date.

In Japan the founder's art has a much less antiquity; it does not extend back to these distant periods; in fact, no remains of any metal castings, even of weapons of defense, have been found there approaching in age even those of the early Bronze period in Europe.

The Japanese do not appear to have migrated to the islands they now occupy earlier than perhaps seven or eight centuries B. C., and the aborigines whom they found there were totally unacquainted with the use of metals. Hence all objects of metal of the earliest times which have been discovered are Japanese, and are not older than that time.

The evidence afforded by tumuli and dolmens, and the remains found in them of the early history and civilization of the Japanese, demonstrates clearly that in prehistoric times there were two periods, which are more or less clearly defined by the progress which they made in the art of metallurgy, viz, a Bronze and an Iron age. The Bronze age begins with the immigration of the race, and terminates about the second century B. C. The Iron age then commences, and extends to the present time.

¹From the Journal of the Society of Arts, No. 2215, Vol. XLIII, May 3, 1895. Paper read before Society of Arts, London, April 23, 1895.

It is worthy of note here that the Bronze age and the first period of the Iron age are also characterized by two distinct forms of sepulchral monuments, the former by barrows, or simple mounds of earth, and the latter by megalithic dolmens and highly specialized forms of chambered tumuli. There is no evidence whatever of a Copper age preceding that of Bronze, but contemporaneous with the early Iron age, and up to the sixth or seventh centuries A. D., we find copper in more extensive use than bronze. Iron swords, trappings, and bits for horses, decorated with thin sheets of copper, coated with gold, are found in abundance, while objects of bronze are rare.

THE BRONZE AGE.

The castings which represent the early Bronze age in Japan consist solely of swords and arrowheads, the wants of the people then being evidently few and simple; and although objects for personal adornment were in use, they were made exclusively of steatite, jasper, quartz, or other stones. The swords are found in barrows or merely buried in the ground, and never along with objects of iron; the arrowheads, on the other hand, occasionally occur also in dolmens, associated with iron swords, and thus connect the Bronze with the Iron age. These bronze swords are undoubtedly the most ancient castings in Japan. They are simple two-edged weapons, resembling in form the short sword of the ancient Greeks. In some examples the blade is cast in one piece with the hilt, but in others with a tang, to which a hilt was subsequently attached. The mold was of stone and was made in two pieces. Illustrations of a mold and sword are exhibited. This is the oldest mold for casting bronze in existence in Japan. It was found by a Japanese archaeologist in use by some farmers as a hone for sharpening their sickles. (I may say here that on my visit to Seoul, the capital of Korea, I found stone molds in use for casting simple silver articles, the stone being an indurated tuff.)

I was unable to obtain any fragments or even scrapings of these swords for analysis, as there are but few existing, and they are highly prized, but a fragment of an arrowhead which I examined consisted of copper and tin, and did not contain lead as an essential constituent, and the swords are probably of the same alloy.

EARLY IRON AGE (FROM ABOUT THE SECOND CENTURY B. C. TO ABOUT THE SIXTH CENTURY A. D.).

In my explorations and studies of the remains which occur in the ancient Japanese dolmens and chambered tumuli I have always observed a marked scarcity of castings of bronze. Circular mirrors, small bells, and arrowheads occasionally are found, but they form an insignificant part of the contents of a dolmen, the chief objects being swords, arrow and spear heads, horse furniture, and other articles of iron, many of which are plated with thin sheets of copper, coated gener-

ally with gold and sometimes with silver. The bells, which are of the form called by the Japanese "suzu," are simple hollow spheres with a slit cut in the lower half, and contain a loose piece of metal or a small round pebble to serve the purpose of a tongue. They rarely occur singly, but are usually cast in groups on the edges of a flat support, furnished with a hole and tang for attachment probably to a staff or in some cases to the trappings of a horse. They appear also to have been used as ornamental appendages to garments and the hilts of swords.

Several plates illustrating their forms and use are exhibited. The mirrors are the earliest examples of art castings found in Japan. Many are decorated with very elaborate designs, and the excellence displayed in the execution of all denotes a very advanced stage in the art of molding and casting. Some are undoubtedly Chinese, and others are probably native copies of the Chinese designs, but not a few are of true Japanese workmanship. An engraving of a mirror bearing a date—the dynastic title Wangmang—9–23 A. D., is exhibited.

The five mirrors from the province of Higo, in Kijushu, shown in the lantern slide, are said by Japanese archaeologists to be of Chinese origin. It is impossible to assign an exact date to the older specimens; the curator of the Imperial Museum, Tokyo, attributes the Chinese forms to the period Han (25–220 A. D.), and I am inclined to agree with him in this attribution. Three specimens (Gowland collection, British Museum), which I obtained from the province of Yamato, were associated with "magatama" and other very ancient stone ornaments, and are probably not later than the above period. These are almost certainly Japanese. The simple geometric designs with which they are decorated bear no relation to the more elaborate patterns seen on Chinese forms.

The largest castings of the early Iron age are curious bell-shaped objects which are of special interest from their form and archaic ornament. It has been conjectured that they are temple bells, but they present no points of resemblance to these or to any instrument or object connected with the ceremonies or observances of Buddhism, and are, in fact, of earlier date than the introduction of that religion into the country. Moreover, none show any signs of having been hung. A considerable number have been found—always buried in the ground—chiefly in Yamato, Kawachi, Totomi, and the neighboring provinces.

As early as 669 A. D. the discovery of one is recorded, and this was even then regarded as being of such a great antiquity that it was presented to the Emperor. The designs with which they are ornamented—the simple geometric line patterns common to many primitive races—are also evidences of their great age. They vary in dimensions from 1 or 2 inches to $5\frac{1}{2}$ feet in height, those measuring 1 foot 6 inches to 3 feet being most common, and all are of extreme thinness compared with their size. Their exact use is still a subject of dispute among archaeologists.

The example shown in the illustration (Pl. LXIV) measures 4 feet 6

inches in height and 1 foot 8 inches in diameter at the base, and does not exceed three-sixteenths of an inch in thickness. It is an excellent casting, and must have been cast in a heated mold.

SEVENTH AND EIGHTH CENTURIES A. D.

Two events of marked importance in Japanese annals, on account of their influence on the development of the arts and culture, occurred during this period. Buddhism, which had been introduced about 552 A. D., had been adopted as the religion of the country through the energy and enthusiasm of Prince Shōtoku Taishi (593–621 A. D.), and a fixed capital and court had, for the first time in Japanese history, been established at Nara (709 A. D.). These two centuries form a brilliant epoch in the history of the art of bronze founding, as in that of the sister arts of painting and sculpture. Numerous temples—some on a scale of great magnificence—were erected for the services of the new religion, and the skill of both native and foreign workers in bronze was specially enlisted for their decoration, as well as for the production of statues of the divinities of Buddhism and of vessels for the ceremonies of its ritual.

Stimulated and supported by the priesthood in their efforts to produce objects worthy of the services of the church, the bronze founders achieved results in those early times which have not since been surpassed. Unfortunately many of their works have been destroyed by conflagrations and in the frequent spoliation of the temples during civil wars, but a few have been preserved which are masterpieces of the art of the modeler and founder.

Many tales record the enthusiasm with which the founders of the time were supported by their patrons and of the stubborn manner in which, after many repeated failures, they overcame the difficulties which beset them. The Empress Kōken (749–758) herself is said to have aided the founders in stirring the molten metal for a statue of a Buddhist saint, which was only completed after six unsuccessful attempts. The development of bronze founding and the encouragement of its artists during this period was entirely due to Buddhism, and even for many centuries later the chief works of the art founders were executed for the adornment of its shrines. The survival of most of the older bronzes is also solely due to the care with which they have been preserved in temples and monasteries by the priests of that religion.

Japanese records and traditions relating to the works of art of this epoch, whether of the painter, sculptor, or founder, invariably speak of the help afforded in their production by Korean or Chinese artists, and not a few of the ancient examples which survive are even attributed solely to them.

It is very difficult to determine how far these traditions relating to Korean artists are trustworthy, as no traces of similar works have been found in Korea itself; yet they all present such a close agreement on the point, that we are almost compelled to acknowledge that, if not

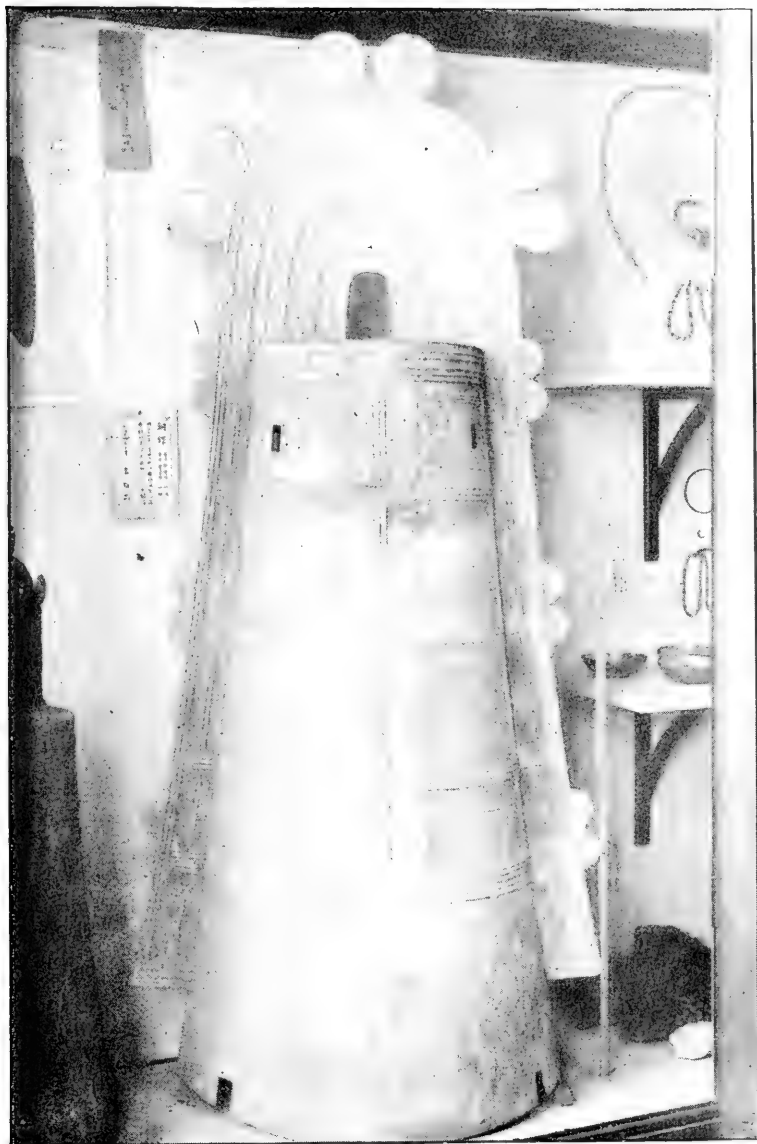

EARLY IRON CASTING.

perhaps true in the details they give of individual artists, yet, broadly speaking, they may be based on facts, and that the Japanese owe to Koreans, or probably rather to Chinese who may have come through Korea, the first great advances which they made in the casting of bronze.

Besides the influence which the neighboring countries—China and Korea—had on the technique and motives of the Japanese bronze founder, we have also abundant evidence of the influence of the art of more distant regions. Among the treasures of the temple Horyuji (near Nara, Yamato) are several Indian statues in bronze of Buddhist saints and deities, and a curious ewer, which are said to have been in the possession of the temple from the date of its erection in the early part of the seventh century. The characteristic pose of the figures, the modeling of their features, and their jeweled headdresses have been frequently copied with more or less modification, and can be distinctly traced in many ancient Japanese statues, as well as in some of comparatively modern times. The ewer, a bronze casting of graceful form, is decorated with figures of winged horses of the form of the Pegasus of the ancients. According to Longperier (Gonse, "L'Art Japonais") it is undoubtedly Sassanian and of earlier date than the seventh century. An illustration is given of it in the "Handbook" of the ancient articles in the temple Horyuji, which will be found on the table. This ewer is of special interest, as, by the kindness of my friend Mr. Alfred Cock, I am able to show you a bronze incense burner, which has been modeled probably during the last century from one of the pegasi with which it is ornamented. Other bronzes of foreign origin are also to be seen in the treasure houses of several of the ancient temples in Yamato.

During the epoch, especially that part of it which has been styled the "Nara period" (the seven reigns during which Nara was the capital, 709-784), the great development in bronze founding was not the only advance made in the working of metals, but the art of incised and repoussé work in gilt copper, which had been practiced during the early Iron age, was brought to a stage of perfection beyond which it has never passed. A specimen of this work will be found on the table, and others are illustrated in the colored plates near it.

The examples contained in the following list I have selected as representative specimens of the art of bronze founding during this period (seventh and eighth centuries).

Date 690 to 702 A. D.—Three bronze figures representing a Buddhist trinity—Amitâbha, Kwanyin, and Mahâsthâma—that of Amitâbha being about 9 feet in height. They resemble the Indian examples at Horyuji in being originally gilt, but the bronze of which they consist is of a different composition, not containing zinc as an essential constituent.

Date 690 to 702 A. D.—A colored seated image of Yakushi (the healing divinity), about 6 feet high, with two attendant deities, cast of a copper-tin-lead bronze.

All the above are in the temple Yakushiji in Nara. Illustrations of

the latter group are given in two plates from the Pictorial Arts of Japan, by Prof. J. W. Anderson, which are on the table.

Date 705 A. D.—A spherical box of gilt bronze, bearing this date, which was found in a stone sarcophagus at Ten-ō-ji, near Osaka, is interesting, as it is probably the oldest dated piece of Japanese metal work in the country.

Date 708 A. D.—Bronze coins, "Wadō-zeni," the earliest coinage in Japan of which there is any record. According to Japanese histories copper is said to have been discovered in the country only in 698 A. D., but the accuracy of this statement, for many reasons, is open to doubt, and the discovery chronicled doubtless only relates to the finding of deposits of ore of more than usual extent and richness. The issue of this coinage, which was cast from copper from these deposits, was regarded as an event of great national importance, and to commemorate it the "nen-go," or name of the period by which the series of years are distinguished in Japanese chronology, was altered to "Wa-dō," which signifies Japanese copper. Besides these there were three other distinct coinages during this century.

Date 732 A. D.—The great bronze bell of the temple Tōdaiji, in Nara. Its approximate dimensions are, height, 13 feet; diameter, 9 feet; thickness, 8 to 10 inches. Its weight can not be easily determined, as its thickness is variable, but at the lowest estimate can not be much less than 40 tons.

Date 749 A. D.—Colossal image of Rochana or Vairochana, in the temple of Tōdaiji, commonly known as the Nara Daibutsu.

This is the largest bronze figure in the country. It has not, however, been cast in one piece, but is constructed chiefly of numerous pieces of comparatively small size. Some of the lower portions have been cast by building up the mold on the parts already finished, but the greater part of the image consists of separate castings, which have been united by running in an alloy containing large proportions of tin and lead between their edges.

The following dimensions are those given on a wood engraving of the image—one of which is exhibited—sold by the priests of the temple, and may be considered as only approximately accurate: Height, 53.2 feet; breadth of face, 9.4 feet; length of eye, 3.9 feet; thickness, variable, 3 to 12 inches.

The figure is seated on a huge lotus flower with fifty-six external petals, each of which measures 10 feet 6 inches by 6 feet, and appears to be a single casting. Twice it has been partially destroyed by conflagrations and once by an earthquake. The present head, cast in the sixteenth century, is extremely ugly, destitute of any trace of the grace and refined expression of the earlier statues, and not at all in harmony with the ancient parts of the figure.

The authorities of the temple state that the image is composed of "shakudo" (a copper alloy containing gold). They also give the weights of the copper, tin, gold, and mercury, which were used in casting it, and

these statements have been repeated by many writers. They are altogether without any foundation in fact. I have had many opportunities of examining it, and although I never succeeded in getting a portion for analysis, yet from the streak, hardness, and color of the metal it is undoubtedly a variety of "karakane" (a copper-tin-lead alloy), and the gold and mercury said to have been used in its manufacture were simply employed for gilding its surface and not as constituents of the alloy of which it is cast. Four hundred and fifty tons of metal are said to have been used in its construction. If its average thickness is as much as 7 inches, and it is probably less, its weight must be less than 300 tons. The two following objects are examples of the smaller works of the period:

Date 749 A. D.—Bronze bell, with curious ornamental tongue, now in the temple Tōdaiji (Nara). Dated 2d day, 5th month, 1st year Tembyō Shō-hō. This is of importance, as it is another of the earliest bronzes which bears a date, but, unfortunately, no artist's name.

Date eighth century.—Lantern of bronze and incised gilt copper in the courtyard of the same temple. Its eight sides are decorated with Buddhist figures, conventional representations of hares and other animals, and fine arabesques in open work. A photograph of this lantern is exhibited.

A gong-shaped bell, suspended between two well-modeled dragons belonging to the temple Kō-buku-ji, in Nara, is attributed to this period.

A Buddhist image from the collection of M. Bing, of Paris, of the same period.

FROM THE BEGINNING OF THE NINTH TO THE END OF THE TWELFTH CENTURY.

Near the close of the preceding epoch the court was removed to the city of Kioto, which from that time (794 A. D.) up to 1868 continued to be the imperial capital. This removal of the court was a severe blow to the art life of the ancient city; and the works and traditions of its old bronze founders soon appear to have been forgotten or neglected in the new metropolis.

From the beginning of the ninth until near the end of the twelfth century, a space of nearly four hundred years, we have a period of stagnation if not of decadence in all art, yet, strange to say, it embraces the golden age of literature, during which the famous classical romances were written. Its first half, as shown by these romances, was marked by effeminacy; during its second the country was plunged in civil war. The romances gives us but little information of the individual and art life of the people, and the pages of its histories are solely devoted to records of the jealousies and feuds of the great families of Fujiwara, Taira, and Minamoto.

Until near its termination we have no record of the erection of any temple of note or of the execution of any great art work; and I have been unable to find any examples of the art of the bronze founder

during the entire period, excepting two insignificant boxes for holding seals (dated respectively 998 and 1098 A. D.) and nine distinct coinages of bronze money (from 810 to 958 A. D.). After this last date even the coinage of money appears to cease, and is not resumed until 1457 A. D.—five hundred years afterwards.

THIRTEENTH CENTURY.

During the last years of the twelfth century, when peace was established throughout the country by the victories of Yoritomo, there are the first signs of a revival of the old art of the Nara period. From 1190 A. D. up to the date of his death (1198 A. D.), this remarkable warrior devoted all his energies to the cultivation and advancement of the arts of peace. Stimulated by his example and enthusiasm, the artistic spirit of the people was aroused from its dormant condition, and for nearly a hundred years we have a notable period of renaissance in art, a period chiefly remarkable in the history of bronze for the casting of that magnificent masterpiece the colossal image of Amitâbha, usually called the Daibutsu of Kamakura. This image, one of the finest examples of bronze founding, can not be adequately described by any word painting; it must be actually seen in the midst of its grove of conifers and evergreens to appreciate fully its grandeur and beauty, its soberness of design, and noble expression of majesty and repose. It stands alone and incomparable among all the chefs d'œuvre of Japanese bronze founders.

Although slightly smaller than the great Buddha of Nara, it far excels it in artistic execution. Like it it has been cast in segments, but these have been "burned together" with bronze of similar composition to that of the image itself, the exterior of the joints having been subsequently finished by chiseling.

Japanese histories relate that it was cast about the middle of the thirteenth century (begun 1252 A. D.) by Ono Goroyemon, one of the first bronze founders whose name is recorded. Its dimensions, taken from a woodcut sold to pilgrims who visit its shrine, are as follows: Height, 49 feet 7 inches; length of face, 8 feet 5 inches; breadth from knee to knee, 35 feet 8 inches.

The measurements of both this and the Nara Buddha, however, require revision; the heights in both cases are, I think, exaggerated, and should have 6 or 7 feet deducted from them. Its thickness is variable, ranging from 1½ inches to 3 or 4 inches, or even more in some of the castings, and its weight will not probably exceed 150 tons.

Other bronze images of the divinities of the Buddhist hierarchy, of less colossal proportions and of varying degrees of excellence, were made for the temples of Yamato and Kioto, one of the chief groups being a trinity for the ancient monastery Horyuji. Several bells were also cast, one at Kamakura being worthy of note, as the record given of it indicates the source of the metal from which they were occasionally made. It is said that 300,000 copper coins, which had been

collected by the priests of the temple, were melted down for casting it, and the metal being insufficient, the casting was a failure; 30,000 more coins were then collected for addition to the defective bell, when it was remelted. It is also recorded that copper coins were similarly melted up for casting Buddhist images and ornamental utensils, hence it would appear that it was not then deemed necessary to use a different alloy for bells and art castings than for coins.

FOURTEENTH AND FIFTEENTH CENTURIES.

During the fourteenth and fifteenth centuries we have again a period of decadence, with the exception of two short brilliant intervals, the first during the supremacy of the Ashikaga Shōgun, Yoshimitsu (1368-1493 A. D.), and the second during that of Ashikaga Yoshimasa (1440-1471 A. D.). For the greater part of this period the country was again in a state of unrest and intestine conflict, and the arts of peace found but little encouragement, excepting so far as they contributed to the needs of war.

Workers in iron are brilliantly represented by one of the greatest of the famous forgers of sword blades, Masamune, and by several distinguished armorers and smiths of the renowned Miochin family; but the bronze founder was not in request. His chief work during these two centuries was a colossal figure of the Buddha Vāirōtchana, cast during the time of Yoshimasa for the temple at Hase (Kamakura). I have not seen this image, but it is said to be an admirable casting and to measure 30 feet 6 inches in height.

Two bronzes which were exhibited at Nara in 1888 represent the smaller castings of the period, one an incense burner, which was presented by the hero Kusunoki Masa-shige (first half of the fourteenth century) to the temple at Hase (Yamato), and a war bell also given by him to the Emperor Godaigo.

SIXTEENTH CENTURY.

In the last decade of this century, after another period of civil war, the patron of art and culture is again a famous warrior, Hideyoshi (often known as Taiko Sama). Although then engaged in war with Korea, the closing years of his life were devoted to peaceful pursuits at home, and in imitation of Yoritomo at Kamakura, he erected a huge Buddha and a temple to contain it at Kioto. On the destruction of the image, which was of wood, by an earthquake only eight years after its erection, he contemplated replacing it by one of bronze, but the execution of this was delayed by his death (1598 A. D.), and was only accomplished by his son and widow sixteen years afterwards.

No large bronzes of importance appear to have been cast during this century. Two specimens of the smaller bronzes are exhibited, one a figure of Yakushi (the healing divinity), belonging to my friend Mr. Alfred Cœck, in which the deity is represented holding a crystal ball, an emblem of purity, in his left hand. It bears the names of its dedicators to the temple and the date 1569.

The other is a bell of the form known as "waniguchi," crowned with the figure of a tortoise encircled by the coils of a snake, kindly lent by my friend Mr. Harding Smith. It also bears the name of its dedicator and the date 1593.

Several specimens of dedicatory bronzes of this time are to be found not only in Buddhist temples but also in Shinto shrines. Two examples of the latter may be mentioned, although they are notable rather for the fame of their donors than for their artistic excellence; a gigantic bell of similar form to the last offered by Hideyoshi to the Shinto shrine at Nachi (Kyushu) and a large mirror (3 feet diameter) dedicated to the Tenjin Miya at Kitano (Kioto) by Kato Kiyomasa, one of Hideyoshi's noted generals in the Korean campaign.

I can not omit to show you on the screen a magnificent bronze in the famous Cernuschi collection in Paris, which is attributed to this period. It is supported on a pedestal of rich open work, and is decorated with gourds and an heraldic representation of the leaf and flowers of the *Paulownia imperialis*.

Another splendid example of "cera perduta" casting of this period is a group of egrets, standing upon an inverted lotus leaf, which has been kindly lent by my friend Mr. Alfred Cook.

SEVENTEENTH CENTURY AND FIRST HALF OF THE EIGHTEENTH.

In 1603 Tokugawa Iyeyasu, a man of remarkable ability, both as a warrior and as a statesman, succeeded to the Shōgunate, and by his wisdom and foresight established on firm foundations the Japanese system of feudalism, which, under the rule of his successors, gave absolute peace to the country for more than two and a half centuries, and resulted in an advance and development of the arts unparalleled in any previous age.

During the supremacy of these Tokugawa Shōguns, the painter, the lacquerer, the potter, and the founder were encouraged and stimulated as they had never been before to bring their respective arts to the highest point of excellence; and it is in no small degree owing to the works which they produced during this period that Japan owes the prominent position which she now so deservedly occupies in the world of art.

The first great works of the bronze founders of the seventeenth century were a colossal figure of the Buddhist divinity Rochana, in Kioto, to replace the wooden image destroyed by an earthquake in the previous century, and a huge bell for its temple.

The figure is said to have been 58½ feet high, and from the records regarding the first attempt to cast it, it would appear that it was cast in situ and in segments, the mold being built up on the parts already finished. It would thus, when completed, have been practically a single piece of metal. This attempt was a failure, as when casting the lower part of the head the wooden scaffolding was set on fire by the operations and the image partly melted. It was successfully completed in 1614, but only forty-eight years afterwards, like its wooden

predecessor, it was destroyed by an earthquake. According to official records its fragments were melted in 1668-1683 and cast into the bronze coins (Kwan-ei-tsu-ho) then current.¹

This record is interesting, as it affords another proof that the alloy used by bronze founders did not differ much in composition, if at all, from that in use at the time in the mints for coins. I have analyzed these coins, with the following results: Individual coins differed considerably from one another in composition, the percentage of copper present varying from 69.8 to 86.8, a variation not greater, however, than might be expected from the nature of the alloy and the mode in which it was cast. Hence, in order to ascertain their average composition, 7,600 pieces were melted together, and the resulting metal was analyzed and found to consist of—

	Per cent.		Per cent.
Copper.....	77.30	Iron	1.01
Tin	4.32	Silver.....	0.06
Lead.....	15.33	Sulphur.....	0.52
Arsenic	1.14	Gold	Trace.
Antimony.....	0.31		
Zinc	Nil.	Total	99.99

We may hence not unreasonably conclude that this represents, approximately, the composition of the alloy which was used for casting the colossal Buddha.

The bell is the largest in Japan. Its dimensions are, approximately, height, 14 feet; external diameter at the mouth, 9 feet; thickness at the rim, $10\frac{3}{4}$ inches. In section these bells differ from European form in having the rim thickened internally, so that their mouths are constricted. (Fig. 1.) And it is this constriction which causes the gentle rising and falling tones which characterize the boom of all Japanese bells. It is hardly necessary to mention that these bells are not swung, neither are they furnished with tongues, but are rung by striking the outside by means of a beam of wood suspended

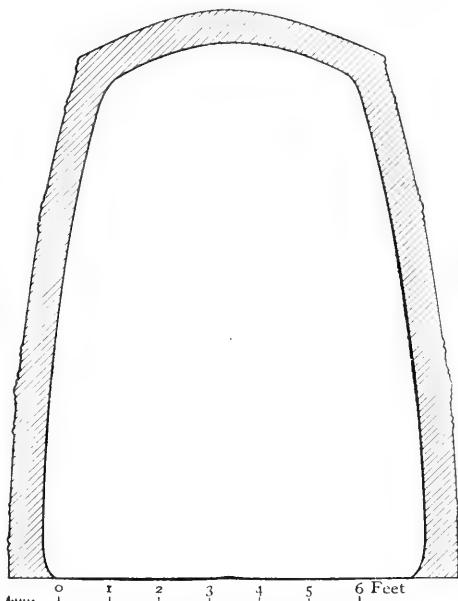

Fig. 1.

SECTION OF TEMPLE BELL.

from the bell tower and swung like a battering ram. The point struck is a low boss, which sometimes has the form of a lotus flower.

¹There is another record of the conversion of Buddhist statues in coins in 1450-1470.

Two other similar bells were cast during the first half of this century, seventeenth, details of which are given in the following table:

TABLE I.—*Approximate dimensions, etc., of four of the largest bells in Japan.*

Date.	Name of temple.	Height.		External diameter at the mouth.	Thickness of rim.	Approximate weight.
		<i>Ft.</i>	<i>In.</i>	<i>Ft. In.</i>	<i>Inches.</i>	<i>Tons.</i>
Eighth century.....	Tōdaiji, Nara.....	12	9	8 10	10	49
1603 A. D.....	Daibutsu, Kioto.....	14	0	9 0	10 $\frac{3}{4}$	56
1633 A. D.....	Chion-in, Kioto.....	10	10	9 0	9 $\frac{1}{2}$	a 43
1623-1649 A. D.....	Zō-jō-ji, Tokyo.....	12	0

^a The weight of this bell is often erroneously given by writers as 74 tons.

The exact average thickness of these bells can not be ascertained without special measurements, which are not permitted, but it can not exceed 8 inches, the thickness I have assumed for the above calculations, and may possibly be somewhat less. The casting of a large bell in old times in Japan was an important event, and was accompanied by religious ceremonies and popular rejoicings. On the day appointed for running the metal into the mold a grand festival was held at the temple in the grounds of which the founding operations were performed, and people of all ranks came from far and near with contributions, many with offerings of mirrors, hairpins, and metal ornaments, to be added to the bronze in the furnaces. On one occasion, that of the founding of the great bell of Zō-jō-ji, the Shōgun himself (Iye-mitsu) was not only present, but took part in the direction of the operations. In succeeding years the day was not forgotten, but its anniversary was celebrated by temple feasts.

The fame and repute of this "golden" period in the bronze founder's art does not however rest on the above castings, which are chiefly remarkable for their size and weight, but on those now to be described, many of which are masterpieces of design, modeling, and technical skill.

The oldest of these are the bronzes cast for the mortuary chapels and tombs of the early Tokugawa Shōguns and members of their families. At the famous mausoleum at Nikkō there are some grand examples, one of the most notable being the tomb of Iyeyasu (the first Tokugawa Shōgun, died 1604 A. D.), a fine casting in bronze, with bronze gates, distinguished by impressive simplicity and chasteness of design (Pl. LXV). In front of the tomb are the three ceremonial ornaments (Sangusoku) of the Buddhist altar, viz, a vase, incense burner, and candlestick, all of the severe style of the period.

The gates (Pl. LXVI) are splendid examples of bronze founding. Almost their whole surface is covered with delicate diaper and floral patterns, upon which ground the bolder ornamentation is molded in relief. These consist of representations of the "chakra," or Buddhist wheel of



BRONZE TOMB OF IYEFASU. DATE, 1617, A. D.

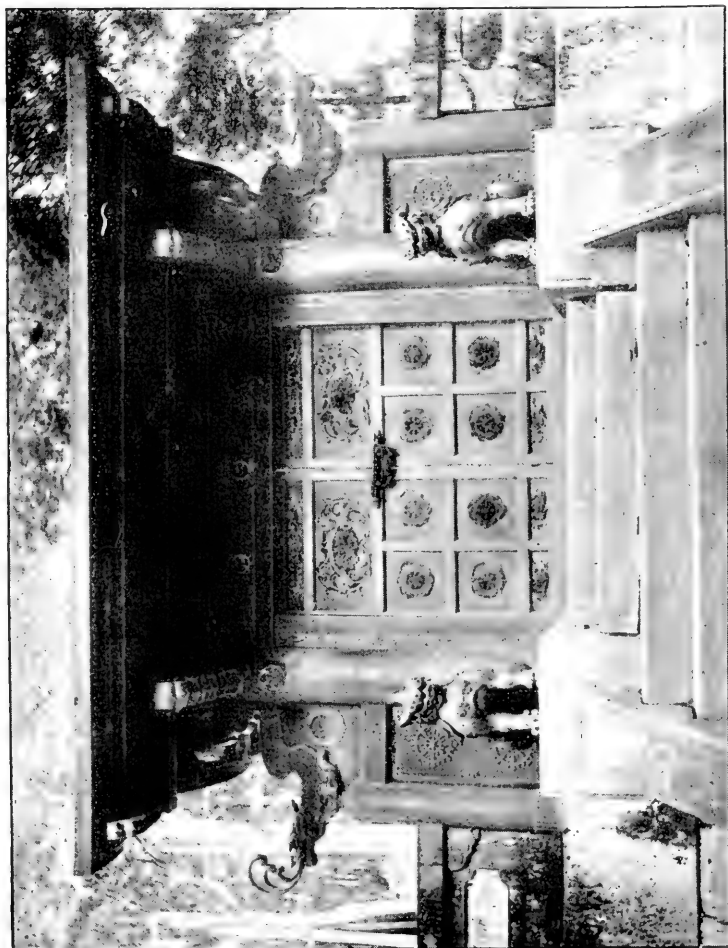

BRONZE GATES OF THE TOMB OF IVEYASU.

the law, and floral designs, most of which are coated with gold. In front are the two fabulous animals (Koma-inu and Ama-inu) supposed to represent lions.

The tomb of Iyemitsu (third Tokuwaga Shōgun, died 1649 A. D.) closely resembles that of Iyeyasu in form, but the reliefs on its bronze gates are simply Sanscrit characters in medallions. These tombs are situated in a grove behind the chapels and oratory, and their simplicity presents a striking contrast to the magnificence of these edifices, which are the most richly decorated shrines in the world. It is said that their plain and simple design is intended as a concrete expression of the Buddhist aphorism that "at death there is an end to all magnificence."

Numerous large standard lanterns (tōrō) of bronze (Pl. LXVII), contributed by the territorial nobles, who vied with one another in thus doing honor to their departed chiefs, line the courtyards of the shrines. Many hundreds of these "tōrō," which were favorite votive offerings of the wealthy both to Buddhist temples and Shinto shrines, were cast during this period of revival in bronze founding. They adorn the approaches and grounds of every temple of note in the country, those of Zō-jō-ji (Tokyo) alone number more than two hundred.¹

Each group or pair differs from any other, yet in outline and decoration all are in harmony; and if no other examples of bronze founding were in existence, the gracefulness of form and fertility of design which characterizes all would alone mark their modelers and founders as artists of the first rank. It will be noticed that both of these in the illustration, although of the same general form, differ entirely in decoration.

The mausolea of other Tokugawa Shōguns also afford some fine examples of the bronze founders' art, notably the tombs of Iye-tsuna (1650-1680), and Tsunayoshi (1681-1708), at Uyena (Tokyo), and of Iye-nobu (1709-1712), at Shiba (Tokyo). They are of similar form to those at Nikkō, differing from them chiefly in the more elaborate decoration of their gates. Finely modeled dragons and the armorial badge of the Tokugawas ornament the gates of Iye-nobu's tomb, while in the tomb of Tsunayoshi—who was a noted patron of art—there is still a further departure from the simple style of earlier times, the symbolical combinations of the fabulous unicorn (Kirin) and pine tree, the phoenix (Hōō) and paulownia, and of the pine, bamboo, and plum being perhaps almost too lavishly employed.

Another important bronze at Nikkō, representative of the period, is a bronze column (1649 A. D.), termed sō-rin-tō, 42 feet in height, a form of the Indian "stupa," as introduced into Japan through China. Before removal to its present site it stood near the tomb of Iyeyasu, and was doubtless erected there in accordance with the Chinese superstitious beliefs in the efficacy of such structures in warding off evil influences and insuring the protection of Heaven. Besides these, four huge lotus

¹ Presented to the Shōguns Iyetsugu (1716) and Iye-shige (1762) by the territorial nobility.

petals, for the base of the image of the Daibutsu at Kamakura, were cast at the beginning of the eighteenth century (1717). A small bronze of the seventeenth century I am enabled to show you through the kindness of Mr. W. Cleverly Alexander; it is an incense burner, in the form of two rats, by Meiho. Also a candlestick for the Buddhist altar, decorated with a dragon coiled round its stem, from the collection of Mr. Alfred Cock. Two other candlesticks of the seventh century, or probably earlier, have been kindly lent by Mr. E. W. Hennell.

FROM THE MIDDLE OF THE EIGHTEENTH CENTURY UP TO THE
PRESENT TIME.

Hitherto the skill of the bronze founders had been chiefly exerted in the production of colossal images and other huge castings for the temple of Buddha, and in giving a severe beauty to the forms and ornaments of utensils and implements for ceremonial purposes; but during this period, with the continuation of peace their art found a wider range in the designing of objects for secular use for the decoration of the home and the everyday needs of life.

Shortly before, the *okimono*, or ornament, a thing of no practical utility, but only of display, had been introduced, and this specially opened up to the artist a rich and unlimited field for the exercise of his ingenuity and skill in the art of ornament and design. The vase, too, formerly used only as a ceremonial vessel of the Buddhist altar, now became a necessary object for the adornment of private life, and in its form and decoration the artist was no longer hampered by the old traditions and rules of the church. The founders of this period hence are not chiefly notable, as in earlier times, for the works destined for the services of Buddhism or the embellishment of its shrines, although many remarkable castings were made, principally standard lanterns, dedicated as votive offerings to temples and monasteries, and *torii*, or gateways of Shintō shrines, but owe their world-wide fame to the skill and fertility of design exhibited in the objects above mentioned for household use, many of which are masterpieces of form and ornament. The following characteristic examples of Buddhist art can not, however, be omitted from my account of this period:

Date 1736 A. D.—A fine image of Sakya-muni, in the grounds of Zōjōji (Tokyo).

Date 1765 A. D.—A colossal figure of Kwanyin, 9 to 10 feet high, near the post town of Futagawa, on the Tōkaidō.

Date 1778 A. D.—An image of Sakya-muni (7 to 8 feet high?), in the courtyard of Jō-shin-ji, Tokyo.

End of eighteenth century.—An image of Amitâbha, formerly at Meguro, near Tokyo, now in the Cernuschi collection (Paris). Height from the base of the lotus flower to the top of the nimbus 14 feet 9 inches.

A figure of Amitâbha, seated on a lotus flower (date 1772), lent by



BRONZE LANTERNS AT NIKKŌ. DATE. 17TH CENTURY.

Mr. Alfred Cock, is an excellent example of the Buddhist art of the period.

The period is also marked by an important naturalistic monument in the schools of both pictorial and glyptic art.

They had up to this time followed the older men in basing their designs on the traditions of Buddhism and the forms and motives of Chinese and occasionally of Indian art, but now they began to break away from the trammels by which they were bound to these old conventional forms and motives, and to go to nature for their inspirations and models.

It should, however, be remembered that much as the works, especially of Chinese artists, were admired, mere slavish copies were never or rarely made of them; thus in the bronzes even of the early days, the figures of Buddhist divinities, there is a serenity of expression and graceful arrangement of drapery which we look for in vain in the masterpieces of Chinese art. Nearly contemporaneous with the establishment of the Shijo-ri—the school of naturalistic painting—in Kioto, by the famous painter Ōkyo, we find the art founders adopting these new motives and new modes of representing the old. Stiff geometric designs give place to those based on natural forms, and even in representations of the mythical dragon we see, as has been pointed out by Professor Anderson, “distinct evidences of direct study of snake form.”

Students of natural objects, of plant and animal life, were now made, the designs of the naturalistic painters were followed, and an impulse was given to the art of bronze founding greater than had been known since the Nara period.

For a little more than three-quarters of a century we have another golden age in its history, during which a succession of brilliant artists, distinguished by marvelous technical skill and originality of design, worthily maintained the best traditions of the founders' art, and Japan attained a position in *cera perduta* casting which she had never reached before.

Two men, Seimin and Toiin, stand out prominently during the closing years of the last century and the first quarter of the present. Others, among whom should be mentioned Harutoshi, Kunihiisa, Kamejo, Teijo, Taichi, approach these great masters in skill, even occasionally proving their equals. The work of these famous artists is well represented by the specimens on the table, the most important of which are from the collections of my friends Mr. Alfred Cock, Mr. Mills, Mr. Alfred Parsons, and Mr. J. M. Swan, and by Pl. LXVIII, fig. 1, a group of tortoises from the collection of Mr. J. M. Swan, and Pl. LXVIII, fig. 2, a brazier from the collection of Mr. Alfred Cock.

In examining their works it will be noticed that, as among the painters, several were specially distinguished for their skill in the representation of certain motives—Sosen as a painter of monkeys, Ganku

of tigers, Ōkyo of carp, etc.—so among the founders several are similarly renowned; thus Seimin chiefly owes his fame to the perfect modeling of his tortoises, Toiin Sōmin for the vigor and life expressed in their dragons, and Kamejo for the delicate and truthful rendering of her quails. It is needless to say that they did not confine themselves to these, but executed other works not less demonstrative of their skill.

The human figure, however, does not form part of their naturalistic studies. The forms and movements of lower animal life are expressed with a truthfulness which has never been surpassed, but in representing man they seem rarely to have been able to free themselves from the conventionalities of the art dogmas of the old Sinico-Japanese schools, and seldom show even traces of that close observation of nature which characterizes their other works.

One of the finest examples is a seated figure of Ban-kurobé in the garb of a pilgrim, cast by Murata Kunihiisa, in 1783 (now in the famous Cernuschi collection, Paris). Pl. LXIX.

Portrait statues are of extreme rarity, those representing famous personages being merely conventional creations which are supposed to portray the type or class to which they belonged rather than the individuals themselves. This example would seem to be one in which an attempt has been made to produce with truthfulness a characteristic likeness of the man whom it is intended to commemorate.

With the death of the last representative of this brilliant group of art founders near the end of the first half of the present century, the art gradually passed into a stage of decadence, the lowest depths of which it but recently reached, and from which it is only just emerging.

Vast numbers of bronzes have indeed been cast, but they are too often of meretricious design and tawdry ornament, or debased copies of the creations of Seimin, Toiin, and their distinguished contemporaries. Fortunately there are a few notable exceptions to this later statement. In the first decades of the second half of this century Dōsai, Gidō, Sōmin, Joun, Tanchosai, Toryusai, and Izan (specimens of whose works are exhibited) did much excellent work, and ably sustained under considerable difficulties the reputation of their famous predecessors. Among more recent founders, a distinguished position should be given to Suzuki Chokichi (now living), whose well-known magnificent example of *cera perduta* casting is in the South Kensington Museum. It is an ancient incense burner with doves and peacocks, the doves especially being masterpieces of modeling, and an embodiment in bronze of the highest developments of the naturalistic school, of which Chokichi is an earnest and ardent follower.

And I here should like to say a word on the excessive crude and vulgar ornament which disfigures too many modern Japanese bronzes. Such ornament is never found on any vase, brazier, or other object intended for use by the Japanese themselves, but is confined to those articles specially made for sale to foreigners. (The collection exhibited

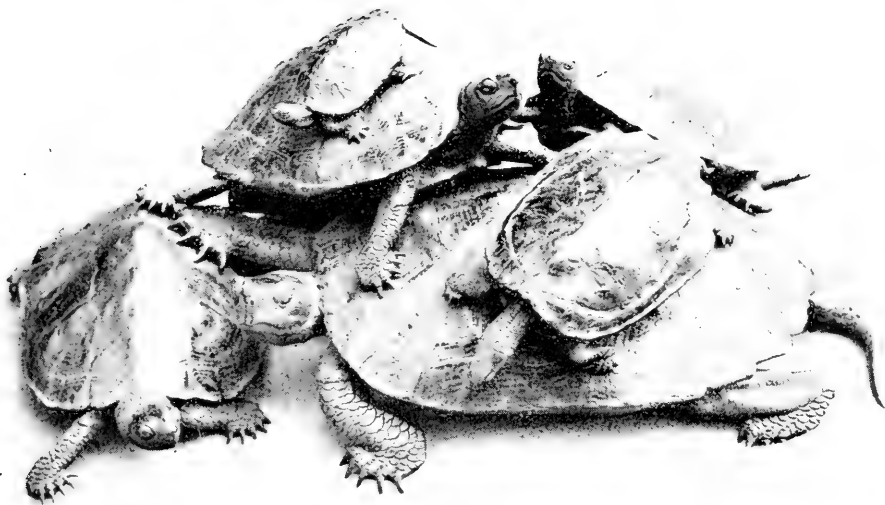

FIG. 1. BRONZE GROUP OF TORTOISES BY SEIMIN.

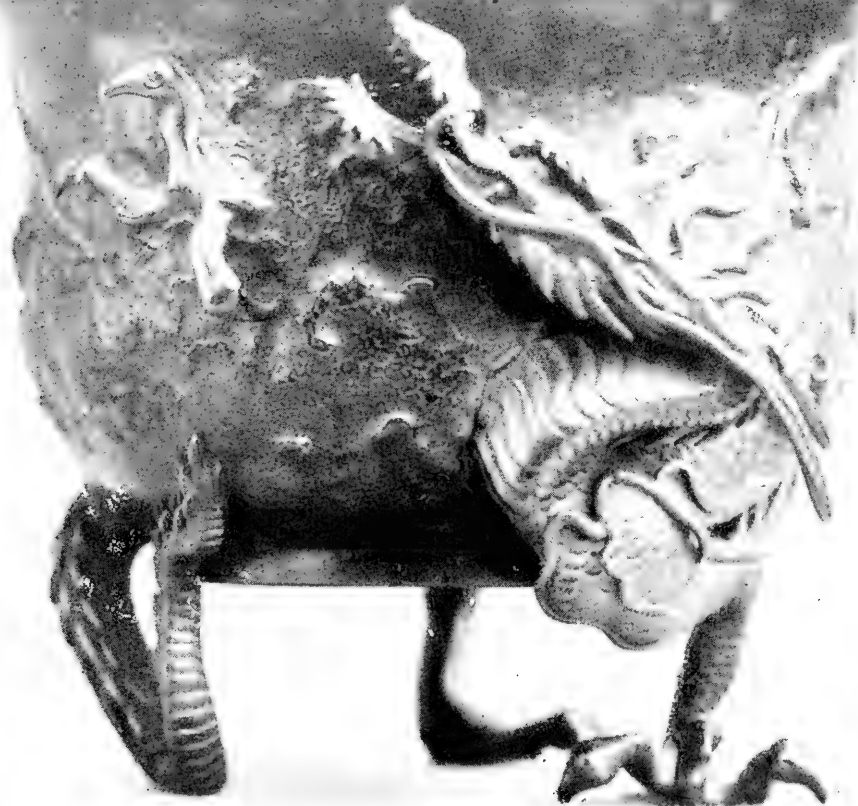

FIG. 2.--BRONZE BRAZIER BY TOÛN. BUNSEI PERIOD, 1818-26, A. D.



BRONZE FIGURE OF BAN-KUROBÉ. CERNUSCHI
COLLECTION, PARIS.



to illustrate the forms and ornaments of Japanese bronzes before the opening of the country to foreign trade amply demonstrates this.) These are all veritable "pot-boilers" cast by men often capable of doing better things, who earn more by the production of these vulgar monstrosities for exportation than others who still endeavor to follow the simple canons of Japanese art. Modern Japanese bronze founders, like their brethren in pictorial art, hence work in an adverse environment, and under many disadvantages unknown to their predecessors. In the early centuries religious enthusiasm, the quiet seclusion of the monastery, and the patronage of a powerful priesthood stimulated, fostered, and supported the old artists in their work, so that all their powers were put forth in the execution of the grand masterpieces of those times.

In later times the same result was achieved under the system of feudalism which prevailed in the country. Workers in bronze were attached to the courts of the greater daimyos (territorial noble); their incomes were secure, they were free to work out their designs as they wished, and need only do so when they felt inspired.

During recent years the Emperor has done much for the encouragement of a select few of the chief art workers in bronze in the revival of their old art, the result being that some of the objects of modern work which adorn the imperial palace are of extreme beauty, and equal those of the older masters in gracefulness of form and sobriety of ornament. But for the great majority there is no such patronage, yet the bronze founders must live, and to live means for too many that they must waste their talents in producing work in designing which they are hampered by the demands of commerce and the chief, or rather sole, end of which is merely pecuniary remuneration. Up to the eighteenth century we rarely find the name of the artist or founder attached to any bronze. Most of the existing specimens of the earlier bronzes were made, as we have seen, for use in the ceremonies and ritual of the Buddhist religion, and were not usually allowed to bear any name, excepting when they were *ex voto* offerings, and then only the names of the donors. The records of the temples are also silent, with few exceptions, even on the authorship of the grand masterpieces to which they often owe their popularity and fame. The dedicators alone are remembered and the artists forgotten. Being almost invariably men of plebeian origin, the bronze founders occupied a lower status in life than the calligrapher, painter, or armorer, and their lives have not been thought worthy of record. All the knowledge we have of even the great masters of the last generation is derived solely from their works.

Several charming specimens of both the larger and smaller bronzes, especially of the latter, as late as the last hundred years, are unfortunately not signed (see especially the candlesticks of fine open work lent by Sir Trevor Lawrence), and many of equal merit are signed by artists whose names do not appear in the lists of noted bronze workers. So

that the materials for a history of the men themselves, such as has been compiled of their fellow-artists the painters, do not exist; and are but scanty and incomplete, even for a record of their works.

This will conclude the first part of my paper. I must apologize for the fragmentary character of the account I have attempted to give you of the rise and development of bronze founding in Japan, and will ask you to regard it merely as a collection of notes which may be of use in the compilation of its history when further materials are brought to light. I have purposely omitted from it the consideration of the guards (*tsuba*) and other furniture of the sword, because they are more particularly the work of the chaser and carver of metals than of the founder, and also because the subjects of their designs and their technical execution extends over such a wide field that a special paper would be required for their adequate treatment.

Lantern slides were shown of specimens dating from 1785 to about 1838 A. D.:

Eighteenth century.—A hawk. From the magnificent collection of Japanese bronzes presented by M. Cernuschi to the city of Paris.

1783.—A statue of Ban-kurobé in the garb of a pilgrim. By Murata Kunihisa. Height 2 feet 6 inches, measured from the top of the pedestal. Cernuschi collection.

1821.—An incense burner. By Ta-uchi and Yaki-yajiro. Nearly 6 feet high. Cernuschi collection.

Beginning of the nineteenth century.—A group of tortoises. By Seimin. Kindly lent by Mr. J. M. Swan, A. R. A.

A brazier. By Toiin. Kindly lent by Mr. Alfred Cock. Both of these are masterpieces of modeling and casting.

An incense burner. By Toiin. About 3 feet in height. Cernuschi collection.

THE TECHNICS OF JAPANESE BRONZE FOUNDING.

Several methods of casting metals have been practiced by the Japanese. In the earliest times molds of stone, in which the shape of the object was cut, sufficed for the simple forms of their ancient weapon; and although they are no longer employed in the casting of bronze, their use still survives in the casting of lead for some industrial purposes, and of small silver bars, which have subsequently to be worked with the hammer into jewelry and ornaments. Somewhat later, molds of clay were introduced, probably by Chinese, and it is almost certain that contemporaneous with their adoption the method of *cera perdata* casting was first practiced.

Casting in molds of sand or loam is also of an early date. In 708 A. D. it was in use in the mint for the production of bronze coins. At present it is chiefly employed for small or flat objects—plain or only roughly ornamented—and for castings for industrial uses.

These methods have been followed in some form or other by almost

all nations, but I may mention *en passant*—although it hardly comes within the scope of this paper—another method which is essentially Japanese, i. e., the casting of refined copper in canvas molds in hot water. Specimens of copper so cast for the use of the bronze founder are on the table. It is also used occasionally, but rarely, for silver, never for bronze.

One mode of casting they have never practiced, that is, what is called the “ascending” method, in which the ingates are so arranged that the molten metal enters the mold at its base and gradually rises and fills its cavity. They have, however, introduced a modification in the “descending,” or ordinary method—which will be described later—to minimize some of its disadvantages, the chief of which are, as is well known to founders, the occasional formation of “cold sets”¹ on the core and sides of the mold, and unsoundness in the castings due to the entanglement of air in the streams of metal when falling from the top of a high mold.

It will be seen from the descriptions which follow of the operations of the Japanese bronze founder that, while in their general features they have much in common with those of the bronze founder in Europe, they present some differences of greater or less importance, differences which are chiefly found in certain details of manipulation which are the results of the conditions under which the Japanese founder has worked, the composition of his chief alloy, and the nature of his training.

Before proceeding to consider these operations, we will first glance briefly at the founder himself. He was—as I have stated above—almost without exception of the plebeian class of the people, and although many at various periods were men of marvelous ability and of the highest merit as artists, yet they seem never to have ranked higher than artisans. Several sculptors in metal, who were specially distinguished for their skill in the design and ornament of the furniture of the sword, and many noted smiths, forgers of famous blades and of armor, were indeed elevated above this grade, and had the honor of receiving complimentary titles in recognition of their ability; but I have not succeeded in finding a single example of an art founder having been similarly honored.

No special courses of study, such as were followed by painters, were open to him. A knowledge of the principles and practice of his art had to be obtained under a system of apprenticeship, which had much in common with that in vogue in Europe during the latter part of the Middle Ages, and in which drudgery and household work absorbed not a little of his time. As an apprentice he was bound to serve his master for a fixed term of years, during which his duties were not only to assist

¹“Cold sets,” metal which has been splashed up against the sides of the mold or core, has solidified there, and not afterwards united with the main mass of metal, owing to a film of oxide which has formed on its surface.

in the actual work of the foundry and studio, but also to attend to the personal wants of his master. He lived in his master's house, was fed and clothed by him, and became in fact a minor member of his family.

During his apprenticeship he was taught every branch of the founder's art, from the rough work of mixing and tempering clay for molds, and the making of crucibles, to the highest stages of designing and modeling objects in wax and of subsequently casting them in bronze. After long years of faithful work, if distinguished by special ability, he might be selected by his master as his successor, and at least was entitled to receive from him a modest sum of money, either as a loan or a gift, sufficient to enable him to establish a small atelier of his own.

The foundry of the artist always now forms part of his dwelling house, and doubtless this was the case in earlier times. Special rooms are set apart for drawing, modeling, and the preparation of the molds, the rougher operation of molding being carried on in sheds at the side of the garden or yard. The foundry itself, in which the metal is melted and cast, is also situated in the yard. A special feature in many is the well-arranged garden on which the modeling rooms open, so that the artist works amid cheerful surroundings, which must influence his work for good. The working staff consists of the artist, his apprentices, the members of his family, all of whom, even the children, assist in some of the operations, and one or two workmen. Castings from models designed by the artist himself form sometimes the sole work of the foundry, but generally other work is undertaken, and castings are then made of objects which have been modeled by other artists who send their molds ready prepared merely to be filled with metal.

The Japanese processes of casting bronze and the appliances and materials used, which I shall now endeavor to describe, are those which I have seen from time to time in the art foundries of Osaka during my residence there, and I have to ask for your indulgence if I burden you with some dry and apparently trivial metallurgical details which may be uninteresting to those who are not specially concerned with the melting of metals. I will, however, try to deal with them as briefly as possible.

This part of my subject may be conveniently divided into the following sections:

1. Preparation of the mold and core. In clay; in sand or loam.
2. The furnace and foundry appliances.
3. The operations of casting.
4. The alloys used.
5. Stains and patinas.

1.—PREPARATION OF THE MOLD AND CORE (IN CLAY).

The materials used for modeling and the preparation of the mold and core are as follows: Vegetable wax, prepared chiefly from the fruit of *Rhus succedanea*; it possesses great fluidity when melted, but has the

disadvantage of being extremely brittle in cold weather; beeswax; resin, obtained from various conifers, chiefly *Pinus massoniana* and *densiflora*; clay, raw and burned; river sand; chopped rice straw; rice husks. Various mixtures of vegetable wax and resin, to which beeswax is sometimes added, also of beeswax and resin alone, are used for modeling, according to the character of the design of the object, and the extent and nature of its ornament. For castings of the highest class, and especially for those with delicate lines and forms or ornament, the latter mixtures are always employed, the former being used only for large or common works of simple shapes, with rough or little decoration. The clays used in Osaka and Kioto are obtained from the hills of decomposed granite in the neighborhood. They are extremely plastic, but are not very refractory, as they contain considerable amounts of the alkalis.

Great care is devoted to their "tempering," which is effected by many months, even years, of exposure to the weather, with frequent turning over in the yard or sheds of the foundry. They are always mixed for use with varying proportions of old fire bricks in both fine and coarse powder, and when employed for large or solid cores with coarsely chopped rice straw, rice husks, and river sand. Special importance is attached to the use of the oldest clay for the preparation of molds and hollow cores, as it has been found by experience that they are then much stronger and less liable to crack than when made of newer material. The amount of rough usage these molds will bear without injury is very surprising. I have seen them rolled over the rough floor of the foundry from one end to the other and yet yield perfect castings. The core, which is one of the most important parts of the mold, possesses some curious features which are specially characteristic of Japanese foundry practice. For small figures it is generally solid, and these differ but little from those in common use everywhere; in other cases it is always hollow.

The hollow core—this is used by the Japanese whenever possible—is of two kinds, in one of which it is closed at one end: in the other both ends are open. The chief peculiarity of the former is its thinness, compared with similar cores in Europe, otherwise it does not differ much from them. I will hence only describe in detail the latter, or open core, as it has many peculiarities, and is particularly distinctive of the methods of founding adopted by artists. In its usual form its thickness is not much, sometimes not at all, greater than that of the outer shell of the mold; in fact, it merely forms its inner wall; and, in order that this kind of core may be employed almost all castings, even of vases, braziers, and similar objects, are cast without a bottom, the bottom being cast separately and subsequently attached by means of solder. It is usually fashioned on a wooden framework, the parts of which are ingeniously arranged, so that it can be withdrawn as soon as the entire mold has been finished and dried. This

framework, an example of which is shown in plan and section in fig. 2, is constructed as follows: A sufficient number of flat strips of wood,

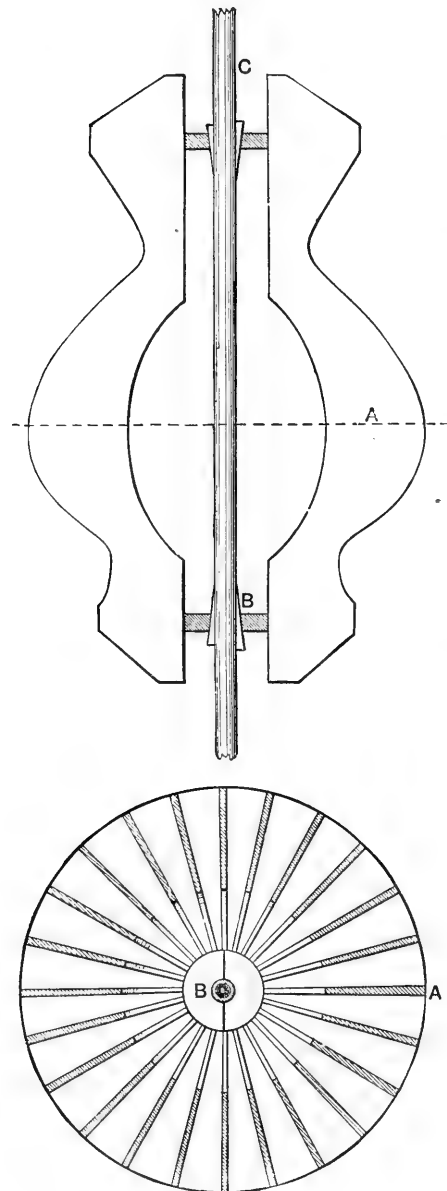

Fig. 2.

REMOVABLE CORE FRAME.

A A, resembling templates, are prepared, their external edges being roughly cut to the shape of the interior of the article to be cast. Two circular disks of wood, B B, each in two segments, and furnished with a central hole, are also prepared to form the top and bottom of the frame. The above strips are then arranged around the peripheries of the disks, and are kept in position by means of wires or cords. A bar of wood, C, of suitable length, is then passed through the aperture in the disks, and the framework is firmly attached to it by wedges. The object of this bar is to enable the core to be moved about or revolved, and so to facilitate the work of the modeler. Thin strips of bamboo, or sometimes a cord of straw, or both, are now bound round the exterior of the frame. The core is then molded on it to the proper thickness with a mixture of burned and raw clay, and rice husks applied in several layers, the lower layers being coarser and more porous than those above them, and the exact form is given to it by one or two final coatings of clay mixed with sand. After the core has been dried the vase or other object is modeled on it in wax of the proper composition (see above). Wooden or metal stamps are sometimes

used for molding Chinese characters and parts of the ornament, but only for the commonest articles, the whole of the modeling of all others being performed by hand.

A drawing or rough model is sometimes used by the artist for his guidance, but not unfrequently he works without either, and even when using them he does not merely copy their lines or the exact details of their ornament; in fact, often he departs from them altogether, if he feels that by a modification of their outlines or decoration the beauty of his subject may be increased.

In preparing this model on the core he exerts his utmost skill; no plaster casts are made from it; if the casting is a failure, his work—it may have been a masterpiece—is lost, but if successful, it bears in imperishable bronze all the subtle and delicate touches of his hand. When the model is completed the ingates or openings C C C C and D D D (fig. 7), through which the metal is poured into the mold, and the necessary outlets for the escape of the air and gases and for running out the wax, are molded on it, and in some objects pins of bronze are inserted in it to aid in keeping the core in position. The ingates for castings of moderate size, especially for those of considerable height, are not placed only at the top of the mold, but also in one or more tiers around its sides. Thus in fig. 7 we have four ingates (A A A A) a little above the middle, and three (B B B) on the top of the mold. The object in thus placing them being to diminish some of the disadvantages of the “descending” method of casting which have been previously alluded to. For thin castings this practice is extremely successful, a much smaller proportion being defective from vesicular structure caused by entangled air, from burned patches, and from “cold sets,” than when the ingates are all at the top.

The wax model is now coated with a thin layer of fine clay, applied with a brush with great care. After drying, other layers are similarly applied, until the crust is sufficiently thick to permit additional layers of somewhat coarser clays to be put on with the hand and tools, to give the requisite strength to the mold. The mixture of clays for the first layers is very carefully prepared, and is sometimes mixed with finely powdered porcelain, to prevent them from being melted by the molten metal. The formation of a fused crust on the casting, which is always difficult to remove, destroys its surface, and mars the sharpness of its designs, is thus avoided.

The mold is then dried very slowly in a warm part of the foundry. When dry, the wooden core is removed and the wax is then melted out by means of a carefully regulated charcoal fire, by which both the hollow core and the outside of the mold are heated, and at the same time all traces of moisture are expelled and its walls baked hard.

PREPARATION OF THE MOLD (IN SAND OR LOAM).

Molding in sand or loam has not been extensively practiced by the Japanese for artistic castings, with the exception—as I have stated above—of flat objects, such as coins and mirrors, and others of simple forms in which no parts of the ornament are in undercut relief. Even

in many cases in which the use of a sand or loam mold was perfectly admissible, a clay mold seems to have been preferred because it could be heated before it was filled with metal, a point to which much importance is attached. Their methods of molding in sand do not differ greatly from ours; I will hence only describe that followed in the old mint about sixty years ago, where this kind of molding was brought to a high state of perfection for casting the bronze coins known as "tempo."

Specimens of these coins and of mirrors cast in the same way are exhibited.

The model, or "mother" coin as it was termed, was prepared in bronze, either by the "cera perduta" method or by cutting and engraving. For mirrors and similar objects this or a model in wood was used as the "pattern," but for coins, when many had to be cast, the "patterns" were prepared first by casting from the "mother" coin what were termed "seed" coins in pewter, and then from these the actual working "patterns" in bronze.

Lantern slides were shown illustrating the operations of molding and casting in the old mint in Yeddo in 1835, as follows:

Filling the mold frame with sand.

Molding by means of the metal patterns.

Smoking the molds.

Pouring the bronze into the vertical sand molds, see Pl. LXX.

The "flask" or frame for holding the sand was of wood, without transverse or longitudinal ribs. It was placed on a flat board on the floor of the molding room, where it was filled with damp sand—the sand being well trodden to consolidate it—the excess was scraped off and the surface made level and smooth. Upon this surface, which was first dusted with charcoal powder, two bronze rods to form the ingates and main feeding channels were placed, and on each side of them a row of the metal "patterns," all being carefully pressed into the sand. Another frame was then placed upon it and filled with sand, which was also very carefully trodden. The frames were then separated, the "patterns" removed, and a small channel was cut from each cavity in the mold leading to the main channel. They were now placed on an open frame and their inner surfaces were smoked with burning pine wood held below them in a brazier. After being again fitted together they were placed between two boards and firmly braced up, and then set up vertically in the melting room to receive the bronze.

2.—THE FURNACES AND APPLIANCES OF THE FOUNDRY.

The furnaces and appliances which are used by Japanese artists for melting and casting bronze are of a very simple character. They consist of a series of cupola furnaces in segments, several crucible furnaces, and two kinds of blowing machines.

Reverberatory furnaces were not employed by the old founders, but



POURING THE BRONZE INTO A VERTICAL SAND MOLD.

during recent years several have been erected from my designs in Government and other establishments, chiefly, however, for the production of ordnance and castings for industrial purposes.

When small castings only are required the bronze is generally melted in crucibles, but for those of larger dimensions a cupola furnace, or more than one, is always employed.

A typical cupola furnace, which is that which was actually used in

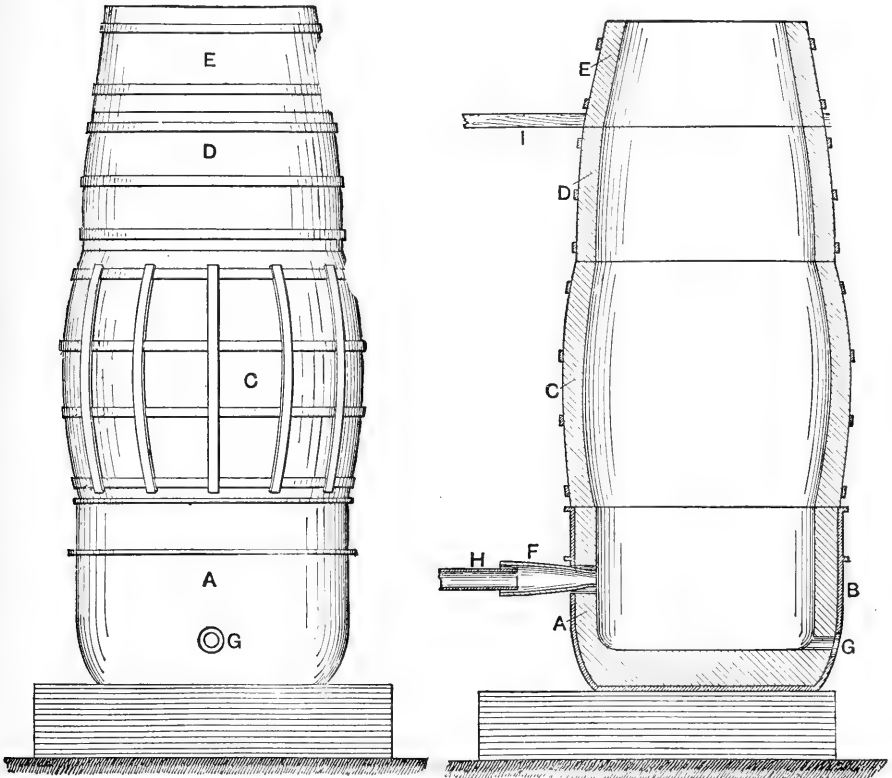

Fig. 3.

TYPICAL CUPOLA FURNACE FOR MELTING BRONZE.

A, lower segment of the furnace; B, iron pan inclosing the furnace; C, D, E, upper segments; F, twyer; G, tap-hole; H, pipe leading the blast from the blowing machine; I, charging.

the casting operations to be described subsequently, is represented in fig. 3.

It is very ingeniously constructed of cylindrical segments. The lowest, which forms the hearth, consists of a cast-iron pan lined with fire clay and a coating of brasque, composed of clay and charcoal. It is furnished with an aperture, G, in front, for tapping out the metal, and another at the back for the insertion of the twyer, through which

the blast is introduced. Each of the other segments consists of a cylinder of fire bricks or slabs, cemented together with fire clay, and firmly bound with iron bands. The number and size of these segments used in erecting a cupola depends on the quantity of metal it is intended to melt at each charge, and as a considerable number of various sections and degrees of taper are kept on hand, any form can be given to the interior of the cupola. In all well-arranged foundries these segments, with their accompanying hearths of various sizes—generally from 1 foot to 2 feet 3 inches in diameter—are always ready, so that a furnace can be built up without delay at any time for either large or small meltings.

The cupola is erected by placing the hearth segment on a platform of brick about 1 foot high, so that the tap hole may be of a convenient height for tapping. Upon this segment one of the others is placed and luted to it with fire clay; another is placed on this and similarly luted, and others are added if necessary until the furnace is of suitable height. The advantages which this method of erecting cupola furnaces possesses for small foundries, where the work is of an irregular character, and where castings are often urgently needed which are too large for crucibles and too small to justify the lighting up of a large permanent cupola, are self-evident.

There is only one twyer, and this is the chief disadvantage of the larger sizes of these furnaces, as it causes an unequal distribution of heat in the zone of fusion, the results of which are undue volatilization of lead and zinc in the overheated spaces and an unnecessary waste of blast and fuel. There is no special charging door, the fuel and metal being simply thrown into the open top of the furnace.

Portable furnace for melting bronze.—Another furnace which is not now in use in Japan, but is still employed in China, resembles the hearth segment of the cupola I have just described. It is, however, made light and portable, stands on three feet, and is fitted with sockets in its sides, into which long handles are inserted, so that it can be carried by two or four men. It is placed in front of a bellows, as shown, and then charged with charcoal and bronze. When sufficient of the latter has been melted it is carried to the mold, the fuel raked off, and the molten metal poured through a beak-shaped opening in its side.

For objects of small size and complicated forms and of delicate modeling the bronze is melted in crucibles in small furnaces, which, like the cupola, are worked by means of a blast. This form of furnace consists of a simple cylindrical chamber, with a lining of fire clay, generally partly embedded in the ground of the melting room, and fitted with a movable clay cover. Its sides are pierced with four or six or more holes, about 3 to 5 inches above its base, for the admission of the blast. The fuel used is charcoal. Recently air furnaces connected with chimney stacks, similar to those of Europe, have been erected in many

foundries, but the above form is still in extensive use in the melting rooms of artists.

The crucible used (fig. 4) consists of a thin inner crucible of porcelain inclosed in an outer one of fire clay; and its construction affords a good example of the ingenuity of the Japanese in overcoming the difficulties arising from the nonrefractory character of their fire clay. As has been pointed out already, granitic clays, not very infusible, are alone available for metallurgical purposes in Japan, porcelain clays being expensive and reserved for the potter. If the crucible were made entirely of the former it would soften and crack at intense heats; hence it is lined with a cup of difficultly fusible porcelain just at that part where, owing to the position of the tuyers, the temperature of the furnace is extremely high; so that, even if the outer part is partially fused or destroyed the metal will not be lost, but be retained by the porcelain cup within it.

Blowing machines.—The machines used for producing the blast can not be passed over without notice. They are of two kinds, both of which are peculiar to the East, and although defective in many respects when compared with the more perfect forms of blowers, such as Baker's and Root's, in use in this country and also in the large commercial and Government works in Japan, yet their convenience and efficiency is sufficiently great to enable them to hold their own in the art foundries, where, indeed, they are still universally employed. One of these, called the "fuigo," is shown in the lantern slide. It is used for producing the blast for the crucible furnace previously described, and also very extensively for other metallurgical operations, such as copper, lead, and tin smelting. As the Chinese form, with which it is almost identical, has been described more than once, I will not trouble you with a detailed account of it. It is essentially a rectangular wooden box, fitted with a piston, which is worked horizontally, and with four valves so arranged that it is double-acting, a blast being produced by both the forward and backward motion of the piston. The air chamber generally measures about 3 feet by 1 foot 10 inches by 7 inches.

The other blowing machine, which is called "tatara," appears to have escaped the observation of foreign writers, as it has not hitherto been described. Fig. 5 represents it in plan and sections. It consists of two air chambers A A, in some cases constructed of wood, in others of clay with merely a lining of wood at their sides. The bottom of each chamber is an inclined plane sloping from a central ridge. The top of this ridge is fitted with metal bearings, in which the axle of the pressure board B works. The pressure board is made of wood and is fitted with two valves, C C, opening inwards, one being placed at each end. Its edges are sometimes lined with a packing of fur or feathers, so that it

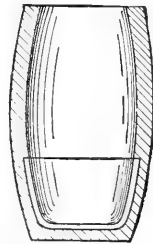

Fig. 4.
CRUCIBLE FOR MELTING
BRONZE.

may fit closely to the sides of the chamber and leakage of air be prevented.

About eight or ten persons are required for working one of these machines in melting bronze, and often the whole of the artist's household—men, women, and children—aid in the operation. A rocking motion is given to the pressure board by the workers stepping alternately on and off either end (fig. 6), and the air is thus compressed first in one chamber, then in the other, and passes to the blast outlet E

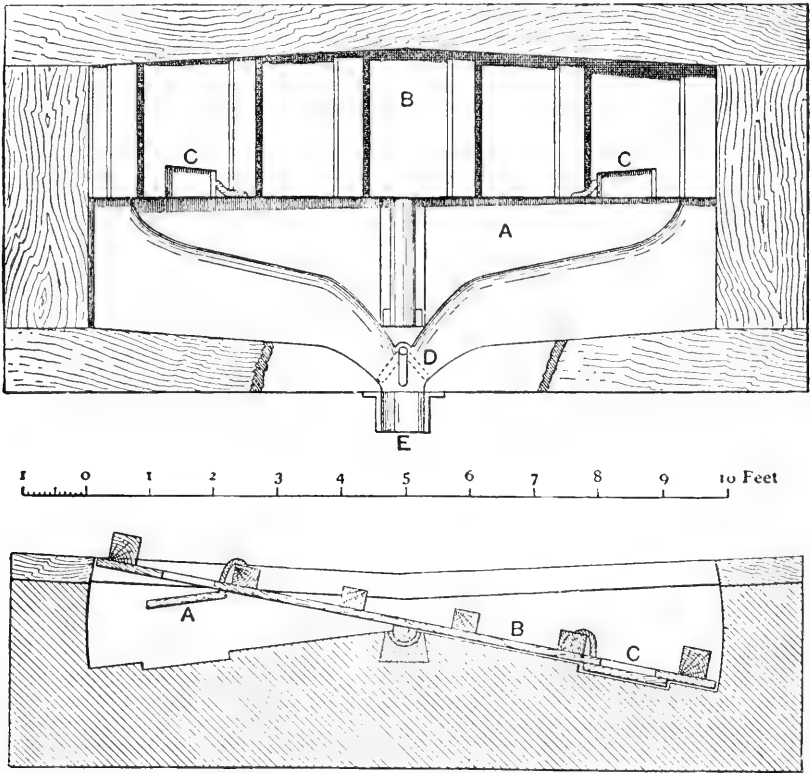

Fig. 5.

JAPANESE BLOWING MACHINE, CALLED "TATARA."

A, A, air chamber; B, pressure board; C, C, valves of pressure board; D, blast valve; E, blast outlet.

through a channel at the bottom and front of each. At the junction of these channels with the blast outlet a flap valve, D, closes either channel when the opposite half of the pressure board descends. The workers are aided in stepping on and off by ropes hanging from the roof, which they grasp with their hands, and in keeping time—and the efficiency of the machine depends greatly on this—by singing songs which have been specially composed for them.

The blast is intermittent, irregular in pressure, and deficient in

volume; and the effective power of a machine worked by eight men does not exceed 1 ton of cast iron melted per hour, the cost of the labor, however, being only about 8 pence.

3.—THE OPERATIONS OF CASTING.

The metal used for the charges of a cupola furnace when a "cast" has to be made consists either of old bronzes and defective castings, or more generally of a mixture of these with new alloy. The separate metallic constituents of the bronze, viz, copper, tin, lead, or zinc, do not form part of these charges, but the alloy is previously prepared by melting them together some days beforehand. The alloy then obtained is cast into thin plates, which are broken up while hot, and the frag-

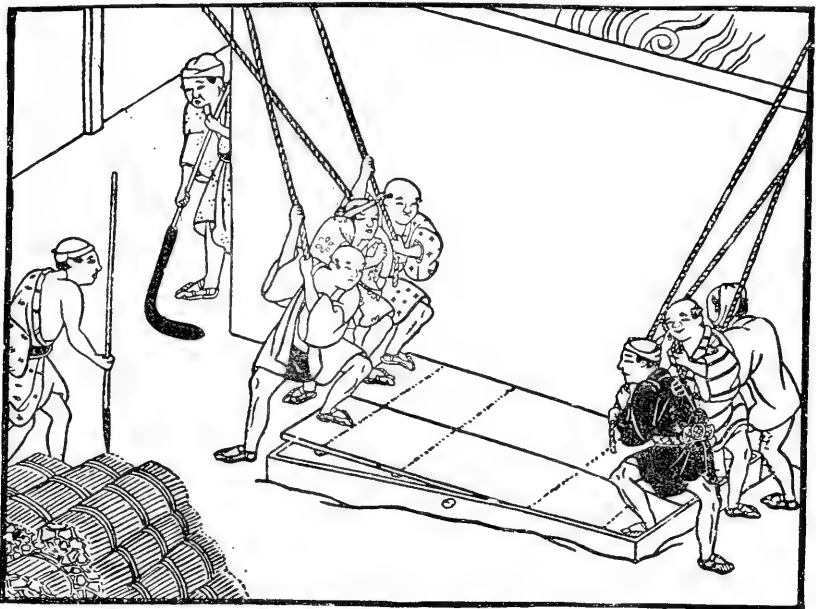

Fig. 6.

WORKING THE BLOWING MACHINE, CALLED "TATARA."

ments are used for the casting charges. When crucibles are used, the alloy is however frequently made at the time of casting, although for castings of special importance bronze which has already been once or oftener cast is always preferred.

For my description of the operations of casting I have selected the casting of a brazier in the mold shown in fig. 7, as it is a typical example of Japanese practice, and I was present in the foundry during the whole of the operations.

The bronze was melted in the cupola furnace (fig. 3). Charcoal was used as fuel, and the blast was produced by a "tatara" worked by eight persons.

From an early hour in the morning and while the melting was proceeding the foundry staff was engaged in preparing the molds for the reception of the metal by heating them to redness. This was effected in the following manner: The mold (fig. 7) was placed on five or six bricks, H H, to raise it above the earthen floor of the melting room. Its ingates, C C C C and D D D D, were closed with stoppers of clay and the conical tubes, F F, were fitted over its air outlets, E E, to prevent any fuel from falling into them. A wall of fire-clay slabs, G G, was now built up around it, the slabs being kept in position by hoops and bands of iron and an external luting of clay, a space about 3 inches wide at its narrowest part being left between the inside of the wall and the outside of the mold. A charcoal fire was then made

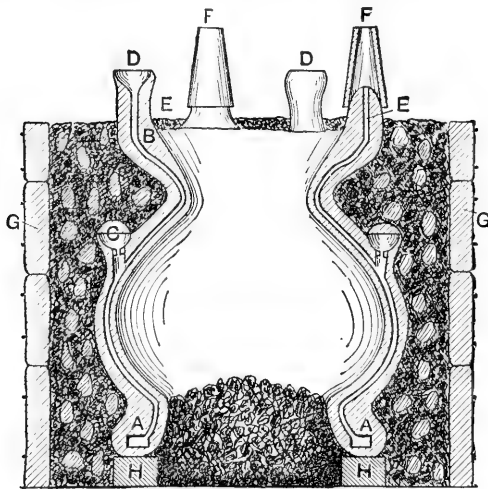

Fig. 7.

MOLD WITH OPEN CORE. SHOWING THE MODE OF HEATING IT.

A, A, outer wall of the mold; B, B, inner wall of the mold or core; C, C, lower ingates; D, D, upper ingates; E, E, vents or outlets for the air and gases; F, F, fire-clay tubes; G, G, fire-clay slabs; H, H, firebricks; I, I, ignited charcoal.

on the floor below the mold, and the space between the wall and the mold was completely filled with burning charcoal, which was mixed with fragments of bricks and crucibles to prevent the heat from becoming too intense. The interior of the core was also partly filled with the same mixture, and two clay tubes were fitted above it to serve the purpose of chimneys. The temperature of the interior was regulated by partially or entirely closing the upper openings of these tubes with tiles. The mold was kept at a red heat for more than two hours, by which time the metal was nearly ready. The wall of clay slabs and the draft tubes were now rapidly taken down and the fire was raked away. The bricks H H, supporting the mold, were carefully removed, and the holes through which the wax had run out stopped up with fire clay. During their removal the floor below was sprinkled with water and softened by shoveling, and on this the mold was allowed to rest. Large stones were now piled around its base to steady it and the stoppers were removed from the ingates. The ingates, of which there were seven—four about the middle of the mold and three at the top—were fashioned in the form of small cups of fire clay about 2 inches in diameter, each having three apertures, half inch in diameter, opening into the channel leading into the mold.

The mold was now ready for receiving the metal. On looking into it

through one of the ingates it was seen to be a dull red heat. The bronze was then tapped into four iron ladles, each of which was held by a workman, and a small quantity of wood ashes was thrown upon its surface. The workmen then took up their positions opposite the lower ingates and on a signal being given poured the contents of their ladles simultaneously into the mold. The quantity of metal had been very accurately estimated, as it just reached about half way up each ingate. These ingates were then closed with clay stoppers luted in with fire-clay. Three of the ladles were filled again and poured in the same manner as before, but into the upper ingates, completely filling the mold. During pouring very finely powdered rice bran was thinly sprinkled on the metal as it flowed from the mouths of the ladles. The mold was allowed to stand for six hours before breaking it from off the casting. Several other smaller molds were then filled in a similar manner, and as one ladleful of metal was sufficient to fill each, they had only one ingate and one air outlet. While the bronze was being poured into them they were rather vigorously tapped with a short stick to dislodge any air bubbles which might have adhered to their sides.

For castings of very large size ladles are not used, but the bronze is run from one or more of cupola furnaces, first into a receptacle lined with fire clay, and then from this through an aperture in its bottom into the mold. The outflow is regulated by means of a plug, so that a considerable depth of metal is always retained in the receptacle in order that scoriae and oxidized scums may be prevented from entering the mold. To prevent oxidation as far as possible, the surface of the metal is kept carefully covered with a layer of charcoal or of partially carbonized straw.

A subsidiary but often necessary part of the founder's work, and one in which the Japanese exhibit very great skill, is the repairing of any defects that the castings may show on their removal from the molds. Thus, for example, occasionally the rim or other part of a vase may be imperfect owing to the retention of air in the mold when the metal was poured in. In this case the imperfect part is carefully remodeled in wax on the defective casting, a clay mold is made over it in the usual way, and the wax is melted out. A certain quantity of metal is then poured in and allowed to run out until the edges of the defective part have been partially melted, when the outlet is stopped and the mold allowed to fill. When it has solidified the clay mold is broken away and the excess of metal filed off.

Handles and ornamental appendages, which have been separately cast, are frequently attached to objects in this manner. Separate parts of complicated groups and of colossal figures are similarly united, and often this is so skillfully done that it is impossible to say whether the whole is a true single casting or is composed of several pieces which have been separately cast.

Rude as the appliances and methods of the Japanese art founder

which I have just described may seem to us, he has produced with them castings in bronze on all scales which, with all the modern equipments of our foundries, it would be difficult for us to excel. The simplicity, adaptability, and portable character of his appliances have been of special advantage to him in his remarkable achievements in colossal castings. Thus, when a huge image of a Buddhist divinity or a bell of unusual weight was required for a temple in any locality, the whole of the operations were conducted on the spot. Temporary sheds for the modeling were erected in the temple grounds. The furnace and blowers were transported thither in segments; sometimes the latter were even made by the local carpenters. If the casting had to be made in one piece the necessary number of cupola furnaces, each with its blower, were erected around the mold. The cost of the blast was nil, as the services of any number of eager volunteers from the crowds which congregated at the temple festival on the day of casting were readily obtained for the meritorious work of treading the blowing machines. In this way the great bells and colossal images were cast. It may be interesting to note here that the methods of heating the mold and of repairing defective castings were in use in Europe during the tenth and eleventh centuries, and doubtless at a very much earlier date. They are described by Theophilus in his valuable treatise, *De Diversis Artibus*, written in the early half of the eleventh century, and his description is practically identical with that I have just given you of them as they are practiced in Japan.

4.—THE ALLOYS USED.

The success which the Japanese artist has attained in the execution of his famous masterpieces in bronze is not, however, solely due to his methods of modeling and casting, but is largely dependent on the physical character of the alloys he has used. His alloy, par excellence, is called "karakane"—which signifies "Chinese metal"—this name having been given to it because it is believed not to have originated in Japan, but to have been introduced from China. The exact date of its introduction is unknown, but there is little doubt that it was not later than the seventh century, when the bronze coins in circulation in the country were chiefly Chinese, and it was probably in this form that the Japanese first became acquainted with it. The name "karakane" does not, however, designate any definite alloy. It has a generic rather than a specific signification, and is applied to a very varied group of mixtures of metals of the copper-tin-lead series, in which the proportion of copper may range from 71 to 80 per cent, of tin from 2 to 8 per cent, and of lead from 5 to 15 per cent.

The Table II which follows contains all the analyses of the alloys bearing this name which have been published by various analysts, as well as some which I have made myself of typical specimens. It also includes several other allied alloys which are not in such general use as "karakane," but are valuable for special purposes:

TABLE II.—Analyses of Japanese bronzes ("karakane") and allied alloys.

Description.	Analyst.	Copper.										Tin.	Lead.	Arsenic.	Anti-mony.	Zinc.	Iron.	Silver.	Sub-phur.	Gold.	Nickel.	Total.	
		Copper.	Tin.	Lead.	Arsenic.	Anti-mony.	Zinc.	Iron.	Silver.	Sub-phur.	Gold.												Nickel.
1. Temple bronze.	Maumené	88.70	2.58	3.54	0.10	3.71	1.07	99.70
2. Inense burner, eighteenth century.	Gowland	86.85	1.76	9.1340	Nil.	.33	0.079	99.699
3. Temple bronze.	Maumené	86.38	1.94	5.68	1.61	3.36	.67	99.64
4. Vase, eighteenth century.	Geerts	85.3	8.9	4.7	1.1	100
5. Cannon, eighteenth century.	Gowland	84	12.68	3.32	100
6. Vase, eighteenth century.	Geerts	83.70	5.38	7.8065185	99.38
7. Coins, "bankyu," 1863.	Gowland	83.10	3.21	11.2249	Nil.	.27	.06	0.38	100.23
8. } Old bronze ornamental vessels, probably	Morin	83.09	3.23	11.50252250	98.79
9. } vases.		82.90	2.64	10.462564	99.63
10. } Modern ornament, a tortoise		82.72	4.36	9.9055
11. Modern ornament, a tortoise	Roberts-Austen and Wingham.	81.62	4.61	10.21	99.08
12. Coins, "tempo," 1835 to 1870 A. D.	Gowland	81.31	8.26	9.7416	.63	.19	.06	.037	99.887
13. Vase (?), old.	Morin	81.30	3.27	11.05	3.27	.67	99.56
14. Temple bronze.	Maumené	80.91	7.55	5.3344	3.08	1.43	99.05
15. Coins, "do-sen," 1636 to 1768 A. D.	Gowland	77.30	4.32	15.3331	Nil.	1.01	.06	.52	99.99
16. Vase or ornament.	Kalischer	76.60	4.38	11.88	6.53	.47	99.86
17. Temple bronze.	Maumené	72.09	5.52	20.3167	1.73	100.32
18. Ornament.	Geerts	71	5.50	20.35	1.34	1.84	99.93
19. Mirror, seventeenth or eighteenth century.	Gowland	95.04	.58	3.191404	1.13	.04	100.16
20. Mirror, modern.	Atkinson	76.28	23.64	.13	100.05
21. Mirror, modern.	Hochstetter-Godfrey	75.05	16.95	7.63	99.63
22. Bronze for soldering copper.	do	67.87	29.92	.89	1.19	99.87
23. Solder for bronze.	do	37.04	1.01	61.63	.25	99.93
24. Brass coins, "shimon-sen," 1768 to 1860 A. D.	Gowland	75.62	.73	2.85	1.99	.14	16.54	1.76	.016	.09	99.756
25. Brass temple vase, eighteenth century.	do	74.52	.79	5.5012	100.22
26. Yellow bronze, "sentoku"	Roberts-Austen and Wingham.	72.32	8.126	6.217	13.102	.170	100

c Bismuth.

b Manganese.

a By diff.

TABLE III.—Analyses of ancient bronzes of various countries containing lead.

Description.	Analyst.	Copper.	Tin.	Lead.	Zinc.	Iron.	Silver.	Arsenic.	Gold.	Sulphur.
Figure of Osiris, Egypt [date?]	Gladstone	87.1	6.3	4.4	Trace.					
Cellie armet, prior to Roman occupation.	Church	8.49	6.76	4.41	1.44					
Fragment of drapery, Greek, 450 B. C. (British Museum).	Roberts-Austen and Wingham.	84.49	9.47	5.31	Trace.					
Figure of Isis, Egypt, Ptolemæic time.	Flight	82.19	2.02	15.79						
Greek vase, time of Alexander the Great, 356 to 324 B. C.	do	81.764	10.901	5.246		.153	Trace.		Trace.	Cobalt, 1.922; nickel, trace.
Coin, Claudius Gothicus, 268 A. D.	Phillips	81.60	7.41	8.11			1.86			
Roman statue of Victory, Brescia [date?]		80.8	9.4	7.7	1.9					
Figure of Apollo, from Orange (British Museum), first century A. D. [?].	Roberts-Austen and Wingham.	80.70	6.44	9.97	Trace.	Trace.	Trace.			
Coin, Julius and Augustus, 42 B. C.	Phillips	79.13	8	12.81		Trace.				Trace.
Buckle from Bohemia, prehistoric.		76.9	9.3	7.7		2.9				
Coin, Roman As Quadrans, <i>cæca</i> 500 B. C.	Phillips	72.22	7.17	19.56		.40				Cobalt, 0.28; nickel, 0.20. Antimony, 0.10; nickel, 0.13.
Statuette (fragment), Egypt [date?]	Bibra	71.46	3.60	21.54	3.07	.08				

And as a comparison of the alloy "karakane" with similar alloys of other countries is of considerable metallurgical as well as historical interest, I have given in Table III some analyses of several ancient objects, which will enable this comparison to be made.

I would also call your attention to a very valuable series of analyses of oriental art metal work made under the direction of our chairman, Professor Roberts-Austen, who has won special distinction for his researches on alloys, and published by the science and art department.

It will be seen from Table II that the presence of lead, as an important constituent, is one of the characteristic features of the composition of the Japanese bronze "karakane," although, as is shown in Table III, it is not peculiar to them. Several reasons have been advanced for the origin of the presence of this metal in copper-tin alloys; those, however, we need not discuss here. One thing is certain, that even in very early times the relative properties of copper-tin and copper-tin-lead alloys were known, as in almost all specimens which have been analyzed swords and weapons in which strength and hardness were essential consist of the former (copper-tin), and coins, decorative objects, and figures, in which these properties were not necessary, of the latter (copper-tin-lead).

The wide range in the proportions of the constituents of "karakane" is fully demonstrated by the analyses given above. This variability in composition is not solely the result of attempts on the part of the founder to produce special alloys, as might be conjectured, but is chiefly owing to the practice, universally adopted, of mixing considerable quantities of old metal "scrap" of unknown composition with the furnace charge, even when the copper, lead, and tin of the same charge have been carefully weighed in definite proportions, a practice not altogether unknown in this country. In the case of the temple bronzes, it is generally due to their having been cast from accumulations of ex voto offerings of the most heterogeneous character.

A few words on the purity of the metals used by the Japanese in preparing their alloys may not be out of place here. The copper, as will be seen from the following analyses, is almost without exception extremely free from the injurious metals—arsenic, antimony, and bismuth:

Japanese copper refined by native processes.

	Nobe-ji.	Akita.	Omodani.	Sumitomo (ma-buki- do).
Copper	99.30	99.55	99.80	99.24
Lead55	.23	.12	.49
Iron10	.15	Trace.	.05
Arsenic	Trace.	Trace.	Trace.	.04
Antimony	Trace.	Nil.	Nil.	Trace.
Silver025	.009	(a)	.022
Sulphur	Trace.	.03	Trace.	.01
Bismuth	Nil.	Nil.	Nil.	Nil.
Total	99.975	99.969	99.92	99.852

a Not determined.

Imperfectly refined copper, containing larger proportions of sulphur and iron than those given above but still comparatively free from arsenic, antimony, and bismuth, is sometimes used. When Japanese castings are unsound from vesicular cavities, the unsoundness is generally due to the sulphur in such copper. The sulphur becomes oxidized, during melting and pouring the alloy, to gaseous sulphurous anhydride, and the cavities are formed by bubbles of this gas being retained in the casting during solidification. In our own foundries this element is also too frequently the unsuspected cause of the same defects in castings.

The tin used generally contains lead, occasionally iron and copper, but rarely other impurities.

The lead is tolerably pure, excepting that it always contains a little silver.

Zinc, which is of frequent occurrence in Japanese bronzes (*karakane*), has never been added as metal, and its presence is due to the brass articles which often form part of the "scrap" of the furnace charges.

The presence of arsenic and antimony, both of which are often found in considerable amounts in these alloys, is not due to the use of impure metals, but to the addition of a pseudospoise called "*shiro-mé*"—a by-product of the desilverization of copper by lead¹—the composition of which is given in the following analysis, which I have made of a characteristic specimen:

	Shiromé.		Shiromé.
Copper.....	72.70	Silver.....	1.33
Lead.....	8.53	Sulphur.....	.33
Arsenic.....	11.37	Zinc.....	Nil.
Antimony.....	4.27	Gold.....	Trace.
Tin.....	.93		<hr/>
Iron.....	.13		99.50

The first official record we have of the use of this pseudospoise is contained in an edict of the Government in 1764, prescribing its addition to the copper-tin-lead bronze to be used in the mints for the casting of coins, but doubtless it had been similarly employed very much earlier than that date, and almost certainly in the casting of the colossal Buddha in Kioto in 1614 A. D. It was added to the alloy in order to increase its hardness without diminishing its fusibility, and to obtain in the castings a sharper impression of the mold than was possible with the copper-tin-lead alloy alone. During later years it has been used by some bronze founders because its addition to "*karakane*" has been found to facilitate the production of the gray patina, which is preferred for objects which have to be decorated with inlaid-line designs in silver.

It is almost needless to say that silver, although mentioned in temple records as having been added to the bronze used for the casting of some of their famous images and bells, has never been so added, as there is never more present than can be accounted for by its occurrence in the

¹"A Japanese pseudospoise," by W. Gowland. Jour. Soc. Chemical Industry, Vol. XIII, page 463.

copper, lead, or shiromé used. Mercury and gold, which are also erroneously recorded as constituents of some noted bronzes, do not exist in the alloy, and can only have been used for gilding their surfaces. Patches of gold have, however, been employed for the decoration of some ancient bronzes.

The chief characters on which the value of the Japanese copper-tin-lead alloys as art bronzes depend may be briefly stated as follows:

(1) Low melting point. This is of especial importance to the Japanese founder owing to the fusible nature of the clays and sands of which his crucibles and molds are made.

(2) Great fluidity when melted compared with the sluggishness of copper-tin bronzes.

(3) Capability of receiving sharp impressions of the mold.

(4) Their contraction on solidification is not excessive.

(5) Their peculiar smooth surface.

(6) The readiness with which they acquire rich patinas of many tints when suitably treated.

The advantages resulting from the above properties will be obvious to all artists in bronze. They are chiefly the result of the use of lead as one of the chief constituents of the alloys. The low melting point of these bronzes, their fluidity when melted, and the facility with which they acquire certain patinas are indeed entirely due to the use of this metal. The fine velvety surface and sharpness of the castings depend in a great measure on the structure of the mold and its comparative high temperature when the bronze is poured into it, although partly also on the influence of the lead. These alloys are, however, not without some disadvantageous physical properties, and these are also due to the lead which they contain. They are often low in tenacity, and offer but little resistance to bending and torsion when compared with simple copper-tin bronzes, even when they contain sufficient tin to enable them to hold more lead in solution than they would otherwise do. Their use is hence almost limited to the production of objects of art. And even for those art castings, such as, for example, large equestrian or other statues, where a considerable strain has to be borne by certain parts, their use is unadvisable. But in most art castings of moderate size—and even in many of colossal proportions, where the position of the center of gravity of the mass does not cause excessive tension in any part—it is not necessary that the metal of which they are cast should possess great tenacity. For all such these alloys are eminently adapted, and especially so, as by no others can the work of the artist's hand, with all its delicate and masterly touches, be so readily and perfectly reproduced.

I do not think they could be advantageously used for statues or monuments exposed to the weather in the impure atmosphere of our great towns, but for castings protected from these combined adverse influences I think the Japanese bronze, "karakene," is worthy of a trial. As we have seen, the Japanese founders have no fixed or stand-

ard composition for their alloy. I may hence be permitted to suggest the proportions in which, in my opinion, the metals should be mixed to produce a bronze which, for castings of moderate size and thickness, would secure many of the advantages possessed by it. They are as follows:

Metal.	A.	B.
Copper.....	88	88
Tin.....	7	6
Lead.....	5	5
Zinc.....	0	1
Total.....	100	100

The zinc to be omitted from castings with very delicate lines of ornament.

Specimens of each of these alloys are on the table for your inspection, also a specimen of ordinary gun metal, C, containing 2 per cent of zinc, for comparison with them. They do not differ much in tensile strength, that of A being 13.25 tons, of B 12.19 tons, and of C 14.29 tons per square inch. These alloys have been kindly prepared for me, and their tensile strengths determined by the Broughton Copper Company (Manchester), who are specially skilled in the manufacture of copper alloys.

. The other alloys, which are not contained in the "karakane" group, do not require a lengthy consideration, as they are much less frequently made use of by artists. Thus the simple copper-tin alloys which were employed in prehistoric times are not found in use after the introduction of "karakane" from China until comparatively recently, and then only occasionally for mirrors.

Neither have the copper-zinc alloys, "Shinchu," or brass (Table II, Nos. 24 and 25), been much in favor among artists. They were unknown in Japan before the establishment of Buddhism, and were probably introduced contemporaneously with that religion from China (sixth century A. C.). Their use in art has been almost exclusively restricted to the production of the ceremonial vessels and utensils of temples and shrines, and especially for the "Go-gusoku," or five ornaments of the Buddhist altar.

Even when a yellow metal is needed for the purposes of decorative ornament brass is seldom used, copper coated with gold being preferred, the rich color and quality of the gold surface being more pleasing to the Japanese than the harsher tones of the copper-zinc alloy. Hence there is scarcely a single example in the country of any great work of art executed in brass.

Occasionally the yellow bronze, "sentoku" (Table II, No. 26), consisting of copper, tin, and zinc—an alloy occupying an intermediate position between "karakane" and brass—is used instead of the latter alloy. It is, however, probably not older than the fifteenth century. An old Chinese legend records that it was accidentally discovered after

the destruction of a temple by fire, when the bronze, brass, and gold vessels of the altar were melted together into a mass. The beautiful color of the metal attracted the attention of some art founders, who, after numerous unsuccessful attempts, at last succeeded in producing an alloy resembling it. Gold is said to be an essential ingredient in its composition, but I have not found any in the specimens I have examined. It is not in very common use. Vases and other objects cast of it—generally with but little ornament in relief—are occasionally met with, but the finest specimens are found among the guards and other ornamental furniture of the sword, and all are chiefly notable as examples of chasing rather than of founding, or for the beautiful color and texture of their surfaces.

The method of preparing or melting bronze is, as is well known to all founders, secondary only to its correct composition, and as it has such an important influence on the character of the castings, one or two points relating to it, derived from my own experience, may be briefly considered here. Cupola furnaces should never be used for any bronze castings. If coke is employed as fuel in them the metal will be contaminated with sulphurous anhydride (SO_2), and the casting will be vesicular. This may be avoided by using charcoal, but with either fuel the bronze will be of uncertain composition. The Japanese method is in this respect decidedly faulty.

For castings of small or moderate size the bronze should be melted in plumbago crucibles. For large castings requiring the contents of several crucibles a vessel of sufficient capacity should be provided into which the metal from all the crucibles should be poured, and then from it into the mold.

The bronze should not be stirred with iron rods, or it will be contaminated with iron, but with plumbago stirrers. This method should be adopted whenever practicable, even for castings of considerable size, and the fuel used should be charcoal or specially selected coke as free as possible from sulphur.

For colossal castings reverberatory furnaces must be used, and when worked with care they give satisfactory results. A point apt to be neglected in these furnaces is the proper mixing of the alloy—not a difficult matter, but requiring more supervision than is often given to it—and everyone who has had to make many castings with them will have occasionally found crusts of a white alloy attached to the sides of the hearth, indicating that some of the castings did not contain their full amount of tin.

A second point of importance which is often overlooked is the liability of the metal to absorb sulphurous anhydride (SO_2) from the products of combustion of the fuel. This may be prevented by keeping a sufficient supply of charcoal on the melting hearth while the copper is being melted, and afterwards a thick layer on its surface, and at the same time guarding against a large accumulation of ashes and clinker in the fireplace.

Another important point is the prevention of the formation of suboxide of copper (Cu_2O) during the melting of the copper before the addition of the tin and other metals, as, whenever this is formed, it dissolves in the copper, and when the tin and zinc are added it reacts with them, forming difficultly fusible oxides, which diminish very greatly the fluidity of the bronze.¹

It is prevented, to a certain extent, by keeping an excess of charcoal on the melting hearth, but too often this is an insufficient precaution, and I would strongly recommend in all cases that the copper should be treated by the process known as "poling" before the addition of the tin and other metals. This is performed by placing the end of a pole of green wood below the surface of the copper; much gas and vapor are given off, the metal is violently agitated, so that every particle is brought into contact with the charcoal on its surface, and all traces of suboxide are removed.

Phosphorus, aluminium, and manganese have each the effect of removing this oxide. They should not, however, be added in excess, but only in sufficient quantities to insure this result. The kind of copper used is also of great importance.

The purest metal obtainable should alone be employed in the preparation of bronze for valuable "cera perduta" castings, electro-deposited copper if possible, or at least what is known as "best selected" copper, and this should have an electric conductivity of not less than 98 per cent on Matthiessen's scale.

5.—STAINS AND PATINAS.

The rich patinas which Japanese bronzes acquire by age or special treatment, and which enhance so much the beauty of the artists' work, are worthy of a brief consideration, although perhaps they do not strictly come within the scope of the title of this paper. In many bronzes the beautiful color is due merely to a "stain," i. e., a colored film of infinitesimal thinness. In others the surface of the metal is altered to a considerable depth, and in these only have we true patinas. Frequently both a "stain" and a patina are produced by similar treatment, but the operations required for the latter are of a more prolonged character than for the former, and are accompanied by special manipulations, in addition to the application of what are termed pickling solutions. For the production of true patinas of the richest and darkest shades of brown by Japanese methods it is essential that lead should form one of the constituents of the bronze, and that zinc should either be absent altogether or be present only in small proportions. On the other hand, "stains" of any color can be given to metal of any composition and even to unalloyed copper.

The substances used in the operations are copper sulphate, basic

¹This can be easily demonstrated by melting a little copper in a crucible, allowing it to oxidize, and then adding zinc, when the resulting alloy will be found to be so pasty that it can hardly be poured out of the crucible.

acetates of copper (verdigris), iron sulphate, sulphur in fine powder, alum, vinegar prepared from unripe plums, and a decoction of the roots or entire plant of *Calamagrostis hakonensis* (Nat. Ord. *Gramineæ*), potassium nitrate, and sodium chloride. The most important of these reagents are the first five in the above enumeration. Various mixtures of these are dissolved or suspended in plum vinegar and water to form what are called the pickling solutions. Sometimes they are applied in the form of pastes. Some are also used singly to obtain special effects, especially the decoction of *Calamagrostis*. The proportions in which they are mixed to form the pickling solutions are different in every art foundry, even for the same patina. Hence several recipes—said to be used for special patinas—which have been communicated to foreigners, and in which these proportions are given in very exact weights, are not strictly representative of actual practice. So far as my observations go, the ingredients are never carefully weighed in making a solution, and when it is made additional quantities are so often mixed with it at the discretion of the craftsman, that after the first day of its use it is impossible to say what its composition really is. Old solutions are always preferred to new, and in many cases are added to the new in large quantities, thus still further increasing the indefiniteness of their composition. In the bronze department of the imperial mint, which was superintended by an old art worker of great skill, there was only one pickling solution for the treatment of bronze. About equal parts of copper and iron sulphates and smaller quantities of alum and sulphur mixed with varying quantities of plum vinegar, water, and old solution were used in its preparation. Almost every variety of stains and patinas, excepting red and green, were obtained by its use by varying the mode in which it was applied and the treatment of the bronze between the applications.

The processes for producing a patina by the use of these solutions are, as might be expected from what I have just stated, neither simple nor easy, and the intermediate operations on which its production depends, more than on the exact composition of the solution, are so variously modified in different foundries that I can only give you an imperfect account of their chief features within the limits of this paper.

When the casting has been freed from any adherent portion of the mold its surface, where necessary, is very carefully smoothed by lightly rubbing it with a piece of soft, close-grained charcoal or with an impalpable powder of silicious shale prepared by levigation. After its surface has been thus prepared it is sometimes boiled in a decoction of finely ground beans (*Glycine hispida*), this treatment being supposed to facilitate the action of the pickling solution.

It is then immersed in the pickling solution, which is frequently heated almost or quite to the boiling point, but sometimes to a much lower temperature. In other cases it is allowed to remain in a cold solution for many hours. After the casting has been acted on until the

required effect of this stage of the process has been obtained it is taken out and washed with water, and also with a decoction of *Calamagrostis*. It is then carefully heated over a brazier containing burning charcoal, being turned round from time to time until every part has been brought to the proper temperature. During this operation it is frequently wetted with the above decoction or with a pickling solution, and the amount of time and patience bestowed on this manipulation is almost incredible. The casting is again submitted to the action of the pickle, again heated as above described, and these operations are repeated until the desired patina has been produced.

It is obvious that large bronzes can not be thus treated. The pickling solution can only be applied to them in washes, and their action is thus merely sufficient to produce a very thin film of altered metal, scarcely, if at all, more than a stain, and the true patina only results from the action of time. A green patina, in imitation of that of ancient bronzes which have been exposed to the action of the weather, is obtained by treating the casting with plum vinegar, to which common salt is occasionally added, and exposing it to the air, and sometimes this is supplemented by burial in the ground for varying lengths of time. This patina, although often very beautiful, is, I need hardly say, of an entirely different character from the mixture of carbonates, oxychlorides, and oxides of which the true old patina consists.

It will be seen from the foregoing that much practice, careful observation, and patient labor are required for the successful performance of these operations. The artist has no definite rules for his guidance in carrying them out, each seems to have his own methods of procedure, and these he varies according to his experience. His success does not depend on the use of solutions of definite composition, or on the exact proportions of the metals in his alloys, but rather on his ability to correctly modify the manipulation of the various stages of the process, so that the patina he aims at may be infallibly produced. These are the chief features of what may be termed the "wet" method of producing patina. The oldest bronzes, however, owe their patinas almost exclusively to the action of time, and those of intermediate age generally to "dry" methods, in which they were exposed to carefully regulated temperatures in furnaces heated by charcoal. These "dry" methods have now been almost entirely displaced by the "wet" methods just described, and were not in use in the foundries in Osaka to which I had access, so that I have not seen them in operation. Several specimens of bronzes, with magnificent patinas, are exhibited from the collections of my friends, Mr. Alfred Cock, Mr. Swan, and Mr. Tomkinson.

From the account I have just given you—I fear a very imperfect one—of the methods of casting bronze in Japan, it will be seen that they do not differ very greatly from ours. The chief differences lie in the use of the artist's model itself, in the preparation of the mold, in the heating of the mold, and the composition of the bronze. All these we can imitate; but the spécial excellence of Japanese bronze

castings—the faithful reproduction of the wax model, the comparative absence of retouching, the delicacy and vigor of the relief decoration—are not due solely to these, but are the results of a combination of conditions which are only of exceptional occurrence here. Chief among these is the nature of the Japanese people, the intense feeling and love of art with which they have been imbued for centuries past, and their just and enthusiastic appreciation of faithfulness in work. These qualities have made every workman an artist, hence the patient and marvelous skill which we see displayed in all his work, as well on common articles for everyday use as on those for the special purpose of decoration. The training which the artist receives in the operations of founding is also an important factor which can not be overlooked. Besides these there is an esprit de corps in the staff of a Japanese art foundry, which is not always found in Europe, the outcome of which is that an amount of painstaking care almost incredible is exercised by all, so that the work shall be as perfect as they can make it and worthy of the renown of their master.

One word only in conclusion. I think it will be admitted by all that a sculptor should himself possess a practical knowledge of the technical processes by which his work is to be reproduced in bronze. Now in this country this knowledge can only be acquired with the greatest difficulty by our artists, as it does not form a part of any course of their art training. I would hence repeat and indorse, with the emphasis it deserves, the suggestion made by Mr. Simonds in a valuable paper on "Artistic bronze casting," read before this society nine years ago, "that studios should be established in connection with our national art schools, where the student of sculpture could be practically taught the various processes incidental to his profession of molding and bronze casting," and, I would add, the coloring of metals. It would seem to be a matter in the encouragement and development of which our society might be able to afford valuable aid. There should be no insuperable difficulties in carrying it out, and I am sure you will agree with me that if it were carried out it could not fail to be of inestimable value to our artists, and to promote in no small degree the advancement of the art of bronze founding in our country.

The magnificent bronzes which I have the privilege of exhibiting to you to-night are chiefly from the collections of my friends, Prof. W. Anderson, Messrs. W. Cleverly Alexander, Alfred Cock, E. Dillon, F. Dillon, W. E. Hennell, Sir Trevor Lawrence, Messrs. R. Mills, Alfred Parsons, Charles H. Read, F. A. Satow, W. Harding Smith, R. Phene Spiers, J. M. Swan, H. V. Tebbs, and M. Tomkinson, to all of whom I desire here to express my sincere thanks for having so kindly lent them for the illustration of my paper, and especially so as I feel that any interest it may have had is largely due to them. I also owe many thanks to M. Cernuschi for his kindness in permitting me to have photographs taken of the fine specimens in his unique collection, which I have shown you on the screen.



STUDY AND RESEARCH.¹

By RUDOLPH VIRCHOW.

Our university, since its foundation eighty-two years ago, has been in the habit of celebrating the beginning of its scholastic year with particularly solemn feelings. Among the festivals it observes, this October day above all invites self-scrutiny, a review of past successes, an examination of the methods pursued, and, on the other hand, a consideration of new problems, a survey of the future. Have we proved ourselves able to perform the tasks devolving upon us? Have we used to good purpose our means for the training of youth to fulfill the highest aims of the state and of humanity? Do we enjoy the consciousness that the hopes have been realized which our activity aroused in ourselves and in our country?

Upon the new rector rests the heavy responsibility of interpreting these and similar reflections. But who has the eloquence to sum up in a general statement all the widely diverging ideas of his colleagues? How few succeed in gaining even a superficial view of the changes unceasingly taking place in the sciences! Not one of us, we frankly confess, is an authority on all branches of human knowledge; not one can do more than judge the course of studies at the university from the point of view of his specialty, his individual experience. The temptation thus assails the speaker to discuss the branch to which he has devoted himself rather than study in general. I shall endeavor to steer clear of this danger. Forty-six years ago I became a member of this faculty in the capacity of privatdozent; for forty-three years I have been ordinarius in an out-of-town university and here, and now the confidence of my colleagues has honored me with this high post. In the interval great changes, greater than those of centuries before, have taken place in science as well as in political life. All departments of human endeavor have been remodeled, some undergoing radical transformation, others being subjected to incisive criticism. Who that has been interested in public life can have failed to note and seriously consider these great happenings? University life is surely not an isolated phenomenon amid the spiritual experiences of the nations. We university teachers are forced to keep constant watch upon all departments

¹Translation of an address by Rudolph Virchow on assuming the rectorship of the Friedrich-Wilhelm University, at Berlin, October 15, 1892.

of education, upon the elementary and secondary schools, which are to supply us with zealous young knowledge-seekers, and no less upon the instruction dispensed at the higher schools, especially the technical institutions, many of which have latterly manifested the laudable ambition to be, or at least to be called, high schools (Hochschulen). For the primary establishments the university is a constant warning to equip their wards so thoroughly that they may take in our instruction with full understanding; for the higher institutions, it is a model by which to fashion their methods and expedients. On the other hand, the university has the duty to furnish the state and society with generation after generation of well-trained young men permeated with systematic knowledge, governed by high moral views, keeping alive the sacred torch of science, and bearing it aloft through all the perplexities and darkness of daily life.

Time was when not only this exalted position of the universities was generally recognized, but when they were distinguished by great privileges, many of which are now lost. We have passed the period—a fortunate even if not a permanent condition—when universities were exposed to violent attacks, and most irksome restrictions of their liberty were demanded. But we will not forget that this university, too, established in sad days to be in the words of its founder, Frederick William III, “a nursery of better times,” fell under suspicion, and was subjected to rigid surveillance. Various reasons combined to produce so sad a condition of affairs. One of them, and I beg that you, my dear students, give it your special attention, arose out of the attitude of many students, and was due to the widespread misconception with regard to the objects of study and the position of the students.

No less a man than Johann Gottlieb Fichte was the first to give expression to this thought on an occasion similar to the present one. In his memorable address “on the only possible interference with academic liberty,” delivered on October 19, 1811, when he assumed his duties as the first rector of our university, he said, “Only he that studies is a student;” a severe dictum, but worthy of consideration. With prophetic insight he describes the consequences when students, instead of considering study their chief task, “instead of concentrating all their thinking and planning upon their chosen science,” spend their time in cherishing obsolete traditions connected with a separate, privileged student class, and in keeping up supposed prerogatives. Let it suffice to refer to this address, which every student may profitably read. Fichte was careful to point out that he was not speaking of conditions prevalent at our university, but that he had in mind the “state of affairs at other universities,” and the serious tone of his admonition plainly discloses his opinion of the gravity of the danger, so threatening, indeed, that he considered it the “only possible interference with academic liberty.”

The serious crisis which occurred a few years later, overwhelming all

the German universities, mention of which recalls the Carlsbad Resolutions, has at last vanished, and we realize with gratitude that it has left us in undiminished enjoyment of our most precious possessions—liberty of instruction and liberty of study (*Lehrfreiheit und Lernfreiheit*), possessions in which we have abundant reason to take pride when we compare our own with other European nations. Teachers and students have lost none of that independence and self-dependence which grow out of the feeling of responsibility, and are incompatible with control from without. In particular, liberty of instruction, granted as a special privilege by emperors and rulers up to the dissolution of the German Empire, has become a constitutional right in our time. Moreover, we retain the privilege of choosing our rector through our professors (*ordentliche Professoren*), and the corporate character of the university has not been called into question before the law.

To be sure many other privileges, originating when the body of students was well nigh sovereign and medieval customs determined the conditions of student life, have vanished wholly. Even academic jurisdiction, with the exception of a certain degree of disciplinary competence, has been abolished; our scepters, which appear on occasions like this, are ornaments rather than the insignia of power. The student is wholly amenable to civil law; he is a citizen, like those in other walks of life, and it behooves him to know that he now enjoys no privilege but that granted him by reason of his preparatory education, namely, liberty of study, and that to be acquired by devotion to university studies, namely, eligibility to many, in fact the highest, positions in the gift of the state. For the rest, we no longer have any academic liberty that differs from ordinary civil liberty. The student has no peculiar legal code; the academic citizen, like every other citizen of the state, must look to the constitution as the source of law. But the constitution has granted him more rights than he possessed before, especially the right of occupying himself with politics within the limits set by the constitution and by law, and exemption from the jurisdiction of special courts.

Therefore, my dear students, receive my well-meant counsel to devote yourselves to study as your first and foremost task, with high seriousness and with the consciousness of all it involves. Self-evident as it may seem, experience teaches that this admonition can not be repeated too often or with too much emphasis. It applies not alone to the last terms at the university, but to the early ones as well. The more abstruse and comprehensive the science which the matriculate student chooses as his specialty, the earlier must methodical study begin; for the instruction of the later terms is intelligible only when based on that of the earlier. The temptation to enjoy academic liberty, first of all by neglect of study, is doubtless great with a young student. Stepping out from under the rigid discipline of the gymnasium into the golden sunlight of academic liberty, he feels sensuous delight in stretch-

ing his limbs and acting in an irresponsible, improvident way. We all know the feeling, and are in the habit of treating this use of academic liberty with "academic forbearance." But a limit must be set to forbearance; for, in reality, academic liberty according to our interpretation and according to that of the state, is a very different affair. "Academic liberty" is not "liberty to do nothing," not "liberty in the pursuit of pleasure or the indulgence of the passions," but "liberty of study." This is true academic liberty, to practice which the university is opened to students.

Neither teachers nor students should forget that the aim of university work is high: general scientific and ethical culture and full mastery of some one branch of knowledge. At least once in his life, and that at the end of his university course, the attainments of a cultured young man ought to reach the tide mark of scientific research, particularly in his specialty. If he fails to gain that point then, there is little hope that he will ever take creditable rank with his scientific associates; he has the prospect of never being anything but a bungler. Let none deceive himself on this subject; only in exceptional cases does a period of study occur later in life equal in freedom to that normally granted the academic citizen.

For the full exercise of this liberty of study the first condition is love of study. Indisposition to study and liberty of study are contradictory terms. The would-be university student is at once, on entering, forced to decide what and how he will study. He who lacks desire to study will evade the issue. With such an one choice is not exercised as to the manner of studying; it wavers between studying and not studying. The university has no means of compelling study. The disciplinary and regulative measures at its command are barely stringent enough to insure attendance at lectures; only the medical faculty possesses in its examinations an institution calculated to enforce a certain degree of order in the sequence of lectures and exercises. But experience teaches that, in the absence of love of study, even this regulation fails to produce satisfactory results. How, then, can love of study be awakened?

At a great university like ours the personal influence of the teacher upon individual students is naturally very limited; only peculiar circumstances make it possible for the teacher to come into close contact with a small circle of those he addresses or, in very exceptional cases, with single individuals. His influence, therefore, is exerted in the main upon the mass of his audience, and it is reserved for a late examination to reveal to him how superficially it has touched single members of his class. It is a pleasure to be able to state that the number of students who follow the lectures with delight and success, even distinguished success, is by no means small. But it were wrong to conceal the fact that too often the complaint escapes from the teacher that his efforts have been vain. Some, indeed, go a step further, and maintain that

it is noticeable that from year to year the culture of students becomes less and less wide.

This is especially true in departments, as, for instance, jurisprudence and medicine, which, besides being wholly different from the studies pursued before entrance, are distinguished by an overwhelming fulness of new ideas. Precisely in these branches the attitude of the student during the first few terms decides his development, indeed his whole future. In such studies each lecture grows logically out of the last, and the superstructure will be a labyrinth to him who is not acquainted with every cranny of the substructure. The result is an imperfect piece of work built up on an insecure foundation, and the later influence of the teacher avails naught to fill up the gaps.

Doubtless the difficulty of the subjects taught contributes greatly to the abatement of zeal in the beginner. Yet it is precisely the beginner upon whose enthusiasm everything depends. Is it possible that the university teacher is to be held responsible for the diminution of ardor so often occurring in the early terms? Most rigid investigation will not substantiate the reproach, and, so far as I know, it has not been made, certainly not with any degree of frequency. I should say that, on the contrary, all reflection upon the matter leads to the subject of preparatory work.

This question at present engages the attention of many minds. Cultured men, and no less the state, are occupied with the problem of the changes necessary in the instruction dispensed by the higher schools, in order to secure preparation for the university of the sort conducive to the best interests of its work. My address would have to transgress its limits by far, were I to attempt the discussion of this important problem in all its phases. The disputants differ on the curriculum, on the amount of time to be assigned to each study, on the methods of teaching, arriving finally at the overburdening of pupils, mayhap also of teachers. The experience of the university teacher is wide enough to admit of his formulating an opinion on the majority of these questions; for to-day's consideration, however, a few of the less hackneyed ones will suffice.

The university teacher must first of all make two closely connected demands upon the preparatory schools. He must require that the matriculates bring to the university delight in study and ability to do independent work. As compared with these demands, the evidence of positive attainments sinks into the background. In the latter respect, each faculty sets up a different standard; but with regard to the former there is probably no appreciable variation.

As for delight in learning, it is inborn in every normally gifted child. Daily we may observe the child's pleasure at becoming acquainted with some new object, or at learning to use its organs in a new way. Its eagerness grows with every step in advance. It is an innate quality, and the use made thereof depends primarily upon the constitution of

the organs. Various differences in their actions crop out early, conditioned, as they are, by natural endowment and inherited peculiarities.

Is it presumable that this quality is peculiar to children? Surely not. It is distinctive of man in hoary age as well, so long as his organs are not in an abnormal condition, or external circumstances have not caused a disturbance or interruption. Recall the joy of the scholar, bowed down under the weight of years, when a new outlook upon the domain of science is vouchsafed him. How his delight in study is stimulated when he succeeds in grasping a new series of phenomena, be it of nature or of the human mind, hitherto unintelligible or inaccessible! How, then, were it possible to explain the absence of this common human quality in young men of culture about to join the ranks of academic citizenship? They certainly possess it, but not infrequently it has been stunted by injudicious treatment. Hence it is necessary not to create, but to reanimate it.

Under careful training, delight in learning soon develops into desire for knowledge, which refuses to stop at mere acquaintance with a fact, and urges the student to seek its explanation. It casts about for the connection between phenomena and occurrences, for their causes and history, and rests satisfied only when it has discovered their genetic and causal relations. This is the characteristic sign of a genuine desire for knowledge, and it involves the beginning of research. Proneness to investigation is also manifested by children. They are in the habit of taking to pieces objects that fall under their observation, and they imitate movements to find out what must be done to produce them. Education, then, finds all its elements ready at hand in child nature; it is merely necessary to bring them into play, and cultivate them along the right lines by concentrating the mind upon facts, keeping the interest actively engaged, confining work to the main point, and diverting the attention from objects of subordinate importance.

We are justified now in propounding the question: Is this done in our schools? In our very primary classes the child's delight in study is so materially curtailed that a considerable proportion of our people develops not legitimate curiosity, but its perverted form, inquisitiveness, i. e., the inclination to rest satisfied with an external, therefore an incomplete, understanding of a subject, and to pass quickly from one subject to another. Thus a natural quality beneficent in its character is distorted and forced into forms of expression which, not rarely harmful, at best are useless.

If the legitimate desire for knowledge is to be aroused in the child mind, that is, if it is to be trained up to a consideration of genetic and causal relations, its attention must be fixed upon historic facts. Even religious instruction, of all branches the one which depends upon almost verbal transmission of doctrines, does not confine itself to dogmatic precept, but uses sacred history as a means of illustration. Nothing, however, is so well adapted for that sort of instruction as

natural history so-called, which deals with tangible objects that furnish patent illustrations of genetic processes. Our public schools are making daily progress in the application of object lessons, and the only desideratum now is that illustrations by pictures may gradually be superseded by explanations from the object itself.

In the higher schools linguistic studies have always absorbed the lion's share of time and attention. The gymnasium being the direct descendant of the Latin school of the Middle Ages, a predilection for Latin has come down to it as an inalienable heritage. Greek, for whose introduction we are indebted to the humanists, took rank with it only later. We recognize with gratitude that this circumstance was accompanied by the beneficent result of supplying civilized Europe with a common basis of culture for those nations participating in it—those called the Western peoples in Russia. This common basis has contributed more than any other factor to the promotion of mutual understanding and the strengthening of the sense of relationship. For a long time the universal use of Latin by scholars facilitated intercourse among all classes of people in different countries.

All that has changed—changed entirely—and even those who, fully recognizing the salutary influence of the classical languages upon European culture, desire to see it perpetuated, must confess that it is impossible to restore the old conditions. The national idioms have been invested with their natural rights, and much as we may deplore the polylingual character of scientific literature, which prevents our reading a number of excellent disquisitions in the original, yet we must acknowledge that no power on earth is able to effect a change in the near future. Our educational institutions only in exceptional cases graduate men who can speak Latin or write a Latin paper with ease, and the universities, despite their reluctance, have been forced to diminish the time given to instruction in the Latin language and gradually to eliminate it from their business transactions.

From the first, the prominence of Latin was a weak point in the humanistic schools. To be sure, it was not a matter of choice with them; in their time Latin was the universal language of the church and of law, and they themselves were Latin schools. They merely continued what had become a general custom through the practice of a thousand years. But their obedience to the custom was an element of weakness in their constitution, for the productions of the classical writers of Rome ranked far below those of Greece. The best of them, indeed, owed their culture to Greek predecessors, and the school of Athens through all times maintained its preëminent place in the esteem of men. Its teaching formed the background of all scholarly work, and our occidental culture has derived from Greek literature its most stimulating ideas and its most familiar forms. Homer, Herodotus, Aristotle, and Plato continue to the present day to be the masters of the nations.

The conflict is still undecided. When Greek authors began to be read in the original, interest vanished in the works of Latin writers as literature. Nevertheless the Latin language maintained the chief place in the curriculum of the schools. But its study became less and less exhaustive; as the use of the language decreased from day to day, rhetoric was dispensed with, and attention confined to grammar. Indeed, the instruction in grammar usurped so much time that even Latin composition became a *pium desiderium*.

It is plain, then, that we have arrived at a turning point with regard to the classical languages. Discipline in grammar is not the instrument of progress needed by our youth. It does not induce that delight in study which is a condition of independent development; on the contrary, it is obvious that for many pupils, perhaps still more for many parents, it has become a hateful pursuit. Greek has been more than half abandoned; no teacher in the preparatory schools dreams of giving the general run of pupils such instruction as to fit them on graduation to read and construe Greek authors in the original. Apparently the medical faculty has most reason to lament the displacement of Greek, seeing that its science is the only one which, for more than two thousand years, has built itself up without a break on the basis of Greek works. But it can not be denied that Hippocrates and Galen have so few points in common with modern medicine that, although the latter reverently clings to Greek terminology, the study of those authors is of inappreciable importance in the judgment of diseased states. The essential value of Greek literature accordingly lies not in its technical, but in its philosophic and poetic portions, whose educational influence we are inclined to underrate at present.

In the domain of philology, however, a significant innovation has grown up, which we may proudly claim as the achievement of German scholarship, namely, comparative philology. Through it the proper place has first been assigned to the genetic element in philology. Even now it has furnished results of inestimable value in the history of civilization. Constant additions to this fund of discoveries lead us to expect that comparative linguistics will remain an integral part of higher education. Its details, naturally, will be rendered accessible only by means of university instruction. In deciding the course of the higher preparatory schools we are concerned only with the two classical and the modern languages. All that the university teacher must insist upon is that, no matter what languages may be prescribed, they be taught in a manner to train the pupil for original research and to preserve his delight in study. It remains to be seen whether new methods of teaching will effect these results.

At present we are prepared to cite subjects of instruction in which the methods of teaching are so well planned that they amply furnish the needed discipline. They are mathematics, philosophy, and the natural sciences. On the one hand, they are so abundant and diversified

in contents that the desire for knowledge is constantly stimulated, and, on the other hand, by their essential nature they offer wide opportunity for original investigation. These advantages explain why their study schools the mind of the young so thoroughly that it easily familiarizes itself with the work of any of the faculties.

Instruction in at least the elements of these branches has long been part of the regular course at our higher institutions. Only the amount of knowledge to be considered the standard has varied from time to time. The opinions of teachers and of the state officials authorized to make decisions changed frequently, and in the end the overwhelmingly philological character of their education always militated against a more extended engagement in those studies. Only the necessity of meeting the exigencies of swiftly progressing technics and of the industrial arts keeping pace therewith extorted concessions, and as it was believed that they could not be carried out at the humanistic institutions a division of labor was finally resolved upon, and produced the Real-Schule and Real-Gymnasium, and, as a further result, the higher technical schools.

The expedient has not proved successful in establishing permanent peace. We are in the heat of the conflict about the prerogatives of the different kinds of higher schools, particularly the admission of the graduates of the Real-Schule first to university courses and then to state offices. Again and again the cry resounds for a homogeneous school system, and especially for the radical reform of gymnasium methods. Probably not all these pretensions are equally just.

As a rule the universities have refused to support the demand of the Real-Schule to admit its graduates as such. They are apt to be partial to the Gymnasium. As intimated above, the interests of the different faculties with regard to the character of preparatory education are not identical. The faculties that depend upon philological aids in the furtherance of their peculiar educational mission will not be satisfied with preparatory work that assigns a more or less subordinate place to the classical languages; while those in whose departments knowledge of the ancient languages is not the indispensable condition for the understanding of their specialties must consider to what extent a full course in mathematics and the natural sciences offers adequate compensation for deficiencies in the classical education. Experience has not yet helped us to come to a decision on this point. This circumstance may, however, be adduced: Among the foreigners admitted to our various departments not a few have attended the lectures zealously and with praiseworthy results, in spite of not having enjoyed Gymnasium training in our sense of the term.

The practical requirements of the different faculties with regard to the preparatory work of the matriculates differ undeniably. It remains for the future to show whether a single sort of higher educational institution can fulfill all. One assertion can even now be definitely made.

If the classical languages are no longer able to furnish the bond that unites all the provinces of culture, a substitute can be found only in the lustrous triad—mathematics, philosophy, and the sciences—upon whose development occidental culture in all its ramifications depends.

For our present purpose it is of secondary importance to determine that this culture has its roots in the Orient—in Egypt or Babylonia. So far as we are concerned occidental culture began on the western shore of Asia Minor, among the Ionian Greeks, the first to base their speculations about the universe on the mathematical computation of celestial phenomena, and the first to create a natural philosophy which summed up in a harmonious review all knowledge and conceptions of nature and her forces. In this philosophy is contained the beginning of those general speculations upon the world characteristically called “world-wisdom” (*Weltweisheit*) by the Germans, which have gradually led to a complete transformation of the old ideas of heaven and earth and man himself; an achievement that forms the imperishable glory of Greek philosophy.

The occidental nations, it must be admitted, were very late in attaining to an understanding thereof. After the fall of Constantinople, when the Greek scholars fled to Italy and knowledge of Greek literature spread rapidly, and when in Germany the humanists arose and one university after another was founded, only then the independent spirit of research awakened in all the nations. Mathematicians and scientific men of marked originality appeared, and soon philosophers were at work accommodating the conceptions about man to the new views and sounding the very depths of intellectual life.

A little after the beginning of this momentous period he arose whose gigantic achievement civilized men are at present celebrating. Day before yesterday it was four hundred years since Christopher Columbus first gained sight of a strip of land belonging to that New World where thousands are now exulting in his memory. For him was reserved the enviable fortune to demonstrate at a stroke, by means of a hazardous experiment, the sphericity of the earth, and at the same time to open up the vastest playground ever granted to human enterprise. Let us offer due homage to his genius and energy on this spot, too. Let us not forget that, despite his errors, which at the present moment we are inclined to emphasize too strenuously perhaps, he is the creator of a new time, the time of new thoughts and new actions!

After him there was activity everywhere in the world of the intellect. Next to great mathematicians and astronomers arose physicists of the first rank; the reform movement developed in the church, and the corner stone of the modern structure of medicine was laid. Even now we are in the midst of the upheaval, but victory is everywhere on the side of the new. Our age has already earned the title of the age of the natural sciences. No branch of intellectual endeavor has been able to escape the modern influence. The Roman Church itself, the

energetic antagonist of the movement, has had to yield, and a qualified representative of the Evangelical Church, our esteemed colleague, Dillman, a few years ago made use of the following significant words in his rectorate address: "A church which is unable to stand the light of science, or is compelled to mitigate its brilliance by all sorts of colored glasses, should be laid with the dead." Truly the modern conception of life is based wholly upon the natural sciences, and no one can seriously dispute the fact.

In view thereof the question is permissible whether the young charges of our higher schools ought not to be initiated into this new knowledge to a greater degree than hitherto. We willingly concede that disputed points, upon which the authorities themselves are not agreed, shall be excluded from the instruction in the schools, and shall be reserved for the special training at the university. On the other hand, it is just to demand that a young man supposed to be sufficiently self-dependent to make proper use of academic liberty of study should be able to take in the chief results of astronomic and biologic science without danger to himself. Can he be considered mature if his whole world in a sense is closed to him? And how can the instruction at the university be expected to take effect when the young man is left without the instruments needed for his difficult work?

He needs mathematics, not for its own sake nor to be able to understand the movements of the heavenly bodies. Physics has gradually turned into a mathematical science, and even chemistry and physiology find themselves forced daily with more urgency to make delicate calculations. They enable the investigator to penetrate to the comprehension of the most recondite processes, and to learn not only to judge of the strength of living forces, but to calculate them accurately, and so regulate their practical application.

But mathematics alone is inadequate. Thinking is a necessary factor in understanding. Many have an idea that it is supererogation to make thinking an object of study; that systematic thinking is not indispensable to success. Unfortunately even logic has fallen almost into oblivion among students. At many schools the opinion prevails that it is sufficient occasionally to quote a proposition of logic. How is it possible for one who does not know the laws of thought to study psychology? How can the complex relations between spiritual acts and the physical constitution be made clear to him? The young medical student enjoys an advantage in this regard; but what can be expected of the jurist, the theologian, the pedagogue? At least the school can inculcate respect for philosophy; even that were a great attainment. The impulse to learn to think philosophically would soon assert itself.

Finally the natural sciences. What admirable topics for study and for instruction are offered by the descriptive sciences—botany, zoology, and mineralogy! It is a misconception to assume that the university teacher lays chief stress upon systematic information. By no means;

the facts of a science can be taught as well at the university. No pupil is harmed by ability to name and distinguish a number of plants, animals, or minerals. But the real discipline to be derived from the sciences ought to consist in the education of the senses, more particularly of sight and touch. At present we complain that many in our classes have no precise knowledge of colors; that they make false statements about the form of objects in full view; that they show no appreciation of the consistency and the surface characteristics of bodies. Nothing would be easier than to give an accurate description of color and form, if teachers required their pupils to make a drawing, a mere sketch, in pencil or in colors, of the objects they have observed. Such knowledge is useful to everybody; to the medical man it is invaluable, as not infrequently most important diagnoses depend upon his skill in this direction.

The experimental sciences, too, especially physics and chemistry, are essential in a complete course of study; more than anything else they reveal the genetic and causal relations of processes, and prepare the student for the methodical consideration of even the more difficult problems of biology. As a matter of course only the simpler and more comprehensible experiments can be considered in connection with a general course preparatory for academic study. But every graduate of the higher schools should at least have an inkling of this method in order to be able to form an opinion.

The enumeration of the elements that go to make up acceptable preparation for university work has been rather lengthy, not because of the multiplicity of subjects to be passed in review, but because in the present state of the question as to the relation of the university to the preparatory schools the chief consideration is the amount of preparation necessary to make university instruction profitable. To avoid misconception it should be added that many of the branches mentioned may seem superfluous to the student who means to confine himself to his specialty. But if the state intended to provide only for specialists, it could dispense with universities; it could establish separate *écoles*, as in France, or separate colleges, as in England, or separate *cœnobiums*, as in the Roman Church. If we cling to the idea of *universitas*, if we take pride in being more than an agglomeration of specialty schools, then we must look to it that there shall be real collaboration among the faculties; that general scientific culture shall accompany devotion to a specialty. If, however, we find to our great regret that we fall far short of this ideal, which we can and should attain, then the blame must be cast upon the inadequacy of preparatory work which I have sought to describe and which I expect to see remedied by means of an accurate presentation of the facts.

So long as the remedy is not discovered, nothing remains but for the university to provide instruction in certain elementary or at least preliminary subjects, which, to be sure, is a burden and a degradation, and yet rarely suffices to fill up the gaps left by the preparatory work.

The university teacher has the less time for instruction of that kind, as the university is not only an institution for study, but also an institution for research, the latter in a double sense. Our nation is accustomed to look upon its university teachers as investigators, and, on the other hand, science and the state depend upon us to train up as investigators at least a portion of the students. From this point of view we apply the term academic to the members as well as to the institutions of the university.

The old name academy, in Plato's sense, a school aspiring to the highest aims of spiritual endeavor, since the days of the Medici has been used to designate the associations of distinguished thinkers and original workers banded together for untrammelled interchange of ideas. This is the origin of the academies of sciences. In later times all imaginable sorts of academies grew up beside them; but they do not concern us now. Only the academy of sciences is charged with the progressive investigation of scientific problems as its chief task. But in Germany there are only three, at the utmost four, such academies, and their capacity is by no means large enough to insure progress in the wide domain of science. Naturally a part of their duty fell to the share of the universities, and they fulfilled it honorably, in some cases with distinction. This is the reason why the university teacher needs more time than must be devoted to mere instruction.

In the other direction, too, as I said before, in the education of new generations of original workers and teachers, a solemn obligation rests upon the universities. It is a paramount duty, upon whose efficient performance depends the steady recruiting of the ranks of the privat-docenten, a constituent element of the faculty, the nursery of future professors, which is indispensable to the prosperity of the university. Therefore we must begin early to train students as original investigators. Opportunities are ample, since governments everywhere have created institutes and seminaries in which not only guidance and instruction are offered, but also free and independent work. We have special reason to be grateful to our own Government for its indefatigable care in establishing and enlarging such institutions. The moneys expended on them are well invested. They bear abundant fruit, and we are justified in the confidence that in the future, too, funds will be forthcoming to satisfy the ever-growing needs. We are accustomed to have Prussian kings consider the founding of scientific establishments, even in most perilous times, as their sacred duty as rulers, indeed, as a means of strengthening the state. Our own university grew up under such circumstances and out of such considerations, but, not having been endowed with a sufficient sum to be independent, it must look to the state for constant help. May it to-day recommend itself anew to the favor and the provident care of our Government!



SCIENTIFIC PROBLEMS OF THE FUTURE.¹

By Lieut. Col. H. ELSDALE.

An able writer, Mr. Pearson, has recently observed in his work, *National Progress and National Character*, that few or no further leading discoveries or new departures in physical or mechanical science are to be expected; that future generations have now only to fill in the details and to supplement what has already been done.

I can not agree with him. We must not thus set limits to the inventiveness of mankind. The well-known epithet *περιφραδής άνθρωπος* will justify itself in the future as in the past. Nor can we set arbitrary bounds to the inexhaustible secrets of nature, and to the importance of the new arrangements and fresh combinations which are open to further research into them. An ever larger and larger number of fertile brains are continually at work in discovery and invention, as is clearly shown by the most cursory study of the annual publications of any of the various State patent offices. And these fresh brains start from an ever-widening vantage ground of accumulated research and proved experience. The result must surely be that important inventions and new discoveries will crowd thicker upon the world in the twentieth than in the nineteenth century. I think that we have now looming before us in the immediate future, darkly no doubt, but still very distinctly, leading discoveries in science which will constitute new departures fully as large as, if not larger than, those which have resulted from, let us say, the introduction of railways or telegraphs in the past. Their number may possibly be legion. I propose here to confine myself to the consideration of four leading problems, some, if not all, of which seem practically certain of solution in the next generation, if not in our own. And their solution will involve results of enormous and almost incalculable importance to the future of mankind.

I.

The conquest of the air is the first of them. Aerial navigation has been the dream of enterprising and inventive men in all the ages, and that dream is now drawing near to its realization.

¹From *The Contemporary Review*, March, 1894; by permission of the Leonard Scott Publication Company, New York.

The invention of balloons has no doubt given some impetus to the study of the subject, and navigable balloons of increasing speed and importance are at this moment being made on the Continent. Thus, the latest improved machine now under construction for the French war office is expected to obtain a speed of 40 kilometers, or nearly 25 miles, an hour. The navigable balloon, however, at its best, will, on a broad view, provide nothing more than a convenient stepping-stone or intermediate stage, to pave the way for the flying machine proper, which will certainly follow and supersede it in the future. Meanwhile, unless some bold inventor should bring forward speedily a true flying machine, we may expect to see successive modifications in, or progressive forms of, navigable balloons introducing the principle of the flying machine proper gradually and tentatively.

Thus, whereas at present all the weight is sustained by the balloon, in future models the greater part of the weight only will probably be gas-sustained, and the rest of the lifting power and necessary changes of elevation will be provided for by the lifting action of air screws. By and by the air screw, or air propulsion in some form, will predominate. The balloon will be first reduced to an auxiliary appliance, and then laid aside altogether. The result, of course, of its final rejection will be an immense gain in a greatly diminished resistance and a corresponding increase in speed and power.

When first it became my duty to study this subject, some thirteen or fourteen years ago, the flying machine proper was a demonstrable impossibility in the then condition of mechanical science. Since that time the problem has been attacked and its great acknowledged difficulties steadily minimized from three different quarters simultaneously. The net result has been to reduce it to far more moderate and manageable dimensions; and if a corresponding rate of progress is to be maintained for another thirteen or fourteen years, this great problem is morally certain of solution.

I do not propose here to consider the subject in any detail or to give any figures or calculations upon it, but rather to confine myself to such observations on its leading conditions as are necessary to explain and support the above statement and to indicate generally our present position on the whole question.

The problem of aerial navigation by flying machines hinges primarily, of course, on the ratio of power developed by, to weight involved in, the motor. Only thirteen years ago that ratio was simply prohibitory. Any competent mechanical engineer who considered the matter could have no difficulty in concluding that it was then practically impossible to make a motor on any large and safe working scale which would lift its own weight, much less the weight of a heavy passenger-carrying machine and passengers as well. Since that date a large progress has been achieved, and motors can now be made which, for the same weight, will give a greatly increased power. One of the latest

new departures in this line is the motor which Mr. Hiram Maxim has worked out for his flying machine. I have had the privilege of inspecting it, and can certify that, whatever be the merits or ultimate success of the machine generally, it is a marvel of mechanical ingenuity, and the motor especially develops an extraordinary and unprecedented amount of power for weight carried.

Side by side with this great increase of power in the motors, and of equal importance, perhaps, in its bearing on the general question, we must next consider the great fall in the price of aluminium, together with the progress which has been made in the study of its valuable alloys, such as the alloy with about 5 per cent of copper.

Within my recollection the price of aluminium has fallen from a guinea to about 2 shillings the ounce weight. A very moderate further fall in price—far less than the above great and recent fall of 90 per cent—and a little further corresponding progress in the study of the nature and properties of these alloys, will cause aluminium alloys to drive steel out of the market for many important engineering purposes, such as the construction of bridges of wide span. And the new metals will be of cardinal importance to aerial navigation, as they are the material upon which we must rely for the construction of the flying machines of the future.

The third direction in which very important progress has been achieved recently is the theoretical and practical study of the conditions which govern the resistance of the air and determine the laws of flight or locomotion, as well as of suspension therein. The resistance of the air is the one all-sufficient fulcrum or basis on which every flying machine must rely. In the investigation of its laws something has been done by the study of the flight of birds and the analysis of the results of instantaneous photographs of them, especially by modern French writers. For the laws which govern the flight of birds must, *mutatis mutandis*—that is, in principle—apply to all aerial locomotion. Hence, in the last edition of the *Encyclopedia Britannica* we see progress on the subject. Thus we find therein an instructive table, showing clearly that, contrary to many people's ideas upon the subject, the sustaining or wing area in all flying bodies in nature increases in a much less proportion than the increased weight to be carried. For the swallow or the sparrow has a much less proportionate area of wing than the fly, the guat, or the beetle; and the vulture or wild swan a much less area than the swallow. This is an important fundamental fact in aerial navigation, as showing that the flying machine of the future can be made of very moderate dimensions. But by far the most useful progress in this direction has been made by Professor Langley in his excellent "*Experiments in aerodynamics*," wherein he may fairly be said to have laid down, for the first time, a really sound and reliable scientific basis for the study of aerial locomotion by a series of careful experiments and well-reasoned deductions from them. We may note with

pleasure that Professor Langley is reported to be now engaged upon a model aerial machine on a working scale. Whatever its ultimate measure of success, his new experiments with it can not fail to advance the cause of aerial navigation another stage.

I repeat that the net result of modern progress in these three directions—the study of the governing conditions of the work to be done, the increase in the power of the motor necessary for doing it, and the decrease in its amount, or in the weights to be lifted—has been to bring the problem of aerial locomotion well within the range of practical men. What is now required is that the field of research and experiment should no longer be left to unpractical enthusiasts, as for the most part it has been of yore. It is high time that really competent and well-informed mechanical engineers should follow the example of Mr. Maxim and Professor Langley by turning their attention to the subject. Once let this be done, and I am satisfied that the problem will be in a fair way of solution, and can not fail ultimately of a satisfactory issue. Nevertheless, after some considerable study of the question, I have a persuasion amounting to a conviction that whatever partial or temporary success may attend all such machines as Mr. Maxim's, which depend upon locomotion through the air for sustaining power in it, the ultimate solution of the problem will be something different. That is, I believe that a really safe, workable, and reliable flying machine must be based upon the principle of dissociating the stable vertical suspension in the air, if required, from horizontal locomotion through it. Such a machine must be capable of rising vertically in the air in a dead calm, and remaining suspended in it, as apart from, or in addition to, any question of horizontal locomotion through the air. Moreover, it must be so constructed that no possible breakdown or failure in any engine or in any part of the gear will endanger the lives of the passengers. But these conditions will no doubt involve a considerable further reduction in the ratio of weight carried to power developed in the motor, and for this we must be content to await the further progress of science.

Once let this vital issue of stable suspension in the air be satisfactorily achieved in a really sound, safe, and reliable way, and the consequences which will follow from the new departure are enormous and incalculable. Locomotion through the air, as straight as an arrow from a bow, and at a hitherto unheard-of rate of speed, will immediately and easily follow, and the resulting machine is bound for light transport to distance all competition in locomotion, whether by land or by sea. For one of the special and leading advantages attaching to aerial, as opposed to all ordinary locomotion at present, is that increased speed will not involve a great and disproportionate increase of power as it does now. It is perfectly well known to every marine engineer, and to every well-informed man everywhere, that an enormous increase of power is necessary to gain a very moderate increase of speed in ocean navigation.

Thus, if a steamer with a given horsepower will run at say 14 knots an hour, if we double that horsepower we may only succeed in driving her some 16 knots more or less—that is, the doubling of the horsepower will only give us one-seventh additional increase in speed. But in aerial locomotion the conditions are radically different, and the gain is all the other way. Thus, if a flying machine with a given horsepower will run at say 50 miles an hour, with less than double that horsepower it will be likely to run 100 miles, so that the increased power required for doubling the speed is most moderate, instead of being enormous and prohibitory as it would be in water transport.

The aerial navigation of the future will not only be much swifter and more direct, being in a straight course over moor, mountain, or bog, wood, ravine, or river, but it will also be much safer than our ordinary locomotion by railway and steamer at present. For as the traffic on our railways and steamboats steadily increases, the risk of accident on the crowded lines and ocean thoroughfares, due to a set of objects all moving in one horizontal plane, increases continually, as we are already finding out in many a disastrous collision. But once let this problem of stable suspension in the air be satisfactorily solved, and we shall cut off at a stroke a whole host of causes and possible contingencies which now inevitably involve continual risk of accident. For the flying machine of the future will travel directly and independently through the air from point to point. It will incur no risks from drowsy or over-worked signalmen, from inevitable imperfections in or obstructions upon the permanent way, from chances and contingencies due to the running of excursion trains or extra traffic, from icebergs, or floating hulks, rocks, shoals, treacherous currents, unreliable compasses, or other hindrances to safe navigation. If it meet or overtake a fellow machine in the air, it has the whole wide ocean of air above or below it in which to pass in safety, besides an unlimited field on either hand. An endless number of external sources of accident will be eliminated. Once let the flying machine be stable, strong, safe, and powerful enough for its work, and it will represent the safest kind of locomotion ever invented.

It will compete with the railways for light traffic, such as the transport of mails, on terms which must apparently confer an overwhelming advantage. Thus, if we roughly set the cost of the stations along 100 miles of our English railways, and the cost, working, maintenance, and renewal of the aerial machines against the corresponding charges for engines, rolling stock, and working expenses on the line, we have the following advantages to score to the aerial line:

Annual interest at, say, 5 per cent on the first cost of 100 miles of line at £39,000 a mile, which has been about the average cost of construction of English railways.....	£195,000
Annual charge for maintenance or renewal of the permanent way, at £231 per mile	23,100
Total	218,100

This shows that in aid of the maintenance and working of 100 miles of aerial line, or as increased dividends to the shareholders, there will be an annual subsidy of more than £200,000, representing the saving on the cost of a corresponding length of railway. It will be seen that the gain is so great that it is scarcely credible that any possible increase in the working expenses of the aerial line, as compared with the corresponding charges on the railway, could swallow it up.

The revolution made in locomotion by the flying machine, whereby we shall be able to run from London to New York in perhaps from thirty-six to forty-eight hours, and from London to Paris and back between breakfast and luncheon, will be at least as great as that caused recently by the introduction of railways and steam navigation.

I can not go into the principles of construction of these aerial machines further than to say, as I have already said elsewhere in a professional publication, that they will probably be of very moderate size, much less than the huge navigable balloon for military purposes, for which they will be most valuable, and will be speedily adopted. For ordinary or civil purposes also they will no doubt be small at first, but it is impossible to set limits to their future development. The web, or superposed webs, of aeroplane, part steadying, part sustaining, which will be their leading external feature, will be inclined during flight at a very small angle with the horizontal, probably not more than $1\frac{1}{2}$ to $1\frac{3}{4}^{\circ}$. Inside this, or below it, there will be a long low car, presenting a minimum surface to the air, in which passengers, light baggage, or mails will be carried. And the machines will run, as above, at a tremendous pace, probably up to, or even exceeding, 100 miles an hour.

Finally, I repeat that if anything like the same rate of progress is to be maintained during the next ten or fifteen years as has actually been made during the last ten or fifteen years, the problem of aerial navigation by flying machines, which ten years ago was demonstrably insuperable in the then condition of mechanics, and which at present is very difficult, if not altogether impossible, will soon be comparatively easy, and will be morally certain of solution.

II.

A wise man of old, in naming three things which puzzled him, associated together "the way of a fish in the sea" and "the way of a fowl in the air." It is here proposed to follow his example, and, having disposed of the way of the fowl in the air in discussing the question of aerial navigation, to consider next whether any important new departures are not possible and even probable in marine locomotion. I believe they are quite possible and probable, whether in the immediate or in the more remote future. Any revolution which may be effected in this direction will not be as startling and wonder-provoking as the conquest of the air. Nevertheless, such a future conquest of the water, as we may perhaps call it, may prove ultimately to be of very great importance.

I believe, then, that a practical revolution in marine navigation is possible, if we only will set ourselves, with the wise man of old, to study the way of the fish in the sea. With all possible respect to the numerous professors and students and innumerable practical men engaged in marine engineering and marine locomotion generally, I would venture to challenge them to consider carefully whether they are not all, in the main, on the wrong tack. They are one and all, so far as appears by a study of all the publications, as the Engineer, Engineering, the Scientific American, etc., setting themselves steadily to gain increased speed by a continual development of the locomotive power. Successive improvements in engines, boilers, screws, economy of fuel, and so on, are all very desirable in their way no doubt. But these things seem to me unduly to monopolize attention to the exclusion of the one vital problem which appears to contain the key to the whole question—namely, the diminishing of fluid resistance. At present, as we increase the propulsive power continually, we are continually piling up extra resistance to meet and swallow it up. I repeat, that any great further progress in ocean navigation is to be sought and obtained by a careful and scientific study of the way of the fish in the sea.

The subject of fluid resistance, as the leading and governing factor in all water propulsion, may probably be novel to most readers, since, if the question has ever been publicly discussed at all, it has been in naval or other special publications. It seems necessary, therefore, to rehearse the matter briefly from the beginning.

Years ago I was informed by Mr. Brennan, the inventor of the well-known torpedo, that he applied no less than 100 horsepower to drive his torpedo at its then speed, say probably at about 24 knots an hour, or 25 at the outside. Now this torpedo is well designed to the eye and was adapted, to the best of the judgment of a clever inventor, for fluid propulsion. It is, or then was, no larger than a good-sized porpoise, or, say, a very moderate-sized shark. But anyone who on an ocean voyage has watched a school of porpoises playing round an Atlantic liner will agree with me that they experience no difficulty whatever in swimming at such a pace as this and in keeping it up apparently for an indefinite length of time.

If now we turn to any professor of physiology and ask him what power a porpoise, or a small shark of about the same size as the torpedo, can reasonably be expected to develop and maintain, he will probably tell us 1 horsepower, or, if he were disposed to be liberal, he might perhaps say 2. Anyway, whatever be the exact expenditure of force in the propulsion of the porpoise, for which I have no data and do not stop to argue, it is clear that if it were to develop anything in the remotest degree approaching to the power required to drive the torpedo at the same speed it would quickly be reduced to impotence. It would rapidly burn up and consume the tissues of its body in such an immense

production of energy, and in a few minutes we should see it floating on the water an inert and lifeless mass, instead of sporting about as lively as ever, as we actually do see it. Now, whence comes this enormous difference in the power required to propel the porpoise and the torpedo at the same speed? The answer to this question contains, as I submit, the true and proper line of development of the marine engineering of the future.

No doubt we shall be told at once that steamships can not imitate the movements of the porpoise, that his motion is a question of fluid displacement and "stream-line" action or effect, due to the sinuous inflections of his body, and of his tail especially. This is partly true, and it is not here contended that we can make ships with flexible backbones like a fish, and give them a fish-like motion. Nevertheless it appears probable, if not certain, that the main and essential cause of the enormous waste of power at present attaching to man's work, the ship or the torpedo, when compared with nature's work, the porpoise or the shark, is surface or skin friction.

That skin friction is the leading agent in rendering necessary the immense power required to propel ocean steamers or battleships through the water is clearly recognized by the chief authorities on the subject, such as Mr. White in his standard work on naval architecture. Herein he only follows on the principles which were first, I think, formulated by the elder Mr. Froude, late investigator of marine problems to the British Admiralty, in a paper read many years ago at a meeting of the British association at Bristol. In order to clear away a prevailing misconception, or popular error, which quite vitiates any sound argument on this whole subject, it seems necessary to refer to Mr. Froude's paper. Therein he demonstrated that the idea that the resistance to motion of a body through water is to be measured by "head" resistance, or the resistance of its cross section, to passage through the water is baseless and mistaken. There is really no such thing as head resistance, so that if a fairly well-designed body, such as a torpedo, were entirely immersed in a perfect fluid and started in motion at any given speed it would, if there were no surface friction, continue to move uniformly in a straight line ad infinitum. The result of this law, as applied to water, which is not quite a perfect fluid, but has some small amount of viscosity, is that very nearly but not quite all—about 98 per cent, speaking approximately from memory—of the total resistance to the motion of such a torpedo under water is due to skin or fluid friction. Any considerable reduction therefore in this friction would effect a very large corresponding gain in the speed of the submerged body, or a diminution in the power required to propel it at the same speed.

When we come to deal with the case of bodies only partly submerged, such as ships, the matter is not so simple, as a very appreciable fraction of the total resistance to motion is due to the action of waves and wind, and involves a consideration of length, depth, etc., on the part of the

ship, as compared with the magnitude, period, direction, and character of the opposing waves. Nevertheless Mr. White, to whom I again refer as the leading authority, has clearly laid down that a varying percentage, amounting always to considerably the larger half, of the total resistance to such a vessel's motion through the water is still due to surface or skin friction.

Broadly, therefore, we are brought to this conclusion, that this friction is the leading and essential cause of the great waste of power in the propulsion of all vessels of man's design, whether partly or wholly submerged, when compared with the natural propulsion of fish or marine animals, such as whales, under corresponding circumstances and conditions. Hence the question of the possible reduction of this friction is one of vast and supreme importance to the marine engineer.

Now if we saw that nature solved this problem in only one way, and that way clearly inapplicable to such bodies as steamships, we might well despair of any good result to be obtained by inquiry and investigation into the subject. Thus, if all fish, marine animals, and rapidly moving aquatic birds were all alike coated with slime like the eel we might fairly conclude that, as we can hardly hope to coat her Majesty's ironclads with perpetual slime, we may give the question up. But as a matter of fact we find on a very slight consideration of the subject that nature solves this problem in many and various different ways. The slime of the eel whereby, as we may perhaps presume, he is enabled to slip easily through the water has no sort or kind of resemblance to the rough, hard, shagreen, or tough outer skin of the shark, nor is this, again, in the least like the scales of the numerous varieties of scale fish, the fur of the otter or the seal, or the feathers of a rapidly diving bird. Here, therefore, as it appears, is a vast field open to inquiry, investigation, and experiment.

As I think, it is a much more promising field than our present system of piling up enormous engine power to meet an enormous and ever-increasing-resistance. For we have already said that the resistance to our locomotion through water at present increases in a rapidly increasing ratio as we increase the speed; whereas it seems clear that nature in her beautiful arrangements for dispensing with or minimizing skin friction contrives to avoid altogether this disproportionate piling up of resistance to increased speed. It should, however, be noted that this whole problem is greatly complicated by the question of the continual fouling of ships' bottoms, due to the growth of weeds, the shells of marine parasites, etc. Scientific investigators may propose as many elaborate antifriction surfaces as they please, but any old tar who has seen his ship frequently coated thickly with barnacles and weeds, in spite of the use of numerous patent antifouling compositions, will be likely to shake his head doubtfully over them.

This is a serious complication. It means that we must seek for some substance or some system of construction for the external coating of

our vessels which will lend itself as little as possible to the lodgment of such weeds and barnacles. And it also means probably that our ships must be overhauled in dry dock more frequently and regularly, which again will involve the construction of numerous docks at suitable ports along the ocean highways. But I submit that such measures will well repay us, if thereby we can gain a more than equivalent increase in speed.

Nevertheless I freely admit that it is very possible that no inert and lifeless surface of man's design can be or ever will be devised which will compete for the present purpose with the living skin, fur, or feathers which an all-wise Creator has specially adapted to the purpose of marine navigation according to the requirements of the various aquatic forms of life.

But we need not thereupon despair. It would be simple folly to despair of this problem so long as we are so profoundly ignorant of its true conditions. When we have thoroughly investigated the laws and working of this fluid friction and ascertained its true nature and limits, we shall then, and not till then, be justified in forming an opinion as to whether it be or be not possible to meet and deal with it successfully by methods which are practically applicable to ocean navigation.

Practical methods are the essence of the matter; for nobody is foolish enough to pretend that we can coat our ironclads externally with sealskin or with porpoise hide, and undoubtedly we are at a great disadvantage as compared with nature and her living forms. Very possibly the ultimate solution of this question may be found in the application of some new material altogether to the external coating of our vessels. Compressed paper, or compressed ramie fiber, which are now increasingly employed in America for railway wheels and steam pipes, would seem promising materials for the purpose. They admit of being molded externally into any minute grooves or tiny overlapping plates, like the scales of a fish. Little or no extra expense will thereby be incurred, as an enormous hydraulic pressure, capable of forming any required surface, is already employed in the regular course of manufacture; or they can just as easily be molded into a rough shagreen, which in form can be made a facsimile reproduction of the skin of the shark, and by their tough and strong retentive structure they would effectually protect the steel or real skin of the vessel from corrosion by the salt water. But all this is mere conjecture. Any such suggestions which any man can propound will be nothing more than conjecture, so long as we are content to remain in our present deplorable darkness and ignorance of the real governing conditions of the problem. What we most require is therefore light.

I venture to think that the lords of the Admiralty could hardly spend £2,000 or £3,000 a year, or whatever modest sum a systematic course of experiments, undertaken by a competent authority like Mr.

Froude, might cost, with greater advantage to her Majesty's navy and to the nation at large as the leading maritime power, than by spending it in such an investigation. It is easy to see the general line which a course of experiments might take. Thus one might commence with a real live porpoise, or, if smaller scale experiments and a cheaper plant be necessary, with a salmon or a pike. Tow him through the water, in a tank or pond, in a more or less inanimate and nonresisting condition, and measure carefully by chronographs and power meters the exact horsepower required to attain a given speed or the exact time and speed due to a given horsepower. Then run a steel bar through him to kill and keep him rigid, and repeat the experiments with a view to ascertain how far the rigidity of form would affect the result. Next weigh and take an exact cast of him in plaster of paris, and cause any number of models to be made, all of the same uniform pattern and weighted up to the same weight, but vary the material and surface structure of the models indefinitely, with a view to ascertain the conditions of minimum and maximum skin friction. Repeat the experiment with these various models. The result of such a preliminary course of experiment, especially if carried out on a good-sized scale, say with models of a large porpoise or a shark, could not fail to be most valuable and important. It would establish incontestably, once and for all, whether I am correct in believing that there is any such large difference between the power required to tow a torpedo through the water and that required for a fish or marine animal of a corresponding size. If so, we should learn generally how, by further systematic investigation, to determine the real and essential conditions on which this difference hinges. Thereby we should probably see eventually the best way of minimizing fluid friction in practice. It should be borne in mind that, if we could only gain a knot an hour in the speed of an ironclad or an Atlantic liner for a given horsepower, the result would be very important, and would amply repay any possible cost and trouble in the experiments.

It would probably be found that a smooth surface of iron or steel is about the worst which we can give to our ships. For a smooth metal surface has apparently the property of attracting and detaining the particles of water in contact with it, whether by molecular attraction or otherwise. Thereby the water in immediate contact with the vessel's side or bottom is drawn along with her, and its particles communicate their motion to an outer circle of particles, and so on till a vast mass of water is set constantly in motion along with the ship. This is precisely what we want to avoid, as the essence of the reduction of fluid friction is to slip easily through the water with the least possible disturbance. Herein lies, as I imagine, the great advantage of the surface structure of the fish. It would probably be found by experiment that an exact model of a fish in any ordinary material, as wood, iron, steel, etc., when towed through the water at a given rate, would communicate motion to

a straw or light floating object lying near its course to a far greater extent than would the real fish passing through the water at the same speed. Experiments on this point would be easy, and would be as valuable and suggestive when applied to different materials and surfaces as the former suggested experiments on horsepower.

Nature seems to abhor generally a really smooth or polished surface for water propulsion. Thus, if we put a piece of the skin of the sole under the microscope we shall see that it is composed of overlapping layers of scales. On the lower or outer end of each scale we see a number of small projecting horns or points. I can only presume that the particles of water in most immediate contact with the fish are passed on from scale to scale like the rain running off a slated roof without pausing to adhere to any individual scale, and that their disengagement without adhesion or friction arising from molecular attraction is facilitated in some way by the projecting rows of points. Further similar and collateral investigations will easily suggest themselves. But enough, and perhaps more than enough, has been said. I will therefore conclude this discussion by repeating that the question of the reduction of fluid friction is one of primary importance to the whole future of ocean navigation, and that it is high time that the attention of competent marine engineers should be directed to the subject.

So far I have confined myself to this question of fluid friction, as a thorough study of its laws constitutes, it is contended, the proper and the only sound and scientific basis for the marine engineering of the future. But we must not stop there. It does not require the trained perception of a naval architect to see that we must go further. I hope that the majority of such skilled specialists, who take a broad view of the present position of their profession, will agree with me that the next step after we have eliminated as far as possible, or brought down to an irreducible minimum, the all-important element of fluid friction, will be to set ourselves to reduce similarly to a minimum the other important retarding element of wave action. This means probably, in the case especially of cargo-carrying steamships, the adoption of a vessel of the American whale-back type, or some suitable modification of it, with a light commodious superstructure for the convenience and comfort of passengers and crew.

Should we be fairly successful in these two distinct objects, the reduction to a minimum of fluid friction by suitable modifications in the external materials and structure of our ships, and the similar reduction of retarding wave action by the employment of a long, deep, mainly submerged vessel, the ocean steamships of the future may perhaps run at 40 or even 50 knots an hour without any undue or extraordinary increase in propulsive power.

It is at present quite impossible to give any estimate of the magnitude and importance of the issues involved in a successful solution of

these problems. This will entirely depend upon the extent to which we can reduce the fluid resistance. If we can eventually approximate in any considerable degree to the easy course of the fish, the result will amount to a complete revolution in ocean navigation.

III.

In order not to prolong this paper unduly I will only briefly mention two more distinct subjects in which there seems to be room for probable large new departures in the future, and at no remote date.

The problem of how to extract the stored-up power in coal without burning it is of the first importance to the whole future of physical and mechanical science. It is generally admitted that the very best designed furnace is but a lame and most wasteful way of utilizing the vast reservoir of potential work in a ton of coal. The leading chemists and professors of science are aware of the magnitude and importance of this problem, and no doubt many able and competent brains are now at work upon it. The question, if I rightly apprehend it, amounts to this: How can we best, by some simple and practical process, reduce coal to a condition in which it will, when brought into conjunction with the inexhaustible reservoir of oxygen in the atmosphere, give us the necessary elements for the production of an electric battery? The successful solution of this problem will constitute a new era in science and lead to results of vast and incalculable importance in the future. It is quite possible that its early solution, by supplying us with the necessary conditions for the production of power in an extremely light and portable shape, will greatly hasten and facilitate a successful attack upon the first discussed problem of aerial navigation.

Lastly, the problem of how to reduce the vegetable foods, which at present are only adapted to animals like the cow, the sheep, or the horse, to a condition suited to the human digestion and to the human palate is one of great importance. The chemical constituents of these vegetable foods, such as grass, are similar to those which we now consume in various existing foods, and they are adapted to the requirements of the human frame. It is only a question of digestion. It can hardly be but that with the continual progress of organic chemistry and medical science some means will sooner or later be discovered of solving this problem. If the process can be brought to a cheap and workable shape the sources of our food supply will be greatly enlarged and extended at a time, perhaps, when increasing population and a growing pressure in the struggle for existence will render such a result most opportune and welcome to the world.



THE FOUNDING OF THE BERLIN UNIVERSITY AND THE TRANSITION FROM THE PHILOSOPHIC TO THE SCIENTIFIC AGE.¹

By RUDOLPH VIRCHOW.

A pleasant task is set the orator on this day. The son of the founder of our university made choice of his father's birthday as the occasion on which to renew annually in festive assembly the memory of King Frederick William III, and to keep alive among all classes the feeling of gratitude for his high-minded deed.

The task has gradually increased in difficulty. For many years we were accustomed to listen to men at this celebration who had helped to rear our university, which enjoys the honorable distinction of bearing the name of Frederick William. As living witnesses they were qualified to give testimony of the intentions which underlay the beginnings of the great work. Their personal experiences enabled them to recount the difficulties that had to be overcome in order to realize the fundamental ideas. As contemporaries of the founder finally they could justly claim attention when they spoke of the successes obtained by the new institution, and of the impediments which had often opposed themselves to the inner and outer development of academic life. With what reverent attention we younger men harkened to the words dropping from eloquent lips, and how wide were the circles that expected to hear in them a sober and frank judgment on the methods that had been employed and to receive advice and encouragement for the future!

The ranks of these men have been quickly exhausted; the last of them has passed away. Even the oldest of our contemporaries who saw King Frederick William III belong to a younger generation, which had a realizing sense neither of the degradation nor of the glorious reconstruction of our country. We can follow up the story of the founding of our institution only by means of historic tradition, which, it is universally conceded, is fragmentary and untrustworthy even in the case of recent events. We may say with some degree of certainty what we have become, but we grow dubious when we are called upon to tell how we have become what we are. The specialist has confidence in himself only when his specialty is concerned, and so it happens that most of the recent orators of this day have preferred to depict the course of development in the light of their specialty.

¹Translation of an address delivered August 3, 1893, in the main hall of the Royal Friedrich-Wilhelm University by the rector, Rudolph Virchow.

Yet not one has been able to forego the consideration of the struggle through which the idea of the establishment of this university culminated in a creative act at a time of sore hardship. Often as the story has been told, it must be told anew for the benefit of youth ripening into manhood and the refinement of endeavor in all circles of academic culture. It must be instilled into them that the founding of the Berlin University was not merely an act of highest political wisdom, but also an eminently moral deed.

As early as his crown prince days, Frederick William had been drawn into the surging flood that was soon to submerge the whole of Europe. He had been compelled to take part in the unfortunate campaign against revolutionary France, which had shattered Prussia's strength. His father's last political act of importance, the third partition of Poland, had burdened him with a heritage whose baneful influence made itself felt for many days. He had assumed the reins of government filled with the most benevolent and the noblest intentions for the weal of his subjects. To his own country he promised economy and far-reaching reforms; to foreign countries, strict neutrality. He devoted himself earnestly to the affairs of government, not in the perfunctory fashion of a mere administrator of the highest power, but with the positive energy of a true reformer. Then it was, as we know, that the idea of founding a university at Berlin occurred to him and grew strong. In vain! The march of European affairs, to whose complication Frederick William II had greatly contributed, with fatalistic logic dragged Prussia into ruin. A single battle annihilated the army, and with it the state of Frederick the Great. What the arms of the enemy had left undone was completed by the treachery and the folly of the leaders. The King could save the remnant of the loyal brave only by leading it back across the Vistula. All the provinces beyond the Elbe were lost; the rest, impoverished, bereft of practically all their resources, appeared to be easy booty for the conqueror. To hope for better days was by most held to be audacity.

And there were audacious men in Prussia. The severity of the oppression, the monstrous ill-usage to which the people—to which even the King and his family—were exposed, aroused the desire for revenge and the longing for deliverance from alien rule in unsuspected strength. To a greater extent than for centuries personal interests sank into the background to make room for the great thought of patriotism and liberty. Out of the chaos of passions sprang up idealism—that German idealism which was soon to become the hobgoblin of the conqueror. How long since nothing had been heard of a German Vaterland! And now the poet's cry rang out, "Our country must be wider." How few had harbored the thought that such a Vaterland might become the rock of civic liberty and peace, the home of the highest aspirations after culture!

With sincere gratitude we must acknowledge that the King was one

of the idealists. In the days of Memel and Königsberg he found time to pass the prospects for the future in review with faithful counselors. Depressed by the tragic fate of the country, anxious lest new efforts lead to deeper humiliation, his heart full of concern about the sad effects upon his dear ones, he still had the strength of mind to preserve his personal dignity, and not only to cling to the hope of a favorable turn in his fortunes, but also, with truly statesman-like appreciation of the circumstances, to devise ways and means whereby the rehabilitation of the people might be made possible through its own energy.

His deep religious feeling, never left him during his long reign, filled him with immutable trust in God. "With God for King and country" soon became the battle cry with which the people rushed to the bitter war, for confidence was inspired by the caution and resolution with which the tried men summoned to the King's council made all preparations for long-delayed deliverance. It had become a principle with the Government to call into unhampered action all the living forces of the State. As early as 1807 and 1808 reforms that may be described as almost revolutionary were instituted. The principle that every citizen is in duty bound to serve in the defense of his country, wholly new to the modern world, was enunciated. The way was opened for the free economic development of the rural districts and the self-government of the municipal communities. New institutions in the province of pedagogics were to offer the surest guarantee for the education of the people, and as his first and highest task the King put upon his programme the establishment of a university in Berlin.

By the cession of the western provinces, Halle, Erlangen, and a number of Saxon, Westphalian, and Rhenish universities were lost. A deputation of professors from Halle approached the King at Memel in August, 1807, to petition for the transfer of their university to Berlin. For political reasons the King felt obliged to refuse the request, but he announced his intention of creating a new university at Berlin, adding the celebrated sentiment that what the state had lost in physical forces must be replaced by spiritual forces. Accordingly, a cabinet order of September 4, 1807, decreed "the establishment at Berlin of an institution for all branches of learning in suitable connection with the Academy of Sciences."

Berlin at that time was still occupied by the French. A year passed before the evacuation on December 3, 1808. On December 13 a new cabinet was formed, and on February 20, 1809, Wilhelm von Humboldt was put at the head of the bureau of education. Now the actual work began. A few months later we find the erudite statesman in the far East occupied with what he considered his first and foremost duty, the preliminaries for the organization of the Berlin University. It was to be more, he said, than a merely local institution; by its instrumentality "German science was to be given a refuge, the hope of which had almost been relinquished." He engaged the services of a number of

distinguished scholars, secured the privileges for the new institution, and procured for it this palace in which we now are, failing to obtain only the endowment which he had demanded. On June 14, 1810, he felt impelled to hand in his resignation, but he gave up his office with the consciousness of having reached the highest practical success of his life.

At Christmas of 1809 the King left East Prussia, accompanied by his family and his councilors. A sorely tried man of 40, he returned to the capital whence his ancestors during four centuries had managed the building up of the state, of which little more than the foundations remained. He came back to the places that had witnessed the peaceful joys of his young married life, and where he had striven to insure his people's happiness by training it to the fear of God and to pure morality. How changed was all that! Yet his greatest trial was still to come. The King's dearest possession, his beautiful, high-minded wife, his solace and comfort in misfortune, who had shared all his suffering with unparalleled courage, was to be torn from his side. The insidious disease, whose ravages had long been perceptible, made rapid strides, and on July 19, 1810, the Queen succumbed.

The world knows how deeply Frederick William felt the loss, how his whole people sorrowed with him. Even at this late day, every beholder of the magnificent monument erected by the King in honor of his martyr wife is seized with admiration and grief. At the time, the remembrance of the Queen's troubles was an added incentive to the most strenuous efforts for the deliverance of the country, and so make amends, as it were, for the distress inflicted upon the noblest of women.

A chronological review of the documents pertaining to the preparations for the new university betrays by only a slight gap the occurrence of the sad event. In August the negotiations are resumed, the last for which Wilhelm von Humboldt's counsel was invited. The cabinet order appointing the first rector and the deans of the four faculties bears date September 28, and on October 10, 1810, the officers elected up to that time assembled in the university building. It was a small gathering, sixteen persons in all. The proceedings were conducted in a business-like manner, without blare of trumpets. It is evident that the troublous times weighed on all minds. Perhaps never before nor since has so momentous an act, one so long and eagerly awaited, been accomplished so quietly and informally.

Work was begun at once. On October 15 Hufeland, Graefe, and Klapproth, and on October 21 Fichte, opened their lecture courses, and on October 29, the day originally set, the majority of the professors followed suit. Small though the corps of instructors was, it was energetic and efficient; the brilliancy of their names and achievements compensate for their restricted numbers.

It is not our object to-day to enter into further details. Our anniversary celebration rather suggests a general discussion of the results

effected by the new institution. To what extent has it fulfilled the expectations entertained by the King at its establishment? And what has been its significance in the development of science?

Without boastfulness we may say that its first effect was to stimulate most powerfully the sense of nationality. Its very existence indicated that Prussia had not given herself up for lost. Its first years, to be sure, witnessed an increase in the oppression exercised by alien rule. Napoleon's Russian campaign heightened the misery of the provinces still in the possession of Prussia. The exactions levied by the enemy, despite his having become an ally, exhausted their last resources. Forced to participate in the invasion of Russia, the Prussian army revolted from the humiliation of acting as the tool for a stranger's purposes. The patriots, and with them the young who had stayed at home, applied themselves to devise means to shake off the yoke of foreign rule. A circle of enthusiastic youths gathered about Fichte, who had never given up the hope of regeneration, and had begun his inspiring addresses to the German nation even before the establishment of the university. And when finally, after the disgraceful end of the Russian campaign, resistance began to gather force in distant East Prussia; when a rising of the whole people came within the range of the possible, and resolution won the day in the King's council, then the summons to the war of liberation was nowhere obeyed more enthusiastically than in the Berlin University circles. Here all was in readiness. Teachers and students presented themselves for military service; the memorial tablet in this hall records the names of the brave who in 1813 and 1815 sealed their devotion to their country with death. So the university showed by precept and example what forces spiritual elevation creates for the service of the state.

Slowly the almost deserted lecture rooms filled up after peace was established, and a still longer time it took our academic youth to realize that their duty consisted in study and preparation for action, not in action itself. Repeatedly academic liberty was in imminent danger on account of the unbridled desire of individuals to interfere with the course of public affairs. But gradually the conviction that quiet work was the real object of study gained ground, and the palladium of academic life, namely, liberty of instruction for the teachers and liberty of study for the students (*Lehrfreiheit und Lernfreiheit*), was happily rescued from all assaults.

Along what lines did the actual development of the university proceed? Let us briefly review the aims of scholarly research before 1810; details are of course out of the question.

Since the Reformation the philosophic faculties had assumed a more and more dominating position at the North German universities. Though occupying the last place in the hierarchic series, the philosophic faculty exercised a determining influence upon the general tendency of the studies with regard to method as well as matter. In this department

classical philology and history were represented as well as mathematics and a part of the natural sciences; and philosophy in the restricted sense being added, this faculty gave clearest expression to the universality of academic instruction. The philosophic faculty was the microcosm, as it were, of the universitas. The other faculties were in this way forced into the position of specialty schools; even the medical faculties, though frequently they possessed chairs of chemistry, botany, and natural history, not wholly escaping this description. The more sturdily philosophy in the narrow sense of the term developed, the more it seemed the center, or in fact the culmination, of scholarly study. Its method was adopted as the standard for all branches.

Philosophy first developed to magnificent proportions in Halle. The Elector Frederick III founded the university at Halle in 1694, as also the Academy of Arts and of Sciences at Berlin, in order, as he said, to "make a human being of man, to cleanse him of the filth of barbarism, and give him a home on earth." In Halle philosophy, for the first time on German soil, obtained a preëminent position. Christian Wolf gathered numerous disciples about him, and they quickly spread the new manner all over Germany. Soon, however, he aroused the suspicions of the orthodox. An address, "*De philosophia Sinensium morale*," gave the occasion for a cabinet order by Frederick William I, on November 15, 1723, removing him from his position and punishing him with immediate banishment. Thus ended this first promising attempt. The recall of Wolf by Frederick II in 1740 was unavailing to make amends.

The glory of having secured for philosophy a second and long period of splendor fell to the share of the University of Königsberg, founded by Duke Albert of Prussia in 1544, to be the high school of the unadulterated Lutheran creed. But as early as the time of the great Frederick it began to lose its theologic character. Immanuel Kant, who received the professorship of logic and metaphysics in 1770, became the accepted teacher of central Europe; through his agency criticism replaced dogma. Notwithstanding this, his authority was recognized by the ecclesiastical schools; even the Catholic universities in the central provinces of Germany sent him students designed to serve as teachers at home. The rigidity of his moral system, the absolute validity of the categorical imperative taught by him, formed the connecting link between two views of life diametrically opposed to each other at every other point. Frederick William III, who had been interested in Kant's works from his crown prince days, and had entered into personal relations with him during his East Prussian exile, esteemed at its full value his high moral influence. Kant's successful career contributed not a little to the strengthening of the hopes cherished in Government circles in connection with the establishment of a new university.

These hopes centered in Fichte, one of Kant's disciples, who in fact stood godfather to our university, and at its very inception impressed

upon it, as it were, his sign manual. It had been his fortune to be teacher in Jena at that period of greatest luster, when the poet princes inaugurated a new era in literature and a host of excellent scholars joined them. Among the younger men pouring in from all sides were the brothers Humboldt, who built the bridge across which Fichte passed to the northern capital. In 1793 the professorship of philosophy was conferred upon him at Jena. This is the first step toward that departure in philosophy which, in its essence idealistic, led to "Naturphilosophie" and in quick succession transformed one branch of science after another on lines of *a priori* reasoning. Fichte was soon accused of atheism, and when a strong and agile antagonist arose in his own camp in the person of Schelling, he preferred to leave the little town of the muses. Frederick William III received him in Berlin, even before the university was organized, and so created for him the possibility of applying his idealism on the field of practical politics in a way probably never before vouchsafed to a philosopher. His fiery zeal, his eloquence, his love of liberty, insured an influence, which would certainly have become paramount for a long period after the establishment of peace, had fate not decreed otherwise. On January 27, 1814, Fichte died of typhoid fever, contracted at the bedside of his wife, who had brought the infection from the military lazaretto.

At the instigation of Schleiermacher, Hegel was proposed to the ministry in 1816 as Fichte's successor. Despite the opposing vote of De Wette, who represented that this philosopher's system contradicted Christianity and no less the reliable principles of Aristotelian logic, and in reality was but a form of "Naturphilosophie," the Government offered no objections. But the negotiations were without result on this occasion. A little while later, in 1818, the services of the ready dialectician were secured for Berlin. Everybody awaited his lectures with eagerness. The circle of his adherents grew rapidly and annually became greater. Soon his influence over the thought and speech of his contemporaries had become so decided that Hegelians were to be found in every faculty. The whole body of science was remodeled by them, and their master's terminology was carried to the remotest depths of every specialty. When, on November 14, 1831, he succumbed to the cholera on its first march through our land, he left a veritable staff of drilled disciples who undertook to continue the work in his spirit and transmit the traditions of his system to future generations. Nothing could have seemed more firmly joined than the system of this self-centered school. Theology and jurisprudence, political science, and æsthetics all wore the garb of Hegelian language and theory; only in medicine and the natural sciences the invasion had confined its depredations to individual authorities. Although the master was gone, his halo remained visible for fully a decade, one may say, up to the death of King Frederick William III, whose minister, Altenstein, himself an enthusiastic Hegelian, kept the system in power by his favor. But not

one of his disciples possessed the creative impulse, nor even the glowing enthusiasm, which move great circles of men. The pedantic, often empty phrases left as the residue of a great movement, came to be the target of ridicule, as before they had been the object of astonishment or even admiration.

Hegelianism was the last of the successive philosophic schools that grew up under the eye of Frederick William III. With "Naturphilosophie" in its more rigid, or better its more logical, development he did not come into direct contact. Its exponent, Schelling, first Fichte's disciple, then his rival, finally his successor in Jena, had soon transferred his activity to Bavaria; and there he had succeeded, by bold strictures on physiology and pathology, in attracting the attention of physicians to himself and his system. But the influence which "Naturphilosophie" did indeed obtain in medicine lasted only a short time. So far as Berlin is concerned, it might have passed without leaving a trace, had Hegel not imported many details from his old friend Schelling into his own system.

It is peculiar that a few decades later, after "Naturphilosophie" had passed its zenith, ten years after the death of Hegel, immediately after that of King Frederick William III, an unexpected turn in affairs seemed to hold out to "Naturphilosophie" the hope of filling the vacant chair of philosophy. Not long after his accession to the throne Frederick William IV called Schelling to Berlin (1841). The largest lecture halls were inadequate to hold the crowds, consisting partly of students, partly of numerous representatives of all strata of the cultured, eager to hear from his own lips the famous thinker's views, held almost equal to a revelation. It soon became evident that, as might have been imagined, the aging philosopher sought to cover up the weaknesses of his system by all sorts of mystic additions and by a correspondingly confusing phraseology, but that in thought he had penetrated neither further nor deeper. The attempt to introduce "Naturphilosophie" was soon abandoned, and with the author his system vanished from Berlin; its soil had been prepared, but also exhausted by Hegelianism.

A rapid survey of the inner history of our university reveals unmistakably that during the whole time of Frederick William III its development took place, if not entirely, certainly to all outward appearance, under the standard of philosophy. Yet this monarch was neither a philosopher in the strict sense of the word, nor an enthusiastic admirer of philosophy. On this point we have information through his biographer, the court preacher, Bishop Eylert, who was in close intercourse with him during those years. Biased by his ecclesiastical position, he may have made his report one-sided, but there is no reason for doubting its truthfulness.

Eylert says of the King: "Philosophy as such he did not care for; he was not gifted with taste in that direction. In the history of philosophy, which at least in its general features was not strange to him, he

found nothing to induce him to cultivate the study. The succession of shifting systems which it describes, wherein what has been built up is destroyed, what has been praised to the skies is degraded and censured, and ideas rejected but now appear in new guises and fresh colors, rather had the effect of instilling distrust of human wisdom into him." Eylert then describes how the King learned to love Kant: "But when," the biographer goes on, "after the death of Kant, Fichte raised a new system, and the divine homage paid to the former was transferred to the latter, who in turn was put into the shade by Schelling, and the members of philosophic dynasties continued to be deposed and enthroned in rapid succession until Hegel was called to Berlin, the King became disgusted. He lost whatever desire he may have had to work his way through the labyrinth of ideas, and ceased wholly to take interest."

It seems, then, that the King speedily arrived at the conclusion reached on devious paths by the bulk of the cultured, even by the learned. It is certain that with the death of Hegel the university was forever delivered from the magic spell thrown over it by philosophical systems. No philosopher since then has occupied, nor to be just has claimed, an equally authoritative position. But as for the conditions prevailing during the reign of Frederick William III no epithet can more comprehensively describe them than the expression, "the philosophic age."

A term of that kind is open to misconstruction. We have since then had eminent philosophers among our teachers, excellent men, fitted to explain to their audiences the nature of philosophy, the laws of thought, the method of perceiving and judging, the course and degree of intellectual development, but happily not one of them has invented a system of philosophy or sought to introduce it into the speech of our youth by the agency of artistically constructed phrases. To be sure, a strong motive for studying philosophy has thus been removed, for many minds are more attracted by what is dark and unintelligible than by what is clear and perspicuous. It is possible, too, that after the study of a definite system of philosophy ceased to be the rule, the desire to devote study to philosophy in general was permanently impaired. Among us teachers it is a recognized fact that the training of many of our students in logic and dialectics falls far short of the standard that ought to be set up for every academic citizen, indeed for every man of education. Therefore we are not wanting in admonitions to our students to make up their serious deficiencies in this direction by their own efforts. It is hard to establish since when this lamentable condition has existed. The school of "Naturphilosophie," which was productive of a host of faulty methods and invalid conclusions in its very exponents, was by its nature ill fitted to discipline students to that degree of proficiency in thinking which we at present require. In view of De Wette's discovery of a contradiction between the logic of Aristotle and that of Hegel seventy-seven years ago, consolation may be derived

from the fact that this opposition rarely crops out in the scholars of to-day. In the measure in which philosophic systems were pushed into the background, sober observation and common sense asserted themselves.

King Frederick William III must be classed among the sober-minded. It is highly characteristic of him that his intimate biographer begins the description of his mental qualities by praising his "sound, natural, common sense" as the foundation of his personality. "In a rare degree," he writes, "it (common sense) was peculiar to the King, so that it may be said that his sound, natural, undistorted good sense prevailed in all affairs, and always was his helpful companion." Therefore he loved nature, and although he had not enjoyed a comprehensive education in the natural sciences, he was wont to devote attention and thought to the phenomena of nature. And in connection with this characteristic his biographer distinctly and repeatedly gives evidence that "his closest confidant, the one who understood and stimulated him, was Alexander von Humboldt—the daily mess mate, the constant traveling companion, the intimate friend of our never-to-be-forgotten royal master."

Humboldt had also had a "Naturphilosophie" period. In Jena, in 1795, he devoted much time to the problem then occupying all minds, the half naturalistic, half spiritualistic being called vital force. The "Rhodian genius," that winsome creation of a naturalist's fancy, which he later abandoned with reluctance, will always remain interesting as a characteristic picture of the mental confusion from which even the best men of the time could not extricate themselves. Curiously, it was at that very period that Humboldt, stimulated first by Girtaner's investigation of the principle of irritability, and later more particularly by the discoveries of Galvani and Volta, was zealously engaged with his famous experiments on the growth of plants and on the irritation of the nerve and muscle fiber, which demonstrated his ability to manipulate the rigid methods of the scientist. It is touching to read in a letter dated Jena, 1797: "The conviction is growing that these experiments may sometime or other become the basis of the art of medicine, and that I may be founding a new science (vital chemistry)." More and more he turned to the empirical observation of nature, and as early as 1795 he wrote to Blumenbach: "Facts endure when philosophic structures hastily erected have long crumbled. I have always kept my facts and my theories apart. This way of observing the phenomena of nature seems to me most fruitful and thorough."

Then came his great scientific tour in America. Immediately on his return, September 3, 1804, Humboldt announced his willingness to serve the King. Frederick William received him with great distinction, and generously supplied him with the means for continuing his work. In the capacity of companion to Prince William he was sent to Paris in 1808, where he remained even after the discharge of his political mission,

until 1826, enjoying intimate intercourse with the first scientists of the century. Here he completed not only his equipment as a scientific investigator, but also his general philosophic development. In 1827 he took up his permanent abode in Prussia, and then began his close relation to the King, to whom he became a friend and counselor. For our university his return definitely marked the transition to the time of the natural sciences.

It were unjust to attribute this change to Humboldt alone. Long before his return, a solid phalanx of genuine scientists had gathered in Berlin. The Academy of Sciences and the Collegium Medico-Chirurgicum included most efficient men among its members. The latter institution indeed, even before the establishment of the university, was so fully equipped with scientific instructors and facilities for the study of the sciences, that it was worthy of being ranked with a regular medical faculty. This fact explains why the medical faculty of the newly organized university at first had the greatest number of students. There were besides other institutions, each with its corps of scholars, among them the Botanical Gardens, the Observatory, and the Library.

After all, these institutions were inadequately, in fact meanly, fitted out, and it required the benevolence of the King and the enduring interest of the ministers to develop and perfect them so as to make them accord with modern views and enable them to bear comparison with those of other States. New positions, new opportunities for work, had to be created, and Alexander von Humboldt was ever ready to give help in that respect. He may be considered the guardian angel of the natural sciences in the time of Frederick William III, and even after his death. His extensive culture, vast memory, and numerous connections enabled him to understand persons and things thoroughly and judge them without bias, while his unprejudiced, upright character guaranteed the impartial use of his influence, no matter to what calling, what nation, or creed his protégé might belong. Humboldt was the confidant not only of the scientist, but of every scholar, though the former was naturally most strongly attracted to him.

So it happened that as early as 1828 we find him presiding over the association of German scientists and physicians, which at that time, a few years after its formation, held its first meeting in Berlin. If this association, which brought together the representatives of all departments of the natural sciences for personal acquaintance and the interchange of ideas, came to exert great and lasting influence upon the development of scientific culture in Germany, then it owes this position not a little to the personal interest of Humboldt. With the Berlin meeting began the heightened activity which has made the Association of Scientists the most popular and most numerous attended of all the associations without a fixed seat. The attendance of the foremost scholars, even from foreign countries, invested its proceedings with decisive authority in the dissemination of improved methods, in pro-

moting the general spread of new discoveries, and especially in compelling the esteem of Government circles. The circumstance that Frederick William III himself appeared at a social reunion of the scientists was an evidence of telling success.

Humboldt was at that period busily urging the erection of a new observatory at Berlin. The old tower in Dorotheenstrasse, which had long served for astronomical observations, was inadequate for the subtler problems of science, now that astronomy had aims beyond the computation of the calendar. Frederick William III, who had had the new observatory at Königsberg built in days of most grievous distress, and had been made cognizant by Bessel of the importance of the celestial science, yielded to the solicitations of his experienced counselor. He granted funds for more perfect instruments, and soon afterwards for the building of the new observatory.

This grant inaugurated the new period of royal activity, which since then has made addition after addition to the scientific institutes at the capital. Some institutions of the kind had existed before. The need of a better corps for the medical care of soldiers had led to the establishment of an anatomical amphitheater in 1713; the Academy of Sciences had fitted up a chemical laboratory in its house on Dorotheenstrasse under Frederick the Great; the flower and vegetable gardens laid out in Dutch fashion by the Great Elector had gradually developed into the Botanical Gardens, so meanly furnished, to be sure, that Frederick William III had to be at great expense to remodel them completely in 1801.

On all sides the conviction was evidently taking root that the natural sciences can be understood only by the observation of nature herself, and that the effective combination of science and tangible objects requires provisions on a large scale, such as can be afforded by museums, collections, laboratories, institutes. This conviction became particularly strong when it was realized that experimentation is the most important means of forcing nature to reveal the essence, causes, and development of a phenomenon. From the closet of the philosophers no valid explanation of the facts of nature had proceeded. Since belief in magic formulas survived only in the lowest strata of the people, the formulas of "nature philosophers" found as little confidence.

Frederick William III and his ministers, to a great extent from financial reasons, confined their assistance in the transformation of scientific institutes to individual cases and to the sporadic betterment of the worst abuses. A definite attitude, assumed under the guidance of fixed principles, was never reached. Also, Frederick William IV gave more attention to the art academies than to the scientific institutions, and it was only a chain of fortunate circumstances that brought about in 1856, the latter part of his reign, the erection of the new Pathologic Institute, the first of its kind in the world.

Luckily it was not long before similar institutions for other branches

were founded, most of them on a much more magnificent scale. Under Emperor William arose the palaces of the Physiologic and the Physical Institute; the Chemical Institute was completely remodeled and an additional building erected, together with a pharmaceutical institute; then followed two anatomical institutes, the great Museum of Natural History, with the Zoologic Institute, the Hygienic Institute—in short, in the course of a few decades so large a number of buildings was erected that at present not one of the experimental sciences is left without a home of its own in Berlin, or without the instruments necessary for successful research. Nor have the institutions for the sick been neglected, the less so as the municipal authorities, in praiseworthy emulation of the example set by the Government, have erected hospitals, each with more perfect appointments than the last.

“Thus,” to cite the expression used by one of the most famous exponents of physical science, our recently departed friend, Siemens, at the second Berlin meeting of the Association of Scientists, “we have stepped into the age of the natural sciences.” Nowadays the scholar is called upon to be an investigator, and the demands made upon instruction have increased to so great an extent that the academic course of studies is arranged with a view not only of initiating the student into the methods of investigation, but also of affording him the opportunity of practicing them. There is no longer need to prove the usefulness of this sort of science. Every member of the nation is aware of the profit that accrues to the State and to society from the new institutions. Bacon’s old dictum, *scientia est potentia*, has become truth.

Surely the retrospect upon the career of our university, viewed from the height of its present stage of development, is elevating—we may tell ourselves that eighty years have sufficed to produce a complete revolution in science and instruction. He who has contributed even a mite to this consummation may look back upon his work with deep satisfaction. But it were folly to believe that we have nothing more to investigate, that we are proof against new dangers. Not even the old ones are entirely removed. Perhaps the so-called exact natural sciences, physics and chemistry, will enjoy immunity for a long time to come, inasmuch as in them we have reached a perception of the unity of the forces of nature, instead of regarding them as separate agencies. But that great host of sciences whose essential theme is life and its mysteries—biology in all its ramifications—is by no means unassailable, and it is precisely in this quarter that mysticism has always made its most redoubtable encroachments.

It took long for life, as such, to be recognized in the light of a study. The beginning of its rational observation arose not more than two hundred years ago, and of these two centuries more than three-quarters were used up in refuting the doctrine of vital force as a peculiar *δίναν* of a more or less spiritual nature. Only since we know that life means cell activity, and since we can see the living being in the cell and force

it to submit to experimentation—knowledge which the world owes primarily to our own Johannes Müller and his school—no one speaks of vital force. But this knowledge does not finally solve the question about the nature of life any more than the question about the nature of the human mind is answered by the proof that mental activity is connected with nerve substance. And so long as these are open questions, so long the gates are not closed to mysticism.

With regard to this fear, nothing is more instructive than the proceedings of the medical faculty, since 1812, on the establishment of a professorship of animal magnetism. When a considerable number of petitioners, among them sensible physicians, entreated the appointment of a professor of this branch, the minister of state, Von Schuckmann, said that, convenient though it might be to absorb wisdom during sleep, he could never consent to the employment of a master of the art, because his common sense taught him to consider it jugglery. The medical faculty and the department of medicine were also opposed thereto. A few years later the chancellor, Von Hardenberg, expressed the urgent wish to advance Wolfart and Koreff, the chief representatives of animal magnetism, and curiously enough Wilhelm von Humboldt seconded the proposition. So it happened that by a royal cabinet order the two men were made professors. This was in 1816 and 1817.

In more recent times animal magnetism has been replaced by spiritism, and at present hypnotism is making tremendous exertions to dislodge it and rise to the rank of a recognized science. It is a conflict like that with homeopathy. Will science succeed in warding off the danger, and will the Government remain strong enough to keep the paths of science free from obstructions?

Our time, so sure of itself and of victory by reason of its scientific consciousness, is as apt as former ages to underestimate the strength of the mystic impulses with which the soul of the nation is infected by single adventurers. Even now it is standing baffled before the enigma of anti-Semitism, whose appearance in this time of the equality of rights is inexplicable to everybody, yet which, in spite of its mysteriousness, or perhaps on account of it, fascinates even our cultured youth. Up to the present moment the demand for a professorship of anti-Semitism has not made itself heard; but rumor has it that there are anti-Semitic professors. He who knows the "Naturphilosophie" in all its minute branchings is not astonished at such phenomena. The human mind is only too prone to leave the difficult path of well-ordered thinking and to indulge in fanciful musing. Such aberrations can be counteracted, to speak with Schuckmann, only by sound common sense; and he who has lost good sense through a perverted education can rescue himself only by rigorous empiric work. There is nothing for it but to learn and get accustomed to explain the unknown from the vantage ground of the known, instead of choosing as the premise for fantastic deductions the dark and the unknown, as though they were new truths. The

natural sciences owe their triumphant career to their loyal clinging to actual knowledge, whence they pierced the darkness of unexplored regions. The first aim always was to search out the old law in new phenomena and so link them with the old ones. He who hopes to find a new law in every exception is no better off than he who sees a miracle in every exception.

And, as in the intellectual world, so it is in the moral world. The impulse to do the good and act uprightly rests upon the inner satisfaction experienced when we perform an action in accord with human nature, reason, and the reciprocal duties of men. The satisfaction becomes the greater if in its performance we offer resistance to the suggestions of passion, personal interest, or worldly advantage. Is a positive creed or a compelling obligation necessary for this? Is there not a moral law proceeding from our inner nature which urges us to be true and to act nobly without human statute? Was Kant's categorical imperative naught but a philosophic formula? To be sure, there is a moral education which teaches and strengthens the habit of acting justly and avoiding wrong—true morality—but in point of fact no education can create the moral impulse where it does not exist. Therefore our academic discipline leaves to students a certain measure of personal liberty, which their feeling of responsibility grants them without restriction, and which permits them to develop independently, according to the bent of their minds. They are not bound down to certain religious ceremonies; they are given no ethical code created specially for them. What we expect and demand of them now, as in former days, is the free development of a self-centered, honest, wholly fine personality. May this aim be aspired to by all that come to us; may it be reached by a goodly number! Then will the hope wherewith King Frederick William III founded and cherished this university be fulfilled.



THE INSTITUTE OF FRANCE IN 1894.¹

By M. LOEWY,

President of the French Academy of Sciences and President of the Institute.

GENTLEMEN: It is on the eve of an anniversary that the mind seems to me best disposed to yield to those reflections which every great commemoration naturally evokes in us. On the day of the celebration itself, we are apt to be overcome by the brilliancy of the solemn occasion and the enthusiasm of the moment. Since, then, custom bids me celebrate by a direct address to its members the foundation of the Institute, which will next year attain its completed century, this seems to me a fit occasion to consider not what has so often been admired in you—the picturesque variety, if I may venture to call it so, of the talents which compose each one of the academies and their totality—but rather the close union which binds into one great whole all the works of the mind, for in this solidarity I see the true reason for the existence of your society; this is its true principle, this is its true life. Such was also, as you well know, the feeling of the convention when it converted our previously isolated classes into one great whole. This creation realized the idea that the men of that period had formed of the human mind in its rich unity. It also realized the dream of a model republic, in which the autonomy of admission and the perfect liberty of individual efforts, so far from impeding rather secure that harmonious concert of action where even tradition results in progress. On that day was born the “living encyclopedia,” which so justly deserves its name. Like the other written work, it was fit that this also should see the light on French soil, and if such an example is unique in the world’s history, it will create no surprise to see that it is set by France, the home of liberal initiative, the land in which even the language seems to be the offspring of good sense. Time has shown that this bold foresight, one of the last acts of the eighteenth century, was by no means utopian. The powerful vitality of the institute is the strongest argument in favor of a brotherhood in the ideal of sciences, arts, and letters. As the part it plays in the moral and intellectual development of the nation is continually becoming

¹Address at the annual public meeting of the five academies. Translated from *Revue Scientifique*, 4th series, Vol. II, November 3, 1894.

more important, this incessant activity bears evidence to the high prestige which it enjoys throughout the civilized world.

Not only the history of the institute, but also our personal experience and careful reflection, teach us every day the advantages of our life in common. However different the tasks may be which the five academies consider their special functions, the supreme aim of all your efforts remains the same. You seek for truth in all its aspects, for the beautiful in all its forms; you strive to inspire man with a clearer consciousness of his ability to improve. In order to attain this end, we all and everywhere employ the same means; the methods we employ all have but one and the same principle—to observe and to analyze all the facts in nature and to combine them upon a basis of the unchangeable rules of reason. The arts appeal perhaps to a logic somewhat less severe, but by no means less rigorous, than that employed for algebra.

The beautiful, the ideal representative of truth, can not perish any more than the latter; hence it is subject to laws that are as much above discussion as those which govern science. The plan for a masterpiece of architecture, the composition of a beautiful symphony, may be analyzed with nearly as much precision as a geometrical problem.

The sciences, for their part, never begin and never progress without, as Bacon says, bringing man and nature nearer to each other; the system of the world in its scientific aspect is probably the most beautiful of all works of art. While science and art define the just limits of our powers, they also make us better aware of their extent and their boundary lines. Both of them finally, with all their kindred—literature, history, philosophy—teach man the same lesson of hard work, in which he is sustained by his faith in the ideal, and fill him with the consciousness of the lofty mission intrusted to his mind.

In proportion as progress is secured and accumulates in the vast domain of human activity, the identity of the ends pursued and the inevitable connection between the efforts made to reach them become daily more marked; the study of the great problems of nature and of life help us to comprehend better the marvelous harmony that rules all creation; in the boundless space that surrounds us, all created bodies, from the most minute atom to the grandest of all constellations, influence one another in some way, and their reciprocal action is subject to eternal laws; all natural forces are preserved, binding the infinitely small and the infinitely great to each other; new worlds arise, others pass away, and from one evolution to another the universe advances in perfect order toward a mysterious destiny, and we are more and more struck by the admirable relations which all parts of this infinitely complex creation entertain to each other.

At every instant some close, unthought of, connection between the most varied branches of science and art is brought to light. Who could have thought fifty years ago of the remarkably fruitful intervention of physics and chemistry in astronomy, a science

which up to that time seemed to be of a purely mathematical nature? Who could have imagined that astronomers were to find in photography and spectroscopy their most powerful means of investigation; that by analyzing with their aid the luminous rays, the only messengers through whom we are in direct communication with the stars, we could arrive at positive conclusions in regard to the physical condition of the celestial bodies, the distance which separates them from us, their rotation, their nascent state, the present period of their stellar life, and their wane? What a triumph for natural philosophy to be able to assert that the innumerable bodies in the canopy of heaven contain the same material elements as our globe!

In ascertaining the truly marvelous fact that a single luminous wave sprung from a star is enough to convey such intimate and varied knowledge, we can not help being seized with profound admiration for the sublime arrangement which holds and unites all things together in a perfect and inseparable whole. And this communication, no less surprising than accurate, which modern science has succeeded in establishing with the most remote of the heavenly worlds, inspires us with confidence in the constantly progressive advance of human intellectual power.

Unforeseen prospects are again spread out before us. We may already dimly perceive the solution of the momentous problems relative to the medium and to the mode of transmission of physical forces. It may also be that we are nearer than we think to acquiring precise notions of that primordial substance from which come all those elementary bodies that constitute the material Universe.

We are thus led to the extreme boundaries of the knowable, to the threshold of the great mysteries which it seems human curiosity will never be allowed to penetrate. As was said by one of the greatest thinkers that have honored our company, Ernest Renan, "it is here that our reason collapses; that all science stands still; that analogy is dumb. The antinomies of Kant, an insuperable barrier, loom before us."

This enigmatic unity of origin of all the substances that fill space would at once explain the connection shown by study to exist among the phenomena that seem to be most independent, and the inevitable concatenation of all the sciences whose subject is nature.

But instances of so deep an interpenetration are not found in the physical sciences alone. The close relations to one another of all the operations of the mind become every day more apparent and numerous. As we now know, the necessary preparation for successful application to historical and archæological studies comprise a knowledge of the climate, of the structure, and successive evolutions of the soil on which the human races have developed, and all the traces that these races have left behind on their passage must be rigidly investigated.

The necessity of universal knowledge asserts itself on every occasion. It was again evidenced in one of our quarterly meetings, when one of

our colleagues laid before us, with admirable clearness, his manifold investigations of a curious question in history.

This, then, is the time when, more than ever before, we must yield to the exigency of participating in the general productions of intellectual activity, to the need of universal cultivation of the mind.

But, on the other hand, the inevitable effect of this condition of things is that at no time was so desirable a requirement so difficult to fill. We are no longer living in a period when eminent minds might believe it possible to embrace the whole of human knowledge. Neither do I go so far back as the century in which Leonardo da Vinci was at once the representative of poetry, fine arts, mathematical and natural sciences. I merely refer to the times of Cuvier, of Arago, and of Humboldt, when a poet could, without being charged with temerity, have pretensions to scientific attainments and even make a lasting record, as Goethe did, in natural history.

At the present time the repeated and prodigious conquests of science and the general advance of ideas have imposed entirely novel conditions of labor on the human mind.

The grandeur, variety, and number of the discoveries that have been achieved in the latter half of this century suggest the statement that it offsets all that was done in preceding ages.

Innumerable ways are now laid open before intellectual activity. On the one hand it will henceforth be impossible to ascribe any limits to the fields of investigation in the sciences of the past, and on the other hand we are now supplied with methods of wonderful accuracy and power for observing and analyzing the most impressive phenomena as well as the most minute manifestations of nature, whose secrets we are thus more and more enabled to penetrate.

But each discovery evokes further and manifold revelations, and individual investigators are overwhelmed in the presence of new horizons that spread out before them. However extensive the faculties may be, the efforts must be confined and action concentrated on a limited field of study, as are those of the plowman working a fertile fallow land of vast expanse.

How many of the scientific men of our day could fairly assert that they have been able to master in all its recesses the science that they pursue?

We are then confronted by a condition which is apparently bound to grow unavoidably worse and seriously to hamper the soaring of human exertion.

Should we conclude, as some interpreters of Buffon's saying have done, that genius in the future will be nothing else than long patience? We do not believe it.

Our common life helps us out of the dilemma, as far as it is possible. It enables us to acquaint ourselves at once with all new attainments and to turn them to advantage. It draws every mind out of the par-

ticular sphere within which it would be prone to confine itself, and in an enlarged expanse it affords glimpses over the whole domain of thought.

It is this common life, in which each of us aims at borrowing from his neighbor his commendable qualities, that made us fond of expressing ourselves with clearness and logic; this is one of the causes of our originality, and may have been noticed not only among writers but also among scientific men.

Nor is this all: There is a consensus of opinion that great discoveries or lofty conceptions are stamped with a reflective logic, which keeps imagination within bounds, protects the scientific man from wild hypotheses, the artist and writer from false principles and errors of taste. This character of high impersonality, of prudent wisdom, whose disregard is one of the failings of our contemporaries, is found to exist in your assembly in a conspicuous degree, for yours is in that respect a privileged assembly.

Indeed all these investigations conducted by you in every direction and by every method must be harmonious, since they are the result of the same efforts, converge toward the same goal, and express the whole of human thought. By this constant collaboration you are the most vivid light of intellectual life. By its pure and brilliant rays you see the close solidarity of your endeavors; you constantly have before your eyes the ideal plan under which they are united and utilized for the better advantage of the work in which all the ages of humanity have participated—the progress of civilization. You obtain a better grasp of its main lines, you make more steady progress in the discovery of truth, and, with the assistance of all the noble qualities inherent in national characteristics, you climb with a firm step the luminous heights toward which we are driven by our destiny on earth.

In fine, while it can not be gainsaid that so great a number of wonderful results, of bold doctrines, of sublime conceptions, has stirred to its very depth the mind of our age, and has imparted to the spirit of criticism a disquieting acuteness, this is the place where we are to look for a brake and a regulator to apply to the wanderings of mysticism and skepticism, of which the one gives all up to rash imagination and the other brings all under barren animadversion.

You will preserve for the most ideal manifestations of the mind, for art and for literature, the glorious traditions of the past.

You will push aside those morbid productions, those arbitrary speculations that do not rest on the true reality of nature and of moral life, and which, instead of touching the soul with the spark of enthusiasm, pervade it with delusive bitterness.

It shall always be your pride that profound good sense, superior logic, which confer on our country its first title to glory in the history of civilization, can be said to be a sacred trust over which the Institute of France watches with pious care.

In the course of this plenary sitting, a symbol of the effective union

which now binds all the academies in common aspirations, our thoughts naturally revert to those whose death has left among us recent and lamented vacancies. It is our reverent duty, and it fills our heart with inward satisfaction, to give them a heartfelt remembrance by recalling in a few words the works and the accomplishments of our late colleagues whom death, alas, has taken from us in the course of the year. The Academy of Sciences has suffered most. The list of our losses is headed by a member of the section of rural economy, M. Chambrelent. Our lamented colleague, whose zealous activity continued to the last hour of his life, combined the highest knowledge of engineering with all the qualities of these daring pioneers of civilization, who undertake a struggle with the forces of nature and often discover in those blind and apparently dreadful agents fresh elements of fertility for the soil and of comfort for the people. A great part of his life was devoted to works of that kind, such as the erection of protecting dams in the Camargue, so frequently laid waste by the waves of the sea, the removal of torrents in the Alps, the protection of forests against fire, the digging of canals. But his chief performance, for which his memory will endure forever in the agricultural history of our country, was the reclaiming and replanting of the Landes. Nearly the whole of the vast territory, covering nearly 1,975,000 acres, which lies between the Bay of Biscay and the valleys of the Garonne and the Adour, had been for centuries unfit for cultivation and proof against civilization. In that immense desert, covered in winter with stagnant and noxious water, none but a few wandering shepherds, doomed victims of fever and destitution, were ever seen.

A few cases, widely separated, were the only exceptions. Chambrelent engaged in a persevering investigation of the causes which had allowed a few favored spots to overcome the natural barrenness of the soil. He had no sooner begun active service in the corps of ponts and chaussées (bridges and causeways) than he found the most simple and cheapest solution of that great problem. But the remainder of his life was spent in securing its application. It was no easy task, and Chambrelent had to fight manifold obstacles. The incredulity of the inhabitants whose faith had been blighted by the failure of preceding attempts, the spirit of reluctance in more enlightened circles, the mistrust and indolence which were opposed to his schemes by the executive authorities, all this seemed likely to subdue the most powerful will, the most indomitable perseverance. But nothing could shake the robust faith of this remarkable man, whose modest and affable manner concealed a manly and energetic soul.

Forsaken by all, Chambrelent resolved to teach the lesson of example and to furnish, at his own expense, an irrefutable demonstration. He purchased an extensive portion of land in one of the most desolate spots of the country. In a few years the application of his device, so simple and so easy of execution, was crowned with signal success; that barren

soil was gradually covered with woods and harvests. The aspect of the Landes will be transformed from the day when the methods of our lamented colleague shall be applied to the whole of that region, and the name of Landes will subsist only as a vestige of the past, but the memory of Chambrelent shall live through the ages in the hearts of the people, for whom he shall have proved one of their greatest benefactors.

No less severe for us was the loss of Edouard Fremy, who died at the age of 80, at the Museum, in the glorious scientific establishment the management of which had taken up a portion of his life and whose increased attractions were so largely due to his efforts. His uncommon faculty of investigation had placed him among the masters of chemistry, with every branch of which he became conversant. His numerous discoveries, especially in regard to industrial applications of chemistry, have bestowed upon him a lasting claim to the gratitude of the scientific world. Countless is the number of distinguished pupils who were formed under his teaching and of the investigators who frequented his laboratory to advantage in the forty years during which he occupied a foremost rank in French science.

Our colleague was denied the satisfaction of bringing to an end the publication of the "Encyclopedie Chimique," a monumental work, which he undertook in common with several of our members. The overwhelming fatigues of a long life wholly devoted to work had in recent years weakened the springs of his activity and cast a sort of shadow over his once bright mind. But his image still stands before our eyes as that of a man of profound observation, a sharp and clear intellect, and a high character, which won him universal regard.

A month later we followed to his last resting place an honorary academician especially lamented by his colleagues, General Favé, a highly distinguished officer, who, while he was nobly attending to his duties as a soldier, gave constant and fruitful attention to the arts of war. He wrote many papers on history and strategy, and achieved reputation by his numerous inventions, highly valuable for the national defense. No one could come in contact with General Favé without being impressed with the high cultivation of his mind, which, with his affable disposition and his exquisite courtesy, gave him a genuine fascination.

A physician has also gone from our midst. We shall cherish the memory of Brown-Sequard as one of the most original and interesting characters of our age, a deep thinker and bold investigator. That illustrious physiologist had won fame by works of the highest order long before his name became so universally known through the last and most curious of his efforts. His capacity for production was extraordinary. Always bent on the pursuit of new truths, he was obliged at times to defer the final demonstration of his general views, which thus appeared in the light of actual divination.

He was lavish of his energies, and even of his life, when it was a ques-

tion of thoroughly testing a scientific proposition, and when blood was required in his latest experiments Brown-Sequard took his own. His professional courage, carried to the point of hardihood, was well known. Down to his last day his body bore the indelible marks left by experiments which he had voluntarily undergone.

In the intellectual arena Brown-Sequard was one of the most fearless champions. The endless array of scientific facts he has brought to light and his surprisingly bold views have been the cause of passionate debates and the origin of ardent enthusiasms. The scientific movement thus started by him is an extensive one, and his many pupils, some of whom have in their turn become masters, will for a long time to come find material for deep reflection in his works.

One of the most sudden losses sustained by the Academy of Sciences during the year is beyond doubt the death of Ernest Mallard. His engineering labors engrossed all his attention for many years, and he could not, until late, enter the path of scientific research. It took but a few years to place him above the ordinary level. His efforts have put a new phase on crystallography and reduced to simple and general laws a large number of facts for which no explanation had yet been found. Mallard would have been justified in devoting his whole time to these speculative studies which were so prolific of felicitous results. Considerations of interest and humanity frequently interfered. Down to his last day he followed up technical experiments on fire damp and explosive matters, at the cost of unceasing labor and danger. He thought he could not put his high mental faculties to better use than by working for the better safety of the lowly miners.

The death of the celebrated German physicist, Helmholtz, which occurred in the month of September, has brought to us especial grief. The Academy of Sciences witnesses in his demise the disappearance of one of its most genial associates, one of the most illustrious men of the times. He first became known for his important physiological investigations; but the prolific work accomplished by him in the course of half a century embraces the whole domain of physical and mathematical sciences, and has had far-reaching consequences. Helmholtz was a veritable originator; his researches in geometry, his discoveries in optics, acoustics and physiology have secured invaluable conquests for science; it would be hard to say on which of those sciences his genius cast the most brilliant light.

Even among the most favored nations men gifted with so powerful intellectual faculties appear but rarely in the course of several generations. It is by reason of their majestic isolation that they exert a dominating influence upon the civilization of their country. Helmholtz maintained the most intimate intercourse with French savants throughout his life. The universal cultivation of his mind, the elevation of his thoughts, the nobleness of his heart won for him here the most sincere friends. To our admiration for his genius was superadded the regard bred by the qualities of his fine nature.

The archæology of France has lost M. Waddington, who was in his early days elected a member of the Academy of Inscriptions in recognition of the long years he had devoted as a zealous numismatist, an inquisitive and learned explorer, to those auxiliary sciences which have completely renovated historical methods. The epigraphy of Asia Minor is indebted to him for investigations that have opened and paved the way for further advancement. Waddington was drawn away from his favorite studies by the high public offices he was called upon to fill, at first at home and then abroad, in the service of the country. But it would ill become science to grieve over his temporary exile, for his keen and liberal mind knew how to turn to advantage his versatile attainments in the important positions he filled. Alike moderate and firm, he was enabled to carry through a series of useful reforms in public instruction, and the influence which these reforms are calculated to exert will be lasting and beneficent. Our colleague had returned to the study of archæology when death robbed science and the academy of the fruitful investigations which we were still justified in expecting.

The Academie des Inscriptions et Belles-Lettres has also had the deep sorrow of losing two of its most renowned foreign associates, Sir Henry Layard, a descendant of an ancient family of French emigrants, died at Venice on the 20th of July. As a traveler, politician, ambassador, he gave, in the most varied pursuits, evidence of high intellectual capacity, and left in many parts of the globe the marks of a tenacious and productive activity. The memorable expedition to which science is indebted for so many magnificent monuments of Assyrian antiquity was successfully led by him through manifold dangers. After landing on the left bank of the Tigris he hired a company of nomad Arabs, and was happily moved to begin excavations in the neighborhood of a village bearing the suggestive name of Nimroud. It was soon ascertained that the site of ancient Calah had been discovered. A number of low-reliefs, sepulchers, and inscriptions were thus again brought to light, thanks to Layard's bold initiative. The discoveries that were made later at Kouyundjik, added to those of our fellow-countryman, Botta, have thrown an unsuspected light on the history of that remote antiquity, and have secured for their authors a well-deserved and lasting fame.

The recent announcement of the death of Commandeur J. B. de Ross, has brought us special sorrow. In him we lose not only a celebrated savant, but also a sincere and devoted friend of our country. The members of the French school at Rome never called in vain upon him for information and support. He evidenced his good will toward them by continuous services, and his reliable learning by precious indications for their work. We had, in a manner, the first fruits of his talent, for it was at Paris that his first papers were printed. He first became known for remarkable epigraphic investigations, but his chief title to fame lies in the discovery of that portion of the Catacombs of Rome

that is most extensive and richest in memories. It was there that he found the materials for his monumental compilation of Christian inscriptions, in which he resurrects an epoch and a society in which we take the liveliest interest. On these publications so fraught with useful information, important discoveries and valuable analysis, De Rossi set the first scientific foundation of Christian archaeology. But I must desist, regretting my inability to follow in all its manifestations his comprehensive genius, and his eminent mind adorned by the most noble virtues.

The Academy of Fine Arts has also had its share of mourning. It was bereft, toward the end of January, of one of its oldest members, M. Cavelier. Upon his leaving the Villa Medicis, the young sculptor first gained celebrity by a statue of Penelope, a charming work which at once revealed a substantial talent and that soundness of taste which has ever since characterized the long list of his works.

Our colleague held with immovable conviction throughout his life to the noble conception he had formed of art and of its mission. While an eclectic in the manner of execution, he endeavored always to represent nature under its most ideal form in a classic style. Cavelier has left among his friends, his many pupils, and all those he had favored, the memory of a distinguished artist, of a kind master, and of a devoted colleague. His name, inscribed on many a sculptural composition by which our public buildings are adorned, is assured of going down to posterity, and of being cited as one of those that have reflected honor and brilliancy upon French art.

Federico Madrazo, the painter, whose recent death was a national bereavement for Spain, was doubly ours, as a foreign associate and as an artist trained in the school of the great masters who, in the first half of the century, won glory for our country. France was the cradle of his new-born talent; it was in our annual salons that he won the awards by which fame was brought to his name. His historical pictures, and chiefly his admirable portraits that embellish the finest galleries in Europe, are the highest vindication of the honors which, at home as well as abroad, crowned his long and glorious career.

The French Academy was no more spared than that of the Fine Arts. The death of M. Maxime du Camp has taken from the world of letters and of inquiry an indefatigable worker, a refined writer, a vigorous and honest polemist. Maxime du Camp leaves behind him extensive and manifold works. The marks of the romantic youth of a traveler and soldier are found in his first productions. But even during that period of juvenile enthusiasm his exuberant nature knew how to submit to the delays of patient study. Maxime du Camp thus betokened the eminent qualities that were to make the latter part of his life as a writer illustrious. His great production on Paris, a city which, like Montaigne, he loved down to its warts and blemishes, shows most admirably his ability as an investigator and philosopher always equal

to his subject. Posterity will undoubtedly apply to our colleague the ancient saying of Cicero "that qualities of honor and probity must be exhibited even in the style."

Not only the Institute, but all France, mourns for Leconte de Lisle this year. For she honors in him one of the most sterling poetic celebrities of this century. His name will live as long as his three masterpieces, "The Poèmes Antiques," the "Poèmes Carbares," and the "Poèmes Tragiques." He was engaged for thirty years in perfecting that great and magnificent work, which, by its very nature, seems to be destined for immortality.

He came to us from a distant island, a French possession lost in the tropical seas, La Réunion. It was there that he first came into the world, on the 22d of August, 1820. His parentage was from Brittany, and it may be that it was this dual origin that enabled him to depict with such fidelity the wrath of the Scandinavian seas and the splendor of Indian climes. In France he lived in obscure and modest seclusion, accessible only to the guard of honor made up of a few friends and elected disciples. These certainly knew that the illustrious recluse was anything but insensible and supercilious. A cursory perusal of his poems may have given rise to such an impression, but the testimony of those who came in contact with him and greater familiarization with his verses place him before us in the attitude not of a frigid marble god, but simply that of an ancient sage absorbed in his work and following it with patient ardor.

In 1886 the votes of the Academy sought him in his retirement. Glory did not come to his name until a very late hour. He himself never thought of complaint on that ground; he well knew that the character of his works was not such as to largely draw the admiration of the multitude. He reviews India and its religions; Greece, the birth-place of art; the restless and dark-souled barbarians in his works, and in all of them he takes a tragic and picturesque view of history, and looks upon nature as the eternal soother of all sorrows.

In history he gave preference to obscure and legendary periods. They afforded him a wider field for the description of human passions pitched to a degree of grandeur and energy which does not comport with the periods of peaceful civilization. A decided foe of the morbid sentimentality which partially pervades the literature of the first half of this century, he raised the principle of impersonality in art to the eminence of a dogma. His poetry is in a high degree stamped with the characteristics of scientific thought. It partakes of it by the logical development of the subject-matter, by the stanch erudition which leads him through the traditions of all the races, and in his poems he again brings the soul of ancient heroes into powerfully realistic life. In some of those revivals he combines the clear-sightedness of Thucydides with the fiery imagination of Lucretius.

No poet, perhaps, has been more of an artist than Leconte de Lisle.

He has written some of the most beautiful lines that ever impressed themselves upon human memory. But however perfect and polished may be, the form he never for its sake loses sight of the point; through the moving splendor of images can always be perceived a firm intelligence, a purity of sentiment, the absolute sincerity of which is attested by the dignity of his life. On greeting him as one of our greatest poets we forestall the judgment of posterity without fear of being belied by it.

All these colleagues, whose memory of recent date I have just recalled, labored, each one according to his aptitude, toward adding to the intellectual patrimony of their country. We could do them no better honor than by calling to their seats in our midst those who most worthily continued their labors.

It is said of Socrates that he was in the habit of curiously questioning even the shoemakers and fullers of a town as small as Athens, who thought that the intelligent world ended at the Piræus and the intelligible world at the pillars of Hercules; and it may be that he thought so himself; for however wise a man may be, he nevertheless belongs to his age and to his country, and such a natal pride surely brings to-day a smile to our lips.

Here, on the other hand, is another city, even much smaller than Athens; I mean the Institute. It is in France, in the most sociable country, the second home of foreigners; it receives in its midst the representatives of all the noble qualities of the mind; in fine, does it not, with its extensive ramifications in the provinces and abroad, condense, as it were, the whole of the civilized world? It tells man of nearly all he knows about himself and about the universe. Well, gentlemen, if an ideal Socrates could by questioning you come in possession of all your knowledge what would there remain for him to learn? In a word, would not the man who could unite within himself all the things that you know and succeed in harmoniously blending them be the perfect man? Let us then strive, gentlemen, to draw nearer to such perfection, and to achieve such intimate blending through ever-increasing cooperation, closer intercourse. Such is the wish I have repeatedly heard uttered about me, and which in closing I take the liberty of expressing to you.

HERMANN VON HELMHOLTZ.¹

By ARTHUR W. RÜCKER, F. R. S.

Death has been busy lately among the ranks of German physicists. Hertz, Kundt, and Von Helmholtz have all been laid low within a few months, and the world is the poorer by some of the best promise of the future and the ripest experience of the past.

The last named on this sad death roll was for long regarded as the doyen of the physical sciences in Germany. He celebrated his seventieth birthday three years ago, and on that occasion the whole world (to quote his own words) "from Tomsk to Melbourne" united to do him honor. The close of his career thus lacks the element of tragedy, which shocked us when we heard that Hertz, in his early maturity, before we had ceased to wonder at his first great success, was dead.

But the elder, like the younger man, died too soon, working to the last. He held one of the highest scientific posts in Germany. Long mathematical papers have quite recently been contributed by him to the *Berlin Berichte*. He was present at the meeting of the British Association at Edinburgh in 1892, at the Chicago Congress of Electricians in 1893. It was hoped that he would have attended the meeting of the British Association at Oxford in 1894.

No remarkable events distinguished the earlier years of Helmholtz from those of the majority of clever middle-class lads. His mother, Caroline Penn, was of English descent; his father was a professor of literature in the gymnasium at Potsdam, who, both in and out of school, did all that he could to help his promising boy. On looking back to his youth, Von Helmholtz accused himself of a "bad memory for disconnected things," but admitted that he had an unusual power for grasping and remembering the details of a connected train of thought.

When he began the systematic study of geometry he astonished his teachers with the practical knowledge of the laws of form which he had already attained, chiefly by the aid of wooden blocks. He acquired "a great love of nature," was especially attracted by physics, and confessed that while the class was reading Cicero or Virgil, he was often busy with illicit calculations under the desk.

But, though he describes his interest in the special line of study to which he subsequently adhered as "amounting even to a passion," it

¹ From the *Fortnightly Review*, November, 1894, Vol. LVI, new series, No. 135.

is evident that the passion was controlled by a strong vein of common sense. Neither at that time, nor for many years afterwards, was a living to be made out of physics. The only influential member of the family was a military surgeon. It was therefore decided that the young man should adopt the profession of his relative, and devote to his favorite science such time as he might be able to spare from more urgent duties.

It was not long before the characteristic bent of his mind displayed itself. He was the pupil of Johannes Müller, from whose laboratory came many of the most distinguished German physiologists of the last generation. The first two papers which Helmholtz published were on fermentation and muscular action, respectively, but the first effort which attracted general attraction was an essay on the Conservation of Force, published in 1847, when he was 26 years of age.

It is unnecessary to repeat the oft-told tale of how the pioneers of the great generalization, now called the conservation of energy, were for a time ignored. German physicists turned away from Mayer. England would not hear, or listened in unintelligent silence to Joule. But the year 1847 was an epoch in the history of science. Joule himself, for the first time, claimed the full extent of the territory he had conquered. "On the 28th of April, 1847," says his biographer, "Joule gave a popular lecture in Manchester, at St. Anne's Church reading room," and chose this opportunity to deliver "the first full and clear exposition of the universal conservation of that principle now called energy."

The local press would at first have nothing to do with the address. "One paper refused to give even notice of it." "The Manchester Guardian would, as a favor, print extracts to be selected by themselves." Finally the Manchester Courier, after long debate, promised to insert the whole as a special favor, not to Joule, but to his brother.

Of course no blame can attach to the newspaper men for failing to recognize the importance of views that were rejected by many of the best known scientific authorities, but the theories which in April were hawked from one provincial editor to another, found in June, when the British Association met at Oxford, an advocate who compelled attention. Joule has told the story himself. All the circumstances were depressing. An earlier paper, read some years before, had attracted little notice. The chairman, perhaps on this account, suggested that the author should be brief. No discussion was invited. In a moment the meeting would have passed to other business, and the enunciation of his views would once more have failed "if a young man had not risen in the section and, by his intelligent observations, created a lively interest in the new theory. The young man was William Thomson." The result was that the paper created a great sensation, and from that moment the tide of opinion turned.

What Thomson did in June, in Oxford, Helmholtz did scarcely a

month later in Berlin. His paper was read to the Physical Society of that city on the 23d of July, 1847. It was too clear, too powerful, and too convincing to be ignored. The line of thought which he had been following has been traced by his own hand. The study of medicine led to the problem of the nature of "vital force." He convinced himself that if—as Stahl had suggested—an animal had the power now of restraining, and now of liberating the activity of mechanical forces, it would be endowed with the power of perpetual motion. This led to the question whether perpetual motion was consistent with what was known of natural agencies. The essay on the Conservation of Force was, according to Von Helmholtz himself, intended to be a critical investigation and arrangement of the facts which bear on this point for the benefit of physiologists. In form, however, it was addressed to the physicists.

The paper was called *Ueber die Erhaltung der Kraft, eine physikalische Abhandlung*. It opens with the statement, "Vorliegende Abhandlung musste ihrem Hauptinhalte nach hauptsächlich für Physiker bestimmt werden." It was communicated to the Physical Society of Berlin. The author appears to have expected that it would there be received as a mere summary of accepted facts, and to have hoped that, having gained this authoritative sanction, he could thereafter appeal with greater force to his brother physiologists. To his surprise the physicists were not only interested, but showed a strong disposition to treat the essay as a fantastic speculation. The editor of Poggendorff's *Annalen* declined to publish it. On the other hand, Helmholtz was supported by his fellow-student, Du Bois Reymond, and by mathematician Karl Jacobi. In the end they carried the Physical Society with them.

The essay itself is full of interest. The phraseology differs from that we employ, but the use of terms now regarded as archaic is not due to any mistiness of perception. Write energy here and there for "force," potential energy for "tension," as defined in the essay, assume our fuller knowledge of the results of experiment, and the whole might have been written yesterday, instead of nearly fifty years ago.

The author began by an argument which practically amounts to the statement that science is limited to the search for a mechanical explanation of nature, and that, whatever the final result of the quest may be, it must be pushed as far as possible.

Assuming that the basis of a mechanical theory must ultimately be the action of forces between material points, and, implicitly assuming the Newtonian laws of motion, the conclusion is reached that the law of the conservation of energy holds good, and holds good only if the forces are central; that is, if they are attractions or repulsions, the magnitudes of which depend solely on the distances between the mutually reacting particles.

The cogency of this as an *à priori* proof of the conservation of energy

of course depends upon whether the premises are admitted to be axiomatic; but it was followed by an appeal to experiment. The greater part of the memoir was occupied with an elaborate discussion as to whether the law of the conservation of energy was consistent with the facts then known. This involved a survey of the application of the law to mechanics, heat, electricity, magnetism, and electro-magnetics. A number of most interesting calculations and suggestions were made, and the conclusion arrived at was "that the law of the conservation of energy does not contradict any known fact in natural science, but in a great number of cases is, on the contrary, corroborated in a striking manner."

The author was acquainted with the earlier experiments of Joule only, and, while employing the idea of a mechanical equivalent of heat and using symbols to represent it, dismisses the results of observation as having but "little claim to accuracy." It need hardly be said that this opinion was not afterwards extended to the later investigations, which were only just then becoming known.

In a note appended, when the essay was republished in 1881, Von Helmholtz expressly disclaimed any right to priority as an originator of the doctrine of conservation of energy, but his essay is the more remarkable on account of his slight acquaintance with the work of his predecessors. He knew nothing of Mayer, and his information as to Joule's experiments was only gained after his own work was far advanced.

Enough has, perhaps, been said to show that he must, as Professor Tait asserts, "be classed as one of the most successful of the early promoters of the science of energy on legitimate principles."

The paper on the Conservation of Energy was only the third or fourth which Helmholtz had published, but his remarkable abilities were now fully recognized.

His connection with the army was severed in 1848. For some months he was an assistant in the Anatomical Museum of Berlin, and also teacher of anatomy at the Academy of Arts. After this he held in succession the professorships of physiology in the universities of Königsberg, Bonn, and Heidelberg, and in 1871 he was appointed professor of natural philosophy in the University of Berlin.

Honors of all sorts were showered upon him. Late in life he was ennobled by the German Emperor, and the esteem in which he was held in this country was proved by the award of the Copley medal, the highest distinction in the gift of the Royal Society.

It would be impossible to follow in chronological order the work which Von Helmholtz gave to the world during these long years. The most that can be attempted is to convey some idea of its importance. He was great as a mathematician and physicist, but the direction of his most characteristic efforts was probably determined by the early necessity for seeking a livelihood by the practice of medicine. On the

borderland of physics, physiology, and psychology he won a place that is all his own. This thorny region has been invaded by others from both sides, but it is not too much to say that Von Helmholtz, in his triple mastery over anatomy, mathematics, and physics, had unique qualifications for the task.

To the oculist he gave the ophthalmoscope, and thus made it possible to investigate the conditions of the inmost recesses of the living eye. If the eye be illuminated a portion of the light returns from the hinder surface, is brought to a focus by the lenses of the eye itself, and forms an image of the retina in external space. To see this was no easy matter. If the patient's eye were focused on a luminous object the image would coincide with the source of light, and, even if otherwise visible, would be lost in the glare. If he looked elsewhere the image would move, but, inasmuch as the lenses can not be adjusted to the clear vision of any object nearer than about 10 inches, that is the minimum distance from the eye at which it can form the image of its own retina. To see this clearly an observer without appliances must place himself at least 10 inches from the image, that is, at 20 inches from the patient. At that distance the view would be so limited that no result could be obtained.

Von Helmholtz, however, convinced himself that, if these difficulties could be overcome, the image of a brightly illuminated retina could be seen. He made the observations through a small hole in the center of a mirror, which reflected light into the eye under examination. Then, by means of a lens, he shifted the position of the image backward until the relative positions of the observer and the patient were such that, according to calculation, the retina should be visible.

Again and again he tried and failed, but he was convinced of the validity of the theory, and at last the experiment succeeded. From that time the oculist has been able to look into the darkness of the pupil, and to see through the gloom the point of entry of the optic nerve and the delicate network of blood vessels by which it is surrounded.

The great monograph on the Sensations of Tone appeared in 1863. The theories advanced were novel, but, though some points are still open to dispute, they have as a whole been generally accepted. The aim of the work was ambitious, being nothing less than the discovery of the physical basis of the sensations which affect us when listening to consonant and dissonant musical intervals, respectively. The general nature of the solution arrived at is now well known. If two notes, which differ but little from unison, are produced together, throbbing alternations in the intensity of the sound are heard as beats. If the interval is gradually increased the beats become quicker, till at last they can no longer be distinguished separately. According to Von Helmholtz, however, they produce the effect of dissonance. "The nerves of hearing," he says, "feel these rapid beats as rough and

unpleasant, because every intermittent excitement of any nervous apparatus affects it more powerfully than one that lasts unaltered. Consonance is a continuous, dissonance an intermittent sensation of tone." The disagreeable effect depends in part upon the number of beats, in part upon the interval between the notes which produce them, being greatest when the rapidity of the beats is neither very large nor very small, and when the interval between the two notes is not great. In applying this theory it is necessary to take into account not only the beats between the two fundamental notes, but also those due to two series of secondary sounds by which they may be accompanied. The presence or absence of one of these—the so-called upper harmonic partials—depends upon the way in which the note has been obtained. They produce the differences of quality which distinguish one musical instrument from another. They are also the basis of our appreciation of the closeness of the relationship between the notes they accompany. The want of perfect consonance between compound notes is attributed to beats between those members of the two groups of sound which are not very far apart on the scale. The growing importance of these beats, as the intervals become less and less consonant, was traced with wonderful ingenuity.

This theory alone would be insufficient to account for a perception of want of consonance between two pure notes unaccompanied by partials. To explain this recourse was had to a second series of attendant sounds, the most important of which had been discovered in 1745 by Sorge, a German organist, and was well known as Tartini's tone. Von Helmholtz proved that such notes would arise when the vibrating body was set in somewhat violent motion, provided that the resistances offered to equal displacements in opposite directions were unequal. Of course the air, which transmits the sounds to the ear, does not possess this property. On the other hand, the drum skin of the ear, to which the aerial vibrations are communicated, is not symmetrical, being bent inward by the little "hammer" bone. Von Helmholtz, therefore, concluded that it is probable that Tartini's tone is due to this membrane. From his point of view it is subjective, in the sense that it is produced within the organism, though it originates in the auditory apparatus, and not in the brain. It is, if one may use the phrase, the rattling of the machinery of the ear.

Having thus accounted for the production of secondary sounds by tones, which were themselves unaccompanied by partials, Von Helmholtz explained our sense of the dissonance of imperfect intervals, when produced by such pure notes, by beats due to the combinational tones.

But, though he maintained that these theories explained the physical "reason of the melodic relationship of two tones," the author of the "Tonempfindungen" was careful to point out that the principles he enunciated had not always determined the construction of the scale, and do not determine it everywhere now. The selection of a series of

notes which were à posteriori found to obey certain natural laws was voluntary. The scale itself is not natural, in the sense that it is not a necessary consequence of the construction of the ear. On the contrary, it is the product of artistic invention. Music is thus not a mere branch of mechanics, but an art. The architect and the composer alike deal with materials which are subject to mechanical laws, but they are alike free to fashion from these forms determined not by calculation, but by the sense of beauty.

Von Helmholtz was at work on optics while still engaged in the study of sound. The *Handbuch der Physiologischen Optik* appeared in sections in 1856, 1860, and 1866. It is, as he himself has said, a complete survey of the whole field of that science. In the first place he treated the eye as an optical instrument, traced the path of the rays through it, and discussed the mechanism by which it can be accommodated to distinct vision at different distances. To investigate the last point it was necessary to measure the images formed by reflection from the surfaces of the crystalline lens. For this purpose he invented a special instrument—the ophthalmometer—by which such measurements can be made on the living patient with great accuracy.

In an interesting course of popular lectures, published in 1868, and since translated by Dr. Atkinson, Von Helmholtz insisted that far from being, as was often supposed, a perfect organ, the eye has many optical defects; and that our unconsciousness of these is due not so much to its perfection from the instrument-maker's point of view, as to the ease with which it adapts itself to different circumstances, and to the skill with which long practice enables us to interpret the messages it conveys to the brain.

The second section of the work was devoted to the sensation of sight. The theories of color and of intensity, the duration of the sensation of light, the phenomena of contrast and subjective appearances were all discussed with a fullness never before attained. The last part was devoted to such problems as our visual appreciation of three dimensions in space and binocular vision.

The theory of color, originally due to Young, was adopted and enlarged by Helmholtz. It assumes that all the sensations of color are compounded out of three fundamental sensations, which are respectively a red, green, and violet or blue. Nearly if not all the phenomena of color-blindness can be explained on the hypothesis that, in the case of persons so affected, the power of appreciating one or other of these sensations is wanting.

It was hardly to be expected that differences of opinion would not arise as to some of the points discussed in two works so wide in their scope and so novel in their methods as the treatises on the sensations of tone and on physiological optics. Koenig, the celebrated instrument maker, has demonstrated the existence of beats which in the case of compound sounds could be explained as due to the upper partials, but

as they are produced when the notes are as pure as it is possible to make them, they do not appear to be accounted for by the original theory. A writer (Voigt, *Wiedemann's Annalen*, 1890, 40, p. 660) who has recently examined the matter, concludes that both the combination tones of Von Helmholtz and the beat tones of Koenig can theoretically be produced without the unsymmetrical arrangement which the former regarded as essential, and that the one system or the other will tend to predominate according to circumstances. The more nearly the energies of the two vibrations approach equality the greater is the probability that the combination tones will be heard. The less nearly the condition of equal energy is fulfilled, the more important will the beat notes become.

Several other points of considerable interest have been raised, but those who on one ground or another have objected to the views of Von Helmholtz, have not been entirely in accord among themselves. It is probable that the theory will finally be accepted in its broad outlines, but will require modifications of some importance in its details.

The theory of color, too, with which the name of Von Helmholtz is associated, is not without its difficulties. A new edition of his *Optics* is appearing in parts, and in this alterations have been made which prove that the author regarded the original hypothesis as capable of modification and improvement. A strong committee of the Royal Society, which has recently reported on color vision, adopted the terminology of the Young-Helmholtz theory, but pointed out that it fails to explain some curious cases of diseased vision, in which the sensation of color is confined to the blue end of the spectrum, while all the other tints appear as white. On the other hand, the rival theory of Hering also fails to account for some of the known facts. Thus the problem is not finally solved, but the importance of the contribution to its solution made in the *Physiologischen Optik* is not disputed even by those who feel that there is need for further inquiry in the future.

In these investigations on the eye and the ear, on light and sound, we see Von Helmholtz at his most characteristic work; but the shortest sketch of his scientific achievements would be incomplete without reference to his eminence as a mathematician.

He was, as might have been expected, deeply interested in the electro-magnetic theory of light, and developed it in a form which is even more general than that adopted by Clerk Maxwell; but it seems probable that, while Von Helmholtz has indicated possibilities, Maxwell has taken account of all that is necessary to explain the facts.

Another inquiry of the first importance, and conducted with the greatest ability, was that on the laws of vortex motion. The movements of a liquid may be so complicated that it is at first sight an almost hopeless task to analyze the motion into its simplest elements. Changes of shape of the most exaggerated character may occur. A compact mass may be drawn out into long threads. Particles at one time far apart may be brought close together and again separated.

If, however, instead of contemplating the final results we consider what is actually going on at a given instant at a given place it is possible to describe the facts in simple terms. A minute sphere of the liquid may be moving as a whole in some definite direction, may be changing its shape, and may be rotating about an axis. This last is the distinguishing characteristic of vortex motion. Von Helmholtz was the first to detect some of the most remarkable properties of those portions of a fluid in which it occurs. The investigation was confined to a frictionless, incompressible liquid, and the author proved that in such an ideal substance the property of vortex motion could neither be produced nor destroyed by any natural forces. If it existed in a group of particles, they would be incapable of transmitting it to others. They could not be deprived of it themselves. The laws of their motion would establish between them a curious and indissoluble fellowship.

A number of beads, strung on a ring of thread or wire and rotating about it, afford, with regard to a similarly shaped system of particles possessing vortex motion, an analogy so imperfect that it is almost dangerous to use it. But the two have, at all events, one property in common. The wire may be moved from place to place or bent into various forms, but wherever it goes, however it is distorted, it carries the beads with it. The connection thus artificially secured would be automatically maintained in a ring of fluid particles endowed with vortex motion. The ring might enlarge or contract, be deflected or distorted, but amid all such vicissitudes the rotating particles would move among their fellows apparently free, but in reality inseparably united.

This and other peculiarities, upon which it is unnecessary to dwell, give to vortex motion a special interest and importance. Lord Kelvin has made the profound and remarkable suggestion that the atoms of matter may be vortex rings in a frictionless liquid. Whatever the ultimate fate of this theory may be, it is justified as affording a glimpse into new possibilities. It is, at all events, not absurd to dream that we may some day regard matter as a special form of some more fundamental substance, from the comparatively simple properties of which the laws of chemistry and physics may be deduced. Apart, however, from the use which has been made of vortices in this and in other ways, as affording a basis for the explanation of physical facts, Von Helmholtz must rank as the discoverer of a series of fundamental propositions in hydrodynamics which had entirely escaped the notice of his predecessors.

During the last years of his life Von Helmholtz was president of the "Physikalisch Technische Reichsanstalt" at Charlottenberg. In 1884 the late Werner Siemens offered £25,000 toward the foundation of a State research laboratory. The Reichstag voted the necessary additions to this sum. The institution has been established on a large scale, and the first volume of records was published in March of the present

year. The preface was signed by Von Helmholtz, and thus the career of the great investigator was fittingly closed by the inauguration of a national college devoted to learning and research.

In a brief and imperfect sketch such as this it is barely possible to give an idea of the extent of the work of Von Helmholtz; it is certainly impossible to do justice to its fulness and depth. I have mapped the directions of the main streams of his thought. Only those who follow them in detail can count the fields they have fertilized. In the course of his investigations all sorts of side issues were studied, a vast number of subsidiary problems solved. The alertness of his intellect, the readiness with which he turned from one science to another, the extraordinary ease with which he handled weapons the most diverse and the most difficult to master, these are not less wonderful than the catalogue of his main achievements.

The technical merits of his work will, of course, be appreciated chiefly by experts. Special knowledge is not necessary to understand its importance. He was one of the first to grasp the principle of the conservation of energy. He struck, independently and at a critical moment, a powerful blow in its defense. He penetrated further than any before him into the mystery of the mechanism which connects us with external nature through the eye and the ear. He discovered the fundamental properties of vortex motion in a perfect liquid, which have since not only been applied in the explanation of all sorts of physical phenomena, of ripple marks in the sand and of cirrus clouds in the air, but have been the bases of some of the most advanced and pregnant speculations as to the constitution of matter and of the luminiferous ether itself.

These scientific achievements are not, perhaps, of the type which most easily commands general attention. They have not been utilized in theological warfare; they have not revolutionized the daily business of the world. It will, however, be universally admitted that such tests do not supply a real measure of the greatness of a student of nature. That must finally be appraised by his power of detecting beneath the complication of things as they seem something of the order which rules things as they are. Judged by this standard, few names will take a higher place than that of Hermann von Helmholtz.

SKETCH OF HEINRICH HERTZ.¹

By HELENE BONFORT.

Wherever the investigating minds of scientists are at work promoting the insight of man into the mysteries of nature, wherever friends of natural philosophy are keenly alive to the importance of this comparatively new field of study, a field in which lie some of the most essential interests of modern civilization, there will be sincere and deep regret over the death of a young professor whose splendid career came to an untimely end on the first day of this year. Prof. Heinrich Hertz, of the University of Bonn, in Germany, died on January 1, 1894, not yet 37 years of age. For the last two years he had not been in good health, and, though under the treatment of his capable physicians he several times rallied and seemed to be restored to his former strength, the last winter brought a serious relapse. A chronic and painful disease of the nose spread to the neighboring Highmore's cavity, and gradually led to blood poisoning. He was conscious and in possession of his full mental power to the last; he must have been aware that recovery was hopeless, but not a word escaped his lips that would have shown to his dear ones whether hope or fear filled his heart. His wife and his mother were at his bedside for many weeks, giving him their tenderest care, and in spite of his continuous sufferings there were many hours of genial discourse. At such times they read to him, and he gave himself up to general topics and to matters of personal interest to them, displaying even yet his wonted brightness and cheerfulness.

Heinrich Hertz, born in Hamburg on February 22, 1857, was the eldest son of exceptionally good and clever parents. His father was at the beginning of his career a lawyer; in due course of time he rose to the position of judge of the supreme court of appeal, and has now for a number of years been a senator of the free city of Hamburg. The childhood of Professor Hertz was subject to every pure, healthful, and elevating influence that a highly capable father and a superior mother can exercise. Both of them gave a great part of their time to their children; their eldest boy especially enjoyed the advantage of their companionship in many a holiday's ramble through the green fields and woods, and

¹ From the Popular Science Monthly, July, 1894, Vol. XLV, No. 3.

in cozy winter nights spent in reading Homer, the German classics, and other books.

In passing through the high-school classes of his native city his predilection for the study of natural science early asserted itself. Whenever a new course of study began and a new text-book was put into the hands of the class, the boy would devote every leisure moment to the perusal of the volume, experimenting frequently with apparatus made by himself, and never ceasing until he could tell his father, "I have mastered that book." This statement always proved to be perfectly correct. In spite of his decided gift for natural science, Hertz chose as his vocation civil engineering. But when, after completing his studies, he came to take the first steps toward the practical execution of this design, he felt that his choice had been a mistake. His parents, with a ready perception of the deeply rooted needs of his strong and peculiar nature, whose desires they would not think of thwarting, entered into his new idea, gave him their approval, and furnished him with the necessary means. So he set out on a new course of studies in mathematics and natural science. He gave himself up to this work heart and soul, and for a number of years knew no other object in life but unceasing and unrelenting hard work. He studied physics at Munich and Berlin, and enjoyed the warm regard of Professor Helmholtz. In 1880 he became his assistant, and at his instigation, in 1883 settled down as a "privatdocent," or professor without salary, at the University of Kiel. It was from this time on that he made the science of electricity the one great object of his researches, the main pursuit of his life. The first years were filled with investigations relating to electric discharges, etc. He busied himself, above all, with the new conceptions of the inner mechanism of electric phenomena and of the connection between these and the phenomena of light and of radiant heat. These conceptions, originating with Faraday and Maxwell in England and represented in Germany by Helmholtz, were now carried forward by Professor Hertz.

His reputation soon spread through his native country, and he was in 1885 called to the Polytechnic School of Karlsruhe, which for various reasons became very dear to him. One of its attractions was the exceptionally fine and well endowed laboratory of the institution, which furnished the most desirable facilities for unlimited experimenting. At Karlsruhe Professor Hertz found a wife who was in every way a lovely and graceful, devoted, and highly intellectual companion to him. His life was from this time on divided between the pursuit of his main object, the progress of science, and home happiness; both he and his wife derived rare gratification from literature and the beauty of nature. It was from Karlsruhe that he went to Heidelberg, there to enjoy the proudest moment of his life, in the year 1889, when, greeted with enthusiastic applause by most prominent scientists, he stood upon the platform to tender an account of his researches and their results. Who

that saw him there, the very picture of youthful vigor and life, could have foreboded that those fine and penetrating eyes, to which for the first time since our earth turned around its poles electric waves had been revealed, were so soon to be closed in death!

Soon Professor Hertz received flattering calls to the most prominent universities. He preferred the smaller town of Bonn, where he settled down in 1890, even to Berlin, the capital, because what he sought after was the most serious and fruitful work, not glory and outward advantage. In Bonn he succeeded to the eminent physicist, Professor Clausius. This was in itself a high distinction conferred upon so young a man as Professor Hertz. Considered all over Europe as one of the most prominent, he was looked up to as one of the most promising leaders in the science of electricity. Not only had his own country conferred high honors upon this young and ardent worker, but the chief academies of England, France, Italy, Austria, and Russia now crowned his efforts with prizes, honorary memberships, and other tokens of universal esteem and gratitude.

Up to the middle of this century the phenomena of electricity and magnetism had been only inadequately explained by applying to them Newton's law of gravitation, and asserting that in the same way as celestial bodies exercise power of attraction at a distance and without the intervention of a medium the two kinds of material electricity were attracting and repelling each other while passing through space or through nonconductors.

It was the great English physicist Faraday who first sought to carry the knowledge of electricity to a higher stage by entering upon the study of phenomena with a mind free from preconceived opinions. He put forth as the foundation on which to base new theories his observations of electric and magnetic forces, their influence upon each other, their attractions for material bodies, and their propagation by the transmission of the excitation from one point of space to another. He questioned the assumption of space being void, and conjectured that the ether which transmits the luminous waves suffers modifications perceived under the form of electrical and magnetic manifestations. His discoveries, important as they were, gained due consideration only when Faraday's great countryman, Maxwell, treated the same subject in a purely scientific and theoretical way, publishing in 1865 his *Mathematical Theory of Light*. The nature and properties of ether he left undecided, and they form to this day dominant questions, destined, it seems, ultimately to reveal the deepest secrets of natural science. Maxwell labored to confirm the connection, surmised by Faraday, between light, electricity, and magnetism; the idea of velocity now entered the theory and became of supreme importance. Maxwell arrived at the conclusion that the velocity of electromotion in a given medium must be identical with the velocity of light in the same medium, and that therefore ether, being contained in all ponderable

bodies, would have to be looked upon as the conductor of electric motion and power. Consequently the periodical motions of ether, which our eye conceives as light, and which he figured as transversal waves, were considered by Maxwell to be at the same time undulations of electricity. These conceptions, unproved by experiment as Maxwell left them, had merely the value of a scientific hypothesis emanating from a man of rare genius. To have proved them facts, and thereby to have united two vast and highly important domains of natural philosophy, is the lasting credit of Professor Hertz.

The complexity of phenomena of light and electricity and the insufficient opportunities afforded by the laboratory for deductions of such magnitude rendered the obstacles barring the road to exact observation well-nigh insurmountable. Many of the best and ablest naturalists were laboring to cope with these difficulties. Two English scientists of highest standing, Prof. G. F. Fitzgerald and Dr. O. T. Lodge, were during the eighties occupied with experiments for the investigation and measurement of electric waves. But it was reserved for Hertz to discover and apply with marvelous ingenuity the necessary "detector," a resonating circuit with an air gap, the resistance of which is broken down by well-timed impulses, so that visible sparks are produced. After an unceasing course of experiments, in which he manifested indefatigable energy and a wonderful faculty of reaching the very essence of the matter, he succeeded in deciding the questions: Is the propagation of electrical and magnetic forces instantaneous? and further, Can electrical or magnetic effects be obtained directly from light? The paper "On very rapid electric oscillations," which was published in 1887, was the first of a splendid series of researches which appeared in Wiedemann's *Annalen* between the years 1887 and 1890, and in which Hertz showed with ample experimental proof and illustration that electromagnetic actions are propagated with finite velocity through space. These twelve epoch-making papers were afterwards republished—with an introductory chapter of singular interest and value, and a reprint of some observations on electric discharges made by Von Bezold in 1870—under the title *Untersuchungen über die Ausbreitung der elektrischen Kraft*. A translation of this book, entitled *Electric Waves*, by D. E. Jones, B. Sc., with illustrations and a preface by Lord Kelvin, has just been published in England.

In 1889, when laying before the Congress of German Naturalists at Heidelberg the results of his labors, Professor Hertz, with the modesty characteristic of the true investigator, the utterly unassuming disciple of science, gave ready and graceful acknowledgment to the efforts made by his predecessors or cooperators in the work, some of whom had all but attained the results which they aimed at and which he achieved. It is pleasant to recollect that when he had gained the end toward which they also had been striving, the English professors, Oliver Lodge and Fitzgerald, were foremost in announcing his success, and in prepar-

ing the English-speaking world to appreciate the importance of his discoveries. A natural bent of mind toward the questions at issue had awakened the young professor's creative powers; his complete concentration upon the vital point and his intuitive perceptions led him to definite results and complete success where so many able minds had searched in vain. In the April number of this magazine Herbert Spencer, speaking of the late Professor Tyndall, gives a number of traits that apply with singular force and exactness to Professor Hertz. Of these the first is "the scientific use of the imagination." It may well be said that with this constructive imagination, as Mr. Spencer terms it, originated Professor Hertz's rare success as a discoverer and as an instructor.

To find out the most effective arrangement of electrical conductors and to secure the conditions which would produce the strongest vibrations at regular intervals and in quickest succession, we might say the adjustment of his instruments was the first part of his work. Having brought about electric undulations up to several hundred millions in one second, Hertz proved through experiment that the waves of electricity are transversal like those of light, and that the transmission requires a certain lapse of time. He ascertained exactly the velocity of electricity; it is found by multiplying the length of wave, which he measured, by the duration of the vibration, which can be calculated, and he found this velocity to be, as Maxwell had supposed, equal to that of light, and, moreover, equal to the velocity of electric waves in metallic wires. The grand consequence of this last discovery was the cognizance of a new fact, that what had hitherto been considered as a current of electricity in a wire is really a movement along the surface of the wire. Maxwell's magnetic theory of light found further corroboration by the experimental demonstration of electric power as propagating from its center in waves similar to sound. The electric undulations are subject to the same process of reflection, refraction, absorption, etc., as the rays and waves of light, from which they are in the end distinguished only by their considerably greater length, measured sometimes by kilometers. The crowning experiments of this course finally changed what had hitherto been looked upon as a coincidence between two orders of distinct phenomena into a demonstration of identity. By gathering the electric spark in the focus of a large concave mirror, whence it came forth in the form of a rectilinear beam, the properties of the electric ray were shown to be identical with those of a luminous ray, the former producing phenomena which have heretofore been observed only in light—those of polarization. This result renders all theorizing on the matter superfluous; the identity of the two powers springs from the experiment itself; ocular proof is produced for the proposition that light is in its very essence an electrical phenomenon, whether it be the light of the sun, of a candle, or of a glow-worm. Suppress electricity in the universe, light would disappear.

Suppress the luminiferous ether, electric and magnetic forces would cease to act through space. Even a body not casting light can be a center of electrical action if it radiates heat. Electricity therefore possesses all nature and even man. The eye itself is, in fact, an electrical organ.

The influence of this new system of physics upon the development of natural science and the manifold applications in practical life of which it is capable can not easily be overrated. Only recently a new application of Hertz's discovery was made by an American, who is trying to develop photographs by the agency of the Hertzian waves, as science has named them—that is, by electricity instead of light. Hertzian waves, Hertzian investigations, apparatus, and methods form henceforth an essential part of all hand and text books of electricity. The facts established by Hertz's experiments have been molded into a mathematical formula by their author, who in this purely theoretical work also has shown himself to be a master of high genius in the realm of abstract science. There is at present in press and will soon be issued by T. A. Barth, at Leipsic, a comprehensive work, entitled Principles of Mechanics in a New Connection, found among his unpublished papers at the death of Professor Hertz. Its appearance is eagerly watched for by the scientific world.

However highly his own time and posterity may prize the man of science, the great discoverer, in Professor Hertz, his value as such to the world at large does not surpass that of the rare purity and greatness of his character, of the intrinsic merit which he possessed for those who knew him personally. A world-wide reputation so rapidly attained might have produced in the young man some feeling of elation and pride and in his colleagues somewhat of envy. But, as Prof. Hubert Ludwig, representing the University of Bonn, at Professor Hertz's funeral in Hamburg, said in his memorial speech:

“The rich harvest of fame and glory which was granted him, and that was so fully merited as not to be tainted by a single breath of envy or jealousy, never caused him to give up one atom of the noble simplicity and genuine modesty which were a fundamental trait of his character. His modesty was a most lovable quality in this great man, asserting itself not only in everyday life, but also in his scientific labors, which it pervades with the endearing charm of an amiable personality. It was coupled with the most considerate indulgence when judging others. His ever-ready recognition of other people's merits made it a sheer impossibility to grudge him his attainments or to be his enemy.

‘None knew him but to love him,
‘None named him but to praise.’

At the same time he was governed by an inflexible veracity.”

He was indeed a most lovable man, and was never happier than in giving pleasure to others. His kindness and benevolence found expression in many ways, most of all toward those above whom he was placed as head of his department in the university. It was a pleasure to notice

his satisfaction, when he found it in accordance with his duty, to confer a benefit or favor. And when it was incumbent upon him to refuse or displease, he became the director who performed his duty and the friend who regretted what had to be done. He was always ready to show hospitality to scientific men who came to Bonn from other parts of Germany or from foreign countries. Even under the restraint of a foreign tongue (he spoke English and French with considerable fluency) his conversation was charming. Not what he had achieved gave him his ascendancy in scientific discourse, but what he, beyond a thousand learned men, could achieve at any time—original and sagacious thoughts, springing up on the spur of the moment, and losing none of their force by being expressed in the most unpretending, simple form. When entertaining friends or conversing with his dear ones he perfectly forgot the learned professor in himself; he was so much at his ease, so full of fun, that none around him could help sharing his gayety. Many of his guests, prominent men of science as well as students, will always remember with pleasure and gratitude delightful trips made with Professor Hertz to the Siebengebirge or evenings of genial intercourse at his house in the Quantiusstrasse at Bonn. Absolutely devoid of any desire to pose before the public, the professor sometimes astonished students newly entered for his lectures by putting in a bit of humor where they had expected abstract instruction; but they soon found themselves none the worse for it. Some simple word, a casual remark made as if it were a self-understood thing, from his lips did more toward improving the mind of his audience than a long lecture from another. He was not a scientist inculcating one special branch of knowledge; he was a thinker. To be considered an authority, even by the youngest beginner, was an idea that never entered his mind. In the congenial atmosphere of advanced classes new ideas and conceptions seemed to rise in him and flow from his lips as though there could be no easier thing in the world. He was at his very best when propounding a problem to this small circle, showing how he would attack it. None, however capable, but could profit by his teaching; genius itself seemed to prompt it.

With penetrating perspicacity he took hold of his problems. As a veritable disciple of natural science he strove to accomplish his ideal ends, although by means of theory, which he completely mastered, yet not merely by theory and not for her sake only; what he aimed at first and last was the most accurate establishment of facts. Pervaded as his strong personality was by an absorbing love of his science, the rare harmony of his nature kept him equally from an exaggerated enthusiasm and from prosaic dullness. An uncommonly great number of valuable researches made at the Physical Institute at Bonn during the short time of his leadership prove his rare capacity and untiring eagerness to incite young talents to the best possible application of their faculties and so pave the way for their success in research. But in a wider

sense of the word we may call his disciples all those physicists who are at this moment and will be for a long time occupied in exploring the provinces which he was the first to open. In this sense almost one-quarter of all living physicists call themselves Professor Hertz's followers.

The honors paid at his funeral to the memory of this young and ardent worker were exceptionally great. He was buried in his native city, Hamburg, where the most widespread sympathy for his family and the deepest regret over his loss were shown. From Bonn, Karlsruhe, and Berlin came friends, colleagues, and students, some of them officially representing their colleges. Universities and prominent men from all parts of our globe have sent messages of esteem and sympathy to the wife, the parents, and the University of Bonn. It may be questioned whether such utterances of sympathy and respect, much as they tend to make mankind feel itself as one, can offer consolation to those whose bereavement is greater than words are able to convey. However, what Mr. Lowell said in one of his simple and admirable memorial addresses is certainly true:

"It may seem paradox, but the only alleviation of such grief is a sense of the greatness and costliness of the sacrifice that gave birth to it, and this sense is brought home to us by the measure in which others appreciate our loss."

Prof. Hubert Ludwig, of Bonn, uttered the last farewell at the grave of his friend and colleague. He expressed the sentiment of those grieving at his bier in these final words:

"This loss is so great that we are tempted to recall the old saying of the envy of the gods. But in this solemn hour let us resolutely banish such temptation, and instead of rebelling against destiny, let us at the open grave of this God-inspired investigator bow low our heads and hearts before the inscrutable."

INDEX.

A.

	Page.
Abbott, Dr. William L., explorations by	8, 43, 86
Aberdare, Lord, of Royal Geographical Society	32
Aberration, constant of	105
Aboriginal art, survival of	598
Aborigines, American, origin of	529
Absolute measure of hardness	83
Academies of sciences, origin of	665
Academy of Fine Arts, of France	706
Sciences, French	697
Acosta, cited	254
Acts of Congress relating to the Institution	XXXV
Adams, Dr. W., lecture by	20
Adler, Cyrus, report on library by	82
Aerial navigation, Lieutenant-Colonel Elsdale on	667
progress in	670
Ærodynamics, investigations in	398
Langley's experiments in	669
Africa, explorations in, by Abbott	86
by Chanler and others	338
geographical features of	322
origin of tribes of	600
Agassiz, Alexander, on Gulf Stream	83
Agassiz, Louis, founder of Museum of Zoology	162
Agathodæmon canal on Mars	114
Agricultural chemistry, plant food	213
Department, foreign exchanges of	62
Air, atmospheric, at summit of Mont Blanc	243
refractive index of	105
resistance of	396, 669
Albuminoids in fish	223
Alexander, W. Cleverly, mentioned	622, 651
Algeria, exchange agency	64
Allen, Dr. Harrison, lecture by	20
on North American bats	42
Allen Korean collection	86
Alloys in Japanese bronzes	640
Aluminium, used in flying machines	669
America, early cartography of	281
food and migrations in	526
American Association for Advancement of Science	93
Historical Association	18, 21
Institute of Electrical Engineers	141
Mining Engineers, collection from	25
Amitabha, bronze image of	622

	Page.
Amos, Prof. Sheldon, quoted	515
Ampère, Andre Marie, biography of	144
discoveries of	129, 167
Ampere, electrical unit of current	143
Anatomy of bird's skull	312
Anchor Steamship Line, courtesies from	65
Anderson, C. W., surveys in British Guiana	339
Anderson, Prof. W., mentioned	651
Anderson, W. W., quoted	256
Angell, James B., Regent of Smithsonian Institution	X, XI
Angle measurements, methods of	109
Angles and Saxons, art of the	605
Animal locomotion, analysis of	404
magnetism, study of	694
Antarctic region, promotion of discovery in	317
research, committee on	336
Antarctica, a vanished austral land	297, 308
Anthrax poison, destruction of	455, 477
Anthropology in France	164
progress in	84
Antipodea, antarctic land	302
Antiquities, classical, value of	590
Antitoxins, use of	477
Ants' nests, Dr. August Forel on	479
Ants, agricultural	502
blind species of	501
habits of	479
method of spinning	492
relation to plants	493
road building by	501
seed-harvesting	485
Appropriations, summary of	XXXII
Arabs, Byzantine art among the	605
Arago, mentioned	700
Archæological investigations	30, 46
research, methods of	589
Archæology, American and Asiatic	537
of Canary Islands	541
Architecture, Greek horizontal curves in	573
Greek, principles of	573
Archives, classification and indexing of	20
Arctic currents, course of	344
Ocean, temperature of	353
region, promotion of discovery in	317
research, addresses on	322
Argentine Republic, exchange agency	64
transmissions to	66, 67
Aristarchus, on distance to sun and moon	95
Aristotle and Hegel, logic of	689
Armory building, repair of	XXXVIII
vacated by Museum	5
Armour Institute, founding of	163
Army Medical Museum	26, 62

	Page
Arnould, M., prestidigitator	571
Art, Byzantine and Teutonic	605
Greek, collections of	590
Mohammedan	606
Neo-celtic	604
relation of natural science to	84
Arts and sciences, study of	698
similarities of American and Asiatic	537
Aryan culture, origin of	601
Asellius, discoveries by	392
Ashburton, Lord, of Royal Geographical Society	321
Ashmead, William H., on Proctotrypidæ	42
Asiatic languages	536
Association Française pour l'Avancement des Sciences	153
Asteroids, used in determination of solar parallax	97
Astrolabes, Moorish	606
Astronomers, rise of great	662
Astronomical equation, definition of	105
method of determining earth's flattening	102
observatory at Arequipa	162
Berlin, founded	692
physics	191
Astronomy, American interest in	163
ancient knowledge of	94
and Astro-physics, extract from	93
Harkness on magnitude of solar system	93
intensity of moonlight	193
Leverrier's discoveries in	157
photographic telescope	175
progress of, Winlock on	85
radiating power of stars	195
relation of geology to	93
physics and chemistry to	698
Schiaparelli's views of the planet Mars	113
Astrophysical Observatory, appropriation for	XXXVIII, 4
receipts and expenditures of	XXIX
researches in	7, 75
Secretary's report on	39
Atkinson, Dr., cited	715
Atlanta Exposition, law relating to	XXXIX
Atlas Steamship Company, courtesies from	65
Atmosphere, general circulation of	83
of planet Mars	118
Atmospheric pressure, effect on ocean level	357
Attraction of sun and earth on moon	100
Atwater, J. B., on treatment of tornadoes	259, 269
Atwater, W. O., on nutritive value of fish	222
Auerbach, F., on absolute measure of hardness	83
Augière, A., quoted	582
Australia, former climate of	313
Australian fauna and flora	299
Austria-Hungary, exchange agency	64
Austria Sound, location of	325

	Page
Austrian Arctic expedition	325
Anzout, invented astronomical instrument.....	96
Avery, Robert Stanton, acceptance of bequest of	XII
Ayrton, Professor	141, 152

B.

Babylonia, chronological data of	596
Bacillus, colon, destruction of	451
Bacteria, sunlight destructive to	451
Bahama Islands, characteristics of sea bottom at	363
Bailey, H. B., & Co., courtesies from	65
Baird, Secretary S. F., statue of	21
Baker, Dr. Frank	41
report on Zoological Park	74
Balboa's South Sea, on early chart	286
Ball, Sir Robert, cited	311
Balland, John, donation to Zoological Park	71
Balloons, development of	668
Baltazzi, X., courtesies from	65
Baltzly, E. E., donation to Zoological Park	72
Barlow declares telegraph impossible	143
Barnum & Bailey Shows, loan to Zoological Park	73
Barth, T. A., cited	724
Basel University, publications from	79
Basque language, survival of	600
pilot, Juan de la Casa	283
Basques as cartographers	283
Bates, cited	426
Bateson, William, on variation	414
Baudouin, M., method of rainmaking	260
Beall, J. E., donation to Zoological Park	71
Bean, Dr. Tarleton H.	9, 42, 531
Beaumont, Elie de, French geologist	155
Behaim's globe	282
Belgium, exchange agency	64
Bell, Dr. Alexander Graham, gift of	3
Bell, Charles, discoveries by	392
Bell, G. H., cited	269
Bell, James, donation to Zoological Park	72
Bellet, Daniel, cited	269
Bells, Japanese	611, 620
Bendire, Maj. Charles, on North American birds	42
Bent, Mr. and Mrs., travels by	338
Berber origin of Guanches	542
Berbers, origin of	600
Bergen, F. D., mentioned	255, 256
Bering Sea, food supply in	531
Berlin Academy of Arts and Science, founding of	686
Zoological Garden, area of	36
University, address by rector of	653, 681
publications from	79
Virchow on founding of	681

	Page.
Bernadou Korean collection.....	86
Bernard on heart nerves.....	466
Bernard, Claude, on effect of nerves on temperature.....	392
Berne University, publications from.....	79
Bessel, angle measurements by.....	109
on latitude variation.....	275
Bethencourt at the Canary Islands.....	547
Bible dates, basis of.....	596
Bibliography of aceto-acetic ester.....	10
cerium and lanthanum.....	10
chemistry, by Bolton.....	10, 83
didymium.....	10
National Museum publications.....	86
native American languages.....	53
Royal Geographical Society.....	319
Bickman, G. H., donation to Zoological Park.....	71
Billings, Dr. J. S.....	18
on American inventions in medicine and surgery.....	86
typhoid and the colon bacillus.....	451
Binet, Alfred, on psychology of prestidigitation.....	555
Binnix, B. F., donation to Zoological Park.....	72
Biology, fundamental processes of.....	386
origin of life.....	386
relation to geology.....	87
Birds, Australian.....	299
flight of.....	85, 394, 395, 398, 407, 408
fossil, in Chatham Islands.....	299
geographical distribution of.....	302
life histories of.....	42
marine, at Bahama Islands.....	364
migration of.....	85
Parker on embryology of skull of.....	312
principles of variation in.....	421, 423
Birds' eggs, Ralph collection of.....	25
Bischoffsheim, M., mentioned.....	238
Bishirins, origin of.....	600
Bissell, Wilson S., member of Smithsonian Institution.....	IX, 1
Björling, Alfred, Arctic exploration by.....	330
Black, C. E. D., on India surveys.....	341
Blake, James, on effect of drugs on circulation.....	463
Blake, Lucien J., cited.....	269
Blanford, Dr., cited.....	311
Blood pressure, causes of increase in.....	469
measure of.....	392, 465
Blondlot, M., electric disturbance measured by.....	137
Blunt, W. B., cited.....	269
Board of Regents. (<i>See</i> Regents.)	
Boas, Dr. Franz.....	55, 334
Boats, aboriginal.....	532
Boehmer, George H., on naval architecture.....	86
Bolivia, exchange agency.....	64
Bollman, Charles Harvey, on Myriapoda.....	42
Bologna University founded.....	513

	Page
Biographic curves, record of	75
Bolton, H. Carrington, bibliography of chemistry by	9, 83
Bonaparte, Prince Roland, mentioned	238
Bonfort, Helene, sketch of Heinrich Hertz by	719
Bonn University, publications from	79
Booth, Sir Felix, munificence of	326
Borelli on muscle movements	407
Börs, C., courtesies from	65
Bosporus, currents of the	347
Botanic Garden, foreign exchanges of	62
Botanical gardens at Berlin	692
Botany, and insects, relation between	493
benefit of study of	663
economic, possibilities of	84
irritability of plants	387
marine	366
of Australia	306
Botta, oriental discoveries by	705
Bouillaud on cardiac murmurs	462
Boulton, Bliss & Dallett, courtesies from	65
Bourke, J. G., on Indian rain making	252
Boussingault on tropical soils	225
Boutmy on architecture	584
Boys, Professor, cited	208, 210
Brackett, Col. William S.	85
Bradford, Governor, history of Plymouth Plantation	223
Bradley, angle measurement by zenith sector	109
Brahe, Tycho, instruments perfected by	272
Brain, anthropology of the	85
Bravais, researches by	247
Brazil, discovery of	285
exchange agency	63, 64
Breckinridge, W. C. P., Regent of Smithsonian Institution	x, xi, 2
Brennan, Mr., inventor of torpedo	673
Breslau University, publications from	79
Brewster, Sir David, on undulatory theory of light	106
Brindley, H. H., cited	426
Brion, H. W., donation to Zoological Park	72
British Guiana, exchange agency	64
surveys in	339
Brodie, Sir Benjamin, quoted	472
Bronze, art of casting, in Japan	609
Bronze Age in Japan	609, 610
survival of	598
culture of Denmark	602
founding, technics of	626
lanterns, Japanese	621
methods of casting	628
mirrors, Japanese	611
workers, origin of	602
working in Ireland, early	603
Bronzes, Japanese, methods of making	640
stains and patinas of	686
varieties of	640

	Page.
Brooks, W. K., on origin of oldest fossils and discovery of ocean bottom	359
Brown, Addison, on endowment for scientific research	85
Brown, J. Campbell, translation by	84
Brown, J. H., donation to Zoological Park	71
Brown, L. L., cited	269
Brown, Vernon H., & Co., courtesies from	65
Brown-Sequard, Dr. C. E., death of	703
discoveries by	466
experiments by	411
lecture by	20
on use of animal extracts	477
researches by	704
Bruce, Minor W., loan to Zoological Park	72
Bruegmann, H., cited	269
Brunet, legacy of	164
Brunton, Dr. T. Lauder, on modern development of Harvey's work	459
nature of inhibition	379
Bryant, Henry G., arctic expedition under	335
Buchan, Dr. Alexander, on ocean temperatures	351, 353
Buddha, bronze images of	616
Buddhism in Japan	612
Buddhist divinity Rochana	618
monks, influence of	604
Buffalo, extinction of	35
Buffon, cited	409, 413
Bugher, Mrs., donation to Zoological Park	71
Building, need of, for National Museum	21
Buildings, Secretary's report on	4
Bumpus, Dr. H. C., at Naples table	17
Burdon-Sanderson, Professor, mentioned	464
Bureau of Education, foreign exchanges of	62
Ethnology, director's report on	44
explorations by	44
finances of	56
origin of	28
receipts and expenditures of	XVIII
Secretary's report on	28
Medicine, foreign exchanges of	62
Ordnance, foreign exchanges of	62
Burial habits, early English	599
Burns, Frank, on Crump burial cave	87
Burton, canals of Mars seen by, in 1879	113
Bush, Richard J., cited	582
Bute, Marquis of, quoted	549, 550
Butler, cited	426
Byzantine art	605

C.

Cabral, Brazil discovered by	285
Calah, discovery of site of	705
Calderon, Climaco, courtesies from	65
Cambridge University founded	513

	Page.
Cameron, R. W., & Co., courtesies from	65
Camp, M. Maxime du, death of	706
Canals of Mars, Schiaparelli's description of	113, 123
Canario, marine chart by	283
Canary Islands, Guanches of	541
Cantero, marine chart by	283
Canyon de Chelly, exploration of	45
Cape Colony, exchange agency	64
Carcel lamp, luminosity of	191
Cardiac center, position of	466
murmurs, discovery of	462
Carlet, G., analysis of animal locomotion	396
Carlisle, John G., member of Smithsonian Institution	IX, 1
Carpenter, Dr. W., on sea currents	347
Carr, Lucien, on mounds of Mississippi Valley	84
Cartier, Jacques, voyages of	288
Cartography of America up to 1570	281
Casa de Contratacion for the Indies	285
Cassini, determined rotation of Mars	114
Cassini, J. D., on variations in latitude	273
solar parallax determined by	96, 97
Catacombs of Rome, exploration of	706
Catlin collection of Indian portraits	25
Cave dwellings on Canary Islands	550
man of Europe, extinction of	599
Cavelier, M., death of	706
Celestial spectroscopy, by William Huggins	83
Celts in France, origin of	601
Central America, collections from	43
Cernuschi, M., bronze collection of	618, 651
Chaldea, bronze figures from	609
early religious system of	601
Chaldeans, astronomical knowledge of	94
Chambaud, Eugene, certificate from	582
Chambers, Dr., executor of Hodgkins estate	XIII
Chambers, Robert, cited	413
Chambrelent, M., death of	702
Chandler, Dr. S. C., on Eulerian period	277
Chang Yen Hoon, vote of thanks to	xiv
Chanler, William Astor, African exploration by	338
Charter of Liberties, object of	512
Charts and globes, early American	294
Charts, marine, origin of	283
Chatham Islands, fossil birds in	299
topography of	308
Chemical Institute of Berlin	693
Chemistry, benefit of study of	664
bibliography of	9, 83
aceto-acetic ester	10
literature of cerium and lanthanum	10
didymium	10
of human tissues, function of	385
physico, principles of	437

	Page.
Chemistry, relation to astronomy	698
relations of physiology to	377
waste and conservation of plant food	213
Chenault, C. O., donation to Zoological Park	71
Chicago Exposition, French views on	158
University, founding of	162
Child, R. C.	39, 78
Chile, deposits of nitrate of soda in	226
exchange agency	64
transmissions to	66, 67
Chimique, Encyclopedie	703
China, chronology of	595
exchange agency	64
transmissions to	66, 67
Chinese methods of time keeping	84
minister, vote of thanks to	XIV
Chree, C., on applications of physics and mathematics to geology	83
Christian archaeology, De Rossi on	706
Chrono-photographs of sleight-of-hand tricks	570
Chrono-photography, investigations by	399
Church and science, relation of	663
Circulation, effects of drugs on	463
Clairant's theorem	102
Clark, Sir Andrew, death of	460, 478
Clark, W. P., on Indian rain making	251
Clarke, Agnes M., on sun's motion in space	83
Clausius, Professor, mentioned	721
Clendinning, Dr., on cardiac murmurs	462
Clerk-Maxwell (<i>see also</i> Maxwell)	106
on light and electricity	129, 130
Cleveland, Grover, member of Smithsonian Institution	IX, 1
Clifton, Professor	174
Climate of the planet Mars	120
Clocks, improvement in accuracy of	109
Cloissoné jewelry, origin of	605
Coal, extraction of latent power of	679
Coast and Geodetic Survey, foreign exchanges of	62
Cock, Alfred, mentioned	617, 618, 626, 651
Coffin, William Pine, mentioned	335
Cohnheim, researches by	467
Coins, ancient	604
Japanese bronze	614
Colába, observatory at	178
Cole, R. S., mentioned	208
Colladon, Daniel, electrical investigations by	167
Colombia, exchange agency	64
Color, theory of, Helmholtz on	715
Color-blindness, phenomena of	715
Color-vision, Young-Helmholtz theory of	716
Columbian Line, courtesies from	65
Columbus, Christopher, chart made by	284
maps used by	282
Columbus, Ferdinand, chart made by	287

	Page.
Comets, photographs of.....	195
Commonwealth, establishment of, in Britain.....	516
Compagnie Générale Transatlantique.....	65
Compass needle, oscillation of.....	185
Congressional acts and resolutions.....	XXXV
Conant, Levi L., on primitive number systems.....	85
Conservation and transformation of energy.....	147, 437
of force, Helmholtz on.....	710
Constant of aberration.....	105
Contributions to Knowledge, expenditures for.....	xvi
Secretary's report on.....	8
Conway, Mr., glacier survey by.....	339
Cook, Prof. O. F., collections from.....	8, 43
Cooke, Dr. F. A., arctic exploration by.....	335
Copernicus, astronomical system of.....	95
Copley medal awarded to Helmholtz.....	712
Coppée, Henry, executive committee report by.....	XXXIII
Regent of Smithsonian Institution.....	X, XI
Copper age in Japan.....	610
Copper mining, pre-Columbian.....	85
Coptos, discoveries at.....	600
Coral at Bahama Islands.....	363
Coral atolls, origin of.....	357
Coral island, luxuriance of animal life on.....	371
Corbin game park.....	84
Cornu, M., cited.....	131
Correspondence, Secretary's report on.....	16
Correspondents, map showing distribution of.....	32
statistics of.....	60, 64
Corrigan, on cardiac murmurs.....	462
Cortez, surveys by.....	287
Cortis, R. J., courtesies from.....	65
Coryndon, Mr., African exploration by.....	339
Cosa, Juan de la, chart by.....	283, 285, 290
Costa Rica, exchange agency.....	64, 66, 67
Coulomb, Charles Augustus, electrical experiments by.....	146
Coulomb, electrical unit of quantity.....	143
Cranial characteristics.....	535
Craniology, ancient.....	597
of the Guanches.....	542
Crawford, John M., collections from.....	8, 43
Creak, Captain, magnetic survey by.....	183
Cresson, Hilborne.....	48
Crocker, Dr. M. M., donation to Zoological Park.....	72
Croll, Dr. James.....	310
Crozet Islands, penguins at.....	301
Crump burial cave, Frank Burns on.....	87
Crutchfield, Mr., donation to Zoological Park.....	71
Crystallization, by G. D. Liveing.....	85
Crystals, rejuvenescence of.....	85
Cuba, exchange agency.....	64
transmissions to.....	66, 67
Culin, Stewart.....	52

	Page.
Cullom, Shelby M., Regent of Smithsonian Institution	x, xi
Cunard Steamship Company, courtesies from	65
Cuneiform writing, invention of	601
Currents, kinds of electric	131
ocean	344
and food supply	533
Curtis, G. E., on rain making	265, 269
Curtiss, G. G., on rain making	269
Curves in Greek architecture	573
Cushing, Frank Hamilton	52, 55
Cuvier, studies of skeletons by	407
Cyprus, former fertility of	214

D.

Da Costa, Dr. J. M., lecture by	20
D'Almeirim, Baron, courtesies from	65
Dardanelles, currents of the	347
Darling, J. H., donation to Zoological Park	71
D'Arsonval, M., on measurement of temperatures	395
Darton, N. H., on phosphate beds	229
Darwin, cited	409, 414
Darwin, Dr. Erasmus, on organic evolution	413
Darwin, Prof. G., on tidal waves	354, 359
Darwin, G. H., on variation of latitude	274
Darwinian theory, basis of	414
Davis, W. A., donation to Zoological Park	72
Davis, W. M., on rain making	269
Dawes, canals of Mars seen by, in 1864	113, 115
De Caumont, French archæologist	158, 159
Deherain, researches by	217
De la Rive, multiple resonance discovered by	136
Delboeuf's law, operation of	433
D'Elcano, Sebastian, of Magellan's squadron	286
Delessert, Ed., mentioned	238
Demeny, Georges, chrono-photographs by	570
Demeny, M., researches by	398
De Morgan, Professor, mentioned	174
Denmark, exchange agency	64
transmissions to	66, 67
Density, methods of determining earth's	103
of earth's crust	102
interior of earth	102
De Romas, electrical experiments by	165
Descalier's chart of the world	291
Deslien, Nicolas, chart of the world by	288
Dessoir, Max, on illusions of the senses	556
Dewar, Professor, researches on low temperatures	175
De Wette, on logic of Aristotle and Hegel	689
Dielectrics, function of	130
Dieudonné, Dr., on effects of sunlight on bacteria	54
Digitalin, action of	393
Dilettanti Society of London	573

	Page.
Dillon, E., bronze collection of	651
Dinwiddie, William	46, 72
Dividing engine, Repsold	109
Dobrizhoffer's method of rain making	260
Dogiel, researches by	467
Dohrn, Dr., director of Naples station	17
Dollond telescope, improvements in	109
Doolittle, Professor, on variations of latitude	272
Dorsey, J. Owen	49, 51, 250
Dosai, Japanese bronze artist	624
Downes and Blunt, cited	451
Dragon tree of Orotava	547
Drainage, composition of	217
loss of nitrogen by	218
Dreyer, canals of Mars seen by, in 1879	113
Druidism, origin of	604
Du Bois-Reymond, Dr. E., on natural science and art	84
Duchenne, study of muscles by	405
Dufferin, Lord, of Royal Geographical Society	321
Dunn, Gilbert, on arctic exploring expedition	331
Dutch, survival of early customs of	593
Dutch Guiana, exchange agency	64
Dyer, Lieut. S. A., on rain making	266
Dynamographs, for recording mechanical forces of animals	394, 402
Dynamos, increased size of	171
Dyrenforth, R. G., experiments in rain making	265

E.

Earth, crust of, variation in density	102
density of interior of	102
determination of radius of	99
flattening of the, methods of determining	102
moments of inertia of	103
orbital velocity of	101
Earthquakes, address on, mentioned	322
effect on ocean	352
Easter Island images	538
Eckhardt, on heart nerves	466
Ecuador, exchange agency	64
collection from	43
transmissions to	66, 67
natural history	64
Egypt, exchange agency	64
transmissions to	66, 67
Egyptian architecture, curves in	577
chronology	596
type of Guanches	547
Egyptians, astronomical knowledge of	94
Eldridge, George H., on phosphates	230
Electric activity, unit of	147
Electric and telephonic service in National Museum	XXIV
Electric capacity, unit of	146

	Page.
Electric currents, kinds of	131
Thompson on	151
flash apparatus for photographing splash of a drop	199, 200
power, unit of	147
quantity, unit of	146
relay, invention of	144
self-induction, discovery of	150
undulations, Hertz's experiments in	84
reflection and refraction of	723
waves, D. E. Jones on	722
work, unit of	147
Electrical conductors, Hertz investigation of	723
energy, specific character	437
Engineers, American Institute of	131
exciters	133
industry, capital invested in	142
measurements, units of	142
photographs	724
units, definition and relation of	111
Electricians, International Congress of	141
Electricity, age of, by M. Mascart	153
and light, Maxwell and Hertz on	129
relation of	722
as the living motor	440
easy development of	679
decomposition by	438
discharge of, through exhausted tubes	84
discovery of alternating current	171
displacement currents	130
fluid theory of	169
history of knowledge of	165
industrial, growth of	171
measure of disturbance on wire	137
origin of	106
part of, in animal life	437
phenomena of	721
propagated by the nerves	441
static, theorem of	156
unit of resistance	143
velocity of waves of	137, 723
Electrization of muscles	405
Electro-dynamic disturbances in wires	7
Electro-dynamics, science created by Ampère	144
Electrolysis in cell nutrition	448
Electro-magnetic telegraph, made possible by Joseph Henry	144
theory of light	716
wave of light	106
Elliot, Scott, African exploration by	338
Elliott Bros., magnetometers of	176
Ellis, John T., on rain making	266
Elsdale, Lieut. Col. H., on scientific problems of the future	667
Embryology of bird's skull, Parker on	312

	Page.
Electric current, unit of	144
Encke, on transit of Venus	109
Encke's value of solar parallax	110
Encyclopédie chimique	703
Endothermic phenomena	438
Endowment for scientific research and publication	85
Energy, conservation of	147, 437, 710
electrical, specific character of	437
liberation of, in action	383
England, evolution of society in	514
survival of early customs in	593
Entomological commission, foreign exchanges of	62
Entomology of Australia	305
Equatorial ocean current	346
Erlangen University, publications from	79
Espy, James P., on rain making	260, 269
Establishment, Smithsonian, members of	IX
organization amended	XXXV, 1
Ether, luminiferous	94, 106, 129
Ethnography, American and Asiatic	538
Eulerian period, Dr. Chandler on	277
Evans, John, on polar heat	273
Evans, Sir John, cited	604
Evolution and heredity, problems of	85
Darwinian law of	386
divergent	84
doctrine of	409
of modern society in its historical aspects	507
organic, method of, Wallace on	413
origin of theory	507
Ewing, J. A., on magnetic induction	84
Exchange service. (See International Exchanges.)	
Executive committee, annual report of	XI, XV
members of	X
Explorations by Bureau of Ethnology	44
National Museum	43
Smithsonian Institution	8
Exothermic phenomena	438
Extinction of American animals	35
Eye, an electrical organ	724
ophthalmoscope for examination of	713
Eylert, Bishop, quoted	688

F.

Fairchild, Eugene, on rain making	266
Fairchild, D. G., at Naples table	17
Faliero, Francisco and Ruy	287
Fano, Giulio, on relations of physiology to chemistry and morphology	377
Farad, electrical unit of capacity	143
Faraday, electrical researches by	106, 146, 149, 168, 721
Farquhar, Capt. J. A., mentioned	335
Farre, General, mentioned	397
Farwell, Senator, on rain making	264

	Page.
Favé, General, death of	703
Favorite, G. L., donation to Zoological Park	71
Federsen, electrical experiments by	134
Fergola, Sig., on latitude variation	274
Fermentation, Helmholtz on	710
Fernow, B. E., on artificial rain	269
Ferrare, Dominique Maria de, cited	272
Ferraris, at Electrical Congress	141
Ferry, M. Jules, mentioned	397
Fichte, death of	687
Fichte, Johann Gottlieb, mentioned	654
Fick, experiments on muscles	407
Field, Marshall, donation to Chicago University	163
Finances of the Institution, annual report on	xv
modification of law relating to	xxxv
Secretary's report on	3
Finé, Oronce, cited	296
Finland, collections from	8, 43
Fish Commission, foreign exchanges of	62
Fishes, antarctic distribution of	305
Australian fresh-water	311
Bahama Islands	364
causes of variation in	422
skin friction of	677
speed of, in swimming	673
Fitzgerald, Prof. G. F., electrical researches by	722
Fizeau, M., on velocity of electricity	137
light	98, 104
Flammarion, on the planet Mars	113, 114
Flamsteed, Gascoigne's micrometer used by	96
Fletcher, Dr. Robert, quoted	256, 258
Flocculation, physical and chemical results of	215
Flood, the mammoth and the	596
Florida phosphates	228
Flügel, Dr. Felix	63, 64
Flying machines, possibilities of	668
Folk lore, American and Asiatic	537
weather-making	255
Fontarive, legacy of	164
Food, areas and food supply	525
preparation of vegetable	679
quest, migration and, Professor Mason on	523
supply of marine animals	367
Foraminifera, index of genera and species of	10, 83
Forbes, Henry O., on Antarctica	297
Forbes, W. A., cited	303
Forchammer, cited	220
Foreign exchanges of National Museum	42
Forel, Dr. August, on ants' nests	479
Forepaugh Show, loan from	72
Forests, prevent denudation of land	214
protection against fires	702
Forget, A., courtesies from	65

	Page.
Fossil birds in Chatham Islands.....	299
plants, Lacoë collection of.....	25
Fossils, origin of oldest, Professor Brooks on.....	359
Foster, Michael, work of.....	464
Foucault, velocity of light measured by.....	104
Fowke, Gerard.....	47
Fowle, F. E., jr.....	39, 73
France, exchange agency.....	64
transmissions to.....	66, 67
Institute of, Loewy on.....	697
Franck, M. François, on action of digitalin.....	393, 394
Frankland, Percy, on action of light on micro-organisms.....	455
Franklin, Jonathon, cited.....	411
Franklin's electrical experiments.....	165
Franks, Sir A. Wollaston, on Neo-Celtic art.....	604
Franz Josef Land, exploration of.....	325
Frederick William III and Berlin University.....	691
Freiburg University, publications from.....	79
Frémont, M., investigations by.....	402
Fremy, Edouard, death of.....	703
Freshfield, Douglas, of Royal Geographical Society.....	340
Fresnel, Augustin, French optician.....	156
Fresnel, the ether of.....	132
Friction, laws of fluid.....	678
skin, of fishes.....	677
Friedrich-Wilhelm University, growth of.....	653, 681
Fritsche, Dr., cited.....	187, 188
Frost, John, on Indian rain making.....	251
Froude, Mr., cited.....	677
Fuel, gas, etc., expenditures for.....	XVI
Fuchs and De Launy, cited.....	233
Fuller, Melville W., member of Smithsonian Institution.....	IX
Regent of Smithsonian Institution.....	X, XI
Funch, Edye & Co., courtesies from.....	65

G.

Gaels, origin of.....	601
Galapagos Islands, origin of giant tortoises of.....	315
Galileo, discovery of phases of Mars by.....	114
quoted.....	388
telescope first used by.....	96
Gallway, Captain. African survey by.....	339
Galton, Francis, on evolution.....	414, 425
Galvani, experiments by.....	145
Galvanism, history of.....	165
origin of.....	145
Gambier, Capt. J. W., on the Guanches.....	541
Gärtner, ergostat of.....	474
Gascoigne, William, micrometer invented by.....	96
Gaseous theory of solution.....	85
Gases and liquids, Professor Ramsey on.....	85
Gaskell, W. H., cited.....	382
Gatham, Louis, on rain making.....	263, 269

	Page.
Gatschet, Albert S.	49, 51
Gatta, L., cited	269
Gaugain, French electrician	156
Gauss, on latitude variation	275
Gautier, on phosphatic deposits	227
Geikie, Sir Archibald, on geological change and time	84
Geodesy, adjustment of errors in	108
Geodetic Congress, International	188, 274
Geodetic method of determining earth's flattening	102
Geoffroy-Saint-Hilaire, Etienne	413
Geographical distribution, fundamental law of	307
of animals	297
birds	302
giant tortoises	315
life, by C. Hart Merriam	84
tables, Smithsonian	9
Geography and geology, relation of	322
Antarctic, by Henry O. Forbes	297
Arctic and Antarctic discovery	317
bibliography of	319
cartography of America to 1570	281
Geological change and time, by Sir Archibald Geikie	84
Survey, foreign exchanges of	62
Geology, applications of physics and mathematics to	83
continental problems of	84
investigations of Beaumont in	155
origin of oldest fossils	359
relation of astronomy to	94
relation of biology to	87
German universities, development of	655
Germany, exchange agency	64
transmissions to	66, 67
Geysers, soaping, by Arnold Hague	84
Walter Harvey Weed on	83
Gido, Japanese bronze artist	624
Giessen University, publications from	79
Gilbert, G. K., donation to Zoological Park	72
on continental problems of geology	84
Gilenwater, Miss C., donation to Zoological Park	71
Gill, Dr., heliometer measurement of asteroids by	101
Girard, legacy of	164
Goessmann, analyses of seaweed by	221
Göldi, Dr., mentioned	482
Goodale, George Lincoln, on economic botany	84
Goode, G. Brown	ix, 531
on agricultural fertilizers	223
classification for World's Columbian Exposition	86
oceanic ichthyology	9
report on National Museum by	43, 86
Goodyear, William Henry, on Greek horizontal curves	573
Gothic architecture	607
Goths, arts of the	605
Göttingen University, publications from	79

	Page.
Gowland, W., on art of casting bronze in Japan	609
Grafe, lectures by	684
Gramme, M., mentioned	171
Graphophone, Indian songs recorded by	45
Gravatt, Dr. C. U.	41
Gravitation, origin of	107
solar parallax determined by theory of	98
universal, Coulomb on	165
Gravitational method of determining earth's flattening	102
determining solar parallax	98
Gravity, relation of moon's mass on	98
Gray, George, Regent of Smithsonian Institution	IX, X
Gray, Prof. Thomas, on inventors of telegraph and telephone	85
physical tables by	9
Grecian mathematics, ancient	95
Greece, exchange service with	63
Greek art, collections of	590
horizontal curves in Maison Carrée	573
studies at Berlin University	659
Green, Georgie, donation to Zoological Park	72
Green, Mr., drawings of Mars by	115
Greenland, exploration of	323
Greenough, Mr., of Royal Geographical Society	321
Greffuthe, Count, mentioned	238
Gregory, James, on determination of solar parallax	97
Gregory, Dr. J. W., African exploration by	338
Greifswald University, publications from	79
Gresham, Walter Q., member of Smithsonian Institution	IX, 1
Gresham Commission	174
Grinnell, George Bird, cited	253
Grundy, G. B., surveys by	339
Guadeloupe, exchange agency	64
Guanches, ancient inhabitants of Canary	541, 546, 600
Guanos, ammonium phosphates in	228
Guatemala, exchange agency	64
transmission to	66, 67
Guérin, J., investigations by	409
Gulf Stream, Alexander Agassiz on	83
tide influence on	345
Gulick, Rev. John, on divergent evolution	84
Gunning, researches by	467
Günther, Dr. A., cited	305
Gutenberg, invention of printing by	514
Gypsies, route from valley of Indus	339

H.

Habel, Simeon, bequest of	xv, 3
Habit and intelligence, Murphy on, cited	433
Hadandowahs, origin of	600
Hadramant Valley, journey to	338
Hafiz, researches by	467
Hague, Arnold, on soaping geysers	84

	Page
Haiti, exchange agency	64
Hales, Henry, on prehistoric New Mexican pottery	85
Hall, discovers satellites of Mars	115
Halley, on diurnal parallax of Mercury	96, 97
Hallion and Comte, mentioned	394
Hallock, William, on flow of solids	83
Hamburg-American Packet Co., courtesies from	65
Hamilton, James, bequest of	xv, 3, 20
Hamilton, Admiral Sir R. Vesey	336
Hamilton, W. R., mentioned	321
Hamy, E. T., on troglodytes	84
Hansen, on Encke's value of solar parallax	110
Hardy, Cozens, survey by	339
Harkness, William, on magnitude of the solar system	93
Harmsworth, Mr., arctic exploration by	326
Harrington, Mark W., on weather making	249
Harrisse, on discovery of America	287
Hartwell, on value of seaweed	221
Harvard, John, founder of Harvard College	161
Harvard University, founding of	161
Harveian oration, by T. Lauder Brunton	459
Harvey, William, discoveries by	392, 463
Harvey's work on diseases of the heart	459
Haserick, Captain, mentioned	335
Hastings, C. S., on history of telescope	84
Haupt, Dr. Paul, delegate to Oriental Congress	19
Hayes, Dr. H. L., loan to Zoological Park	73
Hazen, H. A., on rain making	269
Hazewell, C. C., on rain making	269
Hearing, study of nerves of	713
Heart, accelerating nerves of	466
action of digitalin on	393
diseases of, Harvey's work on	459
effect of drugs on	463
emotion on	465
sounds of, discovered by Harvey	462
syncope and stoppage of	472
training muscles of	474
treatment of diseases of	473
Heat, animal, disengagement and accumulation of	383
flow of, in conductors	143
in human body, movement of	468
mechanical equivalent of	712
Polar, decrease of	273
radiant, measurement of	109
subterranean	220
Heckel, M. E., cited	386
Hegel, at Berlin University	687
Hegelianism, school of	688
Heidelberg University, publications from	79
Helmholtz, Hermann von, biography of	709
death of	704
experiments by	440

	Page.
Helmholtz, Hermann von, inventor of ophthalmoscope.....	713
president of Electrical Congress.....	141
researches and inventions of.....	713
quoted.....	151
Henderson, J. B., executive committee report by.....	xxxiii
Regent of Smithsonian Institution.....	x, xi
Henderson, J. B., jr., collections from.....	43
Henderson, Lee, donation to Zoological Park.....	71
Henderson & Bro., courtesies from.....	65
Hennell, W. E., bronze collection of.....	651
Henry, electrical unit.....	141, 143
Henry, Joseph, biography of.....	148
electrical researches by.....	144, 149
influence of discoveries of.....	151
invents electric relay.....	144
invents intensity magnet.....	144
self-induction discovered by.....	150
Hensel, Bruckmann & Lorbacher.....	65
Herbarium, National, transferred to Museum.....	5
Herbert, Hilary A., member of Smithsonian Institution.....	ix, 1
Hérédia, M. de, mentioned.....	397
Heredity, evolution and.....	85
possibilities of.....	417
Herring, abundance of.....	365
Herschel, Sir William, on characteristics of the planet Mars.....	114
Hertz, Heinrich, biography by Helene Bonfort.....	719
discoveries by.....	724
on light and electricity.....	129
personality of.....	725
Hertz's experiments in electric undulations.....	84
method of interferences.....	133
Hewitt, J. N. B.....	52
Hicetas, astronomy taught by.....	95
Hitchcock, Romyn, on mythology of Japanese.....	86
Hitt, Robert R., Regent of Smithsonian Institution.....	x, xi, 2
Hodge, F. W.....	49
Hodgkins, Thomas G., gift of.....	xv, 3
Hodgkins estate, residuary legacy from.....	xiii
Hodgkins fund, expenditures from.....	xvi
Secretary's report on.....	11
prizes, circulars relating to.....	14
competition for.....	15
terms of.....	xiii
Hodgkinson, researches by.....	247
Hoffman, Dr. W. J.....	46, 49
Höhmel, Lieut. Von, African exploration by.....	338
Hoke, L. M., donation to Zoological Park.....	71
Holden, Prof. E. S., experiments in solar photography.....	7
Holmes, William H.....	18, 30, 46, 55
Honduras, exchange agency.....	64
Hooke, sketch of Mars by.....	114
Hooker, Sir Joseph, cited.....	309, 336
Hooker, L. M., donation to Zoological Park.....	71

	Page.
Hopi villages, survey of	44
Horrocks, on solar parallax	96, 97
Horse, analysis of movements of	397, 403
Hospitalier, at Electrical Congress	141
Houdin, Robert, cited	559
Hough, Walter, on armor	539
Houston, Edwin J., on rain making	263, 269
Howorth, Sir Henry, on methods of archaeological research	589
Hubbard, Gardiner G., on evolution of commerce	84
Hubbard, H. G., donation to Zoological Park	72
Hufeland, lectures by	684
Huggins, on water vapor in Mars	115
Humboldt, Wilhelm von, Berlin University organized by	683
on animal magnetism	694
tropical soils	225
researches by	690
sciences encouraged by	691
tour in America by	690
Hunt, T. Sterry, cited	219, 220
Huxley, Professor, quoted	303, 316
Huygens, sketch of Mars by	114
Hydrographic Office, foreign exchanges of	62
Hygienic Institute at Berlin	693
Hypodermic syringe, first use of	463
Hypnotism, phenomena of	558

I.

Iberian descent of the Guanches	542
Ice Age, cause of, by Sir Robert Ball, cited	311
Iceland, exchange agency	64
Illusions of the senses	555
Income of the Institution, available June 30, 1895	XXXIII
Secretary's power of disposition of	XIII
India, chronology of	595
explorations in	8
Indian methods of rain making	249
Indians, explorations among	8
Haida, migration of	527
investigation of habits and customs of	28
of the Amazon	598
researches among	46
use of fertilizers by	223
weather folklore among	256
Inertia, earth's moments of	103
Infra-red solar spectrum, investigation of	75
Inglefield, Edward, arctic exploration by	330
Inhibition, nature of	379, 382
Insects, cause of variations in	422, 423
life of aquatic	84
marine	368
nests of	479
of Australia	305

	Page.
Institute of France in 1894, M. Loewy on	697
Insurance on storage sheds	22
Intercontinental Railway Commission	43
Internal work of the wind, by S. P. Langley	9
International Congress of Electricians	141
International exchanges, appropriations for	XXXVII, 33
efficiency of	63
curator's report on	58
receipts and expenditures of	XVI
Secretary's report on	32
statistics of	58
Invertebrates, marine, at Bahama Islands	363, 364
Invention, birth of, Mason on	85
Investment of income of the Institution	XIII
Iodine, marine origin of	227
Ireland, early knowledge of metallurgy in	603
Iron Age in Japan	609, 610
art in Ireland, early	603
first use of	602
Italian cartography of America	287
Italy, exchange agency	64
transmissions to	66, 67
Iyemitsu, tomb of	621
Iyeyasu, tomb of	620
Izan, Japanese bronze artist	624

J.

Jackson, F. G., Arctic exploration by	326
Jacobi, Karl, mentioned	711
Janowski, on typhoid bacillus	451
Janssen, J., observations on Mont Blanc by	237
on photographic photometry	191
Japan, exchange agency	64
transmissions to	66, 67
Japan current, cause of	345
Japanese bells, measurements of	620
bronzes, method of making	609, 626, 628
ornamentation of	625
wood-cutting and printing	87
Jardin des Plantes, area of	36
Java, exchange agency	64
Jena University, publications from	79
Jenkins, analyses of seaweed by	221
Jenner, Dr., cited	472, 477
Jenner, Sir William, honors to	460
Johns Hopkins University, publications from	79
Johnson, A. J., donation to Zoological Park	71
Johnston, William P., Regent of Smithsonian Institution	x
Jones, D. E., electric wave researches	722
Joule, unit of electric work	143, 147
Joule, James Prescott	147, 710
Jouy Korean collection	86

	Page.
Jouy, P. L., donation to Zoological Park.....	71
Judd, John W., on rejuvenescence of crystals.....	85
Jupiter, eclipses of satellites of.....	105

K.

Kallstenius, Evald Gustaf, Arctic exploration by.....	331
Kangaroo, giant, in Australia.....	305
Kann, Karl, on Arctic exploring expedition.....	331
Kapila, theory of.....	507
Karakane, composition of Japanese bronze.....	643
Karakoram glaciers, survey of.....	339
Karr, W. W., donation to Zoological Park.....	71
Kashmir, explorations in.....	43
Kazen University, publications from.....	79
Keeler, Lucy Elliot, on Indian rain making.....	253
Kelly, Henry H., donation to Zoological Park.....	72
Kelvin, Lord, cited.....	134, 139, 276, 354, 717
experiments in electricity by.....	147
Kepler, on solar parallax.....	96
Kerguelen Land, topography of.....	309
Kerniss, Dutch.....	592
Kerr, Mark B., collection from.....	43
Kidder, Dr. J. H., bequest of.....	3
Kiel University, publications from.....	79
King, Capt. J. W., donation to Zoological Park.....	71
Klafroth, lectures by.....	684
Koehler, S. R., on Japanese woodcut printing.....	87
Koenig, beat tones of.....	716
Königsberg, University of.....	79, 686
Korean collections in National Museum.....	86
Koreff, on animal magnetism.....	694
Krakatoa, loss of life at.....	356
Kuehling, J. H., donation to Zoological Park.....	71, 72
Küstner, Dr., on latitude variation.....	276
Kwanyin, colossal figure of.....	622

L.

Lacoe collection of fossil plants.....	25
Läennec, introduced auscultation.....	462
Lagrange's law.....	103
Lamarck, on organic evolution.....	409, 413, 414
Lamb, F. A., African survey by.....	339
Lamont, Daniel S., member of Smithsonian Institution.....	IX, 1
Langley, S. P., annual report as secretary.....	1-88
experiments in aerodynamics by.....	669
on internal work of the wind.....	9
Langton, Stephen, mentioned.....	512
Language of the Guanches.....	549
Languages, American and Asiatic.....	536
history of.....	594
Las Casas, cited.....	289

	Page.
Latin studies at Berlin University	659
Latitude, inaccuracy of	109
variation of, article on	271
Laughton, J. K., on weather making	270
Lawrence, Sir Trevor	625, 651
Layard, Henry, death of	705
Lea collection of minerals and shells	25
Leannarda, C. W., loan to Zoological Park	73
Leech, Dr., mentioned	478
Legroux, legacy of	164
Leipsic University, publications from	79
Le Maout, Charles, on rain making	270
Le Maout, Emile, on rain making	270
Lépine, researches by	467
Le Pilem, researches by	247
Leverrier, French astronomer	157
on Encke's value of solar parallax	110
weather forecasts	158
Leverson, Major, African survey by	339
Lewis, J. C., on rain making	270
Liberia, collections from	8, 43
exchange agency	64
Librarian, report of	79
Library, constitution of	80
expenditures for	16
increased by exchanges	80
regulations of	80
Secretary's report on	11
Library of Congress, foreign exchanges of	62
Liebig, Justus von, autobiography of	84
Liege University, publications from	79
Life, animal, part of electricity in	437
origin and development of	386
Light, action of, on micro-organism	455
and electricity, according to Maxwell and Hertz	129
relation of	722
corpuscular theory of	105
earth, intensity of	194
effect of, on bacteria	451
electro-magnetic theory of	716
emission theory of	106
Fresnel's researches on	156
intensity of, from the moon	193
magnetic theory of	723
magnetization of ray of	106
mathematical theory of	721
nature of	132
sensation of, Helmholtz on	715
study of movement of	699
synthesis of	136
theories of	129
undulatory theory of	106
velocity of	98, 104, 129

	Page
Lilford, Lord, mentioned	335
Lime, agricultural use of	216
carbonate of, sources of	220
Ling, on massage treatment	473
Linguistic studies at Berlin	659
Linguistics of American Indians	29, 50
Liquids and gases, Professor Ramsay on	85
Lisle, Leconte de, death of	707
Lister, on heart pulsation	466
Littledale, on travels by Marco Polo	338
Liveing, G. D., on crystallization	85
Living cell, part played by	447
motor, nature of	439
Lockyer, sketches the planet Mars	114
Locomotion, mechanism of	395
Locomotor muscles, study of	409
system of medusæ	379
Lodge, Henry Cabot, Regent of Smithsonian Institution	xi
Lodge, Dr. O. T., electrical researches by	722
Loewy, M., on Institute of France in 1894	697
Lommel, Eugene, on work of George Simon Ohm	83
Longtail, Philip	51
Lönnerberg, Dr. Einar, collection from	43
Louvain University, publications from	79
Lucas, Frederick A.	41
Ludwig, Carl, investigations on blood circulation	464
Lumholtz, Carl	49, 52
Luminiferous ether	94, 106, 129
Lund University, publications from	79
Luni-solar precession	103
Lysimetry, principles of	216, 217

M.

McBeth, Miss S. L.	52
McCaddon, J. T., donation to Zoological Park	71
McGee, W. J.	29, 46
McMurtrie, Daniel	41
Macdonald, Herbert, on Arctic exploring expedition	331
Macfarlane, Prof. A., on rain making	266, 270
Machin, determination of solar parallax by	98
Mackay, Capt. Alexander, on rain making	261
Mackay, George, on rain making	260
Maconochie, Captain	321
Madagascar, botany of	306
extinct species of ostrich in	300
giant tortoises of	315
nests of ants in	482
Madeira, exchange agency	64
Madrazo, Federico, death of	706
Magellan's squadron, explorations by	286
Magendie, blood pressure measured by	392
Maggiolo, Viscount di	287

	Page.
Magna Charta of 1215, object of.....	512
Magnet, daily oscillation of.....	179
Magnetic elements, value of.....	177-180
induction, molecular process of.....	84
storms, effect on needle.....	179
Magnetism, animal, study of.....	694
origin of.....	106
phenomena of.....	721
terrestrial, Professor Rücker on.....	173
Magnetization of ray of light.....	106
Magnetometers, used by Professor Rücker.....	176
Magnitude of the solar system, Harkness on.....	93
Magowan, D. J., on Chinese time keeping.....	84
Maison-Carrée, at Nimes, curves in.....	573
Maissiat, study of muscles by.....	405
Majolica, Italian, origin of.....	592
Malayan Islands, fauna of.....	299
Mallard, Ernest, death of.....	704
Mallery, Col. Garrick.....	31, 46, 50, 54
Malta, exchange agency.....	64
Mammals of Australia.....	304
principles of variation in.....	421
Man, origin of.....	597
Mandan Indian rain makers.....	250
Manometer, mercurial, use of.....	392
Mantez, José, courtesies from.....	65
Maps, early American.....	281
Maraldi, sketch of Mars by.....	114
Marburg University, publications from.....	79
Marco Polo, Littledale on travels by.....	338
Marcuse, latitude observations by.....	277
Marey, E. J., chrono photographs by.....	570
on work of physiological station of Paris.....	391
Marine charts, origin of.....	283
locomotion, development of.....	672
Markham, Clement R., on arctic and antarctic discovery.....	317
Marmion, Dr. R. A.....	41
Marquesan Islanders, primitive habits of.....	598
Marquette, Father James, mentioned.....	253
Mars, atmosphere and temperature of.....	118
distance from earth to.....	97
diurnal parallax of.....	96
first known observation of.....	114
first map of, 1840.....	114
oppositions of.....	96, 107
rotation of.....	114, 115
satellites of, discovered in 1877.....	115
Secchi's study of colors of.....	114
Schiaparelli's latest views regarding.....	113
triangulation of.....	115
Mascarene Islands, giant tortoises of.....	315
Mascart, M., at electrical congress.....	141
on the age of electricity.....	153

	Page.
Mason, O. T., on birth of invention.....	85
migration and food quest.....	523
progress in anthropology.....	84, 85
Massage treatment, advantage of.....	473
Masson, Orme, on gaseous theory of solution.....	85
Mastication, analysis of movements in.....	400
Mathematicians, rise of great.....	662
Mathematics, advantage of study of.....	663
ancient Greek.....	95
applications to geology.....	83
study of, at Berlin University.....	685
Matthews, Washington, on Navajo dyestuffs.....	84
Mauritius, exchange agency.....	64
Maxim, Hiram, flying machine by.....	669
Maxwell, J. C. (see also Clerke-Maxwell).....	275
on light and electricity.....	129
Maxwell's mathematical theory of light.....	721
theory of electricity.....	170
Maya and Malay languages, affinities between.....	51
Maya inscriptions, study of.....	31
Mayer, M., mentioned.....	710
Mayer, T., solar parallax determined by.....	98
Mayow, researches on blood circulation by.....	467
Mearns, Dr. A. E., collection from.....	43, 71
Medal, Copley, awarded to Helmholtz.....	712
Medicine, American inventions and discoveries in.....	86
Melville, R. D., on evolution of modern society.....	507
Mendenhall, T. C., mentioned.....	255
on the Henry.....	141
Menhaden, for fertilizer.....	233
Menomoni Indians, Dr. Hoffman on.....	49
Mercator's map of the world.....	288, 296
Mercury, distance from earth to.....	97
diurnal parallax of.....	96, 97
Merriam, C. Hart, on geographical distribution of life.....	84
Metallurgy, development of.....	603
Japanese compositions.....	644
Metal work, ancient.....	604
Meteoric dust in rain water.....	219
Meteorological Conference, International.....	177
tables.....	9
work of Smithsonian Institution.....	84
Meteorology, oceanic.....	350
of planet Mars.....	119
Meyen, Captain, magnetic observations by.....	187
Meyers, R. L., donation to Zoological Park.....	71
Miall, L. C., on aquatic insects.....	84
Micrometer, invention of, by Gascoigne.....	96
Micrometer microscopes.....	109
Middleton, Clarke, donation to Zoological Park.....	71
Migration and the food quest, Professor Mason on.....	523
Mills, Dr. C. K., lecture by.....	20
Mills, R., mentioned.....	651

	Page.
Mind, Mr. Salton on.....	432
Mindeleff, Cosmos, explorations by.....	44, 47
Mineralogy, benefit of study of.....	663
Minerals and shells, Lea collection of.....	25
Miscellaneous Collections, expenditures for.....	XVI
Secretary's report on.....	9
Mitchell, Dr. S. Weir, investigations by.....	451
on massage treatment.....	473, 478
Moas, remains of, in New Zealand.....	300
Moctezuma, Louis C.....	53
Mohammedan art.....	606
Molecular process in magnetic induction.....	84
Moleschott, on heart pulsation.....	466
Monachus, Franciscus, globe made by.....	296
Mond, Ludwig.....	175
Mongolia and Tibet, explorations in.....	8, 10, 85
Mongols in China.....	592
Mont Blanc, observations at summit of.....	237
Moon, amount of light reflected by.....	193
attraction of sun and earth on.....	100
determination of mass of.....	98
parallax of.....	98
distance from earth to.....	95, 99
parallactic inequality of.....	100
perturbation of.....	100
relation of, to gravity.....	98
to tides.....	98
sun's attraction on.....	100
time of sidereal revolution.....	99
variation of centripetal force on.....	100
Mooney, James, explorations by.....	45
Moore, H. C., donation to Zoological Park.....	69, 71
Moore, Capt. W. N., on ocean currents.....	348
Moorish tiles.....	606
Moose, extinction of.....	35
Morales, Andres de, charts by.....	286
Morgan, Lewis H., on Indian migration.....	526
Morice, Father, cited.....	638
Morley, Prof. E. W., on density of oxygen and hydrogen.....	16
Morphology, relations of physiology to.....	377
Morrill, Justin S., introduces bill for Baird statue.....	21
Regent of Smithsonian Institution.....	X, XI
Morton, J. Sterling, member of Smithsonian Institution.....	IX, 1
Morton, Thomas, New England Canaan by.....	224
Mosso, A., researches by.....	467
Moses, Mrs. W. B., loan from.....	72
Mouillard, L. P., on flight of birds.....	85
Mounds, aboriginal burial.....	85
of Mississippi Valley.....	84
Mountains of the planet Mars.....	120
Moureaux, M., magnetic survey by.....	183
Mourt, George, history of Plymouth by.....	224
Mozambique, exchange agency.....	64
Müller, Fritz, cited.....	426, 493

	Page.
Muller, Johannes, mentioned	710
Müller, W., cited	500
Mummies of Canary Islands	544
Munoz y Espriella, courtesies from	65
Münster, Sebastian, chart by	296
Müntz and Marcano, on tropical soils	225
Murdoch, John	55
Murbach, Prof. Lewis, at Naples table	17
Murchison, Sir Roderick, vice-president Geographical Society	321
Murphy, J. J., on habit and intelligence, cited	433
Murray, John, on Antarctic exploration	336
cubic contents of ocean	343
Muscles, effect of electricity on	440
functions of	405
modification of	410
sound made by	462
Muscular action, Helmholtz on	710
contractility	442
exertion, phenomena of	471
Museum of Comparative Zoology, founded by Agassiz	162
Natural History at Berlin	693
Museums, European	25
Myograph records changes of volume in organs	393
Mythology of American Indians	52

N.

Nansen's Arctic expedition	324
Naples table, advisory committee of	18
leased by Smithsonian Institution	17
Nares, Sir George, Antarctic exploration by	336
Arctic expedition by	322
National Museum, accessions to	41
appropriation for	4
Assistant Secretary's report on	41
compared with museums in Europe	25
Congressional acts relating to	XXXVII
crowded condition of	4, 21
expenditures for publications	XXV
explorations by	8
foreign exchanges of	42
genesis of, by G. Brown Goode	86
need of larger appropriations	27
publications of	28, 42, 86
receipts and expenditures of	XIX
Secretary's report on	21
scientific staff of	26, 41
statistics of visitors	42
valuable gifts to	25
National Zoological Park, appropriation for	XXXVIII, 4
area of	36
benefit to public	35
list of animals in	69

	Page.
National Zoological Park, receipts and expenditures of	XXX
roads in	38
Secretary's report on	34
sewers in	XXXIX
Superintendent's report on	68
Natural gas, rock pressure of	83
science and art, relation of	84
sciences, benefit of study of	663
methods of studying	692
Navajo dyestuffs, Washington Matthews on	84
Naval architecture of North of Europe	86
Navigation, aerial, progress in	670
marine, development of	672
Navy Department, foreign exchanges of	62
Nectar Canal on Mars	114
Neo-Celtic art, origin of	604
Neolithic Age in Canary Islands	546
Neptune, discovered by Leverrier	157
distance of	111
Nerve and muscle fiber, Humboldt's experiments on	690
Nerves, propagation of electricity in	441
stimulating power of	442
variations of temperature caused by	392
Nervous centers, inhibitory action of	383
system, action of	382
development of	444
reason for existence of	443
relation to muscles and bones	411
stimulator of senses	444
Netherlands, exchange agency	64
transmissions to	66, 67
New Caledonia, exchange agency	64
Newcomb, Simon, on Eulerian Period	278
latitude variation	276
rain making	263, 264, 269
Newfoundland, exchange agency	64
New South Wales, exchange agency	64
transmissions to	66, 67
Newtonian theory of gravitation	97
New Zealand, exchanges with	64, 66, 67
former size of	302
fossils in	300
Nez Perce Indians, vocabulary of	52
Niagara Falls, utilized for electric power	171
Nicaragua, ants nests in	500
Nicetas, astronomy taught by	95
Nikko, Japan, bronzes at	621
Nile Valley, origin of tribes of	600
Nilus on planet Mars	115
Nimes. Maison-Carrée at	573
Nimroud, excavations at	705
Nitrate soils in tropics	226
Nitrogen, conservation of	225

	Page.
Nitrogen, loss of, in agriculture	218
Noble, W., on Indian rain making	251
Nöllner on nitrate deposits	227
Nordenskiöld, Baron, subscription by	333
Nordenskiöld's globe	291
North American Ethnology, appropriation for	xxxviii, 4
receipts and expenditures	xviii
report on	28, 44
North German Lloyd, courtesies from	65
Norway, exchange agency	64
transmissions to	66, 67
Nouri, Dr. J. J.	51
Noyes, Isaac P., on rain makers	270
Number systems, primitive	85
Nutation, constants of	101, 102

O.

Obarrio, Melchor, courtesies from	65
Observatory on Mont Blanc	240
Ocean, bottom, characteristics of	353
primitive fauna of	374
discovery of, Professor Brooks on	359
currents and food supply	533
Wharton on	344
depth of, Wharton on	348, 349
mean level of	357
physical condition of, Wharton on	343
tidal waves on	354
waves caused by earthquakes	352
O'Dell, L. N., donation to Zoological Park	72, 73
Odogenesis, definition of	447
Odograph, for measuring steps	396
Oelrichs & Co., courtesies from	65
Oersted, electrical discoveries by	144, 166
Oertel, on muscle training	473, 474
Ohlin, Dr., Arctic exploration by	333
Ohm, George Simon, scientific work of	83
sketch of life of	143
Ohm, electrical unit of resistance	143
Ohm's law in electricity	143, 145
Okhotsk Sea, food supply in	531
Olney, Richard, member of Smithsonian Institution	ix, 1
Ommanney, Admiral Sir Erasmus	336
Ophthalmometer, invention of	715
Ophthalmoscope, invention of	713
Optical deflection of straight lines	583
effects of curves	576
Optics, Helmholtz's researches in	715
Organic evolution, method of	413
stability	430
Organism, subordination of parts of	411
Oriental discoveries by Layard	705

	Page.
Oriental languages and peoples	600
Orientalists, International Congress of	19
Ornithology of Australia	299
Orton, Edward, on rock pressure of natural gas	83
Osborn, Henry Fairfield, on evolution and heredity	85
Osborn, Sherard, Arctic exploration by	330, 334
Ostrich, African, characteristics of	308
geographical distribution of	300
remains of extinct species of	300
Overton, Percy, donation to Zoological Park	71
Oxford and Cambridge universities founded	513
Oxygen and hydrogen, Professor Morley on density of	16
question of solar	243

P.

Pacinotti, M., experiments by	170
Packard, R. L., on pre-Columbian copper mining	85
Paget, experiments on the heart by	466
Paleolithic Age in Canary Islands	546
man in Europe	599
Paleontology, origin of oldest fossils	359
Palmen, Dr. J. A., on migration of birds	85
Paper, compressed, for vessel covering	676
Paraguay, exchange agency	64
Paris physiological station, work of	391
Paris University founded	513
Parker, Prof. W. K., mentioned	303
Parry, Dr., cited	472
Parsons, Alfred, mentioned	623, 651
Parthenon, curves in entablature of	573
Paschal, G. W., donation to Zoological Park	71
Pasteur, M., discoveries by	392, 477
Patagonia, extinct species of ostrich in	300
Pathologic Institute in Berlin	692
Patinas of Japanese bronze	648
Payer's Arctic sledge journey	325
Peary, Lieut. Robert E., Greenland exploration by	328
Peckham, Adelaide Ward, on typhoid and the colon bacillus	451
Pendulum experiments	99, 100
seconds, length of	99, 102
Penguins, geographical distribution of	300
Pennethorne, John, on architectural curves	577
Pennsylvania University, publications from	79
Penrose, Francis Cranmer, on Athenian architecture	573
Periodicals, statistics of, in Smithsonian library	79
Perry, Ed., & Co., courtesies from	65
Perry, Newman K., donation to Zoological Park	71
Persian porcelain	607
Peru, astronomical observatory in	162
exchange agency	64
transmissions to	66, 67
Peters, C. A. F., on latitude variation	276
Petrie, Professor, discoveries at Coptos by	600

	Page
Pfeffer, on plant irritation, cited.....	387
Phelps Bros. & Co., courtesies from.....	65
Philippine Islands, exchange agency.....	64
Philolaus of Crotona, on astronomy.....	95
Philology at Berlin University.....	686
study of, at Berlin University.....	660
Philosophic to scientific age, transition from.....	681
Philosophy, study of, at Halle.....	686
Phosphate beds, origin of.....	231
Phosphatic deposits, distribution of.....	227
Phosphoric acid in fish.....	222
Photographic photometry, Janssen on.....	191
Photographs of splash of drop of water, etc.....	208
Photography, chrono, uses of.....	570
electrical.....	724
relation to astronomy.....	699
solar, Professor Holden's experiments in.....	7
Photometry, celestial.....	192
International Congress of.....	191
photographic, Janssen on.....	191
Phototachymetrical methods.....	104
Physical condition of the ocean, Captain Wharton on.....	343
Society of Berlin.....	711
tables, Smithsonian.....	9
Physicists, rise of great.....	662
Physicochemical theory of life.....	377
Physicochemistry, principles of.....	437
Physics, applications to geology.....	83
benefit of study of.....	664
relation to chemistry.....	698
Physiologic and Physical Institute of Berlin.....	693
Physiological basis of thought.....	379
station of Paris, work of.....	391
voltaic battery.....	441
Physiology as related to chemistry and morphology.....	377
Picard, solar parallax determined by.....	96, 97
Piccard, J. F., on rain making.....	270
Pickering, William H., on Schiaparelli's latest views regarding Mars.....	113
Pictet, Raoul, researches in low temperatures.....	384
Pictography, Colonel Mallery's study of.....	31, 50
Pilling, James C.....	53
Pim, Forwood & Co., courtesies from.....	65
Pinzon, Martin Alfonso.....	289
Pinzon, Vincencio Yanez.....	286
Piorry, on cardiac murmurs.....	462
Pizarro, surveys by.....	287
Planets, relative distances from.....	95
Plant food, waste and conservation of.....	213
Plants, Humboldt's experiments on growth of.....	690
marine.....	366
Playfair, on massage treatment.....	473
Pliny, on distances to sun and moon.....	95
Poincaré, M., on light and electricity.....	129
Point Barrow expedition.....	55

	Page.
Polar heat, decrease of	273
Pollard, John Garland	54
Pollock, G. F., donation to Zoological Park	71
Polynesia, exchange agency	64
transmissions to	66, 67
Polynesian bow, E. Tregar on	85
Pomares, Mariano, courtesies from	65
Poncin, quoted	562
Porcelain, Chinese, decoration of	592
in Persia	607
Porter, A. A., donation to Zoological Park	71
Portugal, exchange agency	64
transmissions to	66, 67
Portuguese chart makers	287
Postage and telegraph, expenditures for	xvi, xxiv
Potash deposits, distribution of	232
Potential of electricity	147
Pottery of the Guanches	551
Potts, T. H., on rain making	270
Pouillet, electrical experiments by	168
Powell, Maj. J. W.	xviii, 29, 526
Powers, Edward, method of rain making	264, 270
Powys, Mervyn, Arctic researches by	335
Pratt, F. W., donation to Zoological Park	71
Pratt, N. A., on phosphates	230
Precession, constants of	101, 102
luni-solar	103
Preece at Electrical Congress	141
Preston, latitude observations by	277
Prestidigitation, psychology of	555
Prince Henry, discoveries by	283
Printing, expenditures for	xvi
Proctor, determines periodic rotation of Mars	115
Psychology, Major Powell's investigations in	83
of prestidigitation, Binet on	555
Ptolemaic system of astronomy	95
Ptolemy's Almagest, cited	114
Public documents, international exchange of	61
Publications of Bureau of Ethnology	54, 88
National Museum	xxv, 28, 42, 86
receipts from sale of	xvi
received in Smithsonian Library	11, 79
Secretary's report on	8
Pueblo Country, explorations in	44
Purinton, L. W., donation to Zoological Park	72
Putton, P. H., donation to Zoological Park	71
Pythagoras, astronomical knowledge of	94
Pythagorean system suppressed	95

Q.

Quatrefages, Armand de, on advent of man in America	85
Queensland, exchange agency	64
transmissions to	66, 67

R.

	Page.
Race problem, Professor Mason on.....	535
Radiant heat, measurement of.....	109
Radius of earth, determination of.....	99
Rain, denudation caused by.....	215
Raindrops, cause of bubbles by.....	206
Rain makers in India.....	270
Rain making by electric connection with cloud.....	260
great fires.....	260
sudden chill.....	263
concussion theory.....	264
Dyrenforth theory.....	265
Indian methods of.....	249
physical methods of.....	259
Rain water, impurities of.....	219
Ralph collection of birds' eggs.....	25
Ramie fiber, for vessel covering.....	676
Ramsey, Prof. William, on liquids and gases.....	85
Rawlinson, Sir Henry, of Royal Geographical Society.....	339
Rayleigh, Lord, mentioned.....	175
Raynaly, M., prestidigitator.....	571
Read, Charles H., mentioned.....	651
Red Star Line, courtesies from.....	65
Rees, J. K., on variation of latitude.....	271
Reformation, effect of the.....	514
Refraction and reflection of electricity.....	723
Regents, executive committee of.....	x
list of.....	x
proceedings of meeting of.....	xi
Reinel, Jorge and Pedro.....	287
Relay, electric, invention of.....	144
Religion and folklore, American and Asiatic.....	538
Renaissance, period of the.....	513
Renan, Ernest, quoted.....	699
Renatus, Duke.....	291
Réné, Duke, of Lothringen.....	287
Repsold dividing engine.....	109
Researches, Secretary's report on.....	7
expenditures for.....	xvi
Resistance, elastic and viscous.....	130
Resonance exciter.....	135
Revolving mirror method of measuring light.....	104
Reymond, Du Bois, mentioned.....	711
Ribero, map designed by.....	287
Richer, solar parallax determined by.....	96
Roberts-Austen, Professor, analyses by.....	643
Rochana, Buddhist divinity.....	618
Rockefeller, John D., founds Chicago University.....	162
Rockhill, W. W., explorations in Tibet by.....	8, 10, 85
Rocky Mountain goat in Zoological Park.....	37
Rodway, James, on struggle for life in the forest.....	84
Rohl, C., courtesies from.....	65
Roman Church, influence on sciences.....	663

	Page.
Roman remains in England.....	596
Romanes, G. J., cited.....	379
Römer, solar parallax determined by.....	96
Ross, Commander J. B. de, death of.....	705
Ross, Sir James, on ocean depth.....	348
Rostock University, publications from.....	79
Rothschild, Baron Alph. de, mentioned.....	238
Rouelle, French chemist.....	154
Roumania, exchange agency.....	64
transmissions to.....	66, 67
Roux, M. W., on muscle modification.....	410
Rowell, G. A., on rain making.....	270
Rowland, Professor, at Electrical Congress.....	141
Royal Geographical Society, address before.....	317
Royal Society of London, history of.....	463
Rücker, Arthur W., biography of Helmholtz by.....	709
on terrestrial magnetism.....	173
Ruge, Sophus, on cartography of America.....	281
Ruggles, Gen. Daniel, on rain making.....	264, 270
Ruiz, Domingo L., courtesies from.....	65
Russell, Robert, on rain making.....	270
Russia, exchange agency.....	65
gold produce of.....	322
transmissions to.....	66, 87
Ruysch, Johann, early map by.....	287, 295
Ryder, Dr. J. A.....	18

S.

Sadler, researches by.....	467
Salaries, expenditures for.....	XVI-XXXIII, 56
Salisbury, Lord, mentioned.....	428
Saltpeter, exported from Chile.....	227
Sanderson, J. S. Burdon, cited.....	382
San Salvador, exchange agency.....	65
transmissions to.....	66, 67
Sarasin, multiple resonance discovered by.....	136
Satow, F. A., mentioned.....	651
Saxon remains in England.....	596
Say, Leon, mentioned.....	238
Schaffer, G. F., donation to Zoological Park.....	71
Schiaparelli, Giovanni, on canals of Mars.....	113
Schiff, on heart pulsation.....	466
Schleiermacher, mentioned.....	687
Schmid, E. S., donation to Zoological Park.....	71, 72
Schmidt, Alexander, cited.....	467
Schöner, Johann, globe by.....	296
Schott, on muscle treatment.....	473
Schreiber, Paul, on rain making.....	270
Schroepfer, A., on rain making.....	270
Schroeter, the planet Mars studied by.....	114
Schröter, Ludwig, illustrations of ants' nests by.....	503
Schuchert, Charles.....	41

	Page.
Schumacher, A., & Co., courtesies from.....	65
Schumacher, H. A., cited.....	292
Science and art, relation between.....	698
Scientific discoveries during nineteenth century.....	701
problems of the future, Colonel Elsdale on.....	667
Szczelkow, on circulation of blood.....	467
Seal of the Smithsonian Institution.....	XIV, 18
Seaweed, agricultural value of.....	221
analyses of.....	221
general uses of.....	221
Secchi's study of the colors of Mars.....	114
Sec-ohm, proposed as unit of induction.....	152
Seimin and Toun, bronzes by.....	623
Seismic waves, extensive movement of.....	352
Semitic origin of Babylonia.....	602
Sensations of tone, Helmholtz on.....	713
Shakespeare, Dr. E. O., lecture by.....	20
Shannon, Dr. W. C., United States Army, collections from.....	43
Sharpey, Professor, work of.....	464
Shaw, F. G., donation to Zoological Park.....	71
Sherborn, C. Davies, index of Foraminifera by.....	10, 83
Shufeldt, R. W., on taxidermy in National Museum.....	87
Shugio, Hieromich, mentioned.....	18
Shuster, Professor, on polar changes.....	274
Shute, D. Kerfoot, on anthropology of the brain.....	85
Sidereal month, length of.....	99
Siderostat, improvement in.....	77
Siemens, Professor, mentioned.....	693
Siemens, Walter von, on circulation of atmosphere.....	83
Siemens, Werner, research laboratory founded by.....	717
Sight, sensations of, Helmholtz on.....	715
Silurians of Glamorganshire.....	600
Simpson, Charles T., collections from.....	43
Smith, C. A., quoted.....	256
Smith, D. M., donation to Zoological Park.....	71
Smith, Mrs. E. A., on Indian rain making.....	249
Smith, F. J., mentioned.....	210
Smith, G. V., on use of flint blades.....	84
Smith, Harding, mentioned.....	618
Smith, Hoke, member of Smithsonian Institution.....	IX, 1
Smith, John B., on Noctuidæ.....	42
Smith, Leigh, Arctic exploration by.....	325
Smith, S. W. J., mentioned.....	179
Smith, W. Harding, mentioned.....	651
Smithson, James, bequest and legacy of.....	XV, 3
Smithson fund, condition of, July 1, 1894.....	XV
receipts and expenditures of.....	XVI
Smithsonian building, repair of.....	XVI, XXVIII, 5
Smithsonian Institution, annual report on finances of.....	XV
appropriations disbursed by.....	XXXII, 4
available income.....	XXXIII
circular relating to work of.....	12
Congressional acts relating to.....	XXXV

	Page
Smithsonian Institution, deposit of fund in Treasury	3
disposition of income	XIII
expenditures of	3
explorations by	8
law as to finances modified	XXXV
library of	79
officers of	IX
organization act amended	XII
receipts and expenditures of	XVI
regents of	X
report on administration	2
researches aided by	7
seal of	XIII
Secretary's report on	1-88
summary of finances of	XXXII
Smoot & McCulloh, donation to Zoological Park	72
Snow, as foundation for observatory	239
Soaping geysers, by Arnold Hague	84
Society, emancipation of the individual	519
evolution of, Melville on	507
Sociology, of American Indians	50
problems of	586
Solar bodies, relative distance of	94
parallax, Encke's value of	110
methods of determining	95, 98
photography, Professor Holden's experiments in	7
rays, question of oxygen in	244
spectrum, oxygen lines in	245
system, magnitude of	93, 111
Solids, flow of, by William Hallock	83
Solis, Juan Diaz de	286
Solution, gaseous theory of	85
Solvay, Ernest, on part of electricity in animal life	437
Somali Land, exploration in	339
Soret, researches by	247
Sorge, discoveries by	714
Sotomayor, Simon de Alcazaba de	287
Sound, Helmholtz's investigations of	713
made by muscles	463
Tyndall's lectures on, quoted	379
Sounds of the heart discovered by Harvey	462
Spain, exchange agency	65
transmissions to	66, 67
Spanish cartography, beginning of	284
invasion of Canary Islands	548
Spears, John R., on Corbin Game Park	84
Specific gravity of sea water	354
Spectral analysis, advances in	109
Spectroscopy, celestial	83
Spectrum, infra-red solar	75
Speed in marine navigation, problem of	673
Spencer, Herbert, cited	429, 723
Sphygmoscope, for measuring pulsations	393

	Page.
Spiers, R. Phene, mentioned.....	651
Splash of a drop and allied phenomena.....	197
milk drop, photographs of.....	209
water drop, photographs of.....	209
Spratt, Thomas, cited.....	463
Stainton, cited.....	426
Stamford Parry, Herron & Co.....	65
Star places, determination of.....	109
Stassfurt, saline formation near.....	233
Stationery, expenditures for.....	XVI
Statue of Secretary Baird, bill for.....	21
Stein, Robert, proposed Arctic expedition by.....	333
Steamships, increase in speed of.....	674
Stevenson, Adlai E., member of Smithsonian Institution.....	L, LX
Regent of Smithsonian Institution.....	X, XL
Stevenson, Matilda Coxe.....	53
Stevenson, R. L., quoted.....	206
Stewart, Alexander, courtesies from.....	65
Stewart, Balfour, quoted.....	180
Stewart, B. D., donation to Zoological Park.....	71
St. Gaudens, Augustus, seal designed by.....	XIV, 18
St. Helena, exchange agency.....	65
Stiles, Dr., on advisory committee of Naples table.....	18
Stokes, Professor, mentioned.....	174
Stone, E. J., on transit of Venus.....	109
Stone, G. H., on rain making.....	270
Stone Age, languages during.....	595
Stone implements from India, by Thomas Wilson.....	87
Storage sheds, danger from.....	22
Strachey, General, of Royal Geographical Society.....	321
Strassburg University, publications from.....	79
Struve, angle measurements by.....	109
Student life at Berlin University.....	655
Study and research, by Rudolph Virchow.....	653
Sturgeon, experiments with electro-magnets.....	144
Sully, James, cited.....	555
Sun, composition of.....	246
distance from earth.....	95, 97, 111
relative mass of.....	100
Sunlight destructive to certain bacteria.....	451
Sun's motion in space.....	83
Suzuki Chokichi, Japanese bronze founder.....	624
Swan, J. M., mentioned.....	623, 651
Sweden, exchange agency.....	65
transmissions to.....	66, 67
Switzerland, exchange agency.....	65
transmissions to.....	66, 67
Symbiosis between ants and plants.....	493

T.

Tait, Professor, quoted.....	712
Tana River, Africa, expedition to.....	338
Tanchosai, Japanese bronze artist.....	624

	Page.
Tapirs, limited distribution of	297
Tartini's tone, discovery of	714
Tasmania, exchange agency	65
Tassin, Wirt	41
Taxidermy in National Museum, Shufeldt on	87
Taylor, Dr. J. Cleasby, on craniology of Guanches	542
Taylor, William B., editor's report by	88
Tebbs, H. V., mentioned	651
Tegetmeier, M., cited	411
Telegraph and telephone, inventors of	85
Telegraph, electro-magnetic, made possible by Joseph Henry	144
Teleki, Count, African exploration by	339
Telescope, Dollond, improvements in	109
first use of, by Galileo	96
history of	84
largest known, at Chicago	163
limit of accuracy of	109
photographic	175
zenith, new form of	279
Temperature, distribution in human body	392
Temperatures, low, effect on chemical reaction	384
lowest ocean	351, 353
Terrestrial magnetism, Professor Rücker on	173
Teutonic art	605
Theban temple of Medinet Habon	577
Thermometers for measuring body temperature	392
Thomas, Cyrus	48, 54
Thomson, J. J., electrical experiments by	84, 197
Thomson, William, discoveries by	710
Thomson, Sir Wyville, cited	371
Thompson, Sir Henry	175
Thompson, Russell J., on aboriginal burial mounds	85
Thompson, Silvanus, mentioned	141
Thompson, Prof. W., on electric currents	151
Thompson, Sir William, on variation of earth's axis	273, 276
Thorp, Dr., magnetic survey by	176
Thought, physiological basis of	383
Tibet, Rockhill's explorations in	8, 85
Tice, J. H., on rain making	270
Tidal waves, cause and movement of	354
Tide, influence on Gulf Stream	345
producing forces of	98
Tides, heights of	355
relation of moon's mass to	98
Time keeping, Chinese methods of	84
Timor Island, fauna of	299
Tisserand, M., on polar motion	278
Todd, Dr. R. B., on cardiac murmurs	462
Tokumo, T., on Japanese woodcut printing	87
Tomkinson, M., mentioned	651
Tone, sensations of, Helmholtz on	713
Toner, Dr. J. M., lecture fund established	20
Toriello, Enrique, courtesies from	65

	Page.
Tornadoes, treatment of.....	258
Tortoises, giant, of Galapagos and Madagascar.....	315
Toryusai, Japanese bronze artist.....	624
Toscanelli, chart of.....	288
Townley, Richard, original micrometer used by.....	96
Trade winds, course of.....	344
Traill, Dr. H. D., quoted.....	508
Transportation, primitive methods of.....	525
Treasury Department, foreign exchange of.....	62
Tregar, E., on the Polynesian bow.....	85
Trevor-Battye, Mr., mentioned.....	335
Troglodytes, E. T. Hamey on.....	84
Trowbridge, John, on rain making.....	270
Tubar Indians.....	49
Tubingen University, publications from.....	79
Turkey, exchange agency.....	65
Tusayan, explorations in.....	44
Tyndall, Professor, mentioned.....	389, 723
Tyndall, researches by.....	247
Typhoid and the colon bacillus, destruction of.....	451

U.

Uber, C. E., donation to Zoological Park.....	71
Universities, institution of.....	513
Universities of Oxford and Cambridge, founded.....	513
University, Berlin, development of.....	655
founding of.....	681
Chicago, founding of.....	162
University of Bologna, founded.....	513
Paris, founded.....	513
Ural Mountains and gold product of Russia.....	322
Uruguay, exchange agency.....	65
transmissions to.....	66, 67
Utrecht University, publications from.....	79

V.

Vallot, M. J., observatory on Mont Blanc by.....	238
Van Bibber, Andrew, on rain making.....	270
Vandeleur, Lieut. S., African survey.....	339
Vanden Toorn, W. H., courtesies from.....	65
Vandremer, M., mentioned.....	240
Van Rijckevorsel, Dr., on magnetic elements.....	177
Variation, principles of organic.....	419
of latitude, J. K. Rees on.....	271
Varignon, Pierre, French geometrician.....	153
Vauquelin, French chemist.....	154
Venezuela, exchange agency.....	65
nitrate soils of.....	225
transmissions to.....	66, 67
Venus, distance from earth to.....	97
solar parallax determined by.....	97
transits of.....	97, 107, 109

	Page.
Verrazzano, Giovanni, early map by	288
Vespucci, Amerigo, chief pilot of Spain	286
Vespucci, Juan, mentioned	
Victoria, exchange agency	65
transmissions to	67
Victoria Land, discovery of	337
Vinci, Lionardo da, cited	194
Violle, researches by	247
Virchow, Rudolph, on founding of Berlin University	681
study and research	653
Virginia, early fisheries of	224
bonds, sale of	xv
Visigoths, art of the	05
Vital activity, mechanism of	445
Vivisection, discoveries by	392
Voelcker, cited	219
Volcanic eruptions in ocean bed	356
Volkman, on pulse registration	465
Volta, discoveries by	146, 165
Von Bezold, electrical researches by	722
on the heart nerves	466
Von Frey, researches by	467
Von Hardenberg, on animal magnetism	694
Von Helmholtz, Hermann, at Electrical Congress	141
biography of	709
Vortex motion, characteristics of	717

W.

Waddington, M., death of	705
Wadsworth, F. L. O., resignation of	39, 78
Walcott, C. D., on oldest fossil fauna	259, 375
Waldseemüller, Martin	291
Waldseemüller's globe of 1509	296
Walferdin, thermometers made by	392
Walker, Gen. F. A., and Bureau of Ethnology	28
Walker, Dr. Fuller, on weather making	249
Wallace, cited	409
Wallace, Alfred R., on geographical distribution of animals	299
method of organic evolution	413
Walther, Henry	47
Walton, J. P., on rain making	270
Wanner, Atrous, on Indian relics	85
Wapiti, extinction of	35
War Department, foreign exchanges of	62
Ward, R. De C., on rain making	270
Waring, Dr. G. E., jr., lecture by	20
Warington, on lime salts	218
Washburn, Dr., on agricultural use of seaweed	221
Washington, Captain, mentioned	321
Water, resistance of, methods of overcoming	675
sea, specific gravity and temperature of	354
drop, photograph of splash	209

	Page.
Watt, unit of electric power.....	143, 148
Waves, seismic, great extent of.....	352
tidal, cause and movement of.....	354
Weather forecasts in 1854.....	157
making, ancient and modern.....	249
physical methods.....	258
Weber, Ernest Heinrich, mentioned.....	466
Webster, Dr. A. G., researches by.....	7
Weed, Walter Harvey, on geysers.....	83
Weimaraner, general chart of 1527.....	287
Weir, Jenner, cited.....	426
Welling, James C., Regent of Smithsonian Institution.....	X, XI
Wellman, Walter, Arctic exploration by.....	327
Wesley, William, & Son.....	63, 64
West Shere Railroad bonds, from Hodgkins estate.....	XV, 4
Weyher, M., study of tornadoes.....	258
Weyprecht, Lieutenant, Arctic observations by.....	325, 327
Wharton, Capt. W. J. L., hydrographer.....	336, 341
on physical condition of the ocean.....	343
Wheeler, on agricultural value of seaweed.....	221
Wheeler, Joseph, Regent of Smithsonian Institution.....	X, XI, 2
Wheeler, L. M., donation to Zoological Park.....	71
Wheeler, Dr. W. M., at Naples, table.....	17
White, Andrew D., Regent of Smithsonian Institution.....	X, XXXV, 2
White, Dr. C. H., United States Navy.....	41
White Cross Line, courtesies from.....	65
Wilde, Henry, on terrestrial magnetism.....	182
Wiley, Harvey W., on waste and conservation of plant food.....	213
Williams, Mrs. A. B., loan to Zoological Park.....	73
Williams, A. Stanley, on the planet Mars.....	115
Williams, Dr. C. J. B., on cardiac murmurs.....	462
Wilson, Dr. E. B.....	18
Wilson, Thomas, on primitive industry.....	85
stone implements from India.....	87
Wind, ocean waves caused by.....	355
Winds, prevailing, in Pacific Ocean.....	533
trade, course of.....	344
Winlock, W. C., on progress of astronomy.....	85
report as curator of exchanges.....	67
Winogradsky, researches by.....	234
Wolf, Christian, philosophy taught by.....	686
Wolfart, on animal magnetism.....	694
Wollaston, discovered sound made by muscles.....	462
Wood, Dr. Alexander, hypodermic syringe introduced by.....	463
Woodcut printing, Japanese.....	87
Woodward, J. J., lecture by.....	20
Woodward, Professor, geographical tables by.....	9
Woodward, R. S., cited.....	278
Wooldridge, researches by.....	476
World's Columbian Exposition.....	18, 141, 159
classification for.....	86
Worthington, Prof. A. M., on splash of a drop.....	197
Wren, Christopher, on circulation as affected by drugs.....	463

	Page.
Wright, Peter, & Sons, courtesies from.....	65
Wurzburg University, publications from.....	79
Wyatt, on phosphate deposits.....	229
Wynee, J. H., donation to Zoological Park.....	72

Y.

Yellowstone National Park.....	35, 37
geological history of.....	84
Yerkes, W., donation to Zoological Park.....	71
Yoritoms, victories of.....	616
Young, Thomas, capillaries investigated by.....	461

Z.

Zamoiski, codex of, 1468.....	282
Zoologic Institute at Berlin.....	693
Zoological Park. (<i>See</i> National Zoological Park.)	
Zoological parks, European, area of.....	36
Zoology, benefit of study of.....	663
Japanese animal painters.....	623
oceanic ichthyology.....	9
of Australia.....	299
oldest fossils.....	360
skin friction of fishes.....	677
Zurich University, publications from.....	79



SMITHSONIAN
INSTITUTION

REPORT

WASHINGTON



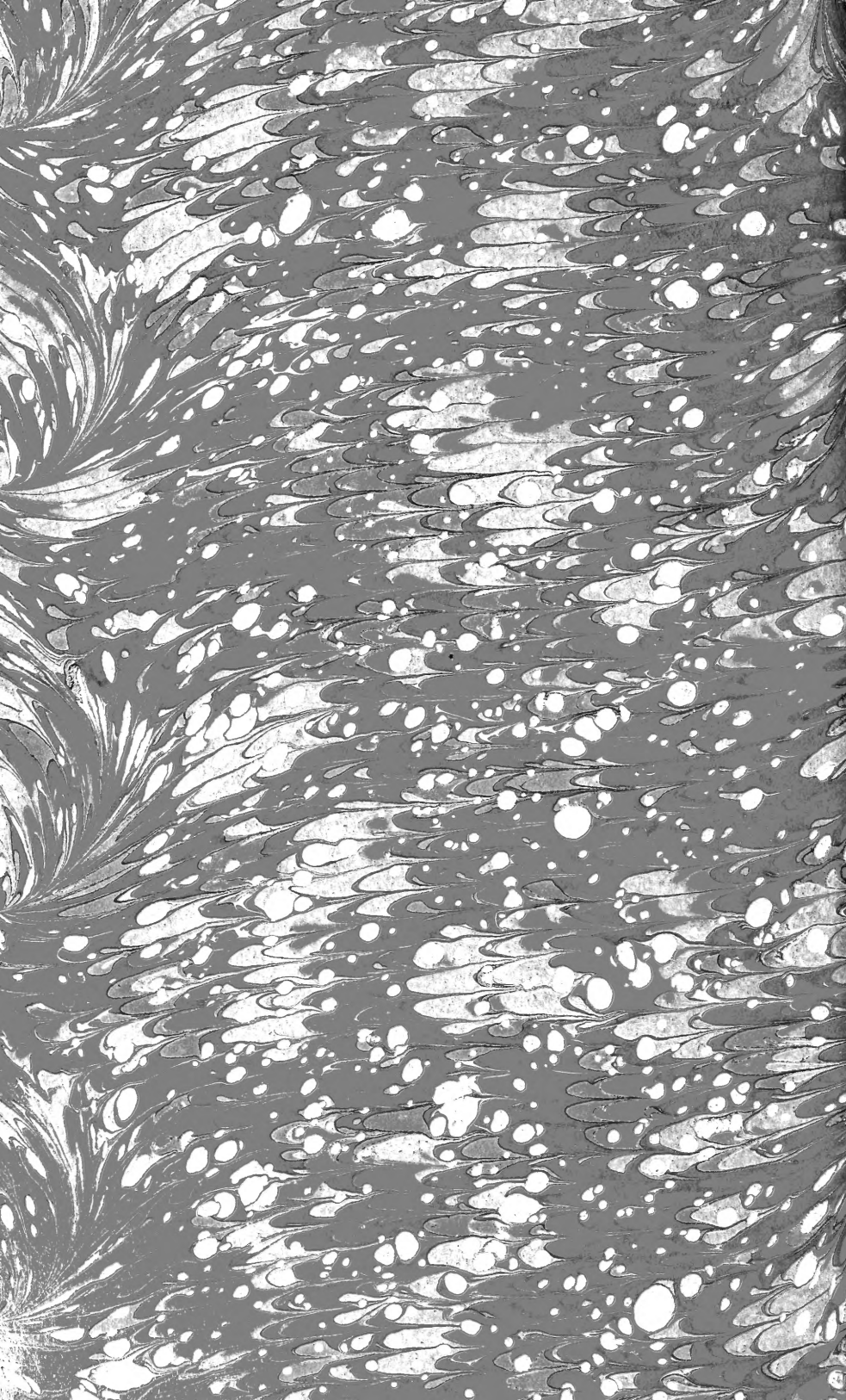

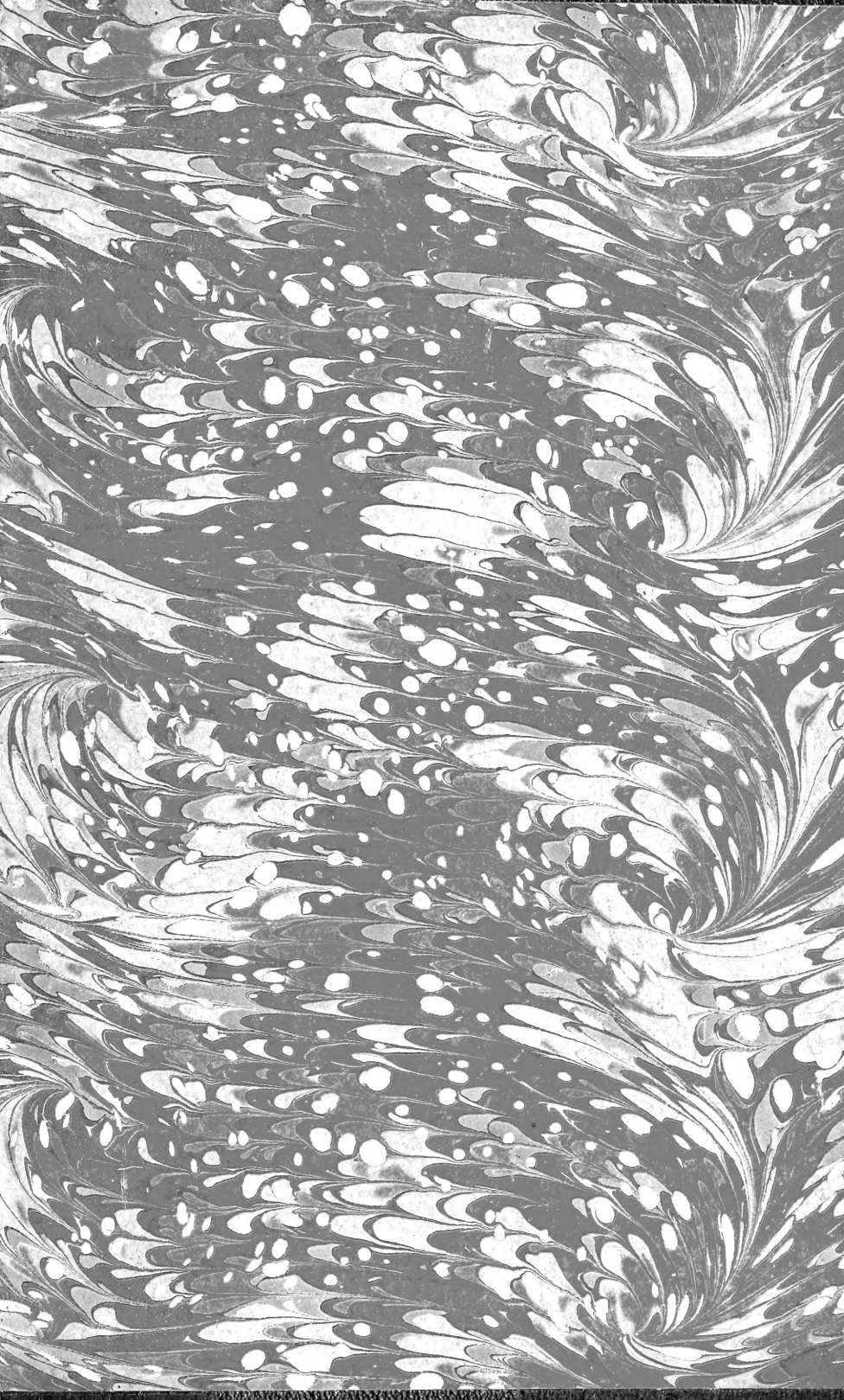

SMITHSONIAN INSTITUTION LIBRARIES



3 9088 01421 6642