

ANNUAL REPORT OF THE
BOARD OF REGENTS OF
THE SMITHSONIAN
INSTITUTION

SHOWING THE
OPERATIONS, EXPENDITURES, AND
CONDITION OF THE INSTITUTION
FOR THE YEAR ENDING JUNE 30

1912



WASHINGTON
GOVERNMENT PRINTING OFFICE
1913

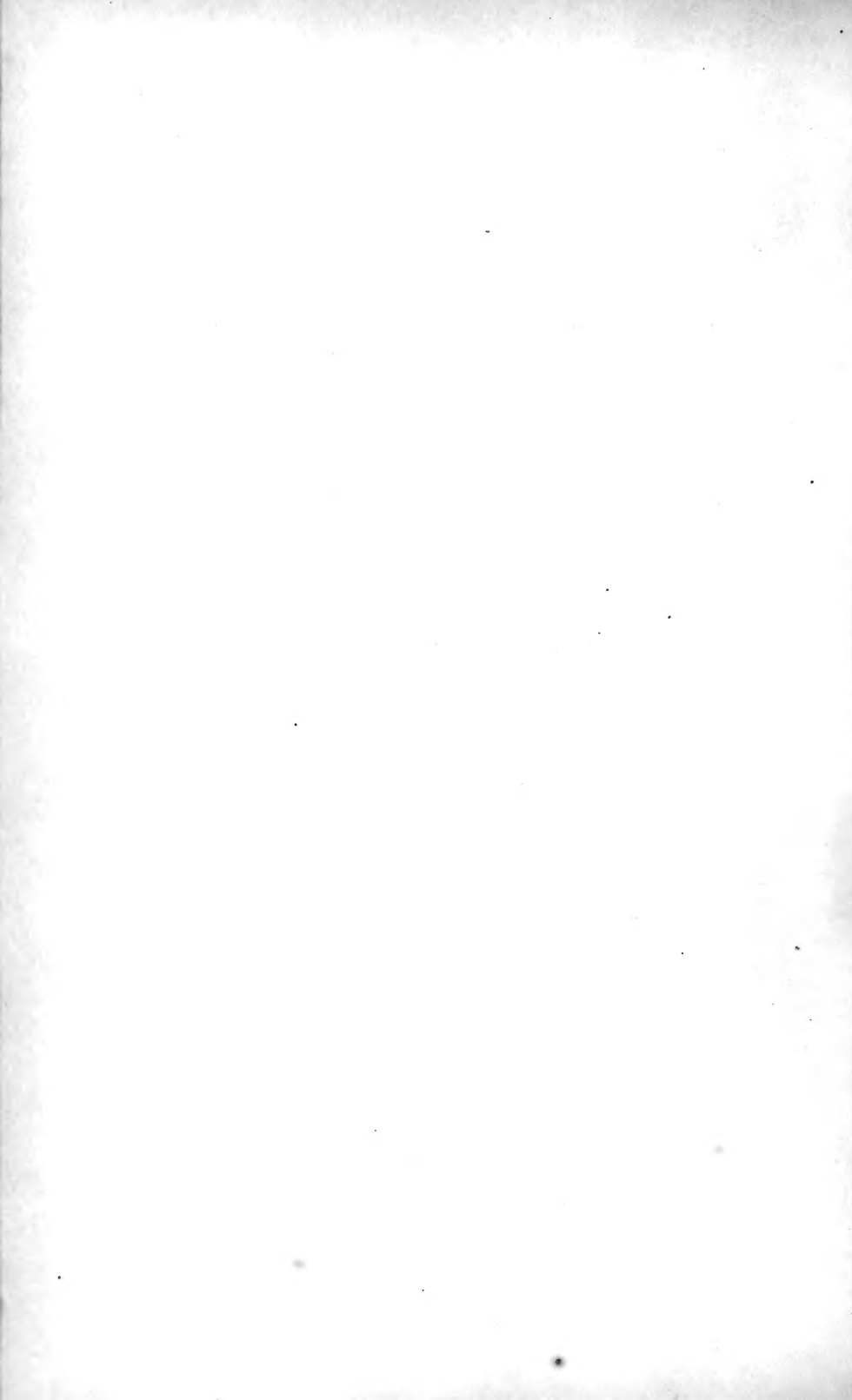

L E T T E R

FROM THE

SECRETARY OF THE SMITHSONIAN INSTITUTION,

SUBMITTING

THE ANNUAL REPORT OF THE BOARD OF REGENTS OF THE
INSTITUTION FOR THE YEAR ENDING JUNE 30, 1912.

SMITHSONIAN INSTITUTION,
Washington, March 29, 1913.

To the Congress of the United States:

In accordance with section 5593 of the Revised Statutes of the United States, I have the honor, in behalf of the Board of Regents, to submit to Congress the annual report of the operations, expenditures, and condition of the Smithsonian Institution for the year ending June 30, 1912. I have the honor to be,

Very respectfully, your obedient servant,

CHARLES D. WALCOTT, *Secretary.*



CONTENTS.

	Page.
Letter from the Secretary submitting the Annual Report of the Regents to Congress.....	III
Contents of the report.....	V
List of plates.....	VII
General subjects of the annual report.....	IX
Officials of the Institution and its branches.....	XI

REPORT OF THE SECRETARY.

The Smithsonian Institution.....	1
The Establishment.....	1
The Board of Regents.....	1
General considerations.....	2
Finances.....	5
Explorations and researches—	
Studies in Cambrian geology and paleontology.....	7
Raney African expedition.....	8
Frick African expedition.....	9
Biological survey of the Panama Canal Zone.....	9
Siberian expedition.....	10
Borneo expedition.....	10
Biological Survey in the Canadian Rockies.....	11
Anthropological researches in Siberia and Mongolia.....	11
Antiquity of man in Europe.....	12
Researches under the Hodgkins fund.....	12
Smithsonian table at the Naples Zoological Station.....	13
Publications.....	14
Library.....	19
Langley memorial tablet.....	19
Hamilton lecture.....	20
International congresses and celebrations.....	21
George Washington Memorial Building.....	22
National Museum.....	23
Bureau of American Ethnology.....	25
International Exchanges.....	25
National Zoological Park.....	27
Astrophysical Observatory.....	28
International Catalogue of Scientific Literature.....	28
Appendix 1. Report on the United States National Museum.....	30
2. Report on the Bureau of American Ethnology.....	37
3. Report on the International Exchanges.....	58
4. Report on the National Zoological Park.....	71
5. Report on the Astrophysical Observatory.....	82
6. Report on the Library.....	89
7. Report on the International Catalogue of Scientific Literature.....	99
8. Report on the Publications.....	102

REPORT OF THE EXECUTIVE COMMITTEE.

Condition of the fund July 1, 1912.....	111
Receipts and disbursements July 1, 1911, to June 30, 1912.....	112
Summary of appropriations by Congress.....	114

PROCEEDINGS OF BOARD OF REGENTS.

Meetings of December 4, 1911, and February 8, 1912.....	115
---	-----

GENERAL APPENDIX.

The year's progress in astronomy, by P. Puiseux.....	135
The spiral nebulae, by P. Puiseux.....	143
The radiation of the sun, by C. G. Abbot.....	153
Molecular theories and mathematics, by Émile Borel.....	167
Modern mathematical research, by G. A. Miller.....	187
The connection between the ether and matter, by Henri Poincaré.....	199
Experiments with soap bubbles, by C. V. Boys.....	211
Measurements of infinitesimal quantities of substances, by William Ramsay...	219
The latest achievements and problems of the chemical industry, by Carl Duisberg.....	231
Holes in the air, by W. J. Humphreys.....	257
Review of applied mechanics, by L. Lecornu.....	269
Report on the recent great eruption of the volcano "Stromboli," by Frank A. Perret.....	285
The glacial and postglacial lakes of the Great Lakes region, by Frank B. Taylor.	291
Applied geology, by Alfred H. Brooks.....	329
The relations of paleobotany to geology, by F. H. Knowlton.....	353
Geophysical research, by Arthur L. Day.....	359
A trip to Madagascar, the country of beryls, by A. Lacroix.....	371
The fluctuating climate of North America, by Ellsworth Huntington.....	383
The survival of organs and the "culture" of living tissues, by R. Legendre....	413
Adaptation and inheritance in the light of modern experimental investigation, by Paul Kammerer.....	421
The paleogeographical relations of antarctica, by Charles Hedley.....	443
The ants and their guests, by P. E. Wasmann.....	455
The penguins of the antarctic regions, by L. Gain.....	475
The derivation of the European domestic animals, by C. Keller.....	483
Life: its nature, origin, and maintenance, by E. A. Schäfer.....	493
The origin of life: a chemist's fantasy, by H. E. Armstrong.....	527
The appearance of life on worlds and the hypothesis of Arrhénius, by Alphonse Berget.....	543
The evolution of man, by G. Elliot Smith.....	553
The history and varieties of human speech, by Edward Sapir.....	573
Ancient Greece and its slave population, by S. Zaborowski.....	597
Origin and evolution of the blond Europeans, by Adolphe Bloch.....	609
History of the finger-print system, by Berthold Laufer.....	631
Urbanism: A historic, geographic, and economic study, by Pierre Clerget..	653
The Sinai problem, by E. Oberhammer.....	669
The music of primitive peoples and the beginnings of European music, by Willy Pastor.....	679
Expedition to the South Pole, by Roald Amundsen.....	701
Icebergs and their location in navigation, by Howard T. Barnes.....	717
Henri Poincaré: his scientific work; his philosophy, by Charles Nordmann....	741

LIST OF PLATES.

	Page.		Page.
SECRETARY'S REPORT:		ADAPTATION AND INHERITANCE	
Plates 1, 2.....	76	(Kammerer):	
RADIATION OF SUN (Abbot):		Plates 1-8.....	442
Plates 1-2.....	154	ANTS AND THEIR GUESTS (Was-	
Plates 3-4.....	158	mann):	
SOAP BUBBLES (Boys):		Plates 1-10.....	474
Plate 1.....	214	PENGUINS (Gain):	
HOLES IN THE AIR (Humphreys):		Plate 1.....	476
Plates 1-2.....	260	Plates 2-5.....	478
ERUPTION OF STROMBOLI (Perret):		Plates 6-9.....	480
Plate 1.....	285	FINGER-PRINT SYSTEM (Laufer).	
Plates 2-9.....	290	Plates 1-3.....	640
CLIMATE OF NORTH AMERICA (Hunt-		Plates 4-7.....	650
ington):		SINAI PROBLEM (Oberhammer):	
Plates 1, 2.....	392	Plates 1, 2.....	670
Plates 3, 4.....	398	Plate 3.....	676
Plates 5, 6.....	400	ICEBERGS (Barnes):	
Plates 7, 8.....	402	Plate 1.....	726
Plates 9, 10.....	408	Plates 2, 3.....	738
LIVING TISSUES (Legendre):			
Plates 1-4.....	420		



ANNUAL REPORT OF THE BOARD OF REGENTS OF THE
SMITHSONIAN INSTITUTION FOR THE YEAR ENDING
JUNE 30, 1912.

SUBJECTS.

1. Annual report of the secretary, giving an account of the operations and conditions of the Institution for the year ending June 30, 1912, with statistics of exchanges, etc.
2. Report of the executive committee, exhibiting the financial affairs of the Institution, including a statement of the Smithsonian fund, and receipts and expenditures for the year ending June 30, 1912.
3. Proceedings of the Board of Regents for the sessions of December 14, 1911, and February 8, 1912.
4. General appendix, comprising a selection of miscellaneous memoirs of interest to collaborators and correspondents of the Institution, teachers, and others engaged in the promotion of knowledge. These memoirs relate chiefly to the calendar year 1912.



THE SMITHSONIAN INSTITUTION.

JUNE 30, 1912.

Presiding officer ex officio.—WILLIAM H. TAFT, President of the United States.
Chancellor.—JAMES S. SHERMAN, Vice President of the United States.

Members of the Institution:

WILLIAM H. TAFT, President of the United States.
JAMES S. SHERMAN, Vice President of the United States.
EDWARD DOUGLASS WHITE, Chief Justice of the United States.
PHILANDER C. KNOX, Secretary of State.
FRANKLIN MACVEAGH, Secretary of the Treasury.
HENRY L. STIMSON, Secretary of War.
GEORGE W. WICKERSHAM, Attorney General.
FRANK H. HITCHCOCK, Postmaster General.
GEORGE VON L. MEYER, Secretary of the Navy.
WALTER L. FISHER, Secretary of the Interior.
JAMES WILSON, Secretary of Agriculture.
CHARLES NAGEL, Secretary of Commerce and Labor.

Regents of the Institution:

JAMES S. SHERMAN, Vice President of the United States, Chancellor.
EDWARD DOUGLASS WHITE, Chief Justice of the United States.
SHELBY M. CULLOM, Member of the Senate.
HENRY CABOT LODGE, Member of the Senate.
AUGUSTUS O. BACON, Member of the Senate.
JOHN DALZELL, Member of the House of Representatives.
SCOTT FERRIS, Member of the House of Representatives.
IRVIN S. PEPPER, Member of the House of Representatives.
ANDREW D. WHITE, citizen of New York.
ALEXANDER GRAHAM BELL, citizen of Washington, D. C.
GEORGE GRAY, citizen of Delaware.
CHARLES F. CHOATE, Jr., citizen of Massachusetts.
JOHN B. HENDERSON, Jr., citizen of Washington, D. C.
CHARLES W. FAIRBANKS, citizen of Indiana.

Executive Committee.—A. O. BACON, ALEXANDER GRAHAM BELL, JOHN DALZELL.

Secretary of the Institution.—CHARLES D. WALCOTT.

Assistant Secretary in charge of National Museum.—RICHARD RATHBUN.

Assistant Secretary in charge of Library and Exchanges.—FREDERICK W. TRUE.

Chief Clerk.—HARRY W. DORSEY.

Accountant and Disbursing Agent.—W. I. ADAMS.

Editor.—A. HOWARD CLARK.

THE NATIONAL MUSEUM.

Keeper ex officio.—CHARLES D. WALCOTT, Secretary of the Smithsonian Institution.

Assistant Secretary in charge.—RICHARD RATHBUN.

Administrative Assistant.—W. DE C. RAVENEL.

Head Curators.—WILLIAM H. HOLMES, LEONHARD STEJNEGER, G. P. MERRILL.

Curators.—R. S. BASSLER, A. HOWARD CLARK, F. W. CLARKE, F. V. COVILLE, W. H. DALL, B. W. EVERMANN, J. M. FLINT, U. S. N. (retired), W. H. HOLMES, WALTER HOUGH, L. O. HOWARD, ALÈS HRDLIČKA, G. P. MERRILL, GERRIT S. MILLER, Jr., RICHARD RATHBUN, ROBERT RIDGWAY, LEONHARD STEJNEGER, CHARLES D. WALCOTT.

Associate Curators.—J. N. ROSE, DAVID WHITE.

Curator, National Gallery of Art.—W. H. HOLMES.

Chief of Correspondence and Documents.—RANDOLPH I. GEARE.

Superintendent of Construction and Labor.—J. S. GOLDSMITH.

Editor.—MARCUS BENJAMIN.

Photographer.—T. W. SMILLIE.

Registrar.—S. C. BROWN.

BUREAU OF AMERICAN ETHNOLOGY.

Ethnologist in charge.—F. W. HODGE.

Ethnologists.—J. WALTER FEWKES, J. N. B. HEWITT, FRANCIS LA FLESCHÉ, TRUMAN MICHELSON, JAMES MOONEY, MATILDA COXE STEVENSON, JOHN R. SWANTON.

Philologist.—FRANZ BOAS.

Editor.—JOSEPH G. GURLEY.

Illustrator.—DE LANCEY W. GILL.

INTERNATIONAL EXCHANGES.

Assistant Secretary in charge.—FREDERICK W. TRUE.

Chief Clerk.—C. W. SHOEMAKER.

NATIONAL ZOOLOGICAL PARK.

Superintendent.—FRANK BAKER.

Assistant Superintendent.—A. B. BAKER.

ASTROPHYSICAL OBSERVATORY.

Director.—C. G. ABBOT.

Aid.—F. E. FOWLE, Jr.

REGIONAL BUREAU FOR THE UNITED STATES, INTERNATIONAL CATALOGUE OF SCIENTIFIC LITERATURE.

Assistant in charge.—L. C. GUNNELL.

REPORT
OF THE
SECRETARY OF THE SMITHSONIAN INSTITUTION

CHARLES D. WALCOTT,

FOR THE YEAR ENDING JUNE 30, 1912.

To the Board of Regents of the Smithsonian Institution:

GENTLEMEN: I have the honor to submit herewith a report showing the operations of the Smithsonian Institution and its branches during the year ending June 30, 1912, including the work placed by Congress under the direction of the Board of Regents in the United States National Museum, the Bureau of American Ethnology, the International Exchanges, the National Zoological Park, the Astrophysical Observatory, and the United States Bureau of the International Catalogue of Scientific Literature.

The general report reviews the affairs of the Institution proper, with brief paragraphs relating to the several branches, while the appendix presents detailed reports by those in direct charge of the work. Independently of the present report, the operations of the National Museum and the Bureau of American Ethnology are fully treated of in separate volumes.

THE SMITHSONIAN INSTITUTION.

THE ESTABLISHMENT.

The Smithsonian Institution was created an establishment by act of Congress approved August 10, 1846. Its statutory members are the President of the United States, the Vice President, the Chief Justice, and the heads of the executive departments.

THE BOARD OF REGENTS.

The Board of Regents consists of the Vice President and the Chief Justice of the United States as ex officio members, three Members of the Senate, three Members of the House of Representatives, and six citizens, "two of whom shall be resident in the city of Washington, and the other four shall be inhabitants of some State, but no two of them of the same State."

In regard to the personnel of the board I may here record that Dr. James B. Angell, of Michigan, resigned on January 15, 1912, after an honorable service as Regent for 25 years. The vacancy thus caused was filled by Congress by the appointment of Hon. Charles W. Fairbanks, of Indiana, who as Vice President of the United States had formerly been a Regent from 1904 to 1909. Representatives Scott Ferris and Irvin S. Pepper were appointed Regents to succeed Representatives Howard and Mann. The roll of Regents at the close of the fiscal year was as follows: James S. Sherman, Vice President of the United States, Chancellor; Edward D. White, Chief Justice of the United States; Shelby M. Cullom, Member of the Senate; Henry Cabot Lodge, Member of the Senate; Augustus O. Bacon, Member of the Senate; John Dalzell, Member of the House of Representatives; Scott Ferris, Member of the House of Representatives; Irvin S. Pepper, Member of the House of Representatives; Andrew D. White, citizen of New York; Alexander Graham Bell, citizen of Washington, D. C.; George Gray, citizen of Delaware; Charles F. Choate, jr., citizen of Massachusetts; John B. Henderson, jr., citizen of Washington, D. C.; and Charles W. Fairbanks, citizen of Indiana.

The annual meeting of the board was held on December 14, 1911, and the usual supplementary meeting on February 8, 1912. The proceedings of these meetings and the annual report of the executive committee are printed in the customary form and the details need not therefore be repeated here.

GENERAL CONSIDERATIONS.

The affairs of the Institution and of its branches have been conducted during the year with success and, I trust, to the satisfaction of all interested. The work covers practically the entire field of natural and physical science, as well as anthropological and archeological researches. The extent of that work is limited only by the amount of the funds available. I referred in my last report to the establishment of a trust fund by Mrs. E. H. Harriman for carrying on certain research work, and I desire here to mention the generosity of several friends of the Institution who have provided means for engaging in certain biological expeditions.

The equipping of the new National Museum building with cases and the installation of the collections progressed satisfactorily. It is anticipated that during the fiscal year 1913 the building will be entirely occupied and all the exhibition halls opened to the public. The great extent of this work may be best understood by the statement that the exhibition halls embrace an area of about 220,000 square feet, or 5 acres. The installation had been so thoroughly planned by Assistant Secretary Rathbun and his associates that the work in

all the departments has advanced in an orderly and systematic fashion.

Although the new Museum building is intended primarily for the exhibition of natural-history specimens, the main floor of the large central hall has been temporarily given up to the exhibition of the collections of paintings belonging to the National Gallery of Art. It is to be noted in this connection that Mr. William T. Evans has presented 137 paintings illustrating the work of 100 American artists. This extremely valuable collection should in due time be housed in a suitable art gallery, with other valuable collections of this character belonging to the Government. The details of the development of the Museum system and accessions made to the collections will be found in the report of the assistant secretary in charge of the Museum.

As I have stated in previous reports, I believe it desirable to establish a number of research associateships similar to the Harriman trust fund, whereby especially capable men in the several branches of science may be afforded opportunities for research work without the care and burden of administrative duties, and with full assurance that as long as their work is properly conducted it will be continued, and that provision will be made for them when incapacitated for active service. The field for scientific investigation is extensive, and there are numbers of worthy projects that can not now be undertaken because of lack of means—projects that could not properly be carried on through Government appropriation, but which the Smithsonian Institution could readily undertake were the means available.

In this connection I would call attention to the organization of a Research Corporation in which the Institution is particularly interested.

Research Corporation.—Dr. Frederick G. Cottrell, of the United States Bureau of Mines, having generously offered to present to the Smithsonian Institution a valuable set of patents relating to the electrical precipitation of dust, smoke, and chemical fumes, it seemed to the Regents advisable, for various reasons incident to the business management of the patents, that there be organized a stock corporation which could take title to the patents and in which the Institution should be indirectly represented by the secretary as an individual, and not in his capacity as secretary. The recommendation of the Regents being acceptable to Dr. Cottrell, the Research Corporation of New York was accordingly organized and incorporated by certificate executed February 16, 1912, filed in the office of the secretary of state of New York February 26, 1912, and in the office of the clerk of the county of New York February 27, 1912.

The objects of the Research Corporation are explained in the following circular:

RESEARCH CORPORATION.

The Research Corporation has recently been organized under the laws of the State of New York as a self-supporting means of furthering scientific and technical research. The corporation has two objects: First, to acquire inventions and patents and to make them more available in the arts and industries, while using them as a source of income; and, second, to apply all profits derived from such use to the advancement of technical and scientific investigation and experimentation through the agency of the Smithsonian Institution and such other scientific and educational institutions and societies as may be selected by the directors. For these purposes the corporation has been capitalized at \$20,000, divided into 200 shares, but the charter provides that no dividends shall be paid and that the entire net profits shall be devoted to research; all the stock being held under a stockholders' agreement, which recites that the corporation has been organized for the purpose of aiding and encouraging technical and scientific research, and not for personal or individual profit.

At the present time many discoveries are constantly being made, which undoubtedly possess a greater or less potential value, but which are literally being allowed to go to waste for lack of thorough development. This is due, in some cases, to the fact that the inventors are men in the service of the Government, or in the universities or technical schools, who are retarded either by official positions, lack of means, or reluctance to engage in commercial enterprises; and in other cases to the fact that a discovery made incidentally in the laboratory of a manufacturing corporation does not lend itself to the particular purpose of such corporation. True conservation demands that such by-products as these shall be developed and utilized to the fullest extent of which they are capable. The Research Corporation aims to supply this demand; and, through the cooperation of the Smithsonian Institution and the universities, to carry forward the work of investigation already begun by others upon lines which promise important results and to perfect such inventions as may prove to possess commercial value, thus bringing scientific institutions into closer relations with industrial activities and furthering the improvements of industrial processes.

The establishment of the Research Corporation has been rendered immediately possible by the acquisition, through the gift of Dr. F. G. Cottrell, of the United States Bureau of Mines, and his associates, of a valuable set of patents relating to the precipitation of dust, smoke, and chemical fumes by the use of electrical currents. These devices have already been tested and are in operation in several Western States, and are fully described in an article in "Industrial and Engineering Chemistry", for August, 1911. The ownership of these patents and the exclusive control of them, except in six Western States, at once assures a certain amount of business to the corporation, and it already has contracts for preliminary installations in the Garfield Smelter of the American Smelter & Refining Co., the New York Edison Co., and the Baltimore Copper Refinery. Numerous inquiries have been received from other important plants.

Besides the patents which have already been transferred to the corporation, a number of others in various fields of industry have been offered by officers of the Government and scientific institutions, as well as by manufacturing corporations holding patents not available for their own purposes. A similar offer has also come from Germany, through Mr. Erwin Moller, who has developed certain inventions in the same field as the Cottrell patents, and undoubtedly there are many others who will be glad to have their inventions utilized for the benefit of scientific research.

The management of the corporation is in the hands of a board of directors composed of business and professional men, many of whom have had experience in large industrial and mining enterprises. Among them are Dr. Charles D. Walcott, Secretary of the Smithsonian Institution; Charles Kirchhoff, recently president of the American Society of Mining Engineers; Arthur D. Little, president of the American Chemical Society; Hennen Jennings, of Washington; Gen. T. Coleman du Pont, of Wilmington; James J. Storrow, Charles A. Stone, and Prof. Elihu Thomson, of Boston; Frederick A. Goetze, dean of the faculty of applied science of Columbia University; Elon Huntington Hooker, president of the Development and Funding Co.; Thomas C. Meadows, vice president of the International Agricultural Corporation, and Benjamin B. Lawrence and John B. Pine, of New York. Lloyd N. Scott is the secretary and Linn Bradley the engineer of the corporation.

The Research Corporation invites correspondence with industrial concerns who are interested in perfecting their operations.

All communications should be addressed to "Research Corporation, No. 63 Wall Street, New York City."

The Cottrell patents cover processes used in the precipitation of solid particles from gases and smoke produced in smelters and cement plants. Considerable injury has been suffered by orchards and crops in the neighborhood of the great cement plants in California. The Cottrell processes have met with success in removing the particles of cement from the smoke and gases of such plants and particles of lead and other metals from the smoke of smelters, as well as the abatement of smoke nuisances in general. It is expected by Prof. Cottrell that there will be great economic advantage in saving the solids in the gases and smoke.

FINANCES.

The permanent fund of the Institution and the sources from which it was derived are as follows:

Deposited in the Treasury of the United States.

Bequest of Smithson, 1846.....	\$515, 169. 00
Residuary legacy of Smithson, 1867.....	26, 210. 63
Deposit from savings of income, 1867.....	108, 620. 37
Bequest of James Hamilton, 1875.....	\$1, 000. 00
Accumulated interest on Hamilton fund, 1895.....	1, 000. 00
	<hr/>
	2, 000. 00
Bequest of Simeon Habel, 1880.....	500. 00
Deposit from proceeds of sale of bonds, 1881.....	51, 500. 00
Gift of Thomas G. Hodgkins, 1891.....	200, 000. 00
Part of residuary legacy of Thomas G. Hodgkins, 1894.....	8, 000. 00
Deposit from savings of income, 1903.....	25, 000. 00
Residuary legacy of Thomas G. Hodgkins.....	7, 918. 69
	<hr/>
Total amount of fund in the United States Treasury.....	944, 918. 69
Registered and guaranteed bonds of the West Shore R. R. Co. (par value), part of legacy of Thomas G. Hodgkins.....	42, 000. 00
	<hr/>
Total permanent fund.....	986, 918. 69

In addition to the above there are four pieces of real estate bequeathed to the Institution by the late R. S. Avery, some of which yield a nominal rental, and all are free from taxation.

That part of the fund deposited in the Treasury of the United States bears interest at 6 per cent per annum, under the provisions of the act organizing the Institution and an act of Congress approved March 12, 1894. The rate of interest on the West Shore Railroad bonds is 4 per cent per annum.

The income of the Institution during the year, amounting to \$107,168.31, was derived as follows: Interest on the permanent foundation, \$58,375.12; contributions from various sources for specific purposes, \$21,150; and from other miscellaneous sources, \$27,643.19; all of which was deposited in the Treasury of the United States to the credit of the current account of the Institution.

With the balance of \$32,425.66 on July 1, 1911, the total resources for the fiscal year amounted to \$139,593.97. The disbursements, which are given in detail in the annual report of the executive committee, amounted to \$106,533.88, leaving a balance of \$33,060.09 on deposit June 30, 1912, in the United States Treasury.

The Institution was charged by Congress with the disbursement of the following appropriations for the year ending June 30, 1912:

International Exchanges.....	\$32,000
American Ethnology.....	42,000
Astrophysical Observatory.....	18,000
National Museum:	
Furniture and fixtures.....	175,000
Heating and lighting.....	50,000
Preservation of collections.....	300,000
Books.....	2,000
Postage.....	500
Building repairs.....	15,000
National Zoological Park.....	100,000
International Catalogue of Scientific Literature.....	7,500
Total.....	742,000

EXPLORATIONS AND RESEARCHES.

Scientific explorations and researches have been carried on during the past year at the expense of the Institution as far as its limited income and the generosity of its friends would permit. The National Museum has participated in some of these enterprises by furnishing equipment or supplies or by detailing members of its staff to conduct investigations or to make collections that are subsequently transferred to the Museum. Other researches made through the Astrophysical Observatory and the Bureau of American Ethnology are referred to elsewhere in this report. The resources of the Institution not being sufficient to enable it to plan extensive investiga-

tions in the field or to maintain a corps of collectors, it is compelled to concentrate its efforts on special work of limited scope, but of such a character that the results shall, as far as possible, have an immediate bearing on the progress of science. In recent years, as in the whole of its past history, the Institution has had the aid of public-spirited citizens and the cooperation of other institutions and of the several branches of the United States Government. It has, in turn, cooperated with other organizations in the explorations which they have conducted, being itself benefited thereby and benefiting those with which it has been associated.

In recent years opportunities have been afforded for participating in a number of exploring and hunting expeditions organized by private enterprise, whereby scientific collections of great importance have been obtained. These collections, with those from other sources, are preserved in the National Museum for exhibition to the public or for promoting scientific studies.

The field of these activities of the Institution has been world-wide, but attention has been recently concentrated on Africa and the Panama Canal Zone rather more than on other regions.

STUDIES IN CAMBRIAN GEOLOGY AND PALEONTOLOGY.

During the field season of the fiscal year 1911-12, or the spring and summer of 1912, I continued the collecting of Cambrian fossils from the famous fossil locality above Burgess Pass, north of Field, British Columbia, on the main line of the Canadian Pacific Railway, for the first two weeks of July and three weeks in September.

On the way to the Canadian Northwest I stopped off for a few days to examine the locality on Steep Rock Lake, 140 miles west of Port Arthur, where the oldest pre-Cambrian fossiliferous rocks occur. I had made a small collection, when, by the swamping of the canoe in which we were working in the rapids of the Seine River, a short distance from the lake, Dr. J. W. Truman, my guide and fellow geologist, of the Canadian Survey, was drowned, and the work thus most unfortunately brought to a close.

Outfitting at Fitzhugh, on the Grand Trunk Pacific Railway, I went with a well-equipped party over the Yellowhead Pass on the Continental Divide, leaving the line of the railway at Moose River, 17 miles west of the Pass. The Moose River was followed up to its head at Moose Pass, where we passed over into the drainage of the Smoky River, making several camps en route. The final camp was made at Robson Pass, between Berg and Adolphus Lakes. A reconnaissance of the geological section from Moose Pass to the summit of Mount Robson gave approximately 12,000 feet in thickness of the Cambrian formations and 3,000 feet of Lower Ordovician strata. Fossil beds were found at several localities in this section, and one

of them on the east side of Mural Glacier promises to give the finest specimens from the Lower Cambrian rocks of the western side of the continent.

Many photographs were taken both by myself and Mr. R. C. W. Lett, of the Grand Trunk Pacific Railway, who accompanied the party for two weeks.

The scenery about Mount Robson is probably the finest in the Canadian Rockies, as far as now known. The glaciers are on a grand scale, and the geology presents many large problems for solution. My object in visiting the Mount Robson region was to secure data for comparison of the section of Cambrian rocks there with that on the line of the Canadian Pacific Railway, 150 miles to the south.

RAINEY AFRICAN EXPEDITION.

The Smithsonian African expedition, under Col. Roosevelt, had scarcely returned from the field when the Institution received invitations to participate in two others, organized to explore the same general region.

The first was Mr. Paul J. Rainey's hunting trip to British East Africa and southern Abyssinia, where Mr. Rainey especially planned to hunt lions with a pack of American hounds. The natural-history collections that might be secured were offered to the Smithsonian Institution, provided an expert field naturalist be sent to accompany him and prepare such of the game collected as was desired for exhibition or scientific study. Mr. Edmund Heller, who had accompanied the Smithsonian African expedition in such a capacity, was selected and departed with Mr. Rainey in February, 1911. The collection made has been estimated to contain some 4,700 skins of mammals, together with many birds, reptiles, and other animals, making very valuable additions to the present African collection in the Museum. Nearly all of the material is from localities not covered by earlier expeditions, and some of it comes from points never before visited by naturalists. The collection includes the famous series of lions taken by Mr. Rainey with his American hounds, as described in his well-known lectures. There are also many specimens of different kinds of antelopes, including the hartebeests, wildebeestes, and waterbucks, as well as buffaloes, zebras, cheetahs, monkeys, and rodents. A few hippopotamus and rhinoceros skins and one elephant were also collected.

A large number of birds were secured, including some of the rarest species. Many are game birds, among them guinea fowls and francolins (which resemble our partridges), and plantain eaters, crows, bustards, vultures, vulturine guinea fowl, owls, hawks, kites, secretary birds, hornbills, pigeons, parrots, sun birds, flycatchers, etc., are represented. There are also four ostrich eggs.

The party remained in the field nearly a year, having sailed from New York for Mombasa on February 18, 1911, and dispersing about February 15, 1912, at Nairobi.

The territory traversed was mostly to the north and east of that covered by the Smithsonian expedition, and included the country lying between the northern part of British East Africa and southern Abyssinia.

FRICK AFRICAN EXPEDITION.

A further natural-history expedition to Africa was that of Mr. Childs Frick, of New York, whose object was to secure a collection of animals from the territory lying to the north of the regions visited by Col. Roosevelt and Mr. Rainey, covering at the same time certain parts of Abyssinia, northern British East Africa, and the country lying about Lake Rudolf. As naturalist of this party, Dr. Edgar A. Mearns, of the Smithsonian African expedition, was chosen. A portion of the collection of birds is to be donated to the Smithsonian Institution by Mr. Frick, and already several hundred specimens have been received.

BIOLOGICAL SURVEY OF THE PANAMA CANAL ZONE.

As mentioned in my last report, the Institution organized in 1910 a biological survey of the Panama Canal Zone, with the cooperation of the Departments of State, Agriculture, Commerce and Labor, and War. At first it was intended to confine the collections to the Canal Zone proper, but as the faunal and floral areas extended to the north and south of this region, it was decided to carry the work into the Republic of Panama, a step which met with the hearty approval of that Republic. The work accomplished has been very valuable to science, including collections and observations of vertebrate animals, land and fresh water mollusks, and plants, including flowering plants, grasses, and ferns.

During the past year the botanists have continued their studies, and collections have been made of fishes, reptiles, and amphibians, birds, and mammals, and special studies and collections have been made of the microscopic plant and animal life of the fresh waters of the zone.

As can readily be imagined, the life areas on the zone will become confused as soon as the canal is opened and the waters of the Pacific and Atlantic watersheds are intermingled. It is particularly important on that account that the present geographical distribution of animals and plants be recorded prior to that time, and this is especially true as regards the life of the fresh waters and the sea-coasts.

Pamphlets have been issued from time to time descriptive of some of the new or specially interesting forms of animals and plants collected by the survey, and as soon as the mass of material has been worked up it is proposed to publish general accounts of all the various collections, and also one or more volumes containing a summary of the whole fauna and flora of the Canal Zone.

As an indication of the biological value of the survey of the zone I may mention that of grasses alone about 150 species were collected, being four to five times as many as were previously known from that region. In the collections of birds and mammals there are likewise many forms new to science.

SIBERIAN EXPEDITION.

Through the liberality of a friend, Mr. Theodore Lyman, of Cambridge, Mass., the Institution has been enabled to participate in a zoological expedition to the Altai Mountain region of the Siberia-Mongolian border, Central Asia, an exceedingly interesting territory, from which the National Museum at present has no collections. A Museum naturalist was detailed to accompany him, the expenses of the expedition being borne by Mr. Lyman, and the natural-history collections obtained to be deposited in the National Museum. Although this expedition had not completed its work at the close of the fiscal year, yet I may here anticipate some of its results by stating that the Museum will probably be enriched by a large number of interesting specimens of birds and mammals.

The scene of the survey and exploration, the Altai Mountain region, is a particularly wild country and quite unsettled, although it is well stocked with game. These mountains are inhabited by the largest of the wild sheep, which, with the ibex, will form the principal big game animals sought by the party, but a general collection of smaller mammals and of birds will also be made.

BORNEO EXPEDITION.

For more than 10 years past Dr. W. L. Abbott, of Philadelphia, has been exploring the Malay Archipelago and has given all his natural-history and ethnological collections to the Smithsonian Institution for the United States National Museum. These collections, so far as the vertebrates are concerned, are the most important ever received by the Museum from any one person. Through illness, Dr. Abbott has been obliged to abandon his exploration, but his interest in the Institution has not abated. He has engaged the services of a collector and placed at the disposal of the Institution funds for continuing the explorations he had begun in Borneo.

The field work will be carried on in eastern Dutch Borneo, the natural history of which is practically unknown. Nothing relating

to it has been published, and there are no collections from this region in the United States, although the National Museum has some from the west and south coasts of Borneo. The Institution is fortunate in having this opportunity to study a country practically unknown to zoologists. It is hoped to secure a quantity of interesting material, including the characteristic mammals of the country, such as oranges, deer, wild pigs, squirrels and smaller rodents, and possibly specimens of the rhinoceros and tapir.

BIOLOGICAL SURVEY IN THE CANADIAN ROCKIES.

Through the courtesy of the Canadian Government and of Dr. A. O. Wheeler, president of the Alpine Club of Canada, the Smithsonian Institution was enabled, in the summer of 1911, to send a small party of naturalists to accompany Dr. Wheeler on his topographical survey of the British Columbia and Alberta boundary line and the Mount Robson region. The party started in June and returned in October, 1911. The expedition was very successful in obtaining a collection covering practically all the birds and mammals inhabiting this previously unworked territory, together with many insects and botanical specimens. The land surveyed included the territory lying about this mountain in the heart of the Canadian Rockies, comprising the most rugged and broken country imaginable. Amid this wonderful scenery Mount Robson rises in titanic outline, the highest peak in Canada, probably between 14,500 and 15,000 feet high, and surrounding it for a distance of 50 miles in all directions lies the field of the survey. In this wild and unclaimed country the party of naturalists remained nearly four months, protected by special permits from the Canadian Government. The collection includes some 900 specimens of birds and mammals, the latter being of all kinds from tiny shrews to caribou and bears. One enormous grizzly bear was obtained by a fortunate shot. Much fine material for exhibition groups was secured, including a series of caribou, mountain goats, mountain sheep, beavers, and many varieties of smaller animals.

ANTHROPOLOGICAL RESEARCHES IN SIBERIA AND MONGOLIA.

Toward the close of the fiscal year arrangements were made, in connection with the authorities of the Panama-California Exposition of San Diego, to carry on, by or under the direction of Dr. Hrdlička, certain researches in anthropology, among others, those bearing on the origin of the American Indians. In accordance with these plans Dr. Hrdlička left for eastern Asia to search for and, if found, to trace, at least in a preliminary way, any possible remnants

of the stock of people from which, probably in the distant past, the rudiments of the American race branched off. This work touches what is rapidly becoming the most important subject of research in American anthropology. The first part of Dr. Hrdlička's visit was to be devoted to the Yenisei region, in which, judging from the reports of Russian observers, there exist remnants of very imperfectly known tribes, whose physical type apparently bears a close resemblance to that of the American Indian. From the Yenisei his intention is to pass through the Irkutsk Oblast and reach outer Mongolia, and then possibly Turkestan or China. Due to the immensity of the territory and the limited time now at the disposal of Dr. Hrdlička, it is expected that the present journey will have to be largely of the nature of anthropological reconnoissance and preparatory for future investigations.

ANTIQUITY OF MAN IN EUROPE.

A grant was made to enable Dr. Hrdlička to make personal studies of the originals of all the well-authenticated skeletal remains of geologically ancient man of Europe. The recent discoveries in this line have been of such an importance that a direct investigation into the subject by an experienced anthropologist was very desirable. The results of Dr. Hrdlička's studies will be prepared for publication.

RESEARCHES UNDER THE HODGKINS FUND.

A limited grant has been made from the Hodgkins fund to enable Mr. Anders Knutson Ångström to make certain observations on nocturnal radiation from the earth at Bassour, Algeria, in connection with observations to determine the variability of the sun, which have been in progress there under Mr. Abbot, of the Smithsonian Astrophysical Observatory. The results of Mr. Ångström's researches are awaited with interest.

As mentioned in my last report, the Institution has arranged for the distribution to various parts of the world of standard silver disk pyrheliometers designed by Mr. Abbot, of the Astrophysical Observatory, with a view of securing accurate data and more exact knowledge of solar radiation and the influence of the terrestrial atmosphere upon it.

A portion of the income of the fund is devoted to the increase and diffusion of knowledge in regard to the nature and properties of atmospheric air in connection with the welfare of man. There was published a few years ago a number of papers on "Expired air," "Organic matter in air," "The air of towns," and other phases of this

general subject. There is now in preparation by Dr. Leonard Hill, associated with Dr. Martin Flack and other investigators of the London Hospital Medical College, a paper discussing the results of experiments to determine the influence of the atmosphere upon our health and comfort in confined and crowded places.

SMITHSONIAN TABLE AT NAPLES ZOOLOGICAL STATION.

For the past 19 years the Smithsonian Institution has maintained a table for the use of American biologists at the Naples Zoological Station. This table affords exceptional opportunities for the study of marine life, and it is believed that through its use the cause of biological science has been much advanced.

The appointment of Dr. Sergius Morgulis, a Parker Traveling Fellow from Harvard, which was approved for the months of May, June, and July, was continued until July 22, 1911.

Dr. Ch. Zeleny, of the University of Illinois, who was appointed for one month, including part of June and July, continued his occupancy until July 26, 1911. At the close of the fiscal year no report had been received from Dr. Zeleny in regard to the work accomplished.

Dr. Fernandus Payne, assistant professor of zoology at the Indiana University, carried on researches at Naples during the months of April, May, and June, 1912. His studies included: (a) Selective fertilization, (b) Cleavage factors, and (c) Some pressure experiments. In a brief report on his work, Dr. Payne states that he has (1) completed a paper on "The Chromosomes of *Grylloptalpa borealis*," (2) collected a large amount of material on *Gryllotalpa vulgaris*, and expects to study the question of synapsis, ring formation, chondriosomes, and the sex chromosomes in this form.

When the same period is selected by more than one student the earliest application is considered first, the approval of the later ones becoming necessarily dependent on the ability of the station to provide for more than one Smithsonian appointee at the same time. It should be added that the obliging courtesy shown in this connection to appointees of the Smithsonian Institution by the director of the station often permits appointments to the seat which would otherwise be impracticable.

The prompt and efficient aid of the advisory committee in examining and reporting on applications for the table is, as it has always been, of great service to the Institution and is very gratefully appreciated.

The Institution has renewed the lease of the table for another period of three years.

PUBLICATIONS.

One of the chief agencies of the Institution in promoting "the diffusion of knowledge among men" is the publication and distribution throughout the world of the series of "Smithsonian Contributions to Knowledge," the "Smithsonian Miscellaneous Collections," and the Smithsonian Annual Report. These three series constitute the publications of the Institution proper and, with the exception of the annual report, are printed entirely at the expense of Smithsonian funds. Other publications issued under the direction of the Institution, but at the expense of the Government, include the Proceedings, Bulletin, and Annual Report of the United States National Museum; the Bulletin and Annual Report of the Bureau of American Ethnology; and the Annals of the Astrophysical Observatory.

The "Smithsonian Contributions to Knowledge" is a quarto series begun in 1848, which now comprises 35 volumes of about 600 pages each, including, up to the present time, 148 memoirs. The chief characteristic of these memoirs is that they are discussions of extensive original investigations, constituting important additions to knowledge.

The "Smithsonian Miscellaneous Collections" is an octavo series containing papers of varying length, from two or three pages to an entire volume, being special reports on particular subjects of biological or physical research, classified tabular compilations, tables of natural constants, bibliographies, and other miscellaneous information of value to the scientific worker or student. This series was begun in 1862 and now numbers 60 volumes of about 800 pages each, with an aggregate of several thousand articles.

Limited editions of each memoir in the "Contributions" and of articles in the "Collections" are distributed to specialists in the subjects treated, but the principal distribution of these series during the last 60 years has been to about 1,100 large libraries and institutions of learning in the United States and throughout the world.

The Annual Report of the Board of Regents, known as the Smithsonian Report, is printed under congressional appropriation and in much larger editions than the other series. It is in great measure a popular work, containing, besides the official report on the business operations of the Institution, a general appendix made up of 30 or more original or selected articles bearing on particular advances in human knowledge and discoveries and showing the progress of science in all its branches. It is a publication much sought after.

Smithsonian Contributions to Knowledge.—The Langley Memoir on Mechanical Flight, which had been in preparation for several years, was completed and published in August, 1911. It is a work of 330 pages of text and 101 plates of illustrations. It is the third memoir in volume 27 of the "Contributions," following Secretary

Langley's "Experiments in Aerodynamics," and "The Internal Work of the Wind," published in 1891 and 1893, respectively. The present memoir was in preparation at the time of Mr. Langley's death in 1906, and the part recording experiments from 1887 to 1896 was written by him. The chapters discussing experiments from 1897 to 1903 were written by Mr. Charles M. Manly, who became chief assistant to Mr. Langley in 1898.

In the preface to the Memoir, Mr. Manly says:

The present volume on Mechanical Flight consists, as the title-page indicates, of two parts. The first, dealing with the long and notable series of early experiments with small models, was written almost entirely by Secretary Langley, with the assistance of Mr. E. C. Huffaker and Mr. G. L. Fowler, in 1897. Such chapters as were not complete have been finished by the writer and are easily noted, as they are written in the third person. It has been subjected only to such revision as it would have received had Mr. Langley lived to supervise this publication, and has therefore the highest value as an historical record. The composition of the second part, dealing with the later experiments with the original and also new models and the construction of the larger aerodrome, has necessarily devolved upon me. This is in entire accordance with the plan formed by Mr. Langley when I began to work with him in 1898, but it is to me a matter of sincere regret that the manuscript in its final form has not had the advantage of his criticism and suggestions. If the reader should feel that any of the descriptions or statements in this part of the volume leave something to be desired in fullness of detail, it is hoped that some allowance may be made for the fact that it has been written in the scanty and scattered moments that could be snatched from work in other lines which made heavy demands upon the writer's time and strength. It is believed, however, that sufficient data are given to enable any competent engineer to understand thoroughly even the most complicated phases of the work.

Persons who care only for the accomplished fact may be inclined to underrate the interest and value of this record. But even they may be reminded that but for such patient and unremitting devotion as is here enregistered the now accomplished fact of mechanical flight would still remain the wild unrealized dream which it was for so many centuries.

To such men as Mr. Langley an unsuccessful experiment is not a failure, but a means of instruction, a necessary and often an invaluable stepping stone to the desired end. The trials of the large aerodrome in the autumn of 1903, to which the curiosity of the public and the sensationalism of the newspapers gave a character of finality never desired by Mr. Langley, were to him merely members of a long series of experiments, as much so as any trial of one of the small aerodromes or even of one of the earliest rubber-driven models. Had his health and strength been spared, he would have gone on with his experiments undiscouraged by these accidents in launching and undeterred by criticism and misunderstanding.

Moreover, it is to be borne in mind that Mr. Langley's contribution to the solution of the problem is not to be measured solely by what he himself accomplished, important as that is. He began his investigations at a time when not only the general public but even the most progressive men of science thought of mechanical flight only as a subject for ridicule, and both by his epoch-making investigations in aerodynamics and by his devotion to the subject of flight itself he helped to transform into a field of scientific inquiry what had before been almost entirely in the possession of visionaries.

The original plans for this publication provided for a third part, covering the experimental data obtained in tests of curved surfaces and propellers. Owing to the pressure of other matters on the writer, the preparation of this third part is not yet complete and is reserved for later publication.

Smithsonian Miscellaneous Collections.—In this series there were published during the past year 35 papers forming parts of three volumes and covering a wide range of topics. I may mention the Hamilton lecture by Dr. Simon Flexner on "Infection and Recovery from Infection," three papers by your secretary on Cambrian Geology and Paleontology, several papers descriptive of new genera and species of birds, mammals, and other animals and plants from Smithsonian expeditions in the Panama Canal Zone, Africa, and Canada, as enumerated in the editor's report on another page, and an interesting paper on "The Natives of the Kharga Oasis, Egypt," by Dr. Hrdlička, who discusses the physical measurements and other observations made by him on these people dwelling in an oasis 130 miles west of Luxor, the ancient Thebes. Dr. Hrdlička says:

The type of the Kharga natives is radically distinct from that of the negro. It is, according to all indications, fundamentally the same as that of the non-negroid Valley Egyptians. It is in all probability a composite of closely related northeastern African and southwestern Asiatic, or "hamitic" and "semitic" ethnic elements, and is to be classed with these as part of the southern extension of the Mediterranean subdivision of the white race.

Judging from the mummies of the Oasis inhabitants from the second to fifth centuries A. D., exhumed at El Baguat, the type of the present nonnegroid Kharga natives is substantially the same as that of the population of the Oasis during the first part of the Christian era. The nature of the population of the Oasis in more ancient times can only be determined by skeletal material from the ancient cemeteries.

Smithsonian report.—The annual report for 1910, issued during the past year, contained in the general appendix 34 interesting papers of the usual high character, and of many of them it was necessary to publish extra editions to meet the public demand. The report for 1911 was all in type before the year closed, but unavoidable delays prevented its publication.

Zoological nomenclature.—In continuation of the series of Opinions Rendered by the International Commission on Zoological Nomenclature, there were published two pamphlets containing Opinions 30 to 37 and 38 to 51. The Institution cooperates with this commission by providing clerical assistance for its secretary in Washington and in the publication of its Opinions. In connection with the summary of each opinion there is printed a statement of the case and the discussion thereon by members of the commission. The rules to be followed in submitting cases for opinion¹ as laid down by the commission are as follows:

¹ Cases should be forwarded to the secretary of the commission, Dr. Ch. Wardell Stiles, U. S. Hygienic Laboratory, Washington, D. C.

1. The commission does not undertake to act as a bibliographic or nomenclatural bureau, but rather as an adviser in connection with the more difficult and disputed cases of nomenclature.

2. All cases submitted should be accompanied by (a) a concise statement of the point at issue, (b) the full arguments on both sides in case a disputed point is involved, and (c) complete and exact bibliographic references to every book or article bearing on the point at issue.

The more complete the data when the case is submitted the more promptly can it be acted upon.

3. Of necessity, cases submitted with incomplete bibliographic references can not be studied and must be returned by the commission to the sender.

4. Cases upon which an opinion is desired may be sent to any member of the commission, but—

5. In order that the work of the commission may be confined as much as possible to the more difficult and the disputed cases, it is urged that zoologists study the code and settle for themselves as many cases as possible.

Museum publications.—There were published during the year the annual report of the assistant secretary in charge of the National Museum for 1911, 50 miscellaneous papers of the Proceedings, 3 Bulletins, and 5 parts of Contributions from the National Herbarium.

Ethnological publications.—The Bureau of American Ethnology published the Twenty-seventh Annual Report, containing a paper on "The Omaha Tribe," and Bulletin 47 on the Biloxi and Ofo languages.

Reports of historical and patriotic societies.—In accordance with the national charters of the American Historical Association and the National Society of the Daughters of the American Revolution, annual reports of those organizations were submitted to the Institution and communicated to Congress.

Committee on printing and publication.—The advisory committee on printing and publication under the Smithsonian Institution has continued to examine manuscripts proposed for publication by the branches of the Institution and has considered various questions concerning public printing and binding. Twenty-one meetings of the committee were held during the year and 156 manuscripts were passed upon. The personnel of the committee is as follows: Dr. Frederick W. True, Assistant Secretary of the Smithsonian Institution, chairman; Mr. C. G. Abbot, Director of the Astrophysical Observatory; Mr. W. I. Adams, disbursing officer of the Smithsonian Institution; Dr. Frank Baker, superintendent of the National Zoological Park; Mr. A. Howard Clark, editor of the Smithsonian Institution; Mr. F. W. Hodge, ethnologist in charge of the Bureau of American Ethnology; Dr. George P. Merrill, head curator of geology, United States National Museum; and Dr. Leonhard Stejneger, head curator of biology, United States National Museum.

Allotments for printing.—The allotments to the Institution and its branches, under the head of "Public printing and binding," during the past fiscal year, aggregating \$72,900, were, as far as practicable,

expended prior to June 30. The allotments for the year ending June 30, 1913, aggregating \$74,900, are as follows:

For the Smithsonian Institution, for printing and binding annual reports of the Board of Regents, with general appendixes.....	\$10,000
For the annual reports of the National Museum, with general appendixes, and for printing labels and blanks, and for the bulletins and proceedings of the National Museum, the editions of which shall not exceed 4,000 copies, and binding, in half turkey or material not more expensive, scientific books and pamphlets presented to or acquired by the National Museum library.....	34,000
For the annual reports and bulletins of the Bureau of American Ethnology, and for miscellaneous printing and binding for the bureau---	21,000
For miscellaneous printing and binding:	
International Exchanges	200
International Catalogue of Scientific Literature.....	100
National Zoological Park.....	200
For miscellaneous printing and binding for the Astrophysical Observatory, \$400, and for 1,500 copies of volume 3 of the Annals of the Astrophysical Observatory, \$2,000.....	2,400
For the annual report of the American Historical Association.....	7,000
Total	74,900

Distribution of publications.—There was under discussion before committees of Congress at the close of the fiscal year, and later enacted into law, certain proposed measures which particularly affect the practice of the Institution and its branches in the distribution of publications. As finally passed by Congress the law requires that all Government publications must be mailed from the Government Printing Office, mailing lists or labels being forwarded to the Superintendent of Documents for that purpose.

At the Regents' meeting in February last, the secretary called the attention of the board to the proposed legislation and stated that the publications of the Institution are not an incidental result of its work but something planned for and systematically executed. The Institution keeps in touch with all the principal scientific and art establishments of the world, and with experts in science and art who are promoting work in a line with its own, or who are in positions to help in securing collections, information, or advice. The actual labor of wrapping, labeling, and handling the Smithsonian report had been furnished by the Institution and not by the Government, and it was feared that the transfer of the actual work of distribution of the publications of the Institution and its branches to another establishment would distinctly tend to defeat the well-considered plans under which it has been conducted heretofore.

The law as enacted requires the transfer to the Public Printer by October 1 of all publications on hand, and that distribution shall thereafter be made from his office. This measure does not, however, apply to the two series of publications published at the private

expense of the Institution. The question in the main seems to be one affecting the promptness of distribution, which is of primary importance in the case of scientific works, and it is hoped no serious disadvantages may result by the adoption of the new law.

LIBRARY.

The library of the Smithsonian Institution is made up of several constituent parts. The most important of these are the Smithsonian deposit in the Library of Congress and the libraries of the National Museum and Bureau of American Ethnology. There was added to the Smithsonian deposit during the past year a total of 21,863 publications, the equivalent of 14,560 volumes, consisting very largely of works on the various branches of science and art.

To the Museum library there were added 1,791 books, 3,608 pamphlets, and 276 parts of volumes, making the present total in that library about 42,000 volumes, 70,000 unbound papers, besides manuscripts, maps, charts, and other material. Arrangements are being made to divide the Museum library into two principal parts by assembling all books on zoology, paleontology, geology, ethnology, and archeology in the new building.

LANGLEY MEMORIAL TABLET.

A design in plaster for the memorial tablet commemorative of the aeronautical work of the late Secretary Langley was submitted at the December meeting of the Regents by the sculptor, Mr. John Flanagan, and accepted by the committee appointed by the board. The tablet will be cast in bronze and erected in the vestibule of the Smithsonian building. The tablet, which is in relief, measures 4 feet 6 inches high by 2 feet 5 inches wide. It represents Mr. Langley seated on a terrace where he has a clear view of the heavens, and in a meditative mood is observing the flight of birds, while in his mind he sees his aerodrome soaring above them.

The lettering upon the tablet is as follows:

SAMUEL PIERPONT LANGLEY
1834-1906
Secretary of the Smithsonian Institution
1887-1906

Discovered the relations of speed and angle of inclination to the lifting power
of surfaces moving in air

“I have brought to a close the portion of the work which seemed to be specially mine, the demonstration of the practicability of mechanical flight.

“The great universal highway overhead is now soon to be opened.”—LANGLEY, 1901.

HAMILTON LECTURE.

The third Hamilton fund lecture of the Smithsonian Institution was delivered by Dr. Simon Flexner, of the Rockefeller Institute for Medical Research, in the auditorium of the United States National Museum, February 8, 1912.

The title of the lecture was "Infection and Recovery from Infection," an investigation to which Dr. Flexner has given especial study for several years.

In his treatment of this vital and interesting subject the speaker covered a broad field of medical science, and at the same time expressed himself in such a manner as to be intelligible to laymen. Dr. Flexner touched upon the following points:

The part played by bacteria, protozoa, and submicroscopic parasites in causing infection was described, and emphasis laid upon the occurrence on the surface of the body of many kinds of disease-producing germs. The manner in which they are excluded by skin and mucous membranes was discussed, as well as their ability to enter the body by these channels when they were imperfect. In this way a variety of diseases is produced, including diphtheria, meningitis, and probably infantile paralysis. The germs that enter the body encounter a second and even more efficient set of defenses in the blood with its devouring white corpuscles. When disease appears, in spite of and because of inadequacy in the defensive mechanisms, then the body, under the influence of the parasitic germs, sets about creating new defensive principles through the process of immunization. It is immunization that vaccination produces, which is a protection to smallpox; and it is through purposive immunization of animals that the curative serums are prepared, that by injection bringing about an artificial and premature cessation of such diseases as diphtheria and epidemic meningitis. The part played by insects in transmitting malaria, yellow fever, typhus fever, and relapsing fever was sketched, and the varying susceptibilities to disease of different races, species, and individuals dwelt on and in part explained, on the basis of known facts of immunity to and virulence of the germ causes of disease.

The above is the third of the series of Hamilton lectures. In 1871 James Hamilton, a retired lawyer of Carlisle, Pennsylvania, bequeathed \$1,000 to the Smithsonian Institution, the interest of which was to be appropriated biennially by the secretary for some contribution, paper, or lecture on any scientific or useful subject which he might select. As the sum was somewhat limited to adequately carry out the donor's wishes, the interest was allowed to accumulate until the amount was doubled, and the Institution then created a series of lectures, known as the Hamilton Fund Lectures.

The first, by Dr. Andrew D. White, on "The diplomatic service of the United States, with some hints toward its reform," was given in 1905, and the second, by Dr. George E. Hale, on "Some recent contributions to our knowledge of the Sun," was delivered in 1908.

INTERNATIONAL CONGRESSES AND CELEBRATIONS.

The Institution each year receives invitations to numerous scientific congresses and celebrations in the United States and abroad, but as funds are not available for the expenses of delegates few of these invitations can be accepted. In some instances, however, it is possible to arrange for representation by collaborators of the Institution who are visiting the localities on official or private business.

Congress of Americanists.—Dr. Aleš Hrdlička was appointed representative of the Institution and designated as delegate of the United States to the Eighteenth International Congress of Americanists held in London May 27 to June 1, 1912. In addition to Dr. Hrdlička, the State Department also designated Miss Alice Fletcher, Dr. George Grant MacCurdy, Dr. Edgar L. Hewett, Dr. G. B. Gordon, Rev. Charles W. Currier, Prof. Marshall H. Saville, and Dr. Charles Peabody as delegates on the part of the United States at that congress.

The Nineteenth International Congress of Americanists has been invited to meet in Washington in 1914, and Mr. W. H. Holmes, Mr. F. W. Hodge, and Dr. Aleš Hrdlička have been appointed an auxiliary committee to represent the Smithsonian Institution in connection with the preliminary arrangement of details respecting the proposed meeting.

Academy of Natural Sciences of Philadelphia.—The Academy of Natural Sciences of Philadelphia held its centenary anniversary in Philadelphia, March 19, 20, and 21, 1912. At this celebration the Institution and its branches were represented by the secretary, Dr. Charles D. Walcott; Dr. Richard Rathbun, assistant secretary in charge of the United States National Museum; Dr. Frederick W. True, assistant secretary in charge of Library and Exchanges; Mr. Frederick W. Hodge, ethnologist in charge, Bureau of American Ethnology; and Dr. Leonhard Stejneger, head curator of biology, United States National Museum; and Dr. Theodore N. Gill, associate in Zoology, United States National Museum. The secretary also represented the American Philosophical Society on this occasion.

Archeological Congress.—At the request of the Institution, the State Department designated Prof. Arthur L. Frothingham and Prof. George M. Whicher as delegates on the part of the United States to the Third International Archeological Congress at Rome, October 9 to 16, 1912.

Prehistoric Anthropology.—Dr. Alěs Hrdlička, Dr. Charles Peabody, and Dr. George Grant MacCurdy were appointed representatives of the Smithsonian Institution to the Fourteenth International Congress of Prehistoric Anthropology and Archeology at Geneva, September 9 to 15, 1912.

Congress of Orientalists.—Dr. Paul Haupt was appointed representative of the Smithsonian Institution and designated as delegate of the United States at the Fifteenth International Congress of Orientalists, held at Athens, April 7 to 14, 1912. Additional delegates on the part of the United States were Prof. E. Washburn Hopkins, Prof. A. V. W. Jackson, and Prof. Morris Jastrow, jr. (Unforeseen circumstances later prevented Prof. Jackson from attending.)

Congress on Hygiene and Demography.—The Fifteenth International Congress on Hygiene and Demography was invited by the Government, through the State Department, to meet in Washington, September 23 to 28, 1912. I accepted the invitation of the department to serve as a member of the committee on organization. Mr. W. H. Holmes, head curator of anthropology in the National Museum, has been appointed as representative of the Smithsonian Institution on the interdepartmental committee to consider the preparation of exhibits for the congress. At the close of the fiscal year, June 30, 1912, arrangements for the congress were well in hand.

Congress on Applied Chemistry.—In connection with the Eighth International Congress of Applied Chemistry, to be opened in Washington September 4, 1912, and subsequent meetings closing in New York City September 13, Prof. F. W. Clarke has been designated as representative of the Institution, and I have accepted an invitation to attend personally.

Royal Society.—Dr. Arnold Hague, of the United States Geological Survey, was appointed a representative of the Smithsonian Institution at the commemoration of the two hundred and fiftieth anniversary of the foundation of the Royal Society of London, July 16 to 18, 1912.

GEORGE WASHINGTON MEMORIAL BUILDING.

There is now pending in the House of Representatives a bill passed by the Senate, April 15, 1912, granting to the George Washington Memorial Association permission to erect on the Government reservation known as Armory Square, a memorial building to cost not less than \$2,000,000, "where large conventions or in which large public functions can be held, or where the permanent headquarters and records of national organizations can be administered." By the provisions of the bill the control and administration of the building would be vested in the Board of Regents of the Smithsonian Institution, and the association is to provide "a permanent endowment

fund of not less than \$500,000, to be administered by the Board of Regents of the Smithsonian Institution, the income from which shall, as far as necessary, be used for the maintenance of said building."

There is need in Washington of such a structure as here proposed. It would be a fitting memorial to George Washington—the gathering-place and headquarters for patriotic, scientific, medical, and other organizations interested in promoting the welfare of the American people, the development of the country in science, literature, and art.

NATIONAL MUSEUM.

The past year was marked by a new feature in the administration of the National Museum—its opening to the public on Sundays. This measure had long been advocated without effect, and even now the practice must be for a time limited to the new building. Public appreciation was evidenced on the first day of Sunday opening, October 8, 1911, by the presence of 15,467 visitors. The average number of visitors on Sundays up to the close of the year was 1,666, as compared with 693 on week days.

There was added to the permanent collections of the Museum a total of 238,000 specimens and objects, an increase of 10,000 over the year preceding. Of these accessions about 168,000 were biological, 63,000 geological and paleontological, and 7,000 anthropological. A large number of valuable temporary additions in the form of loans were made to the National Gallery of Art, to the collection of art textiles, and to those of the division of history. Among the accessions that I may specially mention are the first aeroplane (Wright) acquired by the Government; important memorials of Gens. Gansevoort and Custer, Rear Admirals Foote and Schley, Commanders Maury and Hosley, and other eminent soldiers and sailors, and mementos of the Washington, Ball, Cropper, McLane, Bradford, and Bailey-Myers-Mason families; some interesting Polish coins dating from 1386 to 1835; and a very large and unique series of postage stamps and other objects relating to the operation of the United States Postal Service. There were also received about 4,000 mammals, besides birds, reptiles, fishes, and invertebrates from the Paul J. Rainey expedition to British East Africa; a large collection of Cambrian fossils; and an unrivaled collection of some 75,000 specimens of fossil echnioderms deposited by Mr. Frank Springer. From the Bureau of Fisheries were received extensive and important collections of fishes from Japan and the Philippines and over 27,000 specimens of marine invertebrates. Other additions of importance are noted by the assistant secretary in his report on another page.

About three-fourths of the exhibition space in the new building has already been made accessible to the public, and before the close

of another year it is expected that the last of the halls will be opened. The installations, however, are to a large extent provisional and much work will still remain to be done to complete their permanent arrangement.

By the transfer of the natural history and anthropological exhibits to the new building, space has become available in the older buildings for the better exhibition of the large collections of the department of arts and industries. The very interesting series of objects commemorative of eminent Americans and of important events in the history of the United States; the collections illustrative of art textiles, graphic arts, and ceramics, as well as firearms, electrical inventions, and other technological material may now receive more attention and be more adequately displayed than has heretofore been practicable.

The picture gallery in the new building, constituting the National Gallery of Art, continues to grow in public interest and importance. A special exhibition of part of the collection of American and oriental art presented to the Nation by Mr. Charles L. Freer was held from April 15 to June 15. The objects displayed included 38 paintings by Whistler, Tryon, and others, 13 Japanese paintings, 36 Chinese paintings, a number of Chinese bronzes, one dating back to 1766-1122 B. C., and examples of Chinese, Persian, and Mesopotamian pottery, ancient Egyptian glass, and Persian and Indo-Persian illuminations. Mr. William T. Evans, of New York, has made 10 important additions to his collection of works of contemporary American painters, now numbering 137 pieces by 98 artists.

A meeting in memory of Mr. Francis D. Millet, lost in the *Titanic* disaster, was held in the auditorium of the new building on the evening of May 10, 1912, under the auspices of The American Federation of Arts, when addresses were made by Senators Root and Lodge, and others. On this occasion I called attention to the valuable services rendered to the Smithsonian Institution by Mr. Millet as chairman of the advisory committee of the National Gallery of Art.

Meetings of a number of scientific organizations were held as usual in the auditorium, including the usual annual April meeting of the National Academy of Sciences, the annual meeting of the American Association for the Advancement of Science, the American Institute of Architects, and the Red Cross conference.

On March 28 and 29 the Washington Academy of Sciences held a conversazione and an exhibition of important recent apparatus, methods, and results pertaining to the scientific investigations carried on by the different Government bureaus and scientific institutions of Washington.

Models and pictures of designs for the memorials to Abraham Lincoln and Commodore Perry were exhibited in several rooms of the new building and attracted much public attention.

The publications issued included the annual report for 1911, numerous papers of the Proceedings, and several Bulletins, which will be enumerated in detail in the usual volume devoted to the operations of the National Museum.

BUREAU OF AMERICAN ETHNOLOGY.

The operations of the Bureau of American Ethnology during the last year are stated in detail on another page by the ethnologist-in-charge of that branch of the Institution's activities. The systematic researches bearing on the history, languages, manners, and customs of the American Indians cover a wide range, and the results of these studies are published as soon as completed. Since the organization of the bureau under the Smithsonian Institution in 1879, 27 annual reports in 32 royal octavo volumes have been issued, and more than 50 bulletins, the collection comprising a most valuable ethnological library. The demand for the "Handbook of American Indians," which is printed in two volumes, has so far exceeded the authorized edition that a measure has been introduced and is now pending in Congress for reprinting it.

The recent field work of the bureau includes:

(1) A visit to El Morro, New Mexico, where impressions of some Spanish inscriptions dating from the year 1606 and having an important bearing on the early history of the Pueblo tribes, were made; (2) excavations in the Jemez Valley in a ruined pueblo on a mesa 1,800 feet high, the ruins bearing evidence of occupancy at two different periods, and containing some interesting pottery, traces of textiles, and other objects; (3) field work to determine the western limit of the ancient Pueblo culture in Arizona; and many other lines of investigation, discussed by Mr. Hodge in an appendix to this report.

The construction of the Panama Canal has aroused so greatly public interest in the aboriginal remains of the West Indies that the bureau has arranged for more extended studies in West Indian archeology. Researches thus far made indicate that the Tainan culture of Porto Rico and the Dominican Republic was represented in the Lesser Antilles by an agricultural people, probably Arawak, who were conquered and absorbed by the marauding Carib. Types of pottery found in some of the Lesser Antilles indicate their occupancy by people superior in culture to the Carib and to those found there at the time of the discovery by Columbus.

INTERNATIONAL EXCHANGES.

There has been an increase of more than 10 per cent in the number of packages handled by the Exchange Service during the past year as compared with the preceding 12 months, the total number being 315,492. These packages weighed over 284 tons.

No change has been made in the amount (\$32,200) granted by Congress during the past four years for the support of this branch of Government work carried on under the direction of the Institution, and the usual sum was collected from various Government and State establishments for services in connection with the transportation of exchanges, the total available resources for meeting the expenses of the system being \$36,591.02.

The publications dispatched by the Exchange Service are classified under four heads: First, the Congressional Record; second, "Parliamentary documents"; third, "Departmental documents"; fourth, "Miscellaneous scientific and literary publications."

The term "Parliamentary documents" as here used refers to publications set aside by law for exchange with foreign Governments, and includes not only copies of documents printed by order of either House of Congress, but copies of each publication issued by any department, bureau, commission, or officer of the Government. The object in sending these publications abroad is to procure for the use of the Congress of the United States a complete series of the publications of other Governments, and the returns are deposited in the Congressional Library.

The term "Departmental documents" embraces all the publications delivered at the Institution by the various Government departments, bureaus, or commissions for distribution to their correspondents abroad, from whom they desire to obtain similar publications in exchange. The publications received in return are deposited in the various departmental libraries.

The "Miscellaneous scientific and literary publications" are received chiefly from learned societies, universities, colleges, scientific institutes, and museums in the United States and transmitted to similar institutions in all parts of the world.

At the request of the Secretary for the Interior of the Union of South Africa the Institution discontinued the sending of full sets of governmental documents to Cape Colony and the Transvaal and partial sets to Natal and the Orange River Colony, substituting one full set for the Government of the Union of South Africa. There are therefore now sent through the Exchange Service to regular foreign depositories only 54 full and 32 partial sets of official documents.

No countries were added during the year to the list of those with which the immediate exchange of official parliamentary journals is carried on, the number of countries taking part in this exchange being 29.

NATIONAL ZOOLOGICAL PARK.

The accessions to the collections in the National Zoological Park during the past year aggregated 510 animals, including 25 species not already represented; 350 of these were obtained by purchase, exchange, or as gifts, and 108 were born and hatched in the park. The total collection on June 30 numbered 1,551 individual animals, representing 381 species of mammals, birds, and reptiles, an increase of 137 over the preceding year. The more important additions were 2 elephant seals and 4 northern fur seals, 8 white pelicans, and a pair each of Brazilian tapirs, Patagonian cavies, and Chilean eagles. The number of visitors was 542,738, or a daily average of 1,487. The largest number in any one month was 95,485, in April, 1912. That the educational value of the park is appreciated is indicated by the fact that it was visited by 4,140 pupils, representing 142 schools and classes from the District of Columbia and neighboring States, and from Vermont, Massachusetts, New York, and Tennessee.

Although each year some improvements are made as regards the accommodation of the collections and the comfort of visitors, yet much remains to be done before the park can be brought to a condition that would properly be expected in a zoological park maintained by this great nation. The most important improvement of the year was the construction of a fireproof building for a central heating plant, in which are installed two pairs of boilers for alternate use as repairs or cleaning become necessary. A yard and bathing pool was also constructed for the use of the hippopotamus and the tapirs; three small inclosures were built for semiaquatic animals; and various other additional structures were built, as enumerated by the superintendent in his report on another page.

I have for several years called attention to the urgent need of a suitable aviary for the fine series of birds in the collection. A suitable structure for this purpose is estimated to cost about \$80,000. Around this large aviary would be grouped the cages for the eagles, vultures, condors, and owls, now scattered irregularly about the grounds.

The superintendent in his report calls attention also to several other desirable measures for the betterment of the park.

The Biological Survey of the Department of Agriculture, in cooperation with the Zoological Park, is carrying on some experiments in breeding mink with a view to ascertaining the possibilities of rearing them in captivity for commercial purposes. The main object in view is to secure data relative to the best methods of rearing mink for their fur, especially as to details of housing, feeding, mating, and caring for them.

ASTROPHYSICAL OBSERVATORY.

The principal research carried on by the Astrophysical Observatory during the year has been on the variability of the sun. Progress has been made in the dissemination of standards of pyrheliometry and on the absorption of radiation by atmospheric water vapor.

The first of these investigations was in continuation of observations taken during several years past to definitely determine the laws governing the apparent variability of the "solar constant." The solving of this problem, it is expected, will be of much value in the probable forecast of climatic conditions from year to year. In this research it seemed important that simultaneous observations be made in widely separated parts of the world. It was accordingly arranged to make such observations at Mount Wilson, California, and at Bassour, Algeria. The results of this work are discussed by Mr. Abbot in his report on another page.

For several years the Institution has been sending to observatories, widely separated throughout the world, standardized copies of the standard silver-disk secondary pyrheliometer designed by the director of the Smithsonian Astrophysical Observatory. During the past year about 10 such instruments have been prepared and sent out, mostly to foreign governmental meteorological services. It is hoped to thus secure not only uniformity of radiation measures, but also a more exact knowledge of solar radiation and the influence of the terrestrial atmosphere upon it.

In carrying forward the research on the absorption of radiation by atmospheric water vapor, there has been recently devised at the observatory a method for determining spectroscopically the total quantity of water vapor between the observer and the sun. Atmospheric water vapor absorption work during the year was confined to the upper infra-red spectrum bands. It is expected by the use of a vacuum bolometer now in preparation to make considerable gain in the sensitiveness of the apparatus and greatly promote the value of the work at great wave lengths.

INTERNATIONAL CATALOGUE OF SCIENTIFIC LITERATURE.

The cooperative enterprise known as the International Catalogue of Scientific Literature is represented in the United States through the Smithsonian Institution, an appropriation being made each year by Congress to maintain a regional bureau in this country under the auspices of the Secretary of the Institution.

This bureau, in cooperation with thirty-one other regional bureaus, through a central bureau in London, publishes yearly 17 volumes, which form an index to current scientific literature. Each country

supports its own bureau, in the majority of cases by means of direct governmental grants. The London central bureau, which bears all of the expense of editing and publishing the data prepared by the regional bureaus, depends for its support entirely on funds received from the subscribers to the work. In the beginning of the enterprise the subscription price was fixed at \$85 per year for a full set of 17 volumes, and it has been necessary to maintain this price, as there are a limited number of libraries and scientific bodies whose subscription to the work practically assures the sum necessary for publication. The lack of any surplus, however, renders it impossible to reduce the price of the work in order to meet the demands of a large number of scientific investigators, who are practically excluded as personal subscribers to this valuable source of information, owing to the present prices.

Had the central bureau a permanent and independent income, derived from an endowment or otherwise, it would be possible to adopt the course which would under similar circumstances be followed by a commercial publishing house having a liberal working capital; that is, to reduce the price of the publication and depend on the certainty of increased sales to pay the relatively small expenses of printing a larger edition of the work. An endowment of \$100,000 properly invested would, it is believed, make it possible to carry out this plan, and, for the end to be accomplished, it would be difficult to find a better use for this comparatively small sum. A more detailed statement of the condition of this interesting example of what may be accomplished through international cooperation will be found in the report of the bureau in the appendix.

Respectfully submitted.

CHARLES D. WALCOTT, *Secretary.*

APPENDIX 1.

REPORT ON THE UNITED STATES NATIONAL MUSEUM.

SIR: I have the honor to submit the following report on the operations of the United States National Museum for the fiscal year ending June 30, 1912:

SUMMARY OF THE YEAR'S PROGRESS.

By the close of the year the natural history departments of the Museum had been quite fully established in the new building, only a small amount of exhibition material remaining to be transferred. The laboratories had been occupied for some time, and the reserve collections brought over from the older buildings had been mainly arranged in the more ample and convenient quarters provided for them. The work of classification had necessarily to be in large part suspended during the period of moving, but the opportunity was availed of to expedite the labeling and recording, and these collections are now, as a whole, in much better condition and far more accessible for reference and study than at any previous time in the history of the Museum. The task of moving was both arduous and delicate, involving, as it did, the handling of several million specimens of all sizes and all degrees of hardness without injury and without the loss or disarrangement of labels. That it was accomplished satisfactorily in such a remarkably short space of time is especially gratifying, in view of the fact that the exigencies of the current work were fully met and no cessation occurred in the receipt of new material.

The installation of the exhibition collections, however, could not be hastened in the same way. A much greater time is required for the construction of the cases, which are more elaborate in character than those intended for storage, and but few of the cases used in the older buildings are adapted to the new building, though many have been temporarily employed. It has also been necessary to reject a large number of the older exhibition specimens as of inferior quality for the purpose, and of those which are being utilized many require to be thoroughly renovated if not entirely done over. The new exhibitions, however, are intended to consist in great measure of fresh materials, much of which has been recently acquired, and to represent

the best skill of the museum preparator and taxidermist. During the year this branch of the work was pressed to the fullest extent possible, and excellent progress was made.

Of the total floor area of about 465,000 square feet furnished by the new building, the amount of space dedicated to the public, including the floors and galleries of the south pavilion and rotunda, is slightly in excess of 220,000 square feet. The permanent exhibitions now planned are limited to the first and second stories of the wings and ranges, which they will completely occupy and which contain about 186,000 square feet. Of this space about three-fourths has been opened to the public, although it should be explained that the installations are still to a large extent provisional and subject to revision, a work that is steadily going on. The end of another year, however, should see all of the exhibition halls opened and in good though not finished condition.

The exhibitions to which the public had gained access by the close of the year comprised, besides the picture gallery in the middle hall, ethnology, historic archeology, systematic and applied geology, mineralogy, paleontology, the birds and fishes, small sections of the mammals and invertebrates, a synoptic series of biology, and certain special zoological collections illustrating anatomy and development, albinism, melanism, hybridism, the domestic animals, and the local fauna. The principal branches that remained to be opened up were the mammals, reptiles, marine invertebrates, and prehistoric archeology.

The removal of the natural history collections from the older buildings furnishes the opportunity for the more complete organization of the department of the arts and industries as contemplated in the original plan of the Board of Regents. Certain subjects belonging to it have for a long time been illustrated to the extent permitted by the crowded condition of the exhibition halls, among them being land and water transportation, firearms, electrical inventions, measuring devices, many kinds of machinery, the graphic arts, and ceramics. There are several others, however, equally important and interesting, of which the Museum has many and valuable illustrations. The material, obtained from various sources, but mainly from the great international expositions, has, from lack of room, been necessarily kept in storage, though before the crowding of the older buildings began some parts of it were exhibited. The space that has been released will afford accommodations for the installation of this material, so far as it has not deteriorated, and for such additions as will be needed to round out the exhibits of the several subjects in at least a modest way. With this accomplished, the Museum will be confronted with the problem of the further develop-

ment of the department to make it comparable with those in the principal European countries, and thus capable of exerting a direct and beneficial influence on the higher industrial pursuits of the country.

It was not until after the middle of the year, however, that the extension of the work in this direction could be taken up, and little more was possible than to remove the material from storage, and begin its unpacking and assorting. The installations will be made, at least for the most part, in the old cases, which will have to be more or less remodeled for the purpose, but it is not expected that the public will be long delayed in gaining access to some parts of these collections. The material relating to the graphic arts and to book-making will be exhibited in the Smithsonian building, but the other subjects will be mainly provided for in the older Museum building, and comprise, besides those above mentioned, mineral technology, textiles, woods, various animal and vegetable products, foods and drugs, etc. The division of history will continue to occupy its present position in the older Museum building, as will the collection of art textiles, but additional space will be required for the former, whose growth and popularity have been exceptionally gratifying.

Several unoccupied rooms in the new building were used by the Government for the competitive plans for the Lincoln and Perry memorials, authorized by Congress and submitted during the year. Opened to the inspection of the public, the models and pictures of the designs for the Lincoln monument in Washington were still on exhibition at the close of the year.

The Sunday opening of the Museum, so long and earnestly advocated by the authorities of the Institution, was one of the most noteworthy accomplishments of the year. This innovation is, in fact, to be regarded as marking the beginning of a new period in the history of the Museum, in which its privileges may be enjoyed with equal freedom by all classes. Started on October 8, 1911, and restricted to afternoon hours, it is for the present limited to the new building.

ADDITIONS TO THE COLLECTIONS.

The permanent additions to the collections numbered approximately 238,000 specimens and objects, of which about 168,000 were biological, 63,000 geological and paleontological, and 7,000 anthropological. There were also many loans, some of great value.

The more important accessions in anthropology related to the Indians of southern Alaska and Panama, and included an interesting series of objects from the ruined pueblo of Kwasteyukwa, New Mexico. To the exhibits in mechanical technology were added many important articles, including the first aeroplane acquired and used by the Government, a large number of firearms, both military and sporting, and numerous examples of inventions. The division of

American history was especially favored with both gifts and loans, among the distinguished persons and families represented by the memorials received being Gen. Peter Gansevoort, of Revolutionary time, and his son and grandson; Rear Admirals Winfield Scott Schley and Andrew H. Foote, United States Navy; Commanders Matthew Fontaine Maury and Harry H. Hosley, United States Navy; Gen. George A. Custer, United States Army; the Marquis de Lafayette; Prof. George Frederic Barker; Mr. and Mrs. Samuel S. Cox; Julia Ward Howe; the Washington and Ball families; the Cropper and McLane families; the Bradford family, of New England; and the Bailey-Myers-Mason family. The collection of numismatics acquired two valuable series of several hundred pieces each, one representing the Polish coinage from 1386 to 1835, the other consisting of antique copper coins from Asia. Exceptionally important was the transfer to the National Museum of the museum of the Post Office Department, so well known to visitors to Washington, comprising the large and unique series of United States postage stamps, besides many objects relating to the operations of the postal service.

The most conspicuous acquisition by the department of biology consisted of the collection made by Mr. Paul J. Rainey on his expedition to British East Africa, accompanied by Mr. Edmund Heller, which was generously presented. It contains about 4,000 mammals, besides many hundreds of birds, reptiles, fishes, and invertebrates, and has already yielded a large number of new forms. Much material was also received from several other natural history expeditions beyond the United States conducted by the Institution and Museum or under other auspices, the principal regions visited having been the Aleutian Islands, British Columbia and Alberta, the Panama Canal Zone, the Bahama Islands, Peru, Abyssinia and British East Africa, the Altai Mountains on the borders of Siberia and Mongolia, Kashmir, and Borneo. Within the confines of the United States a number of minor explorations were carried on by members of the staff.

The transfers made by the Bureau of Fisheries were extensive and important, consisting mainly of collections that had been studied and described and containing much type material. The fishes were from Japan, the Philippine Islands, and various parts of the United States, while the marine invertebrates, numbering over 27,000 specimens of several groups, represented explorations by the steamer *Albatross* in different parts of the Pacific Ocean. The increases in the division of insects were chiefly from the Bureau of Entomology, and in the herbarium from the Bureau of Plant Industry, though many specimens were secured for the latter by exchange and as the result of field work in New Mexico.

The collections of geology and mineralogy received important additions, including types and recently described materials and many fine examples of building and ornamental stones. The permanent acquisitions in paleontology, amounting to over 60,000 specimens, were mainly of Cambrian fossils from British Columbia and Alberta, and from China; Ordovician fossils from the western United States, New York, and Canada; Ordovician and Mississippian fossils from the Mississippi Valley; and Tertiary fossils from the Isthmus of Panama. It is gratifying to note the deposit in the Museum by Mr. Frank Springer of his unrivaled collection of fossil echinoderms, numbering some 75,000 specimens, which he has been many years in assembling and on which no expense has been spared. The material has been installed and made accessible in one of the larger laboratory rooms, and it is the purpose of Mr. Springer to devote much of his time to further research work in connection with it.

NATIONAL GALLERY OF ART.

A memorable event in the brief history of the Gallery was the exhibition in one of the great halls of the new building of a selection of objects from the collection of American and oriental art presented to the Nation in 1906 by Mr. Charles L. Freer, of Detroit, Michigan, but which is to remain in the possession of the donor during his life. This special exhibition, which continued during two months, from April 15 to June 15, and opened with an evening reception, was made possible through the courtesy and generosity of Mr. Freer, by whom the expenses of transportation were defrayed.

The selection, which numbered 175 pieces out of the more than 4,000 composing the Freer collection, was representative of its characteristic features, and in variety, richness, and rarity of material constituted in itself a remarkable exhibit for any place or time. The American art side of the collection was illustrated by 38 paintings, of which 24 were by James McNeill Whistler and the others by Thomas W. Dewing, Dwight W. Tryon, Abbott H. Thayer, and Winslow Homer. Of oriental productions there were 13 Japanese paintings of the sixteenth to the nineteenth centuries; 36 Chinese paintings, the earliest belonging to the Liang dynasty, and also 4 albums of Chinese paintings; 17 Chinese bronzes, one dating back to the Shang dynasty, many centuries before the Christian era; 4 Chinese sculptures of the Wei and T'ang dynasties; 52 examples of old Chinese, Korean, Japanese, Persian, and Mesopotamian pottery; 7 specimens of ancient Egyptian glass; and 4 Persian and Indo-Persian illuminations.

Mr. William T. Evans, of New York, whose generous benefactions have extended through more than five years, made 10 important additions to his collection of the works of contemporary American

painters, which, at the end of the year, numbered 137 pieces by 98 artists. One of the older paintings was also exchanged for another and better example of the work of the same artist. This collection, which occupies the greater part of the space now allotted to the Gallery, is a most notable presentation of American art. The painters represented in the contributions of the year are William B. P. Closson, Wyatt Eaton, Albert L. Groll, Arthur T. Hill, William M. Hunt, William S. Robinson, Abbott H. Thayer, Elihu Vedder, Edgar M. Ward, Frederick J. Waugh, and Irving R. Wiles. Mr. Evans also added 34 proofs of American wood engravings to his previous donation of 81 examples.

The collection of historical paintings in oil was increased by two noteworthy gifts to the Nation. One of these consisted of portraits of Mathias Ringmann, Martin Waldseemuller, and Vautrin Lud, the geographers who, in 1507, first applied the name "America" to the new continent, and was received from the municipality of St. Dié-des-Vosges, France. The other comprised a portrait of John Ericsson and a painting illustrating the "Combat between the *Monitor* and the *Merrimac*," and was made by the Swedish American Republican League of Illinois. The Gallery was also fortunate in obtaining many loans, both of paintings and sculpture, and within the restricted limits of its quarters has maintained an exhibition of exceptional merit and attractiveness.

ART TEXTILES.

Interest in the collection of art textiles, under the patronage and direction of Mrs. J. W. Pinchot, continued unabated, and of 68 additions received 15 were gifts. The laces have now become sufficiently well represented to permit the arrangement of a synoptical series in which all of the varieties are shown, and of a special exhibit constituting a résumé of the history of lace making.

PERIOD COSTUMES.

During the year a collection of costumes intended to illustrate the changes in style of personal attire in America from the colonial period to the present time, was undertaken. The material so far gathered has consisted mainly of apparel actually worn at important state and social functions, which gives it an historical interest, and the collection should also very materially supplement that of art textiles, offering useful suggestion in the field of design. The subject was taken up on the initiative of Mrs. Julian James, who is giving it her personal attention, and the contributions, ranging from single objects to complete parts of costumes, comprised both loans and gifts.

MISCELLANEOUS.

Of duplicates separated from the collections in the course of the work of classification about 8,000 specimens, chiefly minerals, ores, fossils, and recent animals, were distributed to schools and colleges for teaching purposes. About 16,000 duplicates were also used in making exchanges, whereby material of similar value was obtained for addition to the permanent collections. To specialists connected with other scientific establishments some 11,500 specimens, mainly biological, were sent for study, principally in the interest of the Museum and for the purpose of securing the identification of material which could not be determined here.

The number of persons who visited the new building during the year was 281,887, the older Museum building, 172,182, and the Smithsonian building, 143,134, being equivalent to an average daily attendance at each of the three buildings of 800, 550, and 457, respectively. The total Sunday attendance at the new building, beginning October 8, amounted to 64,987, an average by Sundays of 1,666 persons, or more than double the daily average for the same building.

The publications issued during the year comprised the annual report for 1911, volumes 39, 40, and 41 of the Proceedings, and 3 Bulletins, besides 59 papers from the Proceedings, Bulletins, and Contributions from the National Herbarium, printed separately. The total number of copies of publications distributed was about 67,000.

The library received additions to the extent of 1,791 books, 3,608 pamphlets, and 276 parts of volumes, and at the end of the year was estimated to contain a total of 42,002 books and 69,670 unbound papers. With the completion of the arrangements in progress all of the works on natural history will be transferred to the new building, leaving the older quarters for those relating to the arts and industries and history, and by this division the congested condition of the library which has so long prevailed will be relieved.

The facilities offered by the new building were often availed of during the year for congresses and meetings relating to science and art. Among the more important bodies which met or were received there were the American Association for the Advancement of Science and affiliated societies, the National Academy of Sciences, the American Federation of Arts, the American Institute of Architects, and the Red Cross Conference.

Respectfully submitted.

RICHARD RATHBUN,

Assistant Secretary in Charge U. S. National Museum.

Dr. CHARLES D. WALCOTT,

Secretary of the Smithsonian Institution.

OCTOBER 31, 1912.

APPENDIX 2.

REPORT ON THE BUREAU OF AMERICAN ETHNOLOGY.

SIR: I have the honor to submit the following report of the operations of the Bureau of American Ethnology during the fiscal year ended June 30, 1912, conducted in accordance with the act of Congress approved March 4, 1911, making appropriations for sundry civil expenses of the Government, which act contains the following item:

American ethnology: For continuing ethnological researches among the American Indians and the natives of Hawaii, including the excavation and preservation of archaeological remains, under the direction of the Smithsonian Institution, including salaries or compensation of all necessary employees and the purchase of necessary books and periodicals, including payment in advance for subscriptions, forty-two thousand dollars.

SYSTEMATIC RESEARCHES.

The systematic researches of the bureau were conducted by the regular staff, consisting of eight ethnologists, and with the aid of specialists not directly connected with the bureau, but the results of whose studies were procured for publication. These operations may be summarized as follows:

Mr. F. W. Hodge, ethnologist-in-charge, was occupied with administrative affairs during the greater part of the year, but from time to time, as opportunity afforded, he was engaged in the preparation of an annotated Bibliography of the Pueblo Indians, with the result that almost 1,100 cards bearing titles, descriptions of contents, etc., of writings pertaining to the Pueblos were completed. Knowledge of the Pueblo Indians commenced with the year 1539, and these people have been the subject of so much attention by early Spanish explorers and missionaries, as well as by ethnologists and others, in recent years, that the literature has become voluminous and widely scattered. The need of a guide to this array of material has been greatly felt by students, and for this reason Mr. Hodge has prepared notes on the subject for a number of years with the view of their final elaboration in the form of a bibliography.

Late in August Mr. Hodge proceeded to New Mexico, and after a brief visit to the archeological sites in the Rito de Los Frijoles, northwest of Santa Fé, where excavations were conducted in conjunction with the School of American Archaeology in 1911, continued

to El Morro, or Inscription Rock, about 35 miles east of Zuñi, for the purpose of making facsimile reproductions, or squeezes, of the Spanish inscriptions there, which have such an important bearing on the early history of the Pueblo tribes. El Morro is a picturesque eminence of sandstone rising from the sandy valley, and by reason of the former existence of a spring at its base, which is now merely a seep, it became an important camping place of the early Spaniards on their journeys to and from the Rio Grande and the Zuñi and Hopi pueblos. The inscriptions of these early explorers were carved near the base of the rock, chiefly on the northern and southern sides of the highest portion of the mesa, and in the main consist of the names of the visitors with the dates of their visits, but in a number of cases elaborated with a more or less full statement of the object of the journey.

The earliest of the inscriptions is that of Juan de Oñate, the colonizer of New Mexico and founder of the city of Santa Fé, who inscribed his name and the object of his visit in 1606, on his return from a perilous journey to the Gulf of California. Others who visited the rock and left a record are, in order of date: Gov. Francisco Manuel de Silva Nieto, who escorted the first missionaries to Zuñi in 1629; Juan Gonzales, probably a member of the small military escort accompanying the same party, and bearing the same date (1629); Lujan, who visited Zuñi in 1632 to avenge the murder of Fray Francisco Letrado, one of the missionaries who accompanied Silva Nieto; Juan de Archuleta, Diego Martin Barba, and Agustin de Ynojos, 1636; Gov. Diego de Vargas, 1692, the conquerer of the Pueblos after their rebellion in 1680 which led to their independence of Spanish authority during the succeeding 12 years; Juan de Uribarri, 1701; Ramon Paez Hurtado, 1709; Ju. Garcia de la Rivas, Feliz Martinez, and Fray Antonio Camargo, 1716; Joseph de Payba Basconzelos, 1726; Juan Paez Hurtado and Joseph Truxillo, 1736; Martin de Elizacochea (bishop of Durango) and Juan Ignacio de Arrasain, 1737; and others of the eighteenth century. These inscriptions were all carefully photographed by Mr. Jesse L. Nusbaum, with whose aid Mr. Hodge made paper squeezes which were brought to Washington and transferred to the National Museum, where Mr. Nusbaum later made plaster casts of the paper negatives, insuring the permanent preservation of the inscriptions in this manner. This work was accomplished none too soon, since deterioration by weathering is progressing in some parts of the cliff face bearing the inscriptions, while vandalism is perhaps playing an even more serious part in the destruction of these important historical records, notwithstanding the fact that El Morro has been created a national monument by Executive order.

Early in September Mr. Hodge joined Dr. Edgar L. Hewett, director of the School of American Archæology, and his assistants, in the Jemez Valley, about 65 miles northwest of Albuquerque, for the purpose of conducting excavations, under the joint auspices of the bureau and the school, in an extensive ruined pueblo on a mesa 1,800 feet in height, skirting the valley on the west. This village was occupied within the historical period by the Jemez people, by whom it is known as Kwasteyukwa. The ruins cover an area approximately 850 by 600 feet, and even on partial excavation exhibited distinct evidence of occupancy at two different periods. The original pueblo was considerably larger than the one later inhabited, although the latter was built on the ruins of the older and of the same materials. The walls were of tufa blocks, rudely shaped and set in adobe mortar; the rooms were small, the masonry crude, and practically none of the walls remain standing above ground. A large artificial reservoir in a northwestern angle of the ruin furnished the water supply, and various smaller depressions probably mark the sites of kivas. The later inhabitants—those within the historical period, or about the first half of the seventeenth century—buried their dead in and beneath the débris of the older part of the pueblo. The mortuary accompaniments were of the usual character, speaking in general terms—pottery, traces of textiles, stone and bone implements and other objects, and a few ornaments. The finding of glass beads with the remains of a child, and an iron nail in another grave, bear testimony of the comparatively recent occupancy of the village by the Jemez Indians. It was the custom of the inhabitants to throw large stones into the graves, resulting in the breaking of almost all the pottery deposited with the dead. The fragments were carefully preserved, however, and will be repaired by the National Museum. A noteworthy specimen of pottery bears in its decoration a feather design almost identical with feather symbols found on ancient pottery of the Hopi, and therefore tending to verify traditions of the latter people that some of their ancestral clans came from the Jemez.

Dr. J. Walter Fewkes, ethnologist, was engaged in field work from July to October, having especially in view the determination of the western limits of the ancient Pueblo culture in Arizona. Outfitting at Jerome, in that State, he proceeded to certain large ruins on the upper Verde, on Oak Creek, and in Sycamore Canyon, where some time was spent at each locality in photographing and in making plans of these and adjacent remains, as well as in a study of the formerly occupied caves near the mouth of Oak Creek. Crossing the rough country separating the upper course of Oak Creek and the great sandstone cliffs known as the Red Rocks, Dr. Fewkes revisited and further studied the large cliff dwellings, known as Honanki and

Palatki, excavated by him in 1895. Several hitherto undescribed ruins were added to the list of ancient remains in this general vicinity.

From the Red Rocks Dr. Fewkes returned to the Verde and followed that stream upward to the Jordan ranch, where cliff houses of an instructive character were photographed and studied. He also investigated on the hills back of Cornville certain large stone structures of the type known to Spanish-speaking people as *trincheras*, rude but massive fortifications that here begin to assume importance. A number of ruins hitherto unrecorded belonging to the cave- or cliff-dwelling type were observed in the walls of Sycamore Canyon, or Dragoon Fork, and the outlines of stone houses were seen above the river terrace near the junction of Sycamore Creek and Verde River. A large aboriginal fort, with walls well preserved, was found on a height overlooking the Verde, above the mouth of Granite Creek, and others more nearly destroyed were seen at the Baker ranch and in Hell Canyon, not far from Del Rio Station. Near the Baker ranch, a mile or two down the Verde, are the remains of a cliff dwelling, directly in the line of a projected railroad, which will probably be destroyed when the road is constructed. Dr. Fewkes also visited the ruins of several fragile-walled habitations, consisting of low mounds, near Jerome Junction and Del Rio. Although many evidences of such ancient dwellings are here seen, most of the foundation walls have been carried away by settlers and used in their own house building.

A large fort, with well-preserved walls, occupies a low limestone ridge east of Williamson Valley, above the trail from Del Rio westward, and commanding a view of the valley west of Jerome. This fort is typical of the *trincheras* that appear more and more frequently as one proceeds westward from the upper Verde. Several inconspicuous ruins, hitherto undescribed, were found in Williamson Valley, those situated on the hills belonging to the fortification type, while those in the valleys consist merely of low mounds of stone and other débris.

Proceeding westward from Chino Valley, many interesting ruins were observed along the valley of Walnut Creek, referred to in Lieut. A. W. Whipple's report of 1853 as Pueblo Valley, once noted as the site of old Camp Hualapai. This vale, from Aztec Pass to the point where the creek is lost in the sands of Williamson Valley, was extensively tilled in prehistoric times, as is attested by the well-marked remains of ancient irrigation ditches. Characteristic petroglyphs were also found in Walnut Valley.

As elsewhere in this region, two types of ruins were observed in Walnut Valley, namely, (1) extensive stone fortifications with massive walls crowning the hilltops on both sides of the valley and commanding a wide view, and (2), on the low terraces bordering the stream, clusters of small mounds constituting the remains of farm-

houses, upright posts supporting walls of wattling plastered with mud like the *jacales* of the Mexicans and evidently identical in their general character with the dwellings of certain Yuman tribes. Among the best preserved of the forts, called "pueblos" by Whipple, are those near Aztec Pass and at Drew's ranch, Shook's ranch, and Peter Marx's ranch, while others are found farther down Walnut Creek. No trace of terraced pueblo dwellings were seen in this region.

In order to shed further light on the relations of the two types of ruins described, Dr. Fewkes made an examination of the ancient remains along the Agua Fria and near Prescott. At both places the ruins were found to be of the same dual character. In a few instances, as at Frog Tanks, near the mouth of the Agua Fria, the ruins suggest the great houses or compounds of the Salt and Gila Valleys, but here also *trincheras* and fragile-walled houses are the more common.

The observations made by Dr. Fewkes during this field season indicate that the ruins in the region referred to are the remains of buildings so different in architecture from that of true pueblos that it is probable the culture of their occupants was also different. Dr. Fewkes reached the conclusion that the ruins of the forts and small dwellings referred to were constructed and used by a Yuman people whose descendants, more or less mixed with Apache and other non-related tribes, are represented to-day by the Hualapai, Yavapai, and Havasupai Indians. Although the *jacal* domiciles of western Arizona were probably structurally similar to certain ancient houses in the Pueblo region of New Mexico, the river-terrace houses of Walnut Valley were more like certain habitations of the lower Gila River than they were the pueblos of the Rio Grande.

On returning to Washington Dr. Fewkes prepared a report on his observations in this interesting archeological field, which, with suitable illustrations, is now in press as one of the accompanying papers of the twenty-eighth annual report.

Dr. Fewkes also gave considerable time to reading the proofs and arranging the illustrations of his memoir on Casa Grande, which likewise is to appear in the twenty-eighth annual report.

On the completion of the above work Dr. Fewkes commenced the preparation of another paper, relating to "Designs on Prehistoric Hopi Pottery," a subject to which he devoted much attention in connection with his studies of the Hopi Indians for 20 years. This memoir, which was well advanced toward completion at the close of the fiscal year, accompanied by numerous plates and text figures, is designed as a key to the interpretation of the decoration of ancient Hopi earthenware. The great multiplicity of life designs appearing on the pottery of ancient Sikyatki are treated in the paper, in which

modifications in decorative devices derived from feathers, birds, and other animals, and conventional figures are likewise discussed. One object of Dr. Fewkes's treatise is to meet a growing desire of those interested in primitive symbolism, and another is to define the peculiarities of one ceramic area of the Pueblos as a basis for comparison with others, thus facilitating the study of Pueblo culture origins and prehistoric migration routes.

As the construction of the Panama Canal has tended to stimulate an interest in aboriginal remains in the West Indies, and as many archeological specimens differing from those of the Antilles previously known are now being brought to light, the time for a scientific study of them, as well as of the aboriginal sites of the West Indies, has arrived. Much of the interest recently manifested in early Indian life in the West Indies may be ascribed to Dr. Fewkes's memoir on "The Aborigines of Porto Rico and Neighboring Islands," which appears in the twenty-fifth annual report. Since the publication of this paper the new material has become so abundant that plans have been made for Dr. Fewkes to resume his study of West Indian archeology. The most noteworthy collection of aboriginal objects from this area made in recent years is that of George G. Heye, Esq., of New York, who courteously has placed his material at the disposal of the bureau as an aid to these investigations. This collection has been studied by Dr. Fewkes and the most important objects contained therein are now being drawn for illustrative purposes.

Dr. Fewkes's researches thus far indicate that the so-called Tainan culture of Porto Rico and San Domingo was represented in the Lesser Antilles by an agricultural people, probably Arawak, who were conquered and absorbed by the marauding Carib. Study of the collections above noted tend to show that several of the Lesser Antilles were marked by characteristic types of pottery, indicating their occupancy by a people superior in culture to the Carib and to those found there at the time of the discovery by Columbus. New light has been shed on the relations of these early Antillean people and the Orinoco tribes, which, although generally called Carib, were probably an antecedent people of higher culture.

Mr. James Mooney, ethnologist, spent the first three months of the fiscal year in continuing investigations among the East Cherokee of western North Carolina, and in locating and investigating mixed-blood remnant bands in the eastern part of that State. The Cherokee work consisted chiefly of a continuation and extension of the study of the aboriginal sacred formulas of the priests and doctors of the tribe, with the accompanying ceremonies and prescriptions. Although the former dances and tribal gatherings have fallen into disuse, the family rites and medical ceremonies still hold sway among the full bloods.

The so-called "Croatan Indians" of southeastern North Carolina were found to be an important and prosperous community, numbering about 8,000, evidently of Indian stock with admixture of negro and white blood, and closely resembling the Pamunkey Indian remnant tribe in Virginia, but with no survival of Indian language or custom and with almost no knowledge of their own history. After years of effort they have secured definite State recognition as an Indian people. There is no foundation in fact for the name "Croatan Indians," which they themselves now repudiate, and in all probability they represent the mixed-blood descendants of the aboriginal tribes of the region which they now occupy. The existence was also established, and the location ascertained, of several smaller bands of similar mixed-blood stock, but without official recognition, in the eastern section of the two Carolinas.

The remainder of the year was devoted by Mr. Mooney to the compilation of material in connection with his pending study of Indian population. By reason of the shifting, disintegration, and new combinations of tribes, no one section can be treated separately or finally as apart from others. Considering the difficulties met in a study of this kind, the work is making satisfactory progress.

Dr. John R. Swanton, ethnologist, devoted most of the year to field researches among the Creek Indians in Oklahoma. These investigations continued from the middle of September, 1911, to the middle of May, 1912, during which period excursions were made into Texas to visit the Alibamu Indians and for the purpose of endeavoring to trace remnants of other Texas tribes, and to the Caddo Indians of southwestern Oklahoma. No remains of Texas tribes, of ethnologic value, other than the Alibamu, were located, but a considerable mass of material was obtained from the latter. Dr. Swanton's visit to the Caddo was with the view of learning how many of the old Caddo dialects were still spoken, and some valuable documentary material was obtained in Natchitoches, Louisiana. No words of Haiish, supposed to be quite distinct from the other Caddo dialects, could be gathered, but evidence was obtained that it resembled Adai. In the course of his Creek investigations Dr. Swanton visited and made photographs of every busk ground of the Creeks and Seminole still maintained, and information was gathered regarding the organization of the "big house" in each, as well as in those that have been abandoned. Dr. Swanton devoted July and August, 1911, mainly to the study of the Hitchiti and Natchez languages, and the period subsequent to his return to Washington in May, 1912, was occupied in copying his field notes and in incidental work on the Timucua language of ancient Florida, as preserved in Father Pareja's writings, with the view of determining whether Timucua bears any relation to the languages of the Muskogean stock.

On his way from Oklahoma to Washington, Dr. Swanton stopped at Bloomington, Indiana, for the purpose of representing the bureau at the fifth annual meeting of the Mississippi Valley Historical Association, before which he read a paper on "De Soto's line of march, from the point of view of an ethnologist."

Mrs. M. C. Stevenson, ethnologist, continued her field researches of the Tewa tribes of New Mexico throughout the fiscal year, devoting attention particularly to those of San Ildefonso and Santa Clara, and incidentally to the Tewa of Nambe and San Juan. The pueblo of Pojoaque is now practically extinct as an Indian settlement, only about six Tewa remaining in that village. Special attention was devoted to the religious, political, and social organizations of these peoples, which, owing to their extreme conservatism, are difficult to determine. The Tewa are divided not only into clans with patrilineal descent, but each tribe consists of a Sun people and an Ice people, each with its own kiva, or ceremonial chamber. At San Ildefonso the kiva for the Sun people is known as Po'tée, "Squash kiva," and that of the Ice people is Kun'iyäⁿtée, "Turquoise kiva." The element *tée* signifies "round," hence indicating that originally the Tewa kivas were circular. A third kiva of San Ildefonso is called Téepoaⁿte, meaning "Round gathering or sitting place," and symbolizes a lake. Although from its trim condition this kiva appears to be modern, it is in reality very old, and within the memory of the older men of San Ildefonso it was used whenever the Sun and Ice people met together, because of its large size. Large councils are still held in the Téepoaⁿte, and it is used also as a dressing room for the dancers participating in ceremonies. The kivas are also the meeting places of the sacred fraternities. The Squash, Summer Bear, and Fire organizations of San Ildefonso hold their ceremonies in the kiva of the Sun people. The Fire fraternity was adopted in the ancient past from a people in the north who lived in skin tipis, wore clothing of dressed deerskin, and spoke a strange tongue. This fraternity finally became extinct, and, wishing to reestablish it, the San Ildefonso people sent four men to the Sun people of Zuñi (whose Fire fraternity, according to tradition, had a similar origin), who initiated them into their order, thus enabling them to revive the fraternity at San Ildefonso. The Galaxy and Turquoise fraternities meet in the Turquoise kiva. The members of the former organization have a fraternity chamber adjoining this kiva, and at the great Buffalo festival its members frequent the chamber as well as the kiva.

Each fraternity at San Ildefonso has a tablet altar, which is erected on the western side of the kiva, while the participants in the ceremonies sit facing eastward. These people have interesting animal fetishes and many human images of stone representing their anthropic gods. They appeal to their zoöic deities to heal diseases inflicted by

sorcery, and all ceremonies connected with these supplications are dramatic in character. Anthropie gods, principally ancestral, are invoked for rain and the fructification of the earth. The present priest of the Sun people is director of the Summer Bear fraternity, and he is also the keeper of the calendar. He must observe the daily rising and setting of the sun and must watch the rising and setting of the moon. Elaborate solstice ceremonies are performed. Those for the summer solstice are held in the kiva of the Sun people. The Ice people join the Sun people in the summer ceremonies, and the Sun people join the Ice people in the ceremonies of winter. In each kiva the two rain priests sit side by side, the priest of the Ice people always at the right of the priest of the Sun people, while officers associated with each priest sit in line with him. The prayers of the priest of the Sun people are for the purpose of bringing rain, and in order that they may be answered he must live an exemplary life. The same beliefs control the functions of the priest of the Ice people, who, through the ceremonies which he directs, is expected to induce cold rains and snow that the earth may not become hot and destroy the vegetation. All male children are initiated, either voluntarily or involuntarily, into the kiva of the Sun or of the Ice people. When a husband and his wife belong to different sides, the kiva to which the child shall belong is selected by mutual agreement, and a representative of that kiva is chosen as his ceremonial father immediately after the birth of the child. From birth to death the lives of the Tewa are almost a continuous ceremony. The ceremonial father ties native cotton yarn around the wrists and ankles of the new-born child, that its life may be made complete. The initiation ceremonies of the young men are very elaborate, and many miles are traveled on foot to the summit of a high mountain where the final ceremonies are performed. Although the Tewa are professed Christians, they adhere tenaciously to their native religion and rituals; and while the church performs marriage and burial services, the Indians still cling to their native marriage feasts and mortuary ceremonies.

The cosmogony of the Tewa is elaborate and complicated and bears closer resemblance to that of the Taos Indians than to that of the Zuñi. The original sun and moon are believed always to have existed, but the present sun and moon were born of woman after the world and all the people were destroyed by a great flood. The myth associated with the creation of these deities and with their exploits is of great interest.

The masks of the anthropic gods are never seen outside of the kivas of San Ildefonso. There is a great variety of these masks, many of them similar to those of the Zuñi. They are held in great secrecy.

Rattlesnakes, sacred to the fraternities, are captured when young and are reared in rooms adjoining the kivas. A fluffy eagle feather is attached to the head of the snake when caught, and the snake is held captive with a string sufficiently long to allow it considerable freedom until it becomes accustomed to its new surroundings, when the string is removed. Small openings in the chamber allow the snakes to pass in and out. In one ceremony, which takes place at daylight, the snakes are handled outdoors, but on such occasions the pueblo is so patrolled that spying by outsiders is impossible, although Mexicans live almost in the heart of the village. The Santa Clara people likewise make use of live snakes in certain ceremonies, and they also have a large owl which they keep secreted as carefully as are the snakes.

The government of the Tewa differs somewhat from that of the Zuñi. While the governor of the Zuñi has to do with civic matters only, a Tewa governor has absolute power over all matters concerning his tribe except those controlled exclusively by the rain priests and the war priests. Mrs. Stevenson's studies of the natal rites of the Tewa indicate that they are more like those of the Sia than of the Zuñi, while the religious ceremonies connected therewith more closely resemble those observed by the Taos people. The child is baptized in accordance with aboriginal customs before the baptismal rite of the church is performed. At the present time the infant is usually carried in the arms instead of on the back of the mother, but the small, flat cradle, with top, and headrest with turquoise setting, is made as it was centuries ago.

The material culture of the Tewa is in many respects similar to that of the Zuñi. They were adept in the textile art in early days when cotton, milkweed, yucca, and the hair of native animals were employed in weaving, but this industry became lost after the introduction of sheep by the Spaniards, for the Tewa, like the Taos people, came to depend upon the Zuñi and Hopi traders for woven garments, and also for textile paraphernalia for use in ceremonies. One or two Tewa have revived the weaving industry to some extent—a San Ildefonso man learned the process from Santo Domingo, and a man of Santa Clara acquired it from the Navaho. The dainty baby moccasins are now seldom seen, but the women still wear moccasins with heavy leg wrappings during ceremonies, while at other times a well-dressed sheepskin boot tied below the knee is worn, for deer-skin has become rare. Native beads are now very seldom seen. Mrs. Stevenson's study of Tewa ceramics has convinced her that those who decorate their pottery apply their designs, especially the conventional patterns, with little understanding of their symbolism, the significance of which has become extinct. When questioned the potters always have a ready answer; hence students are often deceived. With

the exception of the black ware of Santa Clara, the pottery of the Tewa has greatly deteriorated.

Mrs. Stevenson has been enabled to record the names of the sacred mountains of the Tewa people, as well as the myths associated with them. In their general beliefs and customs the Tewa are found to be intermediate between the Taos and the Zuñi.

The beginning of the fiscal year found Dr. Truman Michelson, ethnologist, engaged in an investigation among the Fox Indians near Tama, Iowa, with whom he remained until the middle of August, when he proceeded to Oklahoma, where he initiated researches among the Sauk Indians of that State. Dr. Michelson was very successful in recording the myths and tales of the Foxes, which covered about 2,300 pages of texts. He obtained likewise some notes on the ceremonial and social organization of that tribe, but these are neither full nor complete, as the Foxes are, without exception, the most conservative of the Algonquian tribes within the United States. While among the Sauk Dr. Michelson, with the aid of a native interpreter, translated some of the Fox myths and tales collected in Iowa, but his chief work in Oklahoma consisted of gaining an insight into the Sauk ceremonial and social organization. He also translated, with the assistance of a Sauk, the Kickapoo texts collected by the late Dr. William Jones, subsequently correcting the version with a Kickapoo informant. The dialectic differences between Sauk, Fox, and Kickapoo are not great, and as few of the Mexican Kickapoo now speak any but broken English, a Sauk was employed in making the first draft of the translation.

Among the Shawnee of Oklahoma Dr. Michelson's work was primarily linguistic. The results confirmed his opinion, gathered from the late Dr. Gatschet's notes and texts, that the Shawnee language is most intimately connected with Sauk, Fox, and Kickapoo, on the one hand, and with the Abnaki dialects on the other. He also gathered some Shawnee myths, partly in texts, partly on the phonograph, and a beginning was made on the Shawnee social organization. It was found that, apparently, the larger divisions are not phratries, nor are their clans exogamous, as already noted by Dr. Gatschet, despite the ordinary view. The question of exogamy or endogamy among the Shawnee is fixed merely by blood relationship.

Among the Mexican Kickapoo Dr. Michelson gathered some additional texts, corrected the translations of Dr. Jones's Kickapoo texts, as above noted, made observations on Kickapoo clan organization, and gathered also linguistic data which shed further light on the relations of the Sauk, Fox, and Kickapoo dialects.

Dr. Michelson returned to Washington about the middle of December and commenced the elaboration of his field notes. In January he visited the Carlisle Industrial School, where he procured linguistic

data on Ottawa, Turtle Mountain Chippewa, Potawatomi, Abnaki, Menominee, Sauk, and Arapaho. The most important result obtained is the fact that the so-called Turtle Mountain Chippewa is really Cree—at least such is the language of the pupils at Carlisle. Whether the entire band is Cree is another question. Dr. Michelson's opinion that Arapaho is the most divergent Algonquian dialect was confirmed, and it was made more nearly certain that Menominee distinctly belongs with Cree, not with Chippewa. Dr. Michelson returned from Carlisle in the following month, when he was compelled to submit to an operation for trachoma, which apparently had been contracted during his field researches of the previous summer. On resuming his duties it was found advisable to incorporate the linguistic notes obtained in the summer and fall of 1911 and the winter of 1911-12, so far as practicable, in his memoir on the Linguistic Classification of the Algonquian Tribes, then in galley proof preparatory to publication in the twenty-eighth annual report. The value and completeness of this paper were thereby greatly enhanced.

While in the office Dr. Michelson was frequently called on to furnish data for answering letters of inquiry, and he also found opportunity to furnish notes of addenda and corrigenda for a future edition of the Handbook of American Indians.

Mr. J. N. B. Hewitt, ethnologist, was engaged throughout the year in office work, continuing the editing and copying of the legends, traditions, and myths of the Seneca, collected by the late Jeremiah Curtin in 1884-85. Of the original list of 120 items composing this manuscript collection, 85 have been edited and typewritten, exclusive of two items which were translated from inedited texts. While this work is now practically complete, the apparent discrepancy in the number of edited and typewritten items (about 35) is due to the fact that the original list contained a number of texts of little ethnological value, being merely narratives of local and personal adventures of modern Indians with ghosts, and the like, and tales about modern witchcraft. The two items completely translated were difficult of rendering, as they were partly illegible and had been left inedited. Two or three texts of similar character remained to be translated, and on these Mr. Hewitt was engaged at the close of the fiscal year. The Seneca material collected by Mr. Curtin and placed in condition for publication by Mr. Hewitt now comprises 1,350 pages.

In addition Mr. Hewitt undertook the work of translating a number of inedited and uncorrected manuscripts bearing on Seneca traditions and legendary lore recorded by himself in 1896. Thirteen of these items were translated, aggregating 410 pages.

As in the past, Mr. Hewitt devoted considerable time to collecting and preparing data for replies to correspondents on linguistic, historical, sociological, and technical subjects, and served also as custodian of manuscripts.

Mr. Francis La Flesche, ethnologist, was engaged during the year in the further study of the tribal rites of the Osage Indians in Oklahoma. These rites are regarded by the Osage as mysterious, and, being held in great awe by the tribe, are very difficult to obtain, even by their own members. Instances are pointed out where, in the belief of the Osage, persons in officiating at ceremonies made mistakes in the form or in the recitation of the rituals and in the singing of the songs, and have therefore become insane, or blind, or have met with violent death. The murder of Saucy Calf, a man of high standing in his tribe, and the burning of his house last winter are attributed by his people to the fact that he gave away certain rituals and songs of the sacred tribal ceremonies. From Saucy Calf Mr. La Flesche had obtained the entire first degree of the Noⁿhoⁿzhiⁿga rites, and while the two were together the old seer frequently expressed the fear that some harm might come to him for parting with these religious secrets. By reason of the superstitious awe in which these sacred rites are held, Mr. La Flesche's studies in this particular have been necessarily slow, since it was essential for him first to gain the full confidence of those versed therein. Notwithstanding this difficulty, he has been fortunate enough to procure the full ritual of the Hibernating of the Black Bear, which pertains to the origin of the seven and six war honors of the tribe, and is recited by the men members of the Noⁿhoⁿzhiⁿga of the Black Bear clan at the sacred-bundle ceremony when the warrior chosen recounts his war honors and takes up the seven and six willow saplings to count and the songs of this part of the ceremony are being sung by the officiating priest. A related ritual, which tells of the rearing of a child to the completion of its life, is recited when a widow is being initiated into the Noⁿhoⁿzhiⁿga to take the place of her husband; but Mr. La Flesche has not yet been able to record this, owing to the dread inspired by the death of Saucy Calf. However, after considerable difficulty he succeeded in obtaining six rituals from Waxrizhi, whose father, who died about a year before, is said to have been the last of the Noⁿhoⁿzhiⁿga men thoroughly versed in the ancient rites.

Another ritual obtained is the Dream Ritual, with literal and free translations. This is a narration of a Noⁿhoⁿzhiⁿga's fast dream of the sacred packs, a number of which have been procured and transferred to the National Museum.

Still another ritual, known as the Wi-gi-e Paho-gre, "First of the Rituals," with literal and free translations, was recorded. This tells of the coming of the Hoⁿga of the Seven Fireplaces, or clans, to the earth from the sky by permission of the Sun, Moon, and Morning and Evening stars, and with the aid of the Winged Hoⁿga, or "Spotted Eagle"; of their finding the earth covered with water when they descended; their having to rest on the tops of seven red-oak trees, until, by his magic power, the Elk dispersed the waters

and made dry land appear; their meeting with the crawfish, which brought from out of the earth clays of different colors to be used by the people of the Hoⁿga clan for symbolic purposes in their Noⁿhoⁿzhiⁿga rites. The Noⁿhoⁿzhiⁿga are said to be exceedingly careful not to recite this ritual to anyone unless given large fees.

The ritual of the Birth of the Sacred Bird, also recorded and translated by Mr. La Flesche, relates to the adoption of the hawk as a war symbol and is in the form of a legend telling of the birth of the bird, as of a human being, to the sister of four brothers who attended the delivery of the child. The story begins with the birth, gives the details of each stage of growth, and tells of the prediction of the four brothers that their nephew was destined to become a great warrior. The child becomes fretful and wails ceaselessly until the skins of seven prey animals and a bow with a bit of scalp attached are brought to it by its uncles. For this reason no one can be initiated into the order of the Noⁿhoⁿzhiⁿga unless he furnishes the skins of these seven animals.

The ritual of the Symbolic Painting was likewise recorded. This relates to the symbolic painting of the man who acts as the initiator in the initiation of a new member of the Noⁿhoⁿzhiⁿga order. The paint is symbolic of the dawn and the rising sun.

Another ritual, that of the Approach to the House of Initiation, is recited by the officiating priest while he, the initiator, and the votary ceremonially approach the place of meeting of the Noⁿhoⁿzhiⁿga for performing some of the ceremonies. It relates to the Tsi'-wa-koⁿ-da-gi, or "mysterious house," of the Hoⁿga clan.

The ritual of Feeding of the Fire relates to the ceremonial building of the sacred fire at the place of gathering of the Noⁿhoⁿzhiⁿga to perform one of the ceremonies. It is an appeal to the supernatural for aid in obtaining deer for the sustenance of life and also for help to overcome the tribes which menace the lives, the peace, and the happiness of the people.

While these rituals are in themselves complete, each one forms a part of the great Noⁿhoⁿzhiⁿga rite, which Mr. La Flesche is endeavoring to record in its entirety.

Aside from the rituals and songs, Mr. La Flesche has procured stories of the *wakoⁿ'dagi*, or medicine men, and of the strange animals from which they obtained supernatural powers; he has also recorded love stories, stories of those who had died and returned to life, war stories, and myths. Some of these have been transcribed in final form. In all, the text of these stories aggregates about 250 pages. Mr. La Flesche, however, has given comparatively little attention to legends and stories of this kind, having devoted his energies chiefly to the secret rites that at one time meant so much to the Osage people, and which are so rapidly disappearing.

By agreement with Mr. Karl Moon, noted for his work in Indian photography, the bureau is to receive a series of Osage photographs, taken with the aid of Mr. La Flesche, who made the necessary arrangements with the Indians to pose for them. Mr. La Flesche received as a gift from Wanoⁿshezhiⁿga the sacred bundle of the Eagle clan, to which he belongs. This fine specimen has been transferred to the National Museum, where it is placed with the other Osage bundles that he has been so fortunate as to obtain.

Dr. Paul Radin, ethnologist, was among the Winnebago Indians of Wisconsin at the opening of the fiscal year, having resumed his investigations of this people in the preceding month. These were continued to completion, and in October, 1911, Dr. Radin returned to Washington and continued the preparation of a monograph on the ethnology of the Winnebago tribe, which was brought to completion and submitted in the latter part of March, 1912. Although the medium of publication of this memoir has not yet been determined, it is probable that it will appear as the accompanying paper of the twenty-ninth annual report.

Dr. Franz Boas, honorary philologist, continued the linguistic researches outlined in previous reports, the immediate object of which is the completion of part 2 of the Handbook of American Indian Languages, which is to contain sketches of the native languages of Oregon and Washington, with some additional material on the extreme northwestern part of the continent. An account of the development of the plan and object of this Handbook was set forth in my last annual report.

The printing of the sketch of the Takelma grammar, by Dr. Edward Sapir, for this Handbook, has been completed, and the separates thereof have been issued. The work of Dr. Leo J. Frachtenberg unfortunately suffered delay owing to protracted illness. His revision of the Coos grammar, however, has been almost completed, and it is expected that the manuscript of the Siuslaw grammar will be in the hands of Dr. Boas, as editor of the Handbook, by August of this year. The necessary final revision of the subject matter of both sketches was made by Dr. Frachtenberg at Siletz, Oregon.

Dr. Boas rewrote a grammar of the Chukchee language, with comparative notes on the Koryak and Kamchadal, by Mr. Waldemar Bogoras, and added references to the published Russian and English series of Chukchee texts, which had been published previously by Mr. Bogoras. In the course of the year this manuscript was also type-written and prepared for the printer. In the summer of 1912 Dr. Boas met Mr. Bogoras in Berlin and discussed with him the revised form of the grammar. At the close of the year the results of these discussions were being incorporated in the grammar, and it is expected that the manuscript will be ready for the printer early in the autumn.

Dr. Boas has followed out the policy of printing texts illustrating the grammatical sketches in a series which according to the original plan were to have been published as bulletins of the bureau, but this plan was abandoned for administrative reasons. During the present year the series of Tsimshian texts, illustrating the Tsimshian dialect, was published as Volume III of the Publications of the American Ethnological Society, and the series of Maidu texts as Volume IV of the same series. These illustrate languages contained in part 1 of the Handbook, so that now texts for all the languages therein treated are available to students.

The printing of the Coos texts, by Dr. Frachtenberg, which are to appear as Volume I of the Columbia University Contributions to Anthropology, has almost been completed, and the printed matter has been utilized to illustrate the sketch of the language.

The research in Indian music by Miss Frances Densmore was characterized by the completion of her studies among the Chippewa and the beginning of investigations along similar lines among the Sioux. Miss Densmore's field work comprised one month with the Sioux on the Sisseton Reservation in South Dakota, about two months on Standing Rock Reservation in North Dakota, and a few days on the White Earth Reservation in Minnesota for the final revision of some descriptions and translations in her Chippewa manuscripts. The finished results submitted during the year comprised material on both Chippewa and Sioux music. Two papers on Chippewa studies were presented, one entitled "Further Analyses of Chippewa Songs," the other bearing the title "Deductions from the Analysis of Chippewa Music." In addition Miss Densmore finished about 100 pages that included additional references to the bibliography of the subject, a more complete explanation of minor points, some linguistic analyses, and slight changes in the analysis of individual songs to conform with present methods—all this was complete for publication when submitted. Her paper on "The Sun Dance of the Teton Sioux," including 33 songs, could be published in its present form, but it is deemed desirable to add a structural analysis of the songs similar to that accompanying the Chippewa material.

Additional illustrations for the Chippewa studies have been submitted during the year, also adequate illustrations for the paper on the Sun dance of the Sioux. With few exceptions these illustrations are photographs taken especially for the work, many being pictures of old ceremonial articles used in the Sun dance. Considerable attention also has been given to the collecting of specimens having an interest in connection with the work.

Mr. W. H. Holmes, head curator of the department of anthropology of the United States National Museum, has continued, as opportunity afforded, the preparation of the Handbook of Archeology

commenced by him while chief of the bureau. The main body of the research work in connection with this Handbook has been completed, but much remains in the way of literary investigation and in the preparation of illustrations. While no time can yet be fixed for the completion of the work, Mr. Holmes hopes to finish the manuscript and the illustrations for the first volume before the summer of 1913.

Good progress has been made in transcribing the manuscript French-Miami dictionary, by an unknown author but attributed to Père Joseph Ignatius Le Boulanger, in the John Carter Brown Library at Providence, Rhode Island. The copying has been made possible through the courtesy of Mr. George Parker Winship, librarian, who not only has placed this valuable manuscript at the disposal of the bureau for this purpose, but has kindly permitted his assistant, Miss Margaret Bingham Stillwell, to prepare the transcript, and personally has supervised the making of photostat copies of part of the manuscript, especially that devoted to the text portion. During the year Miss Stillwell finished and submitted the transcript of 295 pages, representing pages 20 to 77 of the original.

Prof. Howard M. Ballou, of the College of Hawaii, has continued the search for titles for the proposed List of Works Relating to Hawaii, especially those of works published locally in the native language, many of which are very rare. In this work Prof. Ballou has had the generous assistance of the Rev. Mr. Westervelt. This bibliography has now reached a stage where steps should soon be taken toward finally arranging the material for publication.

There has long been need of a revision of the Catalogue of Prehistoric Works East of the Rocky Mountains, prepared by the late Dr. Cyrus Thomas and published as a bulletin of the bureau in 1891, but which passed out of print several years ago. In the fall of 1911 steps were taken toward undertaking this revision, and the bureau was fortunate at the outset in engaging the services of Mr. D. I. Bushnell, jr., of University, Virginia, as compiler of the work. Circular letters were dispatched to county clerks east of the Mississippi, who not only supplied direct information respecting aboriginal sites, but furnished the names of hundreds of collectors and others having personal knowledge of the subject, and to these special letters were addressed. By this means so much information of a local character was received in regard to the location of mounds, village and camp sites, shell heaps, quarries and workshops, pictographs, etc., in addition to that recorded in the Catalogue of Dr. Thomas, that the revised work gives promise of being a fairly complete Handbook of Aboriginal Remains East of the Mississippi. Besides finishing the collation of this material and of other data already in possession of the bureau, Mr. Bushnell has made good progress in extracting the information contained in various publications devoted to American archeology,

notably those by Mr. Clarence B. Moore on the mounds of the South. In this compilation the bureau has had the generous cooperation of Mr. Arthur C. Parker, State archeologist of New York, and of Mr. Warren K. Moorehead, curator of the department of archeology of Phillips Academy, Andover, Massachusetts, while others have kindly offered their aid. No date for the publication can yet be given.

PUBLICATIONS.

The editorial work of the bureau has been conducted under the immediate charge of Mr. J. G. Gurley, editor. The proof reading of the twenty-seventh annual report, the accompanying paper of which is a monograph entitled "The Omaha Tribe," by Alice C. Fletcher and Francis La Flesche, was completed and the report published.

The manuscript of the twenty-eighth annual report was edited and transmitted to the Public Printer. At the close of the year about one-third of this report was in page form, and the remainder was in process of paging. This report includes the following papers: Casa Grande, Arizona, by Dr. J. Walter Fewkes; Antiquities of the Upper Verde River and Walnut Creek Valley, Arizona, also by Dr. Fewkes, and Preliminary Report on the Linguistic Classification of Algonquian Tribes, by Dr. Truman Michelson.

The series of bulletins was increased by the addition of Bulletin 47, A Dictionary of the Biloxi and Ofo Languages, Accompanied by Thirty-one Biloxi Texts and Numerous Biloxi Phrases, by James Owen Dorsey and John R. Swanton.

Bulletin 49, List of Publications of the Bureau, was issued in a third impression.

Bulletin 40, Handbook of American Indian Languages, Part 2, was carried toward completion under the editorship of Dr. Franz Boas, as elsewhere stated, with the result that two sections, comprising 418 pages, dealing with the Takelma and Coos languages, are in substantially final form.

Toward the close of the year steps were taken to advance the work on Bulletin 46, Byington's Choctaw Dictionary, edited by Dr. John R. Swanton.

Considerable time was given to the editing and proof reading of Bulletin 52, Early Man in South America, by Aleš Hrdlička, in collaboration with W. H. Holmes, Bailey Willis, Fred. Eugene Wright, and Clarence N. Fenner. At the close of June the work was nearly through press.

The last bulletin to receive attention was No. 53—Chippewa Music—II, by Frances Densmore. Substantial progress on the preparation of the author's material for the press had been made at the close of the fiscal year.

The demand for the publications of the bureau continues to increase, and their distribution, numbering 15,003 copies during the year, necessitated extended correspondence. The distribution of the bureau publications has been under the immediate care of Miss Helen Munroe and Mr. E. L. Springer, of the Smithsonian Institution.

A concurrent resolution authorizing the reprinting of the Handbook of American Indians was introduced in the Senate and passed on May 11, 1912, and subsequently was favorably reported by the Committee on Printing of the House of Representatives, but it had not been passed at the close of the fiscal year.

ILLUSTRATIONS.

The preparation of the illustrations for the publications of the bureau and the photographing of the members of visiting delegations of Indians were conducted under the charge of Mr. De Lancey Gill, illustrator. In connection with this work 90 photographic negatives of Indians and 123 of ethnologic subjects were prepared; 196 films exposed by members of the bureau in the field were developed; 1,322 prints were made for publication and for exchange or distribution; and 110 pen and brush drawings were prepared. At the request of Mr. Wilberforce Eames, of the New York Public Library, a collection of 118 photographs of representative Indians, covering 55 tribes, was furnished by the bureau as a part of a loan exhibition opened at that library in May and was still on view at the close of the fiscal year.

Mr. Gill had the usual assistance of Henry Walther until February 16, 1912, when his services in behalf of the bureau for many years came to a close with his death. Mr. Walther has been succeeded by Walter A. Stenhouse.

LIBRARY.

Under the supervision of Miss Ella Leary the work of the library has made satisfactory progress. During the year 720 volumes (103 by purchase) and 300 pamphlets were received; in addition 620 periodical publications, of which 606 were acquired by exchange and the remainder by subscription, were accessioned. The recataloging of certain serial publications in the library has been continued, and attention given to the preparation of a subject catalogue of the large collection of pamphlets, many of which had been stored and therefore were inaccessible for three or four years. Successful effort has been made to complete the sets of certain publications of scientific societies and other learned institutions. For the use of the members of the staff the librarian has prepared and posted copies of a monthly bulletin of the library's principal accessions; and in order that the

large number of scientific serials received might also be made readily accessible, the current issues have been displayed on a table provided for that purpose.

Notwithstanding the increasing value of the bureau's library, it was found necessary, from time to time, to make requisition on the Library of Congress for the loan of books, the volumes thus received for temporary use numbering about 250. The volumes bound during the year numbered 492. At the close of the year the library contained approximately 17,970 volumes, about 12,500 pamphlets, and several thousand periodicals. Although maintained primarily as a reference library for the bureau's staff, it is constantly consulted by students not connected with the Smithsonian Institution and by officials of the executive departments and the Library of Congress.

COLLECTIONS.

The following collections were made by members of the staff of the bureau during their field researches:

By Mr. F. W. Hodge: Twenty-two paper squeezes of early and recent Spanish inscriptions on El Morro, or Inscription Rock, in New Mexico. Objects of stone, bone, clay, etc., from the cemetery of the ancient ruined pueblo of Kwasteyukwa on the mesa above the Jemez Hot Springs, New Mexico. Ten barrels of pottery and human skeletal remains from the same locality. These collections were made under a joint expedition conducted by the bureau and the School of American Archæology.

By Dr. John R. Swanton: Two ball sticks, one ball, one breech-cloth and belt, one tiger tail, from the Creek Indians at Coweta, Oklahoma.

By Mr. James Mooney: Four dance masks, two pairs of ball sticks, two toy baskets, two wooden spoons, one ox muzzle, one stone ax, one small celt, three arrowheads, from the Cherokee Indians of North Carolina.

By Mr. Francis La Flesche: Two sacred packs of the Osage Indians.

PROPERTY.

The most valuable part of the property of the bureau consists of its library, manuscripts (chiefly linguistic), and photographic negatives. The bureau possesses also cameras, photographic machines, and other ordinary apparatus and equipment for field work; stationery and office supplies; necessary office furniture; typewriters, etc., and the undistributed stock of its publications. The amount of \$342.27 was expended for office furniture during the year, while the cost of necessary books and periodicals was \$396.42.

As in the past, the manuscripts have been under the custodianship of Mr. J. N. B. Hewitt. Those withdrawn by collaborators of the bureau during the year numbered 234 items. The new manuscripts acquired are those hitherto mentioned in this report as having been prepared by members of the staff or by collaborators and designed for eventual publication. Negotiations have been entered into with the heirs of the late Señor Andomaro Molina, of Merida, Yucatan, for the return of Henderson's Maya Dictionary, a manuscript of six volumes lent to Señor Molina a number of years ago for use in connection with certain linguistic studies then contemplated in behalf of the bureau.

RECOMMENDATIONS.

I desire to repeat the recommendations submitted in my last annual report, respecting the extension of the researches of the bureau and for other purposes, and urging the appropriation of the necessary funds for conducting them. These include the following projects:

The exploration and preservation of antiquities in the arid region.

The extension of ethnologic researches in Alaska and among the tribes of the Mississippi Valley.

The preparation of a completely revised edition of the Handbook of American Indians.

Additional editorial assistance in preparing the publications of the bureau for the press.

A small sum to meet the expense of supplying photographs of Indian subjects to schools and colleges, and for other educational purposes, and for systematically making photographs in the field to illustrate the daily life and the ceremonies of the Indians.

In addition it is recommended that the systematic excavation and study of certain archeological sites in the South and West be conducted in order that archeological research may go hand in hand with the ethnological studies now being pursued in the same fields.

The reasons for extending the work of the bureau in the directions indicated are set forth more fully in the estimates of appropriations for the year 1914, in connection with which the sums regarded as necessary to the work are given.

Respectfully submitted.

F. W. HODGE,
Ethnologist in Charge.

Dr. CHARLES D. WALCOTT,
Secretary of the Smithsonian Institution.

APPENDIX 3.

REPORT ON THE INTERNATIONAL EXCHANGES.

SIR: I have the honor to submit the following report on the operations of the International Exchange Service during the fiscal year ending June 30, 1912:

The congressional appropriation for the support of the service during the year, including the allotment for printing and binding, was \$32,200 (the same amount as granted for the past four years), and the repayments for services rendered were \$4,391.02, making the total available resources for carrying on the system of international exchanges \$36,591.02.

The total number of packages handled during the year was 315,492—an increase over the number for the preceding year of 29,794. The weight of these packages was 568,712 pounds—a gain of 7,904 pounds. The increase in the volume of business, which has been continuous since the establishment of the service, is shown in the diagram on page 59.

The publications dispatched by the Exchange Service are classified under four heads: First, the Congressional Record; second, "Parliamentary documents"; third, "Departmental documents"; fourth, "Miscellaneous scientific and literary publications."

The term "Parliamentary documents," as here used, refers to publications set aside by law for exchange with foreign Governments, and includes not only copies of documents printed by order of either House of Congress, but copies of each publication issued by any department, bureau, commission, or officer of the Government. The object in sending these publications abroad is to procure for the use of the Congress of the United States a complete series of the publications of other Governments, and the returns are deposited in the Congressional Library.

The term "Departmental documents" embraces all the publications delivered at the Institution by the various Government departments, bureaus, or commissions, for distribution to their correspondents abroad from whom they desire to obtain similar publications in exchange. The publications received in return are deposited in the various departmental libraries.

The "Miscellaneous scientific and literary publications" are received chiefly from learned societies, universities, colleges, scientific

institutes, and museums in the United States, and transmitted to similar institutions in all parts of the world.

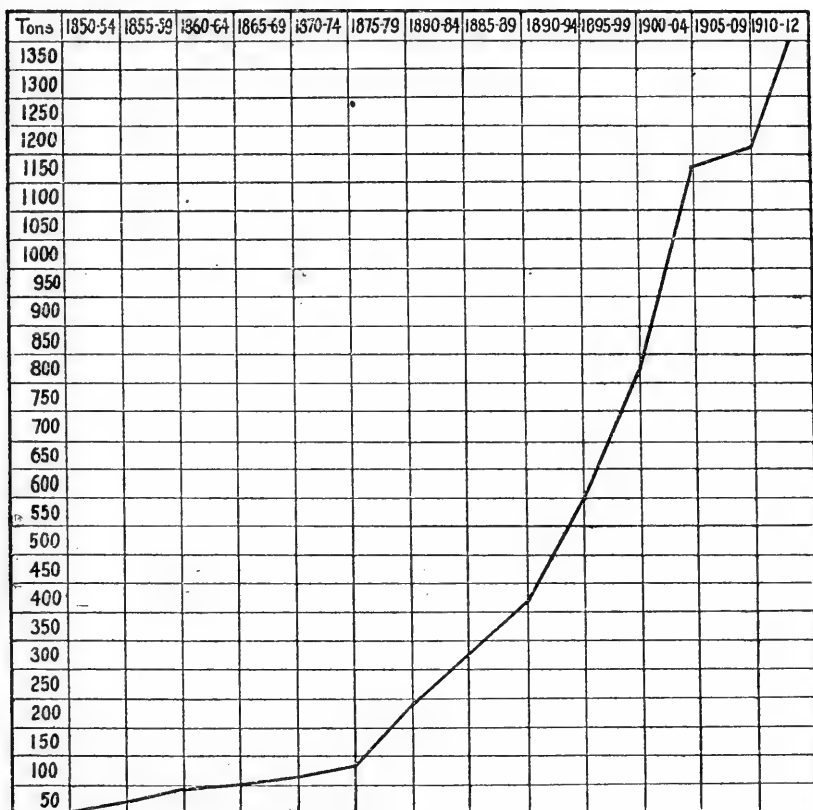

Diagram showing increase of exchange transmissions, in tons of 2,000 pounds, from 1850 to 1912, divided into periods of five years each.

For purposes of comparison, the number and weight of packages of different classes are indicated in the following table:

	Packages.		Weight.	
	Sent.	Received.	Sent.	Received.
United States parliamentary documents sent abroad	136,722	<i>Pounds.</i> 128,253	<i>Pounds.</i>
Publications received in return for parliamentary documents.....	2,425	17,794
United States departmental documents sent abroad	72,438	180,990
Publications received in return for departmental documents.....	9,452	19,113
Miscellaneous, scientific, and literary publications sent abroad..	56,110	113,593
Miscellaneous, scientific, and literary publications received from abroad for distribution in the United States.....	38,345	108,969
Total.....	265,270	50,222	422,836	145,876
Grand total.....	315,492		568,712	

The disparity indicated by the foregoing statistics between the number of packages sent and those received in behalf of the Government is accounted for, in part, by the fact that packages sent abroad contain, as a rule, only one publication, while those received in return often comprise many volumes, in some instances, especially in the case of publications received in return for parliamentary documents, the term "package" being applied to large boxes containing 100 or more separate publications, of which no lists are made in Washington, as the boxes are forwarded to their destinations unopened. Furthermore, many returns for publications sent abroad reach their destinations direct by mail and not through the Exchange Service.

Proper allowance being made for these circumstances, it is, nevertheless, apparently true that the publications of the United States Government sent to foreign countries greatly exceed in number those received by the Library of Congress and the several executive departments, bureaus, and independent offices. This in turn appears to be due mainly to the fact that most foreign Governments publish less extensively on scientific and other subjects than our own. The fiscal relations between the Government and scientific and other institutions are more complex in many countries than is the case in the United States, and the distinction between public documents and other publications is not so clear, especially where the printing for the Government is not centralized in one office or is not done by the Government itself.

While several of the departments and bureaus of our own Government have expressed themselves satisfied with the returns received through the Exchange Service, it is proposed to make a further investigation of this subject for the purpose of ascertaining whether some important publications and series of publications have not been overlooked, and also what proportion the number of the publications issued by certain European Governments in a given year bears to the number received by the departments and bureaus of the United States Government, and to the number sent to the former. It will be obvious that a debit and credit account is out of the question in a case of this kind. While a scientific or literary institution issues publications for the benefit of the whole world, a Government issues reports and other documents mainly for purposes of record and for the information of its own officers and its own citizens. The more largely the people are directly concerned in the Government, and the more extended its interests and activities, the greater will be the output of reports and other publications. Such a Government will have much more to offer than it can expect to receive in return from a smaller country.

As regards the exchange of miscellaneous scientific and literary publications, it will be noted that the weight in pounds of those

received into the United States through the Exchange Service during the fiscal year 1911 more than doubled the weight of those sent abroad, while the weight of those received during the fiscal year 1912, covered by this report, almost equalled that of those sent abroad. There is every reason, therefore, to believe that this important branch of the work yields adequate returns.

By referring to the foregoing table it will be noted that 70 per cent of the work of the office has been conducted in behalf of United States governmental establishments.

Of the 2,395 boxes used in forwarding exchanges to foreign bureaus and agencies for distribution (an increase of 15 boxes over 1911), 328 boxes contained full sets of United States official documents for authorized depositories and 2,067 were filled with departmental and other publications for depositories of partial sets and for miscellaneous correspondents. The number of boxes sent to each foreign country and the dates of transmission are shown in the following table:

Consignments of exchanges to foreign countries.

Country.	Number of boxes.	Date of transmission.
Argentina.....	36	July 15, Aug. 16, Sept. 20, Oct. 18, Nov. 23, Dec. 27, 1911; Jan. 20, Feb. 20, Mar. 22, Apr. 22, May 23, June 22, 1912.
Austria.....	83	July 12, Aug. 3, Sept. 7, Oct. 6, Nov. 14, Dec. 6, 1911; Jan. 10, Feb. 7, Mar. 6, Apr. 3, May 8, June 5, 1912.
Barbados.....	2	Mar. 27, June 27, 1912.
Belgium.....	62	July 8, 29, Aug. 12, 29, Sept. 23, Oct. 14, Nov. 4, 25, Dec. 16, 1911; Jan. 6, 27, Feb. 17, Mar. 16, 30, Apr. 27, May 18, June 8, 1912.
Bermuda.....	1	Feb. 15, 1912.
Bolivia.....	12	Aug. 29, Sept. 28, Nov. 13, 1911; Jan. 30, Feb. 24, Mar. 22, May 23, June 22, 1912.
Brazil.....	31	July 15, Aug. 16, Sept. 20, Oct. 18, Nov. 25, Dec. 27, 1911; Jan. 20, Feb. 20, Mar. 22, Apr. 22, May 23, June 22, 1912.
British Colonies.....	12	July 3, Aug. 12, 21, Sept. 2, Oct. 30, Nov. 4, 1911; Jan. 6, 20, 27, Apr. 27, June 8, 1912.
British Guiana.....	2	Jan. 30, June 29, 1912.
British Honduras.....	1	Jan. 30, 1912.
Bulgaria.....	3	July 28, Sept. 29, Nov. 7, 1911.
Canada.....	6	Aug. 10, Nov. 10, 1911; Jan. 10, Apr. 1, 25, June 1, 1912.
Cape Colony.....	12	Aug. 5, Nov. 7, 1911; Jan. 25, Apr. 15, May 31, June 27, 1912.
Chile.....	22	July 15, Aug. 16, Sept. 20, Oct. 18, Nov. 23, Dec. 27, 1911; Jan. 20, Feb. 20, Mar. 22, Apr. 22, May 24, June 22, 1912.
China.....	23	July 21, Aug. 26, Sept. 29, Nov. 4, Dec. 29, 1911; Jan. 31, Feb. 28, Mar. 27, Apr. 30, May 31, June 27, 1912.
Colombia.....	14	Aug. 21, Sept. 28, Nov. 23, 1911; Jan. 20, Feb. 20, Apr. 22, May 23, 1912.
Costa Rica.....	17	July 27, Aug. 21, Sept. 28, Oct. 27, Nov. 23, 1911; Jan. 20, Feb. 24, Apr. 22, May 23, June 22, 1912.
Cuba.....	6	Aug. 10, Nov. 10, 1911; Jan. 10, Apr. 1, 25, June 1, 1912.
Denmark.....	31	July 19, Aug. 24, Sept. 27, Oct. 19, Nov. 16, Dec. 19, 1911; Jan. 20, Feb. 20, Mar. 15, Apr. 15, May 20, June 20, 1912.
Ecuador.....	7	Aug. 29, Sept. 28, Nov. 13, 1911; Jan. 30, Feb. 24, Apr. 30, June 22, 1912.

Consignments of exchanges to foreign countries—Continued.

Country.	Number of boxes.	Date of transmission.
Egypt.....	13	July 22, Aug. 25, Sept. 26, Oct. 28, Nov. 25, 1911; Jan. 13, Feb. 3, Mar. 9, Apr. 6, May 4, June 8, 1912.
France.....	207	July 6, 26, Aug. 10, 24, Sept. 15, 28, Oct. 12, Nov. 1, 23, Dec. 8, 21, 1911; Jan. 4, 25, Feb. 8, 29, Mar. 14, 28, Apr. 4, 25, May 9, June 6, 27, 1912.
Germany.....	410	July 6, 11, 18, 25, Aug. 1, 8, 15, 22, 29, Sept. 3, 12, 19, 26, Oct. 3, 10, 17, 31, Nov. 7, 14, 21, 28, Dec. 5, 12, 19, 1911; Jan. 3, 9, 16, 23, 30, Feb. 6, 13, 20, 27, Mar. 5, 12, 19, 26, Apr. 2, 9, 16, 23, 30, May 7, 15, 21, 28, June 4, 11, 18, 25, 1912.
Great Britain and Ireland.	423	July 3, 8, 15, 22, 29, Aug. 5, 12, 19, 26, Sept. 2, 11, 18, 23, 30, Oct. 7, 14, 23, 30, Nov. 4, 11, 18, 25, Dec. 2, 9, 16, 27, 1911; Jan. 6, 13, 20, 27, Feb. 3, 10, 17, 24, Mar. 2, 9, 16, 23, 30, Apr. 6, 13, 20, 27, May 4, 11, 18, 25, June 1, 8, 15, 22, 29, 1912.
Greece.....	19	July 28, Aug. 29, Sept. 27, Nov. 7, Dec. 28, 1911; Jan. 25, Feb. 26, Mar. 27, Apr. 25, May 25, June 27, 1912.
Guatemala.....	8	July 27, Aug. 29, Sept. 28, Nov. 13, 1911; Jan. 30, Feb. 24, Apr. 30, June 22, 1912.
Haiti.....	6	Aug. 10, Nov. 10, 1911; Jan. 10, Apr. 1, 25, June 1, 1912.
Honduras.....	7	July 27, Sept. 28, Nov. 13, 1911; Jan. 30, Feb. 24, Apr. 30, June 22, 1912.
Hungary.....	39	July 12, Aug. 3, Sept. 7, Oct. 6, Nov. 14, Dec. 6, 1911; Jan. 10, Feb. 7, Mar. 6, Apr. 3, May 8, June 5, 1912.
India.....	38	July 3, 29, Aug. 5, 12, Sept. 2, 18, 23, Oct. 14, 23, 30, Nov. 4, 18, 25, 1911; Jan. 6, 20, 30, Feb. 17, 24, Mar. 9, 16, 23, 30, Apr. 13, 27, May 4, 18, June 8, 15, 22, 1912.
Italy.....	96	July 24, Aug. 5, Sept. 2, 25, Oct. 16, Nov. 11, 25, 1911; Jan. 13, Feb. 3, Mar. 9, Apr. 6, May 4, 18, June 8, 29, 1912.
Jamaica.....	8	July 27, Aug. 31, Sept. 29, Nov. 29, 1911; Jan. 30, Feb. 26, Apr. 30, June 27, 1912.
Japan.....	62	July 21, Aug. 26, Sept. 27, Oct. 20, Nov. 20, Dec. 28, 1911; Jan. 23, Feb. 21, Mar. 20, Apr. 20, May 20, June 20, 1912.
Korea.....	4	Sept. 29, 1911; Feb. 26, Mar. 27, June 27, 1912.
Liberia.....	5	July 27, Sept. 29, Nov. 13, 1911; Feb. 26, June 27, 1912.
Lourenco Marquez.....	2	Nov. 13, 1911; June 22, 1912.
Manitoba.....	6	Aug. 10, Nov. 10, 1911; Jan. 10, Apr. 1, 25, June 1, 1912.
Mexico.....	6	Aug. 10, Nov. 10, 1911; Jan. 10, Apr. 1, 25, June 1, 1912.
Montenegro.....	3	Nov. 13, 1911; Feb. 24, June 22, 1912.
Natal.....	2	Sept. 2, 1911; Feb. 24, 1912.
Netherlands.....	60	July 11, 29, Aug. 29, Sept. 19, Oct. 17, Nov. 14, 28, Dec. 12, 1911; Jan. 9, 30, Feb. 27, Mar. 12, 26, Apr. 9, 23, May 7, June 4, 25, 1912.
Newfoundland.....	2	Jan. 16, Apr. 11, 1912.
New South Wales.....	33	July 20, Aug. 22, Sept. 21, Oct. 28, Nov. 25, Dec. 21, 1911; Jan. 24, Feb. 15, Mar. 20, Apr. 20, May 20, June 20, 1912.
New Zealand.....	28	July 20, Aug. 22, Sept. 21, Oct. 28, Nov. 25, Dec. 21, 1911; Jan. 24, Feb. 15, Mar. 20, Apr. 20, May 20, June 20, 1912.
Nicaragua.....	5	Aug. 29, Sept. 28, 1911; Jan. 30, Feb. 24, June 22, 1912.
Norway.....	28	July 19, Aug. 24, Sept. 27, Oct. 19, Nov. 16, Dec. 19, 1911; Jan. 20, Feb. 20, Mar. 15, Apr. 15, May 20, June 20, 1912.
Ontario.....	6	Aug. 10, Nov. 10, 1911; Jan. 10, Apr. 1, 25, June 1, 1912.
Panama.....	3	Nov. 13, 1911; Feb. 24, June 22, 1912.
Palestine.....	4	Aug. 31, Nov. 29, 1911; June 27, 1912.
Peru.....	18	July 15, Aug. 16, Sept. 20, Oct. 18, Nov. 23, Dec. 27, 1911; Jan. 20, Feb. 20, Mar. 22, Apr. 22, May 23, June 22, 1912.
Portugal.....	19	July 19, Aug. 24, Sept. 27, Oct. 19, Nov. 16, Dec. 19, 1911; Jan. 20, Feb. 20, Mar. 15, Apr. 16, May 20, June 20, 1912.
Quebec.....	6	Aug. 10, Nov. 10, 1911; Jan. 10, Apr. 1, 25, June 1, 1912.

Consignments of exchanges to foreign countries—Continued.

Country.	Number of boxes.	Date of transmission.
Queensland.....	21	July 20, Aug. 22, Sept. 21, Oct. 28, Nov. 25, Dec. 21, 1911; Jan. 28, Feb. 15, Mar. 20, Apr. 20, May 20, June 20, 1912.
Roumania.....	10	July 28, Sept. 29, Nov. 7, 1911; Apr. 10, May 31, June 27, 1912.
Russia.....	81	July 13, Aug. 4, Sept. 7, Oct. 6, Nov. 11, Dec. 7, 1911; Jan. 11, Feb. 8, Mar. 7, Apr. 4, May 9, 29, 1912.
Salvador.....	7	Aug. 29, Sept. 28, Nov. 29, 1911; Jan. 30, Feb. 24, Apr. 30, June 22, 1912.
Santo Domingo.....	1	Sept. 29, 1911.
Servia.....	12	Aug. 29, Nov. 7, 1911; Jan. 24, May 7, June 27, 1912.
Siam.....	10	July 28, Oct. 10, Nov. 4, Dec. 29, 1911; Jan. 31, Feb. 26, Mar. 28, Apr. 30, May 31, June 29, 1912.
South Australia.....	19	July 20, Aug. 22, Sept. 21, Oct. 28, Nov. 25, Dec. 21, 1911; Jan. 24, Feb. 15, Mar. 20, Apr. 20, May 20, June 20, 1912.
Spain.....	30	July 22, Aug. 25, Sept. 26, Oct. 28, Nov. 25, 1911; Jan. 13, Feb. 3, Mar. 9, Apr. 6, May 4, June 8, 29, 1912.
Sweden.....	54	July 13, Aug. 4, Sept. 7, Oct. 6, Nov. 11, Dec. 7, 1911; Jan. 11, Feb. 8, Mar. 7, Apr. 4, May 6, June 6, 1912.
Switzerland.....	53	July 8, 29, Aug. 10, 29, Sept. 23, Oct. 14, Nov. 4, 25, Dec. 16, 1911; Jan. 6, 27, Feb. 16, Mar. 16, 30, Apr. 27, May 18, June 8, 1912.
Syria.....	4	Nov. 2, 1911; Feb. 5, 1912.
Tasmania.....	10	Oct. 30, Nov. 4, 1911; Jan. 6, Apr. 27, 1912.
Transvaal.....	19	July 27, Aug. 29, Sept. 28, Nov. 7, 1911; Jan. 25, Feb. 24, Mar. 27, Apr. 26, May 22, June 22, 1912.
Trinidad.....	4	Aug. 31, 1911; Jan. 30, Mar. 27, June 27, 1912.
Turkey.....	15	Aug. 30, Nov. 2, 1911; Jan. 31, Feb. 28, Mar. 28, Apr. 30, May 31, 1912.
Uruguay.....	19	July 15, Aug. 21, Sept. 20, Oct. 27, Nov. 23, Dec. 27, 1911; Jan. 20, Feb. 20, Mar. 22, Apr. 22, May 23, June 22, 1912.
Venezuela.....	14	Aug. 21, Sept. 28, Nov. 23, 1911; Jan. 20, Feb. 20, Apr. 22, May 23, June 23, 1912.
Victoria.....	33	July 20, Aug. 22, Sept. 21, Oct. 28, Nov. 25, Dec. 21, 1911; Jan. 24, Feb. 17, Mar. 20, Apr. 20, May 20, June 20, 1912.
Western Australia.....	20	July 22, 29, Aug. 5, 26, Sept. 2, 23, Oct. 7, 23, 30, Dec. 16, 1911; Jan. 6, 27, Mar. 16, Apr. 27, May 18, 1912.

For some years the Institution has been sending full sets of governmental documents to Cape Colony and the Transvaal and partial sets to Natal and the Orange River Colony. In May, 1912, a communication was received from the Secretary for the Interior of the Union of South Africa stating that since these Governments have now become Provinces of the Union, only one set of the publications would in future be required. In accordance with this request, the forwarding of official documents to the above-mentioned Provinces was discontinued, and one full series, beginning with box 133, is now transmitted to the Union of South Africa, addressed to the Secretary for the Interior, care of the Government Printer, Pretoria.

Packages containing scientific and literary publications received from individuals and establishments in the United States for transmission through the Exchange Service to miscellaneous addresses in the various Provinces of the Union of South Africa are now for-

warded to certain governmental establishments in those Provinces for distribution. The department of the interior of that country has been asked to undertake the distribution and also to forward to the United States such books as may be sent in return—the department acting in the same capacity for the Union of South Africa as this Exchange Service does for the United States.

Through the wrecking of the steamship *Papanui*, the Institution lost cases 117 and 158, containing exchanges for distribution in Western Australia by the Public Library at Perth. A number of packages sent in care of the director general of stores, India Office, London, were also lost at sea during the year, owing to the stranding of the steamer by which they were being transmitted to India. It is gratifying to state that the Institution has succeeded in procuring from the senders copies of most of the lost publications, which have been duly transmitted to their various destinations.

FOREIGN DEPOSITORIES OF UNITED STATES GOVERNMENTAL DOCUMENTS.

The number of sets of United States official publications regularly forwarded to foreign countries in accordance with treaty stipulations and under the authority of the congressional resolutions of March 2, 1867, and March 2, 1901, has been reduced from 89 to 86—one set instead of four now being forwarded to the Union of South Africa, to which reference is made above. This reduction in the number of sets transmitted abroad will be only temporary, as negotiations are now under way looking to the establishment of new exchanges.

The recipients of the 54 full and 32 partial sets are as follows:

DEPOSITORIES OF FULL SETS:

- Argentina: Ministerio de Relaciones Exteriores, Buenos Aires.
- Argentina: Biblioteca de la Universidad Nacional de La Plata.
- Australia: Library of the Commonwealth Parliament, Melbourne.
- Austria: K. K. Statistische Central-Commission, Vienna.
- Baden: Universitäts-Bibliothek, Freiburg.
- Bavaria: Königliche Hof- und Staats-Bibliothek, Munich.
- Belgium: Bibliothèque Royale, Brussels.
- Brazil: Bibliotheca Nacional, Rio de Janeiro.
- Canada: Parliamentary Library, Ottawa.
- Chile: Biblioteca del Congreso Nacional, Santiago.
- China: American-Chinese Publication Exchange Department, Shanghai Bureau of Foreign Affairs, Shanghai.
- Colombia: Biblioteca Nacional, Bogota.
- Costa Rica: Oficina de Depósito y Canje Internacional de Publicaciones, San José.
- Cuba: Secretaria de Estado (Asuntos Generales y Canje Internacional), Habana.
- Denmark: Kongelige Bibliotheket, Copenhagen.

England: British Museum, London.
 England: London School of Economics and Political Science, London.
 France: Bibliothèque Nationale, Paris.
 France: Préfecture de la Seine, Paris.
 Germany: Deutsche Reichstags-Bibliothek, Berlin.
 Greece: Bibliothèque Nationale, Athens.
 Haiti: Secrétairerie d'État des Relations Extérieures, Port au Prince.
 Hungary: Hungarian House of Delegates, Budapest.
 India: Department of Education (Books), Government of India, Calcutta.
 Ireland: National Library of Ireland, Dublin.
 Italy: Biblioteca Nazionale Vittorio Emanuele, Rome.
 Japan: Imperial Library of Japan, Tokyo.
 Manitoba: Provincial Library, Winnipeg.
 Mexico: Instituto Bibliográfico, Biblioteca Nacional, Mexico.
 Netherlands: Library of the States General, The Hague.
 New South Wales: Board for International Exchanges, Sydney.
 New Zealand: General Assembly Library, Wellington.
 Norway: Stortingets Bibliothek, Christiania.
 Ontario: Legislative Library, Toronto.
 Peru: Biblioteca Nacional, Lima.
 Portugal: Bibliotheca Nacional, Lisbon.
 Prussia: Königliche Bibliothek, Berlin.
 Quebec: Legislative Library, Quebec.
 Queensland: Parliamentary Library, Brisbane.
 Russia: Imperial Public Library, St. Petersburg.
 Saxony: Königliche Oeffentliche Bibliothek, Dresden.
 Servia: Section Administrative du Ministère des Affaires Etrangères, Belgrade.
 South Australia: Parliamentary Library, Adelaide.
 Spain: Servicio del Cambio Internacional de Publicaciones, Cuerpo Facultativo de Archiveros, Bibliotecarios y Arqueólogos, Madrid.
 Sweden: Kungliga Biblioteket, Stockholm.
 Switzerland: Bibliothèque Fédérale, Berne.
 Tasmania: Parliamentary Library, Hobart.
 Turkey: Department of Public Instruction, Constantinople.
 Union of South Africa: Department of the Interior, Pretoria, Transvaal.
 Uruguay: Oficina de Canje Internacional de Publicaciones, Montevideo.
 Venezuela: Biblioteca Nacional, Caracas.
 Victoria: Public Library, Melbourne.
 Western Australia: Public Library of Western Australia, Perth.
 Württemberg: Königliche Landesbibliothek, Stuttgart.

DEPOSITORIES OF PARTIAL SETS.

Alberta: Legislative Library, Edmonton.
 Alsace-Lorraine: K. Ministerium für Elsass-Lothringen, Strassburg.
 Bolivia: Ministerio de Colonización y Agricultura, La Paz.
 Bremen: Senatskommission für Reichs- und Auswärtige Angelegenheiten.
 British Columbia: Legislative Library, Victoria.
 Bulgaria: Minister of Foreign Affairs, Sofia.
 Ceylon: United States Consul, Colombo.
 Ecuador: Biblioteca Nacional, Quito.
 Egypt: Bibliothèque Khédiviale, Cairo.
 Guatemala: Secretary of the Government, Guatemala.

Hamburg: Senatskommission für die Reichs- und Auswärtigen Angelegenheiten.
 Hesse: Grossherzogliche Hof-Bibliothek, Darmstadt.
 Honduras: Secretary of the Government, Tegucigalpa.
 Jamaica: Colonial Secretary, Kingston.
 Liberia: Department of State, Monrovia.
 Lourenço Marquez: Government Library, Lourenço Marquez.
 Malta: Lieutenant Governor, Valetta.
 Montenegro: Ministère des Affaires Étrangères, Cetinje.
 New Brunswick: Legislative Library, Fredericton.
 Newfoundland: Colonial Secretary, St. John's.
 Nicaragua: Superintendente de Archivos Nacionales, Managua.
 Northwest Territories: Government Library, Regina.
 Nova Scotia: Provincial Secretary of Nova Scotia, Halifax.
 Panama: Secretaria de Relaciones Exteriores, Panama.
 Paraguay: Oficina General de Inmigracion, Asuncion.
 Prince Edward Island: Legislative Library, Charlottetown.
 Roumania: Academia Romana, Bucarest.
 Salvador: Ministerio de Relaciones Exteriores, San Salvador.
 Siam: Department of Foreign Affairs, Bangkok.
 Straits Settlements: Colonial Secretary, Singapore.
 United Provinces of Agra and Oudh: Under Secretary to Government, Allahabad.
 Vienna: Bürgermeister der Haupt- und Residenz-Stadt.

No countries were added during the year to the list of those with which the immediate exchange of official parliamentary journals is carried on. While the number of countries at present taking part in this exchange with the United States is 29, the total number of copies of the Congressional Record transmitted is 34—2 copies being sent to some of the countries, 1 to the upper and 1 to the lower House of Parliament.

The Records are received from the Government Printing Office on the morning following the date of their issue. They are at once placed in envelopes and forwarded to their destinations by mail.

A complete list of countries to which the Congressional Record is now sent is given below:

Argentine Republic.	Great Britain.	Roumania.
Australia.	Greece.	Russia.
Austria.	Guatemala.	Servia.
Baden.	Honduras.	Spain.
Belgium.	Hungary.	Switzerland.
Brazil.	Italy.	Transvaal.
Canada.	New South Wales.	Union of South Africa.
Cuba.	New Zealand.	Uruguay.
Denmark.	Portugal.	Western Australia.
France.	Prussia.	

LIST OF BUREAUS OR AGENCIES THROUGH WHICH EXCHANGES ARE TRANSMITTED.

The following is a list of bureaus or agencies through which the distribution of exchanges is effected. Those in the larger and many in the smaller countries forward to the Smithsonian Institution, in return, contributions for distribution in the United States:

Algeria, via France.

Angola, via Portugal.

Argentina: Comisión Protectora de Bibliotecas Populares, Reconquista 538, Buenos Aires.

Austria: K. K. Statistische Central-Commission, Vienna.

Azores, via Portugal.

Belgium: Service Belge des Échanges Internationaux, Rue du Musée 5, Brussels.

Bolivia: Oficina Nacional de Estadística, La Paz

Brazil: Serviço de Permutações Internacionais, Bibliotheca Nacional, Rio de Janeiro.

British Colonies: Crown Agents for the Colonies, London.¹

British Guiana: Royal Agricultural and Commercial Society, Georgetown.

British Honduras: Colonial Secretary, Belize.

Bulgaria: Instituições Scientifiques de S. M. le Roi de Bulgarie, Sofia.

Canary Islands, via Spain.

Cape Colony: Government Stationery Department, Cape Town.

Chile: Servicio de Canjes Internacionales, Biblioteca Nacional, Santiago.

China: Zi-ka-wei Observatory, Shanghai.

Colombia: Oficina de Canjes Internacionales y Reparto, Biblioteca Nacional, Bogota.

Costa Rica: Oficina de Depósito y Canje Internacional de Publicaciones, San José.

Denmark: Kongelige Danske Videnskabernes Selskab, Copenhagen.

Dutch Guiana: Surinaamsche Koloniale Bibliotheek, Paramaribo.

Ecuador: Ministerio de Relaciones Exteriores, Quito.

Egypt: Director-General, Survey Department, Giza (Mudiria).

France: Service Français des Echanges Internationaux, 110 Rue de Grenelle, Paris.

Germany: Amerika-Institut, Berlin, N. W. 7.

Great Britain and Ireland: Messrs. William Wesley & Son, 28 Essex Street, Strand, London.

Greece: Bibliothèque Nationale, Athens.

Greenland, via Denmark.

Guadeloupe, via France.

Guatemala: Instituto Nacional de Varones, Guatemala.

Guinea, via Portugal.

Haiti: Secrétaire d'Etat des Relations Extérieures, Port au Prince.

Honduras: Biblioteca Nacional, Tegucigalpa.

Hungary: Dr. Julius Pikler, Municipal Office of Statistics, City Hall, Budapest.

Iceland, via Denmark.

India: India Store Department, India Office, London.

Italy: Ufficio degli Scambi Internazionali, Biblioteca Nazionale Vittorio Emanuele, Rome.

¹This method is employed for communicating with several of the British colonies with which no medium is available for forwarding exchanges direct.

- Jamaica: Institute of Jamaica, Kingston.
- Japan: Imperial Library of Japan, Tokyo.
- Java, via Netherlands.
- Korea: His Imperial Japanese Majesty's Residency-General, Seoul.
- Liberia: Department of State, Monrovia.
- Lourenço Marquez: Government Library, Lourenço Marquez.
- Luxemburg, via Germany.
- Madagascar, via France.
- Madeira, via Portugal.
- Montenegro: Ministère des Affaires Étrangères, Cetinje.
- Mozambique, via Portugal.
- Natal: High Commissioner for the Union of South Africa, London.
- Netherlands: Bureau Scientifique Central Néerlandais, Bibliothèque de l'Université, Leyden.
- New Guinea, via Netherlands.
- New South Wales: Board for International Exchanges, Public Library, Sydney.
- New Zealand: Dominion Museum, Wellington.
- Nicaragua: Ministerio de Relaciones Exteriores, Managua.
- Norway: Kongelige Norske Frederiks Universitet Bibliotheket, Christiania.
- Panama: Secretaria de Relaciones Exteriores, Panama.
- Paraguay: Ministerio de Relaciones Exteriores, Asuncion.
- Persia: Board of Foreign Missions of the Presbyterian Church, New York City.
- Peru: Oficina de Reparto, Depósito y Canje Internacional de Publicaciones, Ministerio de Fomento, Lima.
- Portugal: Serviço de Permutações Internacionaes, Bibliotheca Nacional, Lisbon.
- Queensland: Chief Secretary's Office, Brisbane.
- Russia: Commission Russe des Echanges Internationaux, Bibliothèque Impériale Publique, St. Petersburg.
- Salvador: Ministerio de Relaciones Exteriores, San Salvador.
- Servia: Section Administrative du Ministère des Affaires Etrangères, Belgrade.
- Siam: Department of Foreign Affairs, Bangkok.
- South Australia: Public Library of South Australia, Adelaide.
- Spain: Servicio del Cambio Internacional de Publicaciones, Cuerpo Facultativo de Archiveros, Bibliotecarios y Arqueólogos, Madrid.
- Sumatra, via Netherlands.
- Sweden: Kongliga Svenska Vetenskaps Akademien, Stockholm.
- Switzerland: Service des Echanges Internationaux, Bibliothèque Fédérale Centrale, Bern.
- Syria: Board of Foreign Missions of the Presbyterian Church, New York.
- Tasmania: Royal Society of Tasmania, Hobart.
- Transvaal: Government Library, Pretoria.
- Trinidad: Victoria Institute, Port of Spain.
- Tunis, via France.
- Turkey: American Board of Commissioners for Foreign Missions, Boston.
- Uruguay: Oficina de Canje Internacional, Montevideo.
- Venezuela: Biblioteca Nacional, Caracas.
- Victoria: Public Library of Victoria, Melbourne.
- Western Australia: Public Library of Western Australia, Perth.
- Windward and Leeward Islands: Imperial Department of Agriculture, Bridgetown, Barbados.

Table showing the number of institutions and individuals in foreign countries to which packages were transmitted through the International Exchange Service during the first six months of the fiscal year 1912.

	Organi- zations.	Individ- uals.		Organi- zations.	Individ- uals.
Africa:			America (North)—Contd.		
Algeria.....	13	25	West Indies—Contd.		
Angola.....	1		St. Lucia.....	1	
Azores.....	4	1	St. Thomas.....	1	
Canary Islands.....	2		St. Vincent.....	1	1
Cape Colony.....	38	30	San Domingo.....	4	2
East Africa and Uganda Protectorates.....	4	7	Trinidad.....	8	8
Egypt.....	21	15	America (South):		
German East Africa.....	3	2	Argentina.....	65	95
Gold Coast.....	1	1	Bolivia.....	9	6
Lagos.....	1	1	Brazil.....	63	55
Liberia.....	5	7	British Guiana.....	6	4
Lourenço Marquez.....	2	1	Chile.....	38	40
Madagascar.....	3		Colombia.....	13	6
Madeira.....	1	1	Dutch Guiana.....	2	
Mauritius.....	7	3	Ecuador.....	9	15
Morocco.....		1	French Guiana.....		1
Natal.....	17	14	Paraguay.....	10	3
Orange Free State.....	3	8	Peru.....	28	24
Reunion.....	4	2	Uruguay.....	19	13
Rhodesia.....	2	11	Venezuela.....	13	11
St. Helena.....	1		Asia:		
Sierra Leone.....	3	2	Burma.....	3	6
Transvaal.....	22	31	Ceylon.....	12	8
Tripoli.....		3	China.....	24	64
Tunis.....	4	6	Cyprus.....	3	1
Zanzibar.....	1		French East Indies.....	1	
America (North):			Hongkong.....	7	3
Canada.....	131	323	India.....	122	85
Central America—			Indo-China.....	5	4
British Honduras.....	6	6	Japan.....	95	155
Costa Rica.....	11	10	Korea.....	2	8
Guatemala.....	10	6	Macao.....	1	
Honduras.....	6	6	Malasia—		
Nicaragua.....	4	10	Java.....	17	13
Panama.....	1	10	Philippine Islands.....	3	1
Salvador.....	11	10	Sarawak.....	2	
Greenland.....	1		Persia.....		2
Mexico.....	48	70	Siam.....	3	4
Newfoundland.....	7	3	Straits Settlements.....	14	8
West Indies—			Australasia:		
Antigua.....	3	1	New South Wales.....	50	59
Bahamas.....	4	1	New Zealand.....	45	62
Barbados.....	7	9	Queensland.....	30	22
Bermudas.....	2	6	South Australia.....	25	24
Cuba.....	20	11	Tasmania.....	19	11
Dominica.....	1		Victoria.....	65	67
Grenada.....	1		Western Australia.....	23	15
Haiti.....	2		Europe:		
Jamaica.....	10	9	Austria-Hungary.....	293	424
St. Christopher.....	1		Belgium.....	153	116
			Bulgaria.....	10	9

Table showing the number of institutions and individuals in foreign countries to which packages were transmitted through the International Exchange Service during the first six months of the fiscal year 1912—Continued.

	Organi- zations.	Individ- uals.		Organi- zations.	Individ- uals.
Europe—Continued.			Europe—Continued.		
Denmark.....	51	48	Russia.....	217	256
France.....	682	702	Servia.....	10	2
Germany.....	957	1,233	Spain.....	75	62
Great Britain.....	1,012	1,794	Sweden.....	91	127
Greece.....	18	17	Switzerland.....	48	154
Iceland.....	7	5	Turkey.....	20	28
Italy.....	350	312	Polynesia:		
Luxemburg.....	6	Fiji Islands.....	1	1
Malta.....	6	1	New Hebrides.....	1
Montenegro.....	1			
Netherlands.....	104	139	Total correspondents,		
Norway.....	62	61	July 1, 1911, to Jan. 1,		
Portugal.....	36	14	1912.....	5,535	7,073
Roumania.....	24	9			

Respectfully submitted.

F. W. TRUE,
*Assistant Secretary in charge
of Library and Exchanges.*

DR. CHARLES D. WALCOTT,
Secretary of the Smithsonian Institution.

OCTOBER 7, 1912.

APPENDIX 4.

REPORT ON THE NATIONAL ZOOLOGICAL PARK.

SIR: I have the honor to submit herewith a report of the operations of the National Zoological Park for the fiscal year ending June 30, 1912.

The general appropriation made by Congress for the improvement and maintenance of the park during that year was \$100,000. The cost of maintenance was \$86,132, being materially increased over that of the previous year mainly because of the advance in prices of forage and other food supplies, the expenditure for which amounted to \$21,175. A few small increases were made in the compensation of employees, but nothing to correspond with the great increase in the cost of living which has occurred during recent years.

ACCESSIONS.

Among these the most important were 2 elephant seals and 4 northern fur seals from the United States Bureau of Fisheries, 8 white pelicans from Lieut. Col. L. M. Brett, acting superintendent of the Yellowstone National Park, and a pair of American tapirs, which, with certain other animals, were received in exchange, as noted below. The accessions included about 25 species not already represented in the collection. Mammals and birds born and hatched numbered 108, and included American tapir, yak, American bison, harnessed antelope, Barasingha deer, llama, mona monkey, hairy armadillo, wild turkey, and Florida cormorant.

EXCHANGES.

The most important accession from this source was a shipment received in November, 1911, from the Municipal Zoological Garden at Buenos Aires, Argentine Republic, which comprised 23 animals and included a pair each of Brazilian tapirs, Patagonian cavies, and Chilean eagles, with other interesting mammals and birds. A sambar deer was received from the New York Zoological Park, and a considerable number of specimens from dealers.

ANIMALS IN THE COLLECTION JUNE 30, 1912.

MAMMALS.

Grivet monkey (<i>Cercopithecus sabæus</i>)	1	African palm civet (<i>Viverra civetta</i>)	1
Green monkey (<i>Cercopithecus callitrichus</i>)	1	Common genet (<i>Genetta genetta</i>)	2
Mona monkey (<i>Cercopithecus mona</i>)	3	Sudan lion (<i>Felis leo</i>)	2
Diana monkey (<i>Cercopithecus diana</i>)	2	Kilimanjaro lion (<i>Felis leo sabakiensis</i>)	5
Sooty mangabey (<i>Cercocebus fuliginosus</i>)	2	Tiger (<i>Felis tigris</i>)	1
Bonnet monkey (<i>Macacus sinicus</i>)	1	Cougar (<i>Felis oregonensis hippolestes</i>)	1
Macaque monkey (<i>Macacus cynomolgus</i>)	4	Jaguar (<i>Felis onca</i>)	1
Pig-tailed monkey (<i>Macacus nemestrinus</i>)	4	Mexican jaguar (<i>Felis onca goldmani</i>)	1
Rhesus monkey (<i>Macacus rhesus</i>)	27	Leopard (<i>Felis pardus</i>)	2
Brown macaque (<i>Macacus arctoides</i>)	3	Black leopard (<i>Felis pardus</i>)	1
Japanese monkey (<i>Macacus fuscatus</i>)	3	Serval (<i>Felis serval</i>)	1
Formosan rock-macaque (<i>Macacus cyclops</i>)	1	Ocelot (<i>Felis pardalis</i>)	1
Chacma (<i>Papio porcarius</i>)	1	Canada lynx (<i>Lynx canadensis</i>)	1
Mandrill (<i>Papio maimon</i>)	4	Bay lynx (<i>Lynx rufus</i>)	5
White-throated capuchin monkey (<i>Cebus hypoleucus</i>)	1	Spotted lynx (<i>Lynx rufus texensis</i>)	2
Brown monkey (<i>Cebus fuscus</i>)	1	Florida lynx (<i>Lynx rufus floridanus</i>)	1
Marmoset (<i>Hapale jacchus</i>)	1	Steller's sea lion (<i>Eumetopias stelleri</i>)	1
Ruffed lemur (<i>Lemur varius</i>)	2	California sea lion (<i>Zalophus californianus</i>)	2
Ring-tailed lemur (<i>Lemur catta</i>)	1	Northern fur seal (<i>Callotaria alascanus</i>)	2
Polar bear (<i>Thalarectos maritimus</i>)	3	Harbor seal (<i>Phoca vitulina</i>)	2
European brown bear (<i>Ursus arctos</i>)	2	Fox squirrel (<i>Sciurus niger</i>)	9
Kadiak bear (<i>Ursus middendorffi</i>)	1	Western fox squirrel (<i>Sciurus ludovicianus</i>)	8
Yakutat bear (<i>Ursus dalli</i>)	1	Gray squirrel (<i>Sciurus carolinensis</i>)	40
Alaskan brown bear (<i>Ursus gyas</i>)	3	Black squirrel (<i>Sciurus carolinensis</i>)	20
Hybrid bear (<i>Ursus gyas-arctos</i>)	1	Albino squirrel (<i>Sciurus carolinensis</i>)	1
Kidder's bear (<i>Ursus kidderi</i>)	2	Panama squirrel	1
Himalayan bear (<i>Ursus thibetanus</i>)	1	Prairie dog (<i>Cynomys ludovicianus</i>)	25
Grizzly bear (<i>Ursus horribilis</i>)	4	Woodchuck (<i>Arctomys monax</i>)	7
Black bear (<i>Ursus americanus</i>)	9	Albino woodchuck (<i>Arctomys monax</i>)	1
Cinnamon bear (<i>Ursus americanus</i>)	3	Black woodchuck (<i>Arctomys monax</i>)	1
Sloth bear (<i>Melursus ursinus</i>)	1	Alpine marmot (<i>Arctomys marmotta</i>)	3
Kinkajou (<i>Cercoptes caudivolvulus</i>)	1	American beaver (<i>Castor canadensis</i>)	3
Cacomistle (<i>Bassariscus astuta</i>)	1	Coyu (<i>Myocastor coypus</i>)	2
Gray coatimundi (<i>Nasua narica</i>)	3	Hutia-conga (<i>Capromys pilorides</i>)	2
Raccoon (<i>Procyon lotor</i>)	17	Indian porcupine (<i>Hystrix leucura</i>)	2
American badger (<i>Taxidea americana</i>)	3	Mexican agouti (<i>Dasyprocta macricana</i>)	1
Common skunk (<i>Mephitis mephitis</i>)	3	Azara's agouti (<i>Dasyprocta azaræ</i>)	2
American marten (<i>Mustela americana</i>)	3	Crested agouti (<i>Dasyprocta cristata</i>)	2
Fisher (<i>Mustela pennantii</i>)	1	Hairy-rumped agouti (<i>Dasyprocta prymnolopha</i>)	4
Mink (<i>Putorius vison</i>)	5	Paca (<i>Catagenys paca</i>)	2
Common ferret (<i>Putorius putorius</i>)	1	Guinea pig (<i>Cavia cutleri</i>)	13
Black-footed ferret (<i>Putorius nigripes</i>)	2	Patagonian cavy (<i>Dolichotis patagonica</i>)	3
North American otter (<i>Lutra canadensis</i>)	5	Domestic rabbit (<i>Lepus cuniculus</i>)	37
Eskimo dog (<i>Canis familiaris</i>)	2	Cape hyrax (<i>Procavia capensis</i>)	1
Dingo (<i>Canis dingo</i>)	2	Indian elephant (<i>Elephas maximus</i>)	1
Gray wolf (<i>Canis occidentalis</i>)	4	Brazilian tapir (<i>Tapirus americanus</i>)	4
Black wolf (<i>Canis occidentalis</i>)	1	Grevy's zebra (<i>Equus grevyi</i>)	1
Coyote (<i>Canis latrans</i>)	4	Zebra-donkey hybrid (<i>Equus grevyi-asinus</i>)	1
Woodhouse's coyote (<i>Canis frustror</i>)	3	Grant's zebra (<i>Equus burchelli granti</i>)	1
Crab-eating dog (<i>Canis cancrivorus</i>)	1	Collared peccary (<i>Dicotyles angulatus</i>)	6
Red fox (<i>Vulpes pennsylvanicus</i>)	4	Wild boar (<i>Sus scrofa</i>)	2
Swift fox (<i>Vulpes velox</i>)	2	Northern wart hog (<i>Phacochoerus africanus</i>)	2
Arctic fox (<i>Vulpes lagopus</i>)	2	Hippopotamus (<i>Hippopotamus amphibius</i>)	1
Gray fox (<i>Urocyon cinereo-argenteus</i>)	5		
Striped hyena (<i>Hyæna striata</i>)	1		

Animals in the collection June 30, 1912—Continued.

MAMMALS—Continued.

Guanaco (<i>Lama huanachus</i>)-----	3	Indian antelope (<i>Antilope cervicapra</i>)--	3
Llama (<i>Lama glama</i>)-----	8	Nilgai (<i>Boselaphus tragocamelus</i>)-----	2
Alpaca (<i>Lama pacos</i>)-----	2	Congo harness antelope (<i>Tragelaphus</i>	
Vicugna (<i>Lama vicugna</i>)-----	2	<i>gratus</i>)-----	2
Bactrian camel (<i>Camelus bactrianus</i>)--	3	East African eland (<i>Oreos canna pat-</i>	
Muntjac (<i>Cervulus muntjac</i>)-----	1	<i>tersonianus</i>)-----	1
Sambar deer (<i>Cervus aristotelis</i>)-----	2	Chamois (<i>Rupicapra tragus</i>)-----	2
Philippine deer (<i>Cervus philippinus</i>)--	1	Tahr (<i>Hemitragus jemlaicus</i>)-----	7
Hog deer (<i>Cervus porcinus</i>)-----	6	Common goat (<i>Capra hircus</i>)-----	8
Barasingha deer (<i>Cervus duvaucelii</i>)--	10	Angora goat (<i>Capra hircus</i>)-----	5
Axis deer (<i>Cervus axis</i>)-----	6	Barbary sheep (<i>Ovis tragelaphus</i>)-----	12
Japanese deer (<i>Cervus sika</i>)-----	10	Barbados sheep (<i>Ovis aries-tragela-</i>	
Red deer (<i>Cervus elaphus</i>)-----	6	<i>phus</i>)-----	13
American elk (<i>Cervus canadensis</i>)-----	7	Anoa (<i>Anoa depressicornis</i>)-----	1
Fallow deer (<i>Cervus dama</i>)-----	6	East African buffalo (<i>Buffelus neu-</i>	
Reindeer (<i>Rangifer tarandus</i>)-----	1	<i>manni</i>)-----	1
Virginia deer (<i>Odocoileus virginianus</i>)--	9	Zebu (<i>Bibos indicus</i>)-----	3
Mule deer (<i>Odocoileus hemionus</i>)-----	1	Yak (<i>Poephagus grunnicus</i>)-----	3
Columbian black-tailed deer (<i>Odocoi-</i>		American bison (<i>Bison americanus</i>)--	14
<i>leus columbianus</i>)-----	1	Hairy armadillo (<i>Dasyppus villosus</i>)--	3
Cuban deer (<i>Odocoileus sp.</i>)-----	1	Wallaroo (<i>Macropus robustus</i>)-----	2
Prong-horn antelope (<i>Antilocapra</i>		Bennett's wallaby (<i>Macropus ruficollis</i>	
<i>americana</i>)-----	1	<i>bennetti</i>)-----	1
Coke's hartebeest (<i>Beatlis cokei</i>)-----	2	Virginia opossum (<i>Didelphys marsu-</i>	
Bontebok (<i>Damaliscus pygargus</i>)-----	1	<i>pialis</i>)-----	2
Blessbok (<i>Damaliscus albifrons</i>)-----	1	Common wombat (<i>Phascolomys mitch-</i>	
White-tailed gnu (<i>Conochætæts gnu</i>)--	1	<i>elli</i>)-----	1
Defassa water buck (<i>Cobus defassa</i>)--	1		

BIRDS.

European blackbird (<i>Merula merula</i>)--	1	Red-crested cardinal (<i>Paroaria cucul-</i>	
Brown thrasher (<i>Toxostoma rufum</i>)--	1	<i>lata</i>)-----	10
Japanese robin (<i>Liothrix luteus</i>)-----	12	Common cardinal (<i>Cardinalis cardi-</i>	
White-cheeked bulbul (<i>Pycnonotus leu-</i>		<i>nalis</i>)-----	1
<i>cogengs</i>)-----	5	Siskin (<i>Spinus spinus</i>)-----	8
Black bulbul (<i>Pycnonotus pygæus</i>)--	3	European goldfinch (<i>Carduelis eleqans</i>)--	3
Laughing thrush (<i>Garrular leuco</i>		Yellow hammer (<i>Emberiza citrinella</i>)--	1
<i>lophus</i>)-----	2	Common canary (<i>Serinus canarius</i>)--	15
Bishop finch (<i>Tanagra episcopus</i>)-----	4	Linnet (<i>Linota cannabina</i>)-----	4
Orange-checked waxbill (<i>Estrellda mel-</i>		Bullfinch (<i>Pyrrhula europæa</i>)-----	10
<i>podæ</i>)-----	6	Hooded oriole (<i>Icterus cucullatus</i>)--	3
Amaduvade finch (<i>Estrellda amandava</i>)--	4	Cowbird (<i>Molothrus ater</i>)-----	1
Cordon-bleu (<i>Estreida phænicotis</i>)--	8	Glossy starling (<i>Lamprotornis cau-</i>	
Magpie finch (<i>Spermestes fringilloides</i>)--	10	<i>datus</i>)-----	1
Cut-throat finch (<i>Amadina fasciata</i>)--	11	European raven (<i>Corvus corax</i>)-----	1
Zebra finch (<i>Amadina castanotis</i>)-----	4	American raven (<i>Corvus corax sinua-</i>	
Black-headed finch (<i>Munia atricapilla</i>)--	11	<i>tus</i>)-----	1
Three-colored finch (<i>Munia malacca</i>)--	7	Common crow (<i>Corvus brachyrhyn-</i>	
White-headed finch (<i>Munia maja</i>)-----	9	<i>chos</i>)-----	2
Nutmeg finch (<i>Munia punctularia</i>)--	6	Green jay (<i>Xanthoura luxuriosa</i>)-----	1
Java sparrow (<i>Munia oryzivora</i>)-----	14	White-throated jay (<i>Garrulus leucotis</i>)--	2
White Java sparrow (<i>Munia cryzivora</i>)--	15	Blue jay (<i>Cyanocitta cristata</i>)-----	3
Chestnut-breasted finch (<i>Donacola</i>		American magpie (<i>Pica pica hud-</i>	
<i>castancothorax</i>)-----	10	<i>sonica</i>)-----	1
Parson finch (<i>Poëphila cincta</i>)-----	1	Red-billed magpie (<i>Urocissa occipi-</i>	
Lady Gould's finch (<i>Poëphila gouldiæ</i>)--	1	<i>talis</i>)-----	2
Bearded finch (<i>Spermophila sp.</i>)-----	2	Piping crow (<i>Gymnorhina tibicen</i>)-----	2
Napoleon weaver (<i>Pyromclana afra</i>)--	4	Yellow tyrant (<i>Pitangus derbianus</i>)--	2
Madagascar weaver (<i>Foudia madagas-</i>		Giant kingfisher (<i>Dacelo gigas</i>)-----	1
<i>caricensis</i>)-----	8	Yellow-breasted toucan (<i>Ramphastos</i>	
Red-billed weaver (<i>Quelea quelea</i>)--	8	<i>carinatus</i>)-----	3
Whydah weaver (<i>Vidua paradisica</i>)--	16	Sulphur-crested cockatoo (<i>Cacatua gal-</i>	
Painted bunting (<i>Passerina ciris</i>)-----	1	<i>erita</i>)-----	3

Animals in the collection June 30, 1912—Continued.

BIRDS—Continued.

White cockatoo (<i>Cacatua alba</i>)-----	6	South American condor (<i>Sarcorhamphus gryphus</i>)-----	2
Leadbeater's cockatoo (<i>Cacatua leadbeateri</i>)-----	1	California condor (<i>Gymnogyps californianus</i>)-----	3
Bare-eyed cockatoo (<i>Cacatua gymnopsis</i>)-----	2	Griffon vulture (<i>Gyps fulvus</i>)-----	2
Roseate cockatoo (<i>Cacatua roseicapilla</i>)-----	3	Cinereous vulture (<i>Vultur monachus</i>)-----	2
Gang-gang cockatoo (<i>Callocephalon galcatum</i>)-----	1	Egyptian vulture (<i>Neophron percnopterus</i>)-----	1
Yellow and blue macaw (<i>Ara araucana</i>)-----	2	Turkey vulture (<i>Cathartes aura</i>)-----	5
Red and yellow and blue macaw (<i>Ara macao</i>)-----	3	Black vulture (<i>Catharista urubí</i>)-----	2
Red and blue macaw (<i>Ara chloroptera</i>)-----	3	King vulture (<i>Gypagus papa</i>)-----	2
Great green macaw (<i>Ara militaris</i>)-----	1	Ring dove (<i>Columba palumbus</i>)-----	14
Kea (<i>Nestor notabilis</i>)-----	1	Snow pigeon (<i>Columba leucozona</i>)-----	4
Mexican conure (<i>Conurus holochlorus</i>)-----	1	Red-billed pigeon (<i>Columba flaviventris</i>)-----	4
Carolina parrot (<i>Conuropsis carolinensis</i>)-----	2	Mourning dove (<i>Zenaidura macroura</i>)-----	8
Cuban parrot (<i>Amazona leucocephala</i>)-----	2	Peaceful dove (<i>Geopelia tranquilla</i>)-----	2
Orange-winged amazon (<i>Amazona amazonica</i>)-----	3	Cape dove (<i>Ena capensis</i>)-----	1
Porto Rican amazon (<i>Amazona vittata</i>)-----	1	Blood-breasted pigeon (<i>Phlogoenas luzonica</i>)-----	4
Yellow-shouldered amazon (<i>Amazona ochroptera</i>)-----	2	Victoria crowned pigeon (<i>Goura victoria</i>)-----	1
Yellow-fronted amazon (<i>Amazona ochrocephala</i>)-----	2	Purplish guan (<i>Penelope purpurascens</i>)-----	1
Yellow-headed amazon (<i>Amazona leucillanti</i>)-----	1	Crested curassow (<i>Crax alector</i>)-----	2
Blue-fronted amazon (<i>Amazona aestiva</i>)-----	1	Mexican curassow (<i>Crax globicera</i>)-----	2
Lesser vasa parrot (<i>Coracopsis nigra</i>)-----	2	Chapman's curassow (<i>Crax chapmani</i>)-----	1
Banded parakeet (<i>Palorinis fasciata</i>)-----	4	Daubenton's curassow (<i>Crax daubentoni</i>)-----	1
Rosella parakeet (<i>Platyercus eximius</i>)-----	2	Wild turkey (<i>Meleagris gallopavo silvestris</i>)-----	16
Love bird (<i>Agapornis pullaria</i>)-----	3	Peafowl (<i>Pavo cristata</i>)-----	60
Green parakeet (<i>Loriculus</i> sp.)-----	2	Jungle fowl (<i>Gallus bankiva</i>)-----	1
Shell parakeet (<i>Melopsittacus undulatus</i>)-----	1	Reeves's pheasant (<i>Phasianus reevesi</i>)-----	1
Great horned owl (<i>Bubo virginianus</i>)-----	12	Golden pheasant (<i>Thaumalea picta</i>)-----	1
Arctic horned owl (<i>Bubo virginianus subarcticus</i>)-----	1	Silver pheasant (<i>Euplocamus nycthemerus</i>)-----	1
Screech owl (<i>Otus asio</i>)-----	2	European quail (<i>Coturnix communis</i>)-----	1
Barred owl (<i>Strix varia</i>)-----	2	Hungarian partridge (<i>Perdix perdix</i>)-----	3
Sparrow hawk (<i>Falco sparverius</i>)-----	2	Bobwhite (<i>Colinus virginianus</i>)-----	5
Bald eagle (<i>Haliaeetus leucocephalus</i>)-----	8	Mountain quail (<i>Oreortyx picta</i>)-----	2
Alaskan bald eagle (<i>Haliaeetus leucocephalus alascanus</i>)-----	1	Scaled quail (<i>Callipepla squamata</i>)-----	1
Golden eagle (<i>Aquila chrysaetos</i>)-----	1	California quail (<i>Lophortyx californica</i>)-----	1
Short-tailed eagle (<i>Terathopus ecaudatus</i>)-----	1	Massena quail (<i>Cyrtonyx montezumae</i>)-----	10
Harp eagle (<i>Thrasaetus harpyia</i>)-----	1	Purple gallinule (<i>Porphyrio carulea</i>)-----	1
Chilian eagle (<i>Geranoaetus melanoleucus</i>)-----	1	Black-backed gallinule (<i>Porphyrio melanotos</i>)-----	2
Crowned hawk eagle (<i>Spizaetus coronatus</i>)-----	1	Martinique gallinule (<i>Tonornis martinicus</i>)-----	1
Red-tailed hawk (<i>Buteo borealis</i>)-----	1	American coot (<i>Fulica americana</i>)-----	11
Broad-winged hawk (<i>Buteo platypterus</i>)-----	1	Flightless rail (<i>Ocydromus australis</i>)-----	1
Venezuelan hawk-----	1	Common cariama (<i>Cariama cristata</i>)-----	1
Caracara (<i>Polyborus cheriway</i>)-----	3	Demoiselle crane (<i>Anthropoides virgo</i>)-----	9
Lammergeyer (<i>Gypaetus barbatus</i>)-----	1	Crowned crane (<i>Balearia pavonina</i>)-----	2
		Sandhill crane (<i>Grus mexicana</i>)-----	2
		Australian crane (<i>Grus australasiana</i>)-----	1
		European crane (<i>Grus cinerea</i>)-----	2
		Sarus crane (<i>Grus antigone</i>)-----	2
		Indian white crane (<i>Grus leucogeranus</i>)-----	2
		Thick-knee (<i>Edicnemus gallinarius</i>)-----	1
		Ruff (<i>Machetes pugnax</i>)-----	4
		Black-crowned night heron (<i>Nycticorax nycticorax naevius</i>)-----	122

Animals in the collection June 30, 1912—Continued.

BIRDS—Continued.

Little blue heron (<i>Florida cœrulea</i>)	1	Lesser snow goose (<i>Chen hyperboreus</i>)	2
Reddish egret (<i>Dichromanassa rufescens</i>)	3	Greater snow goose (<i>Chen hyperboreus nivalis</i>)	1
Snowy egret (<i>Egretta candidissima</i>)	4	American white-fronted goose (<i>Anser albifrons gambeli</i>)	4
Great white heron (<i>Ierodias egretta</i>)	1	Chinese goose (<i>Anser cygnoides</i>)	3
Great blue heron (<i>Ardea herodias</i>)	3	Red-headed duck (<i>Marila americana</i>)	1
Great black-crowned heron (<i>Ardea cocoi</i>)	1	Wood duck (<i>Aix sponsa</i>)	8
Boat-bill (<i>Canceroma cochlearia</i>)	2	Mandarin duck (<i>Dendronessa galericulata</i>)	5
Bittern (<i>Botaurus lentiginosus</i>)	1	Pintail (<i>Dafla acuta</i>)	4
Black stork (<i>Ciconia nigra</i>)	1	Shoveler duck (<i>Spatula clypeata</i>)	2
White stork (<i>Ciconia ciconia</i>)	1	Black duck (<i>Anas rubripes</i>)	1
Marabou stork (<i>Leptoptilus dubius</i>)	1	Mallard (<i>Anas platyrhynchos</i>)	13
Wood ibis (<i>Mycteria americana</i>)	2	American white pelican (<i>Pelecanus erythrorhynchos</i>)	10
Sacred ibis (<i>Ibis æthiopica</i>)	4	European white pelican (<i>Pelecanus onocrotalus</i>)	1
White ibis (<i>Guara alba</i>)	22	Roseate pelican (<i>Pelecanus roseus</i>)	1
Roseate spoonbill (<i>Ajaja ajaja</i>)	1	Brown pelican (<i>Pelecanus occidentalis</i>)	5
European flamingo (<i>Phœnicopterus antiquorum</i>)	5	Black-backed gull (<i>Larus marinus</i>)	1
Crested screamer (<i>Chauna cristata</i>)	3	Herring gull (<i>Larus argentatus</i>)	4
Trumpeter swan (<i>Olor buccinator</i>)	1	American herring gull (<i>Larus argentatus smithsonianus</i>)	6
Whistling swan (<i>Olor columbianus</i>)	3	Laughing gull (<i>Larus atricilla</i>)	3
Mute swan (<i>Uygnus gibbus</i>)	2	Florida cormorant (<i>Phalacrocorax auritus floridanus</i>)	12
Black swan (<i>Chenopsis atrata</i>)	1	Mexican cormorant (<i>Phalacrocorax vigua mexicanus</i>)	1
Muscovy duck (<i>Cairina moschata</i>)	1	Water turkey (<i>Anhinga anhinga</i>)	5
White muscovy duck (<i>Cairina moschata</i>)	2	Somali ostrich (<i>Struthio molybdophanes</i>)	1
Wandering tree-duck (<i>Dendrocygna arcuata</i>)	7	Common cassowary (<i>Casuarius galeatus</i>)	1
Fulvous tree-duck (<i>Dendrocygna bicolor</i>)	2	Common rhea (<i>Rhea americana</i>)	3
Egyptian goose (<i>Chenelopex ægyptiacus</i>)	1	Emu (<i>Dromæus novæ hollandiæ</i>)	1
Brant (<i>Branta bernicla glaucogastra</i>)	1		
Canada goose (<i>Branta canadensis</i>)	8		
Hutchin's goose (<i>Branta canadensis hutchinsii</i>)	3		

REPTILES.

Alligator (<i>Alligator mississippiensis</i>)	18	Black snake (<i>Zamenis constrictor</i>)	1
Painted turtle (<i>Chrysemys picta</i>)	4	Coach-whip snake (<i>Zamenis flagellum</i>)	1
Diamond-back terrapin (<i>Malacoclemys palustris</i>)	1	Corn snake (<i>Coluber guttatus</i>)	1
Three-toed box-tortoise (<i>Cistudo triunguis</i>)	6	Common chicken snake (<i>Colubar quadrivittatus</i>)	2
Painted box-tortoise (<i>Cistudo ornata</i>)	4	Gopher snake (<i>Compsosoma corais couperii</i>)	4
Gopher turtle (<i>Xerobates polyphemus</i>)	1	Pine snake (<i>Pityophis melanoleucus</i>)	6
Duncan Island tortoise (<i>Testudo ephippium</i>)	2	Bull snake (<i>Pityophis sayi</i>)	1
Albemarle Island tortoise (<i>Testudo vicina</i>)	1	Texas chicken snake (<i>Ophibolus calligaster</i>)	2
Alligator lizard (<i>Sceloporus undulatus</i>)	1	King snake (<i>Ophibolus getulus</i>)	1
Horned lizard (<i>Phrynosoma cornutum</i>)	1	Common garter snake (<i>Eutania sirtalis</i>)	1
Gila monster (<i>Heterodera suspectum</i>)	5	Texas water snake (<i>Eutania proxima</i>)	1
Glass snake (<i>Ophisaurus ventralis</i>)	1	Water moccasin (<i>Ancistrodon piscivorus</i>)	1
Anaconda (<i>Eunectes murinus</i>)	2	Copperhead (<i>Ancistrodon contortrix</i>)	5
Common boa (<i>Boa constrictor</i>)	1	Diamond rattlesnake (<i>Crotalus adamanteus</i>)	3
Antillean boa (<i>Boa diriviloqua</i>)	1	Banded rattlesnake (<i>Crotalus horridus</i>)	1
Cuban tree-boa (<i>Epicrates angulifer</i>)	3		
Spreading adder (<i>Heterodon platyrhinus</i>)	1		

GIFTS.

The following persons presented animals to the park during the year :

- Miss Frances Gage Allison, New Bedford, Mass., a Diana monkey.
 Mr. J. B. Ames, Winchester, Va., an albino squirrel.
 Mr. D. R. Anthony, jr., Washington, D. C., an alligator.
 Mr. Oscar E. Baynard, Washington, D. C., a black vulture.
 Mr. August Busck, Washington, D. C., a Panama squirrel.
 Maj. H. W. Carpenter, U. S. M. C., ret., Berryville, Va., two Cuban parrots.
 Mr. J. R. Eddy, Lamedeer, Mont., a western porcupine.
 Dr. Chas. W. Ely, Frederick, Md., a barred owl.
 Mr. W. H. Emery, jr., Washington, D. C., an alligator.
 Mr. Victor J. Evans, Washington, D. C., two marmosettes.
 Mr. Wallace Evans, Oak Park, Ill., a mink.
 Mr. Gale, Washington, D. C., a horned lizard.
 Mr. W. S. S. Groh, Ashburn, Va., a common raccoon.
 Mr. John B. Henderson, jr., Washington, D. C., two common canaries.
 Mr. Holmes, Washington, D. C., a common opossum.
 Mrs. Kenrolde, Washington, D. C., a woodchuck.
 Mr. W. P. Mattoon, Washington, D. C., a "glass snake."
 Mr. F. A. Milligan, Washington, D. C., a common canary.
 Mr. Russell H. Millward, New York City, a paca.
 Mr. J. L. Narvell, Port Deposit, Md., two copperhead snakes.
 Mr. O. Schneider, Washington, D. C., two alligators.
 Messrs. D. A. Smith & L. E. Deaton, Walhalla, S. C., a bittern.
 Mr. S. Stansberg, Baltimore, Md., an alligator.
 Mr. F. B. Travis, Washington, D. C., a common rabbit.
 Master Horace Wadsworth, Washington, D. C., a love bird.
 Mrs. L. P. Wadsworth, Washington, D. C., two alligators.
 Mr. George A. Wise, Washington, D. C., a woodchuck.
 Mr. Thomas Zipp, Baltimore, Md., seven copperhead snakes.

United States Bureau of Fisheries, two elephant seals and four northern fur seals.

- The Janitor, Balfour Apt., Washington, D. C., a sparrow hawk.
 Unknown donors, a barn owl and two alligators.

LOSSES OF ANIMALS.

The most important losses were a lion, wolverine, reindeer, and two northern fur seals from enteritis; a pair of elephant seals and a fur seal from pneumonia; four prong-horn antelopes from malignant catarrh of nose and throat, and an Alaskan brown bear and a springbok from tuberculosis. A female tiger was killed because of abnormal development of its shoulder. Quail disease was introduced through a shipment of birds from the West, but was isolated so that very little loss was occasioned. Dead animals to the number of 199 specimens were transferred to the National Museum. Autopsies were made as formerly by the Pathological Division of the Bureau of Animal Industry, Department of Agriculture.¹

¹ The causes of death were reported to be as follows: Enteritis, 24; gastritis, 4; gastro-enteritis, 9; enteritis from round worms, 4; intestinal coccidiosis, 4; quail disease,



AMERICAN TAPIR IN THE NATIONAL ZOOLOGICAL PARK.
Received from the Municipal Zoological Garden, Buenos Aires.

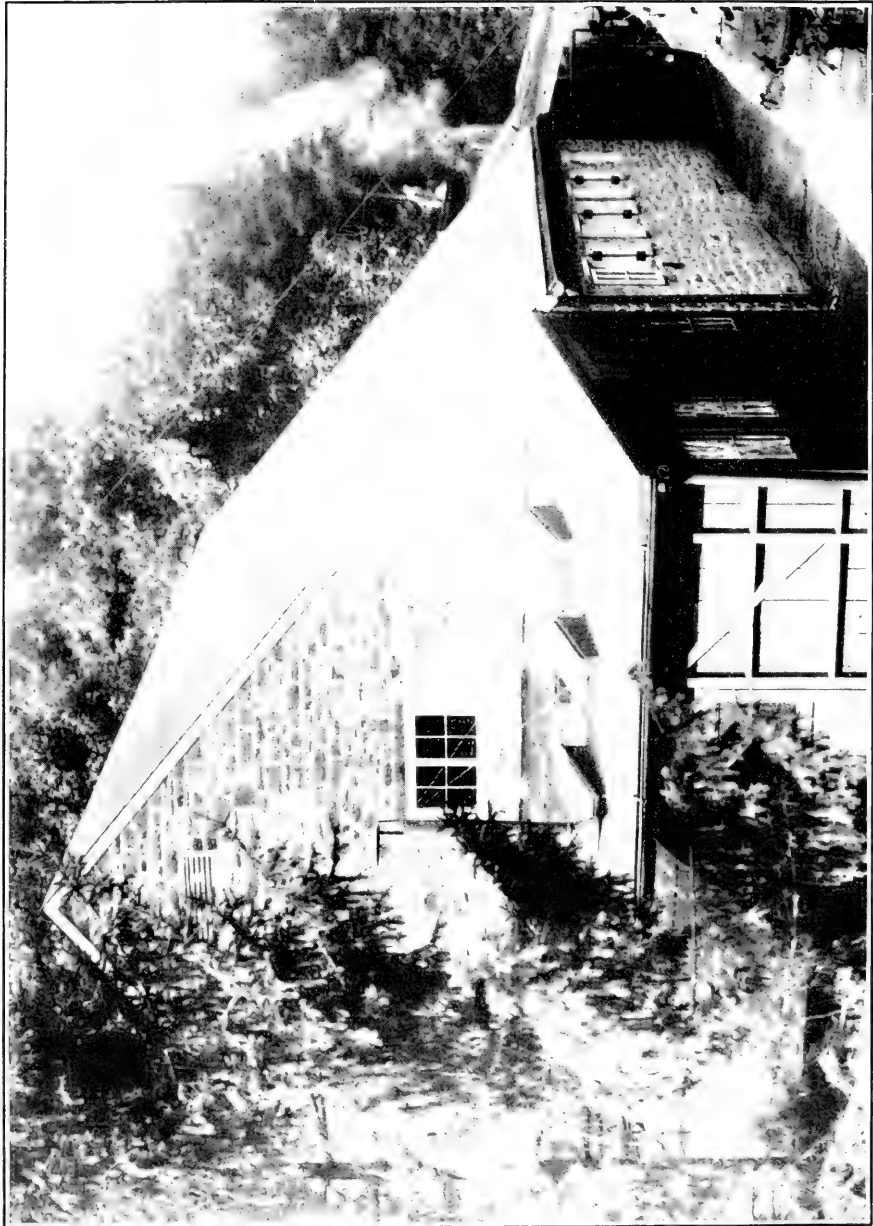

NEW STONE BOILER HOUSE AND MACHINE SHOP IN THE NATIONAL ZOOLOGICAL PARK.

STATEMENT OF THE COLLECTION.

ACCESSIONS DURING THE YEAR.

Presented	50
Received from Yellowstone National Park.....	8
Received in exchange.....	75
Lent	35
Purchased.....	234
Born and hatched in National Zoological Park.....	108
Total	510

SUMMARY.

Animals on hand July 1, 1911.....	1,414
Accessions during the year.....	510
Total	1,924
Deduct loss (by exchange, death, and returning of animals).....	373
On hand June 30, 1912	1,551

Class.	Species.	Individuals.
Mammals.....	150	591
Birds.....	199	876
Reptiles.....	32	84
Total	381	1,551

VISITORS.

The number of visitors to the park during the year is estimated at 542,738, being a daily average of 1,487. The largest number in any one month was 95,485, in April, 1912, an average per day of 3,183.

During the year there visited the park 142 schools and classes, a total of 4,140 pupils, being a monthly average of 345. Besides those from the District of Columbia and neighboring States there were classes from Vermont, Massachusetts, New York, and Tennessee.

IMPROVEMENTS.

The amount remaining from the appropriation after providing for maintenance, was used mainly for improvements of a permanent character. The most important of these, and one urgently needed,

4; congestion of lungs, 19; pneumonia, 13; tuberculosis, 13; pulmonary edema, 2; purulent inflammation of lungs, 1; aspergillosis, 2; abscess, 5; malignant catarrh of nose and throat, 4; catarrh of nostrils, 1; congestion of liver, 5; necrosis of liver, 2; cancer of the liver, 1; osteomalacia, 2; necrosis of tail, 1; pericarditis, 1; peritonitis, 1; septicemia, 1; pyemic absorption, 1; hypertrophy of spleen, 1; impaction of intestine, 1; tympanitic colic, 1; rupture of egg in oviduct, 1; stomach worms, 1; subcutaneous parasitism, 1; rabies, 1; congelation, 2; starvation (snakes), 6; no cause found, 6; accident (fighting, killed by wild animals, etc.), 19.

was a fireproof building for the central heating plant. From this plant the animal houses and the workshop are heated, and as long as the boilers were housed in a flimsy, woden shed, part of which was used as a woodworking shop, there was serious risk of a disastrous fire. The new building is 46 feet by 56 feet, with walls of stone and concrete, and a roof of slate on concrete slabs, supported by steel roof framing. Two additional boilers were purchased and installed so that by using the boilers in alternation they may be cleaned and repaired whenever necessary without interrupting the operation of the plant. The storage vault for coal was enlarged, and a large concrete storage tank built for supplying warmed water to the tanks for the hippopotamus, tapirs, and alligators. The cost of the house, boilers, and other improvements connected with them, was \$5,850.

The series of yards on the west side of the antelope house was enlarged during the year. Light steel bars replaced the wire of the former fence, and wherever sufficient space was available, a double fence of the same character was used instead of solid partitions.

Adjoining the indoor quarters of the hippopotamus and the tapirs a yard 34 feet by 60 feet was constructed, in which was provided a good-sized bathing pool 6 feet deep.

Outdoor cages were installed along the east side of the small mammal house, completing the cage equipment of that building.

A number of inclosures for cattle, deer, and other animals were rebuilt during the year, and a substantial new shelter constructed for the zebus, vicognas, and alpacas.

Three small inclosures for semiaquatic animals were built near the otter and beaver yards, and a permanent walk constructed from that point to connect with the main walk to the west entrance.

The machines in the workshops of the park have heretofore been operated by steam power. As electric power can now be had, arrangement is being made to equip for its use as rapidly as is practicable. Two motors were purchased near the close of the year, also a circular saw with combination bench. Considerable economy in labor will be effected by these changes. Work was also begun on a small house for the storage and preparation of food.

The cost of these improvements was as follows:

House for central heating plant.....	\$5,850
Yards on west side of antelope house.....	1,500
Yard for hippopotamus and tapirs.....	950
Completing outdoor cages at small mammal house.....	525
Inclosures and shelters for cattle, deer, etc.....	800
Small inclosures and walk in beaver valley.....	450
Equipment for workshops.....	613
Beginning construction of food house.....	565
Total.....	<u>11,253</u>

IMPORTANT NEEDS.

New bridge.—The log bridge that crosses the creek on the main driveway in the lower part of the park has for some time shown signs of weakness. A careful examination, by the engineer of bridges of the District of Columbia, showed that several of the logs were in an advanced stage of decay and that the whole structure would soon be unsafe. It was therefore recommended to Congress that an appropriation of \$20,000 be made for a permanent structure. At the time of writing it is known that such an appropriation was made. The construction of the new bridge will therefore be part of the work for the coming year.

Aviary.—In spite of all efforts the fine collection of birds in the park is very far from adequately housed. The wooden building in which the larger number are kept is too small, too low, insanitary, and really unworthy of a national institution. It was built in the cheapest manner to meet an emergency and although considerable sums have been spent on it for repairs it is far from satisfactory. It is desired to build a suitable aviary in the western part of the park and to group about this the cages for the eagles, vultures, condors, and owls now scattered somewhat irregularly about the grounds. It is believed that a suitable structure can be built for about \$80,000.

Hospital.—The statistics given above show that the animals are not exempt from diseases. Infective disorders are sometimes brought in by animals that have been kept in insanitary conditions on ship-board or in the collections of dealers. Even with the utmost care pathological conditions are likely to arise due to changes of habit due to captivity. Animals brought to the park from any place not known to be sanitary and free from disease should be properly quarantined. Sick animals should also be isolated, both on their own account and to prevent the spread of disease. This has been done imperfectly, in the only way possible, by keeping them in exposed cages back of the stable and excluding the public. A small building to serve as quarantine and hospital is urgently needed.

Public comfort house.—There is at present no satisfactory provision for the comfort of visitors who come to spend some time in viewing the collection. The park is located at a long distance from any available restaurant, there is no suitable place where women or children can rest, or be quiet if fatigued, or taken suddenly ill. This offers an unpleasant contrast to the arrangements usually seen in other zoological gardens. It is desired to construct a permanent building in a central locality to serve as a rest house and refectory.

New paddocks.—The deer and other ruminant animals confined near the western entrance to the park have worn the ground so much by the constant attrition of their hoofs that their paddocks are almost

wholly bare of vegetation and the soil is washing away under the influence of rains. These animals must soon be removed to a new location.

Alterations of area.—Very soon after the inception of the park endeavors were made to have its boundaries changed to conform to the plan of the city. It must be remembered that this plan was not developed when the park was laid out. Consequently there are regions where the boundary does not reach existing streets and narrow strips of ground are left which, if occupied, make the rear of houses abut upon the park, presenting an unsightly appearance. This has gone on until on the eastern side private houses have been built that seem to be about to slide down a steep cliff into the park. The value of the adjoining property has materially enhanced.

The western side is greatly in need of improvement. The ideal plan would be to extend the park to Connecticut Avenue, which is a fine, broad street, and make the principal entrance there, with gateways befitting a national institution. If this be found to involve too great an expenditure, the area should at least be made to reach to some contiguous road, either now existing or to be hereafter established.

Retaining wall.—The extension of a street a short distance from the southern boundary of the park has made necessary an extensive fill of earth across the ravine where Ontario Road reaches the park boundary. This fill is encroaching more and more upon the park, and after every heavy rain tons of earth are precipitated down this ravine and into the creek. There seems to be no remedy for this but the construction of a suitable retaining wall or walls forming a series of terraces.

Riprapping banks of Rock Creek.—The heavy volume of water that rushes down the creek at every storm erodes the banks, undermines large trees, and in some places threatens the roadways. It is desirable to avoid this by riprapping with stones of sufficient size to withstand the action of the water. Such work can be effectually concealed by planting twigs and small plants in the interstices.

Footbridge below lower ford.—As the city is rapidly increasing to the westward of the park, more and more people enter from Cathedral Avenue. There is a well-made road from this entrance to the ford through the creek, practicable during low water for carriages. Foot passengers are, however, placed at a disadvantage, as in order to reach the animal houses they are obliged to scramble along a precipitous pathway, used at present mainly by workmen, before they can get to the properly improved roads. At a slight expense a footbridge could be made below the lower ford which would enable visitors to reach at once the main roads of the park.

Additions to the collection.—Without attempting to exhibit those animals that are valuable merely because of their variety, it would

seem that a national collection should at least show those that are common objects of interest, such as the giraffe, the dromedary, the rhinoceros, the African elephant, the various mountain goats, including the indigenous species and others. The high price of these animals has made their acquisition prohibitive in the past, but it is hoped their purchase may be made possible in the future.

Respectfully submitted.

FRANK BAKER, *Superintendent.*

DR. CHARLES D. WALCOTT,
Secretary of the Smithsonian Institution.

APPENDIX 5.

REPORT ON THE ASTROPHYSICAL OBSERVATORY.

SIR: I have the honor to present the following report on the operations of the Smithsonian Astrophysical Observatory for the year ending June 30, 1912:

EQUIPMENT.

The equipment of the observatory is as follows:

(a) At Washington there is an inclosure of about 16,000 square feet, containing five small frame buildings used for observing and computing purposes, three movable frame shelters covering several out-of-door pieces of apparatus, and also one small brick building containing a storage battery and electrical distribution apparatus.

(b) At Mount Wilson, California, upon a leased plat of ground 100 feet square in horizontal projection are located a one-story cement observing structure, designed especially for solar-constant measurements, and also a little frame cottage, 21 feet by 25 feet, for observer's quarters.

There were no important additions to the instrument equipment of the observatory during the year.

In 1909 the Smithsonian Institution, at the expense of the Hodgkins fund, erected on the summit of Mount Whitney, California (height 14,502 feet), a stone and steel house to shelter observers who might apply to the Institution for the use of the house to promote investigations in any branch of science. While this structure is not the actual property of the Astrophysical Observatory, it affords an excellent opportunity for observations in connection with those taken on Mount Wilson.

WORK OF THE YEAR.

1. ON THE VARIABILITY OF THE SUN.

Congress having provided funds, an expedition under the immediate charge of the Director proceeded in July to Bassour, Algeria, to make there a long series of solar-constant observations simultaneously with similar observations made by Assistant Aldrich on Mount Wilson. The Algerian expedition included Mr. and Mrs. Abbot and Prof. F. P. Brackett, of Pomona College, California. The apparatus carried was the same used by Mr. Abbot on Mount Whitney in 1909

and 1910. Station was reached on July 31, 1911, but owing to a most unfortunate miscarriage of a box of apparatus, observations could not be commenced until August 26, and several more days were required to get the whole outfit working satisfactorily. The weather of August was excellent at both Mount Wilson and Bassour, but in the subsequent months the good days at one station frequently coincided with bad ones at the other. Hence, although 44 days of solar-constant observations were secured at Bassour up to November 17, when the camp was broken up, and a still greater number were secured at Mount Wilson, only 29 of these coincided.

In spite of the loss of August and the unfavorable weather of subsequent months, the results thus far reduced strongly confirm the supposed variability of the sun. For example, the first half of September yielded the following results:

Solar-constant values.

	Aug. 29.	Aug. 30.	Aug. 31.	Sept. 1.	Sept. 2.	Sept. 3.	Sept. 4.	Sept. 5.	Sept. 6.	Sept. 7.
Mount Wilson.....	1.913	1.890	1.912	1.894	1.872	1.866	1.935	1.904
Bassour.....	1.976	1.952	1.945	1.930	1.933	1.966	1.905	1.916
B.-W.....	.063	.062	.033072	.033012

	Sept. 8.	Sept. 9.	Sept. 10.	Sept. 11.	Sept. 12.	Sept. 13.	Sept. 14.	Sept. 15.	Sept. 16.
Mount Wilson.....	1.960	1.945	1.872	1.835	1.865	1.885	1.867	1.890
Bassour.....	2.015	1.860	1.905	1.895	1.885
B.-W.....070	-.012040018

From these results appear:

(A) The solar-constant results obtained at Bassour are on the average 2 per cent higher than those obtained for the same days on Mount Wilson. Referring to former reports, the solar-constant results obtained at Washington and at Mount Whitney were also consistently higher than those obtained at Mount Wilson, and by about the same amount as just given. Hence, we seem justified in considering that there is a condition tending to low results prevailing at Mount Wilson. This may very probably be the increase of haziness there at high sun, due to increased humidity. In view of the uniform testimony of the three other stations, it seems proper to conclude that Mount Wilson solar constant values are generally too small.

(B) *High solar constant values at Bassour correspond with high solar constant values at Mount Wilson, and vice versa.* This relation is shown in both the accompanying diagrams. Figure 1 is a plot of the successive solar-constant values at the two stations for the days mentioned. Figure 2 shows the same values plotted in a manner to

better exhibit the comparison. The vertical scale (fig. 2) represents Mount Wilson values and the horizontal scale Bassour values of the solar constant for each day when satisfactory observations were secured at both stations. If the values observed were without error, it is obvious that for each day they would have been identical at the two stations. Hence, if the solar radiation had values of 1.90, 1.95, and 2 calories on three different days, they should have been represented by points at the lower left corner, the center, and the upper right corner of our diagram, if observed at both stations without

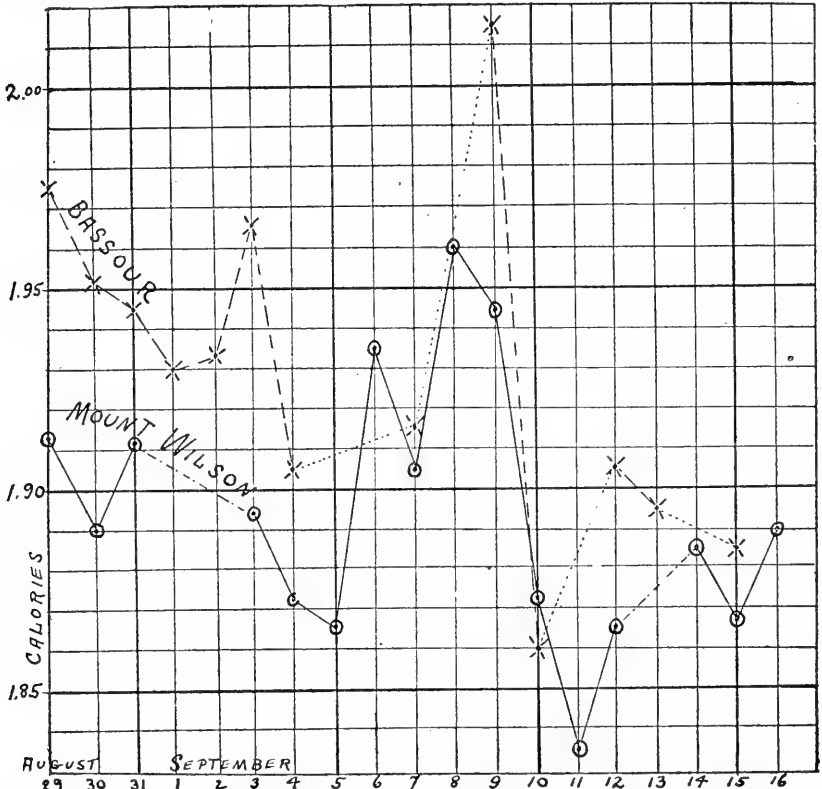

FIG. 1.—Successive solar constant values, Bassour and Mount Wilson.

error. In general all values of the solar constant would fall on the line A B of the figure if the measurements were without error. But we have found the Mount Wilson values consistently lower by 2 per cent. If we admit a constant systematic error of this magnitude, but still deny all accidental error of measurement, then all observations should fall on the line C D of our diagram. They must all lie at a single point of C D if the solar radiation is constant, but may fall anywhere upon that line if the solar radiation is variable. In practice it is of course never possible to avoid accidental errors of

measurement. Hence, we must expect that all values shall cluster about a *point* on C D if the sun is constant, but shall cluster about C D *as an axis* if the sun is variable. The latter condition is evidently the fact. Assuming the mean point of C D as a center, the average deviation from it is proportional to 8. Assuming the line C D as an axis, the average deviation from it is proportional to 3. Thus the observations are represented 8/3 times better by assuming that the sun's radiation is variable than by assuming it constant.

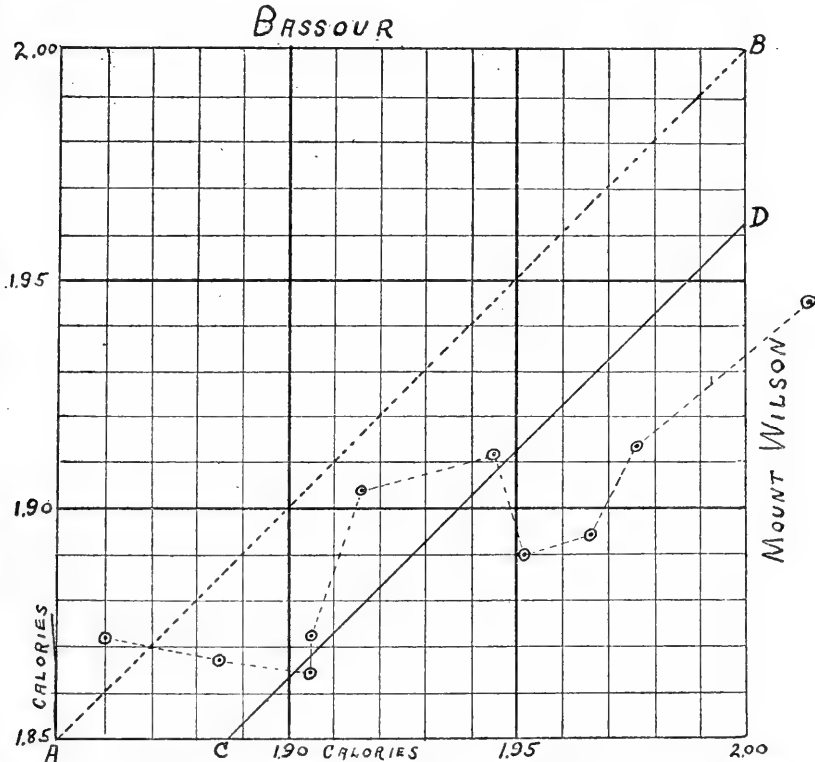

FIG. 2.—Simultaneous solar constant determinations. Bassour and Mount Wilson.

The average deviation of the values from the line C D is 0.021 calories. Hence we may conclude that simultaneous solar-constant measurements at Bassour and at Mount Wilson, while differing by a constant factor of 2 per cent, exhibit accidental errors of only 1.2 per cent due to variability of the sky, errors of observing, and the like. Dividing by the square root of 2, we find that the average accidental error of a single solar-constant determination at one station is 0.9 per cent. When one considers the multiplicity of the sources of error in this complex investigation, and that the result just announced depends on the uniformity of the sky during several hours, as well as

on the ordinary vicissitudes of all experimental work, the smallness of this accidental error seems remarkable.

Expeditions of 1912.—While the simultaneous observations made in 1911 at Bassour and Mount Wilson seemed justly interpretable as confirming the variability of the sun, yet it was felt that a result of such uncommon interest ought to be put beyond the smallest warrantable doubt. Accordingly, in May, 1912, Mr. and Mrs. Abbot again returned to Bassour, where they were joined on May 20 by Mr. Anders Knutson Ångström, as temporary assistant. Observations were begun on June 2. Observations on Mount Wilson had already been begun by Mr. Fowle in April. June yielded 17 days of measurement at Bassour and 25 days on Mount Wilson. It is expected that the two expeditions will continue observing until about September 10, 1912. There can hardly be any question that this work, combined with that of 1911, will thoroughly prove or disprove the existence of the suspected short-period variations of the sun.

2. ON THE DISSEMINATION OF STANDARDS OF PYRHeliOMETRY.

The Smithsonian Institution having undertaken to furnish silver disk pyrheliometers at cost when useful solar researches seemed likely to be promoted thereby, the assembling of the completed instruments, their standardization, and their packing for shipment have been done at the Astrophysical Observatory. During the past year about 10 such instruments have been prepared and sent out, mostly to foreign governmental meteorological services. When returning from Algeria Mr. Abbot compared silver disk pyrheliometer A. P. O. No. IX at Naples and Potsdam with similar instruments furnished by the Institution. In neither case was there found any change of readings of the instruments compared. It was hoped to make comparisons also at London and Paris, but the weather prevented.

3. ON THE ABSORPTION OF RADIATION BY ATMOSPHERIC WATER VAPOR.

Mr. Fowle has continued the research on the absorption of radiation by water vapor, and has devised and published¹ a method for determining spectroscopically the total quantity of water vapor included between the observer and the sun. The method is based on spectrophotometric observations made with the long absorption tube mentioned in the last two reports, and is applicable to all bolometric observations of the sun's infra-red spectrum. It seems probably to be accurate to within 1 or 2 per cent. Heretofore there has been no method of estimating atmospheric water vapor excepting from observations of the humidity prevailing at the surface of the earth or near kites, balloons, and mountains. From such psychrometric

¹Astrophysical Journal, vol. 35, 1912, p. 149.

observations made at different levels general formulæ for the average humidity of the atmosphere have been derived. Mr. Fowle finds, however, that these formulæ, while representing average conditions, are often widely astray on individual days. He is preparing further data from Washington, Mount Wilson, Mount Whitney, and Bassour spectrobolometric work, to promote a more complete study of atmospheric humidity.

This investigation has yielded a valuable application for solar-constant work, for Mr. Fowle has found a way to very greatly shorten the work of correcting for water-vapor absorption in reducing the bolographic observations. This will diminish by about one-fifth the labor of reducing the solar-constant work, and at the same time will yield results of slightly greater accuracy than before.

Atmospheric water-vapor absorption work has been confined to the upper infra-red spectrum bands this year. A vacuum bolometer is in preparation, by means of which a considerable gain in sensitiveness of the apparatus is hoped for. This will greatly promote the value of the work at very great wave lengths, and accordingly this part of the work has been allowed to await the introduction of the vacuum bolometer.

PERSONNEL.

Prof. F. P. Brackett served as temporary bolometric assistant to the Algerian expedition of 1911.

Mr. Anders Knutson Ångström served as temporary bolometric assistant to the Algerian expedition of 1912.

Miss F. E. Frisby was appointed temporary computer, February 12, 1912.

Minor Clerk M. Segal resigned March 1, 1912.

F. R. Carrington was appointed messenger boy on March 25, 1912.

SUMMARY.

The year has been notable for expeditions to Algeria and California to test the supposed variability of the sun by making simultaneously at these two widely separated stations spectrobolometric determinations of the solar constant of radiation. The measurements in Algeria agree with earlier ones at Washington and Mount Whitney and indicate that Mount Wilson values are systematically a little low. Apart from this systematic error the average accidental differences between Algerian and Mount Wilson determinations were only 1.2 per cent, indicating an average accidental error of a single solar-constant determination at one station of only 0.9 per cent. So far as yet reduced, *high solar-constant values obtained in Algeria coincide with high values at Mount Wilson and vice versa.* A solar

variation of 4 per cent was indicated at both stations in the first half of September, 1911. Many values remain to be computed, but it can now hardly be doubted that the outcome will prove conclusively the irregular short-period variability of the sun.

Numerous copies of the silver disk pyrheliometer have been standardized and sent out, mainly to foreign governmental meteorological services.

Valuable results have been secured in the research on the transmission of radiation through atmospheric water vapor. An accurate method of estimating the total water-vapor contents of the atmosphere between the observer and the sun has been devised by Mr. Fowle.

Respectfully submitted.

C. G. ABBOT,

Director, Astrophysical Observatory.

Dr. C. D. WALCOTT,

Secretary of the Smithsonian Institution.

APPENDIX 6.

REPORT ON THE LIBRARY.

SIR: I have the honor to present the following report on the work of the Library of the Smithsonian Institution during the fiscal year ending June 30, 1912:

As no general account of the library has appeared in the publications of the Institution for the last 16 years, it seems desirable to give a brief summary of its history in this place.

The formation of a library was included among the objects of the Institution in the act of Congress approved August 6, 1846, by which it was established. The character of this library was specified in the program of organization presented to the Board of Regents by Secretary Henry on December 8, 1847, and approved by them, in the following terms:

To carry out the plan before described, a library will be required, first, of a complete collection of the transactions and proceedings of all the learned societies in the world; second, of the more important current periodical publications and other works necessary in preparing the periodical reports.

With reference to the collection of books other than those mentioned above, catalogues of all the different libraries in the United States should be procured, in order that the valuable books first purchased may be such as are not to be found in the United States.

Also catalogues of memoirs, and of books in foreign libraries, and other materials should be collected for rendering the Institution a center of bibliographical knowledge, whence the student may be directed to any work which he may require.

In 1847 Prof. Charles C. Jewett was appointed librarian, and after some little delay began collecting books in accordance with the plan just cited. As a result of his activities the Smithsonian Library in 1852 comprised 32,000 volumes. A portion of them was obtained by purchase and others by the exchange of the publications of the Institution for those of learned societies and similar organizations in the United States and in Europe.

The expense of maintaining the library soon became a serious drain on the limited resources of the Institution, and in 1864 the Board of Regents, on the recommendation of Secretary Henry, requested Congress to authorize its deposit in the Library of Congress. An act to this effect was passed in 1866, and, in accordance with its provisions, the Smithsonian library was transferred the same year to the new fireproof rooms in the Capitol which had been prepared at

that time for the better accommodation of the Library of Congress. The Smithsonian Library then contained about 40,000 volumes. Its transfer from the Smithsonian building in nowise checked its growth. It increased in extent with every succeeding year, and in 1895 the record entries had reached 314,500, including books, pamphlets, periodicals and parts of periodicals, and maps, exclusive of certain small special collections not incorporated in the "Smithsonian deposit." The Institution at that time currently received more than 3,045 separate publications of learned societies, periodicals, and magazines, of which 1,565 related to pure science, 704 to applied science, and 776 to art, literature, trade, and a variety of other subjects. The small special collections mentioned above, known as the secretary's library, the office library, the library of the Astrophysical Observatory, the library of the National Zoological Park, the employees' library, the Exchange Service collection, and the law reference library aggregated about 10,000 publications in 1896.

In 1897 the Smithsonian library was transferred with the Library of Congress to the new building provided for the latter and placed in the east stack and in a large room adjoining the same. It was subsequently transferred to another room, which was specially equipped with metal bookcases.

It is not possible to ascertain the exact number of books, pamphlets, and other publications contained in the Smithsonian library at the present time without making an actual enumeration of them, an operation which would be attended by many difficulties. It may be said, however, that at the close of the fiscal year 1912 the accession entries had reached a total for the contents of the library of 508,788, including books, pamphlets, periodicals and parts of periodicals, and maps and charts, exclusive of the small special collections already mentioned.

While the Institution has acquired by donation or otherwise many rare and valuable books and collections of books relating to other subjects than the sciences, the original program laid down by Secretary Henry has been closely followed, and the Smithsonian library deposited in the Library of Congress consists mainly of scientific periodicals and the transactions and proceedings of learned societies. With possibly one exception, it contains the most important collection of these classes of publications to be found anywhere in the world.

The increase in the activities of the National Museum which followed the great influx of collections from the United States Fish Commission and from the Centennial Exhibition of 1876 and the erection of a separate Museum building made it imperative that large numbers of books on natural history, the arts, museum administration, and other subjects should be permanently available for the scientific and administrative staff, for use in identifying and classi-

fyng collections and as a source of information regarding museum methods. This resulted in the establishment of the National Museum Library, which had as its nucleus the collection presented by Secretary Baird. By small annual expenditures for the purchase of books, and by the exchange of the Museum publications, by donations, and otherwise, this library has accumulated about 42,000 volumes, 70,000 unbound papers, and a number of maps, charts, and manuscripts.

A similar need in the Bureau of American Ethnology has led to the formation of a library relating to ethnology and archeology, and especially to the North American Indians, which comprises about 21,000 volumes.

While the Library of Congress has the custody of the "Smithsonian deposit," the title of the library remains in the Institution. It continues to have free use of its books, and also enjoys the use of the books belonging to the Library of Congress. Under the provisions of the act of Congress through which the Smithsonian Library was transferred to the Library of Congress, the Institution may withdraw the books upon reimbursement to the Treasury for the expenses incurred in binding and caring for them.

As foreseen by Secretary Henry, this arrangement has both its advantages and its disadvantages. The Institution is relieved from the expense of maintaining a large library, and its books are safeguarded and housed with other similar collections, whereby the wants of students and investigators in many lines of intellectual work are provided for in one place.

On the other hand, the Institution has little within its own walls to show for its early expenditures for books, or for the great system of exchanges which has been carried on for more than half a century. Furthermore, with the growth of the National Museum and other scientific branches, under the direction of the Institution, the desirability of having a large body of books immediately at hand becomes every year more apparent. This is especially true as regards books on natural sciences, and on the industrial and fine arts, a large number of which are constantly needed by the staff of the National Museum, as well as by the other scientific bureaus of the Government and by representatives of the great body of scientific students and investigators throughout the country who are attracted to Washington by the collections of the Museum.

In order that this need might be met as far as possible without impairing the arrangement with the Library of Congress, the Museum has, as already mentioned, assembled a considerable library of its own, but it has been found desirable also to keep certain series belonging to the Smithsonian deposit at the Institution for longer periods than would be required for ordinary reference. The library of the Bureau of American Ethnology is also housed in the Smithsonian Building,

and, in addition, the various small collections of books mentioned above, except that of the Zoological Park, which is kept in the park offices.

To provide fireproof quarters for these and also for a portion of the National Museum Library, it was proposed last year to erect metal bookstacks in the main hall of the Smithsonian Building where they could all be brought together and economically administered. It is to be hoped that Congress will soon provide the means for carrying this plan into effect.

As regards the service of the library, the most unsatisfactory feature at present is the delay in obtaining books, which frequently occurs, owing to the fact that, in accordance with the established routine, books are received from the Library of Congress only twice a day. It is not always possible for those who use the library to cite the exact date or serial number of volumes wanted for reference, and hence, through the fault of no one, wrong books are sometimes received. This causes additional delay and dissatisfaction.

As is well known, the plan has recently been canvassed by the Government of connecting the several departments and bureaus by an underground pneumatic carrier large enough to take books of at least the usual sizes. A connection of this kind between the buildings of the Library of Congress, the Smithsonian Institution, and the National Museum would be of great utility in the service of the library and would remove the difficulties now existing as regards the delivery of books.

The greatest defect in the Smithsonian Library, and one which has existed for many years, if not from the beginning, is the lack of completeness of numerous sets of scientific serials. While this condition is not at all peculiar to this library, it is a source of much vexation to those who use the books. Secretary Langley, when in charge of the library, devised a plan by which many gaps were filled, but others still remain. The Institution has never possessed funds sufficient to enable it to remedy the defects by purchase. Odd volumes of a series are not often obtainable, and to purchase the whole, or the greater part of a series, in order to obtain a particular volume, is an expensive procedure. Although a great deal of thought has been expended in attempts to devise a plan to overcome this difficulty, it has not led to any practical result so far as the Institution is concerned. Recently, however, the Library of Congress, through its greater resources, has succeeded in procuring many of the desired volumes, and they have been placed in the gaps in the Smithsonian series. This liberal action in the interest of scientific study seems to constitute the only possible solution of the problem at present, although it would naturally be a source of greater satisfaction to the Institution if all the volumes in the various series bore the Smithsonian stamp.

ACCESSIONS.

During the fiscal year covered by this report, 29,147 packages of publications were received by mail and 2,759 packages through the International Exchange Service, making a total of 31,906 packages. Some of these packages contained as many as 20 separate parts of periodicals or other serial publications. About 4,737 acknowledgments were made on the regular forms in addition to the letters which were written in acknowledgment of publications received in response to the requests of the Institution for exchange.

The accessions for the Smithsonian deposit in the Library of Congress recorded during the year numbered 3,540 volumes, 1,951 parts of volumes, 15,826 pamphlets, and 366 charts, making a total of 21,683 publications. The accession numbers ran from 504,150 to 508,788, the parts of serial publications entered on the card catalogue numbered 19,012, and 1,225 slips were made for completed volumes, and 171 cards for new periodicals. These various publications comprised in all 52,548 separate pieces, including parts of periodicals, pamphlets, and volumes. They were sufficient to fill 364 boxes, which together contained approximately the equivalent of 14,560 volumes. In addition, 2,058 parts of serial publications secured by the Institution in exchange, to complete sets, were also sent to the Library of Congress.

The practice of sending foreign public documents presented to the Institution to the Library of Congress without stamping or entering was continued during the year, about 4,589 publications not included in any of the foregoing statistics having been sent in that manner.

The office library received as accessions 347 volumes, 42 parts of volumes, and 31 pamphlets; the Astrophysical Observatory, 114 volumes, 38 parts of volumes, and 86 pamphlets; and the National Zoological Park 10 volumes and 9 pamphlets, making a total of 677 publications.

EXCHANGES.

Efforts to establish new exchanges and to secure missing parts to complete sets of publications in the Smithsonian Library involved the writing of 3,000 letters, and resulted in the addition of about 171 new periodicals and the receipt of about 2,058 missing parts to complete volumes in the Smithsonian sets.

New exchanges for the annual reports of the American Historical Association from the allotment set aside by agreement for that purpose resulted in the acquisition of a number of publications of historical societies throughout the world. These were added to the Smithsonian deposit in the Library of Congress.

GENERAL WORK ON THE LIBRARY.

As an aid in determining the actual deficiencies in various sets in the Smithsonian deposit in the Library of Congress, a special search was made through the Library of the National Museum for volumes and parts of volumes belonging to the deposit, and it is expected that before the Museum Library is moved into the new building practically all that have lodged there will have been found and sent to the Library of Congress to be entered in the proper records. In addition, requests have been made upon institutions and societies to secure lacking parts, with the result that many sets have been completed. Revised want lists of French and English publications, prepared at the Library of Congress, were examined, and in many cases the publications were supplied by the institutions and societies.

The author catalogue for the general series of publications received was continued, and the results were all that could be desired. Catalogue cards made for the author-donor catalogue numbered 10,012. Publications catalogued comprised 11,194 volumes, 171 new periodicals, and 383 charts. Of the volumes, 1,712 were recatalogued.

During the year 3,731 parts of scientific periodicals and popular magazines and 250 bound volumes were lent to readers, making a total of 3,981.

CATALOGUE OF SMITHSONIAN PUBLICATIONS.

An analytical card catalogue of the publications of the Institution to include both author and subject entries has been begun. Some time will yet be required to complete the task, as the cards under present conditions can be prepared only during intervals in the regular work at the cataloguing and accession desks. Much thought was given to plans for the preparation of a catalogue of Smithsonian publications to be printed in book form, which is greatly needed at the present time, but on account of the limited funds available for printing it was deemed by the secretary inadvisable to undertake the work this year.

READING AND REFERENCE ROOMS.

A rearrangement of the reading rooms, to make more space for readers, is in progress. The accession books are to be placed in a case erected on the west side of the room, the table in the middle of the room is to be reduced in size, one cataloguer's desk is to be transferred to another room, and a table with bins for periodicals is to be placed under the north windows.

The publications in the reference room and those in the reading room are now in charge of one person.

ART ROOM.

The contents of this room were rearranged during the year and publications not directly relating to the fine arts placed in the sectional

libraries of the Museum. A number of books on art belonging to the Marsh collection were placed at the main entrance to the Smithsonian building in conjunction with the newly installed exhibition series illustrating the various activities of the Institution.

EMPLOYEES' LIBRARY.

The total number of loans from this collection made during the year amounted to 1,800. Two hundred and twelve volumes of periodicals were bound and made available for circulation. A number of books, especially selected for the purpose, were sent to the National Zoological Park, as in previous years. Only one book was purchased and one received as a donation.

At the time at which this collection of books was established the facilities for obtaining reading matter of general interest were quite limited, but with the opening of the Washington Public Library they were very greatly increased. In view of the large number of books in all branches of literature which are now available for readers, it does not appear necessary to expend money in extending this special collection.

LIBRARIES OF THE GOVERNMENT BRANCHES.

United States National Museum.—In previous reports reference has been made to the congested condition of the library of the National Museum. This was partly relieved in 1911 by separating out duplicates, for which work temporary assistants were employed for several months. The library still remained somewhat in confusion, however, owing to the necessity of moving various sections from time to time to make room for new accessions. These accessions arrived more rapidly than they could be disposed of, and accumulated in unsorted piles. The library also suffered greatly from dust.

Owing to the necessity of exercising rigid economy in the administration of the Museum library, the present force is scarcely able to do more than keep pace with the current routine work, which consists of registering accessions, entering current numbers of periodicals and transactions of scientific societies in the card-catalogue, classifying new accessions in accordance with the Dewey decimal system, attending to the wants of the readers and those entitled to borrow books, keeping the records of loans, and conducting the necessary correspondence. The very important task of placing books returned by borrowers, or new accessions, on the shelves is performed by the messenger, the classifier, or others, as they have opportunity. The preparation of books for binding, which requires special care, is attended to by the assistant librarian of the Museum in the intervals of other business.

As the time for removing a portion of the library to the new Museum building was approaching, and there seemed no possibility of diverting the regular force to the task of putting the book-stacks in order, the assistant secretary in charge of the Museum, at my suggestion, employed three temporary assistants who overhauled the entire contents of the stacks, thoroughly dusted the shelves and books, gave particular attention to arranging the volumes of the serials in exact order, and to restoring any books that were out of place to their proper locations. At the same time the floors were cleaned and painted to keep down dust, a few new lights were added where needed, and various minor repairs were made to windows, ventilators, etc.

As a result of these activities, the Museum library at the close of the year, though much crowded, presented a clean and orderly appearance throughout, and everything was in train for the transfer of a portion of the books to the new building without confusion or serious interruption of the regular work.

As will be learned from the report of the assistant secretary in charge of the National Museum, a readjustment of exhibits, laboratories, offices, etc., follows from the completion of the new Museum building, and it is the intention to rearrange the library to suit these new conditions. It is proposed to assemble all books on zoology, paleontology, geology, ethnology, and archeology in the new building. Books on the arts and industries, technology, and allied subjects will be assembled in the present library quarters in the old building. Books on botany and those whose contents relate to a number of different subjects will probably also remain for some time in the present quarters, though, as already mentioned, it is hoped that Congress will soon make provision for these and certain Smithsonian books, together with the library of the Bureau of American Ethnology, in the main hall of the Smithsonian building.

At the request of the assistant secretary of the Museum, the assistant librarian of the Institution and myself prepared definite plans for the installation of the portion of the library already mentioned in the new Museum building, in well-adapted rooms on the ground floor at the northeast corner. Contracts were made for the metal stacks and other fittings, in accordance with these plans, and at the close of the year they were nearly ready for delivery. It is expected that when this equipment is finished the Museum will have a compact, economical, commodious, well-lighted, and well-arranged library, installed in accordance with the latest and most improved methods.

Many important donations of books were received by this library during the year, and the following officers and associates also presented publications: Dr. Charles D. Walcott, Dr. Theo. N. Gill,

Dr. Edgar A. Mearns, Dr. William H. Dall, Mr. R. Ridgway, Dr. C. W. Richmond, Mr. J. C. Crawford, Dr. O. P. Hay, Dr. A. C. Peale, Mr. W. R. Maxon, and Mr. F. D. Millet.

The Museum library, according to the best statistics available, now contains about 42,000 volumes, 70,000 unbound papers, and 122 manuscripts, besides maps, charts, etc. The accessions during the year consisted of 1,791 books, 3,608 pamphlets, and 276 parts of volumes. During the same period 824 books, 960 complete volumes of periodicals, and 3,622 pamphlets were catalogued.

Attention was given as in previous years to the preparation of volumes for binding. In all 543 books were sent to the Government bindery during the year. The binding is, however, still much in arrears, and it is hoped that more money can be devoted to this purpose in the future. Large numbers of pamphlets need cardboard covers to protect them from injury. Though the covers themselves are available, it is impossible with the present force to bring them into use to the extent required.

During the year 24,815 books, periodicals, and pamphlets were borrowed from the library, among them 5,515 obtained from the Library of Congress and other libraries, and 4,560 were assigned to the sectional libraries of the Museum. The majority of these sectional libraries contain publications that are constantly needed by the several curators and other officers in identifying and classifying material, working up collections for publication, writing exhibition labels, etc., and the books are kept together as long as required, though any of them may be recalled temporarily to the general library for the use of readers. Similar collections of books on museum administration, museum methods, etc., are kept in the offices of the assistant secretary in charge of the Museum, the administrative assistant, the editor, and the superintendent. In all, 31 such sectional libraries are now in existence, one relating to textiles having been added during the year.

The records of the Museum library consist of accession book and an author catalogue, a periodical record, and a lending record in card form. The lending record includes books borrowed from the Library of Congress and from other libraries for the use of the Museum staff.

Correspondence relative to new exchanges and missing parts of serial publications already in the Museum library was carried on as in previous years. A number of new titles were added by this means.

Bureau of American Ethnology.—The report on this library will be made by the ethnologist in charge and incorporated in his general report on the operations of the bureau.

Astrophysical Observatory.—Owing to lack of room in the office of the observatory, a part of the books belonging to this library have

been kept in the Smithsonian building. During the year this latter portion was transferred from one of the tower rooms where it was difficult of access to the southwest gallery in the main hall of the building. Additions, comprising 114 volumes, 38 parts of volumes, and 86 pamphlets, were received during the year.

National Zoological Park.—To this small reference library of zoological publications relating to the work of the park 10 volumes and 9 pamphlets were added during the year.

Summary of accessions.—The following statement summarizes all the accessions for the year, except the Bureau of American Ethnology, which is administered separately:

Smithsonian deposit in the Library of Congress.....	21, 683
Smithsonian office, Astrophysical Observatory, National Zoological Park, and International Exchange Service.....	677
United States National Museum.....	5, 675
Total.....	28, 035

Very respectfully,

F. W. TRUE,
*Assistant Secretary, in charge
of Library and Exchanges.*

DR. CHARLES D. WALCOTT,
Secretary of the Smithsonian Institution.

OCTOBER 9, 1912.

APPENDIX 7.

REPORT ON THE INTERNATIONAL CATALOGUE.

SIR: I have the honor to submit the following report on the operations of the United States Bureau of the International Catalogue of Scientific Literature for the year ending June 30, 1912:

The International Catalogue of Scientific Literature is an organization consisting of 32 regional bureaus representing the principal countries of the world. Control over the entire enterprise is vested in an international convention which meets at regular stated intervals. The regional bureaus supply to a central bureau in London classified index citations to the scientific literature published within their several regions.

The duties of the central bureau consist in editing and publishing the citations thus forwarded. The published catalogue comprises 17 annual volumes, one for each of the following-named subjects: Mathematics, mechanics, physics, chemistry, astronomy, meteorology, mineralogy, geology, geography, paleontology, general biology, botany, zoology, anatomy, anthropology, physiology, and bacteriology. Each country cooperating supports its own regional bureau, this support in most cases being in the form of direct governmental grants. The maintenance of the central bureau, which bears the cost of editing and publishing the catalogue, is dependent on the funds received from the sale of the published volumes.

The Royal Society of London has stood financial sponsor for the enterprise since the beginning of the undertaking in 1901, and it has been through the generous financial assistance of this body that the publication of the work has been possible.

The organization has now been at work over 10 years, and the published results have met the exacting requirements of a classified index to the vast scientific activities of the day; but the price of the work to subscribers, although below the cost of publication, is so large that its usefulness is greatly limited. For this reason a permanent endowment is urgently needed in order that the central bureau may have a fixed income independent of the sum derived from the sale of the published volumes. It is believed that if such an endowment could be obtained the cost of the catalogue could be reduced possibly to one-half its present subscription price, which is \$85 per year. This reduction in price would undoubtedly largely increase

the sales, and as a larger edition of the work would cost comparatively little more than the present limited edition any increase in the demand would approximately be clear profit to the central bureau.

This result is not only desirable from a financial standpoint but also because it is believed that this international index to scientific literature, whose scope is now limited to pure science, is but a beginning to what will eventually be an international index to not only the pure but also to the applied sciences. This will mean that the organization will ultimately furnish classified citations to the original literature of many of the professions, arts, and trades whose practices and methods are now much interwoven with, and dependent on the advance of pure science.

The appropriation made by Congress for the maintenance of the regional bureau for the United States during the year was \$7,500, this being the same sum that was appropriated for the previous year. Five persons are regularly employed in this bureau in collecting, indexing, and classifying the scientific literature published in the United States.

The practice of having the more technical scientific papers referred for analysis and classification to specialists in the subjects treated has been found very satisfactory and is now carried on to the exclusion of the former practice of corresponding with the authors of the papers, for it was found that to correspond and advise with authors necessitated much clerical labor and often caused long delays in obtaining the information sought.

During the year 27,201 cards were sent from this bureau to the London central bureau as follows:

Literature of—	
1903.....	4
1904.....	243
1905.....	386
1906.....	562
1907.....	1,480
1908.....	1,949
1909.....	3,372
1910.....	5,231
1911.....	13,974
Total.....	27,201

Since the bureau was established in 1901, 262,335 cards have been forwarded to the central bureau.

The following table shows the number of cards sent each year as well as the number of cards representing the literature of each year from 1901 to 1911, inclusive.

Literature of..	1901	1902	1903	1904	1905	1906	1907	1908	1909	1910	1911	Total for year
Year ending June 30—												
1902.....	6,900											6,900
1903.....	6,150	8,330										14,480
1904.....	3,044	9,424	8,745									21,213
1905.....	1,619	2,780	11,143	8,640								24,182
1906.....	301	622	3,538	12,139	9,001							25,601
1907.....	384	511	862	5,272	9,022	12,578						28,629
1908.....	408	523	366	956	5,629	7,217	13,429					28,528
1909.....	133	235	373	369	1,656	4,410	8,509	18,784				34,409
1910.....	72	173	248	465	1,163	1,502	3,160	6,305	11,994			25,082
1911.....	3	26	28	218	129	374	423	1,301	8,836	14,682		26,020
1912.....			4	243	386	562	1,480	1,949	3,372	5,231	13,974	27,201
Total...	19,104	22,624	25,307	28,242	26,986	26,643	27,001	28,339	24,202	19,913	13,974	262,335

During this time the London central bureau had received from all of the 32 bureaus cooperating in the production of the International Catalogue a total of 2,059,036 cards, and as 262,335 of these represented the cards received from the United States, it will be seen that about 13 per cent of the work has been done by the regional bureau for the United States. All of the first eight annual issues of the catalogue, consisting of 17 volumes each, have been published, together with 15 volumes of the ninth annual issue and 4 volumes of the tenth annual issue, making a total of 155 volumes of the regular catalogue.

Following an established policy to consolidate the catalogue whenever possible with similar enterprises, an agreement has been made with the International Seismological Association whereby the yearly International Catalogue volume on geology will be enlarged and the section "Internal dynamics," containing an index to seismology, be published not only as a regular part of the International Catalogue, but also separately for the use of the International Seismological Association.

It is a matter of regret that this bureau is not yet able to afford the expense of issuing cards, in advance of the regular published volumes, for the immediate use of persons desiring prompt notice of papers appearing on any of the subjects embraced within the scope of the work. Plans having this object in view have been under consideration for some time, but as yet the necessary funds are not available for the purpose. It is not intended to issue cards in place of annual volumes, but to distribute classified index cards as soon as a paper is published, for the immediate information of those interested in the advance of science.

Very respectfully, yours,

LEONARD C. GUNNELL,
Assistant in Charge.

DR. CHARLES D. WALCOTT,
Secretary of the Smithsonian Institution.

APPENDIX 8.

REPORT ON THE PUBLICATIONS.

SIR: I have the honor to submit the following report on the publications of the Smithsonian Institution and its branches during the fiscal year ending June 30, 1912:

The Institution has published one memoir of the "Smithsonian Contributions to Knowledge," 35 papers of the "Smithsonian Miscellaneous Collections," and one annual report. There were also issued by the Bureau of Ethnology 1 annual report and 2 bulletins, and by the United States National Museum 53 miscellaneous papers of the Proceedings, 3 bulletins, and 5 parts of volumes pertaining to the National Herbarium.

SMITHSONIAN CONTRIBUTIONS TO KNOWLEDGE.

QUARTO.

1948. Langley memoir on mechanical flight. Part I, 1887 to 1896, by Samuel Pierpont Langley, edited by Charles M. Manly. Part II, 1897 to 1903, by Charles M. Manly. Published August 18, 1911. Pages i to x, 320, with 101 plates. Vol. 27, No. 3.

SMITHSONIAN MISCELLANEOUS COLLECTIONS.

OCTAVO.

In the series of Smithsonian Miscellaneous Collections there were published (1) 17 papers, cover and preliminary pages for volume 56; (2) 4 papers of volume 57; and (3) 14 papers of volume 59, as follows:

2014. Cambrian geology and paleontology. II. No. 5: Middle Cambrian Annelids. By Charles D. Walcott. Published September 4, 1911. Pages 109 to 144. Plates 18 to 23. Vol. 57, No. 5.

2015. Description of a new genus and species of hummingbird from Panama. By E. W. Nelson. Published July 8, 1911. Pages 2. Vol. 56, No. 21.

2051. Cambrian geology and paleontology. II. No. 6: Middle Cambrian Branchiopoda, Malacostraca, Trilobita, and Merostomata. By Charles D. Walcott. Published March 13, 1912. Pages 145 to 228, with unpagged index. Plates 24 to 34. Vol. 57, No. 6.

2053. Two new subspecies of birds from Panama. By E. W. Nelson. Published September 7, 1911. One page. Vol. 56, No. 22.

2054. On *Psomiocarpa*, a neglected genus of ferns. By Dr. H. Christ, Basel. Published November 21, 1911. Pages 4. Plate 1. Vol. 56, No. 23.

2055. A remarkable new fern from Panama. By William R. Maxon. Published November 22, 1911. Pages 5. Plates 3. Vol. 56, No. 24.

2056. Descriptions of seven new African grass-warblers of the genus *Cisticola*. By Edgar A. Mearns. Published November 23, 1911. Pages 6. Vol. 56, No. 25.
2058. A new kingfisher from Panama. By E. A. Goldman. Published December 1, 1911. Pages 2. Vol. 56, No. 27.
2059. Description of a new species of sunbird, *Helionympha raineyi*, from British East Africa. By Edgar A. Mearns. Published November 28, 1911. One page. Vol. 56, No. 28.
2062. Four new mammals from the Canadian Rockies. By N. Hollister. Published December 5, 1911. Pages 4. Vol. 56, No. 26.
2064. Three new club mosses from Panama. By William R. Maxon. Published January 6, 1912. Pages 4. Plates 4. Vol. 56, No. 29.
2066. A new subspecies of Ptarmigan from the Aleutian Islands. By A. C. Bent. Published January 6, 1912. Pages 2. Vol. 56, No. 30.
2067. Report on an investigation of the geological structure of the Alps. By Bailey Willis. Published February 7, 1912. Pages 13. Vol. 56, No. 31.
2068. Notes on birds observed during a brief visit to the Aleutian Islands and Bering Sea in 1911. By A. C. Bent. Published February 12, 1912. Pages 29. Vol. 56, No. 32.
2069. Three new plants from Alberta. By Paul C. Standley. Published February 7, 1912. Pages 3. Vol. 56, No. 33.
2070. A new leather flower from Illinois. By Paul C. Standley. Published February 7, 1912. Pages 3. Plate 1. Vol. 56, No. 34.
2071. The natives of Kharga Oasis, Egypt. By Aleš Hrdlička. Published April 15, 1912. Pages 118. Plates 38. Vol. 59, No. 1.
2072. New mammals from Canada, Alaska, and Kamchatka. By N. Hollister. Published February 7, 1912. Pages 8. Plates 3. Vol. 56, No. 35.
2073. Descriptions of twelve new species and subspecies of mammals from Panama. By E. A. Goldman. Published February 19, 1912. Pages 11. Vol. 56, No. 36.
2074. Descriptions of two new species of nun birds from Panama. By E. W. Nelson. Published February 16, 1912. Pages 2. Vol. 56, No. 37.
2075. Cambrian geology and paleontology. II. No. 7: Cambro-Ordovician boundary in British Columbia, with description of fossils. By Charles D. Walcott. Published March 8, 1912. Pages 229 to 237. Plate 35. Vol. 57, No. 7.
2076. Cambrian geology and paleontology. II. No. 8: The Sardinian Cambrian genus *Olenopsis* in America. Published March 8, 1912. Pages 239 to 249. Plate 36. Vol. 57, No. 8.
2077. New species of fossil shells from Panama and Costa Rica. Collected by D. F. MacDonald. By William Healey Dall. Published March 2, 1912. Pages 10. Vol. 59, No. 2.
2078. Description of a new subspecies of monkey from British East Africa. By N. Hollister. Published March 2, 1912. Pages 2. Vol. 59, No. 3.
2079. Descriptions of new genera and species of microlepidoptera from Panama. By August Busck. Published March 9, 1912. Pages 10. Plate 1. Vol. 59, No. 4.
2080. New genus and species of hymenoptera of the family Braconidæ from Panama. By H. L. Viereck. Published March 9, 1912. Pages 2. Vol. 59, No. 5.
2081. The genera of fossil whalebone whales allied to Balænoptera. By Frederick W. True. Published April 3, 1912. Pages 8. Vol. 59, No. 6.

2082. Observations on the habits of the crustacean *Emerita analoga*. By Frank Walter Weymouth and Charles Howard Richardson, jr. Published May 10, 1912. Pages 13. Plate 1. Vol. 59, No. 7.
2083. Hamilton lecture. Infection and recovery from infection. By Simon Flexner, M D. Published May 29, 1912. Pages 14. Plates 5. Vol. 59, No. 8.
2085. National Zoological Park. Notes on animals now, or recently, living in the National Zoological Park. By A. B. Baker. Published May 17, 1912. Pages 3. Plate 1. Vol. 59, No. 9.
2086. National Zoological Park. Further notes on the breeding of the American black bear in captivity. By A. B. Baker. Published May 17, 1912. Pages 4. Vol. 59, No. 10.
2088. Sawflies from Panama, with descriptions of new genera and species. By S. A. Rohwer. Published May 18, 1912. Pages 6. Vol. 59, No. 12.
2090. New decapod crustaceans from Panama. By Mary J. Rathbun. Published May 20, 1912. Pages 3. Vol. 59, No. 13.
2091. Smithsonian Miscellaneous Collections. Cover and preliminary pages for volume 56. Pages i to vii.
2092. Report on landshells collected in Peru in 1911 by the Yale expedition under Prof. Hiram Bingham, with descriptions of a new subgenus, a new species, and new varieties. By William Healey Dall. Published June 8, 1912. Pages 12. Vol. 59, No. 14.
2093. Names of the large wolves of northern and western North America. By Gerrit S. Miller, jr. Published June 8, 1912. Pages 5. Vol. 59, No. 15.

The following papers of the Smithsonian Miscellaneous Collections were in press at the close of the year:

1987. Bibliography of the geology and mineralogy of tin. By Frank L. and Eva Hess. Pages i to v, 408. Vol. 58, No. 2.
2087. Expeditions organized or participated in by the Smithsonian Institution in 1910 and 1911. Pages 51. Plate 1. Figs. 56. Vol. 59, No. 11.
2094. New rodents from British East Africa. By Eidmund Heller. Pages 20. Vol. 59, No. 16.
2133. New diptera from Panama. By J. R. Malloch. Pages 8. Vol. 59, No. 17.
2134. New species of landshells from the Panama Canal Zone. By William H. Dall. Pages 3. Plates 2. Vol. 59, No. 18.

SMITHSONIAN ANNUAL REPORTS.

The Annual Report of the Board of Regents for 1910 was published in January, 1912.

2050. Annual Report of the Board of Regents of the Smithsonian Institution, showing operations, expenditures, and conditions of the Institution for the year ending June 30, 1910. Octavo. Pages i to vii, 688. Plates 129 and 1 map. Containing publications 2001, 2002, and 2016-2049.

Small editions of the following papers, forming the general appendix of the Annual Report of the Board of Regents for 1910, were issued in pamphlet form:

2016. Melville Weston Fuller, 1833-1910, by Charles D. Walcott. Pages 113-123, with 1 plate.
2017. Ornamentation of rugs and carpets, by Alan S. Cole. Pages 125-144, with 6 plates.

2018. Recent progress in aviation, by Octave Chanute. Pages 145-167, with 19 plates.
2019. Progress in reclamation of arid lands in the western United States, by F. H. Newell. Pages 169-198, with 12 plates.
2020. Electric power from the Mississippi River, by Chester M. Clark. Pages 199-210, with 8 plates.
2021. Safety provisions in the United States Steel Corporation, by David S. Beyer. Pages 211-229, with 11 plates.
2022. The insolation of an ion, a precision measurement of its charge, and the correction of Stokes's Law, by R. A. Millikan. Pages 231-356.
2023. The telegraphy of photographs, wireless and by wire, by T. Thorne Baker. Pages 357-274, with 2 plates.
2024. Modern ideas on the constitution of matter, by Jean Becquerel. Pages 275-290.
2025. Some modern developments in methods of testing explosives, by Charles E. Munroe. Pages 291-306, with 12 plates.
2026. Sir William Huggins, by W. W. Campbell. Pages 307-317, with 1 plate.
2027. The solar constant of radiation, by C. G. Abbot. Pages 319-328.
2028. Astronomical problems of the Southern Hemisphere, by Heber D. Curtis. Pages 329-340.
2029. The progressive disclosure of the entire atmosphere of the sun, by Dr. H. Deslandres. Pages 341-356, with 4 plates.
2030. Recent progress in astrophysics in the United States, by J. Bosler. Pages 357-370, with 8 plates.
2031. The future habitability of the earth, by Thomas Chrowder Chamberlin. Pages 371-389.
2032. What is terra firma? A review of current research in isostasy, by Bailey Willis. Pages 391-406, with 3 plates.
2033. Transpiration and the ascent of sap, by Henry H. Dixon. Pages 407-425.
2034. The sacred ear-flower of the Aztecs, by William Edwin Safford. Pages 427-431, with 1 plate.
2035. Forest preservation, by Henry S. Graves. Pages 433-445, with 7 plates.
2036. Alexander Agassiz, 1835-1910, by Alfred Goldsborough Mayer. Pages 447-472, with 1 plate.
2037. Recent work on the determination of sex, by Leonard Doncaster. Pages 473-485.
2038. The significance of the pulse rate in vertebrate animals, by Florence Buchanan. Pages 487-505.
2039. The natural history of the solitary wasps of the genus *Synagris*, by E. Roubaud. Pages 507-525, with 4 plates.
2040. A contribution to the ecology of the adult Hoatzin, by C. William Beebe. Pages 527-543, with 7 plates.
2041. Migration of the Pacific plover to and from the Hawaiian Islands, by Henry W. Henshaw. Pages 545-559.
2042. The plumages of the ostrich, by Prof. J. E. Duerden. Pages 561-571, with 8 plates.
2043. Manifested life of tissues outside of the organism, by Alexis Carrel and Montrose T. Burrows. Pages 573-582.
2044. The origin of Druidism, by Julius Pokorny. Pages 583-597.
2045. Geographical and statistical view of the contemporary Slav peoples, by Lubor Niederle. Pages 599-612, with colored map.
2046. The cave dwellings of the Old and New Worlds, by J. Walter Fewkes. Pages 613-634, with 11 plates.

2047. The origin of West African crossbows, by Henry Balfour. Pages 635-650, with 1 plate.
2048. Sanitation on farms, by Allen W. Freeman. Pages 651-657.
2049. Epidemiology of tuberculosis, by Robert Koch. Pages 659-674.

The report of the executive committee and Proceedings of the Board of Regents of the Institution, as well as the report of the secretary, for the fiscal year ending June 30, 1911, both forming part of the annual report of the Board of Regents to Congress, were published in pamphlet form in December, 1911, as follows:

2061. Report of the executive committee and Proceedings of the Board of Regents for the year ending June 30, 1911. Pages 19.
2065. Report of the secretary of the Smithsonian Institution for the year ending June 30, 1911. Pages 91.

The general appendix to the Smithsonian Report for 1911 was in type, but actual presswork could not be completed before the close of the fiscal year. In the general appendix are the following papers:

- The gyrostatic compass, by H. Marchand.
- Radiotelegraphy, by G. Marconi.
- Multiplex telephony and telegraphy by means of electric waves guided by wires, by George O. Squier.
- Recent experiments with invisible light, by R. W. Wood.
- What electrochemistry is accomplishing, by Joseph W. Richards.
- Ancient and modern views regarding the chemical elements, by William Ramsay.
- The fundamental properties of the elements, by Theodore William Richards.
- The production and identification of artificial precious stones, by Noel Heaton.
- The sterilization of drinking water by ultra-violet radiations, by Jules Courmont.
- The legal time in various countries, by M. Philippot.
- Some recent interesting developments in astronomy, by J. S. Plaskett.
- The age of the earth, by J. Joly.
- International air map and aeronautical marks, by Ch. Lallemand.
- Geologic work of ants in tropical America, by J. C. Branner.
- On the value of the fossil floras of the arctic regions as evidence of geological climates, by A. G. Nathorst.
- Recent advances in our knowledge of the production of light by living organisms, by F. Alex. McDermott.
- Organic evolution; Darwinian and de Vriesian, by N. C. Macnamara.
- Magnalia nature: or the greater problems of biology, by D'Arcy Wentworth Thompson.
- A history of certain great horned owls, by Charles R. Keyes.
- The passenger pigeon, by Pehr Kalm (1759), and John James Audubon (1831).
- Note on the iridescent colors of birds and insects, by A. Mallock.
- On the positions assumed by birds in flight, by Bentley Beetham.
- The garden of serpents, Butantan, Brazil, by S. Pozzi.
- Some useful native plants from New Mexico, by Paul C. Standley.
- The tree ferns of North America, by William R. Maxon.
- The value of ancient Mexican manuscripts in the study of the general development of writing, by Alfred M. Tozzer.

- The discoverers of the art of iron manufacture, by W. Bøelck.
 The Kabyles of north Africa, by A. Lissauer.
 Chinese architecture and its relation to Chinese culture, by Ernst Boerschmann.
 The Lolos of Kientchang, western China, by A. F. Legendre.
 The physiology of sleep, by R. Legendre.
 Profitable and fruitless lines of endeavor in public health work, by Edwin O. Jordan.
 Factory sanitation and efficiency, by C.-E. A. Winslow.
 The physiological influence of ozone, by Leonard Hill and Martin Flack.
 Traveling at high speeds on the surface of the earth and above it, by H. S. Hele-Shaw.
 Robert Koch, 1843-1910, by C. J. M.
 Sir Joseph Dalton Hooker, 1817-1911, by Lieut. Col. D. Prain.

SPECIAL PUBLICATIONS.

The following special publications were issued in octavo form, during the year:

2013. Opinions rendered by the International Commission on Zoological Nomenclature. Opinions 30-37. Published July, 1911. Pages 69-88.
 2060. Opinions rendered by the International Commission on Zoological Nomenclature. Opinions 38-51. Published February, 1912. Pages 89-117.
 2052. Classified list of Smithsonian Publications available for distribution, January, 1912. Published January, 1912. Pages vi, 29.
 2084. Publications of the Smithsonian Institution issued between January 1, and April 1, 1912. One page.
 A single folder, containing map showing Smithsonian and National Museum buildings, and information pertaining thereto.

There were no special publications in press at the close of the year.

PUBLICATIONS OF THE UNITED STATES NATIONAL MUSEUM.

The publications of the National Museum are: (a) The annual report to Congress; (b) the proceedings of the United States National Museum, and (c) the Bulletin of the United States National Museum, which includes the contributions from the United States National Herbarium. The editorship of these publications is vested in Dr. Marcus Benjamin.

The publications issued by the National Museum during the year comprised the annual report for 1911; papers 1848, 1853, 1856 to 1879 of volume 41, Proceedings; papers 1880 to 1906 of volume 42, Proceedings; three bulletins and five parts of Contributions from the National Herbarium.

The bulletins were as follows:

- No. 50, Part 5. Birds of North and Middle America, by Robert Ridgway.
 No. 77. The early Paleozoic Bryozoa of the Baltic Provinces, by Ray S. Bassler.
 No. 78. Catalogue of a selection of art objects from the Freer Collection exhibited in the new building of the National Museum.

In the series of Contributions from the National Herbarium (octavo) there appeared:

- Vol. 13, Part 11. The Allioniaceæ of Mexico and Central America, by Paul Standley.
 Vol. 13, Part 12. New or noteworthy plants from Columbia and Central America, by Henry Pittier.
 Vol. 14, Part 3. The Grama grasses: Bouteloua and related genera, by David Griffiths.
 Vol. 16, Part 1. Miscellaneous papers, by William R. Maxon, J. N. Rose, Paul Standley, and R. S. Williams.
 Vol. 16, Part 2. Studies of Tropical American Ferns, by William R. Maxon.

There were also published in completed form volumes 39, 40, and 41 of Proceedings, and a new edition of Bulletin 39, Part N.

PUBLICATIONS OF THE BUREAU OF AMERICAN ETHNOLOGY.

The publications of the bureau are discussed elsewhere in the Secretary's report. The editorial work is in the charge of Mr. J. G. Gurley.

One annual report and two bulletins were issued during the year, as follows:

- Twenty-seventh Annual Report, comprising the administrative report for the year ending June 30, 1906, and a paper entitled "The Omaha Tribe," by Alice C. Fletcher and Francis La Flesche. Published 1911. Royal octavo. Pages 1 to 672, with 65 plates and 132 figures.
 Bulletin 47. A dictionary of the Biloxi and Ofo Languages, with thirty-one Biloxi texts and numerous Biloxi phrases, by James Owen Dorsey and John R. Swanton. Published 1912. Octavo. Pages i to v, 340.
 Bulletin 49. List of publications of the Bureau of American Ethnology. Published 1911. Octavo. Pages 1 to 34.

PUBLICATIONS OF THE SMITHSONIAN ASTROPHYSICAL OBSERVATORY.

There were no new publications issued by the Astrophysical Observatory during the year.

PUBLICATIONS OF THE AMERICAN HISTORICAL ASSOCIATION.

The annual reports of the American Historical Association are transmitted by the association to the Secretary of the Smithsonian Institution, and are communicated to Congress under the provisions of the act of incorporation of the association.

Volume 2 of the annual report for 1908, sent to the printer April 26, 1910, was published during the past fiscal year. On account of the size of the work it was issued in two parts, pages 1 to 807, and 808 to 1617, and comprised Parts II and III of Texas Diplomatic Correspondence, edited by the late Prof. George P. Garrison.

There was also published the annual report for 1909, with the following contents:

1. Report of the proceedings of the twenty-fifth annual meeting of the American Historical Association, by Waldo G. Leland, secretary.
2. Twenty-fifth anniversary celebration: Proceedings of the Carnegie Hall meeting.
3. Report of the proceedings of the sixth annual meeting of the Pacific coast branch, by Jacob N. Bowman, secretary of the branch.
4. Western Asia in the reign of Sennacherib of Assyria (705-689), by Albert T. Olmstead.
5. The teaching of mediæval archæology, by Camille Enlart.
6. Paradoxes of Gladstone's popularity, by Edward Porritt.
7. Bismarck as historiographer, by Guy Stanton Ford.
8. Some aspects of postal extension into the West, by Julian P. Bretz.
9. Side lights on the Missouri compromise, by Frank Heywood Hodder.
10. Two studies in the history of the Pacific Northwest, by Edmond S. Meany:
 1. The towns of the Pacific Northwest were not founded on the fur trade.
 2. Morton Matthew McCarver, frontier city builder.
11. The place of the German element in American history, by Julius Goebel.
12. The Dutch element in American history, by H. T. Colenbrauder.
13. The Dutch element in the United States, by Ruth Putnam.
14. Report of the conference on the contribution of the Romance nations to the history of America, by William R. Shepherd.
15. Historical societies in Great Britain, by George W. Prothero.
16. The work of Dutch historical societies, by H. T. Colenbrauder.
17. The historical societies of France, by Camille Enlart.
18. The work of historical societies in Spain, by Rafael Altamira.
19. Proceedings of the sixth annual conference of historical societies, by Waldo G. Leland.
20. Tenth annual report of the public archives commission.
 - Appendix A. Proceedings of the first annual conference of archivists.
 - Appendix B. Report on the archives of the State of Illinois, by C. W. Alvord and T. C. Pease.
 - Appendix C. Report on the archives of New Mexico, by J. H. Vaughan.
21. Writings on American history, 1909, by Grace G. Griffin.

The manuscript of volume 1 of the annual report for 1910 was sent to the printer June 2, 1911.

PUBLICATIONS OF THE SOCIETY OF THE DAUGHTERS OF THE AMERICAN REVOLUTION.

The manuscript of the Fourteenth Annual Report of the National Society of the Daughters of the American Revolution, for the year ending October 11, 1911, was communicated to Congress February 26, 1912.

THE SMITHSONIAN ADVISORY COMMITTEE ON PRINTING AND PUBLICATION.

The editor has continued to serve as secretary of the Smithsonian advisory committee on printing and publication. To this committee

have been referred the manuscripts proposed for publication by the various branches of the Institution, as well as those offered for printing in the Smithsonian Miscellaneous Collections. The committee also considered forms of routine blanks and various matters pertaining to printing and publication, including the qualities of paper suitable for text and plates. Twenty-one meetings were held and 156 manuscripts were acted upon.

Respectfully submitted.

A. HOWARD CLARK, *Editor.*

Dr. CHARLES D. WALCOTT,
Secretary of the Smithsonian Institution.

REPORT OF THE EXECUTIVE COMMITTEE OF THE BOARD OF REGENTS OF THE SMITHSONIAN INSTITUTION FOR THE YEAR ENDING JUNE 30, 1912.

—————

To the Board of Regents of the Smithsonian Institution:

Your executive committee respectfully submits the following report in relation to the funds, receipts, and disbursements of the Institution, and a statement of the appropriations by Congress for the National Museum, the International Exchanges, the Bureau of American Ethnology, the National Zoological Park, the Astrophysical Observatory, and the International Catalogue of Scientific Literature for the year ending June 30, 1912, together with balances of previous appropriations.

SMITHSONIAN INSTITUTION.

Condition of the fund July 1, 1912.

The permanent fund of the Institution and the sources from which it has been derived are as follows:

DEPOSITED IN THE TREASURY OF THE UNITED STATES.

Bequest of Smithson, 1846.....	\$515, 169. 00
Residuary legacy of Smithson, 1867.....	26, 210. 63
Deposit from savings of income, 1867.....	108, 620. 37
Bequest of James Hamilton, 1875.....	\$1, 000. 00
Accumulated interest on Hamilton fund, 1895.....	1, 000. 00
	2, 000. 00
Bequest of Simeon Habel, 1880.....	500. 00
Deposits from proceeds of sale of bonds, 1881.....	51, 500. 00
Gift of Thomas G. Hodgkins, 1891.....	200, 000. 00
Part of residuary legacy of Thomas G. Hodgkins, 1894.....	8, 000. 00
Deposit from savings of income, 1903.....	25, 000. 00
Residuary legacy of Thomas G. Hodgkins.....	7, 918. 69
	944, 918. 69
Total amount of fund in the United States Treasury.....	944, 918. 69

OTHER RESOURCES.

Registered and guaranteed bonds of the West Shore Railroad Co., part of legacy of Thomas G. Hodgkins (par value).....	42, 000. 00
	986, 918. 69
Total permanent fund.....	986, 918. 69

Also four small pieces of real estate bequeathed by Robert Stanton Avery, of Washington, D. C.

That part of the fund deposited in the Treasury of the United States bears interest at 6 per cent per annum, under the provisions of the act of Congress of August 10, 1846, organizing the Institution, and the act approved March 12, 1894. The rate of interest on the West Shore Railroad bonds is 4 per cent per annum. The real estate received from Robert Stanton Avery is exempt from taxation and yields only a nominal revenue from rentals.

Statement of receipts and disbursements from July 1, 1911, to June 30, 1912.

RECEIPTS.

Cash on deposit July 1, 1911.....	\$32,425.66
Interest on fund deposited in United States Treasury due July 1, 1911, and Jan. 1, 1912.....	\$56,695.12
Interest on West Shore R. R. bonds due July 1, 1911, and Jan. 1, 1912.....	1,680.00
Repayments, rentals, publications, etc.....	27,643.19
Contributions from various sources for specific purposes.....	21,150.00
	107,168.31
	139,593.97

DISBURSEMENTS.

Buildings, care and repairs.....	\$5,460.36
Furniture and fixtures.....	999.16
General expenses:	
Salaries.....	\$18,159.22
Meetings.....	225.75
Stationery.....	702.85
Postage, telegraph, and telephone.....	675.58
Freight.....	86.55
Incidentals.....	1,763.52
Garage.....	2,322.90
Fuel and lights.....	87.25
	24,023.62
Library.....	2,045.93
Publications and their distribution:	
Miscellaneous collections.....	4,014.72
Reports.....	284.61
Special publications.....	497.11
Publication supplies.....	423.13
Salaries.....	6,681.16
	11,900.73
Explorations, researches, and collections.....	19,191.37
Hodgkins specific fund, researches and publications.....	5,666.76
International Exchanges.....	6,121.32
Gallery of Art.....	252.63
Advances for field expenses, etc.....	30,872.00
	106,533.88
Balance, June 30, 1912, deposited with the Treasurer of the United States.....	33,060.09
	139,593.97

By authority, your executive committee again employed Mr. William L. Yaeger, a public accountant of this city, to audit the receipts and disbursements of the Smithsonian Institution during the period covered by this report. The following certificate of examination supports the foregoing statement, and is hereby approved:

WASHINGTON, D. C., August 5, 1912.

EXECUTIVE COMMITTEE, BOARD OF REGENTS,

Smithsonian Institution.

SIRS: I have examined the accounts and vouchers of the Smithsonian Institution for the fiscal year ending June 30, 1912, and certify the following to be a correct statement:

Total receipts.....	\$107,168.31
Total disbursements.....	106,533.88
<hr/>	
Excess of receipts over disbursements.....	634.43
Amount from July 1, 1911.....	32,425.66
<hr/>	
Balance on hand June 30, 1912.....	33,069.09
<hr/>	
Balance shown by Treasury statement June 30, 1912.....	36,738.54
Less outstanding checks.....	3,678.45
<hr/>	
True balance June 30, 1912.....	33,069.09

The vouchers representing payments from the Smithsonian income during the year, each of which bears the approval of the secretary, or, in his absence, of the acting secretary, and a certificate that the materials and services charged were applied to the purposes of the Institution, have been examined in connection with the books of the Institution and agree with them.

(Signed) WILLIAM L. YAEGER,
Public Accountant and Auditor.

All moneys received by the Smithsonian Institution from interest, sales, refunding of moneys temporarily advanced, or otherwise, are deposited with the Treasurer of the United States to the credit of the Institution, and all payments are made by checks signed by the secretary.

The expenditures made by the disbursing agent of the Institution and audited by the Auditor for the State and Other Departments are reported in detail to Congress and will be found in the printed document.

Your committee also presents the following summary of appropriations for the fiscal year 1912 intrusted by Congress to the care of the Smithsonian Institution, balances of previous appropriations at the beginning of the fiscal year, and amounts unexpended on June 30, 1912:

	Available after July 1, 1911.	Balance June 30, 1912.
Appropriations committed by Congress to the care of the Institution:		
International Exchanges, 1910.....	\$11.47	1 \$0.47
International Exchanges, 1911.....	2,323.68	5.02
International Exchanges, 1912.....	32,000.00	2,973.13
American Ethnology, 1910.....	237.06	1 229.66
American Ethnology, 1911.....	2,644.60	580.64
American Ethnology, 1912.....	42,000.00	2,576.64
Astrophysical Observatory, 1910.....	119.42	1 119.42
Astrophysical Observatory, 1911.....	1,063.22	213.83
Astrophysical Observatory, 1912.....	18,000.00	3,802.73
International Catalogue, 1910.....	1.71	1 1.71
International Catalogue, 1911.....	437.12	4.50
International Catalogue, 1912.....	7,500.00	682.04
Elevators, Smithsonian Building.....	946.06	946.06
National Museum—		
Furniture and fixtures, 1910.....	60.20	1 60.20
Furniture and fixtures, 1911.....	34,166.16	287.04
Furniture and fixtures, 1912.....	175,000.00	37,359.32
Heating and lighting, 1910.....	3,592.42	13,592.42
Heating and lighting, 1911.....	9,658.11	4,153.20
Heating and lighting, 1912.....	50,000.00	4,036.43
Preservation of collections, 1910.....	8,461.84	1 6,786.11
Preservation of collections, 1911.....	20,623.80	7,030.94
Preservation of collections, 1912.....	300,000.00	8,932.37
Books, 1910.....	19.56	1 8.22
Books, 1911.....	608.05	42.76
Books, 1912.....	2,000.00	690.30
Postage, 1912.....	500.00
Building repairs, 1910.....	20.30	1 20.30
Building repairs, 1911.....	3,513.87	108.19
Building repairs, 1912.....	15,000.00	4,751.95
Building, National Museum.....	22,902.78	1,675.65
National Zoological Park, 1910.....	4.56	1 4.56
National Zoological Park, 1911.....	6,589.53	10.74
National Zoological Park, 1912.....	100,000.00	4,970.35

¹ Carried to credit of surplus fund.

Statement of estimated income from the Smithsonian fund and from other sources, accrued and prospective, available during the fiscal year ending June 30, 1913.

Balance June 30, 1912.....	\$33,060.09
Interest on fund deposited in United States Treasury, due July 1, 1912, and Jan. 1, 1913.....	\$56,695.00
Interest on West Shore R. R. bonds, due July 1, 1912, and Jan. 1, 1913.....	1,680.00
Exchange repayments, sale of publications, rentals, etc..	8,500.00
Deposits for specific purposes.....	12,000.00
	78,875.00
Total available for year ending June 30, 1913.....	111,935.09

Respectfully submitted.

A. O. BACON,
ALEXANDER GRAHAM BELL,
JOHN DALZELL,

Executive Committee.

WASHINGTON, D. C., November 25, 1912.

PROCEEDINGS OF THE BOARD OF REGENTS OF THE SMITHSONIAN INSTITUTION FOR THE YEAR ENDING JUNE 30, 1912.

At a meeting of the Board of Regents, held December 14, 1909, the following resolution was adopted:

Resolved, That hereafter the Board of Regents of the Smithsonian Institution shall hold their annual meeting on the second Thursday in December, and a supplementary meeting on the second Thursday in February.

In accordance with this resolution the board met at 10 o'clock a. m., on December 14, 1911, and on February 8, 1912.

ANNUAL MEETING, DECEMBER 14, 1911.

Present: Hon. James S. Sherman, Vice President of the United States, chancellor, in the chair; Hon. Edward Douglass White, Chief Justice of the United States; Senator S. M. Cullom; Senator Henry Cabot Lodge; Senator A. O. Bacon; Representative John Dalzell; Representative James R. Mann; Mr. William M. Howard; Dr. Andrew D. White; Dr. Alexander Graham Bell; Mr. Charles F. Choate, Jr.; Mr. John B. Henderson, Jr.; and the secretary, Mr. Charles D. Walcott.

APPOINTMENT OF REGENTS.

The secretary announced the appointment of the following Regents: By the President of the Senate—Senator Henry Cabot Lodge, for his senatorial term of six years; by the Speaker of the House—Representatives John Dalzell, Scott Ferris, and Irvin S. Pepper, to serve until December 24, 1913; by joint resolution of Congress, approved by the President March 1, 1911—Mr. John B. Henderson, jr., for six years, to fill the vacancy caused by the resignation of Hon. John B. Henderson.

RESOLUTION RELATIVE TO INCOME AND EXPENDITURE.

Senator Bacon, chairman of the executive committee, presented the following resolution, which was adopted:

Resolved, That the income of the Institution for the fiscal year ending June 30, 1913, be appropriated for the service of the Institution, to be expended by the secretary, with the advice of the executive committee, with full discretion on the part of the secretary as to items.

ANNUAL REPORT OF THE EXECUTIVE COMMITTEE.

Senator Bacon submitted the report of the executive committee for the fiscal year ending June 30, 1911, stating that the members of the board had been supplied with copies in printed form.

On motion, the report was adopted.

ANNUAL REPORT OF THE PERMANENT COMMITTEE.

The secretary, on behalf of the permanent committee, presented the following report to the board:

"Cottrell patents.—Announcement was made at the meeting of February 9, 1911, of a proposed gift to the Institution, made through Prof. F. G. Cottrell, of royalty-bearing patents. The board, after discussion, adopted a resolution referring the matter of the suggested donation to the permanent committee.

"Your committee has carefully considered the proposition and is of the opinion, strengthened by the opinions of Judge Gray and Mr. Charles F. Choate, jr., Regents of the Institution, that it is inadvisable for the Institution to accept the direct ownership of such patent rights, but that there might be no objection to receiving the net profits of such a gift. The committee respectfully presents the following draft of resolutions to the board for such action as it may deem proper:

"Resolved, That the Board of Regents of the Smithsonian Institution do not deem it expedient for the Institution to become the direct owner of the proposed gift of royalty-bearing patents;

"Resolved further, That the Board of Regents of the Smithsonian Institution decide that the Institution may properly accept a declaration of trust from the owners of the patents to hold and operate the same in the interest of the Institution, and to pay over to the said Institution the net profits therefrom."

[The secretary described the nature of the patents, covering the processes used in the precipitation of solid particles from gases and smoke produced in smelters and cement plants. He stated that considerable injury had been suffered by orchards and crops in the neighborhood of the great cement plants in California, and that the companies had been subject to damage suits. The precipitation process had removed the particles of cement from the smoke and gases. Furthermore, the smoke in some smelters had been found to contain lead and other metals which could be removed by this process and thus save what otherwise would be lost. It was desired to form a company of business men and experts who could manage the patents and turn over the profits to the Institution. The work of the members of this company would be largely altruistic. They would give their attention to its affairs very much in the same manner as the Regents conduct the affairs of the Institution. They would employ a capable manager and assistants, who would look after the management and

commercial development of the patents. In this connection it would seem desirable that the company should have the support of the Institution to the extent that the secretary and the permanent committee, if desired, could take up with the members of the company the question of the appointment of the members of the board of directors, that they might be of such experience and ability that the best results would be secured from the patents. Without such co-operative support, it was doubtful whether the men best fitted to guide the affairs of the company would be willing to serve on the board of directors. This would not involve the management of the business by the Smithsonian Institution, but would strengthen the board of directors by the feeling that they had the opportunity of consulting with the secretary.

The secretary remarked further that the offer had come through Prof. F. G. Cottrell, professor of chemistry in the University of California. He represented a company which had been organized for the purpose of developing and carrying on the process. They desired to present the patents to a learned institution as a foundation for a research fund, and had decided to offer them to the Smithsonian Institution.]

After discussion, on motion, the resolutions were adopted.

[At this point Prof. Cottrell was introduced to the board and made a brief statement showing the development of the "Precipitation process" work, and assuring the board that it was proposed to give to the Institution the very fullest freedom in the use of the fund, he and his associates not wishing to be represented in the least degree, though desiring to assist in any manner possible.

Prof. Cottrell gave several instances of the establishment of plants ranging from a cost of \$2,000 for the first one to a cost of about \$125,000 for one soon to be erected, and explained that their work covered the abating of smoke nuisances, as well as the economic object of saving the solids in the gases and smoke. In this way it was estimated that one company would save from \$50,000 to \$100,000 a year by the precipitation of lead from the smoke passing out of its stacks, and others had been saved damage suits by the precipitation of matter contained in the gases and smoke passing into the air, which had formerly done great injury to crops.]

"The George W. Poore bequest.—The committee also took under consideration the matter of the George W. Poore bequest. The board will remember that at the last meeting it was announced that Mr. Poore had made the Institution the residual legatee of his estate, which was estimated to be worth about \$40,000, under the condition that the income from this sum should be added to the principal until a total of \$250,000 should be reached. Mr. Choate has been very kindly looking after the interests of the Institution and has recom-

mended that the executor be authorized to sell at the best prices obtainable the several lots of real estate included in Mr. Poore's holdings. The executor submitted his appraisal of these properties, and an independent appraisal has also been made by a real estate broker of Lowell. These differed so widely that your committee has thought it best to request Mr. Choate to direct that a third appraisal be made by a totally disinterested party. Mr. Choate has consented to see that this is done at the earliest possible moment.

"*The Langley Monument fund.*—Mr. J. D. Lyon, of Pittsburgh, Pa., has requested the Smithsonian Institution to receive contributions for the purpose of erecting a monument to the late Secretary Langley, in commemoration of his work in the science of aviation. Mr. Lyon inclosed his personal check for \$200 as a beginning of the fund. Your committee sees no objection to the Institution acting as the custodian of such a fund, nor to the secretary taking the matter up informally with the Aero Club of Washington.

"*The Hodgkins and Avery funds.*—These funds remain in the same condition as last reported."

[The secretary said that in connection with the Langley Monument fund he desired to add to the report that he had heard from the secretary of the Aero Club, who assured him that the matter in question would be placed before the officers and members of the club.]

On motion, the report of the permanent committee was accepted.

ANNUAL REPORT OF THE SECRETARY.

The secretary presented his report of the operations of the Institution for the year ending June 30, 1911, stating that it was already before the Regents in printed form.

In this connection the secretary pointed out to the Regents the publications that the Institution had issued during the year, which had been arranged on top of a bookcase, and said that since the last annual meeting in December, 1910, the Institution and its branches had printed a total of 173 publications, aggregating about 9,000 pages of text and 600 plates of illustrations. Included in this aggregate were 62 volumes and pamphlets (1,640 pages and 151 plates) published by the Institution proper; 105 volumes and pamphlets (4,123 pages and 319 plates) by the National Museum; and 12 volumes and pamphlets (3,300 pages and 120 plates) by the Bureau of American Ethnology.

During the year the Institution and its branches had distributed about 200,000 copies of their various publications. The publications issued by the Institution proper comprised the Langley Memoir on Mechanical Flight, a new edition of the Smithsonian Physical Tables, a series of papers descriptive of some of the results of the African expedition and of the biological survey of the Panama Canal Zone,

and of biological and geological work in the Canadian Rockies and anthropological work in Peru. The annual report of the Institution for 1910 was also issued as a complete volume and in small editions of the 34 papers in the Appendix on the usual wide range of topics. There were also in press a Bibliography of Tin, a report on the geological structure of the Alps, a physical study of the natives of the Kharga Oasis in Egypt, and several zoological and botanical papers.

The secretary added that the Museum publications were devoted almost entirely to biological topics, and that those of the Bureau of American Ethnology related chiefly to researches on the history, languages, and habits and customs of the American Indians.

On motion, the report was accepted.

THE LANGLEY MEMORIAL TABLET.

Senator Lodge, chairman of the committee on the Langley memorial tablet, presented the following report on behalf of the committee:

“Since the report of your committee at the last annual meeting of the board, on December 8, 1910, Mr. John Flanagan has presented a plaster cast of the model of the tablet for consideration.

“As the result of its deliberations your committee suggests the following resolution for such action as the board may see fit:

Resolved, That the tablet as presented to-day be accepted; and that in addition to the sum of \$300 for the model the sculptor be paid the sum of \$1,000 for casting in bronze and chasing and delivering the finished tablet ready for erection in the Institution building, the tablet to contain the following wording:

SAMUEL PIERPONT LANGLEY

1834-1906

Secretary of the Smithsonian Institution

1887-1906

Discovered the relations of speed and angle of inclination to the lifting power of surfaces moving in air

“I have brought to a close the portion of the work which seemed to be specially mine, the demonstration of the practicability of mechanical flight”

“The great universal highway overhead is now soon to be opened”—LANGLEY, 1901.

On motion, the resolution was adopted.

ACKNOWLEDGMENTS.

The secretary read the following letter from the Hon. John B. Henderson, whose resignation as a Regent took effect March 1, 1911:

MARCH 30, 1911.

DEAR MR. WALCOTT: I am much gratified and pleased by the receipt of the beautifully engrossed resolutions and of your very kind and appreciative letter.

My association with the Institution was always delightful, and I need hardly say that I shall continue as long as I live to take the keenest interest in the progress and welfare of the Smithsonian. With many thanks, I am,

Very sincerely, yours,

J. B. HENDERSON.

The secretary also read the following extract from a letter in relation to the resolutions adopted by the board on the death of Chief Justice Fuller:

These resolutions are a fitting and appropriate tribute to the late chancellor of the Institution, a man of such amiable and attractive character that I can not doubt his associates on the board sincerely mourned their loss in his death. I beg to express my appreciation of the action of the board in this matter.

THE FULLER MEMORIAL.

The secretary stated that at the meeting of the board held February 9, 1911, the following resolution was adopted:

Resolved, That the secretary be requested to prepare a suitable memorial of the life and work of the late Chief Justice Melville Weston Fuller, chancellor of the Smithsonian Institution from 1888 to 1910, which memorial is hereby declared approved for inclusion in the next annual report of the Board of Regents.

The secretary desired to report that in accordance with the requirements of the resolution he had prepared the memorial, which would be found in the annual report just issued.

SUNDAY OPENING OF THE NATIONAL MUSEUM.

The secretary said that at the meeting of February 10, 1910, the board adopted a resolution directing the secretary to provide for the opening on Sunday "for a period not longer than five hours of such portions of the National Museum as he may deem expedient."

He desired to report that the requirements of the resolution had been fulfilled and that the new building had been opened to the public on Sunday afternoons, beginning October 8. Nearly two-thirds of the exhibition space had been made accessible by introducing temporary installations where the permanent arrangements were not completed. That this innovation, which had been urged for many years, would greatly increase the usefulness and popularity of the Museum was indicated by the large attendance, which reached a total of 15,467 persons on the first day. This unusual number, largely induced by curiosity, was not repeated, but since then the daily Sunday average had been between 3,000 and 4,000, which is not greatly below the weekly average previously.

While the new building was structurally finished in June last, certain minor details remained to be completed, such as the painting of the interior of the rotunda and the final part of the work of grading and road building, all of which had been since completed.

The best efforts of the staff were being directed toward expediting the installations in the exhibition halls. This work was advancing as rapidly as possible, but the preparation and mounting of specimens and the building of cases was requiring much more time than had been expected.

The secretary then presented the following statements relating to explorations conducted, or participated in, by the Institution:

BIOLOGICAL SURVEY OF THE PANAMA CANAL ZONE.

“The secretary’s report contained a statement of what had been accomplished in connection with this survey up to the end of June. It seemed desirable that the work should be continued for another year, and the secretary requested the Secretaries of the Departments of Agriculture and of Commerce and Labor to renew the details of specialists for the purposes of the survey. The requests have already received favorable consideration.

“Special attention will be given during the coming season to vertebrate animals, insects, crustaceans, rotifers and other minute fresh-water animals, and also to the microscopic plants known as diatoms.

THE PAUL J. RAINEY AFRICAN EXPEDITION.

“Announcement was made at the meeting of the board on February 9, 1911, that Mr. Paul J. Rainey, of New York City, had in contemplation an expedition in Africa for the purpose of collecting natural history specimens which he desired to present to the Smithsonian Institution. At his request, Mr. Edmund Heller, one of the naturalists who went with Col. Roosevelt on a previous expedition, was designated to accompany Mr. Rainey. Mr. Heller left Washington on February 17 with the expectation of remaining abroad about a year.

“The regions in which these explorations have been made lie mostly to the north of the territory covered by the Smithsonian African expedition, though short trips were made to the southward, nearly to the border of German East Africa. Several isolated mountains not hitherto visited by naturalists were carefully explored and the scientific results can not fail to be of great importance.

“At the date of his last report, November 3, 1911, Mr. Heller had secured about 700 large mammals, 3,000 small mammals, and 250 birds. Thanks to Mr. Rainey, this magnificent collection has cost the Government only its transportation from Africa and Mr. Heller’s salary and outfit. In the field Mr. Heller has been supplied wholly at Mr. Rainey’s expense with a corps of from 20 to 30 assistants and with every facility that money could procure. This unique opportunity has been utilized to the fullest extent by Mr. Heller, and the

Institution may regard itself as fortunate in having the cooperation of two such men.

“Mr. Rainey has intimated that he will probably conduct an expedition in India next year, and that he will wish to have Mr. Heller with him on that occasion also.

THE CHILDS FRICK EXPEDITION.

“Mr. Childs Frick, of New York City, has organized and financed an expedition into Abyssinia under his own leadership for the purpose of hunting and making natural history collections. The party includes Lieut. Col. Edgar A. Mearns, United States Army, retired, who, as the board will remember, accompanied Col. Roosevelt on the Smithsonian African expedition. Col. Mearns will collect and prepare birds which will be presented by Mr. Frick to the Smithsonian Institution for the National Museum collections.

“Col. Mearns sailed in November, expecting to meet the other members of the party in London, whence they were all to proceed to Aden, from which point they will cross the Gulf of Aden and go directly into the wilderness. It is expected that the expedition will be in the field about seven months.

HAMILTON LECTURES.

“The board is aware that in 1874 Mr. James Hamilton made a donation of \$1,000 to the Institution, the income of which was to be used for the purpose of providing lectures on scientific or useful subjects. The interest on this fund was allowed to accumulate until it had reached the sum of \$1,000 which was added to the original bequest. Under this augmented fund, lectures have been delivered by Dr. Andrew D. White and Prof. George E. Hale. The third lecture will be delivered by Dr. Simon Flexner, director of the Rockefeller Institute for Medical Research, on the evening of February 8, 1912, which, being the second Thursday in February, will be the date of the board's spring meeting.”

There being no further business, on motion the board adjourned.

REGULAR MEETING, FEBRUARY 8, 1912.

Present: Hon. James S. Sherman, Vice President of the United States, chancellor, in the chair; Hon. Edward Douglass White, Chief Justice of the United States; Senator A. O. Bacon; Representative Scott Ferris; Representative Irvin S. Pepper; Hon. George Gray; Dr. Alexander Graham Bell; and the secretary, Mr. Charles D. Walcott.

RESIGNATION OF DR. JAMES B. ANGELL.

The secretary read the following letter:

ANN ARBOR, MICH., *January 15, 1912.*

Dr. C. D. WALCOTT,

Secretary, Smithsonian Institution.

DEAR SIR: Allow me to tender my resignation as a Regent of the Institution. I do so reluctantly, as I have enjoyed my relations to the board and to yourself and to your predecessor.

But I am sure it will be wiser to appoint in my place some one who can attend the meetings more regularly than in all probability I shall be able to do in the future.

With best wishes for the prosperity of the Institution, I am,

Yours, very truly,

JAMES B. ANGELL.

The secretary said that Dr. Angell had been first appointed as Regent on January 19, 1887, and had therefore served in that capacity for over 25 years, being in fact the dean of the "citizen" class of Regents.

Dr. Bell offered the following resolution, which was adopted:

Whereas the Board of Regents of the Smithsonian Institution having learned that Dr. James Burrill Angell has tendered his resignation as a Regent, after an honorable service in that capacity for over 25 years:

Resolved, That the Regents desire here to record their sincere regret at the withdrawal from their body of so distinguished a colleague, their appreciation of the value of his services to the Institution, and their assurances that in thus lessening the burdens of a long and useful career he has their earnest wishes that the years remaining to him may be replete with health and happiness.

The chancellor announced the adoption of the resolution, with the suggestion that, as customary, an engrossed copy be sent to Dr. Angell.

COTTRELL PATENTS.

The secretary briefly sketched the action of the board at the last meeting in adopting resolutions declaring that while the Institution could not accept the direct ownership of these patents, it would accept the net profits resulting therefrom; and stated that he had seen Prof. Cottrell several times since then in relation to the formation of the Research Corporation suggested for the purpose of handling the business in connection with the matter. He then read the draft of a proposed charter for the corporation referred to, and said that the names mentioned were those of business men of wide experience—men of affairs—who would be capable of administering a trust of the nature described.

He further said that a suggestion had been made that he, as an individual, entirely apart from his capacity as secretary of the Institution, should be in the corporation, to which the Regents consented.

WORK UNDER THE HARRIMAN TRUST FUND.

The secretary said that the board had been informed of the trust fund established by Mrs. Edward H. Harriman, to be administered under the direction of the Institution, for the purpose of an exhaustive study of the life of North American mammals by Dr. C. Hart Merriam, an eminent biologist, who is thus occupying a position which has been previously designated as a Smithsonian research associateship.

He stated that Dr. Merriam was engaged in the preparation of a comprehensive work and was also continuing field studies on the distribution of animals and plants, particularly on the Pacific coast; that during the past year he had gone over his voluminous notes and manuscript accumulations of a lifetime and brought them together in convenient form for ready reference.

He had been informed by Dr. Merriam that the first volume of his work on the mammals of North America, treating of the bears, was nearly ready for publication, and would probably go to press in a short time; that the second volume, treating of the wolves, coyotes, and foxes, was well in hand and would follow as early as practicable. The secretary said that in this connection it was gratifying to note that Dr. Merriam was receiving the cordial support of naturalists and museums throughout the United States and Canada, so that practically all the museum material known to exist in American collections had been placed at his disposal.

It was further remarked that Dr. Merriam was also conducting certain ethnological investigations among the little known and rapidly disappearing Indian tribes of California and Nevada; that from these he had already collected a large fund of original material, relating chiefly to distribution, languages, and mythology, and had, in advanced preparation, a book of creation stories and other tales, arranged on the plan adopted in his volume on the myths of the Mewan Tribes of California, already published.

REPORT ON EXPEDITIONS.

The secretary then made the following statement regarding expeditions and other matters of general interest:

“The Smithsonian African expedition under Col. Roosevelt undoubtedly created a wide interest among the friends of the Institution, and opportunities have occurred to benefit by similar expeditions undertaken by private initiative.”

“*Biological survey of the Panama Canal Zone.*—Mention has been made to the board and in the secretary’s reports of the biological survey of the Canal Zone. The work has been under way about a year and is not expected to be concluded until about the middle of the com-

ing summer. Data of much importance have been secured, and the results of the expedition will be certain to justify its organization. Many courtesies have been received from the Departments of Agriculture, War, and Commerce and Labor in the assignment of specialists for the work, and from the Panama Steamship & Railway Co. in providing for their transportation, and due acknowledgment has been made by the Institution.

"The Paul J. Rainey expedition.—The board was informed at the meeting on February 9, 1911, of the intention of Mr. Rainey to make an expedition into British East Africa for the collection of birds and mammals, and of his invitation to the Institution to send a naturalist with him, who would prepare these collections which would be presented to the Institution. Mr. Edmund Heller, who accompanied the Smithsonian African expedition, was designated for this duty, and left Washington on February 17 last. A brief report of the work was made to the board at the December meeting. The expedition is now completed, with results most satisfactory to Mr. Heller, who is at present in London studying types of mammals. He will shortly return to Washington to put the collection in order, and a report on the expedition will be made later.

"The Childs Frick expedition.—No information has been received from this expedition later than that presented to the board at the December meeting.

"Borneo expedition.—During the past 10 or 12 years Dr. W. L. Abbott, of Philadelphia, has been exploring the Malay Archipelago and has given all of his collections of vertebrates and ethnological material to the Institution for the United States National Museum. These contributions, so far as vertebrates are concerned, are undoubtedly the most important ever received by the Museum from any one person. Illness has recently put an end to Dr. Abbott's personal work, but his interest in the Institution does not seem to have abated. He has recently offered to pay the salary and expenses of a suitable man to continue the exploration of eastern Borneo, with the intention of further adding to his generous gifts to the Institution. Upon acceptance of the offer he engaged the services of Mr. Harry C. Raven, of New York, and placed at the disposal of the Institution the sum of \$3,000 for the purpose of beginning the work. A very recent letter from Dr. Abbott, who is now in England, contains the information that he will transmit to the Institution a further sum of \$2,000 in order to meet a total expenditure of \$5,000 if necessary in the conduct of the expedition. The outfitting for the trip is now under way.

"Siberian expedition.—Dr. Theodore Lyman, of Cambridge, Mass., has recently invited the cooperation of the Institution in an expedition to the Altai Mountains, Siberia, during the coming summer.

He offers to pay all expenses, except salary, of a representative of the Institution, who will make natural-history collections, the mammals to be deposited in the National Museum. Dr. Lyman is in correspondence with the American embassy at St. Petersburg as to the probable safety of such a journey, and will start at an early date if indications are favorable. It is expected that Mr. Ned Hollister, a Museum naturalist, will be designated to accompany Dr. Lyman.

Smithsonian Algerian expedition.—For several years, as has been stated in the secretary's reports, the Astrophysical Observatory of the Institution has been engaged in a study of the solar constant of radiation. The work has been conducted under the immediate supervision of Mr. Charles G. Abbot, director of the Observatory, whose studies at Washington, D. C., and Mount Wilson and Mount Whitney, Cal., indicated that the sun was probably a variable star, its radiations fluctuating from 2 per cent to 5 per cent during irregular periods of from 5 to 10 days' duration. This lack of constancy was so important that it seemed necessary to test it further by means of simultaneous observations held at Mount Wilson and some other high-altitude station remote from that point where an equally cloudless atmosphere existed.

“Mr. Abbot selected Algeria for these additional observations, and in July last established a station at Bassour, where until November he carried on the work with the assistance of Prof. Frank P. Brackett, of Pomona College, California. Similar observations were made at the same time by Mr. L. B. Aldrich at the station on Mount Wilson, which is separated from Bassour by a distance equal to about one-third of the earth's circumference.

“Mr. Abbot, though hampered by some unexpectedly cloudy weather, made successful observations on about thirty days, and while much computing and comparing remains to be done before the final results can be stated, a strong hope is entertained that they will go a long ways toward definitely solving the question as to the variability of the sun.

“The practical bearing of this work is important. Weather forecasting is not as yet an exact science, being in fact, except in the matter of pronounced storms and hot and cold waves, but little more than refined guesswork. If radiation proves to be a strongly controlling factor, forecasting would be much simplified.

NATIONAL MUSEUM.

Freer collection.—Preparations are now in progress looking to the temporary exhibition, beginning in April, 1912, of a selection of objects from the Charles L. Freer collection of American and oriental art. One of the large halls in the new Museum building will be used for the purpose, and during a period of about two months the

public will be given the opportunity of judging of the importance and varied character of this notable gift to the Nation.

MARKET SHEDS.

“A bill has been introduced in the House of Representatives at this session (H. R. 19127) which provides for the erection of steel shelter sheds for market purposes in the vacant squares, known as Haymarket Square, directly opposite the north front of the new building for the Museum. While these sheds might tend to make the square more tidy and presentable than it is now, the placing of such structures there would point to an intended long occupancy for market purposes, which is much to be regretted. A sketch plan of the square was shown.

INDIAN MEMORIAL BUILDING.

“Identical bills providing for an American Indian memorial and museum building and the assembling of a collection of objects relating to the Indians of North America were introduced in the Senate and House at the beginning of this session. They are numbered S. 3953 and H. R. 16313.

“The National Museum is the legal custodian of the ethnological and archaeological collections belonging to the Government, and these are now assembled and their public exhibition amply provided for in a monumental building which has cost \$3,500,000. It is not improbable, however, that the movement instituted by the Order of Red Men of the United States might result in bringing to Washington a very large additional amount of Indian material which would be of value; but, should the measure receive favorable action by Congress, the memorial should be placed under the supervision and control of the Regents of the Smithsonian Institution instead of the Secretary of the Interior. Only by such an arrangement could the proposed new collections be properly correlated with those belonging to the national collections; and, furthermore, such relationship with the Institution would insure greater economy of management, as the Institution already has an experienced administrative staff in the National Museum. A representative of the Improved Order of Red Men has given assurance that such a relationship to the Institution would be entirely agreeable to the order, and, accordingly, when requested by the chairman of the House Committee on Public Buildings and Grounds to indicate the Institution's view of the bill, the following letter was sent:

JANUARY 22, 1912.

DEAR SIR: I beg to acknowledge the receipt of your communication of the 13th instant, inclosing a copy of H. R. 16313, being a bill “Providing for the erection of an American Indian memorial and museum building in the city of

Washington, District of Columbia," and requesting such data relating thereto as I may be able to assemble.

I would first note that the matter was originally brought to the attention of the Sixty-first Congress, third session, in identical bills submitted to the Senate and House of Representatives, in which, while the erection of such a museum building was provided for, the precise object of the memorial was not stated. The present bill expressly defines the object of the museum, namely, to house such relics relating presumably to the American Indians as may be contributed for the purpose from private sources, one of which, a patriotic organization, is specifically mentioned. While it is not so stated, it is assumed that the contributions are intended to be of the nature of gifts to the Government and therefore to become its absolute property, though the offer of loan exhibits is to be expected and their acceptance is to be considered a proper museum function.

The National Museum, constituted, by act of Congress of August 10, 1846, a part of the organization of the Smithsonian Institution, is the depository for all Government collections, in which the subject of the American Indians is one of the most prominent and most extensively represented. These collections have resulted from Government surveys and expeditions and from contributions from many private sources. In the new building recently completed for the National Museum at a cost to the Government of \$3,500,000 and containing some 10 acres of floor space, about one-third of the area is devoted to the subject of ethnology and archæology, illustrative mainly of the North American Indians.

With reference to the memorial and museum provided for in H. R. 16313, I have, besides the facts recited in the bill, only certain general information obtained informally, but I have been given to understand that if the proposed measure is carried out the influences back of it are sufficiently wide and potent to cause to be brought to Washington a large amount of material relating to the Indians of the country, which would otherwise remain scattered and unavailable for study. If this be the case, it would seem that much good might result from the movement.

There is one matter covered by the bill, however, to which I would invite special attention. It is proposed that the memorial be under the supervision and control of the Secretary of the Interior. I am not informed as to the position or wishes of the Department of the Interior in the matter, but I respectfully suggest that, in case the bill be considered favorably, the question of placing the memorial and museum under the custody of the Regents of the Smithsonian Institution be given serious thought, since with an experienced administration already established it would appear that the affairs of the proposed museum might be conducted more economically under the Institution than otherwise. The opportunity would also thus be afforded for coordinating the collections with those in the National Museum in such manner as to secure the best results for the public.

The copy of the bill which you forwarded is returned herewith, as requested.

Very truly, yours,

CHARLES D. WALCOTT, *Secretary.*

The honorable MORRIS SHEPPARD,

Chairman, Committee on Public Buildings and Grounds,

United States House of Representatives, Washington, D. C.

DISTRIBUTION OF GOVERNMENT PUBLICATIONS ISSUED UNDER
THE INSTITUTION.

“In a message to Congress, dated February 5, 1912, the President transmits three reports from the Commission on Economy and Efficiency, one of which relates to ‘The centralization of the distribution of Government publications.’ On this subject the President remarks as follows:

The first report recommends that the work of distributing documents be centralized in the office of Superintendent of Public Documents in the Government Printing Office as a substitute for the present method of distribution by each of the departments, offices, and bureaus issuing documents. The plan does not contemplate any change in the authority which determines the persons to whom documents shall be sent, but only that the physical work of wrapping, addressing, and mailing the documents shall be done at one place, and that the place of manufacture.

Documents are now printed and bound at the Printing Office and conveyed to the several departments and bureaus, where they are wrapped and addressed and sent to the post office, and afterwards from the post office to the railroad station, which is near the Printing Office. One result of the proposed plan will be to eliminate this unnecessary transportation of the large number of documents annually issued by the departments. Departments will be relieved of the trouble and expense of handling, storing, and accounting for documents; a better control can be exercised over the number of copies of a document to be printed at one time, or, when printed, the number to be bound from time to time; and the accumulation of undistributed copies of the same documents in several offices will be avoided.

The centralization of the work of wrapping and addressing documents will permit the use of the most improved mechanical devices and a saving of labor that is not possible when the work is done in many offices.

I approve this recommendation of the commission and commend it to the favorable consideration of the Congress.

“It is considered that the Institution is itself better prepared to attend directly to the distribution of its publications in the interest of the trusts confided to the Regents than through any outside agency. The publications of the Institution are not an incidental result of its work, but something planned for and systematically executed. The Institution keeps in touch with all the principal scientific and art establishments of the world, and with all experts in science and art who are promoting work in a line with its own, or who are in positions to help in securing collections, information, or advice. With the exception of certain public libraries, its mailing lists are, therefore, undergoing constant changes. The publications constitute an important asset, and through their judicious distribution have brought returns which could not have been obtained in any other way.

“Furthermore, a large proportion of the publications bear a date of issuance and must be mailed by or on that date to retain their value. They are received from the Printing Office from two to three

days in advance of the date, and it is inconceivable that any outside agency could be relied upon to insure their distribution with the promptness demanded. It is, consequently, felt that the control of this distribution should remain where it is.

“Reports on this subject were made to the President and to the Commission on Economy and Efficiency under dates of September 27 and November 8, last, and in these it was shown that the distributions were made on an exceedingly low basis of cost. In fact, all publications except those of the Museum are stored in and distributed from the Smithsonian building, which the Government is using without cost. The actual labor of wrapping, labeling, and handling the Smithsonian reports is furnished by the Institution and not by the Government. And from all points of view the transfer of the actual work of distribution to another establishment would distinctly tend to reduce the scientific value of the Smithsonian publications and to curtail the benefits which the Institution is deriving from them.”

SMITHSON RELICS.

“For many years the Smithson relics, those personal belongings that were a close and intimate part of the life of the founder, have been cared for in one of the south tower rooms known here as the old Regents’ room, because of its former use by the Regents for their meetings. This room is quite inaccessible, so it was decided to arrange the relics, temporarily at least, for exhibition in the central portion of the main hall of the Smithsonian building. They are in special cases under constant supervision, and have aroused a deep interest among those who are acquainted with the history of the Institution. Among the relics may be seen:

Copy of the matriculation register of Oxford University, showing the name by which Smithson was known in 1782—James Lewis Macie.

Several portraits of the founder.

A portrait of his father, Hugh Smithson, Duke of Northumberland.

Visiting cards.

Dinner cards.

His library.

Printed copies of papers on chemical subjects, written by Mr. Smithson.

Collection of autographs of scientific men, on notes written to Mr. Smithson.

His will, showing the wording that made the Smithsonian Institution possible.

[Incidentally, the secretary spoke of the collection of photographic portraits of Regents being made for permanent preservation, and which was on exhibition in the main hall.]

ADJOURNMENT.

There being no further business, on motion, the board adjourned.

GENERAL APPENDIX

TO THE

SMITHSONIAN REPORT FOR 1912



ADVERTISEMENT.

The object of the GENERAL APPENDIX to the Annual Report of the Smithsonian Institution is to furnish brief accounts of scientific discovery in particular directions; reports of investigations made by collaborators of the Institution; and memoirs of a general character or on special topics that are of interest or value to the numerous correspondents of the Institution.

It has been a prominent object of the Board of Regents of the Smithsonian Institution, from a very early date, to enrich the annual report required of them by law with memoirs illustrating the more remarkable and important developments in physical and biological discovery, as well as showing the general character of the operations of the Institution; and this purpose has, during the greater part of its history, been carried out largely by the publication of such papers as would possess an interest to all attracted by scientific progress.

In 1880 the secretary, induced in part by the discontinuance of an annual summary of progress which for 30 years previous had been issued by well-known private publishing firms, had prepared by competent collaborators a series of abstracts, showing concisely the prominent features of recent scientific progress in astronomy, geology, meteorology, physics, chemistry, mineralogy, botany, zoology, and anthropology. This latter plan was continued, though not altogether satisfactorily, down to and including the year 1888.

In the report for 1889 a return was made to the earlier method of presenting a miscellaneous selection of papers (some of them original) embracing a considerable range of scientific investigation and discussion. This method has been continued in the present report for 1912.

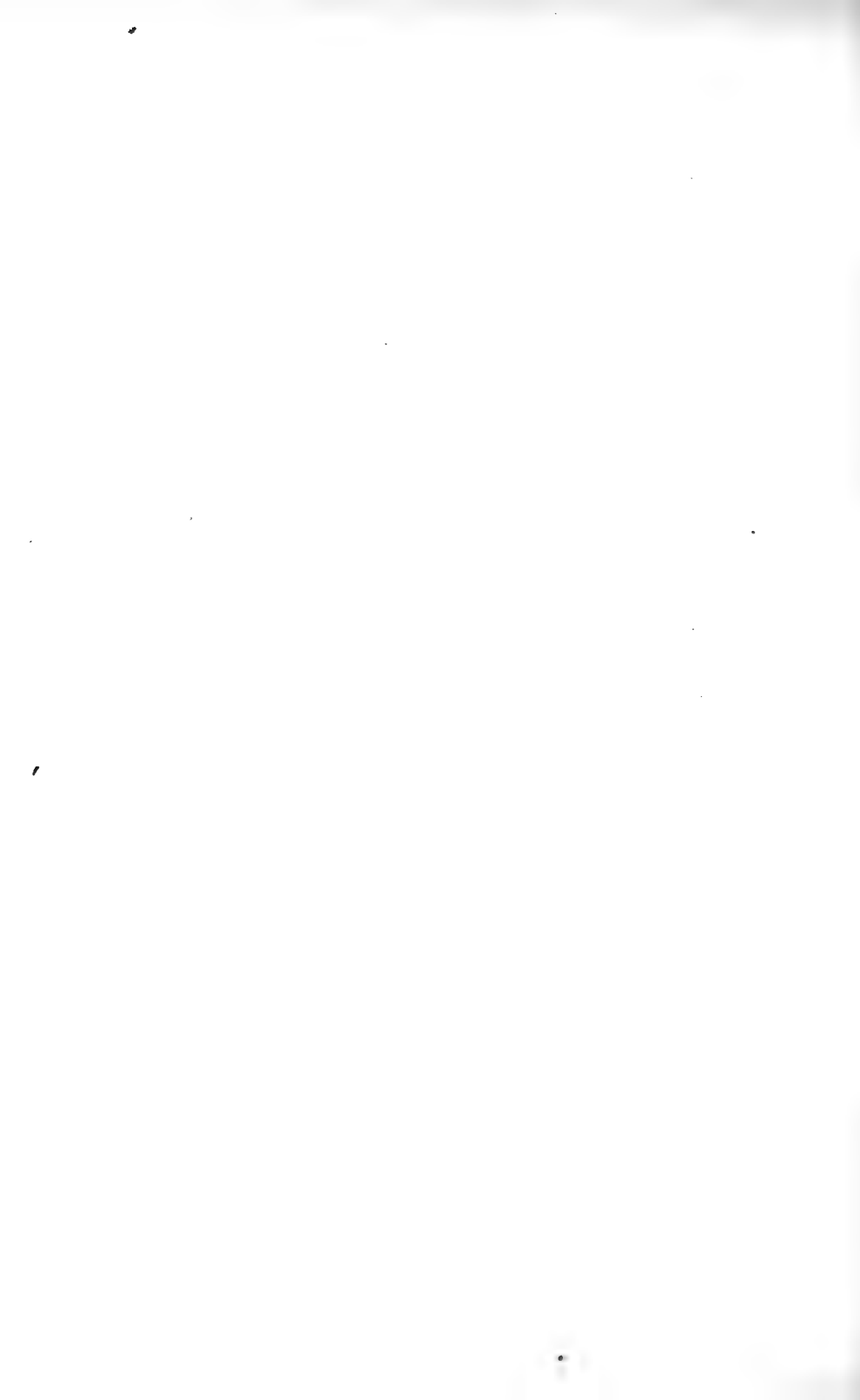

THE YEAR'S PROGRESS IN ASTRONOMY.¹

By P. PUISEUX,

Member of the Academy of Sciences, Professor at the Sorbonne, Astronomer at the Paris Observatory.

I.

It is an illogical peculiarity of the human mind that while it can not comprehend an infinite material universe it readily refuses to limit it. Those celestial objects which hide themselves from our curiosity by their almost inconceivable distances are to the astronomer the most attractive of all. He dislikes to realize the invariable appearance of the nebulae, or that he can not measure their distances with any approach of accuracy. Because he can find no better mode of inquiry he improvises one based upon a reasonable evolutionary theory. These impalpable phantoms he puts to the tests of his laws of mechanics, of physics, to the reactions of chemistry, a legitimate procedure, since it suggests consequences the verification of which he may attempt.

The spiral nebulae, with their sharply defined structure and a spectrum which is a weakened replica not too much altered of the sun, takes us into a region relatively well known. But when we consider the gaseous nebulae, those pale, undefined flakes so constituted that they have defied the power of time, how can we establish any connection between them and our daily experiences? Their spectrum brings us little help. It shows in the most favorable circumstances four bright enigmatic lines with a few others which can be identified as due to hydrogen or helium.

We can not borrow any of the substance of the nebulae for analysis in our laboratory. To look upon each unknown line as an indication of a new element would be easy but futile. It might be useful, on the other hand, to invent some molecular structure for some one single element (which we will call nebulium) capable of producing all the lines of unknown origin. That is just what J. W. Nicholson² has done, who applied the theory of Johnstone Stoney and Ritz regarding

¹ Translated by permission from *Revue générale des Sciences pures et appliquées*, Paris, June 30, 1912, pp. 474-478.

² Session of the Royal Astronomical Society, Nov. 10, 1911.

the origin of spectrum lines. With four negative electrons revolving about a positive central body, 12 of the mysterious lines were explained, and with these several others which were attributed with no great certainty to hydrogen and helium.

This demonstration, of course, leaves much to be desired. But it is evident in what direction we must proceed to complete it. It is very probable that hydrogen and helium, because of their complex spectra, are not simple elements. What glory it would be if by some well-chosen process we could decompose either of them and make the complete spectrum of nebulium appear in our laboratory! Astronomers could then hand over to the chemists a conquest even more precious than was the discovery of helium.

While waiting for the realization of this bold synthesis we continue to proceed by analysis and classification. All the conclusions formerly held about nebulæ demand revision because of the amount and value of the recently obtained photographic evidence. Recently A. R. Hinks ¹ has devoted himself to such an analysis. With his wonted precision he has defined the characteristics which distinguish the various classes of nebulæ and star clusters and has found for each class its law of distribution in the heavens. We must discard the convenient and very simple law which stated the frequency of the occurrence of nebulæ and clusters as a function of the galactic latitude only.

There is a clearly marked distinction between the stellar and planetary nebulæ as well as between the annular and spiral ones. This fact gave Stratton ² a strong argument against the theory of T. J. J. See, who attributed a common origin to the last two kinds. The cosmogony of See, far outrunning the possibility of experimental evidence, creates other difficulties, and it seems to us that it has made no progress since its appearance toward being accepted. The same thing can be said of the mutual collisions of stars. Bickerton ³ has come forward as an advocate of them, and they should, according to him, give birth to double stars as well as to planetary systems. A hazardous theory may prove useful because of the verifications it necessitates. For instance, Monk ⁴ showed that we ought to keep tab on the displacements of the spectrum lines so as to know in advance of imminent collisions, and Forbes ⁵ demonstrated that by a similar process we could obtain evidence concerning the rotation of certain stars about their centers. An attempt with encouraging results has already been made as to the latter problem at the Allegheny Observatory.

¹ Monthly Notices, May, 1911.

² The Observatory, September, 1911.

³ Session of the Royal Astronomical Society, Jan. 25, 1911.

⁴ The Observatory, vol. 24, p. 202.

⁵ Monthly Notices, vol. 72, p. 378.

The probability of a collision sometime in the globular clusters seems especially great. They are considered, with good reason, among the most curious objects in the heavens. If we suppose that the closeness of the stars in these clusters depends on the distances of the stars from the centers of the clusters, then we may get their real distances from their apparent distances. H. C. Plummer¹ did so for M 13² and found groupings which would have been predicted by the theory of gases in convective and isothermal equilibrium. This is one more fact to make us believe that in clusters as well as in the nebulae the force of gravitation is absent or held in check by some repulsive force.

We indeed go yet further and ask whether the law of Newton is always applicable among the stars relatively near for which we have been able to measure the parallaxes and proper motions. We possess decided evidence in favor of the affirmative from binary stars, in the fact that their proper motions follow directions more often parallel to the galaxy than perpendicular. But there are also motives for doubt.

W. W. Campbell, by means of his valuable catalogue of the radial velocities of stars, has shown that the Orion spectrum type is always associated with small velocities. This suggestion, resulting from no preconceived idea, quickly underwent broader developments. It has consequently become of philosophical interest. We seem to have gained now in the old system of classifying the stars, which was founded upon increasing complexity in their spectra, at the same time an ascending scale for their velocities and a descending one for their masses and distances from the sun. Of course there are often individual exceptions, and the above rules apply only when the stars are averaged in groups.

The consequences of these generalizations have been skilfully followed out by J. Halm.³ It was an advance to be able to use as criteria for a classification the masses and velocities, rather than the ages, temperatures, or spectrum types. The first two properties are more fundamental and more apt to enter into our formulæ. The existence of a correlation between the masses and the velocities is even more worthy of remark. It makes us wonder whether there is an equipartition of energy between the groups of stars just as there is between the molecules of a gas in equilibrium. Such a state would not have resulted under the influence of a Newtonian field of force including all the stars. Such movements are rather the final consequence of an initial velocity varying widely between neighboring stars. Further, the predominance of yellow stars near our sun and of white stars farther away, the existence of an ellipsoidal distribution of the trajectories in the central part of our universe, establishes

¹Monthly Notices, vol. 71, p. 460. ²Monthly Notices, vol. 72, p. 378. ³Monthly Notices, vol. 71, p. 610.

between the milky way and the great spiral nebulæ a singularly closer analogy than we had felt warranted in supposing until quite recently.

The new star discovered December 30, 1910, in the constellation of the Lizard, has followed its predicted career, fading rather slowly. It becomes more and more certain that temporary stars, even when they show the ruddy aspect of certain periodic variables, show less difference between the visual and photographic magnitudes.

The polar star often used as a standard for photometric comparisons because it remains constantly at practically the same altitude, seems to have abdicated that rôle and passed into the ranks of the variable stars. In order to show its variability, Hertzsprung¹ went through the discussion of 418 photographs, each having four exposures. The variation amounts to 0.2 of a magnitude and takes place in less than four days.

II.

The step from variable stars to the sun is very easy. It is especially so because of the recent work of C. G. Abbot.² Measures upon the intensity of the solar radiation made simultaneously on Mount Wilson (1,800 meters altitude) and on Mount Whitney (4,420 meters) gave very concordant results and the parallel march of the numbers places beyond doubt a very decided variability of the sun which may amount to a tenth of the total radiation within a few days.

The work of Abbot tends also to show that the precision with which we may state the temperature of the sun has been exaggerated. There are in the sun sources of heat from 5,000° up to some 7,000°. However, the higher temperatures predominate. The infra-red radiation comes from the deeper layers.

Some years ago the researches of Halm appeared to indicate that the rate of rotation of the sun, varying as we knew with the solar latitude, varies also synchronously with the sun-spot cycle. The investigation of this matter remains upon the program of the Edinburgh Observatory. But between the results obtained by Storey and those by Adams at Mount Wilson there is a systematic difference. It might be suspected that with one or the other the distance of the slit of the spectroscope from the edge of the sun was not correctly determined. Or the cause of the discrepancy may lie in the telluric oxygen lines used for comparisons.

The established but not absolutely regular correlation which exists between magnetic disturbances and the appearance of sun spots seems to have been made decidedly clearer by the researches of Bosler, of the

¹ *Astronomische Nachrichten*, No. 4518.

² Report of the Astrophysical Observatory of the Smithsonian Institution.

observatory at Meudon. Bosler has succeeded in proving that in each locality there is a definite direction not only for the earth current but also for the disturbed magnetic field and this takes place as if due to the direct action of a current upon a magnetized needle. Another result of the same research was to show yet more clearly that the years when the sun spots have been the most numerous have been those when Encke's comet has been the most brilliant.

The total solar eclipse of April 28, 1911, was observed by several expeditions sent for that purpose to Vavau of the Tonga Islands. The weather was unfavorable. We must mention in passing one new result, the photograph taken by Father Cortie of the extreme red end of the bright line spectrum.

The army of minor planets continues to grow. The most interesting without doubt was that observed on October 3 and 4 at Vienna and Copenhagen and designated by the letters MT. Its motion determined at that time indicated that its distance was as small as that of Eros. But it could not be found again on subsequent days. We are forced to believe that its brightness varies rapidly and that it was visible on the earlier dates because of an exceptional temporary brightness.

Birkland, while trying to reproduce the solar corona by means of the luminous phenomena about an electrified sphere, got a very close representation of the ring system of Saturn. He was thus led to propose a new theory of those singular objects. Particles of radiant matter, emitted from Saturn, reach a certain distance, make their revolutions according to the third law of Kepler, and serve as absorbers and resonators for the luminous energy coming from the sun.

The flattening of the planet Mars and the orientation in space of its axis of rotation rested until recently upon very discordant data from the micrometer. H. Struve, in a communication to the Berlin Academy of Sciences (Nov. 30, 1911), showed that by a very laborious but surer process depending on the variations in the orbits of its satellites, he had reached much better values. The best series was furnished by the powerful instruments of the Lick and the Yerkes Observatories. A very useful series of photographs of the satellites was obtained at the observatory at Pulkova by Kostinsky. The figure 190.4 for the reciprocal of the flattening and 202.7 for the ratio of the force of gravity to the centrifugal force at the equator will doubtless receive only insignificant changes.

The topography of the moon will now have a more solid basis as the result of the catalogue of 2,885 objects published by Saunder and based upon measures of plates taken at the Paris and the Yerkes Observatories. It is already in use at the Paris Observatory in a study of the libration of the moon. The uncertainty of a position derived from three plates appears to be less than $0.15''$. On our own

globe there are many extended regions which have no points so accurately determined.

The year 1911 saw published the tables of the moon based upon the theory of Delaunay and forming volume 7 of the *Annales du Bureau des Longitudes*. An introduction of 112 pages, where not a line is superfluous, allows us to form an idea of the magnitude of the task. Delaunay, Tisserand, and R. Radau have successively given to the task the last years of their lives and were assisted by Schulhof. An analogous undertaking was carried out in America by Prof. E. Brown; the French astronomers by finishing first have honorably maintained the tradition established by Laplace and Le Verrier. All the errors, although very small, known in the works of Hansen and Delaunay, have been corrected. But it was impossible to break away from all empiricism and there remains an inequality of long period (273 years) discovered by Newcomb. Newcomb gave up trying to find an explanation. More optimistic, R. Radau believes the cause can be found in cosmic dust and the infra-mercurial planets.

A new determination of the parallax of the moon, due to the collaboration of the Cape and the Greenwich Observatories has been carried out after six years of work.¹ The value generally used was confirmed.

III.

The result, at first sight rather small, of a considerable effort, is not to be understood as minimizing the desire often expressed of substituting for the classic method of charting the sky more rapid and more accurate methods. What is aimed at everywhere is the suppression of the measures of moderately large angles by the readings of divided circles. More confidence is placed in measures of time intervals and the extension of such a method is to be expected.

W. E. Cooke proposed, for the determination of right ascensions, not to use a meridian circle but rather a telescope whose optic axis when rotated about a vertical axis intersects in the heavens a small circle parallel to the horizon. We could by such means divide the celestial equator, or any parallel circle with an accuracy comparable with the precision of our best clocks. The declination of the stars would be determined from the times when they reached a determined altitude. The axis of the telescope must therefore be maintained at a constant altitude. At various times the realization of this condition has been attempted with telescopes on floating mounts. Cooke places faith in a vertical axis and level.

Among the disadvantages of the meridian instrument is the necessity that each celestial point has to be separately determined and that great intervals can not be measured as accurately as small ones.

¹ Session of the Royal Astronomical Society, May 12, 1911.

That photography can deal with small intervals with rapidity and great accuracy has been repeatedly shown. But it is desired to free the photographic plate from any dependency upon the meridian circle. H. H. Turner¹ has devised a very complete scheme. He proposes to gather, on the same plate, images of very distant portions of the sky, and believes he can register with the necessary precision the beginning of each exposure. The plan of Turner includes the use of two photographic telescopes mounted at right angles to each other in the equator and adjusted with a prismatic mirror. The project has received the approbation of the Astronomical and Astrophysical Society of America.²

But these methods have not received such emphatic approval everywhere. Before the Royal Astronomical Society Sir David Gill, Sir William Christie, and A. E. Conrady showed numerous reasons for fearing errors in the use of the new methods. According to them, the status of the meridian circle in fundamental astronomy is not yet in any way undermined.

In the past rival processes, even when recommended by illustrious names, have not realized the hopes of their promotors. Such was the case with the zenith telescope, or the alt-azimuth as introduced at Greenwich by Airy and the floating telescope in the hands of Chandler, Sampson, and Bryan Cookson. But it is true that photography introduces a new element into the problem and the experiments now in progress at Oxford deserve attention.

The resources of the photographic method will be yet greater when it is possible to utilize a greater field upon a single plate without the deformation of the images near the edges. Theoretically, curved plates could be employed which would comport better with the focal surfaces of the objectives. Such an attempt was made some 20 years ago at the beginning of the Celestial Chart project. It was not continued in use because such curved plates were not adapted to the micrometrical measuring machines. The difficulty has been overcome as the result of recent experiments at the Harvard College Observatory. The sensitive plate serves as the cover of a metallic box, from which the air may be removed. The atmospheric pressure upon the plate produces the desired curvature. When the air has been reintroduced, after the exposure, the plate loses its curvature and is developed and measured without difficulty.

A conference was held in Paris in October, 1911, by the representatives of all the great nations which publish official ephemerides (France, Germany, the United Kingdom, the United States of America). The resolutions unanimously adopted after very amicable discussions will introduce important economies in efforts, which up to

¹ Monthly Notices, vol. 71, pp. 422, 427.

² The Observatory, vol. 34, p. 233.

the present time have been duplicated. The positions of the planets will be determined only by two independent systems of tables. Greenwich time will be universally used for the ephemerides and unity will be observed for the more important constants (solar parallax, precession, nutation, aberration). The campaign actively pushed during recent years for carrying the aberration constant from $20.47''$ up to $20.53''$ can be considered as having failed. The latter figure is irreconcilable with the solar parallax obtained from the general discussion of the Eros observations.

THE SPIRAL NEBULÆ.¹

By P. PUISEUX,

Member of the Academy of Sciences, Professor at the Sorbonne, Astronomer at the Paris Observatory.

The people whom we claim as our direct intellectual ancestors wished to find nothing in the sky but spherical forms and circular movements. The Greeks, lovers of an exact geometry, the Latins, enamored of order and logic, took pleasure in simple combinations. They would not willingly admit into the celestial throng clouds of indefinite and complicated form. Such indefinite forms must belong to the sublunar world. Comets, with their hairy aspect, passed as meteors, taking their birth and vanishing within our atmosphere. In the Milky Way some saw an accidental derogation of the universal order or the trace of an imperfect joining of the two halves of the celestial sphere. Others guessed it to be a mass of numberless stars, too small and too distant to be separately seen. There was no need, indeed no possibility, of searching further. To those whom the idea of something beyond troubled, the existence of an empyrean was conceded, a luminous region situated beyond the stars, to which only those had access whose souls had become freed from the bonds of flesh.

But astronomy, no more than the other physical sciences, has kept within the bonds with which she was fettered in the name of philosophy. No sooner was the telescope invented than several observers used it to explore the sky. Then, as had been foreseen, the Milky Way was resolved almost entirely into separate luminous points. But, it is true, there were found a few refractory places, where the diffused whiteness persisted in filling the field of the telescope. Even outside the limits of the Milky Way, several such masses, more or less perceptible to the naked eye, refused to be decomposed. Simon Marius, in 1612, noted the great nebula of Andromeda, which suggested to him the comparison, somewhat trivial yet suggestive, of the flame of a candle seen through horn. This pale glow, watched for many years, seems to rest absolutely

¹ Address delivered before the Société des Amis de l'Université, Feb. 1, 1912. Translated by permission from *Revue Scientifique*, Paris, Apr. 6, 1912, pp. 417-422.

unchanged when compared with the adjacent stars. It is therefore neither a planet nor a meteor. It belongs to our sun no more than to the earth. Accordingly, if we admit the Copernican theory, we must attribute to this nebula colossal dimensions, far exceeding the distance which separates the earth from the sun.

Nor is the nebula of Andromeda an isolated case. Christian Huygens made a drawing in 1656 of a nebula in the constellation of Orion, a more brilliant and more extended object the outlines of which he found very difficult to trace. On one side only was it sharply defined against the adjacent sky. Elsewhere it faded into indistinguishable nebulosity. Does it not seem, mused Huygens, as if here we are looking upon a new world, perhaps upon the legendary empyrean? This feeble veil scarcely alters the aspect of the stars which shine through it or are projected upon it.

This somewhat summary sketch of Huygens was only vaguely confirmed by those of Picard and of Legentil who came several years later. The only common trait, indeed, was the dark gulf which hollows out the central part. No part of it seemed sufficiently definite for the detection of possible changes.

During the eighteenth century the number of known nebulae increased slowly. Several, upon closer examination, proved to be clusters of small stars. Those whose aspect remained flocculent, despite all efforts to resolve them, often deceived the comet seekers, who, after verification, saw their cherished hope of making the discovery of a new planetoid disappear. Messier, more than once thus caught, undertook to remove this cause of trouble and in 1784 published a catalogue of these objects, containing nearly all the nebulae easily seen above the horizon at the latitude of Paris.

At the same time a great advance was made in England in the means of observation. The musician, W. Herschel, succeeded during his leisure hours in figuring and mounting telescope mirrors much greater and much more perfect than had ever been made before. In the field of these instruments nebulae appeared in an absolutely unexpected profusion. Thus there arose a new branch of astronomy to be developed. Herschel set to work, aided by his sister Caroline, and with remarkable perseverance, at the same time pursuing other researches, catalogued, from 1786 to 1802, some 2,500 nebulae. Many of these, upon closer examination, were resolved into stars. W. Herschel was led to believe that all could be so resolved and that any one of these scarcely visible flocculent specks would, to an observer properly situated, appear like a stellar universe as rich as that which surrounds us and which is evident to our eyes through the milky way.

The work of W. Herschel was completed for the Southern Hemisphere by his son John, who transported in 1834 to the Cape of Good Hope one of the best telescopes constructed at Slough by his father.

Under a sky more transparent than that of England the harvest was yet richer and the general summary published in 1864 gave the positions of 5,079 of these objects. Very few nebulae found later worthy of interest escaped the eyes of the Herschels.

No thought was taken at that time as to what could be the origin of these curious objects. Their vague aspect gave little faith in their permanency. At one time the hope was held that they might rapidly change before our eyes. Laplace, after meditating upon the spherical or flattened figures of the planets, upon the existence of the ring system of Saturn, upon the close coincidence of the planes of the equators and the orbits of the planets, became convinced that the sun and the planets must have once been parts of the same large, very diffuse cloud. We might then expect the history of the solar system to repeat itself among the many other nebulous clouds in the realms of space. What would be more natural than to see among the nebulae successive stages in this evolution from such clouds, the material of suns and planets of the future. And, accordingly, he devised that celebrated hypothesis which has since been the cause of so many polemics.

For the convenience of reasoning, Laplace gave to his primitive cloud a figure of revolution, a general rotation about an axis and a density decreasing regularly from the center outward. Upon all these points the great mathematician showed no spirit of intolerance, and would have willingly consented to improvements. But it was much later that objections were raised.

The assiduous observers of nebulae found that these objects were mostly of a much less simple structure. This was shown first by the principal nebula of Orion, which was selected because of its extent and brightness. Within the same limits where Huygens drew a uniformly bright surface, astronomers provided with better telescopes found strong contrasts of light and shade, filaments and entangled jets, indications of physical connection between this cosmic cloud and numerous stars. All these points are revealed in the beautiful drawings left by J. Herschel, De Vico, W. Bond, Lassell, G. Bond, and Lord Rosse. The divergencies, often striking, may be interpreted through the marvellous plates taken by Prof. Ritchey at the Yerkes Observatory and at Mount Wilson. The same features are not shown by the various artists and by the chemical processes. Even photographic plates have their "personalities" as well as artists. However, we have the right to hope that the plates are more impartial in the features which they reproduce. The long exposures employed often destroy the details easily recognized by the eye in the central and brighter parts. But for the reproduction of the faint and more extended portions the superiority of the plates is unquestioned.

To sum up, the great nebula of Orion is a very complicated object, very rebellious against graphical representation by which means we had hoped to show by a comparison of drawings what changes may have taken place during the course of a century. The early drawings have in this respect very little value and the elaborate discussion which Holden based upon the sketches of Bond has not in general been found convincing.

This nebula departs too far from a globular form or rather from a figure of rotation to be taken as giving support to the Laplacian hypothesis. No one could trace in it a prelude to the formation of a narrow and regular ring surrounding a larger central body. Several annular nebulae were noted by W. Herschel, but among them not one had a nucleus of any importance.

If we must find in the sidereal universe a picture of what took place in our system, then we would have greater hope of finding it among the planetary nebulae. In the smaller telescopes they appear as small round, somewhat brilliant, diffused spots, but in stronger instruments like bright stars embedded in dense atmospheres. But such systems were too small and too distant to tell us much of the details of their structure before spectroscopic methods were developed.

Such was the condition of affairs when Lord Rosse, in 1850, showed the existence of a distinct series of nebulae, having besides the central nucleus several successive envelopes. But these envelopes, instead of being separate and concentric, as the advocates of Laplace's hypothesis would have expected, were spiral in form. They showed streamers, growing progressively larger, at first in the direction of the radius, then curved around all in the same sense. No theory had predicted such an appearance.

The instrument used by Lord Rosse and made under his direction was a gigantic telescope, 6 feet in aperture, a size not since surpassed despite many courageous attempts. Judging from drawings, it could have been used only near the meridian. Nor was sufficient protection provided against the weather, either for the observer or the mirror. The necessary access to the upper part of the tube was possible only by the use of heavy and complicated machinery. Such a piece of apparatus required the assiduous and careful maneuvering of several assistants. Official astronomers, with strict limitations and limited means, could obtain such cooperation only with great trouble and for very little time. Is it necessary to seek further for the reason why the great instruments of Lord Rosse and the Herschels, despite their great services, had such a short career and were used only by their makers?

The object which first seemed to offer to Lord Rosse an unusual character is numbered 51 in Messier's catalogue. It is to-day considered the most typical and the most curious of the spiral nebulae. If we examine how Lord Rosse drew it in 1850, we will find that the rays do not come out from the nucleus in all directions but normally and only from two diametrically opposite regions. The curvature, pronounced at the start, decreases later but irregularly. One of the spirals departing further from the center terminates in a secondary bright nucleus. The principal spiral continues its path undisturbed and completes at least a turn and a half before fading away. The appearance of these structures, so fine, so geometrical, so prolonged, gives the impression of a rapid whirling movement.

Long afterwards, in 1878, Lord Rosse returned to this same object. The general appearance remained the same, but the number of filaments, their fineness and regularity of curvature seemed much decreased. After mature examination, it appeared that the early appearance had been judged too geometrical just as seems to be the case with the canals of Mars. It looked as if now the principal spiral expands into the secondary nucleus.

Again, looking at the same object as photographed by Keeler at the Lick Observatory, it is evident that the second drawing of Lord Rosse is the more faithful. But other important details are brought to light. The junction of the two principal spirals with the main nucleus is no longer radial but tangential. By their evident discontinuity we are led to strongly doubt that they can be considered as trajectories. Various points of the two spirals are the origin of independent rays, each curved in the same sense as the main spiral but with entirely different initial directions. At the starting points of the secondary rays we always find a star, or if we look closer, a group of stars. Upon a plate of the same nebula, taken by Dr. Isaac Roberts, 180 condensations were counted on the lines of the spirals.

It is evidently well in the presence of such immensely vast objects, so different from any that we have at hand for experiments, to build as much as possible on firm structural groundwork, neglecting no evidence concerning their form, their structure, or distribution in space. Thus armed, we may approach with less danger their life history and seek to know how these strange organisms are born and how they grow.

First, what can be stated as to the distribution of the spiral nebulae, for instance with regard to that most natural plane of reference, the mean plane of the milky way?

If we consider nebulae irrespective of class, we can state on this score a well-defined law. These objects show, as to their direction

from the earth, and doubtless also as to their absolute position in space, a marked antipathy to the plane of the milky way, the galactic plane.

This fact was noticed long ago by the philosopher and sociologist, Herbert Spencer. It is shown by the often-published figure constructed by Proctor. The principal catalogued nebulae are indicated by so many points. The white spot near the south pole corresponds to the Magellanic Clouds, a small region where nebulae and clusters abound. A place of similar nature, though less important, lies in the northern hemisphere close to the milky way. Apart from these two exceptions, the milky way traverses, throughout nearly all its whole extent, regions poor in nebulae which cluster chiefly near the north pole of the milky way.

But is this law of distribution the same for the spiral nebulae? For some years it was generally admitted that it was not, that the spirals were irregularly distributed as regards the milky way. We might therefore treat them as strangers and keeping in mind their circumvolutions, bifurcations, gaps and the fact that they inclose so many stars and clusters of stars, consider each one as an independent milky way.

To-day that conclusion does not seem so assured since Keeler has pointed out that many of the faint nebulae, showing to the naked eye no trace of a central nucleus or spiral structure, reveal on long-exposure photographs both these characteristics. Now we are beginning to ask whether the greater number of nebulae are not spiral and whether statistics, including all of them, would not show that the great majority of these objects are related to the milky way. A photographic exploration of the entire sky with a powerful instrument is necessary to solve this problem.

Apart from their structure, which too often escapes us, is there no other easily determinable characteristic which may serve to classify the nebulae? Could we not, for example, group them, as we have the stars, according to the richness of their spectra in absorption lines?

Huggens, trying to do this, noted that they readily fall into two classes. One shows a spectrum composed of bright lines like that of a gas made luminous electrically. These are often called the *green* nebulae because the greater part of their light is concentrated in a bright green line in their spectrum which has never been identified with any known terrestrial element. Provisionally it is considered as an indication of an unknown element which has been named *nebulium*. Of the four lines to which the spectrum of a nebula of this class is usually limited, the third in order of intensity is the only one upon whose origin we are agreed. It belongs to the spectrum of hydrogen.

A moderate dispersion may be used with this class without weakening the lines of the spectrum too much. Keeler showed that the brightest line does not occupy exactly the same position in all the green nebulae. Naturally, these small differences are interpreted as a sign of radial velocities. The 14 nebulae for which satisfactory results have been obtained give for the radial component figures ranging from 18 to -64 kilometers per second. There is a predominance of negative values, evidently not because the green nebulae show a tendency to approach us, but because the greater part of them which may be easily observed are situated nearer the constellation Hercules toward which our sun is moving, carrying us along with him. Contrary to what is true of the nebulae in general, the majority of the green nebulae lie in the milky way. The existence of these gaseous bodies, owing their light to a more or less extended mass of gas, has been considered as furnishing the experimental basis formerly lacking for the Laplacian hypothesis.

Interesting as these results are, we will not dwell upon them as they take us away from our subject. Indeed, of all the nebulae whose spiral structure is beyond doubt, not one belongs in the class just described. Not one is adapted to the determination of its radial velocity. All of them, as well as the great majority of the faint nebulae without definite form, shine with a white light which the prism transforms into an apparently continuous spectrum. This spectrum is too faint for the detection of absorption bands. However, there is some justice in calling it purely stellar. The white nebulae owe the greater part of their light to the stars which are clustered within them. As to the great nebula of Andromeda, which is the brightest of the spiral nebulae, we may add that the majority of the stars of its central portion are of the solar type.

The contribution of the spectroscope to the study of the spiral nebulae is on the whole somewhat restricted. The services rendered by photography are, on the other hand, inestimable. The great part taken by this method of study dates from the invention of the sensitive bromo-gelatin plates. The green or gaseous nebulae, whose light more strongly affects the photographic plate, brought the first success. The photographs of Paul and Prosper Henry, of Isaac Roberts, and of Keeler early showed evidence of a physical relationship between the stars and the nebulae, even in the case of the gaseous nebulae. This connection is yet closer in the spiral nebulae, of which we will now speak exclusively.

About the year 1900 they were looked upon as rare and scattered objects. Keeler undertook to form a collection of the most remarkable nebulous objects and was led to the two following unexpected conclusions: First, many nebulae formerly classed as globular, annular,

or fusiform show the spiral form on plates taken with special care; second, all exposures sufficiently long to photograph one of these objects lead to the discovery of many other similar objects. The number of spirals is much greater than had been supposed, and they may include the majority of the nebulae. These results were obtained on Mount Hamilton, Cal., where a rich American, James Lick, has founded the observatory which bears his name. No astronomer can visit this model observatory without envy and admiration.

The order in which we take up the objects in the rich collection of Keeler may evidently be open to criticism until an accord is established upon a definite theory. No one, surely, would suppose that the nebulae have always existed just as they are or that they have acquired a final shape. We must look upon them as still in the process of change. The question we will for the moment consider is whether they are in the process of condensation or expansion; whether the spirals are flowing out from or into the center.

Before forming a too hasty decision, let us first examine the larger, more massive nebulae, where the spirals are small and unimportant in comparison with the central nucleus. Afterwards we will consider the more dilated ones, where the greater part of the matter seems dispersed into the spirals. Then we will consider in which direction it is easier to suppose the transition.

In each class we shall place in the first rank those which have the most nearly circular appearance; that is, those whose plane is normal to our line of sight and which will enable us to interpret better the other nebulae seen at less favorable angles or even edgewise.

Having completed that task, we needs must ask of what are the spiral nebulae formed; in what way are they changing? Could we answer these two questions, then we would ask two others still more ambitious. How were the spiral nebulae formed, and what will be their end? But such questions may for a long while yet be premature, and I believe I thus voice the opinion of our master, Poincaré, if I rightly interpret the conclusions stated in his recent book on cosmic hypotheses.

It seems to me that the elements of the spiral nebulae can be nought else than collections of groups of stars, whence comes the abundance of the luminous points scattered in the outer portions of the spirals where they can be separately seen. A cosmic cloud formed of subtler elements could never show such sharp outlines, nor reveal such clear-cut divisions. The continuous spectra must lead us to suppose that even in the central portions stars predominate, enveloped, if you will, in a common atmosphere which diffuses their light.

Some might argue that if the spirals are formed of stars they would be brighter. I do not see that necessity. The distance of the

spirals is immense, much greater than that of the mean distance of the naked-eye stars, because all the visible stars inclosed in the spirals are telescopic. The light of such stars reaches us weakened by their enormous distances and doubtless by an interstellar absorbing medium.

When we consider the great number of the stars embedded in a nebula like that of Ursa Major (M101), or that of Andromeda, it seems as if we rather minimize their importance either in using these nebulae to construct a solar system or by regarding them as the result of some very improbable accidental collision. A single nebula is, in my opinion, capable of giving birth to many stars, indeed, to many clusters. By the range in their development, the variety of their structure, the great spirals are comparable without exaggerations to the milky way itself.

I believe that we should not derive from our latest studies the theories of Chamberlain and Moulton or of Prof. Arrhenius, all three of whom interpret the spirals as due to a collision of two stars. Mr. T. J. J. See has raised very strong objections against such theories in his recent work, "The Evolution of Stellar Systems," a book full of erudition and ingenious views, but one whose uncompromising dogmatism must arouse opposition. According to Mr. See, we must not present an explanation to our learned public as possible, but as absolutely necessary. Is the stellar cosmogony of Mr. See, for he has one of his own, truly one of those to which we must subscribe without discussion and hold as definitive? He makes a spiral have its birth in the meeting of two clouds of very elongated form which move through space with different velocities and become deformed before uniting under the influence of their mutual attraction. Each spiral marks the influx toward the common center of one of the original clouds.

I fear that such an explanation would be satisfactory only to readers but little acquainted with the objects themselves. It is not merely two concurrent spirals which we must explain, but often four or five. And when we consider the parsimonious scattering of matter through space, it is truly difficult to admit that upon the path of the deflecting current there will appear first isolated stars, then clusters of stars more and more numerous and more and more dense as we approach the place of conjunction. I do not see whence will be gathered the matter for these suns if there is no central condensation, which, according to See, would not yet have been formed. To me the movement in spirals must be centrifugal and dispersive. The central mass shoots out intermittently groups of stars, giving them a great initial velocity, but the impulsive force acts only for a short distance. The final movement of the liberated stars is governed by the

general attraction, except in the neighborhood of certain points of the spirals which have in turn become centers of disturbances.

The spirals, essentially irregular in their sections and projections, are neither currents nor trajectories. The axis of each one is a synchronous curve of the places which at any given instant are occupied by the products of a prolonged and intermittent eruption. The latter are continually evolved in the same central mass which slowly turns upon itself. The spirals therefore tend to become, with increasing distances, normal to the radius. The general motions of the matter in this class of nebulae thus conform to the stellar currents of our own milky way if we adopt the views expressed by Schwarzschild.

THE RADIATION OF THE SUN.

By C. G. ABBOT,¹

Director of the Astrophysical Observatory of the Smithsonian Institution.

[With 4 plates.]

The sun presents many interesting aspects. Although controller of the solar system, an object rich with beautiful and curious features, the nearest of the fixed stars, and typical of a large class among them, the sun also has a still greater claim on human interest as the fountain of heat, light, and life upon the earth. It is this latter aspect which we shall consider mainly, still further confining our attention almost wholly to work done under the auspices of the Smithsonian Institution.

When James Smithson died in Genoa in 1829 he left his estate, subject to certain conditions, "to the United States of America, to found at Washington, under the name of the Smithsonian Institution, an Establishment for the increase & diffusion of knowledge among men." On May 9, 1838, by decree of the English Court of Chancery, the Smithson bequest, amounting to about \$500,000, was adjudged to the United States. By the act of establishment in 1846 the control of the Smithsonian Institution is vested by Congress in a Board of Regents, comprising the Vice President and the Chief Justice of the United States, three Senators, three Representatives, and six private citizens. In the years that have elapsed the Smithsonian private funds have increased by gifts and economy to nearly \$1,000,000. For many years the institution has administered the annual congressional appropriations for the support of the National Museum, National Zoological Park, Bureau of American Ethnology, Astrophysical Observatory, Bureau of International Exchanges, and International Catalogue of Scientific Literature. The immediate administration is in the hands of the secretary of the Board of Regents, at present Dr. C. D. Walcott, the fourth of the secretaries.

Dr. S. P. Langley, the third secretary, a distinguished American astronomer, founded in 1890 the Astrophysical Observatory of the

¹ Reprinted with revision and addition from *Science Conspectus*, Boston, vol. 2, No. 5, April, 1912. Illustrations in part from "The Sun," by permission of D. Appleton & Co.

Smithsonian Institution, and was its director until his death in 1906. His own principal investigations, and those of the Astrophysical Observatory begun under his direction and still continued, have lain in the field of measuring the quantity and quality of the sun's radiation, the effect of the earth's atmosphere thereon, and the dependence of terrestrial temperatures and plant life on solar radiation. This is a utilitarian branch of astronomy, whose applications to terrestrial concerns may be expected to increase in future years and result in the promotion of the arts of meteorology and agriculture. But the interest of such studies for the promotion of pure knowledge is also very high. Let us imagine that the Greek philosophers, the Arabians, and the astronomers of Galileo's time, had all possessed the means to measure accurately the quantity and quality of solar radiation. How interesting it would be now to compare their measurements with our own, and determine thereby what, if any, appreciable changes have occurred in 2,500 years in that energy which supports heat and life upon the earth! The astronomer of the future will have, we hope, trustworthy measurements of our own time to compare with his own. Referring to another branch of the measurements which I am to bring before you, our knowledge of the approximate temperatures prevailing in the sun, and our conclusions as to the sun's nature rest on such work as is being done at the Smithsonian Astrophysical Observatory.

By the term solar radiation, I propose to your minds not only the solar rays which affect our eyes as light, but the extensions of the spectrum beyond the violet and beyond the red, where the eye is not sensitive. All these rays, whether visible or not, may be absorbed by blackened surfaces and will thus produce their just and proportional effects as heat. For the measurement of solar radiation, Langley, about 1880, invented the delicate electrical thermometer shown in plate 2, which he called the bolometer; figure 8 of plate 2 shows its most important part. This is a pair of tapes of platinum, each about 1 centimeter long, 0.01 centimeter broad, and 0.002 centimeter thick. These tapes are blackened with camphor smoke or by a deposit of platinum black. One is exposed in the path of the rays to be measured, and the other is hidden. Hence one tape is warmed with respect to the other. Thereby a minute electrical current is caused to flow through the delicate galvanometer connected with the Wheatstone's bridge, of which the tapes form two arms. In this way a change of temperature, which may be as small as one-millionth degree Centigrade, may be detected in ordinary practice. By special devices the sensitiveness may be increased beyond this one-hundred fold. But though so sensitive the bolometer is far behind the eye in its capacity to detect faint yellow light. It is used in preference to the eye because it can detect and

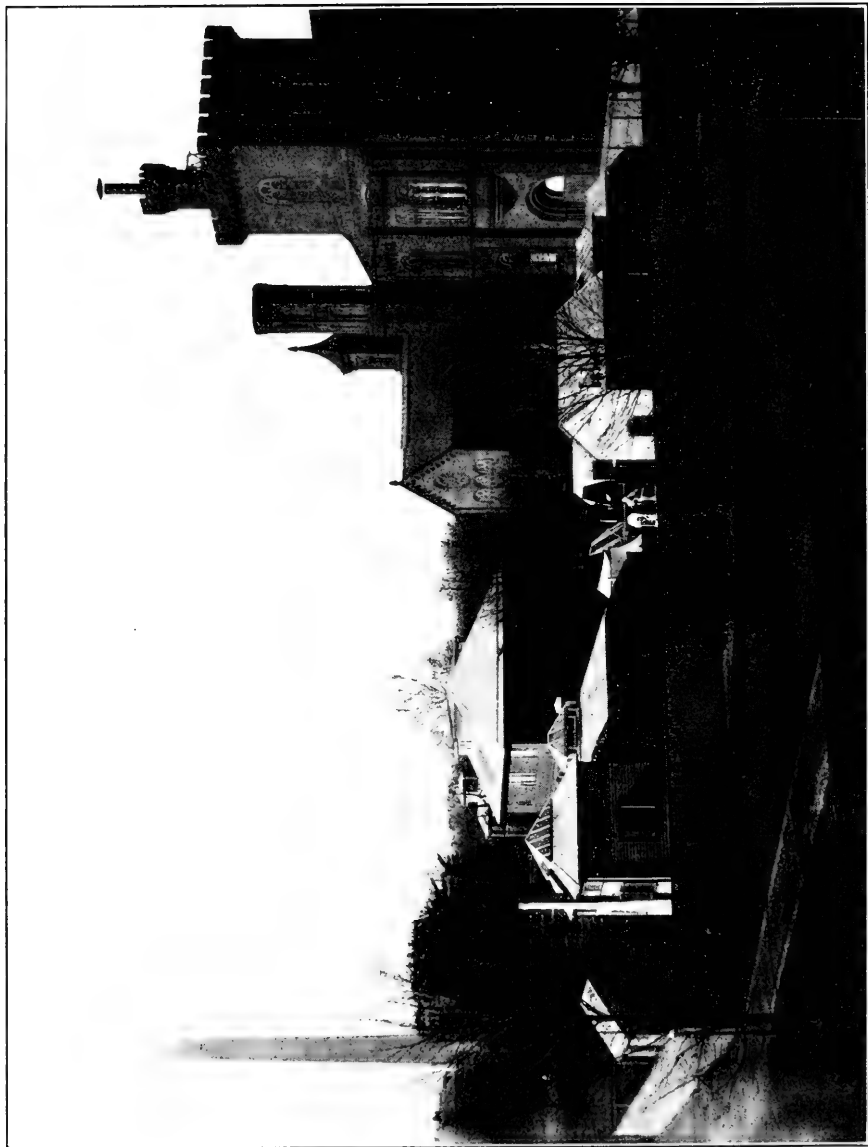

ASTROPHYSICAL OBSERVATORY OF THE SMITHSONIAN INSTITUTION.

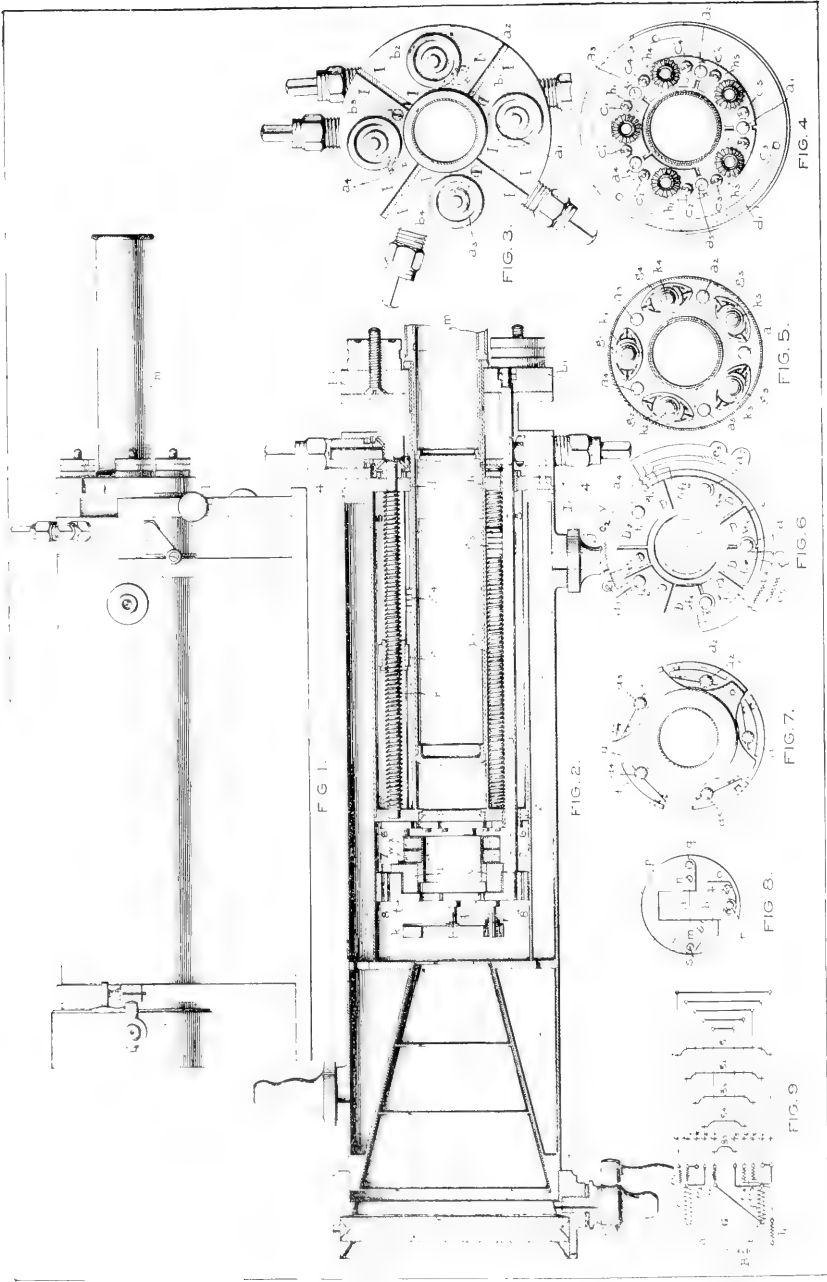

THE BOLOMETER AND ITS ADJUNCTS.

1. General view, 2. Cross section, 3. End view, 4, 5, 6, 7. Details of balancing mechanism and connections, 8. The bolometer proper, 9. Diagram of electrical connections.

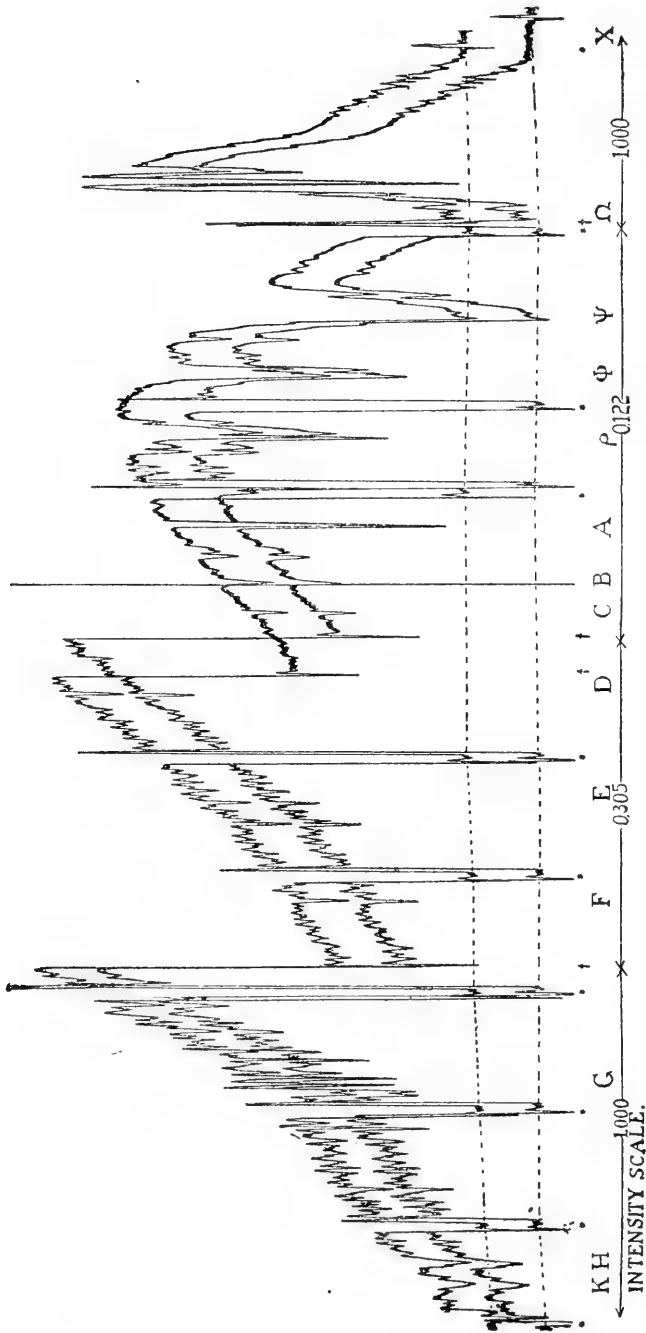

FIG. 1.—BOLOGRAPHIC ENERGY CURVES OF THE SOLAR SPECTRUM OF A 90° FLINT-GLASS PRISM.

† Means diaphragm introduced to give suitable height to curves.

* Means shutter interposed to give zero of radiation.

correctly measure the relative intensities of rays of all wave lengths, whether visible or not.

The indications of the bolometer may be automatically observed by photography, and thereby the solar spectrum may be exhibited, as in figure 1, as a sinuous line whose elevation above the base line of zero radiation gives the relative intensity of the different colored or invisible rays. The two curves shown are taken independently about an hour apart, for the purpose of studying the increase of intensity of the sun's rays of different wave lengths as their path in air diminishes in length in consequence of the approach of

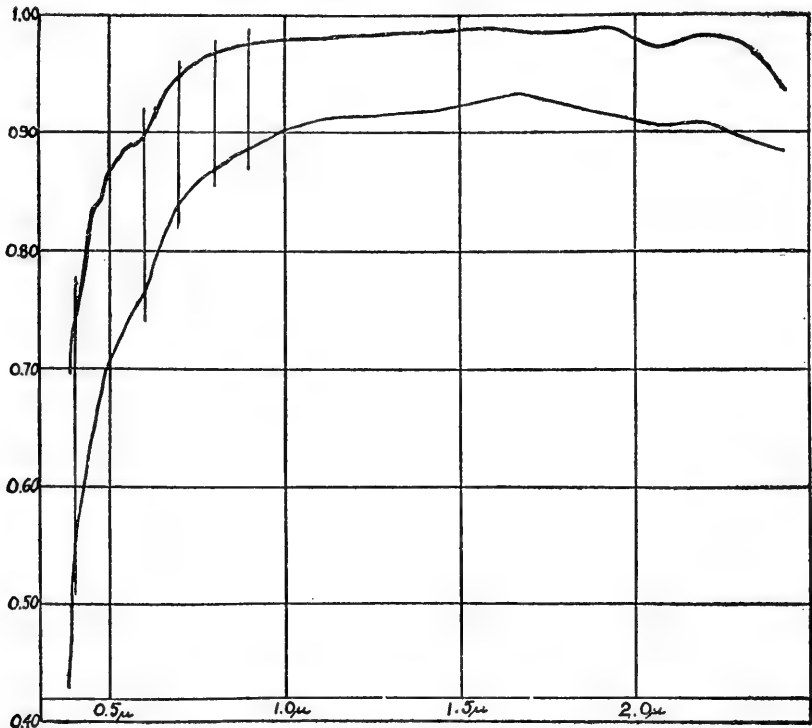

FIG. 2.—VERTICAL ATMOSPHERIC TRANSMISSION FOR DIFFERENT WAVE LENGTHS.
Upper curve for Mount Wilson; lower curve for Washington.

the sun to the meridian. From such studies the results shown in figure 2 are found. The upper curve represents the percentage transmission of a vertical column of air above Mount Wilson (elevation 1,750 meters), while the lower curve shows the less transmission for vertical rays at Washington (30 meters). The wave lengths are indicated as abscissæ. From this we see how much more loss the violet rays of wave length 0.40μ suffer than do the red rays of wave length 0.70μ in traversing the air.

In order to determine the quantity of the solar radiation, we must fix our conditions independent of the variable losses in the

atmosphere. We attempt, therefore, to make the observations in such a manner as to permit a correct estimate of the atmospheric losses, so that the result can be expressed as if the measurements were made in free space beyond the atmosphere. But of course our actual work must be done at the earth's surface.

We express solar radiation in heat units called calories. As the bolometer (pl. 2) is not of itself capable of giving true calories we have devised an instrument shown in figure 3, a standard pyrheliometer, so called. A is a chamber of nearly the dimensions of a large test tube, whose walls are hollow and adapted for the circulation of a stream of water. The stream enters at E, bathes the walls and rear of the chamber and the cone-shaped receiver of rays H, and passes out at F, carrying the heat developed by solar rays which enter the chamber by the measured orifice C. At D_1 and D_2 are platinum coils adapted to measure the rise of temperature of the water due to solar heating. Knowing the weight of water flowing per minute, the rise of temperature and the area of the opening C for solar rays, their intensity is determined. As a check, heat may be produced electrically in the chamber, and the proof of the accuracy of the instrument consists in finding the known quantity of electrically introduced heat correctly measured. Another simpler instrument for everyday use is the silver disk pyrheliometer shown in

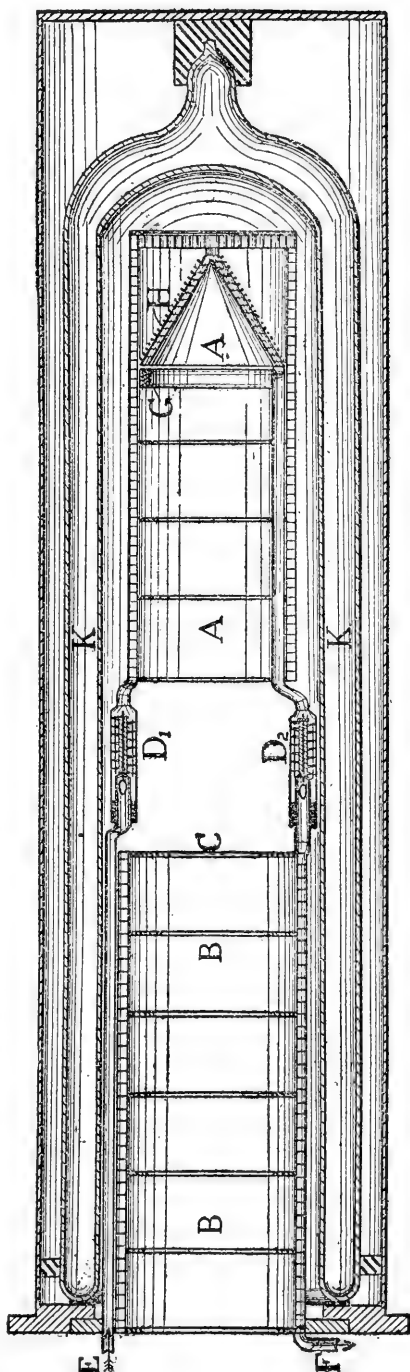

FIG. 3.—STANDARD WATER-FLOW PYRHELIOMETER.

figure 4, which may be standardized against the water-flow instrument and in which the measurement is made by reading a thermometer at stated intervals.

In measuring the intensity of solar radiation as it would be outside the earth's atmosphere at mean solar distance (generally called the solar constant of radiation) it is important to select a station where variability of atmospheric conditions is slight, and where the quantity of air traversed by the solar rays is small.

Owing to smoke and clouds, Washington is a poor locality for the purpose, and so in 1905 an expedition in my charge was sent by invitation of Director Hale, of the Mount Wilson Solar Observatory, to take station on Mount Wilson. Plate 3, figure 1, shows some

of the gigantic apparatus erected by Director Hale at that fine site. With this remarkable outfit the work done by the Mount Wilson Solar Observatory staff has been wonderfully productive. The Smithsonian Observatory on Mount Wilson, a little

affair comparatively, is shown in plate 3, figure 2. It was built in 1908 on a small plot of ground leased from the Solar Observatory. A cottage has since been built close by for observers' quarters.

In order to test more thoroughly whether we can indeed truly estimate the losses of solar rays in our atmosphere, work was done in 1909 and 1910 under my charge at Mount Whitney (4,420 meters), the highest mountain in the United States. To further the work of this and other scientific expeditions the Institution erected on Mount

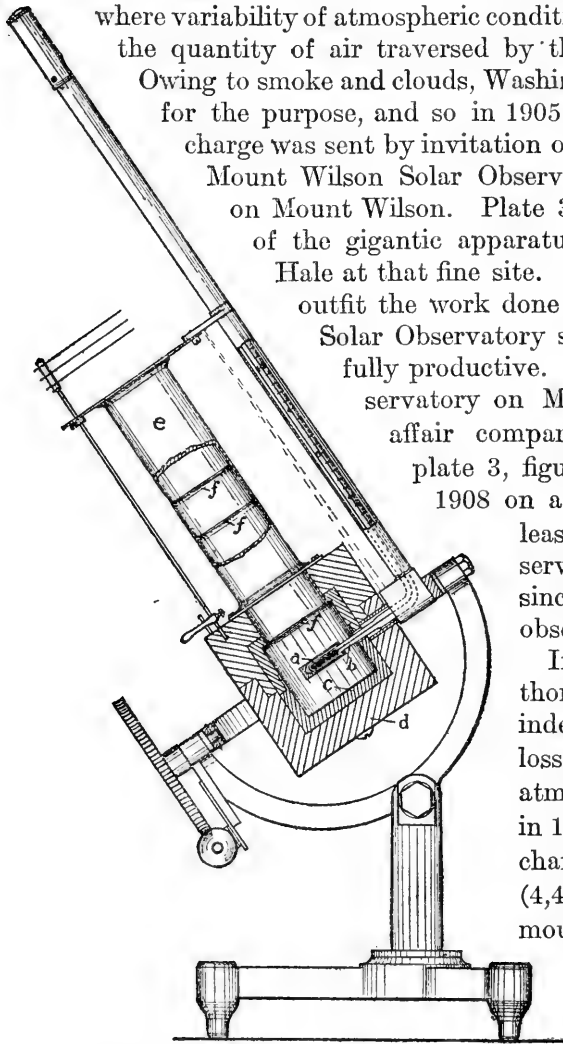

FIG. 4.—THE SILVER-DISK PYRHELIOMETER.

Whitney in 1909 the stone and steel shelter shown in plate 4, figure 1. My apparatus is shown in plate 4, figure 2. With Mr. Marsh, of Lone Pine, I remained two weeks on the summit in 1909 and again in 1910, and made measurements of the solar constant of radiation there, while my colleagues made similar measurements at Mount Wilson.



FIG. 1.



FIG. 2.

MOUNT WILSON EQUIPMENT.

Fig. 1.—The solar observatory of the Carnegie Institution.
Fig. 2.—The solar observatory of the Smithsonian Institution.



FIG. 1.



FIG. 2.

OBSERVING STATION ON MOUNT WHITNEY.

Fig. 1.—Pack train near observers' quarters.
Fig. 2.—Smithsonian outfit of 1910.

The differences between the results obtained simultaneously at the two stations were between 1 and 2 per cent. But considering that the optical apparatus used on Mount Wilson comprised a silvered glass mirror coelostat, an ultra-violet crown glass prism, and two silvered glass mirrors, while that on Mount Whitney comprised only a quartz prism and two magnalium mirrors, and, furthermore, that the pyrheliometers employed at the two stations were read at very different temperatures, it is probable that the slight difference found between the results may be due mainly to experimental differences and implies no discrepancy due to the difference of altitude between the two stations.

This conclusion seems worth emphasizing. We have now made simultaneously solar-constant determinations at sea level (Washington), and at over a mile altitude (Mount Wilson); and again at Mount Wilson, and at nearly 3 miles altitude (Mount Whitney). Although both the quantity and the quality of the solar radiation found at these stations differ very much, neither the "solar constant" nor the distribution of the solar energy in the spectrum outside the atmosphere, as fixed by the wholly independent measurements at these three stations, differs more than would be expected in view of the unavoidable small errors of observation. We seem justified in concluding that we do, in fact, eliminate the effects of atmospheric losses and actually determine the true quantity and quality of the sun's radiation outside the atmosphere as we might do if we could observe in free space with no atmosphere at all to hinder.

Expeditions to Mount Wilson have now been made in 1905, 1906, 1908, 1909, 1910, 1911, and 1912, continuing from May until November. In the earlier years the observations were not made daily, but in 1908, 1909, 1910, and 1911 daily determinations of the solar constant were made when possible. I give below a summary of this work up to the end of 1911, and with it also the results obtained at Washington, 1902-1907.

	Wash- ington.	Mount Wilson.					
	1902-1907	1905	1906	1908	1909	1910	1911
Times observed	37	45	61	114	95	113	109
Mean value	1.908	1.956	1.942	1.936	1.916	1.921	1.923

Other days of observation not yet ready. General mean, 1.932 calories (15° C.) per square centimeter per minute. Number of determinations, 696.

We draw the conclusion that, for the epoch 1902 to 1911, an object in outer space, at the earth's mean solar distance, would have received radiation on surfaces at right angles to the solar beam at the mean

rate of 1.93 calories per square centimeter per minute. What a prize would be given to one who could bring us similar measurements dating, let us say, from the time of Archimedes!

Before considering the possible variability of the sun we may pause to note some of the by-products of the solar-constant measurements. Referring again to figure 1, we see before us the distribution of

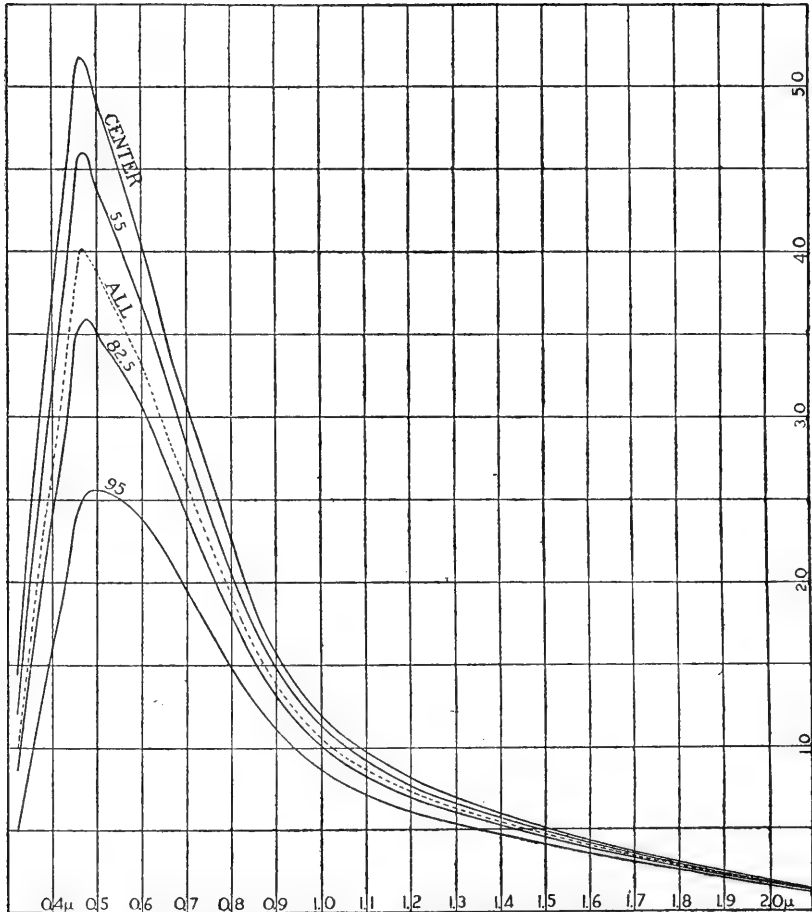

FIG. 5.—SOLAR SPECTRUM ENERGY CURVES OUTSIDE THE EARTH'S ATMOSPHERE.

"All."—Radiation from the whole solar disk.

"Center."—Radiation from center of sun's disk.

55, 82.5, and 95.—Radiation from points at these percentages of radius from center of sun's disk.

energy in the sun's spectrum observed at a particular time on Mount Wilson with certain apparatus. Knowing from other observations of the same day the losses suffered by the rays in the air, and being able to measure also the losses suffered in their passage of the optical apparatus, it is possible to compute the form which the solar energy spectrum would assume if observed outside our atmosphere, with

perfectly transparent apparatus capable of forming a normal spectrum. Such a curve is that marked "All" in figure 5. It is marked "All" because it represents the mixture of rays from all parts of the sun's disk, just as we ordinarily get them.

Figure 6 shows a number of curves of distribution of rays along a diameter of the sun. From these we see that the sun's disk is not of equal brightness from edge through center to edge, and that the

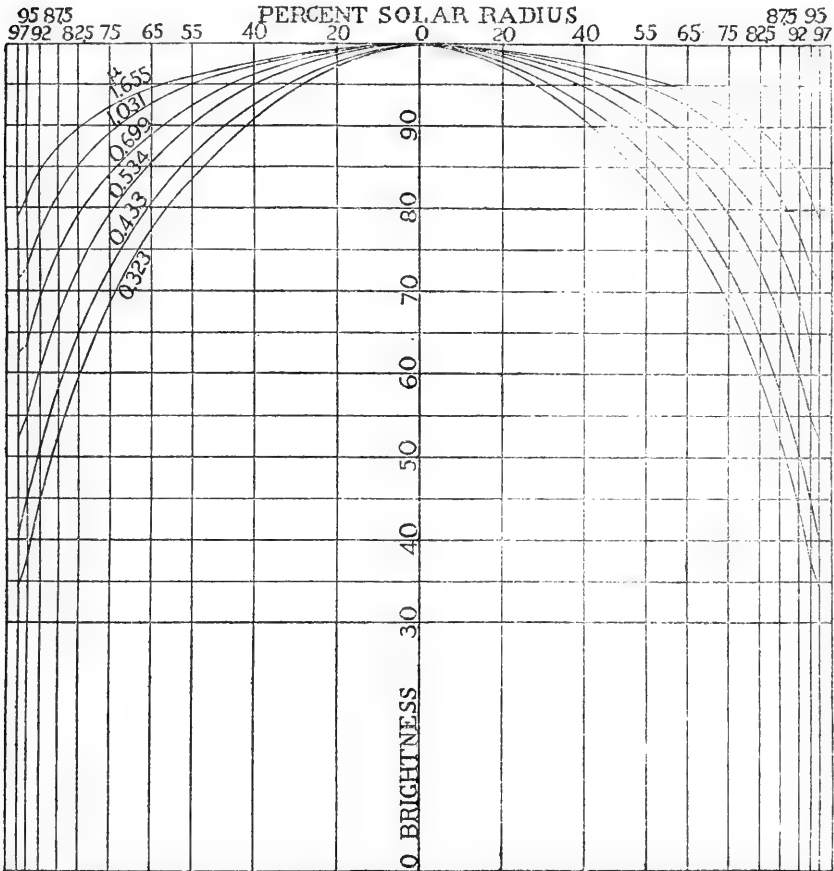

FIG. 6.—DISTRIBUTION OF BRIGHTNESS ALONG THE DIAMETER OF THE SOLAR DISK FOR RAYS OF DIFFERENT WAVE LENGTHS.

contrast of brightness is far greater the shorter the wave length considered. In other words, the sun's edge is much dimmer compared to its center for the ordinary photographic plate than for the eye because the plate is most sensitive for violet and ultra-violet rays, while the eye is most sensitive in the yellow.

Returning again to figure 5, the other curves show the relative intensities of solar energy of all wave lengths taken from points

distant zero 55, 82.5, and 95 per cent, respectively, from the center of the sun's disk. The intensities, as you see, diminish as we go out toward the sun's edge in all wave lengths, but most rapidly for the shorter wave-length rays. Hence not only does the height of the energy curve alter, but its form changes, so that the place of maximum intensity shifts toward the red as we approach the sun's edge. This is a peculiarity of spectra of heated bodies at successively lower temperatures. It is quite reasonable to conclude that the light we see near the edge of the sun comes from regions of lower temperature than that which we get from the center of the disk. This is probably because our view is cut off before it penetrates very deeply, at the edge, because we are there looking very obliquely. Thus we see only

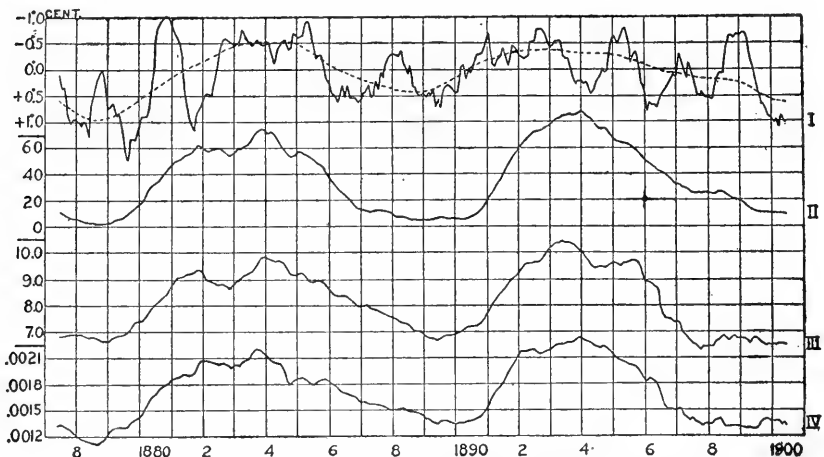

FIG. 7.—SUN-SPOTS AND THE EARTH'S TEMPERATURE AND MAGNETISM.

- I. Temperature departures for the United States.
 II. Sun-spot numbers (Wolfer).
 III. Magnetic declination { mean diurnal range, }
 IV. Magnetic horizontal force { Ellis, Chree. }

superficial layers at the edge, and much deeper and hotter ones at the center. But all these temperatures are very much higher than any we know on the earth. The electric arc, for instance, is said to be at a temperature of about $3,800^{\circ}$ absolute Centigrade. From the form of the solar energy curve, the value of the solar constant, and other data we estimate that the solar temperatures range from about $6,000^{\circ}$ absolute Centigrade upward.

As the temperature of the earth depends almost directly on the quantity of solar radiation, we are immediately interested to inquire if the sun, like so many others of the stars, is variable, and if so, what corresponding variations are produced in the temperature, cloudiness, and rainfall of the earth. It has been known for over half a century that the sun has a slight variability of an average period of about 11

years, corresponding with the fluctuations of the number of sun spots, the changes in form of the solar corona, and other solar phenomena, and inducing changes in the prevalence of the aurora borealis, the magnetic force and declination, and other terrestrial phenomena. Figure 7 shows in its first curve the variation from normal of the temperature of the United States, second the variation of sun-spot numbers, third and fourth the fluctuations in terrestrial magnetic elements for the period 1878 to 1900. It would be of great interest if we had accurate solar-constant measurements to compare with these changes for a long period of time. Unfortunately we have none such earlier than 1903 and only scattering measurements until 1905.

In figure 8 the results of solar-constant measurements on Mount Wilson, 1905 to 1909, are given. On their face they indicate a fluctua-

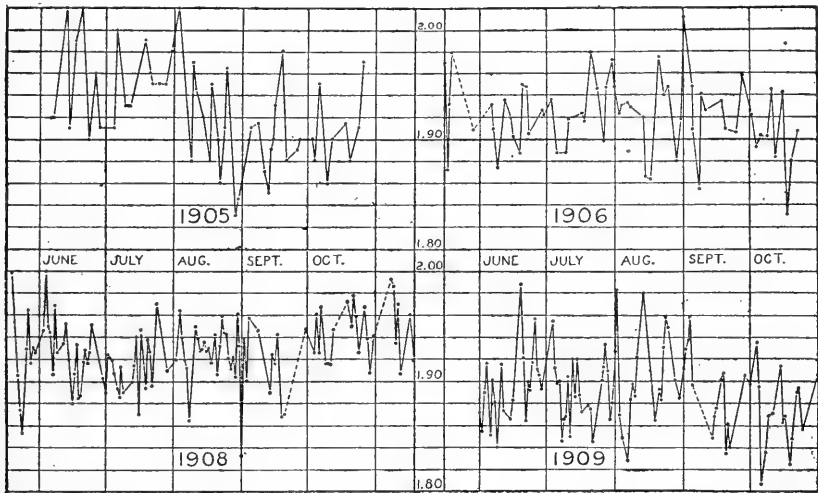

FIG. 8.—INTENSITY OF SOLAR RADIATION OUTSIDE THE EARTH'S ATMOSPHERE AS MEASURED AT MOUNT WILSON IN THE YEARS 1905 TO 1909.

Values given in calories per square centimeter per minute.

tion of the intensity of solar radiation. The fluctuation extends over a total range of nearly 10 per cent. In the later years the measurements were made almost daily, and seem to bring out with certainty that the changes are not haphazard in their character. Successive days of observation indicate a gradual march of the solar constant values from a high to a low, and back. Had the variations been due merely to accidental errors we should not have expected this regularity. Hence we conclude that the changes observed are either really solar or are due to some obscure source of error in estimating the losses in our atmosphere. The latter supposition is not very reasonable, because as already shown, we get practically identical solar constant values whether we observe at sea level (Washington), 1 mile (Mount Wilson), or 3 miles elevation (Mount Whitney). Hence it

seems most probable that we have found a real variation of the sun, irregular in amount and period, but of an average period of 7 to 10 days, and an average magnitude of 3 to 5 per cent. This would be "important if true."

Note added January 13, 1913:

[In part from Annual Report of Secretary of the Smithsonian Institution for year ending June 30, 1912.]

Congress having provided funds, an expedition under my charge proceeded in July, 1911, to Bassour, Algeria, to make there a long series of solar-constant observations simultaneously with similar observations made by Assistant Aldrich on Mount Wilson. The Algerian expedition included Mr. and Mrs. Abbot and Prof. F. P. Brackett, of Pomona College, California. The apparatus carried was the same which I had used on Mount Whitney in 1909 and 1910. Station was reached on July 31, 1911, but owing to a most unfortunate miscarriage of a box of apparatus, observations could not be commenced until August 26, and several more days were required to get the whole outfit working satisfactorily. The weather of August was excellent at both Mount Wilson and Bassour, but in the subsequent months the good days at one station frequently coincided with bad ones at the other. Hence, although 44 days of solar-constant observations were secured at Bassour up to November 17, when the camp was broken up, and a still greater number were secured at Mount Wilson, only 29 of these coincided and 20 were good at both stations.

In spite of the loss of August and the unfavorable weather of subsequent months, the results strongly confirm the supposed variability of the sun.

Expeditions of 1912.—While the simultaneous observations made in 1911 at Bassour and Mount Wilson seemed justly interpretable as confirming the variability of the sun, yet it was felt that a result of such uncommon interest ought to be put beyond the smallest warrantable doubt. Accordingly, in May, 1912, Mr. and Mrs. Abbot again returned to Bassour, where they were joined on May 20 by Mr. Anders Knutson Ångström, as temporary assistant. Observations were begun on June 2. Observations on Mount Wilson had already been begun by Mr. Fowle in April.

Between June 1 and September 9 nearly 50 days of observations common to both stations were secured. This work is fully conclusive in proving the variability of the sun. *High solar-constant values at Bassour correspond with high solar-constant values at Mount Wilson, and vice versa.*

In the meantime it has been found that some measurements of the kind illustrated in figure 6, which were made in 1908 at Washington

and compared with solar-constant values from Mount Wilson, seem to show that there is a slight but distinct change of distribution of the radiation along the diameter of the sun's disk depending on the value of the solar constant. This change is such that when the intensity of solar radiation outside the atmosphere is high as observed at Mount Wilson, the contrast in brightness between the center and the edge of the sun's disk is great, and vice versa. This change in contrast holds true for all wave lengths observed at Washington.

Thus we have two independent proofs that the sun is an irregularly variable star of a short irregular periodicity of 7 to 10 days and magnitude of fluctuation reaching often 3 per cent but rarely 8 per cent. Besides this newly discovered irregularity there is of course also the long period variability of 11 years indicated by sun spots. Curiously enough the solar radiation proves to be above normal when the sun spots are at a maximum; although, as shown in figure 7, the temperature of the earth is then below the normal. It is not unlikely that other solar changes of great interest may be brought to light in future years by the methods above described. Nothing has yet been done to see how far the newly discovered short period solar changes affect the earth's climate, but evidently a most interesting field is opening there.



MOLECULAR THEORIES AND MATHEMATICS.¹

By ÉMILE BOREL,

Professeur à la Faculté des Sciences de l'Université de Paris, Sous-Directeur de l'École Normale Supérieure.

I.

The relations between the mathematical sciences and the physical sciences are as old as the sciences themselves. It is the study of natural phenomena which leads man to set for himself the first problems from which, through abstraction and generalization, has gone forth the superb complexity of the science of numbers and of space. Conversely, through a sort of preestablished harmony, it has often happened that certain mathematical theories, after being developed apparently far from the real, have been found to furnish the key to phenomena concerning which the creators of these theories had no thought at all. The most celebrated instance of this fact is the theory of conic sections, an object of pure speculation among the Greek geometers, but whose researches enabled Kepler, 20 centuries later, to announce with precision the laws of the motions of the planets. In the same way, in the first half of the nineteenth century, it was due to the theory of the imaginary exponentials that the study of vibratory motions was rendered more profound, the importance of which has been revealed on so large a scale in physics and even in industrial art; it is to this study that we owe wireless telegraphy and the transmission of energy by polyphase currents. More recently still, we know what the utility of the abstract theory of groups has been in the study of the ideas so profound and novel whereby one has tried to explain the results of the capital experiments on relativity made by your illustrious compatriot Michelson.

But these illustrations, whatever may be their importance, are special and relate to particular theories. How much more striking is the universal usage of the forms imposed on scientific thought by

¹ Address delivered at Houston (Tex.) on the occasion of the inauguration of the Rice Institute (Oct. 10 to 12, 1912).

Reprinted by permission of the author, the publishers, and the Rice Institute, from *Revue générale des Sciences pures et appliquées*, Paris, Nov. 30, 1912.

the genius of Descartes, Newton, Leibnitz. The employment of rectangular coordinates and of the elements of differential and integral calculus has become so familiar to us that we might be tempted at times to forget that these admirable instruments date only from the seventeenth century. And in the same way the theory of partial differential equations dates only from the eighteenth century. In 1747 d'Alembert obtained the general integral of the equation of vibrating cords. It was the study of physical phenomena that suggested the notions of continuity, derivative, integral, differential equation, vector, and the calculus of vectors; and these notions, by a just return, form part of the necessary scientific equipment of every physicist; it is through these that he interprets the results of his experiments. There is evidently nothing mysterious in the fact that mathematical theories constructed on the model of certain phenomena should have been capable of being developed and of furnishing the model for other phenomena. This fact is nevertheless worthy of holding our attention, for it permits an important practical result. If new physical phenomena suggested new mathematical models, mathematicians will be in duty bound to devote themselves to the study of these new models and their generalizations, with the legitimate hope that the new mathematical theories thus erected will be found fruitful in furnishing in their turn to the physicists forms of useful thought. In other words, to the evolution of physics there should correspond an evolution of mathematics which, without abandoning the study of the classical and tested theories, should be developed in taking into account the results of experiment. It is in this order of ideas that I would examine to-day the influence that molecular theories may exercise on the development of mathematics.

II.

At the end of the eighteenth century and in the first half of the nineteenth there was created on the hypothesis of continuity what we may call classical mathematical physics. As types of the theories thus constructed we may take hydrodynamics and elasticity. In hydrodynamics, every liquid was by definition considered to be homogeneous and isotropic. It was not quite the same in the study of the elasticity of solid bodies. The theory of crystalline forms had led one to admit the existence of a periodic network, that is to say, a discontinuous structure; but the period of the network was supposed to be extremely small with reference to the elements of matter physically regarded as the differential elements. The crystalline structure therefore led only to anisotropy, but not to discontinuity. The partial differential equations of elasticity, as well as those of hydrodynamics, imply continuity of the medium studied

The atomic theory, whose tradition goes back to the Greek philosophers, was not abandoned during that period. Independent of the confirmation that it found in the properties of gases and in the laws of chemistry, it was by means of that theory that one was obliged to explain certain phenomena, such as the compressibility of liquids or the permeability of solids, in spite of the apparent continuity of these two states of matter. But the atomic theory was placed in juxtaposition with physical theories based on continuity; it did not affect them. The rapid advances in thermodynamics and in the theories of energy contributed to maintain this sort of partition between the physical theories and the hypothesis of the existence of atoms, which became so fruitful in chemistry. To the majority of physicists half a century ago the problem of the reality of atoms was a metaphysical question properly beyond the domain of physics; it mattered little to science whether atoms exist or are simple fictions, and one might even doubt if science were able to affirm or deny their existence.

However, thanks especially to the labors of Maxwell and of Boltzmann, the definite introduction of molecules in the theory of gases and solutions showed itself fruitful. Gibbs created the new study, to which he gave the name "Statistical mechanics." But it is only in the last 20 years that all physicists have been forced, by the study of new radiations on the one hand and the study of the Brownian movement on the other, to consider the molecular hypothesis as one that is necessary to natural philosophy. And, more recently, the thorough study of the laws of radiation has led to the unlooked-for theory of the discontinuity of energy—or of motion. It does not come within my subject to expound the experimental proofs through which these hypotheses are each day becoming more probable. The most striking of such experiments are perhaps those which have made it possible to observe the individual emission of the α particles, so that one actually obtains one of the concrete units with which the physicist constructs the sensible universe, just as the abstract universe of mathematics can be constructed by means of an abstract unit.

For definitely formulating their hypotheses and deducing therefrom results susceptible of experimental verification the theorists of modern physics make use of mathematical symbols. These symbols are those which have been created in starting out with the notion of continuity. It is, therefore, not astonishing that difficulties sometimes appear, the most real of which is the contradiction, apparent at least, between the hypothesis of the *quanta* and the older hypothesis that phenomena are governed by differential equations. But these difficulties of principle do not prevent the success of what one might call partial theories, by which a certain number of experi-

mental results may, in spite of their apparent diversity, be deduced from a small number of formulæ which are coherent among themselves. Usually the employment of mathematics in these partial theories is quite independent of the ultimate bases of the theory. And so it is that for many of the phenomena of physical optics the formulæ are the same in the mechanical theory of Fresnel and in the electromagnetic theory of Maxwell. In the same way the formulæ used by electrical engineers are independent of the diversity of theories concerning the nature of the current.

If I have been obliged to point out, though beyond my subject, this employment of the mathematical tool as an auxiliary to the partial physical theories, it is in order to prevent all misunderstanding. It appears certain that for a long time to come, as long, perhaps, as human science shall endure, it will be under this relatively modest form that mathematics will render the greatest service to the physicists. There is no reason why we should be disinterested in the general mathematical theories whereof physics has furnished the model, whether we may be concerned with speculations on partial differential equations suggested by the physics of the *continuum* or with statistical speculations pertaining to the physics of the *discontinuum*. But it should be well understood that the new mathematical theories which discontinuity of physical phenomena might suggest can not have the pretention of entirely replacing classical mathematics. These are only new aspects, for which it is proper to make room by the side of older views in such a manner as to augment as much as possible the richness of the abstract world in which we seek models suitable for making us better to comprehend and better to conjecture concrete phenomena.

III.

It is frequently a simplification in mathematics to replace a very large finite number by infinity. It is thus that the calculus of definite integrals is frequently more simple than that of summation formulæ, and that the differential calculus is generally more simple than that of finite differences. In the same way, we have been led to replace the simultaneous study of a great number of functions of one variable by the study of a continuous infinitude of functions of one variable; that is to say, by the study of a function of two variables. By a bolder generalization Prof. Vito Volterra has been led to define functions which depend upon other functions—that is to say, in the most simple case, functions of lines—in considering them as the limiting cases of functions which would depend on a great number of variables or, if one prefers, on a very great number of points of the line.

These diverse generalizations have rapidly acquired the rights of a citizen in mathematical physics; the employment of integral equations, of which the classical types are the equation of Volterra and the equation of Fredholm, has there become current. Although these theories may be well known to all, it is perhaps useful to recall briefly their origin by a particularly simple example. We shall thus better understand their significance from the point of view where we stand to-day.

Let us consider a system composed of a finite number of material points, each of which can deviate only a small amount from a certain position of stable equilibrium. The differential equations which determine the variations of these deviations from their positions of equilibrium can, under certain hypotheses and to a first approximation, be regarded as linear in respect to these deviations. If, moreover, we introduce the hypothesis that the system satisfy the law of the conservation of energy, the differential equations take a form very simple and classic, from which one easily deduces the fact that the motion may be considered as the superposition of a certain number of periodic motions. The number of these elementary periodic motions is equal to the number of degrees of freedom; it is three times the number of the material points, if each of these points can be arbitrarily displaced in the neighborhood of its position of equilibrium. The periods of the simple periodic motions are the *specific constants* of the system, which depend only on its configuration and the hypotheses made concerning the forces put into operation by its deformation, but which does not depend upon the initial conditions: positions and velocities. These initial conditions determine the arbitrary constants which figure in the general integral and which are two in number for each period: the intensity and the phase.

Suppose now that the number of material points become very great and let us identify each of them with a molecule of a solid body, a bar of steel for example; if the hypotheses made continue to be verified, and that is what one admits in the theory of elasticity, their consequences will subsist also; we shall have, then, a very large number of characteristic constants, each of these constants defining a proper period of the system. Let us increase to infinity the number of the molecules. The system of differential equations, infinitely great in number, is then replaced by a finite number of partial differential equations, whose fundamental properties are obtained by passing to the limit. In particular, the proper periods can be determined and we establish the remarkable fact that these periods can be calculated with precision and without ambiguity if we take care to define them by commencing with the longest period; there is only a

finite number of periods superior to a given interval, but this number increases indefinitely when the interval tends to zero.

The reasoning which has just been outlined is of the type of those to which the substitution of continuity for discontinuity leads. In reality, the considerations based on the existence of molecules play in them only an auxiliary rôle; they put one on the track of the solution, but this solution, once obtained, satisfies rigorously the partial differential equations of Lamé, equations which can be deduced equally well from theories of energy as from molecular hypotheses. The molecular theory has therefore been a valuable guide for the analyst in suggesting the course to be followed in studying the equations of the problem, but it is eliminated from the ultimate solution. On the other hand, we know that this solution represents reality only imperfectly. We obtain an infinitude of proper periods, instead of a very great number of them; the actual number so great, indeed, that one perhaps ought not to scruple to pass to the limit and to regard it as practically infinite. If, however, one observes that the difficulties of the theory of black radiation come precisely from the very short periods, and that these difficulties are not yet resolved in an entirely satisfactory manner, one will perhaps judge that he can not be too careful in everything which concerns these very short periods. Perhaps this is why a physicist like Lorentz has not deemed superfluous the considerable analytical efforts which the study of the propagation of waves requires when we explicitly introduce the molecules. However it may be in other cases, even if the substitution of the infinite for the finite is entirely legitimate in certain problems, it may be interesting to propose to oneself, from a purely mathematical point of view, the direct study of functions or equations depending upon a great, but finite number of variables.

IV.

The first difficulty which presents itself, when one wishes to study functions of a great number of variables, is the exact definition of such a function. I mean by that an *individual* definition, permitting one to distinguish the definite function from an infinitude of other analogous functions. There exist many general properties common to the mathematical entities of a certain category, independent of the numerical value of the coefficients; for example, every definite quadratic form (that is to say, one always positive) is equal to the sum of the squares of as many independent linear functions as the number of the variables which it contains. One has at times sought to deduce mathematical facts from this sort of physical consequences. I must confess that I can not defend myself against some suspicion in regard to this sort of reasoning; for it appears a little singular that

one can deduce anything exact from a notion so general as that of a surface of the second degree (let us say, for fixing ideas, a generalized ellipsoid) in a space having a very great number of dimensions. Let us emphasize a little the difficulty that there is in knowing *individually* such an ellipsoid: Its equation may be supposed to be reduced to the sum of squares, by an orthogonal substitution; that is to say, the axes remaining rectangular. Such an ellipsoid, then, requires for its complete definition the knowledge of what we may call the squares of the lengths of its axes; that is to say, the squares of as many positive numbers as the space considered contains dimensions. The question of knowing whether one can consider as *given* so many numbers, when a man's lifetime would not suffice to enumerate a small part of them, is a question which is not without analogy to that of the legitimacy of certain reasonings in the theory of ensembles, such as that one by which Prof. Zermelo pretends to prove that the continuum can be well ordered, and which suppose, as realized, an infinitude of choices independent of all law, and at the same time to be uniquely determined. Opinions may differ on the theoretical solution of these difficulties and here is not the place to reopen this controversy. But, from the practical point of view, the response is not doubtful; it is not possible to actually write the numerical equation of an ellipsoid whose axes are as numerous as the molecules constituting a gram of hydrogen.

In what sense is it, then, possible to speak of a numerically determinate ellipsoid, possessing a very great number of dimensions? From an abstract point of view, the most simple process for *defining* such an ellipsoid, consists in supposing that the lengths of the axes are equal to the values of a certain function which is simple for the integral values of the variable. One can suppose them all equal (in which case he will say that the ellipsoid is reduced to a sphere). One can also suppose that they have for values the successive integral numbers taken in their natural order, starting either with unity or with any other given number, or that they are equal to the inverses of the square of these integers, etc. In other words, we suppose that the lengths of the axes are all determined by the knowledge of a formula simple enough for being actually written, while it is not possible to actually write as many distinct numbers as there are axes.

Another process, to which we are naturally led by the analogies with the kinetic theory of gases, consists in supposing that the values of a function of the axes such that the square of the lengths of the axes, or of their reciprocals, etc., are not given individually, but that we know only the mean value of this function, and the law of the distributions of the other values around this mean. We propose, under these conditions, not to study the properties of a unique and well determined ellipsoid, but only the most probable properties of the

ellipsoid, knowing only that it satisfies the imposed conditions. We can also say that we study the mean properties of the ensemble of the ellipsoids defined by these conditions. Here again, we may observe that the probable ellipsoid or the mean ellipsoid is completely defined by the knowledge of the mean value of the law of the deviations. If this law is the classic law of probabilities, it includes only two constants. If we were led to introduce a more complicated law, this law might in all cases be explicitly written. The two processes that we have indicated are then equivalent from the analytical point of view. It would evidently be the same with all other processes that we can imagine, and notably with the combinations of the two.

In a word, a figure which depends on an extremely great number of parameters can be considered a numerically determinate only if these parameters are defined by means of numerical data sufficiently few in number to be accessible to us. It is for this reason that the study of the geometrical figures in a space possessing an extremely great number of dimensions, can lead to general laws, if we can exclude from this study such of these figures as it is impossible for a human being to define individually.

Here are, for example, some of the results to which one is led by the study of ellipsoids. In writing the equations in the form of a sum of squares, the second member being reduced to unity, the coefficients are equal to the reciprocals of the squares of the axes. If the mean of the squares of these coefficients is of the same order of magnitude as the square of their mean, one will say that the ellipsoid is not very irregular. The modes of definition concerning which we have just spoken lead to ellipsoids which are not very irregular, from the moment when one ceases to systematically introduce into these definitions functions purposely chosen in a complicated manner. On the other hand, we obtain a very irregular ellipsoid in equating to a constant the *vis viva* of a deformable system composed of a very great number of molecules, this *vis viva* being written under the classic form of the sum of the *vis viva* of translation of the total mass concentrated at the center of gravity, increased by the sum of the *vires vivæ* of the molecules in their motion relative to this center of gravity. The great irregularity comes from the fact that the products of the total mass by the three components of the velocity of the center of gravity are extremely great in comparison with the other terms. When an ellipsoid is not very irregular, several of its properties permit comparing it to a sphere, which we may call the median sphere. The surface of the ellipsoid is almost wholly comprised between the surfaces of two spheres very near to the median sphere. On the other hand, a point being arbitrarily chosen on the ellipsoid, it is infinitely probable that the normal at this point passes extremely close to the center.

This geometrical study of figures having a very great number of dimensions deserves, I believe, to be thoroughly investigated. It puts in evidence the abstract bases of the theories of mechanics and statistical physics; that is to say, it enables us to distinguish among the propositions to which physicists are led, those which are a consequence of physical hypotheses from those which are derived only from statistical hypotheses. But, independent of its physical utility, this geometrical study of spaces having a very great number of dimensions presents an interest of its own. It is to the molecular theories that we are indebted for this new branch of mathematics.

V.

We can, however, ask ourselves whether it is legitimate to regard as connected with the molecular hypothesis a theory which ought, in fine, to depend upon only a small number of constants. To say that an ellipsoid with a very great number of dimensions is entirely defined by five or six constants is to say that all the consequences that we are to deduce from its study shall be expressible by means of five or six constants. We can not suppose in such a case that it will be possible to imagine an analytical mechanism which would permit us to obtain the same consequences, expressed by means of five or six constants, without its being necessary to cause to intervene the equation possessing a very great number of terms; that is to say, without its being necessary to utilize the molecular hypothesis.

It is well that we pause on account of this objection, though it may recall the controversy between the energetists and the atomists, a controversy in which the atomists appear to have had the decided advantage. In the first place, we can reply with an argument of fact: It matters little that we might conceive the possibility, without making use of molecular hypotheses, of combining among themselves the consequences of these hypotheses; the important thing is to know whether this possibility is actually realized or if, on the contrary, they are calculations based upon molecular hypotheses which constitute the most simple, if not the only, mode of deduction. If this latter alternative be correct, and it seems difficult to deny it, molecular hypotheses are, then, actually very necessary, and that alone ought to be of consequence to us.

Under this modest form, which the future holds in reserve, this reply appears preemptory; but I believe that many physicists would not judge it too categorically. It is necessary to observe, however, that the question is independent of experimental proofs of the reality of the molecules. Should we succeed in seeing, by means of an instrument more powerful than a microscope, the molecules of a solid body, it would not follow, however valuable this knowledge might be, that

one should make use of the same for stating the properties of this body in the most simple manner possible. So it is that the possibility of seeing an isolated microbe under the microscope is not an indispensable condition for the attenuation of the viruses and of the use of vaccines. In the same way, in the reproduction of a masterpiece by photogravure, it is not the individual knowledge of the points constituting the negative that interests us.¹

From the abstract point of view, if we admit that all human theory ought to be, in the last analysis, expressed by means of a finite and relatively small number of data, it seems difficult to deny the possibility of entirely constructing the theory without causing the intervention of hypotheses which imply the existence of elements whose number surpasses that which the investigation of man can conceive. But the verification of this abstract possibility can not prevail against the importance of services rendered by molecular theories in the unification of apparently unrelated phenomena; and so it is permitted to consider these reserves on the possibilities of the future, as a simple matter of style.

Is it possible to go still further, and suppress all reserve of this kind? In order to answer this question it is necessary to examine in detail all the phenomena that one explains by means of the molecular hypotheses and seek to ascertain whether an extremely large number of parameters is really necessary to this explanation. Among the discontinuous phenomena whose experimental laws are well known, the most characteristic are those of spectra in series. One knows that the positions of the spectral rays are determined with a very great precision by formulæ, of which the first and most simple, due to Balmer, includes the difference of the reciprocals of the squares of two integers. There, perhaps, is the most remarkable example of the intervention of the integer in a natural law. If the laws of this kind were more numerous and better known, we would perhaps be led to cite arithmetic and the theory of numbers among the branches of mathematics which one can connect with molecular physics. Can one, by induction, admit that the formula of Balmer is exact, not only for small integers concerning which the experimental verification is rigorous, but for many other larger integers concerning which this verification is impossible? And if it is thus, is not there one of the discontinuous phenomena whose explanation requires a very large number of parameters? It does not seem so. On the one hand, the formula with the variable integer, can contain with precision

¹ This individual knowledge of points intervenes in the process of transmission of the negative to a distance; but here these points, although numerous, are, however, finite, and accessible to our observation. If we transmit by telephone an orchestral selection, we know that all the aesthetic beauties of the piece result, in the last analysis, from certain vibrations which would require too much time to know individually; but, in fact, these elementary vibrations present nothing visible in musical aesthetics; an excellent composer of music can ignore their existence and an excellent physicist can be a wretched musician.

only a small number of constants; on the other hand, the attempts made for explaining the presence of this integer by hypotheses of physical discontinuity have led to the placing of this discontinuity in the interior of the atom itself. There is, then, no need of a very great number of atoms; one alone is sufficient, whose structure depends only on certain parameters, on *magnétons* in the theory of Ritz, parameters whose number is far from being of the order of the number of the atoms.

This remark leads us to consider another category of phenomena, to which we have already made allusion and in which the atoms or corpuscles are observed individually. Does not the explanation of these phenomena require atomic hypotheses? It seems difficult to deny it without being paradoxical. We observe, however, that the phenomena such as the emission of the α -particles are susceptible only of a globate explanation; it is not possible to foresee with precision a determinate emission, but only a mean number. It is, then, only this mean number that exists, scientifically speaking. The phenomenon which consists in the emission of *one* particle α does not present the characters which permit of rigorous experimentation. We know not how to foresee it or how to reproduce it at will. It is only the study of the trajectory *after* the emission that presents these characters and in fact this study only requires equations sufficiently restricted in number so that one can write them all. The atomic hypotheses should permit one to foresee such individual emission, if one could actually calculate with reference to an extremely great number of equations; but that is not possible; and in that which concerns the *globe* conjecture the atomic hypotheses is not, at least *a priori*, necessary.

We touch here upon the borders of science, since we attain from phenomena accessible to our observation and which depend upon causes so numerous that it would be impossible for us to know with precision all their complexity. Science remains possible only for mean values which one can calculate with precision by means of data accessible to observation.

It is well understood, I think, that I do not contest the legitimacy and the utility of molecular theories. My remarks as a mathematician can not attain physical reality; at the bottom they reduce themselves to this: All the calculations we shall ever really effect will comprise only a sufficiently small number of equations actually written. If we write one equation, and if we add that we consider some billions of analogous equations, we do not calculate in fact these equations which are not written, but only the written equation, in taking count, perhaps, of the number of the equations which are not written, a number which will also have been written. All mathematical theory, then, reduces itself to a relatively small number of

equations and calculations, and which involve a relatively small number of symbols and numerical constants. It is, then, not *a priori* absurd to suppose that one might imagine a physical model containing also a relatively small number of parameters and leading to the same equations. However, so long as this model shall not be imagined, and perhaps it never will be, the analytical or geometrical researches on functions of a very large but finite number of variables will be able to offer interest to the physicists.

VI.

We have already observed that it is an ordinary proceeding in mathematics to replace a very large finite by an infinite. What may this procedure give when we apply it to discontinuous physical phenomena whose complexity seems tied up to a very great number of molecules? Such are, for example, the phenomena of the Brownian movement which we observe when very fine particles are in suspension in an apparently quiet liquid. These phenomena enter the category of those concerning which we were speaking a moment ago, for which only a statistical foreknowledge is possible.

Can we construct an analytical image of it? Prof. Perrin has already remarked¹ that the observed trajectories in the Brownian movement suggested the notion of continuous functions possessing no derivative or that of continuous curves possessing no tangent. If we observe these trajectories with optical instruments more and more perfected, we see at each new magnification, new details, the curvilinear arc that we could have traced becomes displaced by a sort of broken line whose sides form finite angles with each other; so it is up to the limit of the magnifications capable of actual realization. If we admit that the movement is produced by the impacts of the molecules against the particle, we should conclude from this that we would obtain, with a sufficient magnification, the exact form of the trajectory which would present itself under the form of a broken line with rounded off angles and which would not be sensibly modified by a still further magnification.

But the analyst is not forbidden to retreat indefinitely into the supposed obtainment of this ultimate state and to thus arrive at the conception of a curve in which the sinuosities become finer and finer in proportion as he employs a higher magnification, without his ever obtaining the ultimate sinuosities. This is indeed the geometrical image of a continuous function not admitting of a derivative.

We obtain thus a curve of the same nature, but rather too special to stop to consider, when we study the function which Boltzmann

¹ Jean Perrin; La discontinuité de la matière. *Revue du mois*, mars 1906. See also Jean Perrin: *Les atomes* (Alcan, 1913).

designates by H and Gibbs by η , and which represents, in the case of a gas, the logarithm of the probability of a determinate distribution of the velocities of the molecules. Each collision between two molecules gives a sudden variation to this function, which is thus represented by a [serrated or] staircase curve, the horizontal projections of the steps corresponding to the intervals of time which separate two collisions; the number of the collisions undergone by a molecule being some billions per second (that is to say, of the order of magnitude of 10^9) and the number of molecules of the order of magnitude of 10^{24} (if we consider a mass of some grams of gas), the *total* number of collisions per second is of the order of magnitude of 10^{33} power; such is the number of steps projected on a portion of the axis of the abscissæ equal to unity, if the second is taken for the unit of time.¹ What the physicists consider is the mean behavior of the curve. They replace the serrated curve by a more regular curve, having the same mean behavior in the time intervals which are very small in comparison to the second, but very great in comparison to 10^{-33} of a second.

These diverse considerations bring interesting suggestions to the analyst, on which I would like to dwell for a moment.

In the first place, referring to the subject of continuous curves without derivatives of which the Brownian movement has given us the image, should the passage from the finite to the infinite lead to a curve *all* of whose points are points of discontinuity, or to a curve which admits an infinitude of points of discontinuity but also an infinitude of points of continuity? For properly understanding the question, it is necessary to briefly recall the capital distinction between the denumerable infinity and the continuous infinity. An infinite ensemble is said to be denumerable if its terms can be enumerated by means of integers; such is the case for the ensemble composed of terms of a simple or multiple series; we can also cite as a denumerable ensemble the ensemble of the rational numbers. On the other hand, the ensemble of all the numbers comprised between 0 and 1, both commensurable and incommensurable, is not denumerable; we say that this ensemble has the same power as the *continuum*. If we define a discontinuous function by a series each term of which admits a point of discontinuity, the ensemble of these points of discontinuity is denumerable, as are the terms themselves. Can we determine a function which shall be totally discontinuous—that is to say, one whose points of discontinuity shall be all the points of a continuous ensemble, and not merely those of a denumerable ensemble? It would seem to be easy to imagine such a function. Such is the function often studied which is equal to 1 if x is commensurable and to x if x is

¹ This discontinuity supposes, as is well understood, that we consider the duration of a collision as less than the mean interval of two collisions (in the whole mass), a hypothesis admissible with difficulty. The *schema* to which this hypothesis leads, is not less interesting from the analytical point of view.

incommensurable; this function is indeed discontinuous, as much so for the commensurable values as for the incommensurable values. If we look a little closer, we perceive that the discontinuity is not of the same nature in these points; we would observe, in fact, that the commensurable numbers occupy infinitely less space on the axis of the x 's than do the incommensurable numbers. The ensemble of these commensurable numbers is of dimension zero—that is to say, it can be confined within intervals whose total extent is less than any number given in advance. Speaking in more concrete terms, if we choose a number at random, the probability that it be commensurable is equal to zero.¹ We therefore conclude that the function equal to x for the incommensurable values of the variable is, *on an average*, continuous for these incommensurable values whatever be its values for the commensurable values—that is to say, that if we choose, in the neighborhood of an incommensurable value, for which we study the continuity, another value *taken at random*, it is infinitely probable that this value taken at random will also be incommensurable. It is, then, infinitely probable that the variation of the function will be infinitely small when the variation of the variable is small.

This remark enables us to understand that it would not have been possible to define analytically a function all of whose points should be actually points of total discontinuity. It is only in points determined according to the definition of the function, and playing a particular part in this definition, that the function is actually discontinuous on an average.

The passage from the finite to the infinite, when we are concerned with the discontinuity of functions is, then, not effected after the manner which is the most usual in classical mathematical physics, where the matter is supposed to be continuous, and where we replace the finite by the continuous. We are led to conceive a different process, which appears, besides, more in harmony with the molecular conception and which consists in replacing the very great finite by the denumerable infinite.

This is the way in which the analytical generalization of such curves as the curves H presents itself from this point of view: Let us consider a number written in the form of an interminate decimal fraction and let us imagine that the figures which follow the decimal point are grouped in successive periods, each period containing many more figures than the preceding period. To each period we shall make correspond one term of a series, this term being equal to zero if in the corresponding period the ratio of the number of even figures to the number of odd figures is comprised between 0.4 and 0.6, while if this ratio is not comprised between these limits, the term corre-

¹ To give one's self a random number, he can agree to choose at random the successive figures of the decimal fraction which is equal to it; the probability that this decimal fraction be finite or periodic is evidently equal to zero.

sponding to the period is equal to the term of the same order of a certain convergent series with positive terms. It is clear that, if the lengths of the successive periods increase rapidly, it is infinitely probable that a small number of periods only will furnish terms different from zero. Consequently, the series which corresponds to the decimal number will be terminate; this terminate series has a certain sum, which remains the same so long as the decimal number varies so little that the last one of the periods which furnished a term to the series be not modified; at least, in the interval thus defined, it is extremely probable that the function corresponding to the decimal number preserves this constant and well determined value—that is to say, is represented by a horizontal line. However, there are in this interval, as in every interval, particular decimal numbers for which certain periods of high order, perhaps even an infinitude of such periods, are irregular from the point of view of the distribution of the even and odd figures. There are then intervals which are extremely small, and, on an average, extremely rare, but nevertheless everywhere dense, in which the curve runs up above the horizontal line which in general represents it. In one of these points, which we may call *maxima* of the curve, it is extremely probable that, if we take a neighboring value of the variable at random, the function will diminish—that is to say, that this point has, on an average, the character of a maximum in a point.

In the preceding example the maxima are represented by intervals more or less narrow but finite. One can in modifying slightly the definition obtain a curve which would coincide everywhere with the axis of x , excepting in points not filling any interval. It suffices to agree that, in the series which we have just defined, we replace by zero every term which is followed by an infinitude of terms equal to zero. The new series can then be different from zero only if the terms of the first series are all, starting from a certain order, different from zero.

The study of the analytical models thus obtained lead one to thoroughly examine the theory of functions of real variables and even to conceive new notions, such as the notion of *average derivative*¹ naturally suggested by the physical example of the function H. Besides, it is necessary to observe that, in the study of these functions, the notion of continuous ensemble is often combined with the notion of denumerable ensemble; for example, it is easy to see that the ensemble of decimal numbers whose figures are all odd present certain characters of the ensemble of all the decimal numbers; it has, as we say, the power of the continuum,² but it is, however, of zero dimension.

¹See Émile Borel: Comptes rendus de l'Académie des Sciences, April 29, 1912.

²If, in a decimal number all of whose figures are odd, we replace the respective figures 1, 3, 5, 7, 9 by the figures 0, 1, 2, 3, 4, we can consider the number as any number *whatever* written in the system whose base is 5

We may also connect with these considerations the theory of denumerable probabilities, that is to say, the study of probabilities, in the case where either the infinitude of trials or the infinitude of possible cases is denumerable, a study lying between the study of probabilities in the finite cases and the study of continuous probabilities.

VII.

In spite of the interest of problems relating to functions of a real variable, it is the theory of functions of a complex variable which, since the immortal discoveries of Cauchy, is really the center of analysis. The analogy between the theory of the functions which Cauchy has called monogenic functions and that which we often call analytical functions and the theory of Laplace's equation which potentials satisfy, is certainly one of the most fruitful of the analogies of analysis. We know all the advantage that Riemann has reaped from the theory of potential and from the intuition of physics in his profound researches upon the functions of a complex variable.

It is then natural to ask one's self what new ideas can the molecular theories bring forward in the domain of complex variables. Here again we shall be led to replace the very large finite number by the denumerable infinity. It is easy to form series each term of which presents a singular point, the ensemble of the terms of the series thus possessing a denumerable infinitude of singular points. These singular points may, for example, be so chosen as to coincide with all such points among the points inside of a square whose two coordinates are rational. The most simple series that we can thus form presents itself under the form of the sum of a series of fractions each of which admits a unique pole, which is a simple pole. The physical interpretation in the domain of the real of such a series leads one to consider the potential of a system composed of an infinitude of isolated points, the mass concentrated in each of the points being finite (which leads to the admission that the density in each such point is infinite if the point be abstractly considered as a simple geometrical point without dimensions). We suppose, as is well understood, that the series whose terms denote the values of the masses is convergent, which amounts to saying that the total mass is finite, although concentrated in an infinitude of distinct points, for example, in all the points whose two coordinates are rational numbers. The potential with which we are now concerned is in the case of a plane what we call logarithmic potential. We should be able to reason in an analogous manner in space of three dimensions; we should then have the Newtonian potential properly speaking.

The hypothesis that the attracting masses are simple material points without dimensions is difficult to accept from a physical point of view. We are thus led to carry out the analytical operation of dispersing this mass in a small circle (or small sphere) having the point for center, without changing the potential outside of this circle (or sphere). We shall call this circle (or sphere) the "sphere of action" of the point which coincides with its center. We shall choose its radius to be proportional to the mass concentrated at its center. In such a fashion that if the series formed by the masses converges sufficiently rapid, we can so arrange that the radii of the spheres of action also form a rapidly converging series, and that, at the same time, the maximum density of the attracting mass be finite. It is also easy, if we admit that we dispose arbitrarily of the distribution of the masses and densities, to arrange so that the distribution in each sphere of action reduces to zero, and so for its derivatives, over the whole surface of the sphere. The distribution of the density is thus not only finite, but continuous throughout space.

The hypothesis that we have made concerning the convergence of the series whose terms are the radii of the spheres of action implies the convergence of the series whose terms are the projections of these spheres on any straight line whatever. If, then, in this series we suppress a certain number of the first terms, the remainder of the series can be made less than any number fixed in advance. From this we conclude that, in an interval small as you please, taken on the straight line on which we project the spheres, we can find an infinite number of points which appertain at the most to a finite number of such projections, namely, those belonging to the spheres S which correspond to the first terms of the series and which we have suppressed for rendering the remainder less than the interval considered. If we consider a plane perpendicular to the right line and passing through one of these points (this point being chosen, as is possible, distinct from the projections of the centers of the spheres S , finite in number, concerning which we have just spoken), this plane will at most intersect a finite number of spheres S without going through their centers, but will be exterior to all the other spheres of action. It is possible to modify the distribution of the matter within the spheres S which are finite in number and intersected by the plane in such a manner as to replace these spheres by smaller spheres which do not intersect the plane, this operation not modifying the potential outside of the spheres and the density remaining finite, since the operation relates to only a limited number of spheres. To sum up, it is possible to find a plane perpendicular to any right line whatever, cutting out of this line any segment whatever given in advance and such that in all the points of this plane the density shall be zero. Since our potential function is defined by a density everywhere finite

and continuous, this potential satisfies the equation of Poisson, which reduces itself to the equation of Laplace wherever the density is zero; that is to say, in all the points of the planes which we have just defined. It was not profitless to insist upon this point, for these planes may traverse regions of space in which the given material points are everywhere dense, as are, for example, all the points whose coordinates are rational numbers. We might have entertained a fear lest there should not be free space between the points so much pressed together in any manner whatever; we have just seen that this fear is not justified. The theorem of the theory of ensembles which is necessary and sufficient for demonstrating this result in a rigorous manner is the following: *If on the segment of a straight line we have an infinite number of partial segments (in space, the projections of spheres of action) whose total length is less than the length of the segment, there exists on this segment an infinite number of points which do not pertain to any of the partial segments.* This enunciation is almost evident, and, besides, it is easy to rigorously demonstrate.

In the case of the plane we shall replace the spheres by circles and the plane perpendicular at a point of the segment by a perpendicular straight line. We easily prove that, even in the region where the singular points are everywhere dense, there are points in which an infinite number of such lines intersect at which the density is zero. In these points logarithmic potential function satisfies Laplace's equation in two variables. If we study in a similar way the function of a complex variable with poles dense in one region, we define in this region an infinite number of straight lines of continuity intersecting in all directions, the function admitting derivatives which are continuous on these lines, and the derivative having the same value in all the directions in each of the points of intersection. For expressing this fact we shall employ the expression created by Cauchy for designating functions which admit a derivative independent of the argument of the increment of the variable. These functions will be called *monogenic*; but they are not *analytical*, if we reserve for the word "analytical" the very precise meaning which it has possessed since the labors of Weierstrass.

Without lingering on the physical analogies suggested by the existence of planes which do not intersect the spheres of action of the attracting masses, I wish to insist a little upon the nature of the mathematical problems set by the existence of the monogenic but nonanalytical functions.

We know that the essential property of analytical functions is that of being determinate in their whole domain of existence when their values are given in one portion, however little it may be, of this domain. Is this property a consequence of analyticity—that is

to say, of the existence of the Taylor series, with radius of convergence different from zero—or of monogeneity; that is to say, of the existence of the unique derivative? This question has no meaning so long as we can confound analyticity with monogeneity. On the other hand, it takes a very clear signification as soon as we have succeeded in constructing nonanalytical monogenic functions.

To-day I can not enter into the detail of the deductions whereby this problem has been resolved.¹ Here is the result: It is, indeed, monogeneity which is the essential character to which the fundamental property of analytical functions is due. This fundamental property subsists for the nonanalytical monogenic functions as soon as we specify clearly the nature of the domains in which these functions are considered. I have proposed to call the domains satisfying these distinct conditions domains of Cauchy. A domain of Cauchy is obtained by cutting off from a continuous domain domains of exclusion analogous to the spheres of action just mentioned, domains which may be infinite in number, but whose sum can be supposed to be less than any given number (just as the spheres or circles of exclusion just considered, whose radii once chosen we can multiply by any number less than unity, and are free to increase the upper limit of the density in the same time that we decrease the radii of exclusion).

The series formed by these excluded domains should, as is well understood, be supposed to be convergent; moreover, we ought to suppose that its convergence is more rapid than that of a determinate series which it is not necessary to write here. Under these conditions, which refer only to the domain and not to the function, every function which in Cauchy's domain satisfies the fundamental equation of monogeneity possesses the essential property of the analytical function. We can calculate it throughout its domain of existence by the knowledge of its derivatives at one point (the existence of the first derivative involves the existence of all the derivatives, at least in a certain domain which forms part of the Cauchy domain) and this mode of calculation implies the consequence that, if the monogenic function be zero on an arc however small, it is zero in every point of the domain of Cauchy. Two functions can not, then, coincide on an arc without coinciding throughout their domain of existence, in the generalized sense.

I can not develop the consequences of these results from point of view of the theory of functions; but I would, in closing, submit to you some reflections which they suggest, upon the relations between mathematical and physical continuity.

¹ See Émile Borel; Définition et domaine d'existence des fonctions monogènes uniformes (Fifth International Congress of Mathematicians, Cambridge (England), 1912). Les fonctions monogènes non analytiques (Bulletin de la Société mathématique de France, 1912).

VIII.

The majority of the equations whereby we interpret the physical phenomena have certain properties of continuity. The solutions vary in a continuous manner, at least during a certain interval greater or less in length, when the given quantities vary in a continuous manner. Besides, this property is not absolutely general, and it might happen that the theories of the *quanta* of emission or absorption may lead to attaching more importance than has been done heretofore to exceptional cases; but to-day I do not wish to begin this discussion. I rest content with the general property, verified in a very great number of cases.

When we seek to interpret this property in the theory of the potential and of the monogenic functions, we should expect, if for simplification we confine ourselves to the real functions of a single variable, to find a sort of continuous passage between such of these functions as are analytical in the Weierstrassian sense and those which are entirely discontinuous. But it is this which does not occur unless we consider nonanalytical monogenic functions. From the moment when a function ceases to be analytical, it no longer possesses any of the essential properties of analytical functions; the discontinuity is sudden. The new monogenic functions permit one to define functions of real variables which might be called quasianalytical and which constitute in some way a zone of transition between the classical analytical functions and the functions which are not determined by the knowledge of their derivatives in a point. This transition zone deserves to be studied; it is often the study of hybrid forms which best teaches in reference to certain properties of clearly determined species.

We see that the points of contact between molecular physics and mathematics are numerous. I have been able only to rapidly point out the principal ones among them. I am not competent to ask whether the physicists will be able to derive an immediate profit from these analogies; but I am convinced that the mathematicians can only gain by going into them thoroughly. It is always by a contact with nature that mathematical analysis is revived. It is only because of this permanent contact that it has been able to escape the danger of becoming a pure symbolism, revolving in a circle about itself; it is owing to molecular physics that the speculations on discontinuity are to take their complete signification and be developed in a way really fruitful. And, for lack of exact applications impossible to foresee, it is sufficiently probable that the mental habits created by these studies will not be without advantage to those who shall desire to undertake the task, which will soon be imposed, of creating an analysis adapted to theoretical researches in the physics of discontinuity.

MODERN MATHEMATICAL RESEARCH.¹

By Prof. G. A. MILLER,

University of Illinois.

Mathematics has a large household and there are always rumors of prospective additions despite her age and her supposed austerity. Without aiming to give a complete list of the names of the members of this household we may recall here a few of the most prominent ones. Among those which antedate the beginning of the Christian era are surveying, spherical astronomy, general mechanics, and mathematical optics. Among the most thriving younger members are celestial mechanics, thermodynamics, mathematical electricity, and molecular physics.

Usually a large household serves as one of the strongest incentives to activity, and mathematics has always responded heartily to this incentive. As the most efficient continued service calls for unusual force and ingenuity, mathematics has had to provide for her own development and proper nourishment in addition to providing as liberally as possible for her household. This double object must be kept prominently before our eyes if we would comprehend the present mathematical activities and tendencies.

There is another important incentive to mathematical activity which should be mentioned in this connection. Mathematics has been very hospitable to a large number of other sciences and as a consequence some of these sciences have become such frequent visitors that it is often difficult to distinguish them from the regular members of the household. Among these visitors are economics, dynamical geology, dynamical meteorology, and the statistical parts of various biological sciences. Visitors usually expect the best that can be provided for them, and the efforts to please them frequently lead to a more careful study of available resources than those which are put forth in providing for the regular household.

We have thus far spoken only of what might be called the materialistic incentives for mathematical development. While these have always been very significant, it is doubtful whether they have been the most powerful. Symmetry, harmony, and elegance of form have

¹ Read before the Illinois Chapter of the Society of the Sigma Xi, April, 1912, and reprinted by permission from *Science*, June 7, 1912.

always appealed powerfully to dame mathematics; and a keen curiosity, fanned into an intense flame by little bits of apparently incoherent information, has inspired some of the most arduous and prolonged researches. Incentives of this kind have led to the *mathematics of the invisible*, relating to refinements which are essentially foreign to counting and measuring. The first important refinement of this type relates to the concept of the irrational, introduced by the ancient Greeks. As an instance of a comparatively recent development along this line we may mention the work based upon Dedekind's definition of an infinite aggregate as one in which a part is similar or equivalent to the whole.¹

Mathematics is commonly divided into two parts called pure and applied, respectively. It should be observed that there are various degrees of purity, and it is very difficult to say where mathematics becomes sufficiently impure to be called applied. The engineer or the physicist may reduce his problem to a differential equation, the student of differential equations may reduce his troubles to a question of function theory or geometry, and the workers in the latter fields find that many of their difficulties reduce themselves to questions in number theory² or in higher algebra. Just as the student of applied mathematics can not have too thorough a training in the pure mathematics upon which the applications are based so the student of some parts of the so-called pure mathematics can not get too thorough a training in the basic subjects of this field.

As mathematics is such an old science and as there is such a close relation between various fields, it might be supposed that fields of research would lie in remote and almost inaccessible parts of this subject. It must be confessed that this view is not without some foundation, but these are days of rapid transportation and the student starts early on his mathematical journey. The question as regards the extent of explored country which should be studied before entering unexplored regions is a very perplexing one. A lifetime would not suffice to become acquainted with all the known fields, and there are those who are so much attracted by the explored regions that they do not find time or courage to enter into the unknown.

In 1840 C. G. J. Jacobi used an illustration, in a letter³ to his brother, which may serve to emphasize an important point. He states that at various times he had tried to persuade a young man to begin research in mathematics, but this young man always excused himself on the ground that he did not yet know enough. In answer to this statement Jacobi asked this man the following question: "Suppose your family would wish you to marry would you then also

¹"Encyclopédie des sciences mathématiques," vol. i., pt. 1, 1904, p. 2.

²"Der Urquell aller Mathematik sind die ganzen Zahlen," Minkowski, Diophantische Approximation, 1907, preface.

³"Briefwechsel zwischen C. G. J. Jacobi und M. H. Jacobi," 1907, p. 64.

reply that you did not see how you could marry now, as you had not yet become acquainted with *all* the young ladies?"

In connection with this remark by Jacobi we may recall a remark by another prominent German mathematician who also compared the choice of a subject of research with marriage. In the "Festschrift zur Feier des 100 Geburtstages Eduard Kummer," 1910, page 17, Prof. Hensel states that Kummer declined, as a matter of principle, to assign to students a subject for a doctor's thesis, saying that this would seem as if a young man would ask him to recommend a pretty young lady whom this young man should marry.

While it may not be profitable to follow these analogies into details, it should be stated that the extent to which a subject has been developed does not necessarily affect adversely its desirability as a field of research. The greater the extent of the development the more frontier regions will become exposed. The main question is whether the new regions which lie just beyond the frontier are fertile or barren. This question is much more important than the one which relates to the distance that must be traveled to reach these new fields. Moreover, it should be remembered that mathematics is n -dimensional, n being an arbitrary positive integer, and hence she is not limited in her progress to the directions suggested by our experiences.

If we agree with Minkowski that the integers are the source of all mathematics,¹ we should remember that the numbers which have gained a place among the integers of the mathematician have increased wonderfully during recent times. According to the views of the people who preceded Gauss, and according to the elementary mathematics of the present day, the integers may be represented by points situated on a straight line and separated by definite fixed distance. On the other hand, the modern mathematician does not only fill up the straight line with algebraic integers, placing them so closely together that between any two of them there is another, but he fills up the whole plane equally closely with these integers. If our knowledge of mathematics had increased during the last two centuries as greatly as the number of integers of the mathematician we should be much beyond our present stage. The astronomers may be led to the conclusion that the universe is probably finite, from the study of the number of stars revealed by telescopes of various powers, but the mathematician finds nothing which seems to contradict the view that his sphere of action is infinite.

From what precedes one would expect that the number of fields of mathematical research appears unlimited, and this may serve to

¹ This view was expressed earlier by Kronecker, who was the main founder of the school of mathematicians who aim to make the concept of the positive integers the only foundation of mathematics. Cf. Klein und Schimmack, "Der mathematische Unterricht an den höheren Schulen," 1907, p. 175.

furnish a partial explanation of the fact that it seems impossible to give a complete definition of the term mathematics. If the above view is correct, we have no reason to expect that a complete definition of this term will ever be possible, although it seems possible that a satisfactory definition of the developed parts may be forthcoming.¹

Among the various fields of research those which surround a standing problem are perhaps most suitable for a popular exposition, but it should not be inferred that these are necessarily the most important points of attack for the young investigator. On the contrary, one of the chief differences between the great mathematician and the poor one is that the former can direct his students into fields which are likely to become well known in the near future, while the latter can only direct them to the well-known standing problems of the past, whose approaches have been tramped down solid by the feet of the mediocre, who are often even too stupid to realize their limitations. The best students can work their way through this hard crust, but the paddle of the weaker ones will only serve to increase its thickness if it happens to make any impression whatever.

It would not be difficult to furnish a long list of standing mathematical problems of more or less historic interest. Probably all would agree that the most popular one at the present time is Fermat's greater theorem. In fact, this theorem has become so popular that it takes courage to mention it before a strictly mathematical audience, but it does not appear to be out of place before a more general audience like this.

The ancient Egyptians knew that $3^2+4^2=5^2$, and the Hindus knew several other such triplets of integers at least as early as the fourth century before the Christian era.² These triplets constitute positive integral solutions of the equation

$$x^2 + y^2 = z^2.$$

Pythagoras gave a general rule by means of which one can find any desired number of such solutions, and hence these triplets are often called Pythagorean numbers. Another such rule was given by Plato, while Euclid and Diophantus generalized and extended these rules.

Fermat, a noted French mathematician of the seventeenth century, wrote on the margin of a page of his copy of Diophantus the theorem that it is impossible to find any positive integral solution of the equation

$$x^n + y^n = z^n \quad (n > 2).$$

¹ Bôcher discussed some of the proposed definitions in the Bulletin of the American Mathematical Society, vol. 2 (1904), p. 115.

² Lietzmann, "Der Pythagoreische Lehrsatz," 1912, p. 52.

He added that he had discovered a wonderful proof of this theorem, but that the margin of the page did not afford enough room to add it.¹ This theorem has since become known as Fermat's greater theorem and has a most interesting and important history, which we proceed to sketch.

About a century after Fermat had noted this theorem, Euler (1707–1783) proved it for all the cases when n is a multiple of either 3 or 4, and during the following century Dirichlet (1805–1859) and Legendre (1752–1833) proved it for all the cases when n is a multiple of 5. The most important step toward a general proof was taken by Kummer (1810–1893), who applied to this problem the modern theory of algebraic numbers and was thus able to prove its truth for all multiples of primes which do not exceed 100 and also for all the multiples of many larger primes.

The fact that such eminent mathematicians as Fermat, Euler, Dirichlet, Legendre, and Kummer were greatly interested in this problem was sufficient to secure for it considerable prominence in mathematical literature, and several mathematicians, including Dickson, of Chicago, succeeded in extending materially some of the results indicated above. The circle of those taking an active interest in the problem was suddenly greatly enlarged, a few years ago, when it became known that a prize of 100,000 marks (about \$25,000) was awaiting the one who could present the first complete solution. This amount was put in trust of the Göttingen Gesellschaft der Wissenschaften by the will of a deceased German mathematician named Wolfskehl, and it is to remain open for about a century, until 2007, unless some one should successfully solve the problem at an earlier date.

It is too early to determine whether the balance of the effects of this prize will tend toward real progress. One desirable feature is the fact that the interest on the money is being used from year to year to further important mathematical enterprises. A certain amount of this has already been given to A. Wieferich for results of importance toward the solution of Fermat's problem, and other amounts were employed to secure at Göttingen courses of lectures by Poincaré and Lorentz.

What appears as a bad effect of this offered prize is the fact that many people with very meager mathematical training and still less ability are wasting their time and money by working out and publishing supposed proofs. The number of these is already much beyond 1,000, and no one can foresee the extent to which this kind of literature will grow, especially if the complete solution will not be attained

¹ Fermat's words are as follows: "Cujus rei demonstrationem mirabilem sane detexi. Hanc marginis exiguitas non caperet."

during the century. A great part of this waste would be eliminated if those who would like to test their ability along this line could be induced to read, before they offer their work for publication, the discussion of more than 100 supposed proofs whose errors are pointed out in a German mathematical magazine called "Archiv der Mathematik und Physik," published by B. G. Teubner, of Leipzig. A very useful pamphlet dealing with this question is entitled, "Ueber das letzte Fermatische Theorem, von B. Lind," and was also published by B. G. Teubner, in 1910.

A possible good effect of the offered prize is that it may give rise to new developments and to new methods of attack. As the most successful partial solution of the problem was due to the modern theory of algebraic numbers, one would naturally expect that further progress would be most likely to result from a further extension of this theory, or, possibly, from a still more powerful future theory of numbers. If such extensions will result from this offer they will go far to offset the bad effect noted above, and they may leave a decided surplus of good. Such a standing problem may also tend to lessen mathematical idolatry, which is one of the most serious barriers to real progress. We should welcome everything which tends to elevate the truth above our idols formed by men, institutions, or books.

In view of the fact that the offered prize is about \$25,000 and that lack of marginal space in his copy of Diophantus was the reason given by Fermat for not communicating his proof, one might be tempted to wish that one could send credit for a dime back through the ages to Fermat and thus secure this coveted prize and the wonderful proof, if it actually existed. This might, however, result more seriously than one would at first suppose; for, if Fermat had bought on credit a dime's worth of paper even during the year of his death, 1665, and if this bill had been drawing compound interest at the rate of 6 per cent since that time, the bill would now amount to more than seven times as much as the prize. It would therefore require more than \$150,000, in addition to the amount of the prize, to settle this bill now.

While it is very desirable to be familiar with such standing problems as Fermat's theorem, they should generally be used by the young investigator as an indirect rather than as a direct object of research. Unity of purpose can probably not be secured in any better way than by keeping in close touch with the masters of the past,¹ and this unity of purpose is almost essential to secure real effective work in the immense field of mathematical endeavor. As a class of problems which are much more suitable for direct objects of research on the part of those who are not in close contact with a

¹ Darboux, Bulletin des Sciences Mathématiques, vol. 32 (1908), p. 107.

master in his field, we may mention the numerous prize subjects which are announced from year to year by foreign academies.

Among the learned societies which announce such subjects the Paris Academy of Sciences is probably most widely known, but there are many others of note. The subjects announced annually by these societies cover a wide range of mathematical interests, but they are frequently beyond the reach of the young investigator.¹ It is very easy to obtain these subjects, since they generally appear in the "notes" of many mathematical journals. In our country the Bulletin of the American Mathematical Society is rendering very useful service along this and many other lines. While some of these subjects are very general, there are others which indicate clearly the particular difficulties which must be overcome before further progress in certain directions seems possible and hence these subjects deserve careful study, especially on the part of the younger investigators.

As long as one is completely guided, in selecting subjects for research, by the standing problems or by the subjects announced by learned bodies and those proposed individually by prominent investigators, one is on safe ground. Real progress along any of these lines is welcomed by our best journals, as such progress can easily be measured, and it fits into a general trend of thought which is easily accessible in view of the many developed avenues of approach. Notwithstanding these advantages, the real investigator should reach the time when he can select his own problems without advice or authority; when he feels free to look at the whole situation from a higher point of view and to assume the responsibility of an independent choice, irrespective of the fact that an independent choice may entail distrust and misgivings on the part of many who would have supported him nobly if he had remained on their plane.

In looking at the whole situation from this higher point of view many new and perplexing questions confront us. Why should the developments of the past have followed certain routes? What is the probability that the development of the territory lying between two such routes will exhibit new points of contact and greater unity in the whole development? What should be some guiding principles in selecting one rather than another subject of investigation? What explanation can we give for the fact that some regions bear evidences of great activity in the past but are now practically deserted, while others maintained or increased their relative popularity through all times?

One of the most important tests that can be applied to a particular mathematical theory is whether it serves as a unifying and clarifying principle of wide applications. Whether these applications relate to

¹ For solutions of such problems in pure mathematics by Americans, see Bulletin of the American Mathematical Society, vol. 7 (1901), p. 190; vol. 16 (1910), p. 267.

pure mathematics only or to related fields seems less important. In fact, the subjects of application may have to be developed. If this is the case, it is so much the better provided always that the realm of thought whose relations are exhibited by the theory is extensive and that the relations are of such a striking character as to appeal to a large number of mathematical intellects of the present or of the future. Some isolated facts may be of great interest, but as long as they are isolated they have little or no real mathematical interest. One object of mathematics is to enable us to deal with infinite sets with the same ease and confidence as if they were individuals. In this way only can our finite mind treat systematically some of the infinite sets of objects of mathematical thought.

In comparatively recent years the spirit of organization has made itself felt among mathematicians with rapidly increasing power, and it has already led to many important results. Beginning with small informal organizations in which the social element was often most prominent, there have resulted large societies, national and even international, with formal organizations and with extensive publications. In reference to one of these early organizations, the mathematical society of Spitalfields in London, which lasted for more than a century (1717-1845), it is said that each member was expected to come to the meetings with his pipe, his mug, and his problem.¹

The modern mathematical society is dominated by a different spirit. It generally supports at least one organ for publication, and scholarly publicity develops scholarly cooperation as well as scholarly ambitions. This cooperation has led to movements which could not have been undertaken by a few individuals. One may recall here the *Revue Semestrielle*, published under the auspices of the Amsterdam Mathematical Society; the extensive movement to examine and compare methods and courses of mathematical instruction in various countries, inaugurated at the fourth international congress, held at Rome in 1908; and, especially the great mathematical encyclopedias, whose start was largely influenced by the support of the *deutschen Mathematiker-Vereinigung* as expressed at the Vienna meeting in 1894. The French edition of the latter work, which is now in the course of publication, is expected to include 34 large volumes, besides those which are to be devoted to questions of the philosophy, the teaching, and the history of mathematics.

These encyclopedias and other large works of reference are doing much to expedite travel in the mathematical field. In fact, it would probably not be exaggerating if we should say that by these encyclopedias alone the distances in time and effort between many points of the mathematical field have been cut in two. In this connection it may be fitting to recall with a deep sense of obligation the great

¹ "Es wurde von jedem erwartet, dass er seine Pfeife, seinen Krug und sein Problem mitbringe." Cantor, "Vorlesungen ueber Geschichte der Mathematik," vol. 4, 1908, p. 59.

work which is being done by the Royal Society of London—not only for mathematics, but also for a large number of other sciences—in providing bibliographical aids on a large scale. If the increase in knowledge will always be attended by a corresponding increase in means to learn readily what is known, even the young investigator of the future will have no reason to regret the extent of the developments. On the contrary, these should make his task easier, since they furnish such a great richness of analogies and of tried methods of attack.

The last two or three decades have witnessed a great extension of mathematical research activity. As a result of this we have a large number of new mathematical societies. A few of the most recent ones are as follows: Calcutta Mathematical Society (1908), Manchester Mathematical Society (1908), Scandinavian Congress of Mathematicians (1909), Swiss Mathematical Society (1910), Spanish Mathematical Society (1911), and the Russian Congress of Mathematicians (1912). In Japan a new mathematical periodical, called *Tôhoku Mathematical Journal*, was started in 1911, and a few years earlier the *Journal of the Indian Mathematical Society* was started at Madras, India. The Calcutta Mathematical Society and the Spanish Mathematical Society have also started new periodicals during the last two or three years.

While there has been a very rapid spread of mathematical activity during recent years, it must be admitted that the greater part of the work which is being done in the new centers is quite elementary from the standpoint of research. The city of Paris continues to hold its preeminent mathematical position among the cities of the world, and Germany, France, and Italy continue to lead all other countries in regard to the quality and the quantity of research in pure mathematics.

Although America is not yet doing her share of mathematical research of a high order, we have undoubtedly reached a position of respectability along this line, and it should be easier to make further progress. Moreover, our material facilities are increasing relatively more rapidly than those of the countries which are ahead of us, and hence many of our younger men start under very favorable conditions. Unfortunately, there is not yet among us a sufficiently high appreciation of scholarly attainments and scientific distinction. The honest and outspoken investigator is not always encouraged as he ought to be and the best positions do not always seek the best man. I coupled "outspoken" with "investigator" advisedly, since research of high order implies liberty and scorns shams, especially shams relating to scholarship. Even along these lines there seems to be encouraging progress, and this progress may reasonably be expected to increase with the passing of those who belong to the past in spirit and attainments. What appears to be a very serious element in our situation is the fact that the American university professor does not yet seek

and safeguard his freedom with the zeal of his European colleague. It is too commonly assumed that loyalty implies lying.

The investigators in pure mathematics form a small army of about 2,000 men and a few women.¹ The question naturally arises, What is this little army trying to accomplish? A direct answer is that they are trying to find and to construct paths and roads of thought which connect with or belong to a network of thought roads commonly known as mathematics. Some are engaged in constructing trails through what appears an almost impassable region, while others are widening and smoothing roads which have been traveled for centuries. There are others who are engaged in driving piles in the hope of securing a solid foundation through regions where quicksand and mire have combined to obstruct progress.

A characteristic property of mathematics is that by means of certain postulates its thought roads have been proved to be safe and they always lead to some prominent objective points. Hence they primarily serve to economize thought. The number of objects of mathematical thought is infinite, and these roads enable a finite mind to secure an intellectual penetration into some parts of this infinitude of objects. It should also be observed that mathematics consists of a *connected* network of thought roads, and mathematical progress means that other such connected or connecting roads are being established which either lead to new objective points of interest or exhibit new connections between known roads.

The network of thought roads called mathematics furnishes a very interesting chapter in the intellectual history of the world, and in recent years an increasing number of investigators have entered the field of mathematical history. The results are very encouraging. In fact, there are very few other parts of mathematics where the progress during the last 20 years has been as great as in this history. This progress is partly reflected by special courses in this subject in the leading universities of the world. While the earliest such course seems to have been given only about 40 years ago, a considerable number of universities are now offering regular courses in this subject, and these courses have the great advantage that they establish another point of helpful contact between mathematics and other fields.

Mathematical thought roads may be distinguished by the facts that by means of certain assumptions they have been *proved* to lead safely to certain objective points of interest, and each of them connects, at least in one point, with a network of other such roads which

¹ Between 5 and 10 per cent of the members of the American Mathematical Society are women, but the per cent of women in the leading foreign mathematical societies is much smaller. Less than 2 per cent of the members of the national mathematical societies of France, Germany, and Spain are women, according to recent lists of members. The per cent of important mathematical contributions by women does not appear to be larger, as a rule, than that of their representation in the leading societies. The list of about 300 collaborators on the great new German and French mathematical encyclopedias does not seem to include any woman. Possibly women do not prize sufficiently intellectual freedom to become good mathematical investigators. Some of them exhibit excellent ability as mathematical students.

were called mathematics, *μαθηματικά*, by the ancient Greeks. The mathematical investigator of the present day is pushing these thought roads into domains which were totally unknown to the older mathematicians. Whether it will ever be possible to penetrate all scientific knowledge in this way and thus to unify all the advanced scientific subjects of study under the general term of mathematics, as was the case with the ancient Greeks,¹ is a question of deep interest.

The scientific world has devoted much attention to the collection and the classification of facts relative to material things and has secured already an immensely valuable store of such knowledge. As the number of these facts increases, stronger and stronger means of intellectual penetration are needed. In many cases mathematics has already provided such means in a large measure; and, judging from the past, one may reasonably expect that the demand for such means will continue to increase as long as scientific knowledge continues to grow. On the other hand, the domain of logic has been widely extended through the work of Russell, Poincaré, and others; and Russell's conclusion that any false proposition implies all other propositions whether true or false is of great general interest.

During the last two or three centuries there has been a most remarkable increase in facilities for publication. Not only have academies and societies started journals for the use of their members, but numerous journals, inviting suitable contributions from the public have arisen. The oldest of the latter type is the *Journal des Sçavans*, which was started at Paris in 1665, while the *Transactions of the Royal Society of London*, started in the same year, should probably be regarded as the oldest of the former type. These journals have done an inestimable amount of good for the growth of knowledge and the spread of the spirit of investigation. At the present time more than 2,000 articles which are supposed to be contributions to knowledge in pure mathematics appear annually in such periodicals. In addition to these there is a growing annual list of books.

The great extent of the fields of mathematics and the rapid growth of this literature have made it very desirable to secure means of judging more easily the relative merit of various publications. Along this line our facilities are still very meager and many serious difficulties present themselves. In America we have the book reviews and the indirect means provided by the meetings of various societies and by such publications as the "American Men of Science."

The most important aid to judge contemporaneous work is furnished by a German publication known as the *Jahrbuch über die Fortschritte der Mathematik*. In this work there appear annually about 1,000 pages of reviews of books and articles published two or three years earlier. These reviews are prepared by about 60 different

¹ The term mathematics was first used with its present restricted meaning by the Peripatetic School. Cantor, "Vorlesungen über Geschichte der Mathematik," vol. 1 (1907), p. 216.

mathematicians who are supposed to be well prepared to pass judgment on the particular books and articles which they undertake to review. While these reviews are of very unequal merit, they are rendering a service of the greatest value.

The main object of such reviews is to enable the true student to learn easily what progress others are making, especially in his own field and in those closely related thereto. They serve, however, another very laudable purpose in the case that they are reliable. We have the pretender and the unscrupulous always with us, and it is almost as important to limit their field of operation as to encourage the true investigator. "Companions in zealous research" should be fearless in the pursuit of truth and in the disclosure of falsehood, since these qualities are essential to the atmosphere which is favorable to research.

While the mathematical investigator is generally so engrossed by the immediate objects in view that he seldom finds time to think of his services to humanity as a whole, yet such thoughts naturally come to him more or less frequently, especially since his direct objects of research seldom are well suited for subjects of general conversation. If these thoughts do come to him they should bring with them great inspiration. Who can estimate the amount of good mathematics has done and is doing now? If all knowledge of mathematics could suddenly be taken away from us there would be a state of chaos, and if all those things whose development depended upon mathematical principles could be removed, our lives and thoughts would be pauperized immeasurably. This removal would sweep away not only our modern houses and bridges, our commerce and landmarks, but also most of our concepts of the physical universe.

Some may be tempted to say that the useful parts of mathematics are very elementary and have little contact with modern research. In answer, we may observe that it is very questionable whether the ratio of the developed mathematics to that which is finding direct application to things which relate to material advantages is greater now than it was at the time of the ancient Greeks. The last two centuries have witnessed a wonderful advance in the pure mathematics which is commonly used.¹ While the advance in the extent of the developed fields has also been rapid, it has probably not been relatively more rapid. Hence, the mathematical investigator of to-day can pursue his work with the greatest confidence as regards his services to the general uplift both in thought and in material betterment of the human race. All of his real advances may reasonably be expected to be enduring elements of a structure whose permanence is even more assured than that of granite pillars.

¹ In 1726, arithmetic and geometry were studied during the senior year in Harvard College. Natural philosophy and physics were still taught before arithmetic and geometry. Cajori, "The Teaching and History of Mathematics in the United States," 1890, p. 22.

THE CONNECTION BETWEEN THE ETHER AND MATTER.¹

By M. HENRI POINCARÉ.

When M. Abraham came to me and asked that I close this series of sessions of the Société française de Physique, I was at first inclined to refuse. It seemed as if each subject had been completely discussed and that I could have nothing to add to that which had already been so well said. I could only try to put in words the impression which seemed to emerge as a summary of all the discussions, and that impression was so definite that each of you must have felt it. I did not see how I could make it any clearer by forcing myself to put it into words. But M. Abraham insisted with such good grace that I resigned myself to the inevitable difficulties of which the greatest is to repeat what each one of you has long since felt, and the least is to run through a maze of diverse subjects without the time to dwell on any one of them.

One thought must at once have struck all those present. The old mechanical and atomic hypotheses have, during recent years, become so plausible that they have ceased to seem like hypotheses; atoms are no longer just a convenient fiction. It seems almost as if we could see them, now that we know how to count them. A theory assumes reality and gains in probability when it accounts for new facts. Yet this may result in different ways. Generally it has to be enlarged to include the new data. Sometimes it loses in precision as it becomes broader. Sometimes it becomes necessary to engraft upon it an accessory hypothesis which plausibly fits in with it, but which nevertheless is somewhat foreign to it, and contrived expressly to fit a certain case. Then it can scarcely be said that the new facts confirm the original hypothesis, only that they are not inconsistent with it. Or, again, there may be between the new facts and the old, for which the hypothesis was originally conceived, such an intimate connection that whatever theory renders account of one must, because of that connection, render account of the other as well. Then the new data which fall in with the old are really only apparently new.

¹ An address delivered before the Société française de Physique, April 11, 1912. Reprinted by permission from *Journal de Physique*, Paris, 5th series, vol. 2, May, 1912.

It is quite different when we discover a coincidence which could have been predicted, and is thus not the result of chance, and especially when that coincidence is a numerical value. Now, there are coincidences of this last nature which have recently brought confirmation to our atomic views.

The kinetic theory of gases has thus received unexpected corroboration. New theories have been very closely patterned after the kinetic theory, for instance, the theory of solutions as well as the electronic theory of metals. The molecules of a dissolved substance, as well as the free electrons to which metals owe their electrical conductivity, behave just as do the molecules of a gas within its inclosure. The parallelism is perfect and can be followed even to numerical values. Thus what seemed doubtful becomes probable. Each one of these three theories, if it had to stand by itself, would seem only an ingenious hypothesis for which we might substitute other explanations equally probable. But when, as in each of the three cases, a different explanation would be necessary, the coincidences found would be inadmissible as the result of chance, whereas the kinetic theories make the coincidences necessary. Further, the theory of solutions quite naturally leads us to that of the Brownian movements, where it is impossible to consider the thermal agitation as a theoretical fiction, since it is actually seen under the microscope.

The remarkable counting of the number of atoms by Perrin completed the triumph of the atomic theory. What carries our conviction are the multiple concordances among the results obtained by completely different procedures. But a short time ago we would have thought ourselves fortunate if the numbers found had the same number of digits; we would have asked only that the first significant figure should be the same. That first figure we know to-day. What is more remarkable, we are now discussing even the most diverse properties of the atoms. In the processes used with the Brownian phenomenon, or in those used for the law of radiation, we do not deal directly with the number of atoms, but with their degrees of freedom of movement. In that process where we consider the blue of the sky, the mechanical properties of the atoms come into play; the atoms are looked upon as producing an optical discontinuity. Finally, when we take in hand radium, what we observe is the emission of projectiles. Here, were there discordances, no embarrassment would have been felt, but happily there were none.

The atom of the chemist is now a reality. But that does not mean that we have reached the ultimate limit of the divisibility of matter. When Democritus invented the atom he considered it as the absolutely indivisible element within which there would be nothing further to distinguish. That is what the word meant in Greek. It was for that reason that it was coined. Beyond the atom he wished

no further mystery. Therefore the atom of the chemist would not have satisfied him since that is not indivisible; it is not a true element; it is not free from mystery, from secrets. The chemist's atom is a universe. Democritus would have considered, even after so much trouble in finding it, that we were still only at the beginning of our search—these philosophers are never satisfied.

And so the second thought which comes home to us is that each new physical discovery brings added complexity to the atom. To begin with, these bodies, which we believed simple, and which indeed do act in many ways like simple bodies, may be separated into yet simpler components. This atom disintegrates into yet smaller atoms. What we call radioactivity is the perpetual breaking up of atoms. It is sometimes spoken of as a transmutation of elements; that is not strictly correct because an element is not really transformed into another element; it is really decomposed into several others. The products of the decomposition are still chemical atoms, similar in many respects to the more complex one, which in breaking up gave birth to them. It is a phenomenon which may be expressed by the most common kind of a reaction by a chemical equation which would be accepted with very little hesitation by the most conservative chemist.

Nor are we yet done, for within the atom we find yet more—electrons. Each atom is like a sort of solar system where the small negative electrons play the rôle of planets revolving around the great positive central electron which takes the place of our sun. It is because of the mutual attraction of these electricities of opposite sign that the system is bound together as a whole. This attraction governs the periods of the planets and these periods fix the wave lengths of the light emitted by the atom. It is because of the self-induction of the currents formed by the moving electrons that the atom so formed has an apparent inertia which we call its mass. Besides these captive electrons there are others which are free and subject to the ordinary kinetic laws of gases and which render metals conductive. The second class are like the comets which circulate from one stellar system to another, establishing thus an exchange of energy between distant systems.

But we have not yet come to an end. Besides these electrons, or atoms of electricity, we find magnetons, or atoms of magnetism, which we meet to-day through two different paths; through the study of magnetic substances and through the study of the spectra of simple bodies. I need not remind you of the beautiful discussion of Weiss and the astonishing relationships and commensurabilities which his experiments showed in such an unexpected manner. There were numerical relationships which could not be due to chance, and for which an explanation had to be sought.

At the same time an explanation was necessary for the curious distribution of the lines in the spectrum. According to the work of Balmer, of Kayser, of Runge, of Rydberg, these lines are distributed into definite series and each series obeys simple laws. We might at first expect to find these laws those of harmonics. Just as a cord, vibrating with infinite degrees of freedom, gives an infinite series of harmonics whose frequencies are multiples of the fundamental frequency of the cord, and just as a sonorous body of more complex form also gives out an analogous though less simple series of harmonics—for instance, a Hertz resonator is susceptible of an infinite number of different periods—so might an atom, for identical reasons, give out an infinite series of different wave lengths of light. You know that this simple explanation failed, because with the spectroscopic phenomenon it is the frequency and not its square for which the expression is simple; for the frequency does not become infinite for harmonics of an infinitely high order. The idea must either be modified or abandoned. All attempts at modification have been futile; the method refuses to be adapted. Accordingly Ritz abandoned this theory and represented the vibrating atom as formed of a rotating electron and several magnetons placed end to end. Then the mutual electrostatic attraction of the electrons no longer determines the wave length; that depends on the electromagnetic field formed by the electrons.

It is rather difficult to accept this idea because it seems somewhat artificial. However, we must resign ourselves to it for the time being since continued search for another has so far proved futile. How does the atom of hydrogen produce lines of several different wave lengths? It is not because each one of the atoms could produce any of the lines in the spectrum of hydrogen and does produce this or that one of the lines according to the initial condition of the vibration. It is because there are several kinds of hydrogen atoms, differing among themselves by the number of magnetons in line, each atom producing a different wave length. Can these different atoms change from one kind to another, and if so, how? How can an atom lose a magneton as does seem to happen when we pass from one allotropic form to another? Is it that a magneton escapes from an atom or do some of the magnetons in alignment change and become irregularly distributed?

This disposition of magnetons, end to end, is a peculiar characteristic of the theory of Ritz. The ideas of Weiss must seem to us in every way less strange. The magnetons must be placed either end to end or at least parallel since their resultant effects combine arithmetically, or rather algebraically, not geometrically.

Now what is a magneton? Is it a simple thing? No, provided we wish to retain the hypothesis that they result from special amperian

currents. A magneton is then a whirl of electrons and so our atom gains and gains in complexity.

We now come to something still better because it permits us to estimate the complexity of the atom, the theory which Debiegne announced near the end of this series of meetings. It relates to an explanation of the law governing radioactive transformations. The law is very simple. It is exponential. Its very form suggests at once the principles of statistics. We recognize the earmarks of chance. This chance does not here relate to the fortuitous encounters of atoms and other exterior bodies. Its causes lie within the interior of the atom itself. I wish to be understood to refer not only to the cause relating to this chance but to something yet deeper. Otherwise we would find external conditions, the temperature, for instance, having an effect upon the coefficient of the exponent. Now that coefficient is remarkably constant, indeed Curie proposed to use it as a measure of absolute time.

The chance which rules the transformations which we are considering lies wholly within the atom. That is, the atom of a radioactive body is a universe within itself and a world subject to chance. But if we consider a little further, when we talk of probabilities we think of great numbers of things. A closed world made up of a few elements would obey laws more or less complicated but they would not be those we consider when we deal with statistics. Then it must follow that an atom is a very complex world. It is true that a closed world, at least one nearly closed, would be at the mercy of any exterior perturbations to which we might subject it. Since the atom is subject to this statistical law there is consequently an internal thermodynamics of the atom and we can talk of the internal temperature of it. But, mark, this temperature has no tendency to get into equilibrium with the temperature without; it is as if the atom were shut up within a perfectly adiathermic shell. It is precisely because it is thus closed, because its functions are so sharply limited and guarded by this impervious shell that the atom is so individual.

At first, this complexity of the atom does not seem offensive; it seems as if we would not be embarrassed by it. But a little reflection brings difficulties not apparent at first. When we counted the atoms we really did not count their numbers directly but their degrees of freedom of movement, and we implicitly assumed that each atom had three degrees of such freedom. This also accounted for the observed specific heats. But each new complexity must introduce a new degree of freedom and we become troubled in our count of the atoms. This difficulty did not escape the attention of the originators of the theory of the equipartition of energy. They were astonished at the number of the lines in the spectra, but, seeing no way of escape from their difficulties, they boldly passed them by.

The most natural explanation seems to be this theory of the atom as a very complex world, one shut up entirely to itself. Exterior events have no relation to what passes on within, nor does what happens within affect the exterior world. That can not be strictly true or else we would be utterly ignorant that there is anything within and the atoms would appear as simple material points. The truth is that we can see what happens within only as through a very small window, and there is practically no exchange of energy between the interior and what is outside; there is consequently no tendency to equipartition of energy between the atomic world and that without. The internal temperature, as I have just stated, does not tend to approach equality with that outside. That is why the specific heats are the same as if no internal complexity existed. Let us now imagine a complex body made up of a hollow sphere whose inner wall is absolutely impervious to heat and within which is a great number of various bodies. Then the observed specific heat of such a body would be that of the exterior sphere just as if the interior bodies did not exist.

The door which closes the interior of this atomic world opens, however, from time to time, as when a particle of radium is shot off. The atom becomes degraded in rank in the radioactive hierarchy. What happened then? How did this decomposition differ from an ordinary chemical decomposition? In what respect does the atom of uranium, formed of helium and something else, have more title to the name atom than the half molecule of cyanogen, for instance, which behaves in so many ways like a simple body though formed of carbon and nitrogen? Doubtless the atomic heat (I do not know that it has been measured) of uranium must obey the law of Dulong and Petit and would correspond to that of a simple atom. It should then become double at the moment of the emission of the helium particle, when the primordial atom decomposes into two secondary atoms. Through that decomposition the atom acquired further degrees of freedom through which it may act upon the exterior world and the new degrees of freedom should become evident in an increased specific heat. What would be the difference between the specific heat of all the components and that of the compound body? One would expect that the heat set free by the decomposition would vary very rapidly with the temperature so that the formation of the radioactive molecule, which is strongly endothermic at ordinary temperatures, would become exothermic at higher temperatures. We could thus understand better how the radioactive compounds could form, a process which is very mysterious.

However, the conception of a little closed world, opened at moments, does not suffice to solve our problem. It would be necessary that the

equipartition of energy should be supreme outside the closed little world save at the moment the door opened; but that is not true.

The specific heat of solid bodies diminishes rapidly with decreasing temperatures as if some of the degrees of freedom of the atoms were successively paralyzed—frozen, so to speak—or, if you prefer, have lost connection with the exterior world, withdrawn within the interior in some unknown manner.

Furthermore, the law of “black” radiation is not what would be expected from the theory of equipartition. The law which results from that theory is the one derived by Rayleigh, and that law, besides involving an evident contradiction, since it gives an infinite total radiation, is absolutely at variance with experimental results. In the emission of a black body there is much less light of short wave lengths than would be required by the equipartition hypothesis.

Planck consequently devised his quanta theory, according to which the exchange of energy between the matter and the ether—or rather between ordinary matter and the small resonators whose vibrations furnish the light of incandescent matter—can take place only intermittently. A resonator can not gain energy or lose it in a continuous manner. It can not gain a fraction of a quantum; it must acquire a whole quantum or none at all.

Why, then, does the specific heat of a solid diminish at low temperatures? Why do its atoms seem to lose certain degrees of freedom? It is because the supply of energy offered to them at low temperatures is not great enough to give to each a quantum. Certain ones could get only a fraction of a quantum and, as they will take a whole one or none, they remain without.

It is just so in the case of radiation where certain resonators which can not have a whole quantum take none and remain inactive. Consequently there is much less radiation at low temperatures than there would otherwise be. Since the required quantity becomes greater as the wave length becomes shorter, it is especially the short wave-length resonators which remain inactive, so that the proportion of short wave-length light is much less than that indicated by Rayleigh’s formula.

To say that a plausible theory should remove all difficulties would be somewhat naive. When a somewhat daring theory is launched, difficulties are expected. If we upset all the accepted notions, we must not be surprised at some obstacles. Such difficulties do not count as valid objections.

I take the courage, therefore, to indicate some of these difficulties, and I will not choose those which are the greatest, nor the most evident, those which occur to everyone; that would be futile indeed, since you all recognize them immediately. I wish to state to you

the series of mental attitudes through which I have successively passed.

I asked myself first what was the value of the proposed demonstrations. I saw that I could get the probabilities of the various distributions of energy by simple enumeration, since the numbers were fortunately finite according to the hypotheses, but I could not see why they were all equally possible. Then I introduced the known relations between the entropy, the temperature, and the probability. That assumed the possibility of a thermodynamic equilibrium since the results could be proved supposing that to be true. I knew that such an equilibrium was possible, since experiment has proved it. But that did not satisfy me. I wished to show that it followed from the hypothesis; indeed, that it would be a necessary consequence. I really had no doubts, but I felt the necessity of seeing the matter a little more clearly and for that I needed to examine the steps of the process a little more in detail.

In order that there may be a redistribution of the energy between the resonators of different wave lengths whose oscillations produce radiation, it is necessary that they should be able to interchange their energy; otherwise the initial distribution would persist indefinitely, and as that distribution was arbitrary there would result no definite radiation law. Now a resonator can neither receive from nor give to the ether light except of a perfectly definite wave length. If, then, these resonators can not act upon each other mechanically, that is, without the intervention of the ether, or if they are fixed and immovable in a definite matrix, each of them could emit or absorb only light of a definite color and it could exchange energy only with a resonator with which it was in perfect tune. The initial distribution would remain unalterable. But we can conceive of two modes of exchange which are not objectionable. First, some atoms, some free electrons, might pass from one resonator to another, hit, and thus communicate or receive energy; or, secondly, the light, reflected as by a moving mirror, might change its wave length as recognized by the Döppler-Fizeau principle.

Are we free to choose between these two devices? Surely both must come into play, both should lead to the same result, the same law of radiation. What would we do if the results were contradictory, if the mechanism of collisions working alone led to one law of radiation, that of Planck, for instance, while the Döppler-Fizeau effect led to another? Very well, if both mechanisms came into play, one or the other would alternate in preponderance according to chance, thus causing an oscillation from one law to another, and there would be no tendency to a final stable state, toward that thermal death where there is no further change. Then the second law of thermodynamics would be violated.

I resolved to examine one by one the two processes, and I commenced with the one having mechanical action, collisions. You know why the old theories necessarily led us to the law of equipartition. It was because they assumed that all the equations of the mechanics were of the Hamiltonian form, and consequently made unity possible as the last multiplier in the Jacobian sense. We must therefore suppose that the laws of collision between a free electron and a resonator are not of this form and that the equations then admit of a final multiplier other than unity; otherwise the second law of thermodynamics would not hold and then we would find ourselves in the difficulty just stated. However, it is not necessary that this multiplier be unity.

It is exactly this last factor which is a measure of the probability of the corresponding state of the system (or rather we might call it the probability density). In the hypothesis of quanta, this factor can not be a continuous function since the probability of a state must be zero whenever the corresponding energy is not a multiple of a quantum. That is an evident stumbling block, but one to which we had to be resigned in advance. But I did not stop there. I pushed the calculations to an end and came out with the law of Planck, justifying fully the views of that German physicist.

I then passed to the Döppler-Fizeau mechanism. Let us imagine a receptacle formed of the body and piston of a pump, the walls of which are perfect reflectors and within which is inclosed a certain quantity of energy in the form of light. This energy is distributed in any manner whatever among the various wave lengths. The receptacle contains no source of light. The luminous energy is inclosed within the contrivance once forever.

As long as the piston remains fixed, this distribution of the energy among the wave lengths can not vary, for the light will retain the same wave lengths each time it is reflected. However, if the piston is moved, this distribution will vary. If the velocity of the piston is very small, the phenomenon is reversible and the entropy must remain constant. We would thus have the analysis of Wien and come out with Wien's law. We would have made no advance, since that law is common to both the old and the new theories. If the velocity of the piston is not very small, the phenomenon is not reversible, so that thermodynamic analysis would no longer lead to equalities but to simple inequalities and we could draw no conclusions.

However, it seems as if we could reason as follows: Let us suppose the initial distribution of the energy to be that of black radiation, evidently corresponding to a maximum of entropy. If we then give several strokes to the piston, the final distribution must evidently be the same, otherwise the entropy would diminish. And, indeed, whatever the initial distribution, after a very great number of strokes of the

piston the final distribution must be that corresponding to maximum entropy, which is the same as that of black radiation. Such reasoning has no value.

The distribution of the radiation has a tendency to approach that of black radiation. It can then no longer change, for we can not pass heat from a cold to a hot body; that is to say, without the expenditure of external work. But here external work is supplied through the strokes of the piston, which appears as an augmentation of the luminous energy in the cavity of the pump. The work is changed into heat.

The same difficulty would no longer exist if the bodies in movement on which the light suffered reflection were infinitely small and infinitely numerous; their kinetic energy would not correspond to mechanical work but to heat. We could not then compensate the diminution of entropy which corresponds to the change in the distribution of the energy by a transformation of work into heat, and then we would be right in concluding that, if the initial distribution were black that distribution would remain indefinitely.

Let us now imagine an inclosure with fixed and perfectly reflecting walls; let us inclose not only luminous energy, but also a gas. The molecules of the gas will act as moving mirrors. If the distribution of the energy among the wave lengths is that of the black radiation corresponding to the temperature of the gas, then that distribution should be stable; that is: First, whatever action the light has upon the molecules should not alter the temperature of the gas; second, whatever action the molecules have upon the light should not alter its distribution of energy.

Einstein examined this action of the light upon the molecules. The latter suffer something which resembles the pressure of radiation. Einstein, however, does not state the matter so simply. He compares the molecules to very small mobile resonators possessing at the same time not only the kinetic energy of translation, but also the energy of electric oscillations. The result at any rate would have come out the same—he reached Rayleigh's law.

Personally, I would have done the reverse and studied the action of the molecules upon the light. The molecules are too small to produce regular reflection. They could produce only a diffusion of it. It is this diffusion, when we neglect the molecular movements with which we are acquainted both in theory and experiment. It indeed produces the blue of the sky.

This diffusion does not alter the wave length, but is much greater the smaller the wave length.

We must pass now from the case when the molecules are at rest to when their motion must be accounted for, taking into account their agitation which produces their temperature. That is easy; it

is necessary only to apply the principle of relativity of Lorentz. Accordingly, the various bundles of rays of the same true wave length relative to the molecule and striking the molecule from various directions would not have the same apparent wave length to the observer who supposes the molecule at rest. The apparent wave length is not altered by the reflection, but the true wave length is.

We thus come to an interesting result: The reflected or diffused energy is not equal to the incident energy. What is unaltered is not the energy, but the product of the energy by the wave length. At first I felt satisfied. It seemed from this that an incident quantum would give a diffused quantum since a quantum varies inversely as the wave length. Unfortunately this brings us nothing.

I was led by this analysis to Rayleigh's law. I knew that in advance, but I hoped that in seeing in detail how I was brought to it that I could tell what modifications I must make in the hypothesis in order to get Planck's law. In that hope I was deceived.

My first thought was to look for something resembling the theory of quanta. It would indeed be surprising that two such entirely different explanations should both take account of the same derogation of the law of equipartition of energy. What is the effect of the discontinuous structure of energy? We might suppose that this discontinuity relates to the luminous energy itself when it passes through the free ether and so when it falls upon a molecule does so in a discontinuous manner, in little separate battalions. It is easy to see that that would not alter our results.

Or, we might suppose that the discontinuity occurs at the very moment of diffusion, that the diffusing molecule does not diffuse the light in a continuous manner, but by successive quanta. This again will not do because if the light wishing to be transformed has to wait, so to speak, in an antechamber for its omnibus to fill before starting out, there would result a forcible retardation. Now, according to the theory of Lord Rayleigh, the diffusion by the molecules in the direction of the incident ray produces simply ordinary reflection. That is to say, it interferes regularly with the incident light, and this would not be possible were there a retardation of phase.

If we try, impartially, to choose which of our premises we must abandon, we are none the less embarrassed. We can not see how we can deny the principle of relativity. Must we then modify our law for the diffusion of light by molecules at rest? That would be very difficult. We surely could not stretch our imagination into believing that the sky is not blue.

I will stop in this embarrassment and close with the following reflections. As science progresses, it becomes more and more difficult to fit in the new facts when they will not fit in spontaneously. The older theories depend upon the coincidences of so many numerical

results which can not be attributed to chance. We should not separate what has been joined together. We could not break their frames, only try to stretch them apart. And that we can not always succeed in doing. The theory of equipartition explains so much that it must contain a part of the truth; on the other hand, it can not all be true for it will not explain all. We can neither abandon it nor keep it without modification. Those modifications which we must make seem so strange that we hesitate to reconcile ourselves to them. At present we can only enumerate them without solving them.

EXPERIMENTS WITH SOAP BUBBLES.¹

By C. V. BOYS.

[With 1 plate.]

I had a certain feeling of hesitation in suggesting that you would perhaps be interested in seeing some experiments which I have devised with soap bubbles. I feared that such a subject would have but slight scientific interest for a learned body like yours. However, your accomplished secretary has assured me that my experiments will be well received, and so I trust that you will be indulgent.

To me a soap bubble is a beautiful thing. It appeals to several senses and to many kinds of minds; it is a source of delight to children, and we who know somewhat of the mysteries of molecular physics which it helps to reveal look at it with admiration. With its aid we are enabled to make clear the action of forces relating to other branches of physical science with greater facility and delicacy oftentimes than by any other means. I have observed that the soap bubble even arouses the curiosity of monkeys, and especially of those whose intellectual development is furthest advanced, viz, the chimpanzee and the orang-outang. In a word, among the objects with which we all are familiar and which excite in us a genuine scientific interest the soap bubble takes precedence of all others of the same weight.

Before I show you any of my experiments, it would seem to be incumbent on me to pay the tribute of my admiration to Plateau, that man of genius who, after being stricken with blindness, obliged to make use of the eyes and hands of his daughter-in-law, contrived and developed experiments and theories relating to the science of capillarity which have compelled the admiration of the scientific world, and whose great work, "Statique des Liquides," is a fit monument to the author's genius. When I reflect upon the wealth of

¹ Lecture before the Société française de Physique, April 12, 1912. Translated by permission from *Journal de Physique*, series 5, vol. 2 (August, 1912). See Soap bubbles: Their colours and the forces which mould them, by C. V. Boys, F. R. S., 10th thousand, Society for Promoting Christian Knowledge, Northumberland Avenue, London; E. S. Gorham, New York; and Boys (C.V.), member of the Royal Society: *Bulles de Savon*, Four lectures upon Capillarity, before a Juvenile Audience. Translated from English by Mr. C. Ed. Guillaume, Sc. D., with new notes by the author and the translator, 18 mo., 60 figures and 1 plate. Paris, Gauthier Villars, 1912.

knowledge which Plateau has bestowed upon us, it seems to me that I have but picked up a few crumbs which fell from the rich man's table.

The formation and existence of a soap bubble depend upon the weak superficial tension of the solution of soap and upon the remarkable property, studied by Willard Gibbs, by virtue of which the superficial tension varies, according to the needs of the moment, between elastic limits, in the true sense of the term. I was surprised to find by experiment that an increase amounting nearly to 20 per cent of the normal tension could be produced. Unfortunately, I can try no experiment here which would permit me to demonstrate to you this fact adequately.

The tension at the upper parts of a large bubble must be greater than that at the lower parts, for it must balance both the weight of the bubble and the tension of the lower parts. That is why there must be a superior limit to the possible size of a soap bubble. A bubble whose color is the bright apple green, weighing five one-thousandths grain per square inch,¹ can not exceed 100 inches in diameter, for in that case the additional force which the upper part has to withstand is one-half grain per linear inch, which is one-fifth of the normal tension of the film, i. e., $2\frac{1}{2}$ grains per linear inch. Similarly a bubble white of the first order, or weighing one one-thousandth grain per square inch, might extend to five times this diameter before this cause of failure would operate. But it is not possible in practice to blow such large bubbles. One great difficulty is, if mechanical means be not employed, to send air in sufficient quantity. With regard to this, Prof. Wood, of Baltimore, told me that he found the principle of injection very advantageous. Indeed, when we reflect, it exactly meets the necessities of the case. Internal pressure diminishing as the bubble increases in size, a small quantity of air blown into the tube will carry with it a large amount of air at a small but sufficient pressure.

I have tried several forms of injectors, but the simplest and hitherto the best is made of a bent pipe such as is employed in the testing of illuminating gas for sulphur. I blow into the narrow end by means of a mouthpiece, while the wide end is surrounded by a cambric band with a serrated edge which feeds the bubble with liquid as it increases. With this device I have not only blown a bubble of 80 centimeters diameter, but am convinced that this is by no means the practical limit. It may be worth mentioning that I make use of Plateau's liquid consisting of a solution in water of oleate of soda with glycerine added. The proportions are as follows: Oleate, 1 part; water, 40 parts; one-third of its volume of glycerine is then added. I have increased the proportion of oleate, especially when I have wished to blow large bubbles.

¹ These weights can be read off directly from the colored plate in my book.

If the pipe is warmed a little, the bubble which will then contain slightly warmed air will be a genuine Montgolfier's balloon, and will rise by its ascensional force. If the bubble have a diameter of 1 foot, it is surprising how long it will remain sufficiently warm to float in the air. When it begins to descend, it can be stopped by means of a current of air directed upward either by blowing with the pipe or with a pair of bellows. In the latter case, by accommodating the movements of the bellows to the soap bubble's natural period of oscillation, we may at once keep it in the air and cause it to execute vibrations of great amplitude. We may form it again and blow into the interior a very little illuminating gas, and it will then float of itself. The very heat of our breath suffices to make a bubble ascend if it be sufficiently large, e. g., 6 inches in diameter. The tin funnel of the old-fashioned gazogene is all that is needed for this experiment. But with a heated pipe, we may make even very small bubbles ascend for a few moments. The most convenient method of warming, however, is to allow the warm gases above a candle flame to be drawn in by the injector for a few seconds. Bubbles so blown will rise above buildings and float away out of sight.

It is clear that a cold bubble blown with air will float upon carbonic acid. I once entered the Grotto del Cane, near Naples, and blew numerous bubbles which floated all about me in the heavy gas, to the great delight of the custodian. Vapor of ether is more easily prepared and is still heavier than carbonic-acid gas. It is easier to use it for the purpose of supporting a bubble filled with air, but the vapor soon condenses upon the bubble, evaporates in the interior, and at the end of a short time the latter sinks into the vapor. If it be caught on a ring and brought near a lighted candle, the bubble will burst into flame, thus showing that the vapor has penetrated the interior. We may again blow a bubble by means of the tin funnel and hold it in the vapor. If we then bring a lighted candle near the open end of the funnel, a long flame like that of a Bunsen burner is formed by the issuing vapor. It is interesting to observe that if benzene (C_6H_6) be substituted for ether, the bubble will float as well but the penetration of the vapor will be less rapid. However, it finally enters and the bubble then burns with a brilliant flame. With pentane (C_5H_{12}), on the contrary, the bubble floats without the penetration of vapor, this substance being practically insoluble. A bubble of oxygen floating upon ether or benzene explodes violently like a bomb, when ignited.

The vapor of ether and a few other liquids somewhat diminish the superficial tension of a soap bubble, while the greater number of organic vapors increase it. This is especially noticeable with ammonia, which undoubtedly acts chemically upon the free molecules of oleic acid, combines with them and still further neutralizes the

special influence of the dissociated molecules, which influence Willard Gibbs showed and which tends to diminish the superficial tension. This action of ammonia may be very simply shown by resting a bubble upon a ring of wire of somewhat less diameter. If we hold above the bubble the stopper from a bottle of diluted ammonia, the bubble withdraws toward the lower side of the ring. If, on the other hand, a glass containing ammonia be held beneath the bubble, the action will be still more rapid, the bubble rising in opposition to gravity and squeezing itself through the ring. The motion occurs in each case as if the bubble were inconvenienced by the smell of the ammonia. If the bubble be too large to rise through the ring, a tear is formed, indicating its distress. Naturally, the cause of these actions is the increase of tension of the liquid sheet on the side of the ring to which the ammonia is applied, and if the bubble is too large, this increase of tension attracts a little of the liquid from the rest of the bubble and from the wire. This it is which forms the tear.

Dupré proved long ago that the speed with which soap bubbles burst is determined by the equality of energy in the movement of the little drops discharged at the speed of the retreating edge to that which is necessary to draw out the liquid sheet in opposition to its own tension. This may be expressed in Newton's manner in the following way: If the tension of a sheet of soap water be sufficient to support the weight of a certain number of feet in a sheet of a certain thickness or color, the speed with which a sheet of this thickness or color will break is the same as the speed acquired by a stone which has fallen freely this same number of feet under the influence of gravity. This is manifestly based on the supposition that the liquid is perfectly mobile. When the rigidity and viscosity increase, the speed is reduced. For example, a solution of saponin has a surface tension 50 per cent greater than that of a solution of soap. So a saponin bubble should burst more quickly than a soap bubble if surface tension only were of importance. For the benefit of those who are not familiar with saponin bubbles I will show you one as a curiosity (pl. 1, fig. 1). I shall next make a froth of saponin and glycerin in a cell in the lantern which you see projected on the screen. I may continue the operation until I obtain the ordinary appearance of froth. But the cells which are formed soon begin to burst. You may see the free edge retreat with a slow, irregular movement, which is due to the fact that the liquid is far from being a perfect fluid. Hence I conclude that a soap bubble will burst rather less quickly than the calculation would indicate. Mr. Bull could easily show you this by the aid of his very powerful micro-cinematograph.

In marked contrast with the slow bursting of this particular bubble, I can show you that the speed of a true soap bubble's bursting, which may be as great as that of an express train, may be rendered visible



FIG. 1.



FIG. 3.

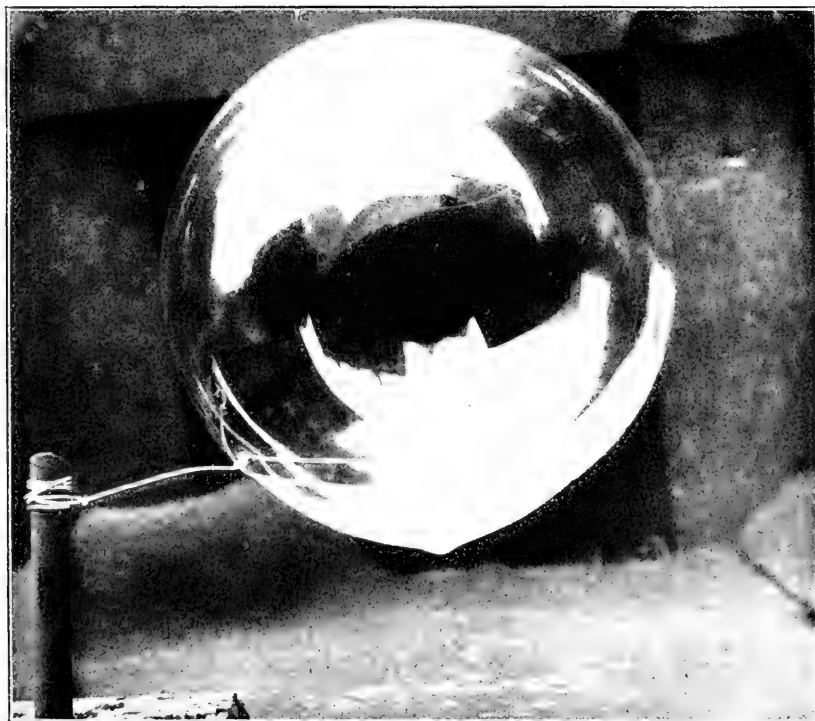

FIG. 2.

to the eye either when seen directly or when projected upon a screen. I have prepared a frame of brass wire upon which I can form a sheet of soap water 6 feet long and one-quarter of an inch wide, but zigzag, so that it occupies a surface of about 4 inches square. Further, I have so constructed it that the two ends of the sheet are adjacent. Then, on breaking the sheet at one end, we immediately see that the bursting is progressive, lasting about one-seventh of a second for the entire course. If the sheet be broken as soon as formed, when it is still thick, the motion of the edge is slower. If we let it drain until it shows the white or the colors of the first order, the motion of the edge is perceptibly more rapid.

The soap bubble furnishes a convenient means of illustrating the principle of stability. It would suffice here to refer to Plateau's labors upon this subject. However, I have arranged two experiments. The first is a variation of an experiment of Plateau's which showed that a very light sphere of glass remained in stable equilibrium upon the lower extremity of a vertical ring of wire if a sheet of soap water were spread over the ring. I have found that blown birds' eggs can be employed for this experiment provided that they be no heavier than those of the house sparrow, but the hole should be mended with a fragment of tissue paper and celluloid varnish.

The bird's egg offers the advantage of introducing a second principle of stability. It can remain in equilibrium only if its greatest cross section, i. e., its oval section, is in the plane of the liquid sheet. If the ring be made to revolve slowly in its own plane, the egg begins to roll or slip; then, the speed increasing, it rolls and jumps, but never leaves the liquid sheet. I have so arranged this experiment as to be able to project it upon the screen.

The second method of showing the conditions of stability depends upon the employment of cylindrical bubbles whose length is nearly π times as great as their diameter. Beyond that length, as Plateau has shown, a cylindrical bubble is no longer stable. As this length is approached, the stability is diminished, or, in other words, the bubble more easily loses its form. If we blow a spherical bubble with oxygen between the poles of an electromagnet of moderate power, we find that the action of the magnetism upon the oxygen is not sufficient to make the bubble move appreciably when the exciting current is closed. But if we make the bubble take the cylindrical form with an apparatus so constructed as to render its length nearly π times as great as its diameter, the magnetic influence immediately causes the separation of the bubble into two parts, the larger attached to the nearer ring remaining between the poles of the electromagnet and the smaller attached to the more distant ring.

I shall now blow a large bubble, using my mouth as an injector and employing my hands without any other apparatus. This method

was shown to me by Prof. Wood. After thus taking a bubble between my hands, I gently separate them until a neck is formed in the midst of the bubble and then until this is divided into two. I now beat the two bubbles together in a horizontal direction, and you observe that they do not unite, but flatten each other and resist nearer approach. If, on the contrary, they are made to approach in the vertical direction, they unite instantly and the approach is facilitated. In the first case, the clean, smooth surface of the two bubbles did not permit the air to be squeezed out, while in the second case the rough surface of the liquid which drips away at the lower part of the upper bubble broke the intervening layer of air. The two bubbles were then able to unite, either attached to a common face or septum, or, if the latter broke before becoming visible, re-forming the original single bubble. This operation may be repeated several times.

What I shall now show you rests upon the following property which bubbles possess: When their surfaces are smooth and clean, they may be pressed against each other without there being actual contact. If I place a bubble upon a horizontal ring just not large enough to admit of its passing through as a result of its own weight, and if I push it downward with a liquid sheet spread over another ring it will pass through at once. If we take care to remove all the drops which may form upon the lower surface, we shall be able to push it upward again. In no case does the liquid sheet really touch the bubble.

I blow a bubble under a ring and suspend from it another ring of aluminum wire so as to be able to give it a slightly elongated form. Inserting the pipe, I blow into the interior another bubble, which I detach. This second bubble will descend into the interior of the first until it finds a support at a certain parallel of latitude in its lower hemisphere and will remain there as long as no drop suspended from its lower part shall come into contact with the outer bubble. But these drops can be removed with the pipe. The outer bubble can then be elongated and pulled downward by means of the aluminum ring so as to compress the inner bubble and give it the form of a prolate spheroid, which can be swung around and around without there being actual contact between the two bubbles during these operations.

I then remove the lower ring by peeling it off, so to speak, and then withdraw the air present between the two liquid sheets until it is almost impossible to see between them. If I then blow in some air again tangentially, the inner bubble will assume a rapid rotary motion. The bubbles are too large to be easily projected upon the screen. However, I can make these operations and other similar ones more visible by simply utilizing the shadow thrown upon the screen by the positive crater of an electric arc.

I blow a bubble upon a ring and insert some coal gas or some hydrogen, and it tends to rise; but as it is held down by the ring, it is elongated upward, it assumes on an enlarged scale and in the opposite direction the form of a liquid drop, and finally detaches itself in a similar manner. When a bubble blown into the open air contains a very small quantity of illuminating gas, it may be that it is just light enough to float or that it has a tendency either to ascend or descend. If it be just light enough to have a tendency to ascend, we see that after some minutes, owing to a process of diffusion, condensation, and evaporation, it loses a little of its light gas and tends to descend again. On the other hand, a large bubble containing a quantity of illuminating gas not quite sufficient to support it may occasionally float along over a paved area and gradually descending it may rid itself of the heavy drop by contact with the stone and then, thus lightened, it can slowly remount. These large bubbles are very beautiful, especially when blown out of doors, and in the new edition of my book on soap bubbles I have given very numerous hints as to the most practical method of making them. Unfortunately, it is not possible in this amphitheater to reproduce the conditions of bubbles made in the open air. I should like, however, to point out that one of the most special features of the beauty of these bubbles is the sky line, which is seen in a kind of spherical perspective upon the upper surface and again, but then reversed, upon the lower surface. You do not see the images of windows reflected by bubbles in the open air, although you may see pictures representing this phenomenon. I can show you a photograph (pl. 1, fig. 2) I took of a bubble in the open air, and in which the buildings behind my office in London appear deformed according to a curious perspective I call spherical. The view is a dismal one, but the photograph is interesting; a similar view taken in a beautiful garden or near magnificent buildings would be still more attractive. A second photograph (pl. 1, fig. 3), which I took last November under most unfavorable conditions, shows that the bubble reflects portraits in a charming manner. A very large number of persons can thus be represented about a central figure, those more distant appearing smaller and those at the edge appearing elongated and curiously distorted. We may thus have an interesting souvenir of any special occasion. I have called these portraits dream portraits, and I commend them to your attention.

Let us return to our gas bubbles. I blow a gas bubble upon a ring and into the interior of this an air bubble. In the gas the air is so heavy that the bubble hangs like a heavy drop from the extremity of the pipe and it soon detaches itself. If, on the contrary, I blow an air bubble upon a ring and place in the interior a gas bubble the latter will float and rest against the upper wall of the outer bubble where there are no heavy drops to break the air film. If I now cause a little

gas to enter the outer bubble the inner bubble will float like Mohammed's coffin, suspended in space. I can now detach the outer bubble from the ring by means of a second ring or by blowing a third bubble in contact with the ring. Starting again, I blow a small gas bubble in an air bubble held upon a ring. With a second ring I lay hold of the outer bubble and draw it out into the form of a cylinder. If I incline it alternately in the two directions, the inner bubble travels backward and forward the entire length within this cylinder. Again, I remove the second ring and gradually blow more gas into the inner bubble. Thus I can enlarge it to the point of pulling upward sufficiently strongly to support the ring and small objects suspended from it. At no time, however, does the inner really touch the outer bubble, though it supports the load carried by the latter.

I begin again, and with one hand I place an outer bubble on a ring. I pass a ring into this outer bubble and then blow a bubble on it. I then blow a third bubble containing gas in the interior of the other two. I can then, at my pleasure, take away first one ring and then the other, and thus render the three bubbles free, or transfer them to another ring. It is possible, but not easy, to blow a fourth bubble in the interior of the first three. However, it is not possible to follow the same method as before, for we find ourselves limited by the number of hands.

If the two bubbles blown upon a ring are pressed against each other, we have seen that they do not unite; but if the least electrostatic attraction be established between the contiguous surfaces the union of the two bubbles is instantaneous and a single bubble is formed. This can be accomplished by means of a stick of sealing wax, or of a Morse key and wires connecting the supporting rings to the terminals of the electric arc. Two bubbles are much more sensitive than a gold-leaf electroscope.

I now take two bubbles, one within the other. If I bring a piece of sealing wax near the outer bubble, the influence exercised can be sufficiently strong to deform the outer bubble, but the inner bubble is not affected, for the electric force is nonexistent in the interior of a conductor. I know of no other means of demonstrating the absence of electric force in the interior of a conductor and at a distance from the exterior surface less than one twenty-five thousandth of an inch. The two preceding experiments may be combined into a single one, so as to show the contrast between the behavior of an outer bubble and an inner bubble. The two outer ones join while the inner remains unchanged.

Now, that I have finished my task, I must express the hope that the beauty of the phenomena which I have been able to show you may persuade you to pardon me for any failures I have met, for one can never be sure of succeeding every time, and especially for the small amount of purely theoretical interest in this communication.

MEASUREMENTS OF INFINITESIMAL QUANTITIES OF SUBSTANCES.¹

By Sir WILLIAM RAMSAY.

Our investigation of rare gases necessarily brought us to measure their densities, in order to be able to draw a conclusion touching their atomic weights. Until then (1895) vessels with a capacity of several liters were employed, e. g., Regnault in his classic experiments made use of balloons containing about 2 liters, while Lord Rayleigh employed vessels of the same capacity. Unable at the beginning of our researches to separate from the atmosphere more than 200 cubic centimeters of argon, we were compelled to determine its density with a much smaller quantity, about 160 cubic centimeters. It is obvious, however, that even this quantity is capable of giving a satisfactory result; for the weight of argon ascertained by the balance was 0.27 gram, and even with a balance the sensitiveness of which does not exceed 0.1 milligram, the error is no more than 1 part in 2,700.

Later, when we succeeded in obtaining the congeners of argon—neon, krypton, and xenon—which form a minimal fraction of the atmosphere, we became bolder. We weighed only 32 cubic centimeters of neon at a pressure of half an atmosphere; its weight was about 0.011 gram. As to krypton and xenon, the quantity at our disposal did not allow us to weigh more than 7 cubic centimeters; but their greater densities permitted the attainment of an equal degree of accuracy, for the weight was 0.015 gram. The error did not exceed 1 or 2 per thousand.

We also attempted to determine the specific volumes of krypton and xenon in the liquid state. We constructed capillary tubes in which the gases were liquefied at a low temperature, and we succeeded in measuring quantities such as 0.006 cubic centimeter.

But although these quantities are very small, those of the radioactive products are much smaller. In the first place, radium is not found in large quantities; and owing to the slowness of its disintegration, which continues for thousands of years, we have only minimal quantities of these substances at our disposal. Let me remind you, gentlemen, that half of the life of radium goes back 1,700 years, that it is disintegrated into emanation and helium, and that even with

¹ Lecture before the Société française de Physique, Session of April 20, 1911. Translated by permission from *Journal de Physique*, series 5, vol. 1 (June, 1911), pp. 429-442.

0.50 gram of bromide of radium, the total quantity of emanation can never exceed 0.1 cubic millimeter.

Let us first see what are the means at our disposal of performing these operations. We may calculate:

With a good chemical balance.....	$10^{-4}=0.0,001$
With an assay-balance.....	$10^{-5}=0.0,000,01$
With Nernst's micro-balance.....	$10^{-6}=0.0,000,001$
With the micro-balance constructed by Whytlaw-Gray.....	$3 \times 10^{-9}=0.0,000,000,003$
The spectroscope permits the discovery of helium. 2 ×	$10^{-10}=0.0,000,000,000,2$
The sense of smell (for mercaptan).....	$10^{-11}=0.0,000,000,000,01$
The electroscope.....	$10^{-12}=0.0,000,000,000,001$

Everyone is aware how the electroscope has become a much-used means of determining the presence of radium and thorium in rocks. To it M. and Madame Curie owed their discovery of radium, and those who determine the content of rocks in radium confidently distinguish between samples which contain 2.3×10^{-12} and those containing 2.4×10^{-12} gram per gram of ore.

Within the last few years we have been devoting our attention to the emanation into which radium changes spontaneously. Owing to the courtesy of the Vienna Academy, I have had at my disposal more than half a gram of bromide of radium, and Mr. Whytlaw-Gray and I have succeeded not only in measuring the quantity of gas which it continually gives off in the gaseous state, but even in determining its volume in the liquid state; in freezing it by cooling it with liquid air; in measuring the wave-lengths of the rays of its spectrum; and in weighing a quantity not exceeding one-tenth of a cubic millimeter. But that is not all. Messrs. Cuthbertson and Porter, my colleagues at University College, have invented an apparatus enabling us to determine the index of refraction of that minimal quantity. There is a proverb in English, "Cut your coat according to your cloth," and its parallel in French seems to be, "Regulate your mouth by your purse." Our purse contained but little of the noble element, and perhaps this lecture corresponds to that minimal quantity; but I rely upon your indulgence, "making of an egg an ox."

This bromide of radium, dissolved in water, was contained in a small glass bulb sealed onto a Toepler pump. You know, gentlemen, that under its influence water is decomposed into hydrogen and oxygen. We actually obtained weekly almost exactly 25 cubic centimeters of detonating gas. There is always a small excess of hydrogen, doubtless by reason of the formation of peroxide of hydrogen. This excess is very useful, for it gives after explosion a bubble of hydrogen which carries the emanation and permits of transferring it into vessels for experiment. Moreover, hydrogen is not condensed at the temperature of liquid air, while the emanation is deposited on the walls of

the vessel in a solid state. Consequently, we can easily separate the two, removing the hydrogen with the pump. The emanation then remains entirely pure.

I shall begin by giving you an idea as to how we set about measuring the volume of the emanation. In the first place, one must avoid all contact between the emanation and the grease of the pump-tap, for fear that the resulting carbonic acid may make the gas impure. We avoid all danger of this kind by sealing the explosion-tube with mercury; but in order to guard against this contamination, we leave the hydrogen with the emanation for three hours in a small tube whose upper part contains some caustic potash melted upon the walls. This period having elapsed, the products of the disintegration of the emanation have reached their maximum, for radiums A, B, and C have but a short life, changing into D, which is without radio-activity. It being necessary, for reasons which will appear later on, to measure the γ rays at this juncture, with the aid of an electroscope we determine the emanation's power of discharge.

In figure 1 we see the small tube *a*. We see also a reversed siphon closed by a kind of glass cap. The cap being raised and the tube placed above, the gases enter the apparatus through the capillary tube *b*, narrow at the upper end, to prevent the mercury from entering too rapidly.

But before introducing the gas it is necessary to empty the apparatus. Opening the tap and lowering the reservoir *f* we connect the pump with the apparatus. We remove all air and by means of the reversed siphon admit some hydrogen, which must remain for a night in the apparatus in order to displace atmospheric air adhering to the walls. This displacement is accelerated by heating in the flame the tubes *k*, *i*, *j*, *l*, *m*. In the morning the apparatus is again pumped empty. The reservoir *f* is raised in order to make the mercury ascend above the tap *h*, and the tap is shut. At noon the measurements of radioactivity will have been made, and we introduce the hydrogen with the emanation, replacing the cap, which, sealed with mercury, has no need of grease to make the joint air-tight. The gases can not come into contact with the tap, which is protected by the mercury.

You can see a tube *i* containing some pieces of caustic baryta. This arrangement is for two purposes: First, to dry the gas; secondly, to remove every trace of carbonic acid which may have escaped the action of the potash. The gas is left in the tube for half an hour to make sure that neither moisture nor carbonic acid remain.

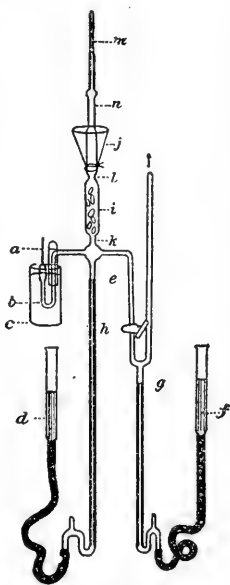

FIG. 1.

In j there is a cone of blotting-paper, which is moistened with water. Pouring in liquid air, it forms a vessel tight for liquid air, because it consists of ice. The tube which it surrounds is so cooled that the emanation freezes in its interior and is deposited upon the walls. We may now open the tap h , for the emanation can no longer be contaminated, and the hydrogen is pumped off. But even at the temperature of liquid air the emanation possesses some little vapor pressure, and, consequently, a certain quantity accompanies the hydrogen. To take this quantity into account, its radio-activity is next determined, and by comparing it with that of the gas before its introduction into the apparatus the loss is ascertained, and consequently the quantity remaining in the apparatus.

Having removed the hydrogen as far as possible, we raise the reservoir f in order to protect the tap h against attack by the emanation, and heat the tube j . The emanation is volatilized. Raising the reservoir d , it is compressed into the capillary tube m , where its volume is measured. But this tube must be chosen of such a diameter that its volume can be determined at a pressure little removed from that of the atmosphere. If we measure under too low a pressure, the correction for the capillarity, which may rise to two centimeters of mercury, becomes too great. However, it is difficult to estimate the magnitude of the correction, for we have been unable to find constant results for the capillarity; it seems to be influenced by the state of electrification of the mercury, due to the presence of the emanation. But that is of little consequence when the measurement is made at a pressure near 760 millimeters, for we may almost disregard a pressure of 5 millimeters, which does not exceed 0.7 per cent of the total pressure.

To give you an idea of the exactness of this measurement, allow me to state the result of a recent experiment by which we ascertained that a sample of helium had a volume of 0.042 cubic millimeter; the length of the tube measured was 20 millimeters, which permits the attainment of an approximation of 1/200. A platinum wire sealed through the top of the capillary tube makes it possible to test the purity of this gas by passing through it an electric discharge. The other electrode consists of the mercury of the reservoir, and we may prevent the lines of mercury from being seen by solidifying it with a paper cone filled with liquid air, surrounding the tube.

We have compressed the emanation so as to liquefy it; the tube containing it is of thick glass and can resist a considerable pressure. We have cut it off and mounted it in a compression apparatus like that of Amagat. The emanation liquefies at the ordinary temperature at a pressure of about 10 meters of mercury. The volume of gas, which was 0.1 cubic millimeter, was reduced to 0.00025 cubic millimeter; it occupied about 0.24 millimeter of the length of the

capillary tube. Naturally, we used a microscope to observe it. However, it was easy to observe its properties. The emanation is colorless like water when seen by transmitted light. Seen by reflected light, it makes the tube phosphorescent, and its color depends upon the nature of the glass. In silica it emits a white light, in soda-glass a lilac color, in potash-glass the color is greenish blue. When the emanation is liquefied in soda-glass its appearance recalls that of a cyanogen flame, being at the same time bluish and pink.

This gas when cooled to -71° becomes opaque and solidifies. A striking change of color is noticeable; the solidified emanation causes the glass to emit a brilliant steel-blue glow like a small electric arc. At a still lower temperature the color changes to yellow, and in liquid air it becomes orange red. When the temperature rises, the changes of color come in inverse order. Though its brilliancy is very intense, I scarcely think that its use can rival modern methods of illumination.

We have succeeded in measuring the volume of this rare liquid, and knowing, as we shall see later, that the density of the gas is 112.5, we may calculate the density of the liquid. It is very heavy, 5.7 times heavier than water.

I have hitherto designated this gas by the name given it by Messrs. Rutherford and Soddy. But it doubtless belongs to the series of inactive gases, and there are already three emanations—that of radium, of thorium, and of actinium. The expression “radium emanation” is not a very happy one, and we had to seek a name to indicate one of the striking properties of the gas and at the same time to recall its congeners of the argon series. We coined the name of niton, signifying “shining.” It is true we paid no heed to the scruples of the purists, who forbid the addition of a Greek ending to a word of Latin origin. My excuse is that it was a generally accepted custom among the Greeks to adopt Latin words (e. g., *σοῦδαριον*, *δηνάριον*, *πραιώριον*, *Κήρσος*, and numerous others).

Dr. Collie and I succeeded in 1904 in measuring the wave lengths of some of the spectral lines of niton. In collaboration with Mr. Cameron other attempts were made. Mr. Watson made in my laboratory a thorough study of this question with niton purified by me. According to Prof. Hicks, this spectrum presents close analogies with the spectra of the inactive gases. Being itself an inactive gas, there were many probabilities for its belonging in that series of elements.

Several attempts have been made to determine precisely the atomic weight of niton. I shall confine myself to mentioning the experiments by means of diffusion of Curie and Danne, of Bumstead and Wheeler, of Rutherford and Miss Brooks, of Makower, of Chaumont,

and of Perkins. Suffice it to say that the results vary between 70 and 235 for the atomic weight. Debiérne, employing Bunsen's method, which is based on the escape of gas through a narrow orifice, gives the figure as 220. Now, taking into account the fact that radium in changing to niton gives off an atom of helium, and accepting for the atomic weight of radium 226.4, found by Madame Curie and confirmed by Thorpe, the atomic weight of the emanation must be $222.4 = 226.4 - 4$.

The molecular weight is fixed by the density, and in the case of a monatomic gas (and there is every reason to believe that niton is monatomic) the molecular weight becomes identical with the atomic weight. As a definite test it was necessary to weigh a known volume of niton.

But how is it possible to weigh a gas of which the largest available quantity did not exceed one-tenth of a cubic millimeter? I have already hinted that, with the aid of the microbalance invented by Steele and constructed by Whytlaw-Gray, the idea is not chimerical. Let me give you a sketch of the methods we have employed.

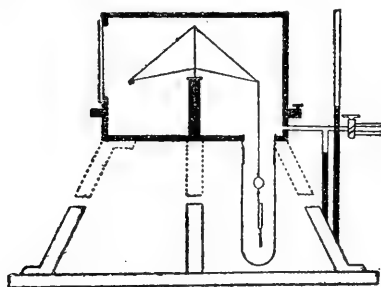

FIG. 2.

First, however, I must make clear the construction of the balance. Scientists have for some years been employing a new substance—melted quartz. Everyone knows how resistant it is. Its coefficient of expansion by heat is almost zero, and we may work it like glass, drawing out rods of suitable thickness. Before constructing the balance, I consulted my colleague, the professor of engineering, as to the best form for a bridge to permit it to resist a maximum pressure. He was so kind as to give me a drawing of it.

To construct the balance-beam grooves are drawn upon a plate of graphite with a knitting needle, and in these short rods of silica of about a half millimeter in diameter are placed. Where the ends of the rods touch, they are melted by turning on them for a moment the flame of an oxyhydrogen blowpipe. The knife-edge is formed of a small drop of silica, melted at the end of a short rod and ground to the form of a wedge with the greatest care. Seen under a microscope it must be straight, without notches, and well polished. Perpendicular to this rod and quite near the knife-edge is sealed a second rod which serves to adjust the knife-edge so that when the rod is sealed to the beam of the balance, the knife-edge forms a right angle with the plane of the beam. This second rod serves also to support a small mirror of platinized silica reflecting the light of a Nernst

lamp, which falls on a scale at about 3 meters from the mirror. The filament of the lamp projects its image upon the scale, divided into millimeters.

The balance is contained in a brass box, in which a vacuum may be made. This box is perforated with two holes upon the lower surface, opposite and below the ends of the beam. There are cemented in these holes two hollow glass-stoppers, into which two tubes of about 3 centimeters' diameter are fitted. In each of these tubes is suspended a very delicate quartz-fiber, soldered to one end of the balance-beam. These threads bend with the greatest ease. There are no pans. Suspended from one of the threads is a small bulb of silica, whose capacity has been ascertained by weighing it filled with mercury. Thus it contains a known volume of air of known temperature and pressure; consequently, the weight of the air is known. A solid counterpoise of silica is suspended from the other thread.

Now, when the air in the box containing the balance is under ordinary pressure, the bulb is balanced by its counterpoise; but if the pressure be diminished, the bulb sinks. If, on the contrary, the pressure be increased, the bulb floats and its apparent weight becomes less. Thus we may, by altering the pressure, add or take away small known weights. It suffices to read the pressure on a manometer, and the temperature, so as to have data for the calculation.

The objects to be weighed are hung on the thread by small hooks of silica. But before weighing, the sensitiveness of the balance must be determined. This is done by means of a silica rod attached vertically to the center of the beam. It is originally longer than is necessary in order to be able to draw off small pieces of it by softening the silica with the blowpipe. Each time this is done the oscillation period of the balance is determined. Finally traces of silica are volatilized by heating in the blowpipe flame until the oscillation has acquired a sufficiently long period—e. g., an oscillation in 50 seconds.

The vessel containing the object to be weighed is held in equilibrium by a counterpoise consisting of a hook of silica. With this counterpoise air must be admitted into the box up to a known pressure. We began originally by admitting unpurified air, but were not long in discovering that every trace of dust and moisture must be removed. The air which enters is consequently purified by passing through a column of pentoxide of phosphorus, of soda-lime, and of cotton wool.

Above a pressure of 150 millimeters of mercury, currents of air in the box exercise a disturbing influence. It is therefore arranged that the balance shall be in equilibrium at a pressure of about 80 millimeters. To this end we must alter the counterpoise, which is

done by adding small pieces of silica or by volatilizing a trace of it with the blowpipe. This operation requires about an hour.

My hearers will now understand that we have a balance capable of indicating a difference in weight of about two or three millionths of a milligram.

In order to conceive of that, let us consider first that the bulb contained a volume of air which, at normal pressure and at 0° C., weighed 0.027 milligram. Each millimeter of the pressure gauge corresponds, consequently, to $\frac{0.027}{760}$, or 0.0000355 milligram = 3.5 hundred-thousandths, but each interval of ten divisions of the scale on which the light of the Nernst lamp is reflected from the mirror of the balance corresponds to 1 millimeter of pressure. Consequently, one division of the scale registers three-millionths of a milligram. As it is easy to read to the tenth of a division, we should be able to determine a variation of three ten-millionths of a milligram. As a matter of fact the sensitiveness is not so great. As I have already said, we may take it at two to three millionths.

Having now explained the construction and operation of the balance, I should like to say a few words as regards our experiments with niton, the density of which we have determined.

Let me remind you that we contrived a method by which a gas can be imprisoned in a capillary tube. Before making experiments with the precious niton, we tested the balance by weighing xenon, and as I possess 100 cubic centimeters of it, it was easy to afford half a cubic millimeter.

Having measured 0.0977 cubic millimeter of xenon in a capillary tube, we solidified it at the top of the tube with a little cone of moist blotting paper filled with liquid air. It was sealed by turning a little flame on the tube above the cone, and placed in a small "bucket" hung on the balance. It was counterpoised and the pressure at which the spot of light was at zero of the scale was observed. To open the little tube without losing splinters of glass we removed with platinum-forceps the "bucket" which it exactly fitted, and we pushed it into the bucket so that the pointed end was broken. We then replaced the bucket and tube on the balance. To remove the xenon from the tube, a vacuum was made in the box several times, and by means of the little air-bulb by changing the pressure we ascertained the loss in weight corresponding to the xenon. The change of pressure was 17.1 millimeters (70-52.9), which corresponds to 608 millionths of a milligram.

But that does not give the true weight of the xenon, for the tube is filled with air at a pressure of 52.9 millimeters, and as the volume of the small tube is known, its weight can be estimated. It is 46 millionths, so the total weight is the sum of the two, or 654 millionths of a milligram. There is even yet a correction to be made.

First, the tube was of glass, and its density differs from that of silica of which the counterpoise consisted.

To determine the alteration due to this difference of densities, the bulb was removed and a counterpoise of solid silica substituted. Weighing again, we found a difference of 91 millionths, which being subtracted leaves 561 millionths. Secondly, a correction is to be made owing to the xenon's having been weighed at a pressure of 70 millimeters, while the pressure has been changed to 52.9 millimeters. If we had weighed the sealed tube at a pressure of 52.9 millimeters instead of 70 millimeters, it would have weighed more. The correction, then, is positive. We must find the difference between the weight of 0.536 cubic millimeter (the capacity of the bulb) at 70 and at 52.9 millimeters (17.1 millimeters). The equation

$$17.1 \times 0.536 \times \frac{1.29}{760} \times 1000 = 15 \text{ millionths}$$

gives this weight, where 1.29 is the weight in milligrams of a cubic centimeter of air.

Thus we have $561 + 15 = 576$ millionths of a milligram for the weight of the xenon. It is easy to show that the weight calculated should be 577 millionths.

Allow me to give another example of weighing with this balance. Mr. Whytlaw-Gray and I have ascertained the weight of helium formed by niton when it changes to radium A, B, C, and lastly D, in the manner already described we filled a tube with niton in July, 1910. We left it until the beginning of October, that it might change to helium and radium D. This last has a half-life of about 16 years, so that it may be regarded as permanent. The tube was weighed, the point was broken, and it was immediately again placed on the balance. The loss of weight was 15 millionths, its volume was 0.196 cubic millimeter, and the weight of air which entered at a pressure of 37.7 millimeters and 18.5° C. was 12 millionths; therefore, the total weight of the helium was 27 millionths.

But given the quantity of niton employed, we should have obtained 38 millionths, so it became necessary to look for it. Now, under the influence of niton the gas molecules which are found in the same vessel are forced to accelerate their velocity, doubtless because of collisions with the α particles projected during the disintegration of the atoms of niton. This velocity causes them to penetrate the walls of the vessel containing them, and the result of our experiments is that the penetration depends not only upon the velocity but also upon the size and form of the molecules. Thus, helium mixed with niton penetrates the glass more than neon and neon more than hydrogen. However that may be, we heated the tube in a small tube of silica surrounded by a second tube to prevent the entrance of the

gases of the flame. We removed the gases with the pump, and, by means of carbon cooled with liquid air, absorbed the oxygen introduced at first to displace the air, which might have contaminated the gases with a trace of neon and helium. The residue measured 0.042 cubic millimeter; its spectrum was that of pure helium, and its weight was eight millionths of a milligram. Adding this to the weight already indicated by the balance, we obtain thirty-five millionths, which differs by only three millionths from the figure calculated upon the hypothesis that every atom of niton, on disintegrating into radium D, lets three atoms of helium escape—i. e., three α particles.

Our main object was to find the true atomic weight of niton. To do this we introduced, in five experiments, quantities of it varying between 0.075 cubic millimeter and 0.0566 cubic millimeter into density tubes as I have already described. These are the volumes of the niton actually removed from the tubes with the pump. It is self-evident that corrections had to be made for the losses of niton due to its partial spontaneous decomposition into solid products and for the part that had penetrated the walls, either under its own form or under that of helium. The weights we found range between 572 and 739 millionths of a milligram. The atomic weights were 227, 226, 225, 220, and 218; mean 223. Starting from the determinations of Madame Curie and Sir Edward Thorpe of the atomic weight of radium and subtracting that of helium, 4, we obtained the atomic weight of niton, 222.4, a sufficiently satisfactory agreement.

Let me describe to you briefly another experiment by Messrs. Cuthbertson and Porter, of the Physical Institute, University College. The object is to find the index of refraction of niton by employing less than one-tenth of a cubic millimeter of this gas. At the end of a sealed capillary tube they polished two surfaces parallel to the axis of the tube and perforated the tube with a small hole perpendicular to these surfaces. By cementing two plates of polished glass to the surfaces a small chamber was constructed with a capacity of about 1 cubic millimeter. They platinized two small circles on the polished glass so that the light could pass through the platinized part and also be reflected by the metallic surfaces of the plates. This thermometer tube formed the upper part of an apparatus such as that which I have described to you, into which purified niton could at pleasure be introduced. Looking at the green light of a mercury lamp through the hole, fringes in the form of concentric circles could be seen, the lengths of whose radii change with every change of pressure. By measuring the number of bands which pass through a fixed point for a known change of pressure the refraction of the gas can be calculated.

Several measurements were more or less successfully made. The difficulty which made it impossible to continue the investigation was entirely unforeseen. This was the corrosion of the platinum by the

niton. The platinum becomes deep black and thus entirely loses its transparency; and it is impossible after a few minutes to see any light through the platinized plates. But before the attack began a few observations were made indicating as the refraction ($\mu-1$) of niton a figure approximating 0.001633 for white light, or about 45 times that of helium, 0.000035. You will perhaps remember that Mr. Cuthbertson pointed out a very curious relationship among the figures expressing the refractions of inert elements. Those of helium, neon, argon, krypton, and xenon show the simple relation 1, 2, 8, 12, and 20. That of niton seems to be in relationship with the others.

The possibility of weighing such minimal quantities suggests investigations which must be very interesting. We might, for instance, calculate the thickness of the layers of gas attached to solid objects, for their weights are quite perceptible. Dr. Whitlaw-Gray weighed a very light capsule of gold with a surface of about 2.5 square centimeters. After heating it to redness he at once replaced it on the balance and counterpoised it. It gained in weight for two days, the total increase being 1,000 millionths of a milligram. Calculating the thickness of such a layer of air, it appears to be seven molecules thick. There is evidently much to be done in that respect, for the substances, the nature of the gas, the temperature, and the pressure may be varied at pleasure.

We have also learned another extraordinary fact. We needed pure water which should leave no solid residue in evaporation. Although we distilled water in vessels of platinum, silica, and silver, we could never obtain a drop but there remained after evaporation a crystalline deposit. We even attempted synthetic water prepared by burning hydrogen in contact with chilled vessels of glass, silica, platinum, and silver. The drops obtained all left a similar deposit weighing about 100 millionths the drop. We spent a weary fortnight in attempts of this kind, and finally discovered that no residue is obtained when water is evaporated in a current of air filtered through cotton wool. The residue came from the dust suspended in the air. According to their appearance the crystals consisted for the most part of common salt, carbonate of lime, and sulphate of lime.

Thus it is evident that water in evaporating is charged with electricity and attracts dust, which possesses a relatively great weight.

Gentlemen, these are some of the experiments we have been carrying out during the last few years. Instruments such as the spectroscope, the microscope, and the electroscope have been highly perfected for the investigation of minimal quantities. We have often had reason to regret that our means of determining the quantity of matter by its weight and volume have lagged so much behind. I trust we have not wearied you in giving some account of our attempts to see the invisible, to touch the intangible, and to weigh the imponderable.



THE LATEST ACHIEVEMENTS AND PROBLEMS OF THE CHEMICAL INDUSTRY.¹

By Prof. Dr. CARL DUISBERG,

Of Eberfeld, Germany.

Probably in no domain of human knowledge and endeavor have the combined forces of theory and practice, intimately acting and reacting upon each other, made such immense strides and led to the solution of such difficult problems as in the chemical industry, an industry which, indeed, had its beginnings in the distant past, but in its vast development and international character is essentially a child of modern times. Success has so emboldened this industry that it considers itself capable of solving any problem, provided the men in its service are well trained in theory and practice and ready to devote themselves to the best of their ability, with patience and perseverance, to the object in view. This has been shown by the struggle between the contact process of producing sulphuric acid and the old "chamber process"; by the rivalry between the Solvay process and the Le Blanc method in the manufacture of soda; by the production of nitric acid and its salts by direct oxidation of nitrogen of the air under the influence of the heat of the electric discharge; by the manufacture of ammonia from atmospheric nitrogen indirectly via calcium cyanamide, and directly by combination with hydrogen; by the replacement of madder by alizarine, and of natural by synthetic indigo, as well as by innumerable other instances in the color, perfume, and pharmaceutical industries.

If, before an audience not wholly consisting of chemists, I venture, within the brief period of an hour, to describe the latest achievements of the chemical industry and to recount the problems that are engaging our attention, I must restrict myself to a great extent both in the choice of the subject matter and its mode of presentation. We can, indeed, merely touch upon the most important happenings in our industry and must, from the very outset, refrain from a thorough discussion of the subject, either from the purely chemical or the technical side. However, what can not be described for lack of

¹ General lecture at Eighth International Congress of Applied Chemistry, College of the City of New York, Sept. 9, 1912. Reprinted by permission from author's pamphlet.

time, and what we should very much like to add for the sake of those chemists who are present, is illustrated by that rich collection of diagrams, products, and materials of all kinds. What can neither be mentioned in my paper nor illustrated by these exhibits will be demonstrated by means of lantern slides, and, should you possess patience enough, I shall show you at the conclusion of my address one of the newest factories which the German chemical industry has built on the Rhine, with its various manufacturing departments, and, above all, its provisions for the welfare of its employees.

In the spirit of Faust, "Who brings much will bring something to many," I invite you to make a flight with me in an airship, as it were, over the fields where the chemical industry holds sway, and, from our point of vantage, to take a bird's-eye view of the latest achievements of this industry. Now and then we shall make a landing and examine the most attractive features a little more closely.

PRODUCTION OF POWER.

The question of power, which is of the utmost importance in every industry, and especially in the great synthetic processes by means of which nitric acid and ammonia are manufactured, is now dominated by the perfected utilization of hydraulic power and the development of the turbine. Not only does the transmission of electric energy render it possible to utilize water power at great distances, but it also allows of the transmission of power evolved at the coal mines and the peat fields to distant points, thus eliminating the necessity of transporting the fuel itself. Recently we also learned to apply the principles of the water turbine to the steam turbine. But this advance over the piston steam engine, which Watt so ingeniously constructed about 150 years ago, has already been surpassed by benzine, petroleum, or oil motors (Diesel motors), and, above all, by the reliable gas engines which are driven by blast-furnace gases, Mond gas, and more recently by peat gas.

PRODUCTION OF BY-PRODUCTS.

The manufacture of by-products goes hand in hand with this more direct generation of energy from fuel. These products include ammonium sulphate, of such great importance in agriculture, and the tar distillation products, so indispensable in the color industry. The latest and most rational method of utilizing the peat or turf beds, which are so plentiful in Germany and in many other countries, is practiced in Schweger Moor, near Osnabrück, according to a process discovered by Frank and Caro. There peat gas is produced and utilized and ammonia obtained as a by-product, the required power being generated in a 3,000-horsepower central electric power station.

The moorland, after removal of the peat, is rendered serviceable for agricultural purposes.

At that place nearly 2,500 to 2,600 cubic meters of gas, with 1,000 to 1,300 calories of heat, were obtained from 1,000 kilograms of absolutely water-free peat in the form of air-dried peat, with 45 to 60 or 70 per cent of moisture. This gas represents energy equal to 1,000 horse-power hours, equal to 700 kilowatt hours, after deducting the heat and power used for the operation of the gas works. In addition 35 kilograms of ammonium sulphate were produced from the above quantity of peat, which contains 1 per cent of nitrogen.

The greatest problem of power production, the direct conversion of coal into electric energy by means of gas batteries, a problem which we had hoped to solve 25 years ago, is still to-day nothing more than a dream.

PRODUCTION OF COLD.

Besides the problem of power and heat, the question of refrigeration is one of growing importance to the chemical industry. Instead of the ammonia machines with which a temperature of minus 20° C. can be attained, we employ to-day sulphurous-acid machines, or, better still, resort to the carbonic-acid gasifier, which yields a temperature of 40° C. below zero. It is hoped in the near future to produce refrigerating machines which, by the use of suitable hydrocarbons, will give temperatures of minus 80° C. Plants for the liquefaction of air, producing as low a temperature as minus 190° C., are becoming more and more common, and are especially profitable where gas mixtures rich in oxygen, or where pure nitrogen, which are simultaneously produced, can be utilized. Diagrams showing the process invented by Linde for the rectification of liquid air with the object of isolating nitrogen and oxygen are exhibited here. The Badische Anilin and Soda Fabrik in Ludwigshafen on the Rhine intends to manufacture hydrogen from water gas in a similar way and to utilize the carbon monoxide, which is simultaneously obtained, as a source of power. In a large plant which is being erected the firm is going to produce ammonia synthetically by combining, according to Haber's invention, pure nitrogen, obtained by the liquefaction and rectification of air, with hydrogen manufactured as above. Particulars about this process will be given during the congress by Prof. Bernthsen in his lecture on "Synthetic ammonia."

SIZE OF APPARATUS.

Influenced by the Solvay process for the manufacture of soda and its pecuniary advantages, the apparatus used in the chemical industry have enormously increased in size. In this respect the United States, no doubt on account of the example set by the iron industry,

with its blast furnaces with a daily capacity of 500 tons, its giant conveyers (50-ton wagons), its huge hoisting cranes, is ahead of other countries. But careful calculations have proved that there is a limit in this direction. The failure, on account of size, of the Mactear sulphate furnace, with a daily output of 25 tons, is well known, whilst the mechanical sulphate furnace of the Verein Chemischer Fabriken in Mannheim, which produces only 7 tons a day, is a success everywhere. It is not improbable that the high cost of construction and the great loss which accidental stoppage entails will necessitate a reduction in size of the wonderful Wedge furnace, a creation of the United States, which roasts 30 tons of iron pyrites per day.

In the organic chemical industry the iron vessels for chlorination, sulphonation, nitration, reduction, and oxidation, as well as the wooden tanks in which we diazotize and produce colors, have developed from the small vessels and vats of former years into apparatus of mighty size, their limit being generally determined by the capacity of the mechanical industry. But here, too, the mistakes which often occur in manufacturing processes and the extra losses which they involve teach us that a wise moderation should be exercised.

Wherever possible, continuous operations have replaced those processes which worked intermittently. In this way loss of time and expense, caused by cooling and reheating, are avoided. This is exemplified by Uebel's new method of the production of nitric acid from Chili saltpeter with retorts lying above each other and without stirrer, and by that of the Badische Anilin and Soda Fabrik, where the chambers are back of each other with stirrer, these methods having replaced the old single retort process.

MATERIAL FOR CHEMICAL APPARATUS.

As regards the material for chemical apparatus several new wares must be referred to:

Quartz vessels.—Apart from the fact that the saltpeter industry of Norway taught us how to absorb dilute nitrous gases in towers 20 meters high, made of granite, a substance which was rarely used for chemical purposes, we have to-day at our disposal tubes, dishes, and vessels of fused quartz, which are stable against acids and heat and which are manufactured in the same sizes and dimensions as the well-known earthenware vessels.

Refined steel.—The greatest progress, however, has been made in the manufacture of iron alloys or refined steel.

Thanks to the kindness of Freidr. Krupp of Essen, I am in the fortunate position to describe a large number of hitherto unknown substances of great importance, of which I exhibit magnificent

specimens, photographs, and lantern slides. Just here, however, I must ask you to make one of the landings from the upper air and permit me to deal with the subject at greater length. You will be astonished at the immense progress which has been made to the general benefit of our industry.

Of the greatest interest are the alloys of iron with other heavy metals and metalloids, i. e., alloyed steel.

Instead of carbon, other elements are employed, which likewise enhance the hardness of steel, but prevent the formation of a crystal-line micro-structure liable to cracks and flaws. The most important of these elements is nickel.

Nickel steel.—The readiness with which nickel forms an alloy with iron has long been common knowledge. Even in Bessemer's days attempts were made in Great Britain to turn out cannon made of steel containing 2 per cent nickel. The experiments were not successful because the nickel obtained at that time contained impurities, such as copper, arsenic, and sulphur, so that the steel could not be forged. Thirty years later pure nickel, as we know it to-day, made successful results possible. The same was the case with chromium, silicon, and manganese, and not until these elements were produced pure could successful alloys be manufactured with them, either alone or together with nickel. The chief aim in the manufacture of these alloys is the formation of an amorphous, pliable structure of the steel. This result is attained not only by removing more or less of carbon, but above all by a certain thermic treatment, namely, by suddenly cooling steel heated to a high temperature, heating again and keeping it at a certain lower temperature. You will see two samples of steel; in the one case, the coarse crystallization of the pure carbon steel before it is forged, and in the other, the same steel refined by the thermic treatment. The difference in the micro-structure of the forged carbon steel and that of the forged and thermically treated nickel steel must also be noted. Whilst carbon steel after forging still shows a crystalline structure with visible cleavage planes of the crystals, the section of nickel steel displays an amorphous structure closely resembling that of welded iron. For comparison sake, a sample of a welded iron fracture is exhibited. It must not be overlooked, however, that nickel and chrome nickel steels are twice or three times as hard as welded iron. There are also exhibited test pieces of construction parts to be used in the automobile industry made of alloyed steel. Notwithstanding the high tensile strength of about 90 kilos per square millimeter (i. e., about 55 tons per square inch), no fracture is noticeable, although they are greatly bent.

Aside from these improvements, which are of such great moment for structural steel, the iron alloys have found many new applications.

I merely mention the different nickel alloys for shipbuilding, electric appliances, and for valves. These valuable alloys containing 23 per cent and more nickel, are nonmagnetic, and not affected by atmospheric influences; those containing 30 per cent nickel possess great resistance to electricity, whilst the coefficient of expansion of steel with 45 per cent nickel is only one-twentieth of that of ordinary steel and not greater than that of glass.

Chromium, tungsten, and molybdenum steel.—It is a very interesting and novel fact that by the thermic treatment alone the microstructure of the cheaper kinds of unalloyed iron plates and iron shapes is so changed that it becomes three times as resistant to the destructive effect of acids. If alloys of iron with chromium, tungsten, molybdenum, and aluminium in certain proportions are thermically treated, this resistance is increased fivefold, as is shown by samples of ordinary carbon steel and chrome nickel steel which underwent a treatment with dilute sulphuric acid for 56 days.

An alloy of ordinary iron with 5 per cent nickel is an excellent material for withstanding hot caustic soda. Most astonishing properties are displayed by steel alloys containing more than 10 per cent of chromium and a small addition (2 to 5 per cent) of molybdenum. Such alloys are manufactured in the form of malleable cast and forged iron pieces by Krupp according to the patents of Borchers and Monnartz in Aix-la-Chapelle and in the form of rolled tubes by the Mannesmann Röhrenwerken in Remscheid. These alloys are insoluble not only in dilute hydrochloric acid and sulphuric acid, but also in dilute nitric acid, even with the addition of alkali-chlorides, and if they contain about 60 per cent chrome, 35 per cent iron, and 2 to 3 per cent molybdenum they withstand even boiling aqua regia. You will see samples of this extraordinary steel, after treatment with acids, compared with ordinary steel and cast iron.

Tool steel.—It must be especially mentioned that the alloys of iron with chromium, tungsten, and molybdenum tempered by a special process invented by two Americans—Taylor and White—find most important uses as quick turning steel for all kinds of tools.

Vanadium steel.—The most recent improvements in the manufacture of steel for tools which must of necessity keep pace in hardness with structural steel have been made by the employment of vanadium. Unfortunately, this metal, the use of which is steadily increasing, is still very dear, and the problem which chemists have to solve is to produce it more cheaply. If the price could be reduced perceptibly, metallurgists prophesy a great future for this metal, which exercises a very favorable influence on the microstructure of steel.

Of great importance are those alloys of iron with chromium, tungsten, and vanadium, which possess a high degree of hardness

even at 400 to 500° C. They are needed by engineers for the construction of steam turbines, for the embossing and spraying of metal objects when heated to redness, a process which has lately found extensive application. Chemists use these kinds of steel whenever chemical reactions are carried out at high temperatures and pressure, e. g., for the synthesis of ammonia according to Haber's process.

The very latest alloy has now been patented and is being manufactured by Krupp for the construction of safety vaults and safes. This steel can neither be drilled nor exploded, nor can it be cut by the oxyhydrogen flame.

Two samples of steel are exhibited, one of ordinary steel in which great holes have been cut in five and one-half minutes by using an oxyhydrogen flame and in six minutes by an oxyacetylene burner, and a specimen of this new alloy which has remained intact after being treated with the same oxyhydrogen and oxyacetylene flames for one and one-half hours. Let us hope that on this hard and infusible material the scientific safe burglar will exercise his noble art in vain.

Manganese steel.—Of the alloys made with manganese the manganese steel or hard steel, first produced by Robert Hadfield, because of its great wear is chiefly used for cast-iron parts of disintegrators and rails of electric tramways. On account of its hardness this steel is not malleable, but it can be bent in the cold state, and is thus very safe against breaking. It is therefore of much interest to the chemical industry where, in almost all branches, grinding operations are carried out.

Silicon steel.—Finally I wish to refer to alloys of iron and silicon which contain $1\frac{1}{2}$ to $2\frac{1}{2}$ per cent silicon and a high percentage of carbon. This steel is excellently adapted for tools and springs which must stand high strain. Since steel alloys containing much silicon, although brittle and porous, have proved very stable against acids, they are now being used more and more where such a property is of importance.

Alloys with about 4 per cent silicon, but very poor in carbon, are of greater value than the above. Robert Hadfield first pointed out the importance of this alloy, whilst Krupp, working in connection with Capito and Klein, a firm of fine-plate rollers in the Rhineland, considerably improved it and introduced it for electric purposes. It is employed in large quantities in the form of sheets of 0.35 millimeter ($\frac{7}{10}$ inch) thickness for the construction of dynamos, alternate-current motors, and transformers. In Germany alone the consumption of this alloy already amounts to 8,000 tons a year. This material has a resistance to electricity four or five times greater than that of ordinary iron and loses only half as many watts, so that the inju-

rious Foucault currents are reduced to a minimum. The manufacture of transformers has therefore become much cheaper, for the proportion between iron and copper is much more economical. The production of this silicon iron alloy, with its very low percentage of carbon, and that of the chrome nickel steels, almost free from carbon, became possible only after silicon and chrome, entirely free from carbon, could be manufactured by electric smelting processes.

Electro-steel.—Since the electric smelting furnace has come into use in the steel industry the problem of removing sulphur, which engaged the attention of chemists for so many years, has been solved. It has been found that the electric furnace process produces a slag free from metal, and such a slag is the prime requisite for the complete desulphuring of the steel bath.

Electrolytic iron.—Superior to the silicon steel, poor in carbon, in its electric properties is the "Ideal" metal for electromagnets—the pure electrolytic iron—first produced by Franz Fischer, of Charlottenburg, and now manufactured by the firm Langbein-Pfanhauser & Co., Leipzig. Formerly it was impossible to produce it free from hydrogen, consequently it was hard and brittle and was not malleable. Only by electrolyzing at 100° to 120° C. and employing an iron salt solution mixed with hygroscopic salts, such as calcium chloride, the iron became free from hydrogen. Its hardness then sinks far below that of silver and gold and is not much greater than that of aluminium. It possesses the valuable property of becoming magnetic more quickly than ordinary iron, containing carbon or silicon, and also of again losing its magnetism more readily, thus considerably increasing the efficiency of electromotors, for which it is used. Amongst the exhibits you will find several objects made of this electrolytic iron; for example, a cathode made from an electrolytic iron plate during five days of uninterrupted operation; also plates made by rolling; further a motor which, if constructed of silicon iron, would furnish 0.5 horsepower, but being composed of electrolytic iron, though in use for several months without appreciable signs of wear, it now furnishes 1.3 horsepower, in other words, it is two and one-half times as efficient.¹

With all these new materials at our disposal, among which I must also mention copper, with 10 per cent silicon, and copper nickel, we shall surely be able to improve all sorts of chemical apparatus that suffer so much from wear and tear.

After this short invasion of the domain of metallurgy, we shall now turn our attention to the chemical industry proper, first dealing with the manufacture of inorganic substances, the heavy chemicals.

¹ See Zeitschrift für Electrochemie, No. 16, 1909.

SULPHURIC ACID.

The triumphal progress of the contact process for the manufacture of sulphuric acid in the United States scarcely has its parallel in Germany, where it originated. Platinum, in spite of the fact that its price has increased threefold, is still our principal contact agent. As it is possible to carry out other contact processes with various contact materials, we shall certainly find other agents than platinum available for sulphuric acid anhydride. It ought therefore to be a fruitful field for research to find cheap substitutes for platinum. The Americans in the 20 years that have elapsed since Knietsch first successfully carried out the contact process, have increased their output threefold for the same weight of platinum. Nevertheless, the old lead-chamber process still competes with the new method, and the steady improvement of this process and the purity of the resulting acid must be acknowledged. In fact, the lead-chamber process promises to make further progress in the future in view of the success of Falding's high chambers and Opls towers, in which large quantities of acid flow down.

The Gaillard tower is supreme for concentration and recovery of the acid and for the regeneration of the various waste acids.

AMMONIUM SULPHATE.

A new way of manufacturing sulphuric acid, together with ammonia, from the gases which are produced by the dry distillation of coal, is looming above the horizon. Burkheiser is seeking, with the aid of especially prepared wet iron compounds, to bind the sulphur, simultaneously absorbing cyan, and to convert the ammonium sulphite thus produced into ammonium sulphate by oxidation with atmospheric air.

In competition with Burkheiser, Walter Feld is endeavoring to recover sulphur directly as ammonium sulphate by a series of interesting reactions, in which thiosulphates play an important part. Such plants are in operation in Konigsberg and here in New York.

NITROGEN COMPOUNDS.

So much has been written concerning the progress made in the last five years in the utilization of atmospheric nitrogen that I need not enter into a description of Birkeland-Eyde's, Schönherr's or Pauling's process for the direct oxidation of nitrogen by means of the electrical discharge, nor of Frank-Caro's method of forming cyanamide from carbides [the world production of cyanamide is, according to Dr. N. Caro, 120,000 tons per year, of which 31,000 tons are manufactured in Germany (16,000 in Trostberg and 15,000 in Knapsack near

Cologne), 19,000 tons are made in Niagara Falls by the American Cyanamide Co., and during the next three years the total production is to be increased to 200,000 tons], nor is it necessary to describe the Serpek process for the production of ammonia from aluminium nitrides combined with the utilization of alumina which is simultaneously obtained. I will mention, however, that the problem of concentrating the dilute nitric acid, as obtained in the large absorption apparatus from nitrous gases, has been solved by Pauling's method, in which sulphuric acid is used in a battery of towers. It is also possible now to convert economically cyanamide into ammonia and this again into nitric acid.

SODA AND CHLORINE.

The 50-year-old Solvay process, which has conquered the whole world, still remains master of the situation. This is all the more remarkable since it is still imperfect as far as the yield is concerned, for a quarter of the salt used in the process is lost as such, and the whole amount of chlorine in the form of calcium chloride.

Although the materials employed in the Le Blanc process are completely utilized, this fact will not give it any chance of surviving, and it would seem to be now chiefly of historical interest.

Not less remarkable is the 25 years' career of the alkali-chloride electrolysis. The limited market for chlorine compounds and the great space taken up by the electrolyzing baths were great obstacles to the progress of this apparently so simple method. For the same reasons the most approved processes, such as the Griesheim cement cell, the quicksilver cathodes of Castner and his successors, the Aussig Bell and the wire-gauze diaphragm of Hargreaves, with its many varieties, of which the Townsend cell is the latest and best, did not develop as expected. The limited demand also quickly restricted the operation of the brilliant method of manufacturing chlorates by electrolysis.

TIN.

Tin is not only produced from natural ores but also in more than 20 detinning establishments from tin-plate and tin-can waste; 200,000 tons of tin-plate waste are subjected to this treatment and about 24,000,000 marks (\$6,000,000) worth of tin and iron are recovered. The electrolytic detinning process, on account of high wages, the great cost of current, and the considerable manufacturing loss, has been replaced—where there is a market for chloride of tin—by the patented process of Thomas Goldschmidt, of Essen. This process takes advantage of the properties of chlorine gas, in the dry state, to greedily take up tin without reacting on iron if certain temperatures are observed. Instead of the inferior quality of electrolytic tin mud,

which must be converted into marketable tin by costly smelting operations, the new process yields an anhydrous tin chloride, which is used in large quantities for weighting silk. The detinning with chlorine is not carried out with cuttings, as in the electrolytic process, but with waste pressed in hard packages, so that 20 times as much material can be treated in the apparatus at the same time. In the United States this process is operated by the Goldschmidt Detinning Co. of New York.

REDUCING AND OXIDIZING AGENTS.

One of the most brilliant successes in applied chemistry has been achieved by the persevering experiments of some chemists with a long-neglected substance, the constitution of which had never been properly understood. The old hydrosulphite of Schützenberger, rendered stable and easily transportable in powder form as an anhydrous sodium salt or as rongalite in combination with formaldehyde, has now become a most important article of commerce. It is chiefly used in vat dyeing and for reducing purposes in general, such as stripping dyed fabrics and as decrolin for bleaching sugar.

PEROXID OF HYDROGEN, PERSULPHATE, AND PERBORATES.

Peroxid of hydrogen and its derivatives at present find less favor in commerce, although their future appears to be very brilliant. Recently the Farbenfabriken vorm. Friedr. Bayer & Co. succeeded in rendering this important oxidizing agent, which easily decomposes and which can be marketed with difficulty only in watery solution, solid and stable by the addition of urea.

This powder is in the market under the name of Ortizon, but on account of its relatively high cost it is intended not so much for technical as for hygienic and pharmaceutical purposes.

The interesting manufacture of sodium peroxid from sodium and the many scientific investigations of the persalts, have not been followed by great commercial success. The persulphate and perborate, however, the latter under the name of "Persil," are being manufactured on a large scale. The reason of this failure seems to be the high cost of production.

RARE METALS.

The most interesting alloys discovered by Muthmann and Auer have found little application in the arts, and the use of cerium and thorium preparations is still confined to the incandescent gaslight industry. Only the "Auermetal," consisting of 35 per cent iron and 65 per cent cerium, is employed and this only to a limited extent for the manufacture of pocket cigar lighters.

In the metal filament lamp industry, tungsten, which shows the highest melting point of all metals, namely $3,100^{\circ}$, has replaced tantalum, which melts at about $2,300^{\circ}$. This became possible only after successful experiments to render the metal ductile by hammering.

The elements cadmium, selenium, and tellurium are obtained in great quantities as by-products; the first is produced in the zinc industry, the other two from the Tellur gold ores which are found in Cripple Creek, Colo. Although they are sold at relatively low prices they find but little use in the industries.

ARTIFICIAL PRECIOUS STONES.

Finally, I will, in but a few words, touch upon a new industry, viz, the synthetic manufacture of precious stones from alumina with additions of chrome oxide, iron oxide, or titanac acid. Artificial rubies and white, yellow, and blue sapphires, which can not be distinguished from natural stones, are being manufactured in great quantities in Paris and recently also by the Electrochemische Werke, Bitterfeld. They are used extensively for jewelry and especially as bearings in watches and measuring instruments.

All this will give you a striking picture of the development of inorganic chemistry, which is taking a more and more important position beside organic chemistry.

APPLIED ORGANIC CHEMISTRY.

In the organic chemical industry the reactions are considerably more complicated and the apparatus mostly smaller than in the inorganic industry. Here the chemist, like a juggler with his balls, gives every atom a definite position in the many thousand combinations which carbon forms with hydrogen, oxygen, nitrogen, and sulphur, and there exist the most varied reactions and processes which may lead to the same result. This chemistry of the carbon compounds has been most wonderfully perfected in the coal-tar color industry, and in every factory of this branch there are hundreds of scientifically trained chemists always experimenting and daily finding new combinations possessing properties of technical value. Before these products become finished articles to be sold as colors, perfumes, or pharmaceutical preparations they must further go through a series of numerous intermediary operations, which finally lead to the marketable chemicals.

COAL TAR.

The starting material of the important coal-tar color industry is the black tar which is obtained by the dry distillation of coal and is known to contain about 150 different chemical products, of which,

aside from carbolic acid, the aromatic hydrocarbons, benzole and its homologues, toluol and xylol, naphthalene and anthracene, play the greatest part.

More recently carbazol has been isolated from tar on a large scale and has become a most important raw material for the manufacture of the color "hydronblue" by Leopold Cassella & Co., Frankfort on the Main. Hydronblue is a sulphur dyestuff distinguished by its fastness against washing and chlorine. Acenaphthen, which also occurs in coal tar as such, is the starting material of a red vat dye "cibanon-red," discovered by the Society of Chemical Industry in Basle. It is to be regretted that hitherto no technical use has been found for phenanthrene, which is also one of the constituents of tar.

Besides carbolic acid, its homologues, the various cresols, etc., are being isolated by Dr. F. Raschig in Ludwigshafen on the Rhine. These substances are largely employed in the manufacture of explosives and coloring matters.

As long as coal gas is produced for illuminating and heating purposes and as long as coke must be used for the reduction of iron ores, tar will always remain the cheapest raw material for the manufacture of these hydrocarbons. But since it may become necessary in the future—as is already possible to-day—to use coal in a more rational way, at the same time producing hydrocarbons, the coal-tar color industry need not fear a scarcity of this important raw material, the less so as certain kinds of petroleum, e. g., Borneo petroleum, contain large quantities of aromatic hydrocarbons from which the Rheinische Benzinwerke, in Reisholz near Dusseldorf, has already isolated toluene in the form of nitro-toluene in a commercial way. If, however, a still greater demand for these hydrocarbons should occur, other methods of obtaining them must be found. We shall then surely succeed in producing them synthetically either directly from the elements carbon and hydrogen or indirectly from carbide of calcium by passing acetylene through glowing tubes—a reaction which was already carried out successfully in the early sixties of the last century by Berthelot and recently by Richard Meyer. At the present time about one-quarter of Germany's annual output of coal is converted into coke, viz, 20 per cent for foundry purposes and 4 per cent in gas works, whilst in England the quantities are 12 per cent and 6 per cent, respectively.

DISTILLATION OF TAR.

The point of greatest importance in the distillation of tar is still the separation and isolation, in the cheapest possible way, of the different hydrocarbons in their purest form. The stills have been continually enlarged, those employed to-day having a capacity of 60,000 to 80,000 liters (13,000 to 17,500 gallons). On the other hand, a con-

tinuous process, such as is possible in the bituminous coal-tar industry, has not yet been found. A large number of patents have been taken out for apparatus intended to solve this problem, but none of them have proved satisfactory in practice.

ORGANIC INTERMEDIATE PRODUCTS.

The conversion of the aromatic hydrocarbons into intermediate products necessary for the color industry is almost always carried out by treatment with concentrated sulphuric and nitric acid and subsequent reduction of the thus obtained nitrocompound by means of metals, metalous oxids, and metal sulphides. In the production of amines, iron is the principal agent of reduction, while zinc and tin are mostly used in the production of azo compounds. The electrolytic reduction has not proved useful for these processes.

The methods of producing nitro and amido compounds have been very little changed as far as chemical operations are concerned, but with the increase of their production their poisonous properties became more and more apparent and forced the manufacturer to modify the processes so that they could be carried out in tightly closed vessels in order to protect the life and health of the workmen.

In Germany legislation has been recently enacted, based on the experience of the individual factories, which lays down rules and regulations for strict observance.

Several trinitro compounds have been shown to be good explosives, and, like trinitrotoluene, are now largely employed as substitutes of picric acid in the manufacture of explosives.

The introduction of oxy groups into the molecule is mostly brought about by melting sulpho acids with alkalis, and, according to more recent methods, with alkaline-earth metals, such as calcium and barium hydrate. Since chlorine, produced electrolytically, is obtainable in unlimited quantities and chemically pure, chlorine substitution derivatives of the hydrocarbons have been employed for all kinds of synthetical purposes. Many of these chlorine derivatives can not only be converted into oxy-derivatives by melting with alkalis, but, like paranitro-chlorbenzole, they also directly exchange their chlorine for an amido group when treated with ammonia or its derivatives. Colors also often change their shade when a halogen atom is introduced into their molecule and acquire more valuable properties. Chlorine has therefore proved exceedingly useful in the preparation of intermediate products and will undoubtedly become of still greater service in the future.

In the naphthalene series the method discovered by Bucherer and Lepetit for the conversion of the hydroxyl group into the amido group and vice versa, employing sulphurous acid esters, has proved of great practical value. Phosgene, too, is to-day

being more and more employed. Several decades ago it became an important substance for the production of the urea of para-*amidobenzolazo-salicylic acid*, introduced into the market under the name of "cotton yellow," as a beautiful yellow cotton color of great fastness to light. Its principal use, however, was for the manufacture of the bright but fugitive triphenylmethane colors. It is now especially used to combine two molecules of aromatic compounds with free amido groups, thus producing urea derivatives, and if the starting material is an azo color, the resulting urea derivative is, as a rule, much faster to light than the original color. Imidazol, thiazol, and azimido compounds of the most varied kinds are also manufactured and converted into azo colors.

In the series of the aldehydes and carboxylic acids there are no epoch-making discoveries to be recorded. Chemists still start from hydrocarbons chlorinated in the side chain or directly oxidize the homologues of benzole. Klobe's synthesis of salicylic acid, of which large quantities are used in the color industry, is also applied at an ever-increasing rate for the production of the oxycarboxylic acids. But the direct introduction of the carboxylic group into the benzole molecule, unsubstituted by hydroxyl, is a greatly desired achievement, which, however, has not yet been attained. It is also a matter of greatest importance that in substitution reactions of the aromatic nucleus we should be able to vary at will the ratio of the isomers to be formed.

Besides the biochemical production of ethylic alcohol from wood waste and from the waste liquors of the sulphite cellulose industry, I wish to mention the synthesis of organic compounds by the addition of water to acetylene. In this manner we produce in a simple way acetaldehyde, which can be easily converted into acetic acid, a very important starting material for the manufacture of numerous products.

The steady search for new raw materials and new intermediate products to be utilized in the manufacture of colors has often been crowned with success. We need only to recall the many intermediate products which have been made available for the production of the vat dyes and sulphur colors and which have led to the discovery of new substances with most valuable properties. Very often new lines of research are not always based upon preconceived theoretical ideas, but are opened up by mere accident. A keen power of observation, however, is the most necessary equipment of the chemist who aims at success.

COAL-TAR COLORS.

In no branch of technical chemistry has such intense work been performed as in that of the coal-tar color industry. The outsider long

ago may have thought that so much had been accomplished in this field that nothing more was left to be done. The countless dyestuffs, giving all the colors of the rainbow, might well have given rise to the belief that there was already a surplus. But here the course of events was just as it generally is in life. With growing possessions, man's needs and demands also multiply. While people were formerly content to produce with coal-tar colors every possible shade in undreamt-of brightness in the simplest way, they gradually began to make more and more exacting demands as regards fastness. Not only must materials to be dyed be a pleasing shade, but they also must be fast to washing and light. Thus new, alluring problems were submitted to the color chemist, and his indefatigable efforts have already carried him a long way toward the desired end. Strange to say, amongst the public you will frequently meet the view that artificial colors do not give fast dyeings. This is a decided error which can not be too emphatically contradicted. To-day we can produce almost any shade with any desired degree of fastness on any kind of material, whether it be wool, cotton, silk, or paper. If the dyer does not always produce such shades it is the fault of the trade which does not express its demands forcibly enough. Of course, the dyeing with fast colors entails a somewhat greater expense which must naturally be borne by the consumer.

Just at this point, before discussing the progress made in the manufacture of fast colors and in order to prevent misunderstanding, I should like to emphasize the fact that the old colors, though not as fast as those more recently discovered and though perhaps quite fugitive in some respects, still have a right to exist. It would be quite foolish to dye certain kinds of paper intended to be in use for only a very short time with colors absolutely fast to light, or to dye cloth never to be washed with expensive colors fast to washing, or, again, to treat lining, which is but slightly exposed to sunlight, in the same way as materials which must be exceedingly fast to light. Everything according to reason. For many purposes, however, the need for shades fast to light or to both light and washing is so great that it must be given every consideration. How mortifying it must be to notice shortly after you have decorated the walls of your home with most beautiful and expensive materials, that the lovely colors daily grow more unsightly, and to see a solitary patch showing up in all its pristine glory amidst a faded background when a picture or other piece of furniture is moved to another place. As it is possible to guard ourselves against such occurrences, we should certainly do so. To-day we are able to produce the most beautiful colored wall coverings, whether of paper or of woven or printed fabrics, to meet every requirement in regard to fastness. This is proved by the large collection of all kinds of woolen and

cotton fabrics (after washing and exposure to light) and especially of wall papers, of carpets, rubber material, and balloon coverings, which the different firms of the German color and dyeing industry have placed at my disposal for exhibition.

If you now inquire how chemists have been able to make such great progress, my only answer is by logical and untiring efforts along well-known ways, undaunted by failures, and by diligently following any track, however faint, that gave promise of advance.

In every branch of the color industry these methods have led to faster and ever faster dyestuffs, from the multicolored benzidine colors, described as fugitive to light and not stable to washing, to the anthraquinone colors and the indigoid vat dyes. In all these classes we have gradually learned to recognize certain regularities and to accomplish certain results by systematically grouping the components and fixing the position of the substituting groups, and thus we have succeeded in increasing the fastness to light of the individual chemical according to a preconceived plan.

INDIGOID COLORS.

The synthetic production of colors allied to indigo was stimulated by the successful synthesis of indigo which almost entirely displaced natural indigo and called the attention of both chemists and consumer in an increased measure to the advantages of vat dyeing. The king of dyestuffs, indigo, now finds itself in the company of a whole series of other colors, the brome indigos, the thio indigos, and alizarine indigos, the shades ranging from blue to red, violet, gray, and black. Even the "purple" of the ancients has been reproduced by Paul Friedlaender, who, by isolating the dyeing principle found in certain glands of the purple snail living in the Mediterranean, has demonstrated the fact that this natural color is identical with a dibrom indigo which had been long before produced synthetically. These indigoid colors possess the same, if not better, properties as indigo itself.

ALIZARINE COLORS.

The fastness of the alizarine colors, e. g., alizarine red, used for Turkey red, was well known in ancient times. But, whereas formerly only mordant colors were considered to be fast, and consequently only these were looked for in the anthraquinone group, which led to the discovery of alizarine orange, brown, and blue, and the alizarine cyanines, Robert E. Schmidt, in 1894 to 1897, succeeded in finding acid-dyeing anthraquinone colors which dye every shade, rivaling the old and well-known triphenylmethanes in brightness and simplicity of application and the alizarine mordant colors in their extraordinary fastness to light. I merely mention alizarine cyanine

green, alizarine sky-blue, anthraquinone blue, and alizarine sapphirole, astrol, irisol, and rubinol. Their fastness to light is so excellent that in the famous "Manufacture Nationale du gobelins" in Paris, they have replaced the older dyestuffs for the dyeing of wool used in the manufacture of gobelins. This means a great deal if it be borne in mind that a square meter of these gobelins, for the production of which an operator needs more than a year, costs, on the average, about 6,000 francs.

INDANTHRENE AND ALGOLE COLORS.

An entirely new era began for the alizarine series when René Bohn in 1901 found that his new color, indanthrene, could be used as a vat dye for cotton. This color can be dyed in its reduced state like indigo, but is far superior to the latter in beauty and brightness of shade, as well as in fastness to washing and light. Indeed, the fastness to light is so great in this respect it must be termed indestructible.

On account of this phenomenal fastness, indanthrene blue caused chemists to look for other vat colors in the anthraquinone series. Their efforts did not remain unrewarded, and we already possess colors of this class giving every possible shade. The Badische Anilin and Soda Fabrik sell them under the name of "indanthrene colors," the Farbenfabriken vorm. Friedr. Bayer & Co. under the name "alcole colors." Chemically most of these vat colors belong to the indanthrene type; some of them are still more complicated nuclear products of condensation of several anthraquinone molecules; others, again, are di- and tri- anthraquinonylamines. It must also be noted that to the greatest surprise of all experts in this branch, it was discovered in the laboratory of the Farbenfabriken vorm. Friedr. Bayer & Co., that even some of the simplest acyl derivatives (-benzoyl) of the aminoanthraquinones are excellent vat colors.

LAKE COLORS.

We must not leave out of sight the importance of some colors of the aniline group and especially the anthraquinone group for the production of lakes for paints and pigment colors for wall paper. The alumina lake of alizarine, the so-called madder lake, with its fine shade and great fastness to light, is best known. Other alizarine colors also yield valuable alumina lakes; thus, alizarine sapphirole gives a blue lake of excellent fastness to light. But it is not always necessary to precipitate lakes. Some of the difficultly soluble vat colors may be directly employed in a finely divided form. Thus indanthrene and alcole blue already play important rôles as substitutes for ultramarine for bluing higher class paper, textiles, and even sugar.

The development of the anthracene colors, aside from the tinctorial progress, brought about remarkable results in pure chemical research, for example, the peculiar action of boric acid and the catalytic action of quicksilver in the sulphonation processes of anthraquinone.

But in this branch of our science as well there is still much room for development. Many problems remain unsolved and new ones are continually arising. To satisfy the demand of the dyer many dye-stuffs must still be synthesized.

The ceaseless efforts of the color chemist will undoubtedly bring us farther and farther along this road, and complaints about the insufficient fastness of dyed materials will be silenced at last. If this goal is to be reached, it is absolutely necessary for the consumer to support the manufacturer, and I take this opportunity to state that in the United States of America these fast colors are to-day more generally used and found recognition and widespread application here earlier than in any other country.

PHARMACEUTICAL CHEMISTRY.

I will now deal with the progress and problems of the pharmaceutical industry in the synthetic production of medicinal drugs. This industry is the youngest daughter of the coal-tar industry, and it is not long since she celebrated her twenty-fifth anniversary. Those who, like myself, had the good fortune to stand at her cradle when Ludwig Knorr discovered antipyrin and to guide her first tottering steps at the time phenacetin and sulphonal were brought out must look back with a joyful heart to this period of splendid growth. Much brilliant work has been accomplished, but a vast amount still remains to be done. Here we see chemistry and medicine intimately bound together, the one dependent upon the other and powerless without its aid. What an organization, what boundless intelligence is necessary, and what immense energy has to be expended in order to discover a new synthetic remedy and to smooth its path through the obstacles of commerce! First, we need a fully equipped chemical laboratory, then a pharmacological institute with a staff of men trained in medicine and chemistry, an abundance of animals to experiment upon, and, finally—the latest development in this field—a chemo-therapeutic and bacteriological department equipped according to the ideas of Prof. Ehrlich, these in close connection with one another. Whatever has been evolved and, after much painstaking effort, selected as useful finds its way into the manufacturing department, there to be elaborated in the most minute details and brought to the highest possible pitch of perfection. Now begins the arduous work of the scientific department. Here the right sponsors must be found; here all prejudices must be brushed aside and an extensive

propaganda initiated. Next, a host of clinicians and practitioners must be called into requisition, so that what has been evolved in the silent workshop will be conducted on a stanch ship into the wide sea of publicity. And, finally, it is the calculating salesman's turn; he must bring in enough to cover all the expenses of the innumerable experiments that have been made if the new drug, which has swallowed so much money, is to survive and prosper. Truly, all this is a task which only too often is misunderstood and insufficiently appreciated. If, however, a great hit is made—an event almost as rare as the Greek calends—then the envious, the patent and trade-mark violator, and even the smuggler, cling to our heels and seek to rob us of our profits, which, taking everything into consideration, are really not large. But despite all this, and though unfortunately opposed by druggists and physicians even to-day, the pharmaceutical industry serenely pursues its task. For, besides certain economic aims, we also have ideals to strive for. We combat systematically the symptoms of disease and are the faithful auxiliaries both of the doctor and the harassed nurse. The agonizing pains of the patient we allay with narcotics and anesthetics. When sleep flees the couch of suffering, we compel it to return; fever, we banish. We destroy the minute organisms which cause and spread diseases. Thus we add to the store of what is valuable and perfect what already exists. We also isolate the active principles of various drugs and thus assure exact dosage and freedom from undesirable or even dangerous by-effects.

In the chemical works of Germany pure chemical science receives its due. In every branch of inorganic, organic, and physiological-biological chemistry we are working with an army of scientifically trained men. In synthetic chemistry, brilliant achievements have fallen to our share. Quite recently Stolz succeeded in building up adrenalin,¹ Decker in making hydrastinin, and Emil Fischer and Wilhelm Traube in producing purin bases. All of these are magnificent accomplishments, and many of them have been effected in the laboratories of the industry.

That even yet, as at the beginning—the antifebrin period—we must trust to chance is shown by the discovery of atophan, the latest valuable antiarthritic, which is due to a fortunate accidental observation. In the subject of the old ergot problem, research work is gradually bringing more light and makes the possibility of synthetically producing a substitute a thing of the near future. The publications on this subject show that hemostatic alkaloids possess a comparatively simple constitution. That sedatives have their place in

¹ 1 kilogram adrenalin, which is now prepared synthetically, and has been introduced under the name of "suprerin" by the Farbwerke of Hoechst, requires for its production the adrenal glands of 40,000 oxen. This product, as well as numerous other glandular preparations, is nowadays manufactured by the large American slaughterhouses themselves.

an age when nervous disorders are so common is not to be wondered at. I need merely remind you of the new adalin which has proved exceedingly useful. Recently Emil Fischer, the master of chemical research to whom the pharmaceutical industry is indebted for the synthetic purin bases, viz, caffen, theobromine, and theocin, as well as the valued remedies, veronal and sajodin, has succeeded, after long and fruitless labors, in elucidating the constitution of tannin and producing it synthetically. He has thus proved that it might be possible to manufacture tanning agents of all kinds artificially and has opened up a new and promising field for research.

CHEMOTHERAPY.

But a short while ago Ehrlich drew attention to another promising branch of pharmaceutical-medical chemistry, viz, the treatment of infectious diseases by chemical means. After many years' arduous labor and after many thousand experiments on different animals this master of medicine and chemistry succeeded in demonstrating that it is possible to produce chemical substances which will kill the parasites in the human body without injuring their host and that this action is a function of the chemical constitution. The new science, with its magical bullets directed only against the injurious organisms in the body, but not affecting its cells, pursued its course from aminophenylarsinic acid (atoxyl) to diaminoxyarsenobenzole (salvarsan). Thus a new synthetic preparation, an arsenic compound, is added to the old and highly effective remedies, mercury, quinine, and salicylic acid. It is certain that we are here only at the beginning of a new development. We know already that we are able to combat not only spirochetes but also bacterial diseases like tuberculosis. Even carcinoma and sarcoma, those growths so destructive to humanity, whose cause is, however, not yet understood, can probably be influenced in a like manner by means of selenium compounds, as first pointed out by Emil Fischer. But were we to learn to cure diseases due to trypanosomes and plasmodia, what a great work we should have accomplished in the interest of humanity and social economy, for it is in the most fruitful lands indeed that these diseases, malaria and sleeping sickness, are to be found, and man and beast are ruthlessly destroyed by them. Neither salvarsan nor atoxyl are of service here, and therefore other hitherto unknown remedies must be found.

While the treatment of syphilis, with its terrible consequences, is still imperfect in spite of mercury and salvarsan, let us hope that the systematic experiments carried out in the laboratory with the innumerable products which chemistry is able to produce from mercury and from arsenic will finally lead to complete success.

SYNTHETIC PERFUMES.

In the perfume industry the developments made since the scent of the violet was imitated with jonon, and since the successful synthesis of camphor from turpentine, are not of such nature that we need to deal with them at great length. The importance of this industry appears from its yearly turnover of 45 to 50 million marks (10 to 12 million dollars). Here the efforts of the chemists are directed toward determining the constitution of the complex and simple natural perfumes, isolating the various products of decomposition obtained during the investigation, and finally reproducing the natural perfumes synthetically. Such results have already been achieved in the case of the odor of the rose, lily of the valley, and violet. Very often certain substances are needed in the compounding of perfumes which like indole possess anything but a pleasant smell.

ARTIFICIAL SILK.

Even if doubt be expressed as to whether artificial silk (the yearly consumption of which amounts to about 7,000,000 kilograms) still belongs to the chemical industry because it stands in such close relation to the textile industry, with its weaving and spinning machines, yet the raw materials needed for its production, such as nitrocellulose, copper ammonia cellulose, and cellulose-xantogenate, are of such importance that the chemist and engineer equally divide the responsibility in this branch of manufacture. Viscose silk from xantogenate of cellulose, the production of which has been recently very much improved, seems to replace nitrocellulose silk and the copper ammonia silk. This viscose silk surpasses all other artificial silks in luster and is the cheapest to manufacture, so that the apparently simplest process of all, the copper ammonia cellulose silk, can not compete with it any more. Among the exhibits are fine specimens of this silk from the Vereinigten Glanzstoffabriken of Elberfeld and their factory in Oberbruch in Dremmen near Aix-la-Chapelle, including the various raw materials, wood, cellulose, alkali cellulose, and the cellulose xantogenates produced by treatment with bisulphide of carbon and the viscose solution itself.

ACETYLCELLULOSE—CELLIT FILMS.

From acetylcellulose soluble in acetone, called cellit, the Farbenfabriken vorm. Friedr. Bayer & Co. first produced cinematograph films, but although they have the great advantage over those manufactured from nitrocellulose in being noninflammable, it has not been possible to introduce them generally. In all their properties the cellit films are equal to the old inflammable ones, yet the proprietors of moving-picture theaters do not take them up because they fear the compe-

tition of the schools and the home where the cellit films would be largely used on account of their noninflammability. The only help then would be such action by those in authority as to make it difficult to employ inflammable films and to facilitate the use of cellit films. There are prospects of such legislation at least in Germany, which would put an end to cinematograph fires with their great danger to life and property.

NONINFLAMMABLE CELLULOID (CELLON).

The problem of manufacturing noninflammable celluloid by mixing cellit with suitable camphor substitutes which burn difficultly or not at all may be considered as definitely solved. Eichengrün has simplified the manufacture to an extraordinary extent by showing that certain acetylcelluloses may be gelatinized in the same way as nitrocellulose. As is well known, nitrocellulose with camphor in the presence of a solvent yields a so-called solid solution, and even in the dried state may be easily cut or formed into sticks, tubes, or threads. Cellit when treated in exactly the same way with appropriate camphor substitutes, can be converted into "cellon," the noninflammable substitute for celluloid. Single blocks weighing 200 pounds are already produced on a large scale which like celluloid can be sawed, cut, and polished; when heated can be pressed or bent; and when subjected to steam at a high temperature can be drawn and molded. Compared with celluloid, cellon has the advantage of being more elastic, soft, and ductile. It is therefore frequently used as a substitute for hard rubber, gutta percha, leather, etc. Cellon, in the form of a highly viscous, sirup-like solution, may be employed for coating fabrics, wood, paper, metal, etc., with a thick, enamel-like uniform and pliable surface. Thus, patent leather, artificial leather, insulators, balloon covers, etc., may be produced. In France this varnish is already employed for enameling aeroplanes. Objects made of this novel and widely useful material are to be found among the exhibits being manufactured by the Rheinisch-Westfälische Sprengstoff Actien Gesellschaft in Cologne and the Société Industrielle de Celluloid in Paris.

RUBBER.

Finally, I will refer to one of the greatest successes and yet one of the most difficult problems of the chemical industry, viz, the production of synthetic rubber. I am proud of the fact that its production was successfully accomplished in the works which are under my management, and that I was able to follow every stage of this important discovery. Perhaps you would be interested to hear, although it is getting late, how the whole thing happened, especially

as much that is untrue and misleading has appeared in the press during the last few weeks.

But first, a few words about natural rubber. The Old World owes its knowledge of this substance to the New. This wonderful product became known in Europe shortly after Columbus discovered America. If I, coming from across the ocean, now bring you this colloid prepared there synthetically, I merely repay part of the debt which we owe America.

Hardly a generation ago, the southern part of this great American continent furnished the whole supply of the different kinds of rubber. Since then extensive plantations of rubber trees have been established in various tropical countries, and their yield has grown so enormously that the old home of wild rubber will soon be thrust into the background. This is a matter which involves many millions; consequently a very serious economical problem confronts South America.

You all know that caoutchouc is made from the milky sap of numerous species of trees and shrubs and the grotesquely formed lianas by various coagulation processes, and that this product, on being suitably treated with sulphur or sulphur compounds, i. e., by vulcanization, acquires its valuable and characteristic properties. The synthetic method took quite a different route. By breaking up the very complex molecule which rubber doubtless possesses, by pyrogenetic processes, i. e., by dry distillation, a veritable maze of all kinds of gases, oils, and resins was obtained, as well as a colorless fluid resembling benzine, to which the investigators gave the name "isoprene." It was Bouchardat who first expressed the belief that this isoprene, which is obtained in very small quantities and in an impure form by the dry distillation of caoutchouc, might be closely and intimately related to caoutchouc itself. This important question was then eagerly discussed for several decades by the scientists of all countries, and opinions were sharply divided.

As far back as the eighties, Tilden claimed to have prepared artificial rubber from isoprene by treatment with hydrochloric acid and nitrous acid. But neither Tilden nor his assistants, though they worked strenuously for years, succeeded in repeating the experiments. Moreover, numerous other investigators, among them our chemists, were unable to confirm the results. In 1894 Tilden found, however, that that isoprene which he had prepared about 10 years before, on standing, had partially polymerized into rubber. In this way Tilden, in fact, was the first discoverer of synthetic rubber. But this method which time has not yet permitted to repeat is obviously not a commercial one. Dr. Fritz Hofmann of the Farbenfabriken vorm. Friedr. Bayer & Co. is to be regarded as the real inventor of synthetic rubber, for, by the application of heat, he succeeded, as the first, in August, 1909, in polymerizing the isoprene molecules com-

pletely into the complex rubber molecule on a technical scale. Somewhat later Harries invented independently another method of arriving at the same result. Everyone is now in a position to repeat this exceedingly simple experiment himself, but in order to confirm Hofmann's results, it is necessary to employ pure isoprene.

The practical value of this rubber, of which many samples are among the exhibits, has been tested by the highest authorities in this branch of the industry, whilst Prof. Karl Harries, whose unremitting labors extending over many years, prepared the soil for Hofmann's synthesis, has carefully examined the chemical constitution of the substance.

Isoprene belongs to the butadienes. It was therefore to be assumed at the start that betamethylbutadiene would not hold a peculiar and isolated position amongst the butadienes in general. It was argued that other members of this interesting group of hydrocarbons would yield analogous and homologous rubbers on being heated. In the synthesis of products occurring in nature, there is always a possibility of producing such variations, and our endeavors to find out whether this was true in the case of rubber were crowned with success, for to-day several representatives of the new class of caoutchoucs possessing different properties are known and are being submitted to technical tests. Exact proof of the existence of the class of isomeric and homologous caoutchoucs was also first presented by Elberfeld:

To you who hear this account and see these beautiful specimens, the matter appears very simple, intelligible, and clear. In reality, however, it was not so. The difficulties which have been overcome were great indeed and those which still remain to be surmounted, in order to produce a substance equal to para caoutchouc in quality and capable of competing with cheap plantation rubber costing only 2 marks per kilo, are still greater. But such difficulties do not intimidate the chemist and manufacturer; on the contrary, they spur them on to further efforts. The stone is rolling, and we will see to it that it reaches its destination. The end in view is this, that artificial rubber may soon play as important a rôle in the markets of the world as does natural rubber. The consumption of rubber is simply enormous. Finished articles to the value of 3 milliard marks (\$750,000,000) are manufactured every year, and the raw material from which they are made, calculated at the present market price of 12 marks (\$3) per kilo, costs 1 milliard marks (\$250,000,000). Other tasks which the chemist has on hand shrink into insignificance compared with this gigantic problem. The laurel wreath will not adorn the brow of the wild dreamer but that of the scientist who, cool and persevering, pursues his way. The seed he sows ripens

slowly, and though according to the statements in the press, all this is mere child's play and the problem has been solved, I leave it to your judgment whether this is true or not, like much that printer's ink patiently transfers to paper. I am right in the midst of this excitement. I have employed articles made of synthetic rubber, and for some time I have used automobile tires made of this material. Yet, if you ask me to answer you honestly and truly when synthetic rubber will bring the millions which prophets see in its exploitation, I must reply that I do not know. Surely not in the immediate future, although synthetic rubber will certainly appear on the market in a very short time. But I hope to live long enough to see art triumph also here over nature.

We are now at the end of our journey. We have flown not only over the field of Germany, but also over all other countries where the chemical industry is cultivated. We have taken a passing glance at the untiring striving for advance, the restless search for the hidden and unknown, the ceaseless efforts to acquire more technical knowledge as witnessed in the great laboratories and factories of our mighty and ever-growing industry. We will now guide our arship into the haven whence we set out and land where our coworkers have gathered from all the countries of the earth to recount whatever progress each has achieved, and to discuss, in public and private, the problems which have been solved and those which still await solution.

This is the purpose and aim of the congresses of applied chemistry, and in this way they promote directly and indirectly the interests of our industry. But they also serve another purpose—to spread far and wide knowledge of our great deeds. It is thus that they impress the importance of our science and the arts founded on it upon the public in general and especially upon those who have influence in social or official positions, so that our profession may advance equally with others, and so that the importance of the chemical industry and of those connected with it from an economic, hygienic, and social standpoint may become better and better known.

That the effulgent light of this knowledge will also be diffused by the Eighth International Congress of Applied Chemistry is assured by the magnificent organization which our friends, the American chemists, have provided, the skillful manner in which the affair has been conducted, the hospitable reception which has been extended to us, not only by our colleagues but by the people at large, and which is still awaiting us in our tours of inspection of the flourishing industry of America, in so many respects a model for others. For chemical science and the chemical industry the following words of Schiller are beautifully descriptive:

“Only the serious mind, undaunted by obstacles, can hear the murmuring of the hidden spring of truth.”

Holes in the Air.

By W. J. HUMPHREYS, Ph. D.,

Professor of Meteorological Physics, United States Weather Bureau, Washington, D. C.

[With 3 plates.]

The bucking and balking, the rearing, plunging, and other evidences of the mulish nature of the modern Pegasus soon inspired aerial jockeys to invent picturesque terms descriptive of their steeds and of the conditions under which their laurels were won or lost. One of the best of these expressions, one that is very generally used and seems to be a permanent acquisition, is "holes in the air." There are, of course, no holes in the ordinary sense of the term in the atmosphere—no vacuous regions—but the phrase "holes in the air" is brief and elegantly expressive of the fact that occasionally at various places in the atmosphere there are conditions which, so far as flying is concerned, are mighty like unto holes. Such conditions are indeed real, and it is the purpose of this paper to point out what some of them are, when and where they are most likely to occur, and how best to avoid them.

Suppose for a moment that there was a big hole in the atmosphere, a place devoid of air and of all pressure. The surrounding air would rush in to fill this space with the velocity pertaining to free particles of the atmosphere at the prevailing temperature; that is to say, at the velocity of sound in air at the same temperature, and therefore at ordinary temperatures of about 1,100 feet per second, or 750 miles per hour. Even, therefore, if such a hole existed, it would be impossible for an aeronaut to get into it—he could not catch up with it.

But, according to the claims of some, if there are no complete holes in the atmosphere there are, at any rate, places where the density is much less than that of the surrounding air; so much less indeed that when an aeroplane runs into one of them it drops quite as though it was in a place devoid of all air and without support of any kind.

This, too, like the actual hole, is a pure fiction that has no support in barometric records. Indeed, such a condition, as every scientific man knows, could be established and maintained only by a gyration

or whirl of the atmosphere, such that the "centrifugal force" would be sufficient to equal the difference in pressure, at the same level, between the regions of high and low density.

Appropriate equations can be written to express the balance between pressure gradient and deflective force in any sort of winds, and at any part of the world (it depends slightly upon latitude). Therefore it is possible with certain conditions given to compute the wind velocity, or with other conditions given to compute the pressure gradient. But in the present case numerical calculations are not necessary. We know that an ascent of half a mile, easily made by an aeroplane, produces roughly a 10 per cent decrease in pressure, and we know too that a greater pressure difference than this seldom exists even between center and circumference of violent tornadoes. Hence a drop in density, or pressure, to which the density is directly proportional, sufficient to cause an aeroplane to fall, would require a tronadic whirl of the most destructive violence. Now there were no whirlwinds of importance in the air, certainly none that could be called tornadoes, at the times and places where aeronauts have reported holes, and therefore even half holes, in the sense of places sufficiently vacuous to cause a fall, must also be discarded as unreal, if not impossible.

Along with these two impossibles, the hole and the half hole, the vacuum and the half vacuum, should be consigned to oblivion that other picturesque fiction, the "pocket of noxious gas." Probably no other gases, certainly very few, have at ordinary temperatures and pressures, the same density as atmospheric air. Therefore a pocket of foreign gas in the atmosphere would almost certainly either bob up like a balloon, or sink like a stone in water; it could not float in mid air. It is possible, of course, as will be discussed a little later, to run into columns of rising air that may contain objectionable gases and odors, but these columns are quite different from anything likely to be suggested by the expression "pockets of gas."

The above are some of the things that, fortunately alike for those who walk the earth and those who fly the air, do not exist. We will now consider some of the things that do exist and produce effects such as actual holes and half holes would produce—sudden drops and occasional disastrous falls.

AERIAL FOUNTAINS.

A mass of air rises or falls according as its density is less or greater, respectively, than that of the surrounding atmosphere, just as and for the same reason that a cork bobs up in water and a stone goes down. Hence warm and therefore expanded and light air is buoyed up whenever the surrounding air at the same level is colder; and as

the atmosphere is heated mainly through contact with the surface of the earth, which in turn has been heated by sunshine, it follows that these convection currents, or vertical uprushes of the atmosphere, are most numerous during warm clear weather.

The turbulence of some of these rising columns is evident from the numerous rolls and billows of the large cumulus clouds they produce, and it is obvious that the same sort of turbulence, probably on a smaller scale, occurs near the tops of those columns that do not rise to the cloud level. Further, it is quite possible, when the air is exceptionally quiet, for a rising column to be rather sharply separated from the surrounding quiescent atmosphere, as is evident from the closely adhering long columns of smoke occasionally seen to rise from chimneys.

The velocity of ascent of such fountains of air is at times surprisingly great. Measurements on pilot balloons and measurements taken in manned balloons have shown vertical velocities, both up and down, of as much as 10 feet per second. The soaring of large birds is a further proof of an upward velocity of the same order of magnitude, while the fact that in cumulus clouds water drops and hailstones often are not only temporarily supported, but even carried to higher levels, shows that uprushes of 25 to 30 feet per second not merely may but actually do occur.

There are, then, aerial fountains of considerable vertical velocity whose sides at times and places may be almost as sharply separated from the surrounding air as are the sides of a fountain of water, and it is altogether possible for the swiftest of these to produce effects on an aeroplane more or less disconcerting to the pilot. The trouble may occur:

1. On grazing the column, with one wing of the machine in the rising and the other in the stationary air; a condition that interferes with lateral stability and produces a sudden shock both on entering the column and on leaving it.

2. On plunging squarely into the column; thus suddenly increasing the angle of attack, the pressure on the wings, and the angle of ascent.

3. On abruptly emerging from the column; thereby causing a sudden decrease in the angle of attack and also abruptly losing the supporting force of the rising mass of air.

That flying with one wing in the column and the other out must interfere with lateral stability and possibly cause a fall as though a hole had been encountered, is obvious, but the effects of plunging squarely into or out of the column require a little further consideration.

Let an aeroplane that is flying horizontally pass from quiescent air squarely into a rising column. The front of the machine will be

lifted, as it enters the column, a little faster than the rear, and the angle of attack, that is, the angle at which the wing is inclined to the horizon, will be slightly increased. This, together with the rising air, will rapidly carry the machine to higher levels, which, of itself, is not important. If, however, the angle of attack is so changed by the pilot as to keep the machine, while in the rising column, at a constant level, and if, with this new adjustment, the rising column is abruptly left, a rapid descent must begin—the half hole is met. But even this is not necessarily harmful. Probably the real danger under such circumstances arises from *over adjustments* by the aeronaut in his hasty attempt to correct for the abrupt changes. Such an adjustment might well cause a fall so sudden as strongly to suggest an actual hole in the air.

Rising columns of the nature just described occur most frequently during clear summer days and over barren ground. Isolated hills, especially short or conical ones, should be avoided during warm still days, for on such occasions their sides are certain to be warmer than the adjacent atmosphere at the same level, and hence to act like so many chimneys in producing updrafts. Rising air columns occur less frequently and are less vigorous over water and over level green vegetation than elsewhere. They are also less frequent during the early forenoon than in the hotter portion of the day, and practically absent before sunrise and at such times as the sky is wholly covered with clouds.

AERIAL CATARACTS.

There are two kinds of aerial cataracts, the free-air cataract and the surface cataract. The former is the counterpart of the aerial fountain and is most likely to occur at the same time. It is seldom rapid save in connection with thunderstorms, and such effect as it may have is exactly similar to, but in the opposite direction from, that of the rising column.

The second or surface cataract is caused by the flow of a dense or, what comes to the same thing, a heavily laden surface layer of air up to and then over a precipice, much as a waterfall is formed. Such cataracts are most frequent among the barren mountains of high latitudes where the surface winds catch up and become weighted with great quantities of dry snow and, because of this extra weight, often rush down the lee sides of steep mountains with the roar and the force of a hurricane.

But the violence of such winds clearly is all on the lee side and of shallow depth, and therefore where such conditions prevail the aeronaut should keep well above the drifting snow or other aerial ballast, and, if possible, strictly avoid any attempt to land within the cataract itself.



REGULAR AND IRREGULAR CLOUD WAVES; WINDS BOTH PARALLEL AND CROSSWISE.



FIG. 1.—REGULAR CLOUD WAVES; WINDS PARALLEL.
(Part of Plate 1.)



FIG. 2. IRREGULAR CLOUD WAVES; WINDS CROSSWISE.
(Part of Plate 1.)

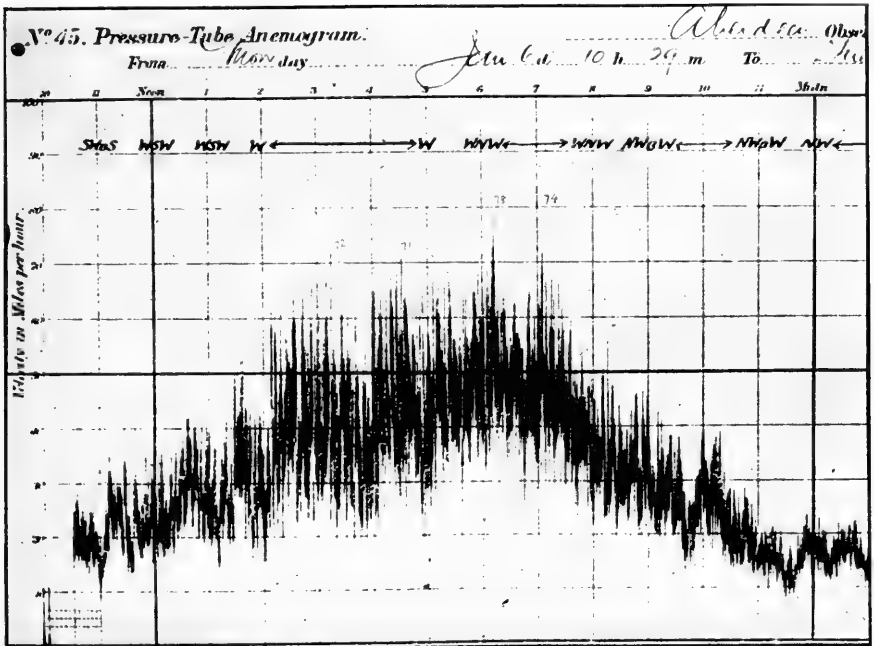

FIG. 1.—WIND GUSTS; PRESSURE-TUBE RECORD.
Aberdeen. Changes during a gale. Dr. W. H. Shaw.

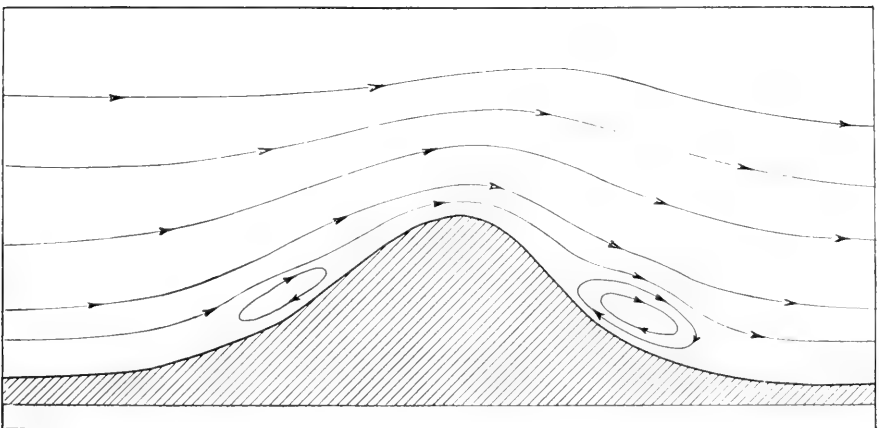

FIG. 2.—WIND EDDIES.

AERIAL CASCADES.

The term "aerial cascade" may, with some propriety, be applied to the wind as, following somewhat closely the surface contour, it sweeps down to the lee of a hill or mountain. Ordinarily it does not come very near to the ground, where indeed there frequently is a counter current, but remains at a considerable elevation. Other things being equal, it is always most pronounced when the wind is at right angles to the direction of the ridge and when the mountain is rather high and steep. The swift downward sweep of the air when the wind is strong may carry the aeroplane with it and lead observers, if not the pilot, to fancy that another hole has been encountered, where, of course, there is nothing of the kind. Indeed, such cascades should be entirely harmless so long as the aeronaut keeps his machine well above the surface and therefore out of the treacherous eddies, presently to be discussed.

WIND LAYERS.

It is a common thing to see two or more layers of clouds moving in different directions and at different velocities. Judgment of both the actual and the relative velocities of the cloud layers may be badly in error—the lower seems to be moving faster, and the higher slower, than is actually the case. Accurate measurements, however, are possible and have often been made.

These differences in direction and velocity of the winds are not confined to cloud layers, nor even to cloudy weather, as both pilot and manned balloons have often shown. Occasionally balloons float for long intervals with a wind in the basket, showing that the top and the bottom of the balloon are in currents of different velocities. Another evidence of wind layers moving with different velocities is the waves or billows so often seen in a cloud layer.

A beautiful example of the long, regular cloud waves produced by winds that have the same direction but different velocities is shown in figure 1, plate 2, while figure 2, plate 2, shows an equally good example of irregular or choppy waves produced by currents that are more or less crossed. Both kinds of waves may, and in fact often do, exist in close proximity to each other. Thus, for instance, the accompanying figures on plate 2 are, indeed, from adjacent portions of but a single negative, plate 1, taken by Prof. A. J. Henry, of the United States Weather Bureau, and kindly lent for these illustrations.

It was explained by Helmholtz as far back as 1889 that layers of air differing in density are of frequent occurrence, and that they glide, sharply divided and with but little intermingling, the one over another, in much the same manner that air flows over water, and with the same general wave-producing effect. These air waves are "seen"

only when the humidity at the interface is such that the slight difference in temperature between the crests and the troughs is sufficient to keep the one cloud-capped and the other free from condensation. In short, the humidity condition must be just right, and therefore, though such clouds are often seen, air billows must be of far more frequent occurrence.

Consider now the effect on an aeroplane as it passes from one such layer into another. For the sake of illustration let the case be an extreme one. Let the propeller be at rest and the machine be making a straightaway glide to earth, and let it suddenly pass into a lower layer of air moving in the same horizontal direction as the machine and with the same velocity. This, of course, is an extreme case, but it is by no means an impossible one. Instantly on entering the lower layer, under the conditions just described, all dynamical support must cease, and with it all power of guidance. A fall, for at least a considerable distance, is absolutely inevitable, and a disastrous one highly probable. To all intents and purposes a hole, a perfect vacuum, has been run into.

The reason for the fall will be understood when it is recalled that, for all ordinary velocities, wind pressure is very nearly proportional to the square of the velocity of the wind with respect to the thing against which it is pressing. Hence, for a given inclination of the wings, the lift on an aeroplane is approximately proportional to the square of the velocity of the machine with reference, *not* to the ground, but to the *air* in which it happens to be at the instant under consideration. If then it glides, with propellers at rest, into air that is moving in the same horizontal direction and with the same velocity, it is in exactly the condition it would be if dropped from the top of a monument in still air. It must inevitably fall to ruin, unless, indeed, rare skill in balancing, or, possibly, mere chance should bring about a new glide after additional velocity had been acquired as the result of a considerable fall. Warping of wings, turning of ailerons, dipping and twisting of rudders, and all the other devices of this nature would be utterly useless at first, totally without effect so long as wind and machine have the same velocity, for, as already explained, there would be no pressure on them in any position, and consequently nothing that could be done with them would at first have any effect on the behavior of the machine. However, as stated above, a skillful pilot may secure a new glide with a properly constructed machine, and, finally, if high enough, make a safe landing.

Of course, such an extreme case must be of rare occurrence, but cases less extreme are met with frequently. On passing into a current where the velocity of the wind is more nearly that of the aeroplane, and in the same direction, more or less of the supporting force is instantly lost, and a corresponding drop or dive becomes at once

inevitable. Ordinarily, however, this is a matter of small consequence, for the new speed necessary to support the machine is soon acquired, especially if the engine is in full operation. Occasionally, though, the loss in support may be large and occur but a short distance above the ground, and therefore be distinctly dangerous.

If the new wind layer is against and not with the machine, an increase instead of a decrease in the sustaining force is the result, and but little occurs beyond a mere change in the horizontal speed with reference to the ground, and a slowing up of the rate of descent.

All the above discussion of the effect of wind layers on aeroplanes is on the assumption that they flow in parallel directions. Ordinarily, however, they flow more or less across each other, as indicated by figure 2, and therefore, as a rule, the aeronaut on passing out of one of them into the other has to contend with more than a disconcertingly abrupt change in the supporting force. That is to say, on crossing the interface between wind sheets, in addition to suffering a partial loss of support, he usually has to contend with the turmoil of a choppy aerial sea, in which his equilibrium is by no means secure—in which “holes” seem to abound everywhere.

Wind sheets, within ordinary flying levels, are most frequent during weather changes, especially as fine weather is giving way to stormy. This, then, is a time to be on one's guard against the most dangerous of all “holes in the air,” even to the extent of making test soundings for them with small pilot balloons. It is also well to avoid making great changes in altitude, since wind sheets, of whatever intensity, remain roughly parallel to the surface of the earth, and the greater the change in altitude the greater the risk of running into a treacherous “hole.” Also, lest there might be a wind sheet near the surface, and for other good reasons, landings should be made, if possible, squarely in the face of the *surface* wind.

WIND BILLOWS.

It was stated above that when one layer of air runs over another of different density billows are set up between them, as illustrated by the cloud pictures. Of course, as already explained, the warning clouds are comparatively seldom present, and therefore even the cautious aeronaut may, with no evidence of danger before him, take the very level of the billows themselves, and before getting safely above or below them encounter one or more sudden changes in wind velocity and direction due, in part, to the eddy-like or rolling motion within the billows, with chances in each case of being suddenly deprived of a large portion of the requisite sustaining force—of encountering a “hole in the air.” There may be perfect safety in either layer, but, unless headed just right, there necessarily is some risk in going from one to the other, and therefore, since flying at the billow

level would necessitate frequent transitions of this dangerous nature, it should be strictly avoided.

WIND GUSTS.

Near the surface of the earth the wind is always in a turmoil, owing to friction and to obstacles of all kinds that interfere with the free flow of the lower layers of the atmosphere and thereby allow the next higher layers to plunge forward in irregular fits, swirls, and gusts, with all sorts of irregular velocities and in every which direction. Indeed, the actual velocity of the wind near the surface of the earth often and abruptly varies from second to second by more than the full average value, and the greater the average velocity, the greater, in approximately the same ratio, are the irregularities or differences in the successive momentary velocities, as is well shown by pressure tube traces, of which plate 3, figure 1, copied from Reports and Memoranda, No. 9 (1909), of the British Advisory Committee for Aeronautics, is a fine example.

Clearly in such wind, if at all violent, the support to an aeroplane will be correspondingly erratic and vary between such wide limits that the aeronaut will find himself in a veritable nest of "holes" out of which it is difficult to rise and dangerous to try. However, as the turmoil due to horizontal winds rapidly decreases with increase of elevation, and as the aeronaut's safety depends upon steady conditions, or upon the velocity of his machine with reference to the atmosphere and not with reference to the ground, it is obvious that the windier it is the higher in general he should fly.

WIND EDDIES.

Eddies and whirls exist in every stream of water, from tiny rills to the great rivers and even the ocean currents, wherever the banks are such as greatly to change the direction of flow and wherever there is a pocket of considerable depth and extent on either side. Similar eddies, but with horizontal instead of vertical axes, occur at the bottoms of streams where they flow over ledges that produce abrupt changes in the levels of the beds.

The inertia of the stream of water, its tendency to keep on in the direction it is actually moving and with unchanged velocity, together with its viscosity, necessitate these whirls with which nearly all are familiar. Similarly, and for the same general reasons, horizontal eddies occur in the atmosphere, and the stronger the wind the more rapid the rotation of the eddy. They are most pronounced on the lee sides of cuts, cliffs, and steep mountains, but occur also, to a less extent, on the windward sides of such places. In other words the general distribution and direction of the wind currents on the sides of and above large obstructions are somewhat as schematically represented in plate 3, figure 2.

The air at the top and bottom of these whirls is moving in diametrically opposite directions, at the top with the wind, at the bottom against it, and since they are close to the earth they may therefore, as explained under "wind layers," be the source of decided danger to aeronauts. There may be danger also at the forward side of the eddy where the downward motion is greatest.

When the wind is blowing strongly landings should not be made, if at all avoidable, on the lee sides of and close to steep mountains, hills, bluffs, or even large buildings; for these are the favorite haunts, as just explained, of treacherous "holes in the air." The whirl is best avoided by landing in an open place some distance from bluffs and large obstructions, or, if the obstruction is a hill, on the top of the hill itself. If, however, a landing to one side is necessary and the aeronaut has choice of sides, he should, other things being equal, take the *windward* and not the *lee* side. Finally, if a landing close to the lee side is compulsory he should, if possible, head along the hill, and not toward or from it; along the axis of the eddy and not across it. Such a landing would be safe, unless made in the down draft, since it would keep the machine in winds of nearly constant (zero) velocity with reference to its direction, whatever the side drift, provided the hill was of uniform height and slope and free from irregularities. But as hills seldom fulfill these conditions lee side landings of all kinds should be avoided.

AERIAL TORRENTS.

Just as water torrents are due to drainage down steep slopes, so, too, aerial torrents owe their origin to drainage down steep narrow valleys. Whenever the surface of the earth begins to cool through radiation or otherwise the air in contact with it becomes correspondingly chilled and, because of its increased density, flows away to the lowest level. Hence of clear still nights there is certain to be air drainage down almost any steep valley. When several such valleys run into a common one, like so many tributaries to a river, and especially when the upper reaches contain snow and the whole section is devoid of forest, the aerial river is likely to become torrential in nature along the lower reaches of the drainage channel.

A flying machine attempting to land in the mouth of such a valley after the air drainage is well begun is in danger of going from relatively quiet air into an atmosphere that is moving with considerable velocity—at times amounting almost to a gale. If one must land at such a place he should head up the valley so as to face the wind. If he heads down the valley and therefore runs with the wind he will, on passing into the swift air, lose his support, or much of it, for reasons already explained, and fall as though he had suddenly gotten into an actual "hole in the air."

AERIAL BREAKERS.

The term "aerial breakers" is used here in analogy with water breakers as a general name for the rolling, dashing and choppy winds that accompany thunderstorm conditions. They often are of such violence, up, down, and sideways in any and every direction that an aeroplane in their grasp is likely to have as uncontrolled and disastrous a landing as would be the case in an actual hole of the worst kind.

Fortunately aerial breakers usually give abundant and noisy warnings, and hence the cautious aeronaut need seldom be, and, as a matter of fact seldom is caught in so dangerous a situation. However, more than one disaster is attributable to just such winds as these—to aerial breakers.

CLASSIFICATION.

The above nine types of atmospheric conditions may conveniently be divided into two groups with respect to the method by which they force an aeroplane to drop.

1. *The vertical group.*—All those conditions of the atmosphere, such as aerial fountains, cataracts, cascades, breakers, and eddies (forward side), that, in spite of full speed ahead with reference to the *air*, make it difficult or impossible for an aeronaut to maintain his level, belong to a common class and depend for their effect upon a vertical component, up or down, in the motion of the atmosphere itself. Whenever the aeronaut, without change of the angle of attack and with a full wind in his face, finds his machine rapidly sinking, he may be sure that he has run into some sort of a down current. Ordinarily, however, assuming that he is not in the grasp of storm breakers, this condition, bad as it may seem, is of but little danger. The wind can not blow into the ground and therefore any down current, however vigorous, must somewhere become a horizontal current, in which the aeronaut may sail away or land as he chooses.

2. *The horizontal group.*—This group includes all those atmospheric conditions—wind layers, billows, eddies (central portion), torrents and the like—that, in spite of full speed ahead with reference to the *ground*, abruptly deprive an aeroplane of a portion at least of its dynamical support. When this loss of support, due to a running of the wind more or less with the machine, is small and the elevation sufficient there is but little danger, but, on the other hand, when the loss is relatively large, especially if near the ground, the chance of a fall is correspondingly great.

CONCLUSIONS.

1. Holes in the air, in the sense of vacuous regions, do not exist.
2. Conditions in the atmosphere favorable to precipitous falls, such as would happen in holes, do exist, as follows:

(a) VERTICAL GROUP.

1. *Aerial fountains*.—Uprushes of air, most numerous during warm clear weather and over barren soil, especially above conical hills, are disconcerting and dangerous to the novice, but do not greatly disturb an experienced aviator.

2. *Aerial cataracts*.—Downrushes of the free air, like the uprushes with which they are associated in a vertical circulation, though less violent, must also be most frequent during warm weather when the ground is strongly heated. They, too, however annoying to the beginner, should not be dangerous to the experienced man, because even when strong enough to carry the machine down for a distance their descent necessarily becomes slower and their chief velocity horizontal before the surface is reached. Downrushes of weighted air over precipices, analogous to waterfalls, must be strictly avoided.

3. *Aerial cascades*.—The lower wind, in following as it must surface contours, sweeps down to the leeward of hills and mountains in cascade-like falls, and the stronger the wind the more rapid the cascades. But they are of no danger to the aeronaut so long as he takes the precaution to keep above the eddies and other surface disturbances.

4. *Aerial breakers*.—The choppy, breaker-like winds of thunderstorms that surge up and down and in all sorts of directions are as much to be avoided by aerial craft as are ocean breakers by water craft. Hence a flight should positively not be attempted under any such circumstances.

5. *Wind eddies (forward side)*.—The air on the forward side of a strong eddy has a rapid downward motion and therefore should be avoided. If caught in the down current of an eddy the aeronaut should head lengthwise of the hill or mountain to which the eddy is due. By heading away from the mountain he might, to be sure, get entirely out of the whirl, but the chances are just as great that instead of getting out he would only get the deeper in and thus encounter downward currents swifter and still more dangerous than those he had sought to shun.

(b) HORIZONTAL GROUPS.

1. *Wind layers*.—The atmosphere is often made up of two or more superimposed layers moving each with its own velocity and direction. Such a condition is a source of danger to the aeronaut because transition from one of these layers to another more nearly coincident in direction and velocity with his aeroplane is certain to result in at least a sudden decrease in the magnitude of its supporting pressure and in the effectiveness of the balancing devices. Under certain extreme conditions this transition, even when the winds are parallel, is well nigh inevitably disastrous. When the layers move more or

less across each other, as they usually do, the turmoil of the resulting short and choppy billows, by rendering equilibrium difficult, add an additional danger all their own.

Dangerous wind layers are most frequent at flying levels during the transition of fair to foul weather.

2. *Wind billows*.—Wind waves analogous to water waves are set up at the interface between two layers that are moving with different velocities. If both layers are moving in the same direction, the resulting waves are long and regular; if in different directions, they are short and choppy. Therefore, other things being equal, it obviously is advisable to keep within the lower layer, or at least to get away from the billowy interface, either above or below, and to avoid crossing it oftener than is absolutely necessary.

3. *Wind gusts*.—The horizontal velocity of the wind near the surface of the earth is exceedingly irregular and fluctuates from second to second at times by as much as the whole of the average velocity. In such a wind, if at all swift, the support to an aeroplane is exceedingly erratic and both its launching and its landing full of danger.

Obviously, too, the stronger the wind the higher, because of these surface disturbances, one should fly, if at all.

4. *Wind eddies (central portion)*.—Eddies, or horizontal rolls in the atmosphere, are found on both the windward and lee sides, especially the latter, of cliffs and steep hills and mountains. When the wind is strong a landing should not be attempted in any such place. If forced to land in a place of this kind, the machine should be headed along and not at right angles to the direction of the hill.

5. *Aerial torrents*.—Steep barren valleys, especially of clear still nights and when the upper reaches are snow covered, are the beds of aerial drainage rivers that at times amount to veritable torrents. Therefore, however quiet the upper atmosphere and however smooth its sailing, it would be extremely dangerous to attempt to land an aeroplane at such a place and such a time.

NOTE.

All the above sources of danger, whether near the surface like the breakers, the torrents, and the eddies, or well up like the billows and the wind sheets, are less and less effective as the speed of the aeroplane is increased. But this does not mean that the swiftest machine necessarily is the safest; there are numerous other factors to be considered, and the problem of minimum danger or maximum safety, if the aeronaut insists, can only be solved by a proper combination of theory and practice, of sound reasoning and intelligent experimentation.

REVIEW OF APPLIED MECHANICS.¹

By L. LECORNU,

Member of the Institute, Inspector General of Mines, Professor at l'École Polytechnique.

The domain of applied mechanics is great. The number of publications devoted to it, in Europe as well as in America, forms an immense bibliography. I can not analyze here even briefly this mass of material. I shall limit myself, as in former years (1903, 1905, and 1909), to describing a few of the most interesting results.

I. STEAM APPARATUS.

Leprince-Ringuet published in the *Revue de Mécanique* (1911) a research upon the transmission of heat between a fluid in movement and a metallic surface. After examining various theories and experiments upon the subject he found that when a gas flows through a tube the quantity of heat transmitted per hour per square meter can be given by the expression $B(CVp)^n$, where B is the coefficient of transmission, varying inversely as the 0.13 power of the length of the tube; C is a coefficient increasing proportionately with the temperature; V the velocity of the gas in meters; p the weight of a cubic meter of the gas in kilograms; and n is an exponent which depends upon the relation of the cross section to the perimeter. For a circular tube of the diameter d it is practically

$$n = \frac{1 + 18d}{1 + 36d}$$

The coefficients B and C vary only slightly from one liquid to another.

The author concludes that the exchange of heat can be considerably increased by increasing the flow, the eddies, and the ratio of the perimeter to the cross section. It is also advantageous, whenever possible, to promote the condensation upon the metallic surfaces.

Bone developed the idea of applying to the heating of steam boilers a process suggested by an old invention of Lude, which consisted in injecting through a contrivance formed of porous surfaces

¹ Translated by permission from *Revue générale des Sciences pures et appliquées*, Paris, July 30, 1912, pp. 548-557.

or mass of refractory fragments a mixture of air and gas in the proportion to assure perfect combustion and which must be discharged fast enough to prevent the flame "striking back." The gas is ignited as it flows out of this contrivance.

In the ordinary Bone heater, based upon this principle, the ordinary boiler tubes are replaced with ones filled with pebbles. The combustion takes place within the first 150 millimeters of the tubes and the burnt gases raise the pebbles to incandescence. The experiments made at Yorkshire gave encouraging results. The experimental heater proved very active and easy to regulate.

I wrote at considerable length in the Review for 1909 on the subject of superheaters. The idea of superheating steam in order to avoid harmful condensations appears to have originated with a mechanician of Strasburg named Becker, who in 1827 obtained a patent for that purpose, and it is rather remarkable that since then it has been in Alsace, where the practical realization of superheating has taken place. It was at Logelbach that Hirn, in his famous experiments, made with two engines of more than 100 horsepower, showed that economies of more than 20 to 25 per cent could be obtained by superheating less than 100°. Schwoerer, for a long while secretary to Hirn, has continued the researches of his former master and triumphed over the difficulties which retarded the practical application of superheating. In 1904 he announced at the Société d'Encouragement pour l'Industrie nationale that during the last 10 years he had built more than 5,000 superheaters of his design and still continued with the same success. Schwoerer's apparatus consists of a set of very thick, straight tubes, about 3 meters long, with exterior transverse thickenings and longitudinal interior ribs, assembled in a semicircular frame. Its weight is about 300 kilograms per meter. The device is sometimes used horizontally, sometimes vertically. The great mass of metal serves as a reservoir of heat.

Davane, in a memoir published in the Bulletin du Congrès international des Chemins de fer (1909), told of the employment of superheating in locomotives and gave many interesting data. The following are a few of his conclusions: The economy is inappreciable for a superheating of 30° to 40°. The temperature of the superheated vapor must not be raised above 350°. Under such conditions economies reaching from 20 to 22 per cent may be obtained. The saw-tooth profile of the roads (that is, frequent changes from up to down grade), the many and prolonged stops at stations, are very unfavorable to the use of superheating on locomotives. The increase of power is obtained only on certain lines. The great superheating necessitates the proper protection of the cylinders and the distributing system as well as special lubrication with oils suitably chosen.

The Review of 1905 mentioned the installation in Algeria of Robert locomotives, where, in place of the ordinary tubes plunged in water and through which the flames pass, the water passed through tubes plunged in the flames. This type of locomotive boiler seems especially suited for service where water of bad quality must be used or with very high pressures. The Compagnie du Nord sent to the exposition at Brussels a locomotive with water tubes of the type called "Atlantic," rated at 18 kilograms; they noted that in order to have a good water circulation it was necessary to have considerably greater vaporization per square meter of surface than with ordinary locomotives.

Steam turbines, of which I spoke in detail in the 1903 and 1909 Reviews, receive more and more extended applications. The North British Locomotive Co., of Glasgow, has constructed a turbine locomotive. The turbine used is of the "impulsion" type; that is, it receives the steam after complete detentions. This turbine, with 3,000 revolutions per minute, drives a continuous-current dynamo which in turn controls four dynamos mounted upon the driving axles. The escaping vapor passes to an ejector condenser and is returned to the heater by a feed pump. Since turbines do not require the lubrication of a piston engine, the steam is not mixed with oil. On the other hand, the suppression of the exhaust into free air makes some other recourse necessary for utilizing the full motive power of the steam. A ventilator is used. The locomotive is carried upon two drivers, each driven by two of the dynamos. The trials seem to have been very satisfactory. The electric control assures the desired flexibility in speed and makes reversal possible. I stated in 1909 that Navor had proposed an analogous solution for the use of marine turbines.

Another turbine locomotive was made at Milan. In this engine the distributor reduces the pressure of the steam from that of the boiler to that of the envelope of the turbine. The latter has four groups of paddles working in turn. When great speed is necessary the steam propels only the first group of blades, at reduced speed, the several groups. In order to change speed the number of blades may be doubled by reversing their curvature. This locomotive has a heater of 65 square meters surface and was rated at 9 kilograms and furnished 100 horsepower. It was only an experimental locomotive. The advantages shown from these experiments were: The possibility of very great speeds, economy in lubrication, the suppression of oscillations, better utilization of the fuel, reduction of the upkeep expense, and facility of management and reversal.

The development of marine turbines continues. Without restating what I have given in previous papers, I would add that Yarrow

profited by the substitution of turbines for piston engines in the construction of marine engines provided with superheating. The use of superheating is here made possible by the suppression of the lubricating oil which, when mixed with the steam, after passing through the boiler is apt to decompose in the superheater and cause trouble. Precautions are necessary that the superheater is not burned up when its supply of steam decreases too much or ceases. To avoid this, Yarrow provided a way of diverting by a damper more or less of the hot gas from the fire. This damper is cooled by a current of air passing constantly between its faces to prevent their deformation. An economy of 10 to 12 per cent was thus obtained with a superheating of 50° to 65° .

The celebrated electrician, Tesla, has invented a steam turbine which seems to possess the greatest possible simplicity. It consists of a series of disks fastened to the same shaft and inclosed within a common casing. The steam, admitted tangentially into the casing, after describing spirals in contact with each of the disks, escapes through a central opening. The friction thus produced suffices to give a very rapid rotation. With disks 457 millimeters in diameter and 25 in number and steam at 9 kilograms, experiments made at New York developed a speed of 9,000 turns per minute and a horsepower of 200. The steam consumption, as might have been expected, was unfortunately very great. It reached 17 kilograms of steam per horsepower. The inventor hopes to get greater economy through the use of condensation. But it is doubtful whether the driving of the disks by friction of the steam, which is the main point of this invention, will ever give good results as to steam consumption. His system has the advantage of allowing easy reversal. Two jets, entering in opposite directions, are all that is necessary, employing one for the forward, the other for backward motion.

An attempt was made with the same turbine to use gas burning under pressure after having been mixed with sufficient water to render the temperature harmless. The results were not stated.

II. GAS AND PETROLEUM ENGINES.

The gas engine, despite the conveniences in its use, did not reach its full development the day that cheaper gases were substituted for the more expensive illuminating gas.

The most common process of producing this cheaper gas consists in passing a current of air over a column of the combustible, raised to a red heat over some 70 centimeters; the combustible part of the gas thus obtained is an oxide of carbon. In place of dry air, moist air is often injected. The water dissociates, furnishing hydrogen which combines with the carbon and oxygen, while the water at the same time lowers the temperature of the apparatus. This gas producer is

fed with poor coal or coke. Results may thus be obtained not exceeding 400 grams of coal per effective horsepower. For realizing the importance of this result, it is sufficient to recall that with a compound steam engine and coal with 10 per cent ash, capable of giving 7,200 calories per kilogram the consumption exceeds 600 grams and often reaches 1 kilogram.

It is desirable to be able to feed the gas producer with any kind of coal whatever. The employment of greasy coals is rendered difficult by the formation of tars which, when the combustion is not complete, tend to obstruct the distributing system. Further, greasy carbon, in order to feed regularly, requires constant stoking which in turn disturbs the working of the motor. Letombe succeeded in overcoming these difficulties. He observed that, in order to keep the coal feeding properly in the gas producer, it was only necessary to start the combustion of the volatile product at the very moment of its distillation. His gas producer is overfed, having at its upper part a stepped grate by which the air necessary for the combustion is introduced.

The greasy coals are in general too costly for the production of cheap gas. It would be better to use those combustibles of copious ash which can not be employed in other ways. The principal difficulty then is to overcome the resistance offered to the flow of the air. Kerpley made for that purpose a high-pressure gas producer (400 to 700 millimeters of water) the rotating grating of which is perforated with a great number of holes distributed over its whole surface.

There has just been put into service at the German steel works at Bruckhausen, a blower driven by probably the most powerful gas engine in existence. This engine is a four-cycle motor, with two cylinders in tandem and of 1.40 meters stroke. The diameter of the gas cylinders is 1.20 meters, of the vent cylinders, 1.90 meters.

For a long time gas engines were worked by valves. Such engines are now in competition with those using cylindrical slides or cocks. The great speeds accentuated the well-known faults of the valves due to the noisy shocks, the hammering, the difficulty of adjustment, the stratification of the gas, etc. The Mercedes and Renault motors use turning cocks. The Knight motor, which has attained such success since its appearance, uses a distribution made by two concentric sheaths placed within the interior of the cylinder and worked by eccentrics. The stratification is small because of the care taken in giving the parts the necessary dimensions. Fear might be entertained over difficulties in lubricating and chilling. But experience shows that these difficulties are easily overcome. Oil, constantly renovated, does not lose its fluidity. The doing away with the valves allows a very simple shape for the explosion chamber, the surface of which may thus be very much reduced, and to this Knight attributes the great flexibility of his motor. The reduction of surface exposed

to cooling allows the gas to conserve its heat at the moment of the explosion and, further, the absence of nooks assures a perfect removal of the burnt gas. It should be noted that the concentric sheaths of the Knight motor require very accurate working, which makes the construction delicate and raises the cost of repairs.

Gas motors are not to be recommended for use on vessels because of the danger of the formation of explosive gas mixtures in badly ventilated engine rooms. This objection does not apply to the Diesel motor, mentioned in the Review for 1903. This motor is of interest for war ships because of the suppression of smoke, the reduction of personnel, as well as its augmented scope of action, which is some three times as great as with the ordinary steam engine.

Let me restate that the principle of the Diesel motor is to inject progressively the combustible liquid by means of a pump into air compressed to 30 atmospheres. Because of the high temperature due to the compression, the mixture spontaneously ignites, so that there is no need of an igniter. This motor can use petroleum residues useless for all other motors. Official tests made on submarines provided with Diesel motors have shown thermal efficiencies reaching 32.5 per cent for a horsepower of 75 and 42 per cent for horsepowers of 395, whereas the best triple-expansion steam engines seldom surpass 13 per cent.

The Maison Sulzer has recently constructed a locomotive of 1,000 horsepower driven by a 4-cylinder Diesel motor.

Among the motors for aviation the king of the day is undoubtedly the Gnome. This is a two-center rotating motor. The cylinders, odd in number, turn about one of these centers while the pistons turn about the other. The line of centers plays the part of a unique crank which remains fixed. This arrangement does away with all the varying forces due to the inertia which are inevitable with motors using fixed cylinders, and thus assures a very satisfactory equilibrium.

On the other hand, the rapid rotation of all the cylinders produces an energetic ventilation and thus at the same time solves the problem of cooling them. That result is obtained, it is true, through an increased power consumption for this stirring of the air, which may amount to 10 per cent of the total power developed. We may add that this rotation intimately mixes the combustible with the necessary air, makes the cylinders fill very uniformly, circumstances very favorable to a regularity of the explosions.

Rotating motors have the objection that the oil is thrown against the bases of the cylinders and toward the valves. They are also very costly because of the especial care necessary in their construction and their rapid wearing out. A rotating motor while working escapes proper surveillance. The gyroscopic effects resulting from the rapid rotation of the motor and possibly disturbing in the maneuvering of the aeroplane do not seem to have troubled the aviators.

I have stated that the number of cylinders of the Gnome motor is odd. The same statement is true of many motors in use for aviation, and we may well ask why. The reply is given through the formula which I had the occasion to prove, and which may be stated as follows: $n = K(n + p - 2)$ where n is the number of cylinders, K , the number of cranks, and p the order in which the sparking occurs; that is after having sparked the first cylinder, then the one of rank, $p + 1$, is sparked, then $2p + 1$, and so on until the first one is reached again. In order that all the cylinders may be sparked in turn it is necessary and sufficient that p is prime with n . That granted, it follows that, if one crank is employed in order to simplify and make the motor as light as possible, k must equal 1 and when $p = 2$, n must be odd.

III. RAILROADS.

The development of our industries requires the use every day of more and more powerful locomotives. Since the gauge is fixed, and so prevents an increase in their width, any increase has to occur in their length. When we pass a certain limit precautions are necessary for permitting their passage around curves. This has led to the construction of long articulated locomotives of the Mallet type. The driving mechanism is here distributed between two trucks, the rear one of which only is rigid with the boiler. The fore truck, movable with respect to the rear one, carries the low-pressure cylinders which receive and discharge the steam through flexible tubes.

The Americans have gone yet further. The excessive length of the new boilers renders their management difficult, so that they divide it into two parts bolted together. The two parts may then be separated at the workshop for inspection and repair. Then they have recognized the advantage of making the joint flexible in order to diminish in going around curves the overhanging of the ends of the engine beyond the tracks. They thus obtain without an increase of crew a flexibility equal to that of coupled locomotives. With engines thus coupled there are hauled between Chicago and the Pacific coast freight trains carrying the enormous loads of 2,200 tons. The results have been excellent and it is only a matter of extending the process or, what accomplishes the same purpose, of making new engines by coupling together older ones.

In order to increase the traction, the Americans have transformed in turn the tender into a kind of an auxiliary engine provided with two cylinders connected by flexible tubes for furnishing the low-pressure steam coming from the locomotive. There is thus obtained almost a rolling manufactory provided with 12 axle motors, 8 of which are under the locomotive and 4 under the tender. There are besides trucks at the front end of the locomotive and under the rear end of the tender. May I ask how one engineer and one fireman can be sufficient to control the boiler of such an engine?

De Valbreuze published in 1911 in the *Bulletin de la Société d'Encouragement* an interesting study on the use of electricity on railroads. The following are a few of his conclusions: The principal advantages resulting from the use of electric traction rest in the suppression of smoke, the increasing of the capacity of the terminal station due to the simplification of the maneuvering of the trains, and the possibility of the use of steep grades so that more than one story may be utilized at the station, the rapidity of starting, the multiplication of trains, and, finally, the possibility of communicating from an exterior source of energy as great an amount of power as may be desired. Along with these technical advantages there are several economic ones which result in diminishing the expenses of operation. Electric locomotives have a smaller dead-weight than those using steam. The power house for electricity uses steam engines of the highest efficiency and fuel unsuited for ordinary locomotives. The maintenance and repair of electric locomotives requires less time, and there consequently results a greater annual mileage for them.

The choice of the electrical method is a very complex problem, demanding in each case a careful study, since no general rules can be formulated. The proximity to a fall of water frequently determines the adoption of electricity. From a military point of view this method of traction possesses great disadvantages; the necessary connection between the electric train and the power house constitutes in the case of mobilization or of war a very serious inconvenience.

Formerly railroad companies used for the transportation of freight only cars of from 5 to 7 tons capacity. After 1855 cars of 10 tons came into use; in 1879 of 15 tons; and in 1895 of 20 tons. In order to go farther it became necessary to increase the number of axles, for the European tracks could not support more than 12 tons per axle. Accordingly, cars of 40 or even 60 tons were made, supported by two small trucks, each having two pairs of wheels.

This increase of capacity has the advantage that the ratio of dead-weight to that of the carried load is reduced. For instance, the tare of a car having a carrying capacity of 40 tons need not exceed 15 tons, whereas formerly cars for loads of 5 to 7 tons had a tare of 5 tons. In order to lighten the cars further it became necessary to give up the use of wood and iron in their construction. The solution of the difficulty was found in the use of sheet steel, which is easily adaptable to the designs suggested.

These great cars have another advantage in that they reduce, other things being equal, the length of the trains. Such a reduction may amount even to 45 per cent. This augments the amount of traffic possible at the station where, for the same length of platform, about twice as much freight may be handled. At the same time the

maneuvering becomes simpler because of the reduced number of couplings.

Henry, who stated these facts in 1911 before the Société d'Encouragement, is of the opinion that we may expect further development and use of these cars of great capacity. However, the small cars will always preserve their utility for lighter traffic, the great cars being reserved for the heavier.

The employment of the air brake has become general with passenger trains, although in Europe it has not yet been extended to freight trains. Such an extension is, however, very desirable even for the security of the passenger trains, since the number of collisions between freight and passenger trains occurs because the former have not sufficiently powerful means of stopping. The air braking of freight trains will cost very considerably, but, as I stated in 1909, it is more a technical difficulty which retards their use. Experience shows that with the very long freight trains the change of pressure produced by the engineer at the front end of the compressed air system requires a considerable lapse of time before it is felt at the other end, and during that period the couplings, which are generally made rather loose in freight trains, because of the frequent changes required in their make-up, receive violent shocks, frequently breaking them. Sabouret, the chief engineer of the Compagnie d'Orleans, proposed for the overcoming of this difficulty a very simple and ingenious contrivance: At the moment when the engineer manipulates the valve of the air brake the three following effects are produced: First, the tender and the four first cars are immediately braked; second, the engine is braked progressively; and third, the rest of the train is braked with a retard of 10 seconds, sufficing for the cars, because of their acquired velocity, to compress all the couplings by pushing forward. Experiments have shown that, under such conditions, the braking works satisfactorily. The application of the process in the Compagnie d'Orleans would cost 7 to 8 millions of francs.

While waiting for the provision of air brakes to freight trains, it is indispensable to at least employ sure and powerful hand brakes. For this purpose the Mestre brake should be mentioned. It last year received the gold medal of the Société d'Encouragement. In the Mestre brake, by a very simple starter, a strong spring causes the rapid approach of the brake shoes, the final clamping being obtained by a device analogous to that of a hand jack. This brake has been successfully tried in the eastern section of France.

The ruptures of the couplings to which I have made allusion are one of the plagues of the railroad world. The procedure which naturally occurs first for reducing them is to reenforce all the dimensions, and such in a measure has been done, as the increase of loads

has so required. But experience shows that this palliative is not sufficient. Fremont showed, by direct experiments, that it is well to use buffer springs strong enough, by their compression, to reduce the active force of the shocks whatever may be their intensity. It seems that this necessity has not always been sufficiently taken into account.

Fremont has further been occupied concerning the ruptures which frequently occur at the end of a certain period in the bent crank shafts of locomotives, often putting such shafts out of service and even causing serious accidents. He saw that such flaws result especially from shocks received perpendicular to their motion, and proposed, consequently, to increase the elasticity of such shafts by hollowing out certain portions (the plates connecting the bodies of the shafts with the bearings of the rods). Such a modification was introduced into the eastern section of France, with so far very encouraging results.

IV. AERODYNAMICS.

The progress of aerodynamics has been intimately associated with that of the perfecting of the motors as well as with the increase of knowledge as to the action of air upon surfaces in movement. I have already spoken of the motors. As to the dynamics of the air, considered with regard to aviation, we may distinguish between the theoretical and experimental results. Among the former there is the important study of Soreau on the propellor, of which he spoke at a conference last year of the Société des Ingénieurs civils. Soreau remarked that there are two schools devoted to the theory of the screw. One considers the elements of the screw itself, without taking into account the movements of the fluid molecules; the other school, better comprehending the flow of liquids, finally reached an avowal of their powerlessness and became strengthened in that avowal as the study of the physical phenomena showed increasing complexity. Soreau says that, after having sided with the latter school at first, he now believes that it is possible to analyze the action of the blades of the screw, with the double reservation that the action takes place in a limited space and that we be content with approximate laws. These laws lead to formulæ no longer wholly empirical, because, as thus developed, they show the parts played by the various dimensions, indicating their order of magnitude and relative influence. Starting thence, the author has commenced to analyze, guided by preconceived ideas, the better experiments on the subject and hopes to get some general results. For some time analogous ideas have guided the naval engineer Doyère in the study of marine screws, for which investigations the Académie des Sciences, in 1911, bestowed a part of the Vaillant prize.

On the experimental side, we must mention the beautiful researches undertaken by Eiffel in the laboratory he has built near the Champ de Mars. It has just been removed to Auteuil. The essential part is a room traversed by an air current, 2 meters in diameter, provided by a centrifugal blower. The velocity of the air may be made as great as 32 meters per second, or 115 kilometers per hour. There is at one side another blower which furnishes air, with a section 1 meter in diameter, but of which the velocity may be raised up to 144 kilometers per hour. The motive power is furnished by a monophasic current from the place at the Champs Elysées and previously transformed into a direct current.

Eiffel's laboratory therefore uses the so-called tunnel method. De Guiche uses in his experiments an entirely different method, studying the action of the air upon surfaces of various form carried by an automobile. We might call the latter an open-air method. At the Institut d'Aérodynamique of Saint-Cyr, established through the liberality of Deutsch de la Meurthe, an open-air method is also used, except that the surfaces under study are carried on a wagon moved electrically along a track 1,400 meters long. A third method, which may be called that of a race course, is used at Saint-Cyr in order to be able to work when the atmosphere without is not sufficiently calm. The diameter of the course has been made 38 meters so as to diminish as much as possible the influence of its curvature.

There are other aerodynamical laboratories in other countries, notably in Italy and in Russia. But whatever may be the scientific interest in the experiments carried on in any laboratories, the conclusions which we may draw from them, when applied to aviation, must always be subject to certain reservations when applied to practical aviation. In order to know exactly what happens on an aeroplane, the measuring apparatus must be installed upon the aeroplane itself in full flight. Legrand and Gaudart have already made some experiments in that manner. It is desirable that their example be followed.

Before leaving the domain of aviation, which will yet require long development, I wish to say a word about Doutré's contrivance for stability. This is designed, according to the inventor, to produce automatically the necessary changes for effecting the longitudinal stability of an aeroplane. The principle is as simple as it is ingenious. A screen running upon guides in the direction of flight receives perpendicularly the force of the wind. To this wing are fastened two other guides parallel to the first and upon which a heavy mass moves. Suitable springs keep the mass in a determinate position. When the velocity of the aeroplane tends to change abruptly, the movable mass, because of its inertia, is momentarily displaced along the guides. On the other hand, when the velocity experiences a sensible varia-

tion the pressure upon the wing is of course changed, and then again, but for a different reason, the movable mass undergoes a displacement. In both cases the change in the position of the mass is used to actuate, by means of a compressed-air auxiliary motor, the elevation rudder of the aeroplane.

The idea of thus combining in one apparatus the influence of an acceleration with that of a velocity is not so new as the inventor supposed, for the regulator of a steam engine called the "American Regulator" applies the same idea.¹ But the merit due to Doutré is because of his idea in using the device for the safety of aviation, and I should add that the experiments so far made show its feasibility. It remains to see how it will work after longer and more varied trials.

Delaporte is the inventor of a contrivance called by him a movable aero propeller and consisting of a device carrying a motor and an air propeller. It is necessary only to install it upon a boat in order to make the latter automobile. Delaporte sees in his invention the solution of the important problem of the navigation of canals. A demonstration of the aero propeller was made at Toulouse September, 1911. It was found that a flat-bottomed boat provided with a 3-horsepower aero propeller could be easily managed and would tow up to 8 boatloads of 40 people each.

V. CONGRESS AT DUSSELDORF.

In 1910 there was held at Dusseldorf a Congrès de Mécanique, where a speciality was made of the application of mechanics to mining and metallurgy. The following are a few abstracts from the proceedings of that congress:

Electricity is more and more used in mines for drilling, for hoisting, for ventilating and exhaust pumps, and for extracting machines. In the metallurgical laboratory it is frequently used for the forges and the rolling machines. It serves further for the heating of the furnaces and for welding. One paper treated of the transportation by aerial cables which exceed 30 kilometers in length.

Another memoir gives the history of the development of the blower and compression in German mines. Blowers are now made capable of blowing in an hour 16,000 cubic meters of air at a pressure of 300 millimeters of water. The turbine compressor, invented by Rateau, is now widely distributed. These machines are often driven by low-pressure turbines to which I referred in the Review for 1909 and whose invention was also due to Rateau. The latter at the Dusseldorf Congress presented an important communication upon the present status of low-pressure turbines. Their steam is furnished by an accumulator receiving the steam escaping from a certain number of ordinary engines. The low-pressure turbine is so built

¹ See my article on Regulators in 1900, *Revue générale des Sciences*, 1901, pp. 125 et seq.

that, in case of need, it may be driven with steam coming direct from the boiler. The supply is automatically received in case of a deficiency from the accumulator. At Middlesborough (England) the installation of two low-pressure turbines allowed the putting out of service of 28 furnaces, thus saving 120 tons of coal per day.

VI. MISCELLANEOUS MATTERS.

In the Review for 1909 I noted a device for diminishing the rolling of ships, based upon the lateral displacement of a heavy mass in a viscous fluid. The stability producer of Frahm depends upon a similar principle. Two reservoirs of water are placed symmetrically upon the opposite sides of a ship and communicate by a tube which can be closed at will. This opening is controlled, according to the oscillation period of the water passing alternately from one reservoir to the other, so as to control the oscillations of the ship itself. Experiments made at Hamburg showed that the rolling could be reduced from 11° to 2.5° . I may add that since 1883, Sir Watts tried the same device upon the gunboat *Inflexible*, and in France, in 1885, Bertin proposed it for the cruiser *Jeanne-d'Arc*.

In the Review for 1909, some mention was made of speed gears which have the purpose of varying at will or reversing the speed of rotation of a shaft driven by another shaft which must run at constant speed and in a constant direction. Since then a new and very interesting solution has been made by Williams and Janney. The transmission of the power is hydraulic. The driving shaft carries a crown of cylinders whose axes are parallel with that of the shaft and each contains a piston jointed to a rod. The end of each piston rod is in turn jointed to a point of a ring which can oscillate about an axis at right angles to the shaft of the motor. Further, this ring incloses a concentric plate which does not partake of the movement of the shaft but may be fixed in a position more or less inclined to that of the shaft. It is apparent, then, that according to the inclination given to the plate the travel of the piston rods will be more or less great; it is zero when the plate is perpendicular to the shaft. The movement of the pistons is used for pumping oil, and it is evident that the quantity pumped at each turn of the shaft depends on the position of the plate. Further, the driven shaft is provided with similar devices except that its plate is rigidly fixed. The whole is assembled and inclosed in a tight box. Its method of working is as follows: The oil pumped during the rotation of the driving shaft is sent to the cylinders of the driven shaft, causing their pistons to work. The displacement of these pistons causes the rotation of the driven shaft and its velocity of rotation is proportional to the volume of air pumped in a unit of time; this volume is varied by inclining more or less the plate of the driving shaft.

This device has already received various applications, especially in the working of the turrets of gunboats. An analogous device is found in the aviation motor of Salmson which was shown at the last Salon. In this we also find an oblique plate with a shaft carrying cylinders with their axes parallel to that of the shaft and of which the pistons, by pressing against a plate, are obliged to take a motion of rotation. But in this case, instead of using oil, the pressure is produced by the explosion of a mixture of air and a volatile oil, as in all gas engines.

In 1909 I stated the principle of certain devices, called torsionmeters, which, as their name indicates, measure the torque of the shaft of a machine in order to calculate the work transmitted by that shaft. The same purpose is accomplished by the use of various dynamometers. The following are two recent inventions whose principle is interesting:

In the Farcot dynamometer the driving shaft is connected to the shaft of the dynamometer by means of a ferrule, threaded on the inside so that it can move parallel along the shaft whenever the two shafts have different speeds. The force which tends to displace the ferrule is proportional to the force transmitted from one shaft to the other. A suitable pressure parallel to the shaft is applied to counteract this displacement and is easily measured by a suitable balance, the scale of which is so graduated as to give by direct reading the power on a basis of 1,000 turns per minute. If the speed has a different value this reading must be multiplied by the actual number of revolutions and then divided by 1,000.

The Walton dynamometer uses a simple device susceptible of a similar movement parallel to the driving shaft. The displacement is here used to compress the oil contained in a small box and by measuring this pressure the power consumed in the transmission may be determined.

Ernault proposes to increase the efficiency of springs in a very rational manner. He remarked that when coiled steel springs are submitted to torsion, for springs of equal weight, those of hollow wire worked better than those of solid wire. Accordingly he was led to construct helical, tubular springs, which for equal strength are much lighter than ordinary springs of the same form. For springs made of superposed strips, he increased the resistance to bending by substituting for the material of rectangular section that which has a slight transverse curvature.

Capt. Largier has constructed an apparatus which he calls a tensionometer, made to indicate the tension of a piece of wire. The device consists in causing a definite length of the wire, limited by two bridges, to vibrate and then finds what the length L must be in order that the vibration may have a certain definite pitch. From this value, the well-known formula for vibrating strings allows the calcu-

lation of the tension per square millimeter of cross section, a tension which is proportional to L^2 . The inventor believes the device will be of important service in aviation. It indeed permits the regulation of the tension of each wire of an aeroplane and further allows one to see how to vary that tension in the tests made in the work shop. Such tests would consist in overturning the aeroplane and scattering sand uniformly over the wings sufficient in amount to produce the equivalent wind pressure in flight. Then by means of this tensiometer each wire would be tested and the weak parts consequently found.

The journal *La Technique Moderne* in 1910 opened an inquiry into the fatigue of metals. The replies received to the questions have not always been concordant, but Charpy, after analyzing and discussing them, believed he could state the following conclusions: First, the alteration in the metals remains negligible until the deformation passes a certain limit; second, the cause of the alteration is almost always a local and progressive condensation and hardening. Consequently it is important to so determine the dimensions of the piece as to avoid permanent deformation at certain points; third, a close examination of the form and appearance of each piece tells when it is becoming bad. The quantity of metal must be determined with care for all parts of the construction. It is necessary to avoid all alterations at the moment of putting the apparatus into operation and to be sure that each piece keeps its integral form so as to prevent any necessary accidental and haphazard repairs. The rigorous application of these rules will doubtless avoid those catastrophies which we so much deplore.

Along the same line, Boudouard sought to see whether the alteration in metals could not be revealed by the study of the damping of their vibratory movements. A sufficiently long vibratory movement finally ruptures a piece of metal. Boudouard found that the number of vibrations necessary for rupture varied inversely with the carbon content of steel. Up to the present, however, he has not succeeded in showing clearly the relation of the microscopic structure to the damping.

It has been known for a long while that a metal could be easily cut with a circular saw without teeth provided the disk had a sufficiently rapid rate of rotation. This process has received a new application in the Ryerson Laboratory at Chicago. A saw 1.32 meters in diameter, turned by a dynamo of a 100 horsepower at 2,000 turns per minute, cut in two 610 millimeters of T iron. The saw, made of steel, turned in an envelope in the interior of which the saw was constantly bathed with cold water and the sheaf of sparks was caught in a trough of water at the side of the machine. The cut metal seemed to undergo a real fusion due to the intensity of the heat developed from the friction. The feeble heating of the saw is explained by the fact

that each of its points remained in contact with the cut piece only during a very short time and during the rest of the rotation was either in the air or in a copious water bath.

VII. THE SCIENTIFIC ORGANIZATION OF THE WORKSHOP.

Under the title, "The principles of the scientific organization of work shops," the American engineer, Taylor, the well-known inventor of the rapid-cutting steels, has published an interesting treatise, a French translation of which with a preface by H. Le Chatelier, member of the institute, has just appeared. Taylor discusses the means of augmenting the output of workshops without increasing the fatigue of the workmen. He shows that the product of each workman depends upon a great number of independent factors, amounting, for example, in the case of metal turning to 12, and that the workman by simple trials can not discover the most advantageous values of these factors. The study of the working of metals alone cost Taylor 1,000,000 francs (\$193,000) and 25 years of experience. That was a very complicated case. A much more simple method and one indicating the purpose of the author is the following: In taking his bricks and mortar and putting them in place, a mason customarily makes five times as many movements as are necessary. By modifying the scaffold and freeing the mason from unnecessary steps in these maneuvers the product was tripled in Philadelphia.

Belot, the state director of manufactures, is busy with the systematic organization of manufactories. An article by him in *La Technique Moderne* gives the following principles which are the result of his observations: First, the principle of discontinuity. Each time there is a discontinuity in the speed of the circulation of matter under construction there will be a diminution of the industrial output of the machine or mechanical combination under consideration and that diminution will be proportional to the variation of speed. Second, the principle of best speed and of the mean maximum delivery. In a machine or a work shop the size and the speed of a mechanical cycle used will be determined by the best speed for the process in use, and the number of cycles will be determined by the mean maximum delivery to be realized.

It is desirable that the attention of workshop foremen be brought to questions of this kind, which are of the utmost importance and the solution of which should not be left to chance



FIG. 1.—STROMBOLI FROM THE SEA. ERUPTION OF 1912.

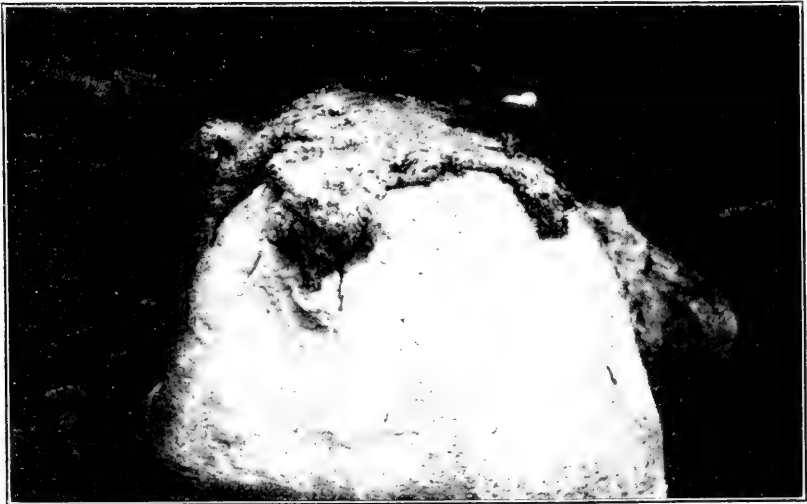

FIG. 2.—MASS OF PLASTIC LAVA FALLEN ON A ROCK, 1907.

REPORT ON THE RECENT GREAT ERUPTION OF THE VOLCANO "STROMBOLI."

By FRANK A. PERRET,¹

Volcanologist to the Volcanic Research Society of Springfield, Mass.

[With 9 plates.]

I have the honor to present, as you requested, the following report on the recent remarkable eruption of Stromboli, and particularly for the following reasons:

1. This eruption, together with the last one in 1907, differs so greatly from the characteristic activity of Stromboli as to mark a new era in the volcano's eruptive habit.

2. The eruption, although certainly the greatest in many years and imperiling the lives of the 5,000 inhabitants of the island, passed almost unnoticed by the press.

3. The writer, as well in 1907 as in the present year, was the only observer. The Italian volcanologists in both cases visited the island only after the close of the eruption.

Stromboli, at the northeast extremity of the Lipari group of islands, north of Sicily, appears as a small volcanic cone rising but 925 meters (3,033 feet) above the sea. It should be remembered, however, that what is seen is but the summit of a submarine mountain of great size and height. Its general form is shown in plate 1, figure 1, the principal characteristics being a divided and crested summit, an eccentric crater situated nearly 200 meters below the summit, a steep slope (35°) descending directly from the crater to the sea (the so-called "Sciarra del Fuoco"), and two plateaus on opposite sides of the island from the crater which form the inhabited and only habitable points.

The crater is thus invisible to the inhabitants and, while this undoubtedly contributes to their security and tranquillity, it is often, nevertheless, the cause of their ignorance of the volcano's condition especially as regards the preparatory symptoms of an eruption. The old semaphore station on Punta Labronzo was well placed for observation but was abandoned after the Calabrian earthquake of 1905, by which it was badly damaged. The new station above the town of San Vincenzo is not in sight of the crater

¹ Report to Mr. Handley, American consul at Naples, Italy, Oct. 26, 1912, transmitted to the Smithsonian Institution by the Department of State Dec. 30, 1912.

During the present generation the normal activity of this volcano has, until the events herein described, consisted of a moderate but almost continuous form of eruption with jets, at frequent intervals, of incandescent fragments of lava yielding an illumination so regular and brilliant as to have earned for Stromboli the title of "Lighthouse of the Mediterranean." There was no crater, properly so called, but a shallow depression where a crater should have been—that is, undoubtedly a filled-up former crater—with a number of small eruptive mouths generally arranged along the edge of the depression toward the sea. It will be seen that I do not claim that the present great crater, as described below, is a new thing in the life of the volcano, but that it is new to the present generation.

In the spring of 1907 the normal activity was broken by an eruption of great violence, which threw the inhabitants into a state of panic. The explosions were so sharp that the air concussion broke nearly every window on the island. The lava was thrown out in large masses so hot as to retain its plasticity and be conformed to the surface upon which the mass fell, as shown in plate 1, figure 2. The eruption lasted several weeks and produced a true crater 200 meters in diameter, and the eruptive mouths, with no exception, were sunk to the bottom of this abyss.

That they still existed and acted as separate mouths was proven by the varied character of the explosions and the different time intervals. There was also a most interesting rhythmic change from a type of explosion with the lava high in the conduit and in free contact with the atmosphere, when the cloud of ejected materials consisted of incandescent lava fragments (bombs) and clear vapors, to the opposite type of dense black volutes of ash from the collapsed wall material as the lava column sank below its former level. The difference between the two forms of explosion, known technically as "Strombolian and Vulcanian," was even more clearly defined in the eruption of 1912 and is clearly shown in plate 2. A considerable emission of ash having a strongly acid reaction ruined the grape crop for that year (1907) and the unfortunate inhabitants besought the Government, through the local municipal delegate, Signor Famularo, to send ships in case it seemed necessary to abandon the island. A cruiser, the *Piemonte*, and several destroyers were sent and it fell to me to assume the grave responsibility of assuring Commander Presbitero that the culmination of the eruption was passed and that, although some minor revivals of activity were to be expected, there was no further cause for alarm. Upon the strength of this he received permission from the Government to withdraw his ships.

A brief account of this eruption was published in the Bulletin of the Brooklyn Institute of Arts and Sciences. This eruption of 1907 left, as I have stated, a deep crater 200 meters in diameter and was

followed by a long period of almost complete repose, this constituting quite a radical change from the foregoing habit of Stromboli and imitating the *modus operandi* of other volcanoes, such as Vesuvius and Etna. During this period not the least glimmer of light was to be seen at the crater and when I again visited the volcano in 1909 it was still in a state of quiescence. In this connection a fact of general interest may be mentioned. Some years previous to this time a project was on foot to erect a lighthouse upon "Strombolicchio." This is a monolith of lava (pl. 3, fig. 1) rising 50 meters above the sea at a short distance from the island. In my opinion it is a volcanic "neck;" that is, the solidified lava which existed in the conduit of a small volcano formerly active on this spot, the cone of which, formed of fragmentary materials, has been destroyed by centuries of weathering, leaving the solid core as a monument to its former existence. A flight of steps was cut from the sea level to the top and the top itself was leveled, but the project was abandoned, as I am informed, precisely because the illumination from Stromboli formed a better lighthouse than any which could be constructed by man. Upon the failure of the volcano a light was needed and a lighthouse is now to be erected upon Strombolicchio.

The eruption of July–August, 1912, was, on the whole, greater than its predecessor and was initiated by a continuous series of violent local earthquake shocks. These undoubtedly were due to a conduit partly obstructed by lava which had consolidated therein. This was ejected in solidified form, as contradistinguished from that of 1907, in irregular blocks of all sizes up to two meters in diameter. One of these, shown in plate 3, figure 2, fell 500 meters distant from the crater. The rock is a compact, basaltic lava containing a considerable proportion of olivine.

Besides this rock the chief product of this eruption was the enormous quantity (for Stromboli) of ash. This reached a depth of over 2 meters on the upper parts of the mountain, as shown by the photograph (pl. 4) of a stone shelter built near the summit to shelter observers of the target practice of the fleet. In the towns the flat roofs were covered to a depth of 6 to 8 centimeters and, in contrast to that of 1907, this ash was alkaline but no less fatal to green vegetation. As long as the fallen ash remains dry it is harmless and a heavy rain is innocuous, as it washes the ash from the leaves, but if the ash on the leaf is moistened by the dew or a few drops of rain the soluble materials are extracted and attack the leaf, generally affecting one or more sectors, as shown in plate 5.

From the standpoint of the volcanologist, the most interesting feature of this ash is the fact that it is constituted almost entirely of new material—i. e., it was formed directly from liquid lava by inter-

molecular gaseous expansion and not by the crushing of old rocks nor by the collapse of crater walls. This forms a striking example of the process of ash making as described in a paper by the present writer entitled "Volcanic vortex rings and the direct formation of ash from liquid lava" and which appears in the November issue of the American Journal of Science. During this eruption the explosions, although very powerful, were not sufficiently sharp to produce the phenomenon of the "flashing arcs" as observed by me at Vesuvius (1906) and Etna (1910) and described in the American Journal of Science.

In addition to the solid blocks and the ash, a very large quantity of porous, vitreous scoriæ or "lapilli" were ejected. These were of the same material as the ash and containing in some cases inclusions of already formed crystals of angite. In falling, they were still plastic to the extent of conforming to the forked branches of the *Genista* plants and even to be impaled upon the spines (pl. 6).

This eruption was very instructive. A careful study was made of the great "mushroom vortices" (pl. 7, fig. 1), by whose mechanism heavy rocks are carried to a great height and then thrown to a distance by the vortex whirl.

Some idea of the crater, 300 meters in diameter, of this eruption may be had from plate 7, figure 2.

On several occasions, including the present one, the writer has been completely enveloped for 15 or more minutes at a time in the cloud of gas and ash proceeding directly from the crater of a volcano during a paroxysmal eruption. In every case there was no noxious gas—no HCl, SO₂, H₂S, CO₂—in perceptible amounts, although these are present in distressing quantities during phases of minor activity. The conclusion is inevitable that the paroxysmal gases—i. e., the gases which produce a great eruption and which have been the cause of the formation of volcanoes—consist mainly of the same ingredients as atmospheric air. Under the above mentioned circumstances I have found only a slight feeling of oppression, which may be due to the high temperature or possibly to a slight deficiency in the proportion of oxygen due to oxydations during the subterranean travel of the gases.

These two eruptions prove that Stromboli shares in the general increase of activity of the Italian volcanoes.

Mount Etna is preparing for a great eruption.

DATA OF THE ERUPTIONS 1907 AND 1912.

1. The ash of 1907 was acid, that of 1912 alkaline, both noxious to green vegetation.
2. The paroxysmal crises of both eruptions corresponded with the luni-solar phases, to which Stromboli is very sensitive.

3. The ash emission of the 1912 eruption was accompanied by strong electrical manifestations, the volcanic lightnings being vivid and almost incessant.

4. The products of the fumaroles of this eruption, collected by the writer and analyzed by Dr. Henze, of the Naples Aquarium, consist principally of Al, Fe, and Mg, combined with H_2SO_4 and HCl. Their gaseous emanation, as tested on the spot, was chiefly SO_2 and a trace of H_2S .

5. The eruptive months are six in number and have been designated by the writer with the letters A. to F, inclusive.

6. The eruption proper lasted from July 22 to August 14, 1912.

7. The crater of 1907 was 200 meters in diameter, very deep, and the throat of the volcano was left quite free, permitting the gases to escape quite continuously after the eruption.

8. The eruption of 1912 enlarged the former crater to 300 meters and left it partly filled with collapsed cone material. This tends to confine the gases until they break through at intervals and form an ash cloud, giving the impression of a greater activity than really exists.

9. The paroxysmal gases, as at Vesuvius in 1906, had approximately the composition of atmospheric air.





FIG. 1.—"STROMBOLIAN" EXPLOSION, 1912.



FIG. 2.—VULCANIAN EXPLOSION, 1912.

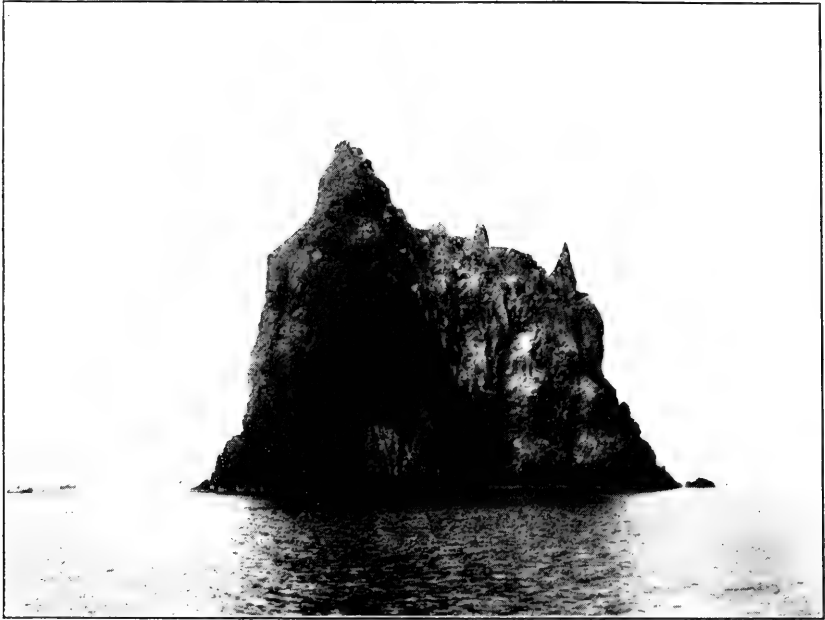

FIG. 1.—VIEW OF "STROMBOLICCHIO."



FIG. 2. LAVA ROCK THROWN 500 METERS DISTANT FROM CRATER.



STONE SHELTER BURIED BY THE ASH OF 1912.

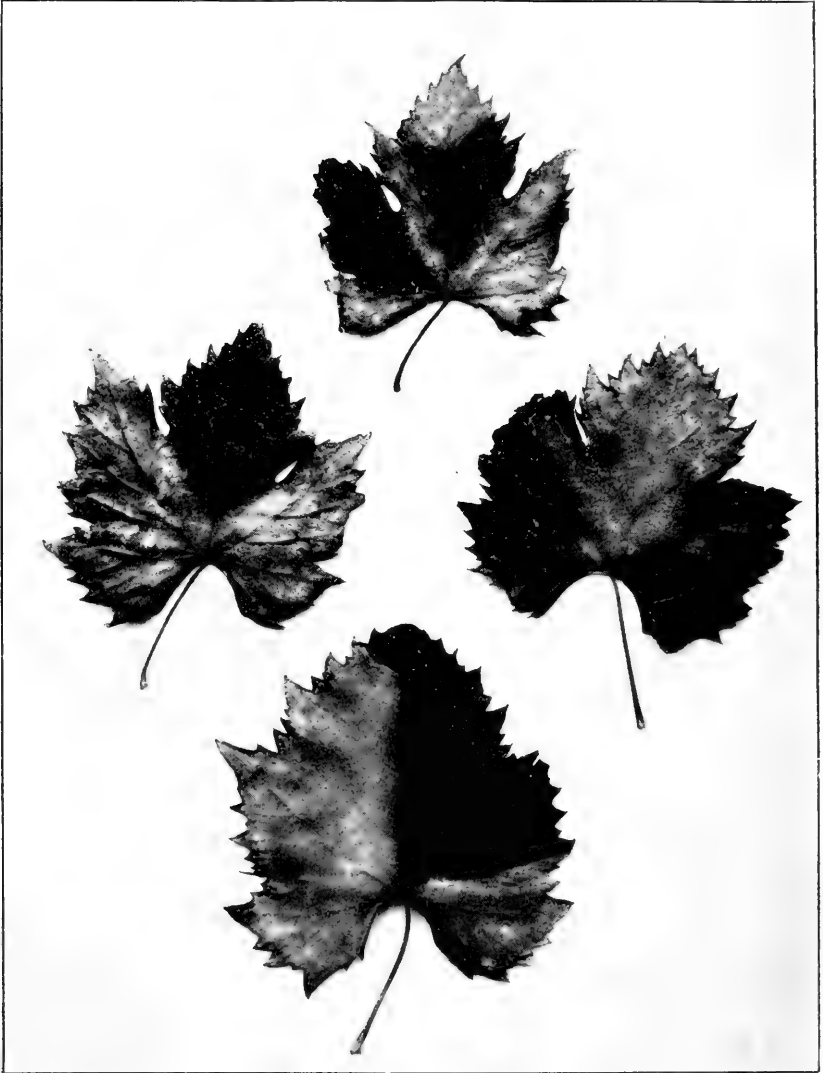

DAMAGE TO GRAPE LEAVES BY THE VOLCANIC ASH. ERUPTION OF 1912.

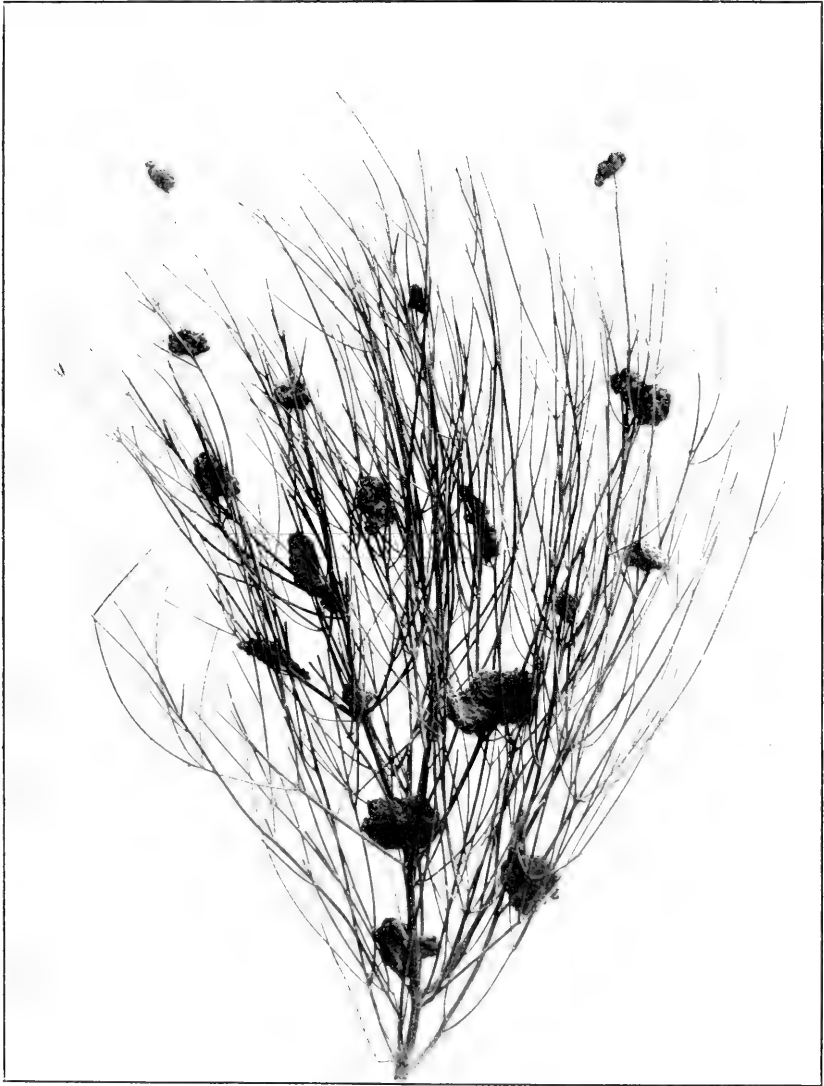

VOLCANIC "LAPFILLI" FALLEN UPON GENESTA. ERUPTION OF 1912.



FIG. 1.—MUSHROOM VORTEX.



FIG. 2.—LOOKING DOWN INTO THE GREAT CRATER OF 1912.

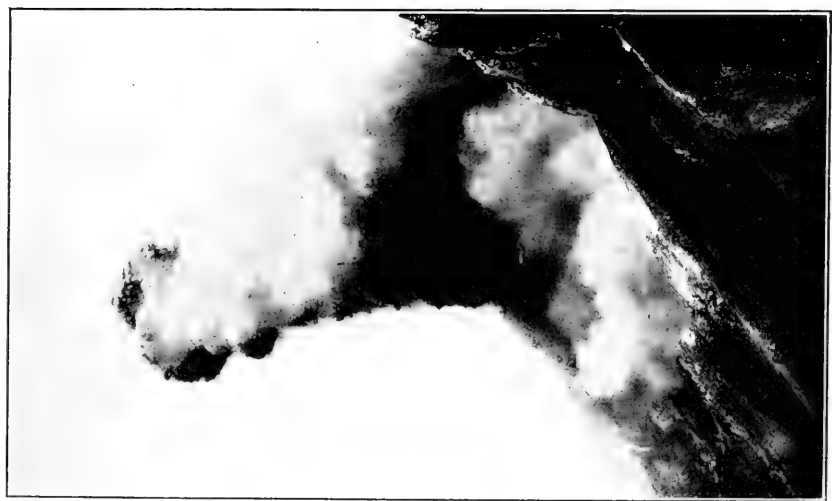

FIG. 1.—AN EXPLOSION FROM ONE OF THE CRATER MOUTHS.



FIG. 2.—AT THE EDGE OF THE CRATER AFTER THE ERUPTION OF 1912.



FIG. 1.—LOOKING UP FROM SAN VINCENZO,
STROMBOLI.



FIG. 2.—STROMBOLI, 1912. NEAR VIEW OF THE
CRATER IN ACTION.

THE GLACIAL AND POSTGLACIAL LAKES OF THE GREAT LAKES REGION.¹

By FRANK B. TAYLOR.

GENERAL STATEMENT.

The Great Laurentian Lakes, or the Great Lakes, as they are commonly styled, are a group of valleys which have been turned into lakes. Geologically speaking, the lakes themselves are new and youthful forms, although the valleys in which they lie are much older.

The basins of the Great Lakes were once valleys with free drainage and no lakes, like the Ohio Valley of to-day. The events which changed them into water-filled basins were apparently associated with the glacial period, and are therefore of relatively recent date. It is the later part of the Great Lakes history, comprising the glacial and postglacial epochs, that has engaged the attention of students most, because the facts relating to that part are the newest and most numerous. But in any comprehensive view, the fact should not be overlooked that the Great Lakes, or rather the basins in which they lie, had a long and complicated history before the glacial period and also a complex interglacial history. Only the main outlines of the earlier epochs are known at the present time, and it will suffice to enumerate them here briefly.

PREGLACIAL HISTORY OF THE VALLEYS OF THE GREAT LAKES.

PHASES OF DEVELOPMENT.

The preglacial history of the Great Lakes is simply the geological history of the region. For convenience it may be divided into three epochs, each one dominantly, though not exclusively, characterized by a particular phase of development. The first was the epoch of sedimentation or Paleozoic strata building—the constructional epoch;

¹ Published by permission of Director of the U. S. Geological Survey. This paper is an advance publication of Chapter XII of a monograph on Pleistocene deposits and glacial lakes of Indiana and Michigan, by Frank Leverett and Frank B. Taylor, U. S. Geol. Surv. Mon., vol. —, in press. This was not originally intended for separate publication, and inasmuch as it is merely an outline of the lake history, full and specific credit is not given here for the work of each of the several geologists who have materially contributed to the elucidation of this complex history. Such due acknowledgment will be found included with the complete discussion of the phenomena in the monograph.

the second was the epoch of land elevation, causing increase of altitude and inaugurating erosion—the epoch of emergence, and the third was the epoch of erosion or valley making—the destructional epoch. These three epochs are not sharply and completely marked off from each other, although they may appear to be so in some parts of the Great Lakes area. For example, in the northwestern part, uplifts producing emergence of land areas occurred while in much of the region of the lakes farther east, sedimentation was still going on uninterrupted. Whatever land was then raised above the sea was attacked by the forces of erosion. Thus, to some extent, sedimentation, elevation, and erosion were all going on at one and the same time. But the successive dominance of the three processes distinguishes fairly well the three phases of development

OUTLINE OF GEOLOGICAL HISTORY OF GREAT LAKES REGION.

It is well known that the basins of the Great Lakes lie chiefly in depressions that were formerly filled and completely occupied by Paleozoic strata. While these strata were being laid down the whole region, excepting, perhaps, part of the Archean area south of Lake Superior and some parts of the plateau north of the Great Lakes, was under the sea. The rocks that filled these basins have very different characters in different beds. There are conglomerates and sandstones, shales and limestones, and in some places igneous rocks. Each one of these classes of rocks has many varieties with more or less variation in hardness and chemical properties, and these qualities exercised an important influence upon the rate and manner of disintegration under the forces of erosion. The formation of the Great Lakes basins has thus been dependent to a large degree upon the character of the strata out of which they have been excavated—upon their relative hardness, thickness, and arrangement.

This was the constructional period in which nature was getting ready for the subsequent making of the lake basins. The basins themselves, however, did not begin to be made until another great event in geological history had taken place—not until a change occurred in the relative attitude of the land and sea. Beginning at the close of the Paleozoic era there came an epoch of great earth movements affecting all of the eastern part of North America, including the whole of the Great Lakes region. In consequence of this the land now occupied by the lakes was lifted out of the sea to an altitude estimated by some to be relatively 2,000 or 3,000 feet higher than its present altitude. This was the time of the uplifting and folding of the Appalachian Mountains. This process probably occupied some thousands of years, but in a geological sense it was a relatively short time.

There is evidence, also, that there were some earlier movements of less extent affecting the region of Lake Superior and the northern part of Lake Huron especially, which probably made land surfaces of limited extent before the great movement which elevated the whole region.

THE MAKING OF THE GREAT LAKE VALLEYS BY STREAM EROSION.

The forces of subaerial and stream erosion attacked the surface of the land as fast as it was raised above the level of the sea, and the sea itself, with its waves and tides and currents, attacked the new land all around its shores. Rain and frost, wind and sunshine and the various agents of chemical decomposition attacked every part of the new land surface. Most effective of all was the water that gathered into flowing streams. All of these, great and small, did their share in tearing down and sculpturing the new land—in carving valleys, hills, and mountains out of the elevated mass. Each one worked with an efficiency dependent upon its volume, the rate of its descent, the character and quantity of sediment carried and upon other factors. The first shapes of the newly emerged land determined the first drainage systems, but as the work of erosion went on the effects produced were greatly influenced by the variously resistant characters of the rocks and their relative position and arrangement.

In the building of the strata out of which the lake basins have been excavated, it happened that the region now occupied by the greater part of the basins was for the most of the time not adjacent to the shores of the ancient seas so as to receive coarse sediments, but was offshore some distance from the land, so that the sediments received were mainly of fine texture, mud which afterwards became shale, and limy ooze which afterwards became limestone. Conglomerates and sandstones indicating shore conditions or shallow water near shore occur, but are not common in the lake basins. Limestone does not rank as a hard substance in the scale of mineral hardness, but compared to the shales it is sometimes a hard, resistant rock, especially where it occurs in massive form and in great thickness. In the building of the strata it happened that, stretching westward and northwestward from central New York to northern Michigan, there was a group of beds whose arrangement and relative hardness predisposed them to unequal erosion and the formation of valleys bounded by great escarpments. In New York the Lockport limestone of the Niagara group is a massive bed of the hardest quality, 150 to 250 feet thick, while below it are shales and sandstones—chiefly shales—much softer, but containing two relatively thin, hard layers of Clinton limestone. These lower beds are several hundred feet thick. Then, again, above the Lockport limestone, are the

very soft, marly, salt-bearing beds of the Salina formation, generally 200 or 300 feet in thickness. The selective processes of erosion led the streams to attack the softer strata with greatest effect, while the harder limestone resisted and formed the great escarpment which now characterizes it, from New York to Wisconsin. Extensive valleys were eroded in the soft rocks below it and the limestone ledge was driven back as fast as it was undermined. Other valleys were also excavated in the soft shales above.

Thus, Lake Ontario, Georgian Bay, the northern channel of Lake Huron, and Green Bay were excavated out of the soft rock below the limestones of the Niagara group, while Lake Erie, the main body of Lake Huron and all of Lake Michigan were excavated out of the soft strata above the limestones. Lake Superior appears to be somewhat exceptional. It is thought to be largely an original rock basin, or perhaps a syncline out of which the soft rocks have been eroded. These softer rocks were probably mainly those that lie below the limestone of the Niagara group.

Thus, the shape and size and arrangement of the lake valleys were primarily dependent upon the geological structure—upon the relative position and thickness of the soft beds and the distribution of their exposed parts. Where the soft beds were exposed to effective stream erosion they were removed more rapidly than the harder rocks, and thus became the main valleys of the region.

In the present attitude of the land the Paleozoic strata dip distinctly but gently southward in the basin of Lake Ontario; south in the eastern part of Lake Erie, and southwest and west in its western part; toward the southwest in the main part of Lake Huron, but toward the south in the northwestern part of this basin; toward the south in the northeastern part of Lake Michigan, toward the east in the southern part, and toward the south in the peninsula east of Marquette, while farther west the older rocks bordering Lake Superior on the south dip steeply northward toward the axis of the basin and the dips are various in other parts.

That these valleys were going through the process of development by erosion during practically all the time from the close of the Paleozoic to the beginning of the glacial period seems not improbable. Indeed, the time must have been very long to have made such extensive valleys by so slow a process. It might be thought that some movement of elevation or tilting had turned these old valleys into lake basins long before the time of the Ice Age, but no certain evidence indicating such a change has been found. Up to, or nearly to, the beginning of the Ice Age the valleys appear to have had complete drainage by rivers and held no lakes.

THE GREAT LAKE BASINS IN THE SUCCESSIVE GLACIAL AND INTER-GLACIAL EPOCHS.

The glacial period as a whole has been found to be made up of four (or possibly five) distinct epochs of glaciation separated by intervening warm periods when the ice sheet either shrank to relatively small proportions or disappeared altogether. The last ice sheet deposited what is known as the Wisconsin drift. It seems certain that the depressions which constitute the lake basins were involved in each one of the several glacial epochs, and yet all the basins, excepting perhaps that of Lake Superior, retain very distinct characters which belong to stream-eroded valleys. Indeed, except for the drift deposits and effects produced by tilting, it may almost be said that they show no other characters. All the changes produced by the several glacial invasions have not destroyed these characters nor obliterated them to any great extent. In fact, when the last ice sheet crept from the north down into the lake basins it appears to have found them in almost every detail the same as they are to-day.

No doubt the events of the lake history which occurred during the advancing phase of the last ice sheet, as well as in the earlier glacial epochs, are matters which would be of great interest and importance if they were accessible; but they seem destined to remain in obscurity, because the record made by the ice at the climax of each minor movement of advance was continually being overridden and obliterated by later and more energetic readvances; and, further, in the region of the Great Lakes the drift sheets of the older glacial epochs were almost entirely overridden by the later ones.

THE GREAT LAKES DURING THE RETREAT OF THE LAST ICE SHEET.

The foregoing is a brief outline of the complex history of the Great Lakes down to the time of the maximum extension of the last or Wisconsin ice sheet. It is only when we begin to follow the retreat of this ice sheet across the lake region that we come upon that later phase of the lake history which is so clearly and completely recorded in the present surface deposits. This part of the history is spread out upon the surface of the lake region like an open book. An immense body of facts has been gathered bearing upon it and this gives us a fairly full knowledge of its details, with the promise, through continued exploration, of still more detailed knowledge.

This part of the lake history has its own complexities and these arise from several different causes. First, from the oscillating manner of the ice retreat, which was accompanied by many periodic minor movements of retreat and readvance; second, from the irregularities of topography which characterizes the lake region; third, from the direction of the general retreat of the ice across the lake

basins; and, fourth, by differential elevation of the land during and after the ice occupation, the maximum elevation occurring in the north and producing several changes of outlet.

The combined effect of these and other less important factors produced a complex history, not only as expressed by the distribution and relations of the various drift forms, but also by the remarkable effects of the ice sheet upon the associated drainage. It determined the location of great rivers which flowed only temporarily from the ice or along its border and produced remarkable shiftings of their courses. Its most noteworthy effect, however, was the production of a complex succession of shifting and changing lakes—enlarging, falling, shrinking, combining, dividing, and rising lakes—of large extent, with frequent changes of outlet, and coming at last to the lakes as we find them to-day. As investigation has inclined more and more to details and has covered an area of increasing extent, it has been found that the succession of changes involved in the later lake history is much more complex than was formerly supposed.

THE SHRINKAGE OF THE ICE SHEET INTO THE LAKE BASINS.

In one of its earlier epochs (the Illinoian) the ice sheet covered the entire region of the Great Lakes, the only exception being the well-known driftless area which lies chiefly in western Wisconsin. This area is in the angle between Lake Michigan and Lake Superior, but does not comprise any part of the drainage basin of either one of them. As the ice sheet moved southward the lake basins naturally offered the easiest lines of flow and the high lands between the basins were areas of greater resistance and slower flow. But when the ice attained its maximum, reaching nearly to Cairo, Ill., some 20 miles across the Ohio River at Cincinnati, and to Beaver Falls, Pa., the lake basins became relatively unimportant in their effect upon the ice movement, for at that time the ice overwhelmed them all, including even the high lands between them. As it retreated, however, the relative importance of the lake basins in controlling the ice flow increased rapidly and by the time the ice front had withdrawn to the most southerly points of the watershed of the lake basins it had taken on lobate forms of a most pronounced type. In the latest or Wisconsin epoch of glaciation the farthest extension of the ice did not reach so far south in the region west of central Ohio as it had before. In Illinois it reached only about half way from the shore of Lake Michigan to the Mississippi and Ohio Rivers. Beyond this the older drift shows now only occasional ridgings suggesting terminal moraines. The great moraine system which is conspicuously related to the basins of the Great Lakes belongs to the Wisconsin or latest glaciation. As the ice drew back, each lake basin, at the time of most pronounced lobation, had its ice lobe which conformed to the outlines of its

southern part with remarkable fidelity. The moraines laid down along the margin of the lobes at this stage are roughly concentric with the basins and nearly parallel with their southern shores. A diagrammatic representation of the outline of the ice border at several successive positions is given in figure 1.



FIG. 1.—DIAGRAMMATIC REPRESENTATION OF SUCCESSIVE POSITIONS OF ICE BORDER.

By Frank Leverett and Frank B. Taylor, 1910. (Data for eastern Wisconsin from Alden and Weldman.)

COMPLEXITIES OF LAKE HISTORY CAUSED BY STADIAL OSCILLATIONS OF ICE FRONT.

The periodic oscillations in the retreat of the Wisconsin ice sheet introduced a peculiar complexity into the lake history. The stronger or principal recessional moraines, called stadial moraines, mark relatively long intervals of time—several hundreds of years, perhaps more than a thousand. Each whole period of oscillation is involved

in a stadium and a stadial moraine marks the forward climax of one of these periods. The readvance to each stadial moraine covered a very considerable distance, certainly in some cases 25 to 50 miles and perhaps twice as much. The long intervals of time between these moraines account perhaps to some extent for the commonly observed discordant relation between them. Each stadium in turn is marked at periodic intervals by weaker moraines which are superposed upon the stadia. These mark subsidiary halts or perhaps slight readvances, and there is a numerous series of them in each stadium. There was, however, only a slight movement of readvance associated with these minor stadial moraines, and they record less strongly marked and shorter periodic climatic variations.

The most important oscillatory variation in the retreat of the ice, so far as its effect on the lake history is concerned, is the stadial oscillation. Its relatively long period and the wide space covered each time by the movement of readvance make it the chief cause of complexity, for after lakes were lowered by a retreat of the ice the stadial readvance was likely to close the outlet last opened and reelevate the lake to a higher level. Three times, certainly, and perhaps four or five times, this kind of change affected the waters of the Huron-Erie-Ontario basin. During several oscillations the ice front stood in critical relations to the land barriers that held up the lakes and changes of relatively slight amount in its position opened or closed outlets and changed the level of the lake waters.

Considering the apparent character of the glacial oscillations, it seems necessary to take account also of the halts of the ice front at the backsteps or climaxes of retreat. These probably affected the lakes and lasted as long as did the halts on the stadial moraines which mark the climaxes of advance. In one case at least there is remarkably clear and complete proof of the long duration of a particular lake stage which existed during the pause at a backstep or climax of retreat.

BRIEF OUTLINE OF THE GREAT LAKES HISTORY DURING AND AFTER THE RECESSION OF THE LAST ICE SHEET.

THE FIRST SMALL LAKES.

As soon as the ice front withdrew to the north side of the southern watershed of the Great Lakes, small ice-dammed lakes began to be formed. In Ohio a number of such lakes appeared along the north side of the divide south of Lake Erie. It seems a necessary inference that in consequence of the stadial oscillations of the ice many of these earliest small lakes were first formed at an extreme position of retreat and then overridden and obliterated by the next readvance. Indeed, in some cases this may have occurred two or three times before the

early beginnings of the larger lakes became well established. There is some evidence of this sort of development at Fort Wayne, Ind.

The earliest small lakes discharged at first southward independently through several gaps in the divide; a little later they fell to lower levels and discharged westward to a lower gap, and finally into the first small, narrow representative of glacial Lake Maumee. Mr. Leverett has already described these earliest lakes in Ohio.¹ Others of somewhat similar origin were formed along the east side of the Lake Michigan basin. Winchell² has described a series of small lakes that preceded the larger lakes in the western end of the Lake Superior basin.

So far as has been made out by the study of the moraines, especially with reference to their continuity from one basin to another, there seems to have been very little difference in the time when the larger lakes began to form in the western end of the Lake Erie and the southern end of the Lake Michigan basins. When the ice front had withdrawn to a position a few miles north of the watershed at the south end of Lake Michigan and was building the later members of the lake-border group of moraines, there was a long, slender, crescent-shaped lake between the ice and the land. This was the beginning or first stage of the glacial Lake Chicago (fig. 2, position M). Similarly, when the ice front had retreated to a position a little east of the watershed at Fort Wayne, Ind., another long, narrow, crescent-shaped lake, called glacial Lake Maumee, was formed between the ice and the land. If the moraines have been rightly interpreted, these two lakes came into existence at about the same time. A third lake of the same kind was formed in the same way at the western end of the Lake Superior basin, when the Lake Superior ice lobe first shrank within the line of the watershed west of Duluth. The time of its first appearance relative to the first lakes formed at Chicago and Fort Wayne is shown by Leverett's work in 1910 to be considerably later.

Two small lakes, formed probably at about the same time as Lakes Maumee and Chicago, gathered in front of the Green Bay lobe of the ice sheet in Wisconsin and discharged, the one southward to Rock River and the other southwestward to the Wisconsin River. These lakes, however, did not have an independent existence long. They soon united in one body and when the retreating ice opened a passage eastward to the basin of Lake Michigan, merged with Lake Chicago.

From these four relatively small beginnings there grew a series of glacial lakes the like of which, for size and complicated history, is

¹ Leverett, Frank, Glacial formations and drainage features of the Erie and Ohio basins, Mono. U. S. Geol. Survey, vol. 41, 1902, pp. 610-611.

² Winchell, N. H., Glacial lakes of Minnesota: Geol. Soc. Am. Bull., vol. 12, 1901, pp. 109-128, 1 pl.

not known in any other part of the world. The total area covered by their waters from first to last was much greater than the entire area of the present Great Lakes, but the whole area was not covered at

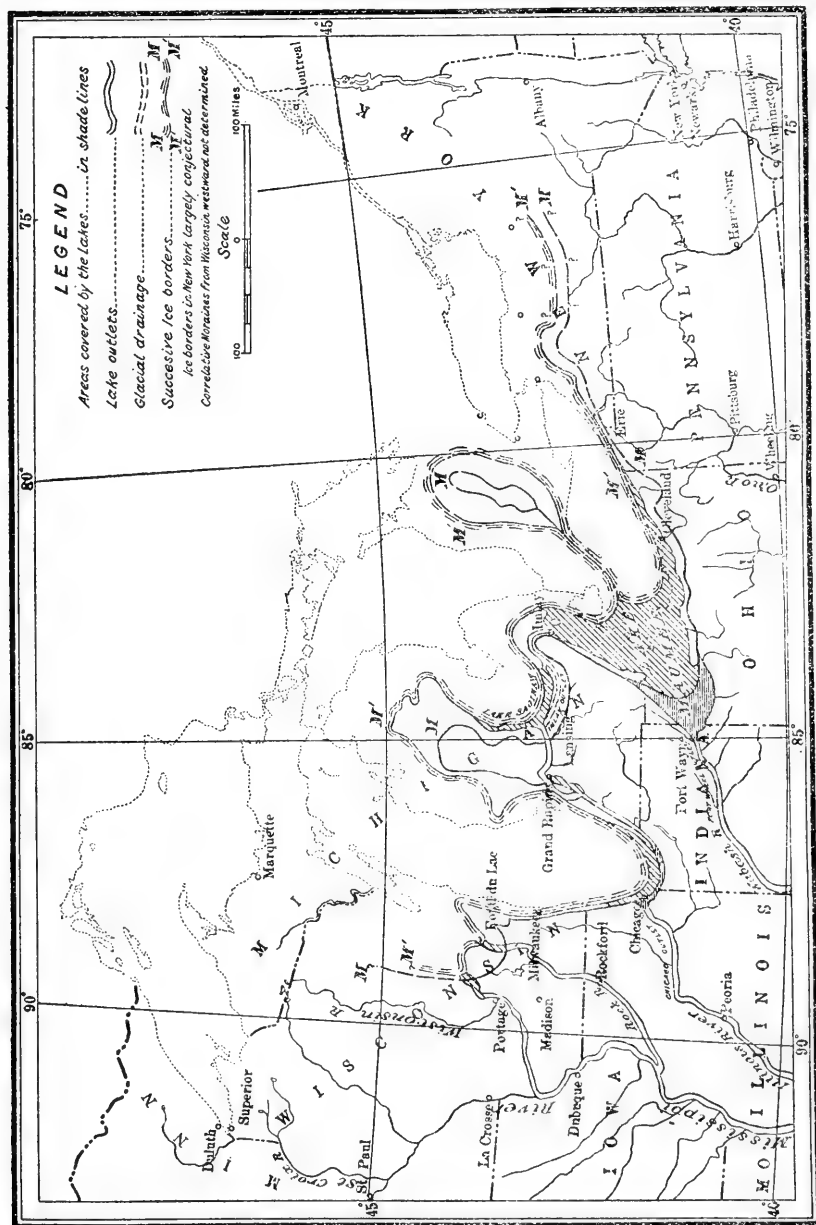

FIG. 2.—GLACIAL LAKES MAUMEE, SAGINAW, AND CHICAGO.
By Frank B. Taylor and Frank Leverett, 1910.

any one time. Only one glacial lake of larger size is known to have existed; this is Lake Agassiz, which overspread northwestern Minnesota, northeastern North Dakota, and a great area in Manitoba and

Saskatchewan. The history of Lake Agassiz appears to have been very simple in comparison, for the basin which it occupied was sim-

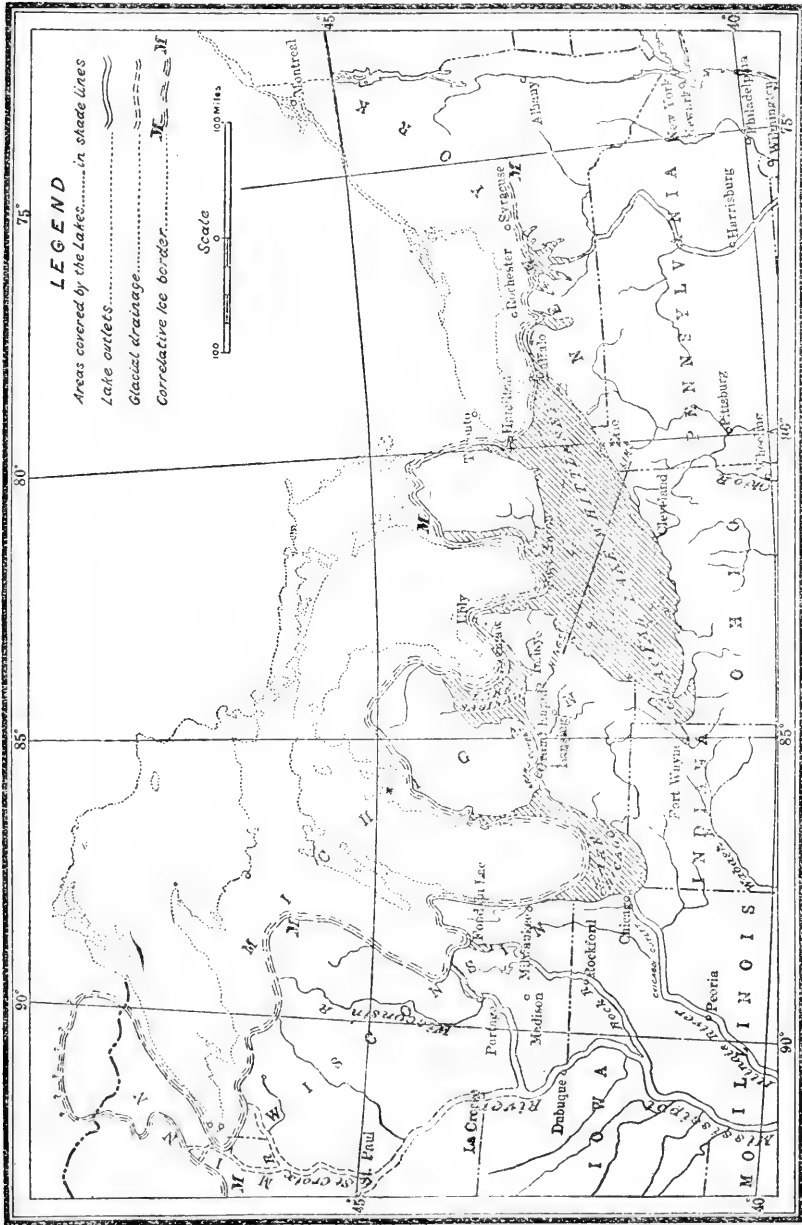

FIG. 3.—GLACIAL LAKES WHITESEY, SAGINAW, AND CHICAGO.
By Frank B. Taylor and Frank Leverett, 1910.

pler in form and the relations of the ice sheet to it were much less complicated.

GLACIAL LAKES OF THE HURON-ERIE BASIN.

The lowland which stretches from Lake Huron southward to Lake Erie was abandoned by the ice sheet in the middle stages of the development of the glacial lakes, but continued to be covered by the lake waters, so that the waters in the southern part of the Lake Huron basin were joined with those in the basin of Lake Erie as one, and at a later stage this extensive lake was further expanded so as to cover the western and southwestern parts of the basin of Lake Ontario.

The succession of lakes in this basin is more complex than in any other part of the lake region. These complexities grew out of several different causes: (1) The configuration of the chief elements of relief, relatively deep basins separating the higher lands, and the position and varying altitude of the watershed south of the lakes; (2) the general direction of the glacial retreat and the trend of the ice front with reference to these features; (3) the stadial oscillations of the ice sheet during retreat, comprising not only periodic movements of retreat and halt, but also alternating movements of readvance over relatively wide intervals of space; and (4) (especially in the later stages) the tilting or northward differential elevation of the land. The stadial readvances introduced the greatest element of complexity and produced their effects chiefly by closing outlets and raising the level of the waters. This occurred repeatedly after the waters had been lowered not long before by a movement of retreat.

South of a line passing about 5 miles north of Birmingham, Mich., and through Ashtabula, Ohio, the old beaches of the Huron-Erie basin are all horizontal; north of it they rise gradually toward the north-northeast. The area south of this "hinge" line is known as the *area of horizontality*. The succession of lake levels within this area is shown in the table below. The order of occurrence on the slope is shown by their altitude in feet above sea level, beginning with the highest; their order in time is shown by the numbers on the left. The beaches that were submerged and modified by a rise of the lake level due to a readvance of the ice are put in italics.

1. First or highest Maumee, 790 feet.
3. Middle or main Maumee, 780 feet.
2. *Lowest Maumee*, 760 feet.
5. Whittlesey, 735 feet.
4. *Arkona*, 710-694 feet.
7. Warren (Forest), 680 feet.
6. *Wayne*, 660 feet.
8. Grassmere, 640 feet.
9. Lundy (Dana, Elkton), 620 feet.

LAKE MAUMEE.

Lake Maumee had at least three distinct stages, and possibly more. The stages that are clearly determined are as follows:

First stage.—As soon as the ice front retreated eastward from the moraine at Fort Wayne, Ind., it obstructed the normal northeastward drainage of the Maumee Valley, and Lake Maumee came into existence. The outlet was westward through the present site of the city of Fort Wayne, thence southwestward to the Wabash River at Huntington, and ultimately to the Ohio and Mississippi Rivers and the Gulf of Mexico. The next stadial moraine to be formed in the Maumee Valley was at Defiance, Ohio (fig. 1 and position M in fig. 2). In view of the periodicity and the wide space covered by the stadial readvances, it may be regarded as certain that when the retreating ice front left Fort Wayne it did not stop at Defiance, but receded to a point probably not less than 25 or 30 miles east of Defiance, and there halted for a considerable time before readvancing. There were also minor oscillations during both of these movements.

As the ice retreated from the Fort Wayne moraine the lake widened eastward, and long arms of water extended eastward into Ohio and northeastward into Michigan between the shrinking ice lobe and the land. Possibly the lake maintained its highest level and discharged at Fort Wayne during the climax of retreat, although this is doubtful. But during the return of the ice front to Defiance and its pause at the Defiance moraine the lake overflowed at Fort Wayne. The first stage ended only when the Fort Wayne outlet was finally abandoned.

Second stage.—At the next stage the ice front retreated a considerable distance from the Defiance moraine and opened a lower outlet somewhere near Imlay in Lapeer County, Mich. Below the upper or first beach of Lake Maumee there are two others which evidently belong to this lake. One, which is called the middle or main beach of Lake Maumee, is 15 to 25 feet below the upper or first beach, and is a normal wave-made shore line of moderate strength. The lowest beach is faint and fragmentary, and shows great modification by submergence since it was made. It is about 20 feet below the middle beach. These two lower beaches have a curious relation; counting the beaches down the slope, the third beach was made next after the first, and then the level of the lake was raised and the second beach was made at a higher level. The storm waves which made the second beach swept over the gravelly ridges of the earlier one below, as the latter lay in 20 feet of water, and almost destroyed them. Hence, when the third or lowest beach was being made the lake was in the second stage. The location of the outlet for this stage is not known with certainty. It may have passed northward a few miles

east of Imlay and thence westward into the Saginaw basin, but if so was overridden and obliterated by a readvance of the ice.

Third stage.—When the ice front readvanced it closed the outlet for the second stage, and moved westward to a position close along the east side of the great Imlay outlet channel, which passes northward just east of Imlay. This channel shows evidence of having been crowded westward by the moraine along its east side. At this stage Lake Maumee was almost high enough to overflow at Fort Wayne.

When the ice retreated from this last position it opened a very temporary outlet across Tuscola County, Mich., but it did not open a permanent new outlet until it had retreated many miles to the north, toward the north end of the Saginaw peninsula, or "thumb." The opening then made, however, allowed the lake waters to fall quite suddenly to a much lower level.

At this stage Lake Maumee reached its greatest extent, stretching from New Haven, Ind., to a point several miles north of Imlay, Mich., and on its south side to a point a little east of Girard, Pa. (fig. 2, ice border at M). In its horizontal part the third beach is 760 feet above sea level. The fronts of the contemporary ice lobes were probably a few miles east of Detroit for the Lake Huron lobe and perhaps 40 or 50 miles east of Toledo in Lake Erie. At its front the ice was therefore standing in water 150 to 200 feet deep.

LAKE SAGINAW.¹

During the later stages of Lake Maumee a lake appeared in the Saginaw Valley in front of the Saginaw ice lobe (fig. 2), and the Imlay outlet river emptied into it. At first it was narrow and crescent-shaped, but it grew larger and wider before the end of Lake Maumee. Its outlet was through the Grand River channel to glacial lake Chicago, a little west of Grand Rapids. Lake Saginaw was merged with Lake Arkona, restored to independence during the time of Lake Whittlesey, and merged with Lake Warren before its final extinction by the abandonment of its outlet.

GLACIAL LAKES OF THE HURON-ERIE-ONTARIO BASIN.

LAKE ARKONA.²

The next important stage of the ice retreat caused a still more profound change in the status of the glacial lakes. The ice withdrew altogether from the "thumb" of Michigan, so that the entire sweep of the lake waters to the eastward was allowed to fall to the level of Lake Saginaw and merge with that lake. Lake Saginaw

¹ When it existed as an independent body, Lake Saginaw was limited to the Saginaw Valley.

² The lakes preceding Lake Arkona were confined to the Huron-Erie basin and did not include any part of the basin of Lake Ontario; Lake Whittlesey, following Lake Arkona, was also limited to the Huron-Erie basin.

had at the same time expanded largely northeastward, and a strait several miles wide had opened past the end of the "thumb." This enlarged lake, which is called Lake Arkona, stretched from the vicinity of Gladwin, Mich., to some point at least 40 or 50 miles east of Buffalo, N. Y., and covered a considerable part of southern Ontario. Its outlet was westward through the Grand River channel. Its altitude above sea level was 694 to 710 feet.

West and northwest of Port Huron three beach ridges formed by this lake are known as the Arkona beaches. After they had been formed the ice front made a pronounced readvance, and before it halted it moved southward up the slope of the "thumb" to Ubyly. This movement had no effect upon the waters in the Saginaw Valley, but it raised their level over the whole lake area east of the "thumb" about 40 feet and submerged the entire extent of the Arkona beaches, excepting those parts which lay in the Saginaw Valley. (See fig. 3, with ice border M.)

LAKE WHITTLESEY.

The surface of Lake Whittlesey (fig. 3) stood about 28 feet above the highest Arkona beach ridge in the region northwest of Port Huron and 44 feet above the lowest. The ice front during this time rested on the Port Huron moraine. As it advanced up the "thumb" the ice which built this moraine overrode the Arkona beaches and buried a considerable extent of them on the northern part of the "thumb" beneath the terminal moraine or under outwash. In the southern part of the Black River Valley northwest of Port Huron the Arkona beaches were not overridden, nor were they buried, but they were protected from the waves of Lake Whittlesey. Within the valley they are strongly developed gravelly beach ridges, and show no modification due to submergence. Outside to the south they were almost entirely washed away by the storm waves of Lake Whittlesey. In many places so little remains of them that they are traceable only with much difficulty. Although they were 28 to 44 feet under the water the storm waves swept their gravels rapidly up the slope and built them into the Whittlesey beach. The Whittlesey beach has characters which indicate that it was pushed up the slope as it was made, and also that it was made rapidly, for it stands very high above the adjacent land and is peculiarly independent of topography, crossing valleys of moderate depth in a direct line like a railroad embankment. The correlatives of Lake Whittlesey in the Saginaw and Michigan basins are shown in figure 3.

LAKE WAYNE.

The next beach below the Arkona is the Warren. But, as was the case with the Whittlesey beach, the next beach below the Warren shows evidence of having been submerged and modified after it was

formed, and the Warren beach is therefore the beach of a raised lake. The Wayne beach is generally faint and on the "thumb" of Michigan, where it is gravelly, shows distinct evidence of submergence and modification after it was made. Excepting on the "thumb," it is generally sandy and without marked characteristics.

From the Whittlesey beach the lake level appears to have dropped quite abruptly 80 or 85 feet to the Wayne beach. This drop in the lake level was, of course, due to a movement of retreat on the part of the ice front. The Wayne beach lies at a level in the Saginaw Valley barely below the head of the channel, which had served as the outlet of Lake Saginaw. At the same time it is quite certain that no outlet was open toward the northwest through the Straits of Mackinac. The outlet at the time of this beach seems to have been in the east along the ice margin, where it rested against the hills south of Syracuse, N. Y.

LAKE WARREN.

Here, as in the previous stages, the ice front readvanced, covering part of the ground previously vacated. This movement closed the outlet which had recently been opened near Syracuse and raised the lake to the level of the Warren beach. In the Saginaw Valley the Warren beach passes 20 to 25 feet above the col at the head of the Grand River outlet channel. The col is extremely flat and much covered with dunes.

In Michigan the Warren beach extends up to the vicinity of the Au Sable River, north of Saginaw Bay (fig. 4), but has not been identified farther. In New York it has been traced some distance east of the Genesee River. Its limits in Ontario have not been determined. While the Warren beach was being made, the Wayne beach was being destroyed, and the Warren beach, like the Whittlesey, shows in some places, but not so strongly, the characters which indicate rapid accumulation. The correlative of Lake Warren in the Michigan basin is shown in figure 4. It is probable that a glacial lake, known as Lake Duluth, also then existed in the western part of the Superior basin with outflow southward through St. Croix River.

In the later stages of the lake waters, from Lake Arkona on, the area covered by the lakes, included not only the basin of Lake Erie, but a part of those of Lakes Huron and Ontario also. In New York, Fairchild reports evidences of a readvance of the ice and raising of lake level later than the one which affected Lake Warren. That movement, however, appears to have been confined to the Lake Ontario basin and had no effect upon the waters of the Huron-Erie basin.

The beaches of all the foregoing lakes are horizontal in the southern part of the region they cover, but in the northern part they rise

slightly toward the north-northeast. The area of horizontality lies southwest of a line passing about 5 miles north of Birmingham, Mich., to Ashtabula, Ohio. This seems to have been a sort of hinge line

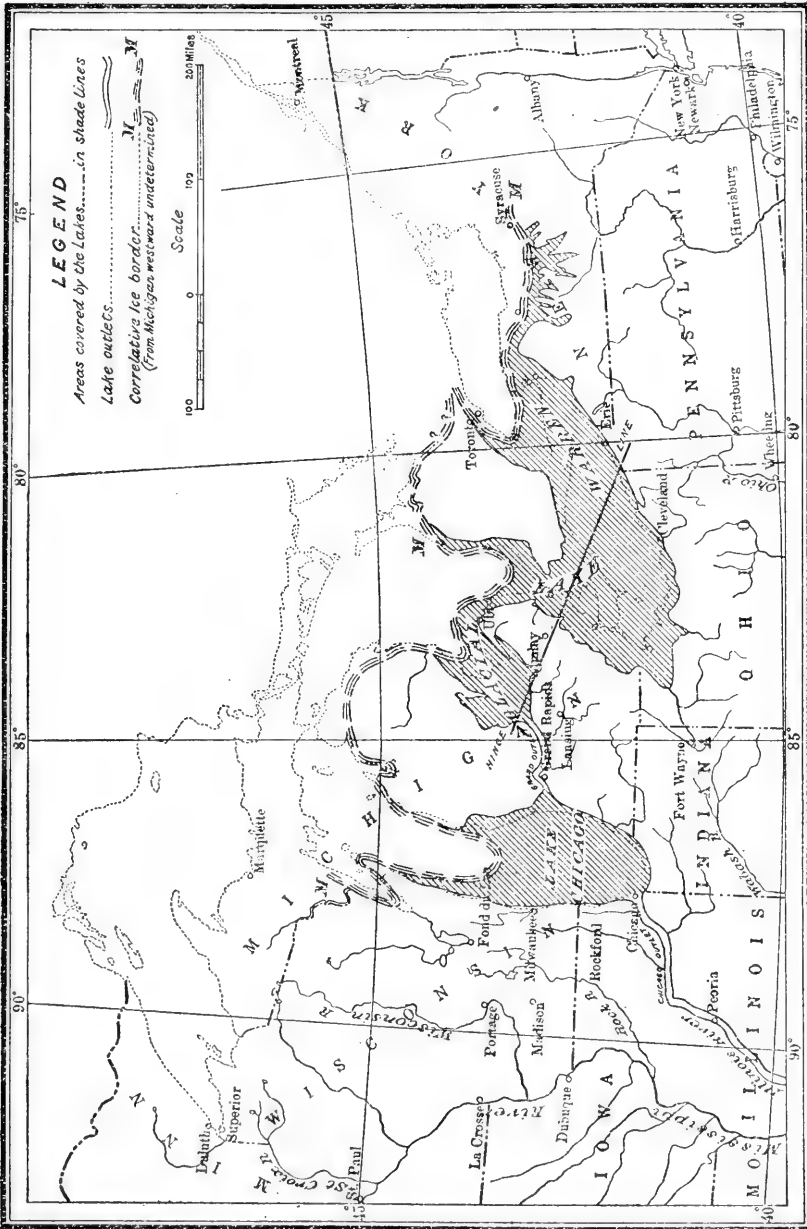
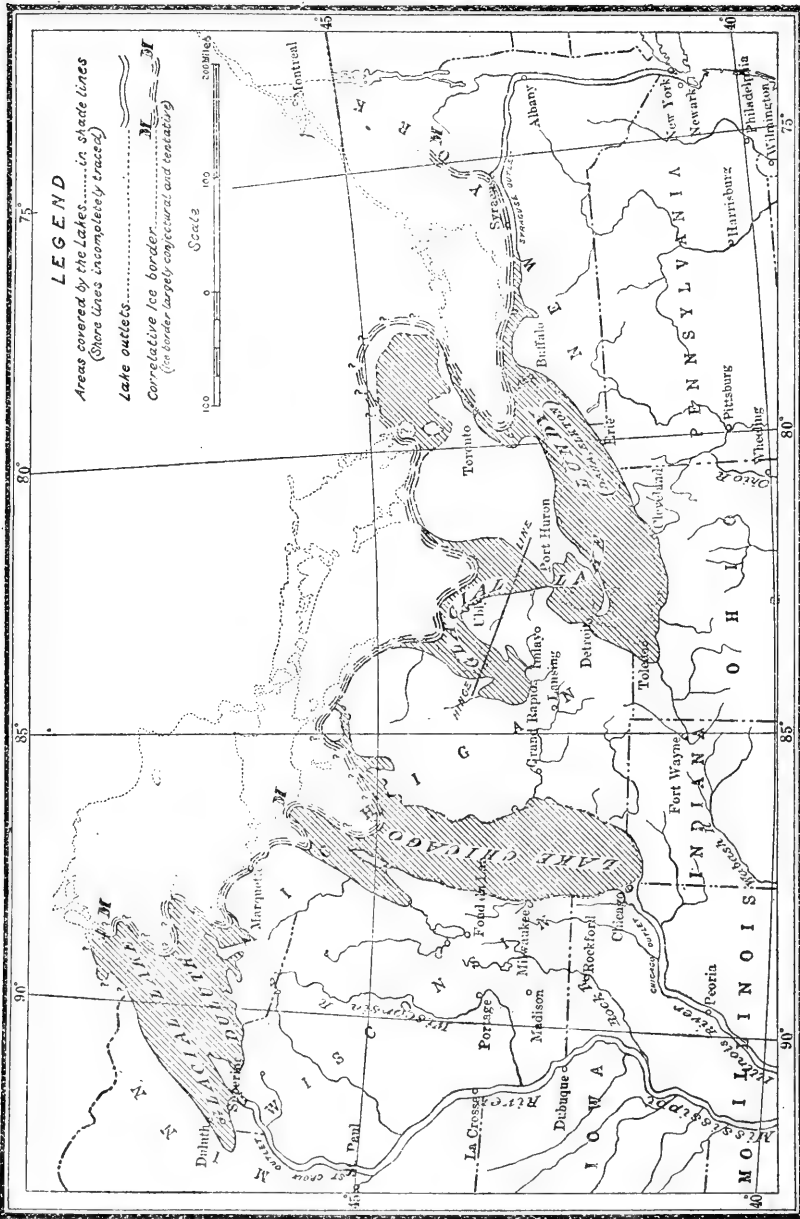

FIG. 4.—GLACIAL LAKES WARREN AND CHICAGO.
 By Frank E. Taylor and Frank Leverett, 1910.

for the earlier deforming movements. North of it all the beaches rise gradually in a direction about north-northeast, but the earlier ones seem to rise or bend upward sooner than the later ones, as though

the deforming force had migrated slowly northward, following the retreat of the ice front.



LAKE LUNDY (LAKE DANA, LAKE ELKTON.)

When the waters fell from the level of Lake Warren they halted first at the Grassmere beach and later at the Elkton beach, before the final

FIG. 5.—GLACIAL LAKES LUNDY (DANA, ELKTON), CHICAGO, AND DULUTH.
By Frank B. Taylor and Frank Leverett, 1913.

separation from the waters of the Lake Erie basin. Both of these beaches have only moderate strength. On the outer part of the "thumb" of Michigan they are both split up into several fainter lines. They are generally gravelly on the "thumb," but are sandy elsewhere. They have been studied very little east of Michigan, probably in part because they are weak.

These beaches mark a transition stage of the lake waters—the transition to Lake Algonquin, the largest of the glacial lakes in the Great Lakes region. The outlet for both stages of Lake Lundy was probably near Syracuse, N. Y. (fig. 5), but connection with that region has not been established by continuous tracing.

On the "thumb" these two beaches show the most remarkable example of northward splitting that has been found. The outer part of the "thumb" was being elevated while these two beaches were being made, and each one splits from a single beach ridge in the south to four or five separate weaker strands covering a vertical interval of 25 or 30 feet. In the area of horizontality the Grassmere and Elkton beaches have altitudes of about 640 and 620 feet, respectively.

Differential elevation has raised the Warren beach at Alden, N. Y., 20 miles east of Buffalo, to an altitude of 845 feet, or about 180 feet higher than the same beach in the area of horizontality in Ohio and southeastern Michigan. In the same region, east of Buffalo, the Lundy or Dana beach is about 150 feet below the Warren beach, and descends toward the south or southwest at a rate not yet accurately determined. But the altitude of fragments 30 to 40 miles west of Buffalo being 640 to 645 feet, it seems almost certain that this beach becomes horizontal at some point farther west and at a slightly lower level, indicating that it is the eastern correlative of the Elkton beach of Michigan. On the south side of Lake Erie the attitude of the deformed planes of the higher beaches suggest that the Lundy beach probably becomes horizontal near Erie, Pa., and continues so westward.

At this time the ice barrier stood not far from the present south shore of Lake Ontario north of Buffalo, with relatively long and narrow arms of the lake waters extending east and west along its front. With these Lake Lundy was connected by a strait 25 to 30 miles wide, extending northward over the Niagara region, the depth of the water being 90 to 100 feet at Buffalo and Niagara Falls.

GLACIAL LAKES IN THE BASIN OF LAKE ONTARIO.

LOCAL GLACIAL LAKES.

When the Lake Ontario ice lobe had retreated far enough to uncover the southern parts of the valleys of the Finger Lakes in central New York, small lakes gathered in them, at first as separate bodies. With continued recession these lakes were lowered and

combined in a complex series of changes leading finally to the later, larger lakes that filled the whole basin of Lake Ontario. The succession of changes has been set forth in considerable detail by Fairchild¹ and illustrated by a series of maps. The first local glacial lakes had independent outlets toward the south.

LAKE NEWBERRY.

Following this the dozen or more small lakes in the "Finger lake" valleys had merged into one lake, Lake Newberry, with its outlet southward from Seneca Lake to the Susquehanna River.

LAKE HALL.

At a slightly later stage of recession an outlet for these waters was opened westward to the glacial waters in the Lake Erie basin initiating Lake Hall.

LAKE VANUXEM.

At a still later stage an outlet was opened eastward to the Mohawk Valley and Lake Vanuxem resulted. After this there was for a time free drainage eastward with only two low, small lakes, one in the Genesee Valley and one in the valley of Cayuga Lake.

Following this stage the waters of the southern part of the Lake Ontario watershed merged with the glacial waters in the Huron-Erie-Ontario basin. They are discussed above under the heading "Glacial lakes of the Huron-Erie-Ontario basin."

LAKE DAWSON.

When the waters had fallen so as to separate those in Lake Erie from those of the Lake Ontario basin, the outlet was established eastward past Syracuse, N. Y., and a number of oscillations of lake level probably occurred corresponding to slight retreats and readvances of the ice front. These changes affected the height and eroding power of Niagara Falls. Toward the end of these oscillations the relatively high ground east of Rochester became a barrier against which the ice front rested, holding Lake Dawson in the Lake Ontario basin west of Rochester, while a smaller lake into which it flowed filled a narrow strip farther east and emptied into the Mohawk.

LAKE IROQUOIS.

Finally the waters of the Lake Ontario basin fell to the level of the pass at Rome, N. Y., and discharged eastward through the Mohawk Valley. (Fig. 6, ice border at position I.) This established Lake Iroquois, which endured for a relatively long time. The land, however, was strongly uplifted around the north side of this basin while the lake was discharging at Rome. This backed the water up on

¹ Fairchild, H. L., Glacial waters in central New York, N. Y. State Education Department Bulletin, No. 442; N. Y. State Museum, Bull. No. 127, 1909.

its south and west shores and caused it to fall away from the northern and eastern shores.

LAKE X.

When the retreating ice opened a passage eastward around the

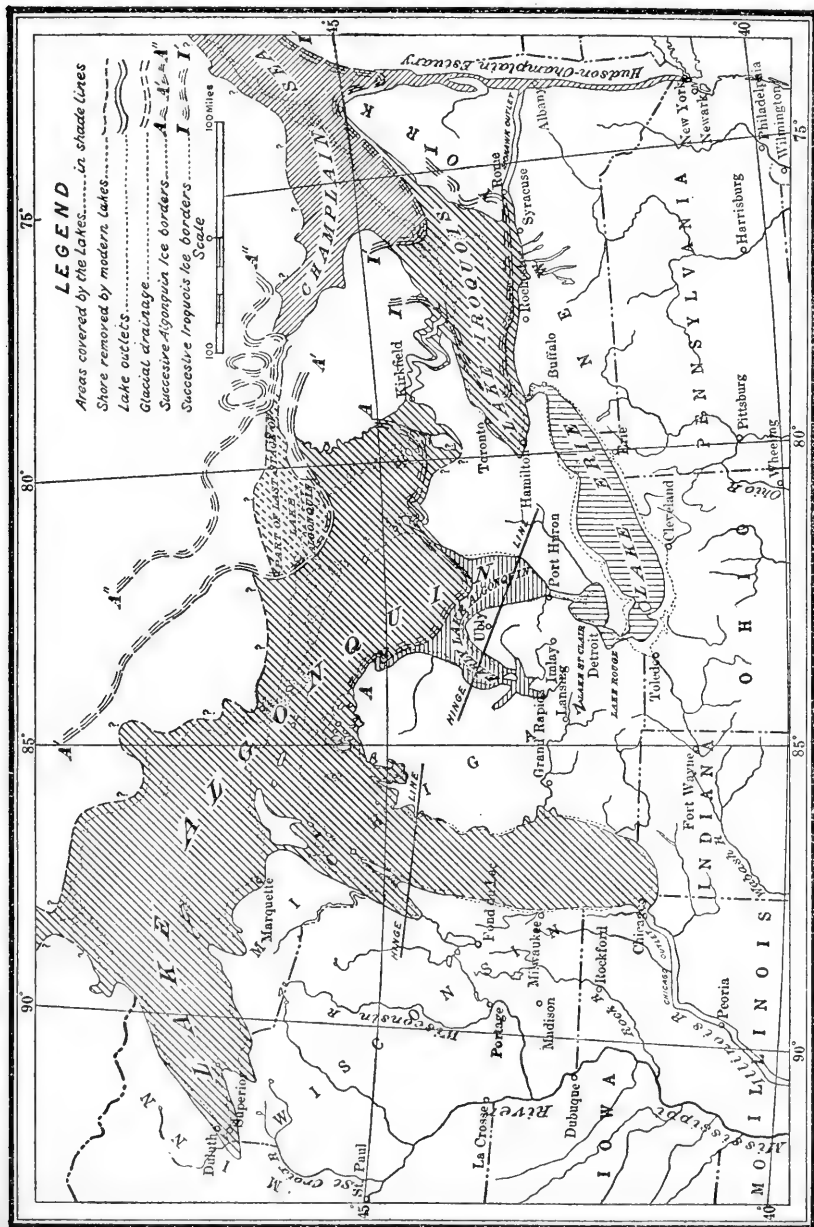

FIG. 6.—GLACIAL LAKES ALGONQUIN AND ITS CORRELATIVES.

By Frank B. Taylor and Frank Leverett, 1910.

north side of the Adirondack Mountains to the basin of Lake Champlain (fig. 6, ice border at position I) the outlet at Rome was aban-

done. Following this the lake level fell as the ice withdrew, until the sea, which then stood relatively higher than now (523 feet higher near Covey Hill, on the northern base of the Adirondacks¹), entered and turned what had been a glacial lake into a marine gulf. The changes of the water levels in the Lake Ontario basin, however, have not yet been fully worked out.

GLACIAL LAKES IN THE BASIN OF LAKE MICHIGAN.

LAKE CHICAGO.

While this complicated history was being enacted in the Huron-Erie-Ontario area the glacial waters in the basin of Lake Michigan were also undergoing an expansive development. In this case, however, the changes were extremely simple, for until the very last stage no critical ground affording a new outlet was encountered. Such changes as occurred were due to erosion of its outlet or to changes in the volume of discharge. From its beginning as a narrow, crescent-shaped lake at the extreme southern end of the Lake Michigan basin, Lake Chicago expanded northward as the ice receded until two-thirds or three-fourths of the basin was uncovered, as shown in figures 2, 3, 4, and 5. In all probability the retreating ice front performed here the same series of oscillations, with strongly marked retreats and readvances, that took place in the Huron-Erie basin. The evidence of these oscillations, however, is not generally so well marked, because critical changes were not produced by them. But some of the stronger moraines mark readvances that override beach ridges which had been made just previously.

The Port Huron moraine skirts the north side of the high ground of the southern peninsula of Michigan and appears to be correlated with the Whitehall moraine of the Michigan basin.

Studies by Alden, under the direction of Chamberlain, on the west side of the Michigan basin have developed evidence of a distinct readvance of the ice southward to Milwaukee characterized by a deposit of red till, and this probably correlates with the Whitehall moraine. Later ridges of red till, which come down to the shore of Lake Michigan near Manitowoc and Two Rivers, Wis., also seem likely to correlate with the Manistee ridges on the east side of the lake. This correlation is inferred not only because of similar positions on opposite sides of the lobe and in reference to earlier moraines, but also because these later morainic ridges do not appear to carry the Glenwood and Calumet (first and second) beaches of Lake Chicago, which are present on the Whitehall moraine. Two lower beaches in the same area seem to have wider connections. The upper one is the Toleston beach, 24 or 25 feet above Lake Mich-

¹ Fairchild and Goldthwait, personal communication.

igan, and the Nipissing beach, about 15 feet above the lake. The summit in the Chicago outlet in the southwest part of the city is only 8 feet above Lake Michigan and is a broad, flat region much obstructed by low, sandy ridges. The Toleston beach passes over this broad divide at a level high enough to have permitted Lake Chicago to discharge over it, even when receiving the discharge of Lake Whittlesey or Lake Warren. Nevertheless, the Toleston beach seems to be continuous with the Algonquin beach, which is present in all of the upper three lake basins, and part of the overflow of Lake Algonquin may have been by way of Chicago for a time. When the Huron-Erie waters were discharging eastward past Syracuse, the volume of discharge at Chicago was largely diminished and the lake stood slightly lower.

When the ice lobe in the Lake Michigan basin retreated into the northern part of that basin, it uncovered ground of critical interest on both sides. On the west side the glacial waters of the Lake Superior basin had been held up to a higher level than those of Lake Chicago, and when an opening occurred around the hills southeast of Marquette these waters were drained southward along the western edge of the Green Bay lobe of the ice sheet and ultimately into Lake Chicago.

Bordering the west shore of Lake Michigan and extending into the Green Bay-Lake Winnebago trough and the Fox and Wolf River valleys is an extensive deposit of red clay, partly laminated, partly pebbly and massive, which was described by Chamberlin¹ in his *Geology of eastern Wisconsin*. Later study of this deposit by Alden,² under the direction of Chamberlin, shows that the larger part of this deposit, the massive pebbly clay, is to be interpreted as glacial till which was laid down during a readvance of the glacier in the Lake Michigan basin as far south as Milwaukee and of the Green Bay lobe in the Green Bay-Lake Winnebago trough to a point south of Fond du Lac, Wis. The ice also crowded westward in the Fox and Wolf River valleys. The red silt composing the laminated clay and the matrix of the massive pebbly clay is thought to have come from the Lake Superior region, being brought into the Green Bay and Lake Michigan basins by the opening of a southward outlet southeast of Marquette. The first opening of this outlet must have been at or near the climax of the stadial retreat immediately before the readvance to the first red till moraine. The phenomena indicate a readvance over a relatively wide interval, and it seems certain that if a lower outlet had been opened by the retreat, it was closed again by the readvance and the level of the glacial waters in the western half of the Lake Superior basin were raised again to the level of some

¹ *Geology of Wisconsin*, vol. 2, pp. 221-223.

² Alden, Wm. C., personal communication.

earlier, higher outlet. Perhaps this accounts for the faintness of some of the beaches immediately above the Algonquin beach in the Lake Superior basin; they may have been submerged and obliterated after they were made.

On the east side, the retreating ice front finally reached the straits of Mackinac, where an opening allowed the waters of Lake Chicago to unite with those of the Lake Huron basin. Whether this merging of the waters in the Lake Michigan and Lake Huron basins occurred before or after the opening of the Trent Valley outlet at Kirkfield, Ontario, is not certainly known.

GLACIAL LAKES IN GREEN BAY BASIN.

Very little has been written concerning the glacial lakes in the Green Bay-Lake Winnebago valley and their extent has been as yet only partially worked out. Upham published a paper in 1903¹ suggesting the name Glacial Lake Jean Nicolet for a lake that discharged from the Fox River drainage past Portage, Wis., to the Wisconsin Valley. This paper was not based on any field work, except a visit to the outlet, and the existence of the lake was inferred partly from the presence of the outlet channel and partly from Chamberlin's² description of the red clays in the Green Bay basin as lacustrine. As noted above, studies recently carried on by Alden for the United States Geological Survey have shown that the red clay was largely worked over and formed into morainal ridges and till sheets by a readvance of the ice so that the limits of the red clay in the Green Bay basin mark a glacial instead of a lake border. Alden's studies have also shown that the lake history in this basin was somewhat different from that set forth by Upham. There was first a lake that discharged from the district south of Lake Winnebago southward past Horicon into Rock River. This lake persisted until the ice which formed the moraines at the head of Lake Winnebago had receded far enough northward to open a passage westward from Oshkosh to the headwater part of Fox River. Then the discharge was shifted past Portage to the Wisconsin Valley. Later, when the melting of the ice cleared the Green Bay peninsula the waters lowered to the Lake Winnebago level and to a lake in the Green Bay basin by discharging eastward into Lake Chicago. A similar series of events accompanied the preceding recession of the ice front, and also, in reverse order, the readvance of the ice which formed the red till moraines.³ In the present incomplete state of the study one can hardly forecast the full succession of events in this basin, but it is evidently so different from Upham's conception that it seems best to leave the naming of these lakes until a later time.

¹ Amer. Geol., vol. 32, 1903, pp. 105-115 and 330-331.

² Geology of Wisconsin, vol. 2, 1877, pp. 221-228; pl. 2, Geology Atlas of Wisconsin, 1881.

³ Alden, Wm. C., personal communication.

GLACIAL LAKES IN THE BASIN OF LAKE SUPERIOR.

From the first small lakes at the extreme western end of the Lake Superior basin the glacial waters expanded in a manner similar to those just described for the Lake Erie and Lake Michigan basins. In the earlier stages, while the lakes were small, there were slight changes in outlet and level, though the early stages had outlet directly or indirectly to the St. Croix Valley.

LAKE DULUTH.

Finally came Lake Duluth with its outlet southward through the Brulé and St. Croix Valleys. Lake Duluth endured for a much longer time than the earlier lakes, and at its lower levels expanded to a lake of large size, forming beaches found even on the outer part of the Keweenaw peninsula. Its outlet was cut down about 40 feet, lowering the level of the lake and causing the formation of later beaches below the highest.

Several lower beaches which have been traced by Mr. Leverett seem to lie too low for waters discharging through the St. Croix outlet, and hence may not belong to Lake Duluth. These suggest a place of overflow to the east and south, around the hills south of Marquette. The outlet indicated by these beaches has not yet been determined. These are rather weak beaches, and suggest the possibility of submergence in consequence of a readvance of the ice after they were made. There is independent evidence of such a readvance.

GLACIAL LAKES IN THE SUPERIOR-MICHIGAN-HURON BASIN.

LAKE ALGONQUIN.¹

In the outline given above the succession of lakes in each of the upper three basins—those of Lakes Huron, Michigan, and Superior—were given down to the time when the glacial waters in all three basins were about to merge into one great lake. This larger body is called Lake Algonquin, and its upper beach is one of the strongest and most persistent shore lines in the Great Lakes region. At its greatest extent, as shown in figure 7, this lake covered an area considerably larger than all three of the present upper Great Lakes.

When the lake waters fell away to lower levels from Lake Warren they uncovered for the first time the low lands between Lakes Huron and Erie. This low land divided the waters into two separate lakes and inaugurated for the first time the flow of the St. Clair and Detroit Rivers.

Lake Algonquin may be divided into four stages: (1) Early Lake Algonquin, confined to the south part of the Lake Huron basin, outlet at Port Huron; (2) Kirkfield stage, covered all of the upper

¹ Spencer, J. W., *Am. Jour. Sci.*, 3, vol. 41, Jan. 1891, pp. 12-21. Goldthwaite, J. W., *Bull. Geol. Soc. Am.*, vol. 21, 1909, pp. 227-248.

lakes, outlet at Kirkfield, Ontario, uplift in north begins; (3) Port Huron-Chicago, or Port Huron stage, outlets at both of these places at first, but rapidly diminishing at Chicago and increasing at Port Huron. Main great uplifts occur in this stage and cause great tilting and divergence of beaches at the north. Three groups of beaches formed: (a) Upper Algonquin group, (b) Battlefield group, and (c) Fort Brady group. Most rapid uplift was during Battlefield group, (4) closing transition stage leading to Nipissing Great Lakes. Outlet eastward to Ottawa Valley.

(1) *Early Lake Algonquin*.—At its beginning, Lake Algonquin probably had a brief stage, when it was confined entirely to the southern half of the Lake Huron basin. (Fig. 6, ice border at position A.) The ice front then rested against the highlands which bound the two sides of the southern half of Lake Huron, as shown by the moraines in both Michigan and Ontario. This stage, however, was of relatively short duration, for the ice front was so far north at its beginning that a very slight additional retreat opened passages to the east and northwest and lower outlets were available in both directions—to the east to Georgian Bay and the Trent Valley in Ontario and to the northwest to Lake Chicago and through this to the Chicago outlet. These two passages probably opened nearly at the same time. From the fact that no separate beach or outlet is known for this stage, it might be thought that this lake is wholly hypothetical and its existence entirely uncertain. But, besides the logical consequences of the relation of the ice sheet to the highlands (fig. 6), the early distributaries of the St. Clair and Detroit Rivers seem inexplicable, except as incidents of the transition from Lake Lundy to a lower stage corresponding to Early Lake Algonquin. And further, the five short gorges which Niagara River made in the Niagara escarpment during its early flow, which was of relatively short duration, show conclusively that Niagara River then had a volume as large or very nearly as large as at present, and this could not have been the case, except by a large contribution of water to Lake Erie from the north. This was clearly before the opening of the Kirkfield outlet in Ontario. The discharge from Early Lake Algonquin was larger than might be expected, because this lake received a large affluent from the east, from the region of the Nottawasaga Valley and Lake Simcoe in Ontario, and also a large amount directly from the ice barrier.

(2) *The Kirkfield stage*.—There seems to be no reason to suppose that the Chicago outlet was at this time low enough to take the whole discharge from Port Huron. On the other hand, the Trent Valley outlet at Kirkfield, Ontario (fig. 7), was surely low enough, and as soon as it opened the overflow went to the Trent Valley and the level of the lake fell below the outlets at Port Huron and Chicago,

for the character of the outlet channel at Kirkfield and below shows that it carried the full discharge of the upper lakes for a considerable length of time. Indeed, the principal or upper strand of the Algonquin group of beaches is remarkably strong and continuous, not only in the southern parts of the basins, but runs on unbroken in the same character far toward their northern sides. If there are parts where this beach was not formed they must be limited to the far north, for it is strongly developed on the high ground north of Sault Ste. Marie, Ontario. Apparently during the time of the making of the upper strand no part of the lake was subject to deforming or warping influences, and the outlet was at Kirkfield.

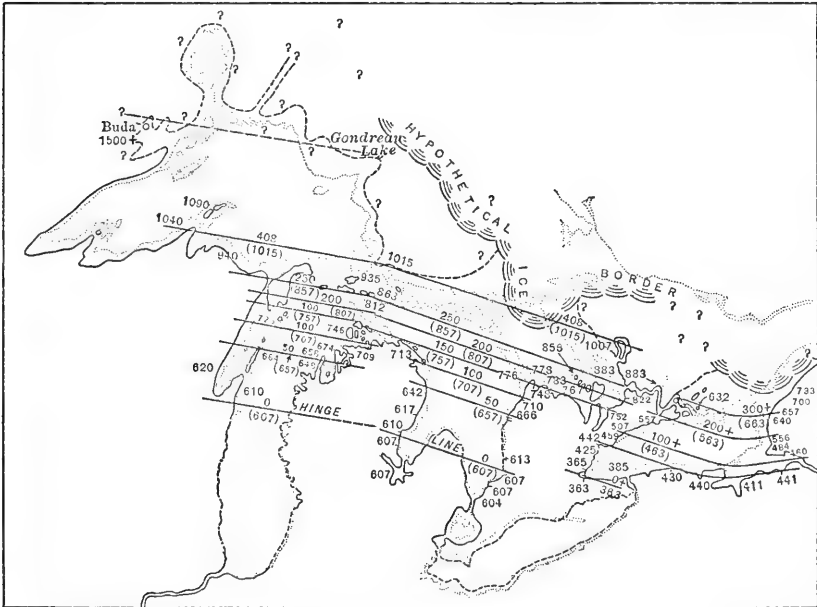

FIG. 7.—ISOBASES OF LAKE ALGONQUIN.

By Frank B. Taylor and Frank Leverett, 1911. (With compilation from other sources.)

At length, when the ice sheet had almost entirely disappeared from the lake basins, a great movement of differential elevation began to raise the land. This movement affected a vastly greater area than that of the Great Lakes, but within this area it affected the northern parts most. South of a line running through the middle of the "thumb" of Michigan (fig. 7) and across the south arm of Lake Huron in a course about S. 68° E. and N. 68° W. and also south of a line running westward across Lake Michigan from a point south of Frankfort, the Algonquin beach was not affected at all by the uplift. This line was a sort of "hinge" line for the movement. Kirkfield, at the head of the Trent Valley outlet (fig. 6), was well within the region

of strong uplifting, so that probably early in the movement it was raised to a position higher than the outlet at Port Huron. The Kirkfield outlet was then abandoned and the discharge was shifted to Chicago and Port Huron. South of the isobase of Kirkfield the Algonquin beach seen to-day is not the first beach made when the Kirkfield outlet carried the whole discharge, but is a transition beach made when two or probably three outlets were active at once. This might be called the Algonquin transition or three-outlet beach. But the name Algonquin beach has generally been applied to the whole strand. The original Algonquin beach is now seen only in the region north of the Kirkfield isobase. While the Kirkfield outlet was active and carried the whole discharge, the isobase of that outlet served as a nodal line on which the water plane swung, and the shores to the north of it were left dry and those to the south of it submerged.

The uplifting and tilting continued in the region north of the hinge line and progressed with increasing rapidity. Since it was abandoned, the outlet at Kirkfield has been raised altogether something more than 270 feet, for it now stands 295 feet above the level of Georgian Bay, and Lake Huron in the meantime has been lowered 25 feet by the erosion of its outlet at Port Huron. Farther north and northeast the movement of elevation was still greater.

From the fact that the Kirkfield outlet appears to have carried the whole discharge of the upper three lake basins and that it was uplifted and abandoned rather late in the life of Lake Algonquin, the conclusion follows that while this outlet was active the Chicago and Port Huron outlets were both left dry. This means that during this time the shores of Lake Algonquin throughout all the region south of the isobase of Kirkfield stood at a level at least a little below these two outlets. Hence, the upper Algonquin beach south of the isobase of Kirkfield was not made during the principal activity of that outlet, but during the transition (two or possibly three outlet) stage of the lake, when a considerable part of the overflow had left Kirkfield and gone to Chicago and Port Huron. It is therefore a transition beach. Its principal making and the gradual lowering of the lake for 10 feet or more was while the overflow was at both Chicago and Port Huron. The character of the Algonquin beach agrees remarkably well with this conception of Lake Algonquin's history.

(3) *The Port Huron-Chicago stage.*—When the Kirkfield outlet was abandoned, it seems probable that the overflow went first in greater part to Chicago, leaving only a relatively small part to flow south at Port Huron. But the Chicago outlet rested on a rock sill and held firm, while that at Port Huron was deepened with relative rapidity, so that by the end of Lake Algonquin the lake level had fallen 10 feet and the Port Huron outlet had taken almost all the overflow away from Chicago. The Niagara Gorge, which reflects in its magnitude

the volume of Niagara River, indicates that the domination of the outlet at Chicago endured for only a relatively short time, for the Niagara River in the early part of the Port Huron stage of Lake Algonquin made the widest section in the whole gorge. The time of this large-volume discharge at Chicago was the time when the Toleston beach was made, and if there was a beach of Lake Chicago there before and controlled by the same sill, it must have been overwhelmed and worked over entirely by Lake Algonquin waters. From this point of view Toleston is in reality only a local name for the Algonquin beach as developed in the southern part of the Lake Michigan Basin.

It was during the third or Port Huron-Chicago stage of Lake Algonquin that the larger part of the remarkable uplift of the Great Lakes region occurred. It began when the Kirkfield outlet was active, but soon raised Kirkfield to a higher altitude than Port Huron and Chicago, to which places the outflow was then shifted. The uplift caused a remarkable northward splitting and divergence of the beaches below the highest Algonquin beach. As a consequence the beaches of this stage are many in number and show a large vertical divergence northward. They seem to fall readily into three groups, (a) the upper or main Algonquin group, (b) the Battlefield group, and (c) the Fort Brady group. The main uplift began during the second or Kirkfield stage, as pointed out above, but the much greater part occurred during the third or Port Huron-Chicago stage, and the most rapid movement was during the making of the Battlefield group of beaches. At Sault Ste. Marie the vertical interval between the highest Algonquin and the Nipissing beaches is 365 feet, while in the area of horizontality the interval between these same beaches is 10 or 12 feet. Coleman reports a beach at Lake Gondreau (fig. 10) at 1,500 feet. This may be the highest Algonquian strand, and is nearly 900 feet above that beach at Port Huron.

For some distance north from the hinge line the upper Algonquin beach rises gradually. It then begins to rise more rapidly and begins also to split into a vertically diverging series of subsidiary strands which are separated by wider and wider vertical intervals toward the north. This splitting of the strands shows that the land was being differentially elevated during the life of the lake. The different strands are not of the same strength nor are they equally spaced vertically, showing apparently that the uplifting movement was not steady in its progress, but was irregular and was marked by a number of pauses of more or less length. The idea held formerly that the postglacial uplifts of the land in the Great Lakes region were gradual and that they were evenly distributed through time is an error. The uplifting movements were evidently quite spasmodic and relatively

sudden and rapid. Almost all the deformation occurred during and since the later part of the life of Lake Algonquin.

(4) *Closing transition stage.*—At its very end Lake Algonquin appears to have been held up by a relatively small glacial barrier at some point in the Ottawa Valley east of Mattawa. (Fig. 6, ice border position A'.) When this last dam broke out or shrank back northward the waters rushed eastward from Lake Algonquin through the Mattawa Valley to lakes in the Ottawa, Petawawa, and Madawaska Valleys (fig. 6, ice border at position A''), and thence to the Champlain Sea, and came to a settled level in the upper lake basins only when the eastward flowing outlet had been established on the col at North Bay.

The relation in time of Lakes Algonquin and Iroquois is a matter of great importance in connection with the study of the deformation of the land. There are certain facts that seem to show that Lake Iroquois had already been established when the Kirkfield outlet first opened. The outlet river of Lake Algonquin has been called by Spencer the Algonquin River. The scoured bed of this great river is quite evident between the small lakes of the Trent Valley. At Peterboro an expanded part of the valley which stood so near the level of Lake Iroquois that it may have been a land-locked bay of that lake is filled with a great deposit of gravel and sand. This appears to be a delta deposit of the Algonquin River and seems to show conclusively that this river emptied into Lake Iroquois. But the scoured channel of the Algonquin River does not stop at Peterboro. It appears to continue down the Trent Valley to Trenton and in all probability passes below the present level of Lake Ontario. (Fig. 6.) It even passes below the probable level of the marine waters that entered the Lake Ontario basin. But below Peterboro it seems to show decidedly less scour than above and in some places suggests a smaller stream. At present the relation of this lower part to the Lake history is quite problematical, for no other fact indicating so low a level for the waters of the Lake Ontario basin at that stage is known. It may be that while the Algonquin River was flowing the ice front withdrew far enough to allow Lake Iroquois to be drained off for a brief time, only to be restored again for another relatively long period by a readvance of the ice. There were a number of episodes of this kind earlier in the lake history.

POST-GLACIAL LAKES OF THE GREAT LAKES REGION.

THE NIPISSING GREAT LAKES.

With the establishment of the outlet of the upper three lakes at North Bay, a new order of things was inaugurated. The ice sheet had disappeared from the Great Lakes region and no longer served as

a dam or retaining barrier for any of its waters. The drawing of the whole discharge to North Bay necessarily caused the abandonment of the Port Huron outlet, which had just previously been active. The new lake level, with its outlet at North Bay, lay in a plane which passed somewhat, though perhaps only a little, below the outlets at Port Huron and Chicago. During the later differential uplifting of the land, which occurred while the North Bay outlet alone was active, the isobase passing through that outlet became a nodal line upon which the water plane swung. As elevation progressed the strands to the north of this line were abandoned and left dry, while those south of this line were progressively submerged by the backing up of the water.

This order of changes continued until the North Bay outlet was raised as high as that at Port Huron. Then both outlets became active with the discharge divided between them. The beach made at this two-outlet stage has been called the Nipissing beach. In a strict sense, however, it is not the original Nipissing beach, made when the North Bay outlet alone was active, but a transitional beach made during the two-outlet stage. It might be called the Nipissing transition or two-outlet beach. The original Nipissing beach may be seen now only in the northeastern part of the Lake Superior Basin, where a small area lies north of the North Bay isobase or nodal line. This area, however, is so small and so close to the nodal line that the measurements thus far made have not yet disclosed any difference in the altitude of the old water plane on the two sides of the line. Theoretically there should be some difference and there probably is, though not yet worked out. South of the line the visible beach is the transition or two-outlet beach, the original beach being everywhere submerged. But inasmuch as no measurable change of plane has been found in crossing the nodal line the name Nipissing beach has generally been applied to the whole extent of the two-outlet strand.

The Nipissing beach thus defined (fig. 8) has been traced with substantial continuity around all three of the upper lake basins and is, especially in the northern part of the area, much the strongest abandoned beach of the Great Lakes region. Its plane extends with almost perfect uniformity, and with no certainly discoverable warping, over all the northern parts of these basins. The uplift which tilted this beach (fig. 9) appears to have hinged about on the same line as the earlier uplifts which raised the Algonquin beaches. South of this hinge line the Nipissing beach is horizontal at about 15 feet above present lake level. North of it the beach rises at the rate of about 7 inches per mile in a direction about N. 22° E. The Nipissing beach at North Bay is now about 117 feet above Lake Huron, about 70 feet at Sault Ste. Marie, 48 or 50 feet at Mackinac Island, and about

130 feet (110 feet above Lake Superior) at Peninsula Harbor, which is near the northeastern angle of Lake Superior.

The Nipissing beach shows remarkably strong development and

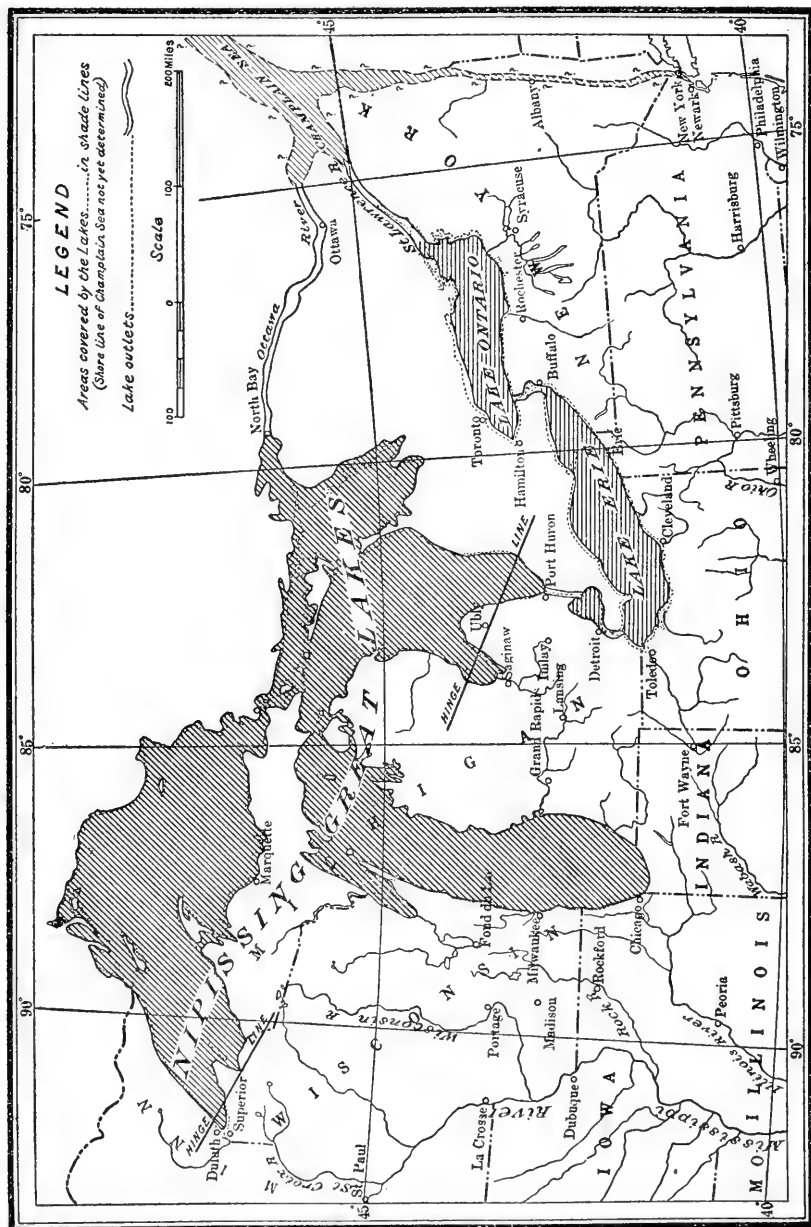

FIG. 8.—THE NIPISSING GREAT LAKES AND CORRELATIVES.

By Frank B. Taylor and Frank Leverett, 1911.

maturity in all the northern parts of the basins, especially near the nodal line. It is very strong for 150 miles or more south of the nodal line, but southward from this line it seems to gradually diminish in

strength, until in the area of horizontality it seems little if any stronger than the Algonquin beach.

In the western end of Lake Superior the Nipissing beach appears to pass a little under the present lake level, a relation which probably accounts for the drowned condition of the shores and stream mouths of that region.

Supposing a short period of southward discharge passed Port Huron at the time of early Lake Algonquin, then the Port Huron outlet and the St. Clair and Detroit Rivers have twice been abandoned and left

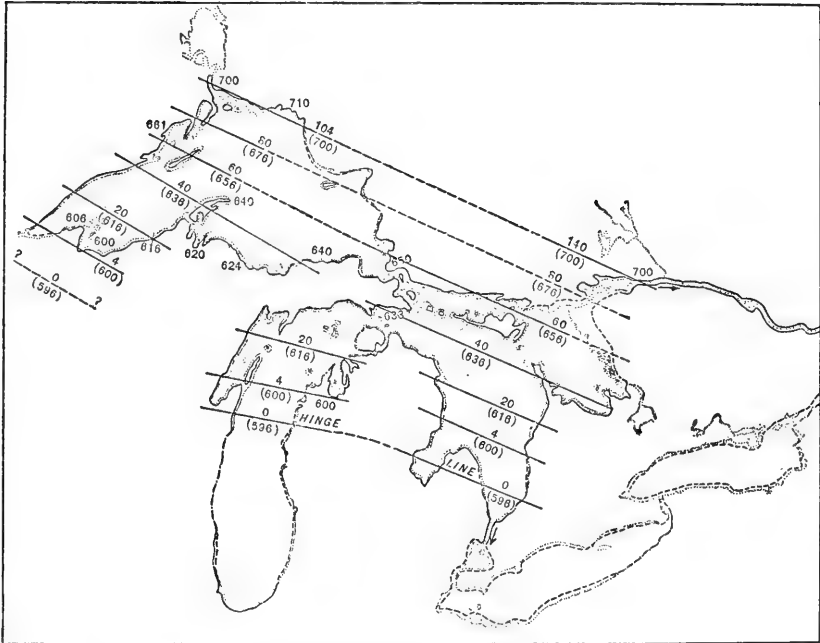

FIG. 9.—ISOBASES OF NIPISSING GREAT LAKES.
By Frank B. Taylor and Frank Leverett, 1911.

dry, and at both times Niagara River was robbed of the overflow of the upper three lakes.

The Nipissing Great Lakes came to an end when the northern uplift raised North Bay, so that that outlet was left dry and the whole discharge returned to Port Huron. With this change the modern Great Lakes have their beginning.

THE POST-NIPISSING GREAT LAKES.

Since the overflow came back to Port Huron the northern uplifting has continued, but apparently at a relatively slow rate, for there is a numerous series of fainter beaches on the slope below the Nipissing beach. One especially is slightly stronger than the rest and seems

to mark a pause in the uplifting movement. This beach is well developed at Algoma Mills, Ontario, and is called the Algoma beach. At that place the Nipissing beach is about 85 feet and the Algoma about 50 feet above Lake Huron. The Algoma beach has been found at many places farther south, and is a little more than halfway up from the present shore to the Nipissing beach.

On the north shore of Lake Superior there is a beach of moderate strength standing in about the same relation below the Nipissing. It may be the Algoma, but it seems more likely to be a beach belonging to the Lake Superior Basin alone and determined by the outlet of that lake at Sault Ste. Marie. It has been called the Sault beach, and appears to swing on the isobase of that place as on a nodal line. It is submerged on the south shore of Lake Superior and around the west end. It is believed to lie along the submerged base of the Pictured Rocks. The Algoma beach appears to be due to a pause in the uplifting movement, but the Sault beach is due in all probability to a relatively steady condition of the lake level arising from the establishment of the barrier and outlet at Sault Ste. Marie.

LAKE ERIE.

After Lake Erie became separated from Lake Ontario it ceased to be a glacial lake, and from that time on it was entirely independent of the ice sheet. By the time the separation had been accomplished, following the fall of Lake Lundy, the basin of Lake Erie had probably been brought nearly to its present attitude. In this time it has also had two low stages, during which it was not receiving the discharge of the upper lakes. These times were when the Kirkfield and North Bay outlets were active. The Fort Erie beach, declining gently westward along its north shore from Fort Erie, Ontario, where it is 15 feet above the lake, is the correlative of Early Lake Algonquin and probably in part also of the Port Huron stage of the greater Lake Algonquin. The two low-stage beaches made in the basin of Lake Erie during the Kirkfield stage of Lake Algonquin and during the Nipissing Great Lakes lay very nearly in the same plane, and both are now everywhere submerged.

EVIDENCES FOR AND AGAINST PROGRESSING ELEVATION OF THE LAND.

In the northern part of the upper lakes there are many evidences, such as the newness of the modern shore line and the newness of the mouths or lower courses of streams, like the Nipigon and other northern rivers, which strongly suggest recent or progressing emergence. Gilbert found what he believed to be evidence of progressing change in the records of the lake gauges, and he estimated the rate of differential uplifting, but recent investigations have made

changes in the data which he used and have necessitated a modification of his results.

Since the discharge returned to Port Huron the St. Clair River has cut down its bed about 15 feet and the Detroit River half that amount. This has greatly reduced the effect of drowning of tributaries which was produced at first by the return of the full volume after the period of abandonment during the time of the Nipissing Great Lakes.

In the basins of Lakes Erie and Ontario there are many evidences which indicate recent raising of the water level, such as the drowned stream courses and submerged stumps in Sandusky Bay. These facts seem at first to suggest that tilting of the land was very recent or may still be in progress. But the drowning effects in these two basins, at least to depths of 10 or 15 feet, are probably due to the return of the large volume of discharge at Buffalo and Ogdensburg after the relatively long period of small discharge during the time of the Nipissing Great Lakes, and not to recent or progressing uplift of the land.

POST-GLACIAL MARINE WATERS IN THE OTTAWA AND ST. LAWRENCE VALLEYS AND IN THE LAKE ONTARIO BASIN.

When the ice sheet withdrew from the basin of Lake Ontario and the northern slope of the Adirondacks the sea entered in its place and covered a large area. Its approximate limits (fig. 6) are indicated by postglacial clays, gravels and sands, which are fossiliferous, and the life remains are largely of marine organisms such as are now living in the Gulf of St. Lawrence. The upper limit of the marine waters was about 350 feet at Plattsburg, N. Y., and 523 feet at Covey Hill, Ontario. It was at least 460 feet at Welsh's Siding near Smith's Falls, Ontario, and may have been much more, for at the last-mentioned place the remains of a whale were found in a gravel bed many years ago, and a minimum upper limit of marine submergence is definitely fixed by this occurrence. The height of marine submergence at Montreal is reported to be about 625 feet. On the south side of the St. Lawrence River a well-defined beach marks what is taken to be the upper limit of the marine waters, and has been called by Gilbert the Oswego beach. It declines gradually toward the southwest and passes under the present level of Lake Ontario about at Oswego.

The changes in the level of the waters in the Lake Ontario basin have not been fully worked out, but the marine waters appear to have entered it some time in the later part of the Port Huron stage of Lake Algonquin. The marine connection was through a strait 25 or 30 miles wide and, except for a relatively narrow central depression, not over 40 to 50 feet deep. The uplift appears to have been

in progress when the sea entered, and the duration of the marine connection was short. The strait was soon raised above the sea,

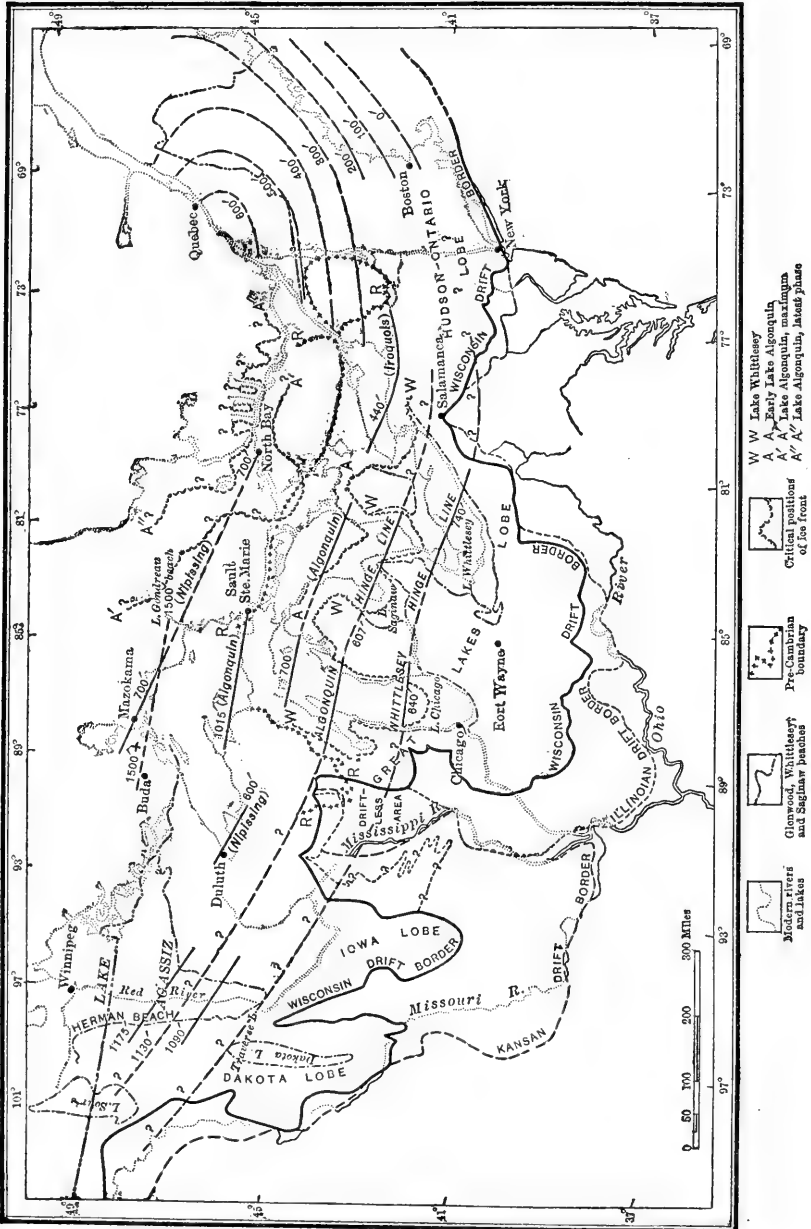

FIG. 10.—DIAGRAMMATIC RELATION OF HINGE LINES AND ISOBASES TO ICE BORDERS, OLD-LAND AREAS, AND LAKE BASINS. By Frank B. Taylor and Frank Leverett, 1912. (Compiled from various sources.)

and at the end of Lake Algonquin sea level probably did not extend above Cornwall and Pembroke.

The accompanying diagrammatic map (fig. 10) shows the relation of the Whittlesey and Algonquin hinge lines to the extreme border of the Wisconsin ice sheet, with three later critical positions of the ice border and several of the isobases. The hinge lines and isobases in the regions east and west of the Great Lakes are added in order to show the general relations of the deformations in those parts to that of the region under discussion. The shore lines of the glacial Lake Agassiz are taken from Upham. (Monograph 25, U. S. Geological Survey.) No shore lines in the Great Lakes area are shown excepting the Glenwood or highest beach of Lake Chicago, the Whittlesey beach, and the correlative beach of Lake Saginaw. The two hinge lines for Whittlesey and Algonquin represent the isobase of zero for each beach. Both are produced conjecturally northwestward to the region of the glacial Lake Agassiz. Two Nipissing isobases are shown in the Superior basin, and these show a trend quite different from those of the Algonquin. In the Michigan and Huron basins the Nipissing beach seems to hinge on about the same line as the Algonquin. The curved isobases in the region south of St. Lawrence River and east of Lake Ontario show the present state of knowledge concerning the deformation of the marine shore line. They show the general relation of the deformation of the marine area to that of the Great Lakes region. The extent of the pre-Cambrian or Old-land area is also indicated to afford means for comparing it with the area of uplift. Inasmuch as the uplift occurred in the course of the melting of the Wisconsin ice sheet and relief from the ice load, and inasmuch as it lies so largely within the glaciated district, a causal relation has by some been inferred and definitely announced. The writer would caution against too hasty conclusions in this matter, especially in view of somewhat discordant relations between the boundaries of the ice and of the uplifted lands which this diagrammatic map will serve to bring out. The writer will take space here merely to state that the preponderance of present evidence appears to be only slightly in favor of resilience following depression by the ice weight as the main cause of the uplifting of the land and the deformation of the shore lines in the region of the Great Lakes. Standing as a close second to the hypothesis of ice weight is the possibility of deformation of the beaches by uplifts of the land incident to crustal creeping movements, which are simply the most recent impulses in a long process of continental growth reaching back into the Tertiary age. If certain evidences which are now supposed to indicate relatively recent crustal creep toward the southwest are substantiated, the hypothesis of resilience following depression by ice weight seems likely to become of secondary importance.



APPLIED GEOLOGY.¹

By ALFRED H. BROOKS.²

The science of geology, generally regarded as having originated in the vague speculations of the cosmogonists hardly two centuries ago, has to-day become of great practical utility. During the past decade all geologic investigations have shown a marked tendency toward material problems, which is in contrast with the previous decade, when the interests of pure science were much more strongly emphasized. No one will deny that economic or, as I prefer to call it, applied geology is attracting more and more attention from professional geologists. It is appropriate that the members of this society should take cognizance of this trend in geologic thought, analyze the conditions which have brought it about, and decide, it may be, whether it makes for the good or the evil of the science.

Before discussing this subject it will be well to attempt a definition of the term "applied geology." Some appear to believe that when the geologist emerges from the tunnel's mouth he is at once transplanted into the realm of pure science, and that the miner's candle illuminates only the so-called practical, or even commercial, problems. I submit that such opinions are not justified. The surveys made as a basis for geologic maps and structure sections, usually classed as belonging to the realm of pure science, often yield results which are the most concrete examples of applied geology. On the other hand, the exhaustive study of mineral deposits is essential to the solution of many fundamental geologic problems. A close analysis will make it evident that the line of demarcation between the fields of pure and applied geology is, in a large measure, arbitrary. The collection to-day of a new group of facts or the determination of new principles relating to pure science may result to-morrow in their application to industrial problems. Mr. Gilbert has recognized two fields of geologic research, the one embracing the study of local problems of stratigraphy, structure, etc., the

¹ Presidential address delivered before the Geological Society of Washington, Dec. 13, 1911. Reprinted by permission, with author's corrections, from *Journal of the Washington Academy of Science*, vol. 2, No. 2, Jan. 19, 1912, pp. 19-48.

² Published by permission of the Director of the United States Geological Survey.

other the general problems of geologic philosophy, and has shown that both may yield results of the highest industrial importance. As David Paige has expressed it:

There indeed can be no antagonism between science and art, between theoretical knowledge and its economic application. The practical expression of a truth can never be divorced from its theoretic conception.

If, in spite of what has been said, the two fields of science are to be differentiated, applied geology may be defined as the science which utilizes the methods and principles of pure geology to supply the material needs of man.

While the present tendency of geologic science toward the investigation of problems of everyday life is patent to all, yet it is desir-

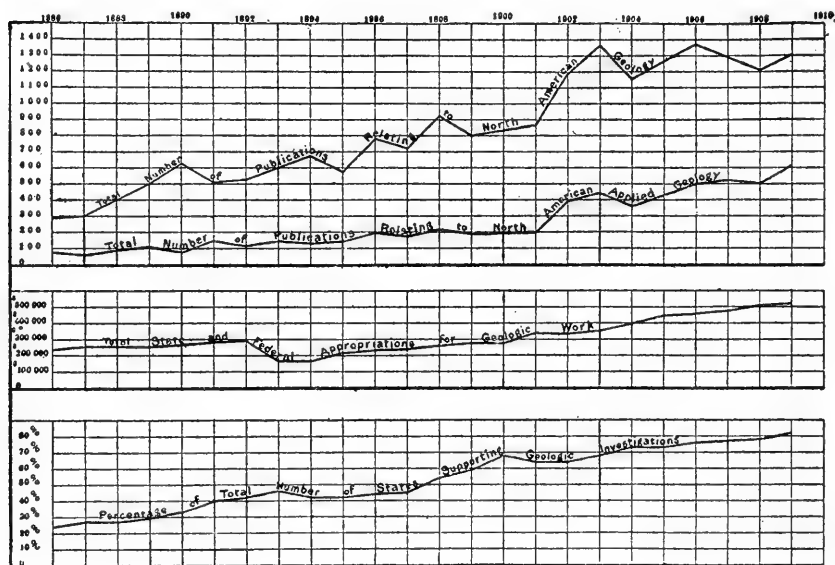

FIG. 1.—GEOLOGIC PUBLICATIONS, STATE AND FEDERAL APPROPRIATIONS FOR GEOLOGIC WORK, AND PERCENTAGE OF TOTAL NUMBER OF STATES SUPPORTING GEOLOGIC WORK FOR THE YEARS 1886 TO 1909.

able to express this tendency quantitatively. For this purpose I have determined the percentage of geologic publications issued annually during the last quarter of a century devoted in part or entirely to applied geology. The result of this analysis is graphically presented in the diagram (fig. 1), in which the one curve represents the total number of publications; another, those classed as bearing upon applied geology. This diagram is based on an actual count, judging by the titles, of the publications included in the annual bibliography of North American geology. It is conceded, of course, that a mere enumeration of titles is, at best, but a crude method, which neither takes into account the extent of the individual pub-

lications nor attempts to appraise their value to science. However, I trust it will serve as a rough measure of the activities of North American geologists. On this basis the diagram clearly records a very rapid increase during the past decade in the ratio of publications dealing with applied geology to the total of geologic literature.

The figures show that applied geology was at its lowest ebb in 1890, when only 12 per cent, and at its highest flood in 1909, when 47 per cent of the total publications related to this subject. To consider the percentage of economic papers by decades: In the 10 years ending in 1895 the average was 22 per cent; for the following decade, 30 per cent; and for the last 5 years, 44 per cent.

Another measure of this trend in geology has been obtained by a similar classification of the publications of the United States Geological Survey. The result of this enumeration is shown in a second diagram (fig. 2). In this it will be seen that in 1890 less than 1 per cent of the publications issued by the Federal Survey treated of applied geology, and in 1910 the percentage was 98. Considering it by decades: For the 10 years ending in 1895 the average of economic

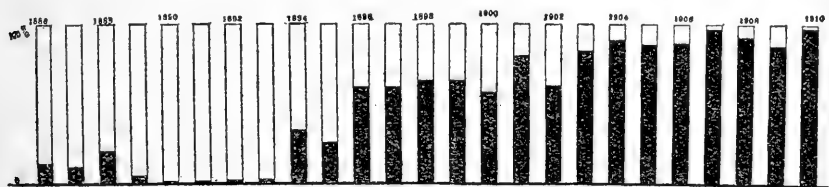

FIG. 2.—PERCENTAGE OF TOTAL PUBLICATIONS OF U. S. GEOLOGICAL SURVEY RELATING TO APPLIED GEOLOGY.

papers was 11 per cent of the total number of publications; in the following decade, 71 per cent; and in the last 5 years, 92 per cent.

These figures are not to be interpreted as evidence that pure science has not been recognized in these publications of the Federal survey. I have classed with the applied geology group all publications which treat in any measure of this subject, though many of them deal chiefly with problems of more purely scientific interest. For example, the geologic folios, which include some of the most notable contributions to pure science, are here included in the literature of applied geology. To me it is less surprising that nearly all the recent publications contain some practical deductions than that most of those of 20 years ago omitted all data of this kind.

The marked tendency toward practical problems, as indicated by these figures, is by no means confined to one organization, for it is exhibited in the same degree by State surveys and is also reflected in the work of the universities. Nor is it limited to this continent, for countries as widely separated geographically and in scientific traditions as South America, Japan, and Germany show similar

signs. Everywhere geologic research of practical problems is receiving more and more support, both publicly and privately.

It is pertinent to consider the attitude of the public at large toward this economic tendency. There are undoubtedly those who believe that the direction of scientific work should rest entirely with the investigator and not with the people. Let them bear in mind that geologic investigations, since they involve heavy expenditures and trespass on private property, can, for the most part, be properly carried on only through Government agencies, in this differing from such sciences as chemistry, physics, or biology, which can be furthered by private means. If geologic surveys are properly a function of the State, in the last analysis the people must be the final arbiters as to what phase of the science is to be emphasized. In our democracy the citizen has a right to inquire what he, as a member of the body politic, is gaining by expenditures from the public purse.

It is estimated, on the best data available, that during the past quarter century the total grants for geologic work made by State and Federal Governments aggregate over \$8,000,000. This may be regarded as evidence of public confidence. More significant to the present discussion is the annual grant of funds during this interval, and this is illustrated by a curve on the same diagram with those showing character of publications (fig. 1). This curve is in part based on estimates, but these are without doubt sufficiently accurate to indicate that the total annual appropriations of State and Federal Governments for geology have been augmented at a rate which proves that they are affected by some other factor than that of increase of population. The annual grant of funds is now more than double that of 25 years ago. It is probably safe to interpret this as indicating that the present economic tendency in geology is approved by the people of the United States. The close parallelism between the lines marking the publications relating to applied geology and the annual allotments of public funds for geologic surveys is probably not entirely fortuitous.

Perhaps the best measure of popular confidence in the results of geologic research is the number of different geologic organizations supported by public funds. We are apt to credit the obtaining of Government support for this or that research entirely to some individual or organization, forgetting that, until the general public has in a measure been persuaded of its value, all efforts would be useless. Therefore, when we find geologic surveys throughout the country supported by Commonwealths having widely different social and industrial conditions, it is fair to presume that the average citizen has acquired the belief that these are attaining results beneficial to the community. The numerical increase of State geologic surveys during the last 25 years is illustrated by the curve on the diagram before you

which marks the percentage of total number of States supporting geologic work (fig. 1). In 1886, 24 per cent of the States had geologic surveys; in 1895 the percentage was 42, and in 1910, 80.

This growing public interest is also manifested by the increase in geologic teaching at colleges and universities. I interpret the statistics published by Prof. T. C. Hopkins as indicating that in 1886 there were about 220 of the higher institutions of learning in which geology was taught, while in 1894 there were 378. Of these, 51 had geology organized as a separate department. I have been unable to find any more recent data on geologic education, but that it has made great strides in the last 17 years will be conceded by all. It will also be generally admitted that the teaching of economic geology is receiving constantly greater attention in the colleges and technical schools. More significant evidence of the present status of geology among the people is the fact of the large number of geologists now in private employment. There are many professional geologists who are engaged in consulting practice. Nearly every large mining company and many railways include in their personnel one or more geologists. In a commercial directory of mining experts recently published fully 10 per cent classed themselves as geologists, while an edition of the same directory issued 10 years ago included only one who claimed to be a geologist. While at that time, as now, many mining engineers were in fact professional geologists, they did not care to advertise the fact.

All this indicates that applied geology has during the last two decades become a dominating element in our geologic work; also that this tendency toward industrial problems pervades all geologic investigations, whether under Federal, State, or private auspices. Furthermore, it has been made evident that this trend is not limited to the North American Continent, but is world-wide. It is clear, also, that since emphasis has been laid upon the economic side there has been a marked increase in the support given to geologic work, from which fact may be drawn the logical conclusion that the public indorses this policy. It does not necessarily follow that this dominating practical note in geology has made for the advancement of the science. Before discussing this important question it will be well to trace briefly the origin of geology as an applied science.

It seems to be generally assumed that the application of geology to industry was not attempted until after its development into a more or less complete rational science. It can not be denied that the application of the principles of a science must await the establishment of those principles through scientific inquiries. It is true, however, that long before geology had developed as a science men observed the geologic phenomena that bore on certain vocations and often correctly interpreted such observations.

The science of applied geology, therefore, had its origin among those who, like the miners, were by vocation brought into intimate contact with natural phenomena. Many of the elementary facts relating to mineral deposits were forced on the attention of the miner, and as the correct interpretation of these facts added to his material welfare, some deductive reasoning was undoubtedly applied. The rudimentary conceptions thus formed were more likely to be correct than those of the early closet academician, whose science for generations began and ended in pure speculation.

Therefore, to trace the origin of applied geology the oldest archives treating of mining, quarrying, agriculture, engineering, and mineralogy must be searched—a task which has been quite beyond me. And reaching far back of any written record was the traditional lore bearing on geologic phenomena of countless generations of miners and husbandmen. Even the man of the stone age must have subconsciously acquired knowledge of the distribution of the materials which he fashioned into implements of the chase and war. If we are to allow our imagination full scope, we can conceive of some primitive economic geologist who, by finding a deposit of copper and revealing the superiority of the new material for weapons, became the hero of his tribe.

While our Aryan ancestors appear to have been ignorant of the use of metals when they first invaded the Mediterranean countries, yet they acquired a knowledge of them from the Semitic races long before the dawn of history. In winning these metals primitive man used methods which required neither any high degree of technical skill nor a knowledge of the form of their occurrence. Mining, being second only to agriculture in its importance to the human race, became more systematized with the progress of civilization. By the time historical records began the recovery of metals and the quarrying of building stones were well-developed arts, and there is no reason to suppose that the mode of occurrence of the deposits exploited were ignored by those whose livelihood was involved.

The rulers of this early period, keenly alive to the value of the metals, undoubtedly caused this source of wealth and power to be investigated by able men. It is recorded that Philip of Macedon evinced his interest in mining by examining in person some underground workings in Thrace. Jason's search for the golden fleece pictures the prospector of those days as a national hero. In any event, it is certain that millions of ounces of gold and silver and many tons of copper, as well as tin and iron, had been produced centuries before the Christian era. We must believe that this production indicates a sufficiently developed industry to employ not only skilled artisans but also those who delved deeper into the problems of mining. The ancient Egyptians were eminently

practical and developed a high degree of skill in certain branches of engineering. Undoubtedly the Egyptian engineers paid some heed to the distribution of building stones as well as to methods of quarrying, while among other peoples who excelled in metal mining it is presumed there were engineers who specialized in mining matters, as do their successors of to-day.

It is far easier to speculate on the knowledge the ancients may have had of some of the principles of applied geology than to trace the actual extent of this knowledge. Ancient Hebrew literature abounds in references to the metals and their utilization, but furnishes little clue as to what was known of them. The same is true of the records of ancient Egypt, in which both placer and lode gold are mentioned. One document that has come down to us shows that location of mineral wealth was considered worthy of note. An ancient papyrus, dating about 1350 B. C., displays a crude map for the purpose of locating Nubian gold mines. It is one of the oldest maps in existence and the first which can be said to impart geologic information. The oldest written record of geology or allied subjects is Theophrastus's descriptions of metals, stones, and earths, dating back to 315 B. C. Pliny's work of four centuries later seems to have been the first attempt at a complete treatise on minerals of economic importance, but he was more concerned in the utilization of the metals than in their mode of occurrence. Other of the ancient writers, notably Aristotle, touched on geologic subjects, but rather from the standpoint of speculative philosophy than of interest in material problems. Some of the early geographers and historians, like Strabo and Herodotus, discussed the geographical distribution or the exploitation of metals. Another field of applied geology is found in treatises on agriculture containing references to character and distribution of soils. Even Virgil in his *Bucolics* attempts a practical classification of soils. As this dwells on the physical rather than the chemical properties of soil, it would seem to have at least the merit of being in accord with some of the latest scientific maxims.

I have dealt with this subject as if the nations of Europe and western Asia had alone made advances in technology. Mining and metallurgy, even in very early times, were important industries in both India and China, and it is not unlikely that there may be in those countries a literature of practical geology which antedates our own.

The meager records of the early period of mining give no clue to the knowledge of applied geology held by the ancients. But that they were not entirely ignorant of its principles is to be presumed from the importance of the mining industry, and the absence of written records does not argue against this theory. The same is true

of other arts. We do not assume, for example, that the principles of mechanics applied to structures were not understood because there were no written treatises on architecture until centuries after many periods of architecture had successively developed and declined.

Scant as is the literature of mineralogy and mining up to the early part of the Christian era, the succeeding 10 or 12 centuries are almost entirely without records. This was the medieval period of intellectual stagnation—the eclipse of scientific and critical thought. The Arabs, who alone preserved the traditions of antiquity during this lapse, made considerable contributions to scientific knowledge, not neglecting mineralogy. Aside from this, there are only a few minor references to the subject in the chronicles of that time.

While science was neglected in the Middle Ages, the arts continued to progress, and among these mining was important. It is recorded that in Charlemagne's time thousands of miners were employed in the metal industry of northern Tyrol, and many other countries made notable contributions to the metallic wealth of the world. Coal mining began in England and Germany in the twelfth century. In fact, the mining industry assumed an importance which attests a high degree of administrative and technical skill.

With the revival of learning in the fourteenth and fifteenth centuries, scholars began again to turn their attention to the natural sciences. At first they labored solely to verify and amplify the theories of the ancient writers, never doubting that the classical philosophers had encompassed the entire realm of human thought. Generations of scholars sought their science in the Greek and Roman literature. But with the Renaissance scholastic thought was freed, and then the first epoch of scientific geology began.

The wide chasm which separated the academician from the technician at that time prevented any utilization of the great store of geologic facts accumulated by miners. The miner had neither education nor incentive to record the facts so laboriously collected; the scholar had yet to realize that nature must be studied by observation and deduction, not by speculation alone. The cosmogonist wrote his treatises on the origin of the world with his vision limited by academic walls, while the miner held his knowledge as important only for his need.

Agricola was one of the first scholars to consider the practical problems of the miner. His works, published in the middle of the sixteenth century, show both keen observation and realization of the importance of applied geology. The German mining industry had at that time advanced sufficiently to have a large technical vocabulary of its own. But as Agricola wrote in Latin, he was forced to translate these technical terms as best he could. German mining methods and terminology must then have found wide accept-

ance in Europe, for Pierre Belon, the French naturalist, recorded that in 1546 they were in use in the Thracian gold fields—then as now a part of the Ottoman Empire.

In Agricola's day there appeared a number of other treatises dealing with some phase of applied geology. These were mostly devoted to mineralogy, which was destined to become a science long before geology had passed beyond the speculative stage. Most of this early literature was in Latin and therefore calculated to have little influence on mining practice. It did, however, bring the scholar into closer touch with the phenomena of nature and thus pave the way for a rational science of geology.

In the early history of the science pure and applied geology can be compared with two confluent rivers having widely separated sources—the one springing from the high realm of speculative philosophy, the other having a more lowly subterranean origin. These two streams of thought gradually drew together, for a space flowing side by side, and finally merged into one great stream.

The following passage, written by Peter Martyr, in 1516, while describing the golden wealth of Hispaniola, reflects something of the status of geology in his day:

They have found by experience that the Vein of gold is a living tree, and that the same by all ways spreadeth and springeth from the root, by the soft pores and passages of the Earth, putteth forth branches, even to the uppermost part of the Earth; and ceaseth not until it discover itself unto the open air; at which time it sheweth forth certain beautiful colours in the stead of flowers, round stones of golden Earth in the stead of fruits, and thin plates in stead of leaves. . . . For they think such grains are not engendered where they are gathered, especially on the dry land, but otherwise in the Rivers. They say that the root of the golden Tree extendeth to the center of the Earth, and there taketh nourishment of increase: for the deeper that they dig, they find the trunks thereof to be so much the greater, as far as they may follow it, for abundance of water springing in the Mountains.

This fantastic account of gold deposits contains a sufficient kernel of truth to indicate that the writer had at least some comprehension of the form of auriferous veins and their relation to gold placers.

One of the earliest recorded attempts of a practical application of geology is that of George Owen, a country squire of Wales, who about 1600 prepared a lengthy description of Pembrokeshire in which he discussed the occurrence of limestones and coal. He appears to have been the first to note the change of bituminous coal to anthracite. Owen's practical purpose is made clear by the following quotation from his writing:

. . . it may be a guide to some parties to seek the lymestone where it yet lieth hidden and may save labours to others in seeking it where there is no possibility to find it.

While men of the Agricola type were assembling and classifying observations on minerals and ore bodies, another group of scientists

was engaged in wordy wars about such problems as to whether fossils had been formed by the influence of stars or were the remnants of former living organisms. It is noteworthy that among the most rational contributions to this discussion, which continued over a century, were those of Leonardo da Vinci and Nicholas Steno, the first of whom based his arguments on his own observations as an engineer, while the second had some practical experience in the study of ore bodies. These two belonged to the class of scientists designated by John Webster in his *History of Metals*, published in 1671, as "experimental observers," of whom he says:

For either they were such as attended the mines, or went thither to converse with the workmen to inform themselves, or bore some office about those places, or were those that either for curiosities sake, or to enrich their knowledge, did gather together all the minerals they could, or used the most of all these ways to gain understanding. And therefore I commend these above all the rest before named, to be read and studied of all officers and men belonging to any mineral or metallick works; and of all young students and beginners that seek after mineral knowledge: because these authors speak not altogether by opinion, fancie, and conjecture; but forth of their own experience, and the experience of those that were conversant about the mines, and getting of ore, and purifying and refining of them; and therefore more certain to be relied upon for leaders and teachers. And more, because they have written what they knew, openly and plainly as the subject would bear; and not in parables, and ænigmatical expressions.

This treatise contains, amid much that now appears childish, some practical hints for the discovery of ore bodies. Webster laments the almost universal ignorance of this subject, which he accounts for as follows:

That the way and means to discover the nature of minerals, is not onely difficult and dangerous, but in itself is so sordid, base and troublesome, that the most men of parts, will hardly adventure themselves into the pits or shafts where ores are usually gotten; nor can indure to stay so long, that they can rightly inform themselves of anything that may be satisfactory to their inquiries. And the Miners or Workmen (for the most part) being but people of the most indigent sort, and such as whose knowledge and aims reach no higher than to get a poor living by that slavish labour, regard to inform themselves of no more then what may conduce to such a poor and servile kind of living; by which means they are little able to give any learned man satisfaction to those necessary inquiries that might tend to enable him to judge rightly of the nature of the things in that subterraneous kingdom.

The prejudice of the scholar against learning from the miner, so quaintly described by Webster, gradually died out in the eighteenth century. Thereby the science profited much, through acquiring a better groundwork of fact, while, on the other hand, technology derived assistance from applied science. Even before Werner's day a number of mining officials discussed in print the occurrence of mineral deposits. As a result of this better understanding between the scientist and the practical man geology developed from a condition of pure speculation into a science which approached the rational and

concrete. It need hardly be added that the advances made in chemistry, physics, and biology were essential to this progress.

By the latter part of the eighteenth century conceptions of stratigraphy began to take definite form. In this field, again, the miner to a certain extent forestalled the scholar, for he had recognized that locally, at least, the earth crust was built up of superimposed strata having a definite order. He had also noted that this order was sometimes interrupted by breaks and in the underground workings had opportunity to grasp some details of tectonic geology.

The advancement of science and arts toward the end of the eighteenth century had been such as to create a demand for trained engineers. In the field of technical education mining was given the first recognition, for the school at Freiberg was established in 1765, 20 years before the existence of schools of any other branch of engineering, except those devoted to military science. This school was to have a world-wide effect on geology, through the influence of Werner, the first great teacher of the science. The founding of other mining schools followed rapidly, indicating a need throughout continental Europe for trained mining engineers. With the exception of Freiberg none of these schools gave special heed to science, but their establishment was of great importance to applied geology, as it gave definite recognition to the fact that mining was to be directed by engineers and not by artisans. The advent of the trained mining engineer was of first importance, for on him was to fall much of the work of advancing the new science.

On the Continent mining was chiefly carried on by or under the direct supervision of the State, and the need of properly trained engineers was probably the chief reason why technical mining education began before other branches of engineering. In England, on the other hand, mining was mostly a matter of private enterprise, and technical education lagged far behind the Continent. The men entrusted with the direction of mining affairs seem to have been drawn from the practical school of experience and were known as mineral surveyors. To this class belonged William Smith, the founder of stratigraphic geology.

Worthy of note also is John Williams, a mineral surveyor, who preceded Smith by one generation. Williams was a Welshman, who was bred as a miner, served as a soldier under the Dutch flag, and held various responsible positions in the coal and lead mining industries. In 1789 he published a *Natural History of the Mineral Kingdom*, which is remarkable for expressing some of the modern views on applied geology. It contains a large number of accurate observations, notably on coal and lead deposits. In discussing ore deposits Williams suggests a probable genetic relation between

intrusive dikes and mineral veins. Unfortunately for Williams's standing as a scientist, he considered it necessary to present a theory accounting for all geologic phenomena and to show the errors in Hutton's conclusions, which had then just appeared.

Inasmuch as Williams treated coal deposits quantitatively, he was far ahead of his generation. He pointed out that coal beds are definitely limited, and this at about the time that Werner was preparing to launch his theory of "Universal formations." A few quotations from his book will serve to illustrate Williams's attitude:

The result of his investigation refutes by inference another erroneous opinion concerning coal, which I have often heard asserted with great confidence, viz., that coal is inexhaustible. That the fund of coal treasured up in the superficies of the globe, for the accommodation of society, is very great, I readily acknowledge; but that it is inexhaustible, in the proper sense of the word, I deny.

If our coals really are not inexhaustible, the rapid and lavish consumpt of them calls aloud for the attention of the Legislature, because the very existence of the metropolis depends upon the continued abundance of this precious fossil, and not only the metropolis, but also the existence of the other cities and great towns, and of the most fertile countries in the three kingdoms, depend upon the abundance of this valuable article; and moreover, most of our valuable manufactures are in the same predicament, and, therefore, if our coal mines are not inexhaustible, it is high time to look into the real state of our collieries.

I feel in myself a strong reluctance against sounding the alarm to my country in a matter of so much importance. I am but an obscure individual of very little consequence in the world, and I have not the least doubt that I shall be severely censured by many for my presumption, and therefore I proceed with sensible remorse; but it is not guilty remorse; on the contrary, my heart tells me, that were I to temporize with my own feelings of reluctance, and to conceal a truth which so nearly concerns the welfare of the community, for fear of incurring censure, my silence would be unpardonable.

The present rage for exporting coals to other nations may aptly be compared to a careless spendthrift, who wastes all in his youth, and then heavily drags on a wretched life to miserable old age, and leaves nothing for his heirs.

While Williams's dire prophesies, made a century and quarter ago, of the early exhaustion of England's coal have not been justified, yet he seems to have been one of the first to urge upon public attention the close relation between the prosperity of a nation and its fuel supply. He was also a pioneer in recommending governmental surveys and investigations of mineral resources. After pointing out the value of the Cape Breton and other coals in the British North American possessions and recommending their development, he goes on to say:

In discussing this topic, we presume to suggest, that, in the first place, it is necessary for Government to explore and discover these coals, and lay them bare for the inspection of British coal masters or companies, and with this view, the first thing to be done, is to employ a prudent man of abilities and skill in the theory and practice of the coal business; to survey the West India coals and coal fields; to make such trials upon the coals already discovered, and those he may discover, as may be necessary to

ascertain the thickness, quality, and situation of each stratum of coal that may be judged worth attention; and to make out a full and substantial report of all the material circumstances relating to each coal, for the information and use of Government, and of such gentlemen and companies as may wish to look into this interesting subject.

These recommendations for governmental surveys of mineral resources were made a generation before they were followed and fully half a century before the nations of the world were generally to accept the principle. Williams also touches on some of the problems which absorb us to-day. After advocating the investigation of the colonial coal fields, he says, in words which have a familiar ring:

When this report is made and considered by Government, suitable encouragement should be offered to gentlemen and to companies of character, stock, and abilities for such undertakings, to open and work some of these coals. . . .

The first undertakers should be allowed a sufficiently extensive coal field, and every reasonable privilege and indulgence; but they should not have a monopoly. Other adventurers should have room to employ their skill and capitals in this line of business in the west as well as in Britain. Monopolies seldom do much good. The views of monopolists are always too selfish and confined to be of extensive utility and public benefit.

While Williams was among the first to recommend governmental mineral surveys, the idea of showing mineral deposits on maps appears to have been a part of a plan for soil maps conceived by Martin Lister a century before, and put into practice by Guettard in 1746. Sir Archibald Geikie has credited the first geologic map to this eminent French naturalist, but has not sufficiently emphasized the fact that Guettard's map also showed the distribution of mines and mineral deposits. Others followed his example, and before the close of the eighteenth century the cartographic representation of geology and mineral deposits had become well established.

The nineteenth century opened during the epoch of intellectual freedom which followed the turmoil of the French Revolution. The time was favorable to the progress of science. The scholar felt free to follow scientific inquiries to their logical conclusions untrammelled by the interdiction of authority. Nowhere was this more true than in the field of geology, for, notwithstanding the efforts of dogmatic theology for upward of half a century to dominate geologic thought, its edicts could hamper the growth of the science but little.

Further incentive sprang from the development of new political ideals. As the Nation began to concern itself with the needs of the individual citizen the application of science to human needs was encouraged. Under the old régime, so long as the wants of the ruling classes were supplied no thought was given to the wants of the masses. When this attitude was changed it was natural to seek the aid of the scientist in ameliorating conditions. Therefore the dawn of the new century was propitious not only to the advancement of pure science, but also to a general appreciation of applied science.

Nowhere were conditions for the evolution of geologic science better than in our own land. Being far removed from the controversies which occupied the sole attention of many European geologists, we could accept or reject without prejudice this or that theory. Our people had entered upon the exploitation of a new land, with boundless possibilities of natural wealth, and pioneer conditions brought most of them into intimate contact with natural phenomenon. Books of travel written in the early part of the century bear witness that a close observation of geologic facts was forced upon every traveler.

A general interest in science and its application was prevalent in America, even in colonial times. This was reflected in the scientific and practical character of educational ideals. In its first advertisement, issued in 1754, Columbia College (then called King's) provided for the instruction of youths—

in the arts of numbering and measuring; of surveying and navigation; of geography and history; of husbandry, commerce, and government, and in the knowledge of all nature in the heavens above us and in the air, water, and earth around us, and in the various kinds of meteors, stones, mines, and minerals, plants and animals, and everything useful for the comfort, the convenience and elegance of life; and in the chief manufactures of these things.

This was half a century before the idea of scientific and technical instruction had taken root in European countries. In the period extending from 1768 to 1811 chairs of chemistry were established in 11 colleges of the United States. In 1824 the Rensselaer Polytechnic Institute was founded—the first school of applied science in any English-speaking country. The avowed aim of this school was to apply “sciences to the common purposes of life.” Van Rensselaer, who founded it, was a patron of geologic science, and Eaton, the geologist, its first president.

Geology had, however, received recognition in several American colleges long before the founding of the Rensselaer Institute. According to Prof. Hopkins there were 31 American colleges which offered courses in geology previous to 1845. Of these, one began teaching geology in 1804, one in 1807, one in 1819, and one in each of the years from 1820 to 1845. The large number of scientific societies founded at this time shows the widespread interest of the people in science. Nearly every town had its lyceum of natural history, while the larger cities boasted of academies of science and similar associations, of which several have survived to the present day. In 1819 the American Geological Society was organized—only 12 years after the founding of the Geological Society of London and nearly 30 years before that of the *Deutsch Geologische Gesellschaft*.

Numerous journals devoted to science and art were established during the period under discussion. While some of these were only short lived they attest the interest in science of the American people.

Another example of this interest is found in the course of lectures on natural history which, according to Dr. Merrill, were delivered before the New York State Legislature by Amos Eaton in 1818. This is probably the only instance in our history where a body of law makers have welcomed serious instruction in scientific matters.

Most of the collegiate instruction and the scientific societies had for their purpose the promoting of knowledge in pure rather than applied geology, but it was in the latter that geology really had the support of the American people. One far-reaching influence on the development of applied geology in the early part of the last century was the scarcity of mining engineers or experienced operators, while the vocation of prospecting was almost nonexistent. Our mining industry was in the early stages and there were almost no engineers and but few so-called practical men to whom the people could turn for information. In European countries, on the other hand, centuries of mining had developed a class of professional men other than geologists who were considered authorities on mineral wealth. But in our own country it was the scientist rather than the engineer or the practical miner who was called upon for information. This not only led to the utilization of science in the preliminary work of seeking mineral deposits, but also had the effect of forcing the scientists to give their investigations a practical turn.

Either from choice or necessity, the early American geologists, like their successors of to-day, always emphasized in their work the needs of the community. McClure devoted much of the brief text which accompanied his geologic map of the eastern United States to the relation of geology to agriculture. Eaton's first work bore on the resources of the region adjacent to the Erie Canal. Rodgers elucidated the structure of the coal fields, while Jackson attempted a classification of the public lands of the State of Maine.

I venture the opinion that one reason why the investigators of this continent have accomplished so much for the advancement of geology is that their research has never been entirely divorced from the field of applied science. We have had no distinct schools of pure and applied geology, as there were until recently in other lands. In Europe there was the practical school of the miner, whose scientific conception seldom reached beyond his immediate environment; and there was the school of the scholar, whose angle of vision was apt to be too wide to focus on facts near at hand. There were, indeed, some exceptions, for the scholar Agricola learned from the miner; Werner's teaching was, in theory at least, an application of geology to the mineral industry; and William Smith used his knowledge of stratigraphy in the practice of his engineering profession. Even in Europe the distinction between the work of these two schools has now almost disappeared.

The general interest and faith in science during the early history of our country is well exemplified in the attitude of public men. Our first two presidents, in spite of the fact that they differed greatly in temperament and experience, showed more interest in scientific work than almost any of their successors. Washington's training as an explorer, surveyor, and planter and his close connection with the beginnings of the iron industry is perhaps sufficient to account for his attitude toward science. He is probably the only President who, by his own efforts, attempted to advance applied science. While President he started an investigation of the soils of the Eastern States through personal correspondence. More important, however, was the work of Jefferson, in bringing about the establishment of the chair of chemistry at the University of Virginia, thereby introducing scientific teaching into this country. He also discussed the mineral resources of Virginia in his book on that Commonwealth, wrote, while Vice President, geologic paper, and, above all, inaugurated that system of exploration and investigation of the trans-Mississippian region which was to yield such fruitful results in the century to follow. John Adams, while he took no personal part in promoting scientific research, manifested interest in it by helping to establish the American Academy of Arts and Sciences.

A review of the conditions which brought about the rapid growth of geologic work in this country during the first decades of the nineteenth century can not fail to consider the political and industrial situation. The War of 1812 had united as one nation the Commonwealths which up to that time, in spite of the federation, had strong centrifugal tendencies. During the war with Great Britain New England had been on the verge of rebellion, while the trans-Appalachian region was not held to the East by any strong bonds. The country, rent by domestic quarrels and the turmoil of opposing political factions, paid small heed to the problems of industry and commerce.

After the war the people thought less about State rights and more about industrial prosperity. There was no longer a French party or an English party, but men of all political faiths had come to the conclusion that we must work out our own salvation. We had learned to supply our own material needs during the war, when English frigates cut off European sources of supply. In short, the Nation had found itself and was ready to begin to harvest the resources of the vast territory which the war had settled for all time was to be our own. Our people, while possessing the self-confidence of the pioneer, were facing new problems, and, guided by their scientific instincts, turned to the scientist for help.

In spite of the fact that the war had developed a relatively strongly centralized Federal Government, yet our political theory was still

one of State rights. Moreover, the Republicans were in power, with a hopelessly small Federalist minority. It was natural, therefore, that the people, loyal to their political faith, should turn to the Commonwealths for aid in developing the new land. This aid for the most part took the form of large grants for public improvement of transportation facilities—at first for canals and wagon roads, later for railways. During the period ending with 1838 the States borrowed sums aggregating over \$160,000,000 for purposes of public improvement. Compared with this sum, the expenditures for geologic surveys were small. It is a significant fact, however, that in 1838 a larger percentage of the States supported geologic surveys than in any subsequent year until 1898. This is graphically illustrated in figure 3. The upper curve shows the total number of States and the lower the percentage of total number which supported geologic surveys between 1826 and 1910.

The very rapid increase in State surveys is all the more significant when compared with the status of governmental surveys in Europe.

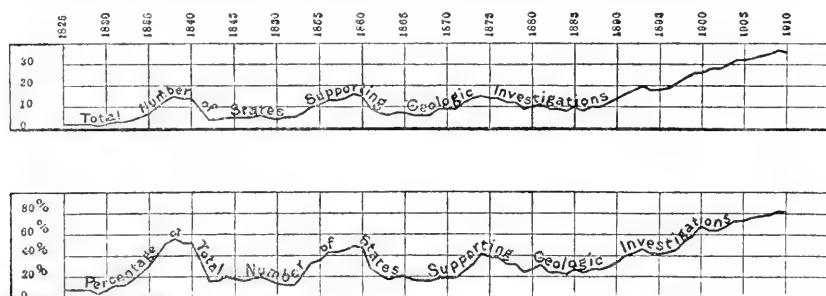

FIG. 3.—TOTAL NUMBER AND PERCENTAGE OF TOTAL NUMBER OF STATES SUPPORTING GEOLOGIC WORK, 1825 TO 1910.

Though much geologic work was done in European countries during the early part of the century, it was not until about the middle that the Governments began organizing systematic surveys. England led by establishing her survey in 1832. Next came surveys of Austria-Hungary and Spain, organized in 1849, of Bavaria in 1851, and France in 1855. Most European countries did not undertake systematic geologic surveys until about 1860, or more than 20 years after our first maxima of State surveys had been reached.

As already indicated, the principal influence that led to this first era of State surveys, as Dr. Merrill has called it, was the widespread interest in scientific investigations and the great industrial advancement which created a demand for the practical results of such investigations. A good example of the faith the people had in applied geology is found in the first geological survey made in Georgia, which was paid for by landowners of two counties—a condition that has never been repeated until recently in some of the rich mining districts of the West.

Another reason for the large number of State grants for geologic work lay in the general westward movement of population from the Atlantic States. This had a twofold effect on geologic surveys. First, it gave rise to a demand for information about the new lands, and second, it put the older States on their mettle to hold their population. So rapid was the westward movement that the Atlantic States became alarmed for their future. In 1815 and 1816 the legislatures of both North Carolina and Virginia appointed committees to devise means for checking the drain on their population. This was unquestionably the motive in establishing many of the Eastern State surveys and in directing their activities toward agricultural problems.

Meanwhile the Federal Government had undertaken the investigation of the resources of the unorganized western Territories. The chief purpose seems to have been a classification of the public lands—a work which was to be interrupted for over half a century and then resumed as the proper function of Federal geologists.

According to Dr. Merrill¹ the first epoch of State surveys declined even more rapidly than it arose, due largely to the financial crisis of 1837. An era of promotion, inflation, and straining of State credits to their uttermost, accompanied by a waste of the borrowed millions and the lack of any sound Federal financial policy, resulted in a money panic, the collapse of many ill-advised enterprises, the repudiation of their public debts by several of the States, and a widespread commercial depression. It is no wonder that, under these conditions, geologic surveys were regarded as luxuries that might well be spared; particularly since these first governmental surveys, it must be admitted, hardly justified themselves from the standpoint of practical results. This fact does not detract from the credit due the pioneer geologists who carried on these surveys under almost insuperable difficulties. They learned much about areal distribution of the larger geologic units, but most of the investigations were not detailed enough to yield results of practical value. Moreover, even in that day many geologists were still living in "flat land"—they considered formations in only the two horizontal dimensions; for while the vertical element was by no means ignored, it was not clearly understood.

During the decade following the panic, few States had surveys, and no great progress was made in the science beyond the publication of results attained in the previous era. Though the contributions to geologic literature by the class of professional geologists—whose appearance was perhaps the most important result of the activity of the previous decade—were not unimportant, yet as a whole both pure and applied science were at a rather low ebb.

¹ The extensive use I have made of "Contributions to the History of American Geology," by G. P. Merrill, Washington, 1904, will be evident to all who have read that work.

The panic was but a temporary check to the industries, however. The estimated production of pig iron was 347,000 tons in 1840, and 600,000 in 1850, while the coal production during the same period increased from 2,000,000 to 7,000,000 tons, and the railway mileage from 2,818 to 9,021. These industrial advancements were accompanied by the rapid settlement of the Middle West, by the beginnings of copper mining in Michigan in 1844, and of iron mining in Michigan and Missouri in 1853, and most important of all, the discovery of gold in California in 1848. All this activity gave a new impetus to geologic work, which is reflected in the revival of interest in State surveys. At this time, too, men began to dream of a transcontinental railway, and therefore the Federal Government undertook a more systematic exploration of the western cordilleran region than had previously been made. The curve of State surveys, as seen in the diagram, continued to rise until the outbreak of the Civil War. In this second epoch of geologic work the States of the Middle West—then the frontier—led. This was but natural, because history has proved geology always appealed more strongly to the pioneer than to any other class of people.

It is difficult to measure the accomplishment of this second period of geologic activity under State and Federal auspices, owing to its abrupt termination by the Civil War, which interrupted many important investigations. One fact stands out clearly: That applied geology was the mainspring of most of the research, and the results indicate that pure science had not been the loser thereby.

The prosperous time following the Civil War in the North and West, with its almost unique industrial advancement, again centered public interest on mineral resources. This caused the Federal Government to resume explorations in the West, which took the form of areal geologic surveys and in some cases detailed study of mineral deposits. Many States undertook similar work, and the curve of geologic surveys arose until the interruption by the panic of 1873.

The results thus attained proved a final justification of geology, not only as an intellectual pursuit, but also as a practical aid to mankind. While the immediate benefits of these investigations were large, they were not so important as the institution of geologic mapping, based on accurate mensuration. Crude as those maps were compared with the present standards of refinement, they represent the earliest general attempt in this country to apply engineering methods to geologic problems. It was very unfortunate that this first epoch of engineering geology, as it might be called, was so soon interrupted and the work practically discontinued for over a decade. The people were, in fact, hardly educated up to an appreciation of its value; moreover, the natural resources that could be readily exploited

without the aid of science were so extensive that the time was hardly ripe to make full use of this new geology.

We have seen that the period following the Civil War was especially favorable to the development of applied geology. The same is true of pure science. This, in fact, has been the history of geology in this country—advances in pure science were always in more or less direct proportion to advances made in the applied science.

It has been shown that, in the early history of the Nation, the genius of the American people was essentially scientific. A deep interest was felt both in the facts and deductions of science, and in the affairs of life deference was paid to the opinion of the investigator. Unfortunately, for reasons which are difficult to fathom, this scientific attitude gradually declined. At the beginning of our national existence we were in close contact with the intellectual life of Europe, which was then essentially scientific. This gave us our first intellectual stimulus and led us to do our full share of the work of advancing both pure and applied science. Then came an interim between the time when we forsook the intellectual standards of the Old World and before we fully established those of our own. Meanwhile, the opening of a continent, with its unbounded resources, was calculated to bring out the characteristic efficiency and self-reliance of the average American. Then gradually developed what may be called the era of the "practical man"—an era characterized essentially by unscientific thought among the mass of the people. The "practical man" now became a national fetish, and the people, overlooking the fact that his success was due to energy and opportunity, attributed it rather to the absence of technical and scientific knowledge. Nowhere was this national trait better shown than in the mineral industry, where the era of the "practical man" cost the Nation untold millions. His distrust of applied science was deep-rooted. For a generation every mining community swarmed with these self-styled experts, whose technical and scientific limitations were only exceeded by their blatant self-assertion.

Unfortunately, at this time there also developed between the geologist and the mining engineer an antagonism which was detrimental to the advances of the science. A school of geology arose which revived to a certain extent the ancient practice of speculation without observation and regarded itself as moving in a higher intellectual sphere than that of the engineer, who dealt with practical problems. On the other hand, many engineers came to regard all work of the geologist as either visionary or purely speculative.

Since the rise of the modern school of applied geology, which may be said to have begun in the eighties, this antagonism between the engineer and the geologist has gradually disappeared. The geologist has made his results of more value by adopting some of the methods

of the engineer, while the engineer no longer hesitates to use geology in his own field. Both professions have been improved by this mutual help, and the geologist has by no means gained the least. The modern mining engineer now recognizes that, even in his own special field, scientific investigations are essential. This is evidenced by the general hearty support given by engineers to the new Federal Bureau of Mines.

It is not necessary to describe in detail the recent progress in applied geology. While most of the countries of the world have taken part, it is a field that the American geologist has made peculiarly his own. Among our important contributions in this field is the geology of mineral oils, presented by Mr. Campbell to this society last year. In this, as in the survey of coal deposits, stratigraphic and structural geology have almost come to be exact sciences. Equally important to to the Nation are the results achieved in underground water investigations. The tectonics of mineral veins now also approaches an exact science; while many of the conclusions on the genesis of ore bodies, notably that of secondary enrichment, are among the triumphs of applied geology.

Moreover, the field is being extended. In Germany the work of the geologist is regarded almost as essential to railway or canal location as that of the engineer—a lesson we have only recently learned at Panama. The investigations of soils is now a distinct science, based largely on applied geology. Questions of public health, such as purity of water and sanitation problems, also in part fall in the domain of the geologist.

A significant phase of the new epoch in applied geology is its contributions to political economy. A striking example of this is the geologic survey of Korea, executed by the Japanese during their war with Russia. It need hardly be said that this was not made for the purpose of advancing geologic knowledge, but solely to gain a scientific valuation of the land which was costing so much blood and treasure. Though the present status of the science does not permit of a quantitative determination of resources which is more than approximate, yet the fact that geologists are being called upon by political economists for assistance indicates how fundamentally the science affects the welfare of the Nation.

This historical survey of applied geology, in which special emphasis has been laid on its progress in this country, seems to point to several conclusions. First, that much of the modern science of geology originated in the field of applied science. It was the striving of mankind to solve problems of material welfare that gave the first impulse to geologic thought. Second, that, as a rule, the science has made most rapid strides at those times when its study was inspired by a desire to achieve some practical end. Whenever geology has become

entirely divorced from industry it has drifted toward pure speculation. The geologists of the past, like those of the present, received much of their inspiration from the fact that they were adding to the material welfare of mankind. Werner, Humboldt, Von Buch, De la Beche were not only trained as mining engineers, but continued for most of their careers to be intimately connected with the mining industry. Desmarest devoted most of his life to promoting the industrial advancement of France. William Smith was an engineer before he was a geologist, and even Hutton knew from personal experience the value of applying the sciences of agriculture and chemistry. On this continent McClure, Eaton, Rodgers, Owen, Leslie, Logan, Whitney, Orton, Cook, Dawson, and King, with a host of others, were all identified with the industrial application of their science. The elder Silliman, in an account of his own training in geology, said, "I learned in the mining districts how and what to observe." The years that Dana spent on explorations may be counted in the field of applied geology. James Hall, for two generations the leader in American geology and the founder of that organization which for three-quarters of a century has preserved the highest scientific ideals, gained his early inspiration in studying practical problems. An enumeration of the leading geologists of the present generation will, I think, show that the larger part have given much attention to the material application of geology.

The recent economic trend of geology is only a counterpart of similar tendencies in most fields of scientific research. The introduction of science into practical affairs is a feature of the present age. It has come about not only because as the sciences progressed their results were more directly applicable to material problems, but more specially because of the gradually changing conditions throughout the world. With a sparse population and abundance of natural resources the need of applied science is never so evident as when the lands become crowded and the more readily accessible resources depleted. The people of a virgin land need pay small heed to exhaustion of soil or destruction of forests, and can carry on shallow mining operations with little recourse to science or technology. It is only when increasing population results in a demand for a greater food supply and makes sanitation important, when the depletion of timber becomes a factor in cost of structures, and the superficial deposits can no longer yield sufficient minerals, that the need of scientific knowledge becomes strongly emphasized. This stage has been reached in most of the civilized countries of the world to a greater or less extent, and the evils of relative overpopulation and depletion of nature's wealth are resulting in an appeal to applied science. China stands alone among the great nations of the world in not utilizing scientific thought to better the conditions of her

people. The present turmoil in China can probably be interpreted, in the last analysis, as a protest against the affairs of state being guided by the classicist rather than by the scientist.

While we may criticize China for not accepting the dictum of science, we have only recently departed from a similar attitude, though our abundant resources have made our own faults less conspicuous. In this respect the present generation has made greater strides than all that preceded. We are now applying science to the affairs of the Nation as never before. The old-fashioned publicist, with his classical education or, at least, traditions, is being shouldered out of the way by the man who analyzes the problems of public welfare on scientific principles. The trained investigator is being more and more appealed to in the affairs of the Nation. In this we are following Germany, whose long leadership in pure science has now been overshadowed by her leadership in applied science. We have begun to realize that it is one thing to win prosperity and happiness out of the bounty of a new land, another to gain it by utilizing resources which can only be made available by scientific genius.

Mr. Gilbert has said that "pure science is fundamentally the creature and servant of the material needs of mankind." Yet it is not uncommon to find the devotee of pure science assuming that his field is on a higher plane than that of those studying problems which involve the material welfare of the human race. This seems specially true in the field of geology. If a bacteriologist finds a new toxin for a disease germ, a botanist a new food plant, a sanitary engineer a measure for preserving human life, all unite in commending his work. Yet there are not a few geologists, though I believe a constantly decreasing number, who seem to view with suspicion any attempt to make the science of geology more useful. Those who are devoting themselves to economic geology are charged with commercializing the science, as if the applying of its principles to better the conditions of the people were not the highest use to which scientific research could be put. One reason for this attitude is because much which has been masquerading as applied geology is not science at all. The commercial exploitation of natural resources under the cloak of geology is not to be confounded with geologic research that has for its aims the application of scientific principles to the needs of man.

The geologist who is studying the resources of the public domain to the end that a sound policy may be adopted for their utilization, or he who is gaging the exhaustion of our mineral wealth by studying statistics of production, is doing his share of scientific work no less than he who is engaged in the more pleasing task of evolving new geologic principles. The masters of the science have not hesitated to turn their attention to economic problems. Clarence King deserves

no less credit for his aid in opening up the West by economic investigations than for his contributions to knowledge on the age of the earth. We think of Maj. Powell as one of the founders of physiographic geology, but his memory will live rather for employing science to make available the latent fertility of the arid regions of the West. Surely no one will charge King or Powell with commercializing their science.

As I see it, there lies no danger in the present trend toward applied geology, provided our applied geology rests on a broad basis of scientific research. If the spring of pure science is cut off, the stream of applied geology must soon run dry. There is no field of pure geology which will not yield results applicable to questions of material welfare. On the other hand, any given investigation in applied geology may lead to problems of paleontology, petrography, geophysics, or other branches of pure science. In view of the pressing demand for results, we are justified in giving precedence to those fields of investigation which promise the earliest returns of material value. There is, however, grave danger that, carried away by the present furor for practical results, we may lose sight of our scientific ideals. Applied geology can only maintain its present high position of usefulness by continuing the researches which advance the knowledge of basic principles. Future progress in applied geology depends on progress in pure geology.

THE RELATIONS OF PALEOBOTANY TO GEOLOGY.¹

By Dr. F. H. KNOWLTON,
United States Geological Survey.

Although there is vague mention of fossil plants in literature as early as the thirteenth century, and unscientific adumbrations in the faintly growing twilight of the succeeding centuries, the real science of paleobotany did not have its beginning until well on in the nineteenth century. With the publication, in 1828, of Brongniart's "Histoire des végétaux fossiles" and the "Prodrome," there was given to paleobotany "that powerful impetus which found its immediate recognition and called into its service a large corps of colaborers with Brongniart, rapidly multiplying its literature and increasing the amount of material for its further study" (Ward). In the succeeding decades, even to the close of the century, the students of paleobotany were mainly occupied in accumulating data as regards distribution, both areal and vertical, and the opening decades of the present century find the subject a recognized, respected, coequal part of the general field of paleontology.

Paleobotany, together with all the other branches of paleontology, admits of subdivision into two lines or fields of study—the biological and the geological—depending upon the prominence given to the one or the other of these phases of the subject. The biological study is, of course, concerned especially with the evolution of the vegetable kingdom, that is, with the tracing of the lines of descent through which the living flora has been developed. As this side of the question will be taken up by other contributors to this discussion, it may be dismissed from further consideration, as the geological aspect is almost exclusively the phase of the subject to which the present paper is devoted.

In the first place it will be necessary to call attention to the fact that the successful use of fossils of any kind as stratigraphic marks is—or at least may be—entirely independent of their correct biological interpretation. To most botanists, and indeed to some paleobotanists, this statement will doubtless come as a surprise, since they have come to imagine that the impressions of plants, the form

¹ Reprinted by permission from *The American Naturalist*, vol. 46, April, 1912.

in which they are most made use of in this connection, are so indefinite, indistinct, and unreliable that they can not be allocated biologically with even reasonable certainty, and hence are of little or no value. As a matter of fact hardly anything could be further from the truth, and it can be confidently stated that it makes not the slightest difference to the stratigraphic geologist whether the fossils upon which he most relies are named at all, so long as the horizon whence they come is known and they are clearly defined and capable of recognition under any and all conditions. They might almost as well be referred to by number as by name, so long as they fill the requirements above demanded, though of course every stratigraphic paleontologist seeks to interpret to the very best of his knowledge the fossils he studies. He may—doubtless often does—make mistakes in his attempts to understand them, but his errors are undoubtedly fewer than he is not infrequently charged with. His faculty of observation is rendered acute from the close study of the restricted and often fragmentary material available, and he has learned to see and make use of characters which are often overlooked or wholly neglected by the botanist. The latter, even when he has before him the complete living plant, including root, stem, and foliar and reproductive organs, sometimes experiences difficulty in correctly placing his subject, and, to judge from some recent work, there are paleobotanists who study only the internal structure of fossil plants and yet are beset with extreme difficulty in interpreting their biological significance.

It may then be taken as settled that the needs of the stratigraphic geologist will be met if he is supplied with a series of marks or tokens by which he may unfailingly identify the various geological horizons with which he deals, while to the historical geologist who makes use of fossils in unraveling the succession of geological events the correct biological identification is of the greatest importance, for upon this rests his interpretation of the succession of faunas and floras that have inhabited the globe. As the late Dr. C. A. White has said, "If fossils were to be treated only as mere tokens of the respective formations in which they are found, their biological classification would be a matter of little consequence, but their broad signification in historical geology, as well as in systematic biology, renders it necessary that they be classified as nearly as possible in the manner that living animals and plants are classified."

While it is in no way desired to overlook or underestimate the biologic value of such fossil plants as have fortunately retained their internal structure in condition for successful study, it is probably safe to say that their value to geology as compared with the impressions of plants is as 1 to 1,000, and had we only the former there never could have been developed the science of stratigraphic paleo-

botany. For example, the collections of the United States National Museum embrace over 100,000 specimens of the impressions of Paleozoic plants, whereas of those showing internal structure there is hardly a half dozen unit trays full. In the Mesozoic and Cenozoic collections belonging to the same institution there are thousands upon thousands of specimens from hundreds of localities and horizons, while of those retaining their internal structure there are so few that they can almost be numbered in tens.

There is another and an excellent practical reason why the impressions of plants are, and will always remain, of more value to geology than those exhibiting internal structure, no matter how well this structure may be preserved. As soon as a plant impression is exhumed it is instantly ready for study and may be interrogated at once as to the stratigraphic story it has to tell, whereas the plant with the structure preserved usually shows little or nothing on a superficial examination, and requires laborious, expensive preparation before it can be identified. For example—to make a personal application—for the past five years I have annually studied and reported on from 500 to 700 collections, each of which embraced from one to hundreds of individuals, and with them have helped the geologists to fix perhaps 50 horizons in a dozen States. If it had been necessary to cut sections of these specimens before the geologist could have had his answer, it is safe to say that very little would have been accomplished.

All fossil plants must be interpreted by and through the living flora. In the more recent geological horizons the plants are naturally found to be most closely related to those now living, but as we proceed backward in time the resemblances grow less and less, and finally we find ourselves in the presence of floras a large percentage of which are without known or clearly recognized living representatives. In describing these and making them available for stratigraphic use it has been necessary to give them generic and specific names, after the analogy of the living floras, so that we may have convenient handles by which to use them. Many of these are confessedly what may be called genera of convenience, such, for example, being many of the genera of the so-called "ferns" of the Paleozoic. Some—but especially botanists—unfamiliar with the geological use of fossil plants have argued that it is unsafe, or even actually unwise, to venture to give names, not only to those without living representatives, but even to those obviously belonging to living groups. A reply to this objection seems unnecessary in view of what has been said.

The practical application of fossil plants as an aid to geology may be briefly mentioned. There have been described from—let us say—North America, upwards of 5,000 species, of which number some

1,200 are confined to the Paleozoic, perhaps 2,000 to the Mesozoic, and 1,500 to the Cenozoic. During the 60 or 70 years that this information has been accumulating it has developed that certain species or other groups enjoy a considerable time range, and therefore are of little value in answering close questions of age, while others are of such limited vertical distribution that their presence may indicate instantly a definite horizon. Thus, if he find in association impressions that we have named *Sequoia Nordenskiöldi*, *Thuja interrupta*, *Populus cuneata*, etc., it is known instantly that we are dealing with the lower Eocene Fort Union formation, since not one of these species, together with several hundred others, has ever been found outside this horizon. Innumerable other concrete examples could of course be given, though hardly necessary, yet it may be instructive to note that within a single geographic province—the Rocky Mountain region—the several plant-bearing formations present are characterized as follows: The Kootenai by 120 species, the Colorado by perhaps 50 species, the Dakota by 460 species, the Montana by 150 species, the Laramie by 140 species, the Arapahoe by 30 species, the Denver by more than 140 species, the Fort Union by from 500 to 700 species, etc. This shows that, as Prof. J. W. Judd once said, "We still regard fossils as the 'medals of creation,' and certain types of life we take to be as truly characteristic of definite periods as the coins which bear the image and superscription of a Roman emperor or of a Saxon king."

Just a word may be said on the economic application of stratigraphic paleontology. It is perhaps safe to say that never in the history of American geology has there been so close an interrelation and dependence of geology on paleontology as at present, and of this confidence paleobotany may justly claim its full share. Thus, of the even dozen of paleontologists in the employ of the United States Geological Survey and covering all branches of the subject, four are paleobotanists.

Among the many subsidiary problems connected with the application of paleobotany to geology, the use of fossil plants as indices of past climate occupies a most important place. As the majority of plants are attached to the substratum and hence are unable to migrate like most animals when the temperature of their habitat becomes unfavorable, they must either give way or adapt themselves gradually to the changed conditions of their environment. Therefore, fossil plants have always been accorded first place as indices of past climates. "They are," as Dr. Asa Gray has said, "the thermometers of the ages, by which climatic extremes and climate in general through long periods are best measured."

To those who have not given especial consideration to the subject, the idea appears to obtain that climatic variations, such as now

exist, are normal or essential, and that they were present without marked differences during all geological ages. It is now established, however, that this conclusion is entirely without geological or paleobotanical warrant, and that the most pronounced climatic differentiation the world has known extends only from the Pliocene to the present. As a matter of fact we of to-day are living in the glacial epoch in what possibly is only an interglacial period, and we know that the time which has elapsed since the close of the last ice invasion has been of less duration than was one, and possibly two, of the Pleistocene interglacial periods. We also know that the climate was milder during these interglacial intervals than has obtained since the final retreat of the ice, as shown by the fact that in eastern North America certain species of plants then reached a point some 150 miles farther north in the Don Valley than they have since been able to attain. The development of strongly marked climatic zones, at least between the polar circles, is, then, "exceptional and abnormal, and we have no evidence that in any other post-Silurian period, with the possible exception of the Permo-Carboniferous period, has the climatic distribution and segregation of life been so highly differentiated and complicated as in post-Tertiary times."¹

The regular and normal conditions which have existed for vastly the greater part of geologic time have been marked by relative uniformity, mildness, and comparative equability of climate. This is abundantly shown by the almost world-wide distribution and remarkable uniformity of the older floras. When, for instance, we find the middle Jurassic flora extending in practical uniformity from King Karls Land, 82° N., to Louis Philippe Land, 63° S., we have conditions which not only bespeak a practically continuous land bridge, but exceptionally uniform climatic conditions. To have made this possible there could have been neither frigid polar regions nor a torrid equatorial belt, such as now exist. The absence of growth rings in the stems of these plants, as well as the presence of such warmth-loving forms as cycads and tree ferns, point to the absence of seasons and the presence of mild and equable climatic conditions.

Another example of similar import is afforded by the early Pennsylvanian flora; that is, the flora of the lower part of the Upper Carboniferous. Wherever terrigenous beds of this age have been discovered, representatives of this peculiar flora, which includes such common genera as *Lepidodendron*, *Sigillaria*, *Sphenophyllum*, etc., have been found, this distribution ranging from South Africa to Brazil and Argentina, and thence over the northern hemisphere.

Similarly, the Mississippian flora (Lower Carboniferous) has been found in Spitzbergen, Greenland, and arctic Alaska, and thence

¹ See White and Knowlton, *Science*, n. s., vol. 31, 1910, p. 760.

south over Europe and America, and although somewhat older than the last, is distinctly related to that in Argentina.

On passing up in the geologic time scale we find that during late Mesozoic and early Cenozoic time the present dominant types of vegetation were firmly established. With what probability of success may these floras be interrogated as to the climatic conditions under which they existed? We find from a study of the present flora that certain types of vegetation, as well as certain plant associations, have definite climatic requirements. Thus, *Artocarpus*, or the bread fruit trees, are now confined to within 20° of the Tropics, showing that they require the moist heat of the torrid regions. If, now, we find that *Artocarpus* once thrived in Greenland, 70° or more north, during Cretaceous time, we feel justified in assuming that its climatic requirements were not very different from those of its living representatives. And when we find that it was then in association, as it is to-day, with cycads, tree ferns, cinnamons, palms, and other distinctly tropical forms we are confirmed in the opinion that at that time Greenland must have enjoyed a tropical or at least a subtropical climate.

Another example is afforded by the Fort Union formation. In the rocks of this horizon, which now occur on the wind-swept, almost treeless plains of the Dakotas, Wyoming, and Montana and thence northward to the valley of the Mackenzie, are found remains of *Sequoia*, *Taxodium*, *Thuja*, *Ulmus*, *Populus*, *Vitis*, *Platanus*, *Sapindus*, *Viburnum*, *Corylus*, *Juglans*, *Hicoria*, etc. From this array we feel justified in assuming a cool to mild temperate climate for this early Eocene flora, and further, from the presence of numerous, often thick, beds of lignite, that there was a much higher precipitation than at present.

A layer of fan-palm leaves a foot in thickness in a formation in northern Washington indicates climatic requirements in which the minimum temperature did not fall much if any below 42° F. The presence of numerous West Indian types in the Miocene lake beds of Florissant, Colo., would alone point to almost tropical conditions, but as these are associated with others of more northern affinities, it seems safe to predicate at least a warm temperate or possibly subtropical climate.

GEOPHYSICAL RESEARCH.¹

By ARTHUR L. DAY.

To write the history of the earth is a very different undertaking from writing the history of a people. In the latter case, a diligent seeker can usually find some ancient monastery where farsighted historians of an earlier generation have collected the more important records which he requires, and placed them within reach of his hand. With the earth's history, which is the province of geology, it is another matter. The great globe has been millions of years in the making, and except for a mere fragment of its most recent history, it has had neither a historian nor an observer. Its formation has not only extended over an almost incomprehensible interval of time, but we have no parallel in our limited experience to help us to understand its complicated development, and no system of classification adequate to the task even of grouping in an orderly way all the observed rock and mineral formations with reference to the forces which molded them. And even if we could correctly interpret all the visible rock records we are still quite helpless to comprehend all those earlier activities of the formation period, whose record is now obliterated.

To the student of the earth's history, therefore, the problem of gathering and ordering such a widely scattered and heterogeneous collection of effects and causes is one of somewhat overwhelming scope and complication. In the industrial world a situation of this kind soon results in replacing individual effort with collective effort in the organization of a system of a scope more appropriate to the magnitude of the task. We are familiar with industrial organization and the wonderful progress in the development of American industries which has everywhere followed it. We are also familiar with organized geological surveys and the success which has attended them in geological and topographical classification. But the idea of organizing research to meet a scientific situation of extraordinary scope and complexity is still comparatively new. The very words "science" and "research" are still regarded as referring to something out of the ordinary, something to be withheld from the common gaze,

¹ Presidential address delivered at the 700th meeting of the Philosophical Society of Washington, November 25, 1911. Reprinted by permission from *Journal of the Washington Academy of Sciences*, vol. 1, No. 9, December 4, 1911, pp. 247-260.

to be kept hidden in a special niche behind a mysterious curtain and served by priests of peculiar temperament and unpractical ideals. This is both disparaging to our good sense and prejudicial to the progress of knowledge. Scientific research is not a luxury; it is a fundamental necessity. It is not a European fad, but is the very essence of the tremendous technologic and industrial success of the last 20 years, in which we have shared.

Prof. E. L. Nichols, of Cornell, as retiring president of the American Association for the Advancement of Science, put the case in this way: "The main product of science (research) * * * is knowledge. Among its by-products are the technologic arts, including invention, engineering in all its branches, and modern industry." The idea of scientific research is therefore not less tangible than industrial development, or less practical; it is merely one step more fundamental; it is concerned with the discovery of principles and underlying relations rather than their application. This being true, research should profit as much, or even more, from efficient organization as industrial development has done.

Although this conclusion is making its way but slowly in American science, in geological research, where material must be gathered from the utmost ends of the earth and even from within it, and where nearly every known branch of scientific activity finds some application, there is a peculiarly favorable opportunity for organized effort which is already coming to be recognized. "So long as geology remained a descriptive science," says President Van Hise, of Wisconsin, "it had little need of chemistry and physics; but the time has now come when geologists are not satisfied with mere description. They desire to interpret the phenomena they see in reference to their causes—in other words, under the principles of physics and chemistry. * * * This involves cooperation between physicists, chemists, and geologists."

In a general way, physics, chemistry, and biology have already supplied working hypotheses which have been used by students of geology to help in the examination, classification, and mapping of the most conspicuous features of the exposed portion of the earth. The geologist has gone abroad and has studied the distribution of land and water, the mountain ranges, the erosive action of ice and of surface water and the resulting sedimentary deposits, the distribution of volcanic activity and of its products the igneous rocks; or, more in detail, he has studied the appearance of fossils in certain strata, and has inferred the sequence of geologic time. The distribution of particular minerals and of ore deposits has been carefully mapped. Regions which offer evidence of extraordinary upheaval through the exercise of physical forces have been painstakingly examined, and so on through the great range of geologic activity.

In a word, the field has been given a thorough general examination, but the manifold problems which this examination has developed, although early recognized, and often the subject of philosophical speculation and discussion, still await an opportunity for quantitative study. They are often problems for the laboratory and not for the field, problems for exact measurement rather than for inference, problems for the physicist and chemist rather than for the geologist. This is not a result of oversight; it is a stage in the development of the science—first the location and classification of the material, then the laboratory study of why and how much.

Certain indications have led us to believe, for example, that the earth was once completely gaseous and in appearance much like our sun. Indeed, it possibly formed a part of the sun, but through some instability in the system became split off—a great gaseous ball which has cooled to its present condition. The cooling probably went on rapidly at first until a protecting crust formed about the ball, then more and more slowly, until now, when our loss of heat by radiation into space is more than compensated by heat received from the sun. Obviously, the earliest portions of this history are and must remain dependent upon inference, but the formation of a solid crust can not advance far before portions of it become fixed in a form such that further disturbance does not destroy their identity. From this point on, the history of the earth is a matter of record and can be interpreted if only we have sufficient knowledge of the mineral relations through all the stages of their development.

It must have been a very turbulent sea, the molten surface of our earth upon which the rocky crust began to form. The first patches of crust were probably shattered over and over again by escaping gases and violent explosions of which our waning volcanic activity is but a feeble echo. If the earth was first gaseous, and the outer surface gradually condensed to a liquid, its outer portions at least must have been whirled and tumbled about sufficiently, even in a few thousand years—which is a very small interval in the formation of an earth—to mix its various ingredients pretty thoroughly. It has accordingly been hard to see just how it came to separate into individual rocks of such widely different appearance and character. Of course the number of its ingredients was large. We have already discovered 80 or more different elementary substances in the earth, and there is an almost endless number of more or less stable compounds of these. The freezing of an earth is therefore different from the freezing of pure water, but the freezing of salt water offers a clue to the explanation of the way in which the earth solidified as we find it. When salt water freezes, the salt is practically all left behind. The ice contains much less salt and the remaining water relatively more salt than before freezing began. Applying this familiar obser-

vation to the supposed molten surface of the earth as it begins to solidify, we have a suggestion of order and system in its separation into so many kinds of rocks.

Now, it happens that in the recent development of chemistry much attention has been given to the study of solutions of various kinds, and a great body of information has been gathered and classified of which our observation upon the freezing of salt water is a simple type. Still more recently, quite lately in fact, it has occurred to many students of the earth that here lies not only the clue but perhaps the key to their great problem. If the individual components which are intimately mixed in solution separate wholly or partially in some regular way upon freezing—and nearly all the solutions which have been studied appear to show such segregation—we have a quantitative system which will probably prove adequate to solve the problem of rock formation, provided only that the experimental difficulties attending the study of molten rock and the complications imposed by the presence of so many component minerals, do not prove prohibitive. This is a very simple statement of the point of view which has led to the experimental study of rock formation in the laboratory as a natural sequence to statistical study in the field.

Geophysics therefore does not come as a new science, nor as a restricted subdivision of geology, like physiography or stratigraphy, but rather to introduce into the study of the earth an element of exactness, of quantitative relation. It may include physics or chemistry, biology or crystallography, or physical chemistry, or all of these at need. The distinctive feature of geophysics is not its scope, which may well be left to the future, but its quantitative character. The Geophysical Laboratory of the Carnegie Institution of Washington has entered upon some of the investigations suggested by this long preliminary study of the earth—the physical properties and conditions of formation of the rocks and minerals. The Department of Terrestrial Magnetism of the same institution has undertaken another—the earth's magnetism; the German geophysical laboratory at Göttingen a third—the earthquakes—and these will no doubt be followed by others.

The first effect of calling exact science into consultation upon geologic problems is to introduce a somewhat different viewpoint. It has been our habit to study the minerals and the rocks as we find them to-day, after many of the causes which have had a share in their evolution have ceased to be active, after the fire has gone out. If we attempt to reconstruct in our minds the operations which enter into the formation of an igneous rock or of a body of ore, we must infer them from present appearances and environment. The experimental geophysicist, on the other hand, confronting the same problem, says to himself: Can we not construct a miniature volcano in the

laboratory; can we not build a furnace in which an igneous rock can be formed under such conditions that we can observe its minutest change? He proposes to introduce temperature-measuring devices and apparatus for the determination of pressure, to investigate the character of the surrounding atmosphere and the quantity of water vapor which may be present. He insists upon the chemical purity of every ingredient which goes into the furnace and guards it carefully against contamination. In these various ways he will undertake to ascertain the exact magnitude of all the causes, both physical and chemical, which have been at work in his miniature rock producer, together with the physical characteristics of the product.

A very practical question now arises. Can he do all this successfully at the temperatures where the minerals form? We must press this question and insist upon a satisfactory answer, for it is by no means obvious that the relations which the physicist and chemist have established at the temperatures of everyday life—energy content, density, solubility, viscosity, dissociation—will continue to hold when substances are carried up to a white heat. The substances, too, are different from those with which the chemist and physicist have been generally familiar. Instead of simple metals, aqueous solutions, and readily soluble active salts, we encounter silicates and refractory oxides, inert in behavior and capable of existing together in mixtures of great complexity. We must therefore extend the range of our physics and our chemistry to a scope in some degree commensurate with the wide range of conditions which the earth in its development has passed through. Let us follow for a little the actual progress of such an attempt.

The first step is to provide the necessary temperatures. Obviously, the common fire-clay crucible and the smelter's furnace with its brick lining will not serve us here, for all these are themselves mineral aggregates. The charge, furnace lining, and crucible would go down together in a fall as disastrous as Humpty Dumpty's. But experiment has taught us that platinum crucibles, magnesia furnace tubes inclosing an electrically heated helix of platinum wire, and electric temperature-measuring devices, provide a furnace in which nearly all of the important minerals can be successfully studied, which is hot enough to melt zinc, silver, gold, copper, nickel, or iron readily, and where any temperature up to $1,600^{\circ}$ C. can be maintained perfectly constant, if need be, for several weeks. All these temperatures can be measured with no uncertainty greater than 5° . This equipment preserves the chemical purity of the mineral studied, and enables the temperature to be controlled and measured at every step of the experimental work. Or an iridium furnace tube and an iridium crucible can be substituted for platinum, the magnesia supports can

still be used, and we have it in our power to go on to $2,000^{\circ}$ C., which is quite sufficient for all the more important minerals which we know.

The physicist has therefore found a suitable melting pot and means of ascertaining what goes on within the pot; but he at once encounters another difficulty. Nature has provided us with relatively few minerals of high chemical purity. If a natural mineral is chosen for experiment, however typical it may be, several per cent of other minerals may be expected to be present with it, the effect of which is at present quite unknown. Now, the first axiom of the investigator in a new field who desires to undertake measurements which shall have a real value is that the number of unknown quantities in his equations must not be greater than he can eliminate by his experimental processes; in other words, he must begin with conditions so simple that the relation between a particular effect and its cause can be absolutely established without leaving undetermined factors. Having solved the simple case, it is a straightforward matter to utilize this information to help solve a more complicated one. Therefore if we would reduce the mineral relations to an exact science, which is our obvious purpose, it is necessary from the outset to prepare minerals of the highest purity and to establish their properties. Having obtained such a pure mineral type, it may be, and often is, in the power of the mineralogist and his microscope to determine, by direct comparison with its natural prototype, the kind and amount of effect actually produced in the natural mineral by the one or more other minerals which it contains. We have therefore hardly started upon our investigation before the need of an organized system is demonstrated: First comes the chemist, who prepares and analyzes the pure mineral for investigation; then the physicist, who provides and measures the conditions to which it is subjected; then the mineralogist, who establishes its optical properties in relation to the corresponding natural minerals.

Having prepared such a mineral, of high purity and of known crystalline character, we can ascertain its behavior at the temperatures which must have obtained during the various stages of earth formation. We can study the various crystal forms through which it passes on heating and the temperature ranges within which these forms are stable; we can also melt it and measure the melting or solidifying temperature. Another mineral, prepared with the same care and studied in the same way, may afterwards be added to the first, and the relation of these two determined. If they combine, heat is absorbed or released; and this quantity of heat can be measured, together with the exact temperature at which the absorption or release takes place. If the mixture results in the formation of one or more mineral compounds, we shall learn the conditions of for-

mation, the temperature region within which the new forms are stable, and the changes which each undergoes with changes of pressure and temperature, as before. If the new forms show signs of instability, we can drop them into cold water or mercury so quickly that there will be no opportunity to return to initial stable forms, and thus obtain, for study with the microscope at our leisure, every individual phase of the process through which the group of minerals has passed.

Without complicating the illustration further, it is obvious that we have it in our power to reproduce in detail the actual process of rock formation within the earth, and to substitute measurement where the geologist has been obliged to use inference; to tabulate the whole history of the formation of a mineral or group of minerals under every variety of condition which we may suppose it to have passed through in the earth, provided only we can reproduce that condition in the laboratory.

During the past quarter of a century there has arisen in the middle ground between physics and chemistry a new science of physical chemistry, in the development of which generalizations of great value in the study of minerals have been established. As long ago as 1861 the distinguished German chemist, Bunsen, pointed out that the rocks must be considered to be solutions and must be studied as such; but, inasmuch as comparatively little was known about solutions in those days, and the rocks at best appeared to be very complicated ones, no active steps in that direction were taken during Bunsen's life. But in recent years solutions have been widely studied, under rather limited conditions of temperature and pressure, to be sure, but it has resulted in establishing relations—like the *phase rule*—of such effective and far-reaching character that now, just half a century afterwards, we are entering with great vigor upon the prosecution of Bunsen's suggestion. It is now possible to establish definite limits of solubility of one mineral in another, and definite conditions of equilibrium, even in rather complicated groups of minerals, which enables us not only to interpret the relations developed by such a thermal study as that outlined above, but also to assure ourselves that only a definitely limited number of compounds of two minerals can exist, that they must bear a constant and characteristic relation to each other under given conditions of temperature and pressure, and that changes of temperature and pressure will affect this relation in a definite and determinable way. Physical chemistry not only takes into account the chemical composition of mineral compounds, but their physical properties as well, throughout the entire temperature region in which they have a stable existence, and therefore furnishes us at once with the possibility of a new and adequately comprehensive classification of all the minerals and rocks in the earth. The value of an adequate system of classification appeals chiefly to

those whose duties bring them into intimate relations with the subject matter of a science, but so much may appropriately be said that a consistent application of physical chemistry to the minerals may operate in the not far distant future to develop an entirely new conception of the science of mineralogy.

As the number and scope of such exact measurements increase, we gradually build up what may be called a geologic thermometer. Just as the location of fossils offers a basis for estimating geologic time, it often happens that a mineral takes on a variety of different crystal habits, according as it happened to form at one temperature or another. Quartz, for example, which is one of the commonest of natural minerals and one of the most familiar, undergoes two changes in its crystal form which leave an ineffaceable record. One occurs at 575° and the other at 800° . An optical examination of even a minute quartz fragment from the mountainside will reveal to the skillful petrologist whether the crystal formed at a temperature below 575° , between 575° and 800° , or above 800° . And if we could have at our disposal a great body of such exact measurements of the temperature region within which particular crystals originate and remain stable, we could apply that directly to terrestrial formations in which this mineral occurs, and read therein the temperature which must have obtained during their formation. All this will not be done in the first year, and perhaps not in the first decade; but the ultimate effectiveness of this method of procedure in establishing the relations between the minerals and the valuable ores is now as certain of success as the operations of any of the sciences which have now come to be characterized as exact, as opposed to descriptive.

There is one important difference between the great laboratory of nature and its feeble human counterpart. Nature operated with large masses, mixed with a generous hand, and there was always plenty of time for the growth of great individual crystals, at which we marvel whenever we encounter them, and which we have sometimes come to regard highly as precious stones. To carry these processes into the laboratory is necessarily fraught with certain limitations. The quantities must remain small and the time and available financial resources will always be limited. So long as we are able to ascertain the optical character of a crystal with equal exactness whether the crystal is of the size of the proverbial mustard seed or a walnut, the scientific laboratory can not properly afford the time necessary to produce the large crystals which nature offers so abundantly. Furthermore, the crystals of nature often owe their brilliant coloring to slight admixtures of impurity, which, to the scientific laboratory, spell failure and are avoided with the utmost care. Most of the mineral crystals, when reproduced in the laboratory, are quite colorless. And so, although the question is often raised whether we

are not really engaged in the artificial production of gems, and although the seductive character of such an investigation would no doubt appeal to many, it must be admitted that the geological laboratory is not and probably will never become the serious competitor of nature in those directions in which nature has produced her most brilliant effects.

In what has preceded I have laid emphasis upon the value of experimental measurements in the systematic development of a more exact science of the earth. It is a fair question, and one which is very often raised, whether all this investigation has a utilitarian side, whether the knowledge obtained in this way and with such difficulty, will help to solve any of the problems arising in the exploitation of our mineral resources or assist in our industrial development. It is neither wise nor expedient, in entering upon a new field of research, to expatiate long upon its practical utility. Its principles must first be established, after which there is no lack of ingenuity in finding profitable application of them.

The development of thermoelectric apparatus for the accurate measurement of high temperatures was begun and has been perfected in the interest of geophysical research, and it has already found such extended application among the technical industries as to demand the manufacture and calibration of thousands of such high-temperature thermometers every year. The tempering and impregnation of steel are no longer dependent upon the more or less trained eye of the workman, but are done at measured temperatures and under known conditions which guarantee the uniformity of the product and admit of adaptation to particular purposes, like high-speed tools or armor plate. This has the incidental but far-reaching industrial consequence that workmen of great individual skill in these industries are much less necessary now than formerly. Everything is accomplished by bringing temperature conditions under mechanical control and making them absolutely reproducible without the exercise of critical judgment on the part of anyone.

A more intimate knowledge of the behavior of the minerals themselves finds almost immediate industrial application. An industry which has grown to enormous proportions in recent years is the manufacture of Portland cement, about which little more has been known than that if certain natural minerals were taken in the proper proportions and heated in a peculiar furnace developed by experience, the resulting product could be mixed with water to form an artificial stone which has found extensive application in the building trades. Chemical analysis readily established the fact that the chief ingredients in a successful Portland cement were lime, alumina, and silica, with a small admixture, perhaps, of iron and magnesia: but the

relation in which these ingredients stood one to another—that is, which of them were necessary and which merely incidental—and in what compounds and what proportions the necessary ingredients required to be present, has never been satisfactorily established. When we know the stable compounds which lime, alumina, and silica can combine to form, together with the conditions of equilibrium between these for different temperatures and percentages of each component, a formula can be written offhand for a successful Portland cement from given ingredients somewhat as an experienced cook might write out the recipe for a successful dish. Such definite and valuable knowledge is not beyond our reach. To obtain it requires in fact precisely the same system of procedure which has been described above and which has already been successfully applied to many of the natural minerals which have been reproduced and studied in the Geophysical Laboratory during the past five years. It happens that we have examined a considerable number of these very mixtures in our recent work upon the rocks. All the compounds of lime, silica, and alumina have been established, and a portion of the silica-magnesia series and their relations have been definitely determined throughout the entire range of accessible temperatures. There is no reason to apprehend serious difficulty in applying the same procedure to the commercial ingredients of Portland cement and replacing the present rule-of-thumb methods and uncertain products with dependable cements. The problem of determining the relation of the ingredients in commercial cement and the conditions necessary for its successful formation is exactly the same in character as that of determining the conditions of formation of the rocks of the earth.

A physico-chemical investigation of the sulphide ores over a wide range of temperatures and pressures has also been undertaken, which has developed a large body of exact information of value in mining industry. And such illustrations could be continued almost indefinitely if it would serve any useful purpose to do so.

The industrial world is not, as a rule, interested in scientific principles; the principle must first be narrowed down to the scope of the industrial requirement before its usefulness is apparent. The immediate effect of an industrial standpoint is therefore to restrict investigation at the risk of losing sight of underlying principles entirely. An illustration of this has come down to us through the pages of history, of a character to command and receive the utmost respect, for such another can hardly be expected to occur. We have honored the early philosophers for their splendid search after broad knowledge, but in what is now the field of chemistry they allowed themselves to be turned aside to the pursuit of a single strictly utilitarian problem—the transmutation of base metals into

gold. The history of chemistry is a history of this one problem from the fourth to the sixteenth century—12 centuries before a man arose whose broader standpoint enabled him to divert the fruitless search into other channels from which a science has slowly arisen which is now so broad as to overlap most of the other sciences and withal so practical that hardly an industry is entirely independent of it.

The so-called practical questions may therefore as well be left to take care of themselves. There has been no lack of ingenuity in making profitable application of systematic knowledge whenever the need for it became insistent, for the rewards of such effort are considerable. And it is no longer an argument against proceeding to establish relationships in a new field, that the scope of their application can not be completely foreseen.

Now, what more promising questions occur to one than these: If the earth was originally fluid, as it appears to have been, and has gradually cooled down to its present state, its component minerals must at some time have been much more thoroughly mixed than now; how did they come to separate in the process of cooling into highly individualized masses and groups as we now find them, and what were the steps in their deposition? If the whole earth was hot, whence came the marble of which we have so much and which can withstand no heat? What has given us the valuable deposits of iron, of gold, of precious stones? What determines the various crystal forms found in the different minerals, and what is their relation? Some must have formed under pressure, some without pressure, some with the help of water, and some without. Where is the center, and what the source of energy in our volcanoes? All these questions and many more the geophysicist may attempt to answer

A TRIP TO MADAGASCAR, THE COUNTRY OF BERYLS.¹

By A. LACROIX,

Membre de l'Institut de France.

Madagascar, the land long full of mystery and of fabulous legends, has ever since it was opened up to the world been noted for its mineral riches.

The second Frenchman who landed on the island, Capt. Jean Fonteneau, called Alphonse le Saintongeois, declared that he found precious stones there in 1547.² One hundred years later, in 1658, Flacourt³ speaks of topazes, aquamarines, emeralds, rubies, and sapphires, and shows on his map the places where one could find those marvelous masses of rock crystal, limpid as the purest water, which have ever since been sought after for ornamentation and for optical use.⁴ Up to the middle of the last century every traveler who wrote about the "Grand Ile" did not fail to note the great abundance of gems there,⁵ although many attempts at their practical utilization, made in the seventeenth and eighteenth centuries by the French East India Co., had lamentably failed.

When the period of scientific exploration commenced, some fearless pioneers, in the front rank of whom I would place our colleague, M. Alfred Grandidier, quickly made known the principal features, so peculiar, of its flora and fauna, but all that concerned its mineralogy was hardly glanced at, for a reason that I will explain. In order to protect its mineral resources the Government of Madagascar had instituted a system as ingenious as it was efficient. One penalty only—and that was death—stopped all mineral research by for-

¹ Lecture at the annual meeting of the Cinq Académies de l'Institut de France (Oct. 25, 1912). Translated by permission from *La Géographie*. Bulletin of the Geographical Society of Paris, Nov. 15, 1912.

² *Voyages aventureux du capitaine Jean-Alphonse-le-Saintongeois*, Paris, 1559 (reprinted in Coll. ouvr. anc. Madag. by A. and G. Grandidier, vol. 1, pp. 92-95).

³ *Histoire de la Grande Isle de Madagascar*, Paris, 1658.

⁴ This mineral was found in the rivers of the eastern coast, to the north of the Bay of Antongil and notably in the region of Voehemar. I have specified (*Comptes Rendus de l'Acad. des Sciences*, Paris, vol. 155, 1912, p. 491) the conditions under which this mineral abounds on the high plateaus. The beds actually worked in place are pockets of crystals in the metamorphosed quartzites.

⁵ Notably: (Du Bois) *Les voyages faits par le sieur D. B. aux îles Dauphine ou Madagascar et Bourbon ou Mascarenne, és années 1669-70, 71 et 72*, Paris, 1674, 151. Souchu de Rennefort, *Histoire des Indes orientales*, Leide, 1688, 173. De la Haye et Caron, *Journal du voyage des Grandes Indes*, Paris, 1688.

eigners. Since the French occupation of the island, the prospectors have taken their revenge. The map of the "Service des Mines," on which is recorded the sites for permits for research, resembles a swarm of ants.

Among the treasures that this remarkable activity has drawn from the earth, precious stones, along with gold, must be placed as the principal object of exploitation. The conjectures of ancient voyagers have been realized, but I should say that the mineral deposits now worked are not at all those which they believed they had discovered. They knew only of those near the mouths of the rivers of the eastern coast and in the neighborhood of Fort Dauphin, there where modern research has so far brought to light only some quartz and poor garnets, unfit for any economic use.¹ The real deposits are found elsewhere.

Official statistics show that in 1911 there were exported from Madagascar 470 kilograms of stones ready to be cut; it is a good omen for the future of so new an industry. I was at its birth.² I have followed its rapid strides while there has been unearthed material of a scientific interest of the first order.³ Thus in the course of a recent mission, to which I was attached, I undertook, among other subjects, to study on the spot all the mineral occurrences that might yield the least gem. I now propose to outline what I saw.

¹ It is shown by the following references that it was these minerals that those early explorers had seen: In 1666 François Martin (the founder of Pondichéry) says that the passengers of the *Vierge du Bon Port* brought a quantity of topazes, amethysts, and other colored stones that they had found at Fort Dauphin. "That has been a fancy of the French who were in the island, but they have not been appreciated in France because they were found too fragile." (Archives nationales, MS.)

In 1668, De Faye, director of commerce of the East India Co., wrote "that the company has been very much undeceived on the subject of some precious stones of which wonderful things had been promised him and for which in India they had not given a sou per thousand [some topazes and amethysts from the Itapere River (Fort Dauphin)]." (Arch. Min. Colonies, Manuscripts.)

This last story is confirmed by De la Haye (op. cit., 91). "Director Caron, arriving at Surate, offered some to the governor of the city, who refused them, smiling at the gift, which, however, was nine of the most beautiful stones that had yet been seen and the smallest as large as a quail's egg, and all cut in various shapes. They were shown to several jewelers, who were pressed to state their value, and none estimated higher than 9 rupees for the most beautiful and 27 for all the others."

² The first specimens received at the museum were a beautiful crystal of rubellite, some small sapphires and zircons, given in 1891 by A. Grandidier. (Jannettaz. Bull. Soc. franç. minér., vol. 14, 1891, p. 66.) The first specimens reported in France with the precise indications of their localities were given to me by E. Gautier; I described them in 1899 (Bull. Muséum, p. 318); a little later Mr. Villiaume sent me some tourmalines found by him to the west of Mount Bity.

I believe that I was the first to have these precious stones of Madagascar cut in a systematic fashion, following the exposition made at the museum at the time of the expedition; there were some chrysoberyls, some garnets, some corundums, and topazes, etc., from the alluvia of Belambo near Mevatanana and brought back by M. Suberbie. I afterwards exhibited in the Gallery of Mineralogy a fine series of yellow and brown tourmalines that I had had cut with the aid of patterns from the region of Tsilaïsina, that Mr. Garnier-Mouton had sent me, who was then chief of the Province of Betafo.

³ I have described these materials in numerous notes and memoirs, particularly in my *Minéralogie de la France et de ses Colonies*, vols. 1-4, 1893-1900, in the article *Minéralogie*, in *Madagascar au XX siècle*, 1902, pp. 65-107, then in the *Comptes Rendus de l'Ac. des Sciences* and in the *Bulletin de la Société française de Minéralogie* from 1908 to 1912. See also the notes of M. Mouneyres and of M. Dabren (showing some results of the mission Villierme) in the *Bulletin de l'Académie malgache*, vol. 4, 1905, and in the *Bulletin économique de Madagascar*, 1906, besides those of MM. Dupare, Wunder and Sabot in the *Bulletin de la Société française de Minéralogie*, 1910-1911, in the *Archives* and the *Memoires de la Société des Sciences physiques et naturelles de Genève*, 1910.

It is necessary first of all to understand what we mean by a precious stone. Mineralogists classify minerals in the first place according to their chemical composition, then they determine from the form of the crystals how to establish subdivisions of a second order; therefore precious stones are, from every point of view, chemical; a simple element, oxides, aluminates, silicates, and many other combinations. All the modalities that can form crystalline symmetry are found represented there. It is not then the question of a natural family but of an artificial grouping.

To be a precious stone a mineral must unite a number of qualifications. It must be transparent, of a fine water; that is, very limpid. It should have a strong, clear color; hence, the doubtful tints, the halftones dear to painters, those which form the charm of certain flowers and the adornment of many animals, are not in favor. The mineral should be very brilliant, which depends upon two optical properties, dispersion and refraction; this last is dependent on density; therefore precious stones are more or less heavy. Finally, it must be hard, so as to take and hold a fine polish. The more a stone unites these qualities in a high degree, the more readily does it hold a high place in the realm of gems, a place which in addition to this is influenced by its comparatively great rarity.

To these intrinsic properties of the stone, we should, however, add something exterior to it that escapes the analysis of a mineralogist, for it is nothing less than feminine fancy, changing with the fashion. Thus, thanks to the favor which artistic jewels now enjoy, these stones, so correctly called "fancy," until lately so neglected, are each day more and more sought after. Madagascar should not complain, for these are the stones that most of all adorn her jewel case.

The definition which I am going to give may be exact; it is not, however, a general one. There are, in fact, some minerals which are neither limpid, nor clear, nor dense, nor hard, and yet are considered as precious stones. Such is the opaque turquoise, which owes its popularity to its beautiful delicate blue color; such is the opal,¹ which takes the charm of its beauty from the warm reflections that play about in its semitransparency.

A mineral which may constitute a gem, and sometimes of the highest value, is found not alone in its precious form. At Madagascar even corundum forms transparent sapphires, the value of which is estimated by the carat of 200 milligrams, and besides some enormous

¹ The opal is also found in Madagascar, but it is not yet quarried; in the phonolite trachyte, coming from the south of Faratsiho, it constitutes very small veins, which possess reflections equal to those of the opal of Hungary and also some small veins which recall the fire opal, but with a tint more brown than red. I visited this deposit but collected only small fragments.

opaque crystals which are exported by the ton and utilized only in the abrasive industry.¹

On the other hand, the list of gems is not definitely closed, for from time to time, following the discovery of a new deposit, the list is increased by the name of a mineral until then considered a mere pebble, because though possessing some of the qualities enumerated above, it has been lacking in transparency or in a pleasing color. Madagascar furnishes some examples of this. One of the most common constituents of the rocks which form the granite mountains of all countries—potash feldspar—has been found in a locality lost in the south (Itrongahy, about midway between Betroka and Benenitra) in crystals of an admirable limpidity, set off by a yellow color as warm as it was unusual and which gave it the appearance of golden beryl.² Very near there, scattered through the soil, were found some fragments of a species of mineral, the name of which has never been heard by any of you, the "kornepine."³

Instead of forming grayish and opaque rods, as in the single deposit in Greenland, where until recently it had only been found, it constitutes a transparent, sea-green stone slightly recalling certain aquamarines but with an incomparably superior brilliancy.

Up to the present time no diamonds have been found in Madagascar, but nearly all the other gems occur there in great abundance.

Many of the minerals are seen in their original matrix, others are gathered in the alluvium resulting from the breaking up of their vein-stone in place, while still others are a part of the alluvium accumulated by the work of streams.

The Grand Ile is made up principally of a basement of ancient rocks, eruptive and metamorphic, ending abruptly on the eastern side in high cliffs which are separated from the Indian Ocean by a narrow plain, low and sandy, while toward the west the island terminates in a way no less abrupt, serving as a buttress for some sedimentary formations which come to an end in the Mozambique Channel. All the deposits of precious stones are located in the central ridge and particularly on the high plateaus that crown the island.

One of the principal attractions of a trip to Madagascar is the contrasts encountered at every step, contrasts due to nature, contrasts

¹ I have shown that this corundum which abounds eastward from the meridian of Tananarive is formed in mica schists in connection with granite. (*Comptes Rendus de l'Acad. des Sciences*, vol. 154, 1912, p. 797.) There were exported in 1911, 150 tons, and this quantity will without doubt be doubled in 1912.

² Its hardness (6) is less than that of the beryl, likewise the density (2.55 to 2.60) and also its refraction ($n_g=1.5253$, $n_m=1.5248$, $n_p=1.5197$).

³ Kornepine is a magnesium aluminium silicate. Once cut, it is distinguished from the aquamarine as well as from the green andalusite of Brazil by its very great density (3.27) and especially by its refraction ($n_g=1.6742$, $n_m=1.6733$, $n_p=1.6613$). (A. Lacroix, *Comptes Rendus*, vol. 155, 1912, p. 675.) A variety named prismatic has been found in the granulite of Saxe, but it is formed only of little grayish rods not transparent.

The feldspar of Itrongahy is accompanied by crystals of limpid diopside, specimens of which of a bottle-green color form a very pretty gem. Some violet zircons and green apatite might also be cut.

due to men and to their industry. The ascent from the eastern side to Tananarive is startling from this point of view. The canal from Pangalanes permits crossing the coastal zone, marshy and warm. The arduous ascent of more than 1,500 meters¹ of jagged rocks, whence fall raging cascades in the midst of the humid luxuriance of a tropical forest, leads to vast plateaus covered by the grassy steppe which is prolonged, barren, and dry until the moment when the high hills of Tananarive commence to carve themselves against the sky, coming nearer little by little, then appearing in the midst of verdant rice plantations with all the details of their red beauty.

The means of transportation which permitted me to reach my destination were not less varied. The slowness and the lack of comfortable navigation through the canal on the plain made us better appreciate the speed and elegance of the railroad—a bold undertaking, which in less than 13 hours climbed over the high rounds of the titanic trestle, leading to the neighborhood of Ocean by the side of the battered plateau on which, much farther still, the Malagasy capital stands. It was by automobile that the 172 kilometers which separate Tananarive from Antsirabe, my first center of exploration, were traversed and I descended from a vehicle of the latest model only to mount a “filanzane” (seat suspended between long poles).

At the risk of being called an old retrograde academician, I distinctly state that between the automobile and the filanzane my sympathy for the geologist goes straight to the latter.

The journey from the capital to Antsirabe was like the cup of Tantalus for me. Over this road, still new, we rolled along with dizzy speed; before my eyes, accustomed by a month of the bush to the monotony of the red earth which covers the greatest part of the island, the rocky walls recently torn up by dynamite appeared like flashes of lightning exposing to the sun their marvelous freshness. Upon the slope some broad surfaces of granite, reflecting white or rose, were loosened, magnificent, with innumerable dark spots, basic inclusions, which I seek throughout the world that I may learn from them the secret of the genesis of the rocks which inclose them; then, as in a giant kaleidoscope, there succeeded some gneiss in many colored strata, revealing the complexity of their nature, some veins of every variety. What more do I know?

Each turn of the wheel brings a new temptation. My hammer burns my hands. But alas! deaf to my prayers, the conductor of the infernal machine, bending over the steering wheel, slave to the hour, refuses the slightest stop and we keep rolling on.

With the filanzane these distractions are unknown. Nicely perched on a little seat of cloth between two long bars resting on the

¹ The railroad attains the height of 1,520 meters between the stations of Ambatoloana and Manjakan-driana.

shoulders of four strong fellows, the traveler is master of his destiny. The measured step of the porters, the resulting rhythmic movement, hardly disturbed each minute by the interchange of the bushmen, are not without charm and induce revery.

In the plain, on a track well marked, the Malagasy loves to take a sinuous course, but just as soon as the land changes, he uses nothing but the straight path. It happens sometimes that one is almost erect in the stirrups during steep descents, or the head is lower than the feet on steep ascents. The inexperienced sufferer makes sad reflections on certain proprieties, new to him, of the shortest way from one point to another, but he soon reassures himself as he learns the skill, the wonderful steadiness of his servants, and without fear trusts to them, and feels himself carried at a bound over all obstacles.

This mode of transportation is not slow, for it is possible to make 70 kilometers in a day, though about 50 kilometers is a good average, and can be maintained for several weeks with the same men on condition that some village be reached from time to time, when the bushman may find fresh meat, a good night's lodging, and rest.

The Malagasy porter is a big child, laughing, talkative, obliging, temperate, easily contented, and from whom one can gain a great deal, when he is treated in an equitable, kindly way, but with firmness.

At the end of my four months of uninterrupted round in the bush, I was alarmed about them only once. One morning, their humorous stories, related as usual at the time of departure, were longer than was customary. The stories were told in an animated dialogue between two of the band, who replied to each other in a tone growing sharper and sharper, and they became more and more excited by the applause for some story well told, until the two chief actors caught each other by the hair on some trifling pretext. I had to intervene to prevent a general fight. My cook, who was interpreter, having stayed behind, forced me to await his arrival to learn the real cause of the conflict. The debate was in a way philosophical. The question was whether it is best to be economical each evening with one's wages or if it be not better to spend them as most of these talkers had very certainly done the night before.

It was in that equipage that I thoroughly explored the region of precious stones, which forms a great rectangle about 200 kilometers long from north to south and 60 or more wide from east to west.¹

¹ The principal centers are to the northwest of Antsirabé, the outskirts of Miandrarivo (Ampangabé in particular); to the west of Antsirabé, the region situated to the west (Anjanaboana) and to the south of Betafo (Tongafeno, Antsongombato, Zamalaza, etc.); to the south of Antsirabé, the valley of the Sahatany and its vicinity; Sahanivotry, to the east of Mount Bity, then more to the south on the other side of the Manandona, a series of beds situated to the northwest and to the west of Ambositra and then still farther south, the region of Ikalamavony (see vol. 4 of the "Minéralogie de la France et ses colonies").

The valley of the Sahatany River southwest of Antsirabé, may be taken as an example. I came upon it in going over Mount Bity, a long jagged ridge more than 2,000 meters high, formed chiefly of white quartzites, sometimes rising vertically, sometimes bedded in great slabs which are crumbled into very fine sand or into large grains of quartz, translucent and sharp.

The Sahatany is only a small tranquil river, flowing into the tumultuous Manandona with many crocodiles, the only harmful animals of Madagascar. It irrigates a large valley in which there is a remarkable relation between the vegetation and the mineralogical nature of the soil. This is essentially formed by parallel bands of quartzites, mica-schists and marbles. A monotonous mantle of high grasses conceals the first two rocks, while the limestones, bright in their white nakedness, support numerous aloes (*Aloe macroclada* Baker) whose trunks, more than a yard in height, are surmounted by large bouquets of green leaves. These aloes with their queer shapes, sole arborescent vegetable of the valley, reveal at a distance the composition of its soil as easily as on a geological map.

The precious stones are all found in the pegmatite veins, intercalated between strata of metamorphosed sediments or traversing intrusions of granite. These pegmatites are very heterogeneous; their two essential elements, quartz and microcline feldspar, at times of a vivid green tint, and constituting the "stone of the amazone," are of great size. Among these rocks, it is interesting to distinguish two types, as well from the scientific point of view as because of their practical use. In one, the quartz often has the beautiful rose color that is sought after for making small ornaments. The mica, when it appears,¹ is that potash-mica, in great colorless sheets, the use of which for portable stoves has made the mineral popular.

Only one gem exists by itself, the beryl,² but its crystals are at times enormous;³ I brought back one which measures nearly a meter. You should not believe, however, that these colossal-like crystals are entirely transparent; the limpid portions are seen only here and there, in the midst of a fissured mass, cloudy or opaque. The colors that are most sought after, those of the aquamarine, are the various shades⁴ of blue and the sea green, but one sees also some colorless varieties and yellow or rose colors; the beautiful striking green color which characterizes the emerald is unfortunately not found there.

¹ Mica is often lacking in the gem-bearing pegmatites. The muscovite is not worked there, though a very good quality of it is found in some special pegmatites, notably in the massif of Olotsingy, to the south of Betafo.

² I have recently found a small quantity of uncolored topaz at Ampangabé, 1913.

³ These crystals of beryl are hexagonal prisms, very long on the vertical axis; they are very often types of weak density, of which I will speak further on.

⁴ The stones that are most highly esteemed are those of sky-blue shade (Ampangabé, etc.) or of a very special dark blue, with a black tint (Tongafeno, Fefena, etc.).

In several deposits situated outside the Sahantany¹ region there is also found an abundance of monazite, a cerium phosphate sought for on account of the small quantity of thorium which it contains, thorium entering into the composition of gas mantles used for intensive lighting. One can find there also some uranium bearing titanotantaloniobates² from which the precious radium is extracted.

It is not rash to think the day is not far distant when these minerals will no longer be mere scientific curiosities, but will become material profitably turned to account.

The second group of pegmatites is characterized by a greater variety of gems.³ The most abundant is tourmaline. This substance furnishes with beryl and corundum an illustration of the fact that the color of minerals does not generally constitute one of their essential characteristics. One can not conceive of malachite other than green, but very rare are the minerals which, like that, have a color which belongs to them alone. The coloration of nearly all species of minerals, and particularly some precious stones, is only a natural tint, existing ordinarily in such a small proportion that in many cases one may still dispute its nature.

In the Sahantany region the transparent tourmalines are the most beautiful gems, running all the possible gamut of colors. Rarely colorless, they are red and of many different reds; pigeon blood like the beautiful ruby, reds more or less tinged with violet, fading away to the most delicate rose; there are some greens and blues, some browns with now and then a smoky tint, some golden yellows, and one of dazzling gold. Here the colors are uniform in the same crystal, there they alternate to form harmonious blendings.⁴

By the side of these transparent stones are also found, as in the preceding pegmatites, a black tourmaline of no possible use.⁵ Though from a reminiscence of the war of conquest in which the Senegal sharpshooters played a rôle that the Malagasys have not forgotten, they call these stones "senegal."

¹ The deposits where this mineral exists in great abundance and in large crystals are to the north of Betafo (Ampangabé, Ambatofotsikely, etc.); it is there accompanied by ampangabéite, columbite, strüverite, and some bismuth minerals. (A. Lacroix, Bull. Soc. franç. minér., vol. 34, p. 63, and vol. 35, 1912, p. 76.)

² I have distinguished two groups among these minerals. (Comptes Rendus, vol. 144, 1912, p. 797, and Bull. Soc. franç. minér., vol. 31, 1908, pp. 218-312; vol. 33, 1910, p. 321; vol. 35, 1912, p. 84.) The first is isometric and comprises blomstrandite and two new species that I have called betafite and samfresite; these minerals crystallize in great yellow or greenish octahedrons; the second is orthorhombic and includes euxénite, samarskite, and the new mineral that I have named ampangabéite. We must add to it the tetragonal fergusonite.

³ The mineralogical characteristics of these pegmatites are its abundance of sodium and lithium bearing minerals; when mica exists it is no longer potash-mica, but lepidolite and zinwaldite rich in lithia. Biotite is common to two types of pegmatite, of which I have recently stated the different characteristics. (Comptes Rendus, vol. 155, 1912, p. 441.)

⁴ I have given in my *Minéralogie de la France et de ses Colonies* (vol. 4, p. 695) a detailed study, accompanied by numerous photographs, of these blendings of various colors, submitted with some interesting models in harmony with the ternary symmetry and occasionally with the hemimorphisms of the mineral.

⁵ In the pegmatites with the blue beryl these tourmaline crystals are sometimes of colossal dimensions (more than a meter).

The beryl is common enough.¹ It is of a pale rose or dark carmine color, so unusual that it is proposed to give to it a special name, that of "morganite."

Spodumene,² almost everywhere else opaque, is found in a limpid form, of a beautiful rose color with a tinge of lilac, accompanied by an exceptional brilliancy, and this variety, the "kunzite," forms a magnificent stone, rivaling the one which until then had been found only in California.

However, I must mention a garnet,³ the spessartite, supplying some orange-colored gems having a refraction as odd as it is strong, besides a mineral making, also, its first appearance as a precious stone, the danburite,⁴ which, once cut, is hard to distinguish from the yellow topaz of Brazil.

Often inclosed in pegmatite and without distinct crystal forms, all these minerals, with many others besides,⁵ show themselves in pockets of crystals, a description of which would not be out of place in a tale of the "Thousand and One Nights"; tiny grottos with marvelous walls illumined by the sparkling of thousands of crystals, and among them one does not know what to admire the most, the delicateness and perfection of the forms, the multiplicity and brilliancy of the faces, or the variety and richness of the colors.

While they may form, like the aquamarine, some prisms of great dimensions, or even the smallest crystals, but with faces of a wonderful clearness, like those from the pockets, or again some shapeless fragments, all the transparent minerals taken from the open quarries⁶ are carried each evening to the foreman, called the commander,

¹ The beryl of Madagascar does not always have the simple composition (silicate of alumina and glucina) that has long been attributed to it; very frequently, above all in the lithia-bearing pegmatites, part of the glucina is replaced by some alkalis, of molecular weights more or less considerable (lithium, rubidium, caesium), and this substitution at once prevents the increase of density and that of the indices of refraction. This variation is continuous; it is not necessarily connected with the color, but the light beryls are most often blue or green, the heavy ones more often rose.

A knowledge of this property is very important in order to diagnose these precious stones, the density of which may vary from 2.70 to 2.90 and the indices in the following limits: $n_g=1.5818$ to 1.6021, $n_p=1.5756$ to 1.5953, in the specimens studied up to the present time, and which does not constitute, perhaps, the extremes of that series. I should add in addition to this that the very dense beryls, instead of being lengthened near the vertical axis, as in the very light ones, are flattened near the base. I have discussed that question recently in the Bulletin de la Société française de minéralogie, volume 31, 1912, page 200, and in some previous articles.

² This mineral belongs to the pyroxene group, of which it shows the crystals; it is a silicate of alumina and lithia.

³ The spessartite is an alumina and manganese garnet, containing a little lime; that orange color is special to Madagascar; it can be compared, but it is not identical with the spessartite of North Carolina. In the aquamarine beryl pegmatites some garnet is also found, but it is the almandine, red and opaque.

⁴ This mineral is a silico-borate of lime; I announced its existence in Madagascar (Bull. Soc. franç. minér., vol. 31, 1908, p. 314), from some crystals from the valley of the Sahatany.

⁵ We should also mention among the minerals found in pegmatite apatite, rhodizite, and blomstrandite; as to crystallized minerals from pockets, they are quartz, microcline, albite, tourmaline, beryl, and lepidolite, to which we should add two new mineral species that I have called "bityite" (Comptes Rendus, vol. 146, 1908, p. 1367) and the "manandonite" (Bull. Soc. franç. minér., vol. 35, 1912).

⁶ In a few deposits the pegmatite is found intact and very hard. More often it is either kaolinized or lateritized, and in these two cases it has become soft enough to be quarried with the pickax or shovel; the gems can then be easily extracted. In many of the beds they work on éluvions, collecting the pegmatite in place or fallen to its immediate vicinity.

following the ancient customs of our old colonies. The foreman, with a little hammer or pincers, without regard for geometrical beauty, for which mineralogists have a sort of worship, applies himself to breaking out the stone,¹ an operation which consists in reducing the mass to small pieces, in order to detach the limpid portions and to separate them not only from the rest of the veinstone, but from all that which, in the material, is not usable, and it is under this rough form of angular débris that the gems are exported to Europe for the final cutting.

The alluvial deposits are very different from deposits "en place" and less attractive. Minerals are no longer found in any sort of collective relation in their mother rock. Under the influence of the phenomena of alteration during centuries, they have been detached from their gangue little by little, drawn away from the place of their origin by the superficial trickling down, and hurried along much more quickly as they are less dense until they have been carried a long distance by torrents and mixed with other species of different nature and origin.

Under the tumultuous waters which consume the most resistant mountains, pursuing without truce a sort of eternal struggle for life, the weak minerals, the soft and fragile ones, are worn away, crushed by the strong, I should say by the hard minerals, and are eliminated in the form of fine clay; the strong resist much longer, but whatever they are, their crystals sooner or later lose the brilliancy of their faces, the keenness of their edges, and before disappearing in their turn they are reduced to the condition of round pebbles. Among them, of equal hardness, those are preserved the longest that are devoid of physical blemishes. This is a gigantic mechanical preparation, a formidable cutting, effected by natural action. It is a selection through force and beauty.

Further, the gems that subsist in beds, where they are often associated with heavy and precious minerals, such as gold, pertain to a number of more limited species; though as a rule they are less abundant, yet the proportion of beautiful stones in such cases is generally great. At Madagascar these stones are chiefly corundums, garnets,² occasionally some chrysoberyl, some spinel, and topaz.

One of the most typical of the alluvial deposits among those I visited is found to the southwest of Ambositra, in the bed of the small river Ifèmpina. Its boundary is not at all a wilderness of weeds like the Sahatany, but a forest in all its splendor, impenetrable

¹ In certain works the cutting is not done in the camp (toby), but at the prospector's headquarters (Antsirabé for example).

² The most frequent is almandine, which shows a wide range of color from dark red to a pretty rose. Many of the cut almandines come from éluvions.

outside the beaten tracks, a forest whose glades set in great trees are peopled with many-colored birds and agile lemurs.

The few habitations along the path that led me there were no longer the small white molded clay houses of Imerina, but light wooden huts built on piles. The landscape is no more enlivened by the white "lambas" of the Hova; the natives that roam in the woods are half nude; they are the Tanalas with hairy faces.

The washing of the alluvia with the aid of primitive sluices and the "batée," still more primitive, yields, with some gold, many crystals of corundum¹ much rolled. Most of them are opaque but some are transparent. By an irony of nature, that does not fail to rise again, and not without bitterness, the prospector, who kindly allowed us to visit his works—it is the uncolored corundum which forms the largest crystals—could weigh them up to 500 grams.

Their limpidity is so perfect that they might well be classed as magnificent precious stones, but of a difficult setting; nevertheless the least among them would bring a fortune if it had the color of the smallest rubies and sapphires which accompanies them.

In order to find the deposits rich in rubies, and especially in sapphires, you must climb toward the north on the volcanic massif of Ankaratra, where are worked some basaltic alluvia containing débris of granitic subtraction, the original source of the crystals of corundums and zircons which accompany them.²

Such are the precious stones of Madagascar, numerous, varied, and beautiful. Beryls, tourmalines, kunzite, spessartite, and uncolored corundum, in particular, could cope through their limpidity, their color, and their brilliancy with similar gems of the best known deposits of Brazil, of Ceylon, of California. Some of them, the rose beryls and the yellow tourmalines, for example, are unrivaled throughout the world. They need only to be known. As the new comes to everything, so these must conquer their right to live. I have the pleasure of presenting these to you in recognition of the pleasures that their study and their pursuit has afforded me in traversing the vast solitary places of the high plateaus illuminated by the clear sky of the southern winter, in traversing the somber vaults and dense forest.

¹ The corundum crystals of this deposit are at times transformed into absolutely round pebbles, and moreover, from the situation of Ifempina and the position of the point situated up the stream where they commence to find them, they can roll on a course only a few kilometers. It is true that the valley is very winding, hollowed between cliffs of granite and gneiss; they could be used on the spot as some sort of cauldrons for giants.

² By their properties and their kind of deposition these stones are identical with those of Velay (Espaly near Le Puy and Le Coupet).

The knowledge of gems constitutes only a small part of mineralogical questions which are presented in Madagascar. Its extinct volcanoes, its rocks and their minerals, its ores, their composition, their mutual relations, their genesis, their modes of alteration deserve in the highest degree the attention of men of science.

Fifteen years of work on these materials of all kinds accumulated in my laboratory of the museum through the devotion and intelligent curiosity of explorers, officers, administrators, of colonists, prospectors, had very often made me dream of the Great Isle.

This dream has become a reality. This has not in the least disappointed the hopes that had been born in my mind.

THE FLUCTUATING CLIMATE OF NORTH AMERICA.¹

By ELLSWORTH HUNTINGTON.

[With 10 plates.]

PART I. THE RUINS OF THE HOHOKAM.

During his connection with the Pumpelly expedition sent out by the Carnegie Institution in 1903-4 to Transcaspia and adjacent regions the present author came to the conclusion that in the dry regions of central Asia the climate of the past was distinctly moister than that of the present. During the next two years an expedition by way of India to Chinese Turkestan, in company with Mr. R. L. Barrett, led him to extend this conclusion over a wider area and to believe that the change of climate has not progressed regularly, but by pulsations. Still another expedition to Palestine, Asia Minor, and Greece in 1909 on behalf of Yale University seemed to confirm the pulsatory theory, and to show that the general course of history for at least 3,000 years has been in harmony with the supposed climatic pulsations. Moreover, the observations of others, even of men such as Beadnell, who do not believe that the climate of the earth has changed in recent times, seem to indicate that north Africa, on the one hand, and central Europe on the other, as well as southern Europe and large parts of Asia, have also been subject to climatic changes. Thus there seems good ground for the conclusion that during historic times essentially synchronous climatic pulsations have taken place in all of the vast region of the Temperate Zone from China on the east, across Asia and Europe, to the Atlantic on the west. Obviously, if such pronounced and widespread changes have occurred in the Eastern Hemisphere, there is a possibility that changes of a similar nature may have taken place in America. Accordingly when Dr. D. T. MacDougal, director of the Department of Botanical Research of the Carnegie Institution of Washington, invited the author to cooperate with the Desert Laboratory at Tucson, Ariz., in a climatic study of the arid southwestern portion of North America, the opportunity seemed too good to be neglected. Three seasons, consisting of three months in the spring of 1910,

¹ Reprinted, by permission, abridged by the author, from *The Geographical Journal*, London, for September and October, 1912.

four months in 1911, and four in 1912, have now been spent in the field. The time was divided between the States of New Mexico, Arizona, and California in the United States, and Sonora, Mexico City, Oaxaca, and Yucatan in Mexico. Most of the methods of investigation were similar to those which the writer has employed in Asia, and led to a similar result. To these, however, were added some significant observations upon the relation of tropical jungle and tropical forest to civilization in Yucatan, and a series of highly conclusive measurements of trees. Both of these new and independent lines of observation confirm previous conclusions, but in the present article the facts as to Yucatan must be omitted for lack of space.

Omitting all consideration of the effect of climatic changes upon the form of the earth's surface, the composition of soil, the distribution of animals, and various other lines of thought, let us turn at once to the vestiges of pre-Columbian man found in the southwestern part of America. Some, such as the cliff dwellings and the great irrigation works and villages of the Gila Valley in southern Arizona, are famous. A far larger number, however, have received almost no attention even from archeologists. The reason is obvious. In most cases the ruins are so insignificant that an unobservant traveler might ride miles through what was once a region thickly studded with villages without being aware of the fact. Walls for defensive purposes upon the mountains or pictographs upon the face of the rocks are apt to attract attention, but few people notice the far more important sites of villages scattered in profusion over thousands of square miles, especially in southern Arizona, New Mexico, and the neighboring parts of Sonora. The sites are now reduced to barren expanses strewn with ornamented bits of pottery, flint knives and arrow heads, stone hammers and axes, mani and metate stones for grinding seeds, and in some cases rectangular lines of bowlders placed erect at intervals of a foot or two and evidently outlining the walls of ancient houses. Here and there a little mound a foot or two high shows where an ancient dwelling was located. In almost every village an oval hollow surrounded by a low wall covers an area 100 or 200 feet long by half as wide—not a reservoir, as one at first supposes, but probably a ceremonial chamber of some sort. Aside from these scanty traces nothing remains. Yet there can be no question that these were once ancient villages. Frequently the ground is full of bits of pottery to a depth of 2 feet or more, while the surface is so strewn with similar bits that one can not walk without treading on them. The houses were probably built for the most part of branches wattled with mud. Such houses disappear quickly when abandoned, for the wood decays and the clay used for wattling blows away or else is spread over the ground in such a way as not to be noticeable. The

more well-to-do members of the community apparently had more pretentious houses, the remains of which are probably to be found in the larger heaps of clay and rubble which occur in most villages. Close to the mountains, or in regions where stone was available, other methods of construction prevailed. There we find every type of architecture, from houses which used stone only in a single course in the bottom of the walls, to structures made entirely of roughly squared stone blocks. Some of these stone structures were cliff dwellings of three stories in front of caves, while others were isolated buildings standing in the middle of a plain and still rising three or four stories even after the lapse of one or two thousand years.

The majority of the villages must have been inhabited for a long time. Even where the houses have entirely disappeared, the amount of broken pottery covering the ground indicates that a busy population lived here for centuries. The modern Papago Indians still use pottery to almost the same extent as before the coming of the white man, yet the amount of broken pottery in their chief villages, which have been inhabited at least 50 years, is insignificant, while that in the ruins is as great as in many Asiatic ruins which are well known to have been occupied hundreds of years. I emphasize this point because American archeologists and ethnologists have labored under a peculiar impression which amounts almost to an hallucination. Being convinced that no change of climate has occurred, they have been forced to the peculiar theory that the ancient people of America, the "Hohokam" or "Perished ones," as the modern Pimas call them, were of a different nature from the rest of mankind. It has been supposed that these ancient Hohokam were extraordinarily mobile and extraordinarily industrious. For instance, in the Thirteenth Annual Report of the Bureau of Ethnology (p. 259), Mindeleff, one of the best authorities, says that "a band of 500 village-building Indians might leave the ruins of 50 villages in the course of a single century." He assumes a degree of mobility unparalleled among any modern agricultural people, or among any of whom we have historic records. His assumption also carries with it the corollary that the Hohokam must have spent most of their time in building houses, or in making pottery with which to strew the ground and give an appearance of age to their villages. Hunting tribes are, of course, mobile in the highest degree, but the people with whom we are dealing were strictly agricultural, as is universally agreed. The ruins of their villages are invariably located close to agricultural land, or at least to land which would be available for agriculture if there were water enough; their number, even according to those who hold the migratory theory, was too great to allow of their obtaining a living by hunting; they had no domestic animals on which to rely; and finally, traces of corn and beans, the two staple products, are found in

almost every ruin. Accordingly, in the following discussion we shall follow the archeologists in assuming that the ancient Hohokam were an agricultural people. We shall depart from them, however, in assuming that, in the absence of any evidence to the contrary, the Hohokam were like the rest of mankind, and their ruins are to be interpreted by the same criteria as those universally employed in the study of the archeology of other parts of the world.

With these assumptions in mind, we are prepared to investigate the relation of the ancient population to rainfall. Let us first concentrate our attention upon a single region, the Santa Cruz Valley of southern Arizona. I select this valley, not because it is particularly remarkable, but because it happens to contain Tucson, the site of the Desert Laboratory. This town is the largest in the two States of New Mexico and Arizona, although it has only 16,000 people, including all its suburbs.

The reason for the scantiness of population is found in the climate. The average rainfall at Tucson amounts to about 12 inches. This is distributed between two rainy seasons; one of them comes in the winter from November to March, and has an average of about 5 inches of rain, while the other, with 7 inches of rain, begins at the end of June and lasts until early in September. The months of April, May, and June, or the foreshummer, as MacDougal has called them, are practically rainless and very hot, and the same is true of the interval from the end of the summer rains to the beginning of those of winter. Nothing can be raised without irrigation of some sort. Since the coming of the white man, winter crops, such as barley, alfalfa, and the like, have become important. The Indians, however, cultivated practically nothing except corn and beans, which they irrigated by means of the summer floods.

The Santa Cruz Valley has a length of at least 200 miles, but most of it is well-nigh a desert, and can be utilized only for cattle raising. According to Prof. R. H. Forbes, director of the Arizona Experiment Station, the entire drainage area of the Santa Cruz River contains only about 6,000 acres of land under cultivation. Part of the 6,000 acres is under full irrigation and produces four or five crops of alfalfa per year, while a considerable portion is only under flood irrigation and produces but one crop each year, when the heavy rains of July and August redeem the desert for a brief space. Under the best system of irrigation available in modern times, Prof. Forbes estimates that for every 2 acres brought under full cultivation one person is added to the population of Arizona. In other words, if the Santa Cruz Valley were cut off from all the rest of the world and left to its own resources without railways, mines, health-seekers, or other extraneous sources of wealth, the population would be limited to the 3,000 who could be supported on the 6,000 acres of irrigated or

partly irrigated land. To this number nothing could be added by dry farming without irrigation; for Prof. Forbes expressly states that at the present time, in spite of various attempts, no such thing as genuine dry farming exists in the State of Arizona. Promising experiments give hope of some success in the future, but they involve repeated and expensive plowing of the soil after each short period of rain, and this must be kept up for two years before any crop can be harvested. It may safely be assumed that the ancient Hohokam, with no iron tools, no beasts of burden, and no great knowledge of science, could scarcely cultivate as much land as the modern American. Moreover, as they had no winter crops, they could scarcely have raised as much food per acre as is now possible, even had they not been otherwise handicapped. For the sake of argument, however, let us suppose that with the aid of game, wild fruits, and seeds in bad years, and with their lower standards of living, the Hohokam, if they were here to-day under the present conditions of climate, might support themselves to a maximum number of four or five thousand.

Granting that four or five thousand Hohokam might possibly find a living in the Santa Cruz Valley under present climatic conditions, let us see where they would be located. Inasmuch as the ancient people were agricultural, they must have lived where both land and water were available. At present about 1,500 of the 6,000 arable acres are at the Indian reservation and old Spanish mission of San Xavier, 9 miles up the Santa Cruz to the south of Tucson. Six or seven hundred Indians now live there, cultivating the land, raising cattle, and going out to the neighboring city to work. In the days of the Hohokam a somewhat dense population lived at San Xavier, as is proved by various ruins, including a fort on a hilltop. Around Tucson itself the modern houses and streets make it impossible to determine exactly how large an area was occupied by the Hohokam. In all the outskirts of the town, however, pottery and other evidences of early man are abundant, and there is a fort on Tumamoc Hill, where the Desert Laboratory is now located. Evidently many Hohokam lived near Tucson and cultivated the 2,000 acres which can there be irrigated. A third large area of modern cultivation is found along the Rillito, a stream from the southeast which joins the northward flowing Santa Cruz, 8 miles north of Tucson. Here nearly 2,000 acres are now in use. In the past the Hohokam evidently made use of the same land, for traces of villages are found near Agua Caliente, Tanke Verde, Fort Lowell, and elsewhere. The three areas of San Xavier, Tucson, and the Rillito Valley include about 5,500 out of the 6,000 acres available for cultivation, while the remaining 500 are scattered here and there in insignificant patches.

I have described the present distribution of population in the Santa Cruz Valley and its relation to ruins in order to bring out the fact that the prehistoric inhabitants utilized every site which their modern successors can utilize. They did more than this, however, for in the now almost uninhabited and waterless 50 miles below the main irrigated areas of Tucson they occupied at least seven distinct villages, and others will probably be discovered. The first village, at Jaynes station on the Southern Pacific Railroad, 7 miles below Tucson, must have been a genuine town. Broken bits of pottery, old grinding stones, pestles, stone hammers, flint arrowheads, and the low mounds of old houses extend for over a mile along a slight ridge of gravel between two areas of low-lying fertile land easy to irrigate and cultivate if the river contained water. Now, however, the river does not flow so far except in floods. It might possibly reach this point permanently if no water were taken out upstream, but this is not certain, and we have already seen that in former times there were numerous villages farther upstream which must have used up a large amount of water. The abundant traces of human occupation in the Jaynes village appear to indicate that the houses were close together, and were occupied hundreds of years. This one village can scarcely have had less than one or two thousand inhabitants. Adjoining it on the east we traced what seemed to be the line of a canal for more than a mile on the gravelly ground between the bottom lands of the Santa Cruz and the Rillito. Here we found not only numerous remnants of houses, but several of the hollows described above which seem to be ceremonial chambers, and which by their size and number point to a somewhat large population.

Two miles downstream from the Jaynes ruins, at the Nine-mile Water Hole, where the last permanent spring is now found in the dry river bed, another village was located, not so large as its neighbor, but nearly half a mile long. On the opposite or north side of the Rillito we found traces not exactly of a village, but of a series of houses scattered along the edge of the arable land at intervals of a few hundred feet. If all these ruined sites were occupied at one time, which was probably the case, as we shall see later, the population of this one small region from 7 to 10 miles below Tucson can scarcely have been less than two or three thousand. That the inhabitants cultivated the low land on all sides of them can hardly be doubted; for the houses are located just on the edges of the good land, but without encroaching upon it except where the arable tracts are so extensive that an elevated, gravelly site can not be found within a reasonable distance. The villages in the situations thus far mentioned might at present succeed in getting drinking water without much difficulty. They could scarcely get a living from agriculture, however—and certainly not from any other source—unless the upper

villages were unoccupied and all the water normally used by them were brought many miles downstream in canals. This is scarcely possible, for the universal tendency in all irrigated regions is to use the water as far upstream as can be done profitably under the existing state of skill in the science of irrigation. In the good years, to be sure, the people of these villages might raise crops, but in the dry years they would starve.

Farther down the Santa Cruz River, by which I mean the dry bed wherein a little water occasionally flows, a small ruin lies at the mouth of the Canada del Oro, or Little Canyon of Gold. A little farther downstream, at the so-called Point of the Mountains, 17 miles northwest of Tucson, there is another large ruin known as Charco Yuma. In the spring of 1910 we found that the nearest source whence people like the Hohokam, who could not dig deep wells, could have obtained water was 8 miles upstream at the Nine-mile Water Hole. There the amount was sufficient for drinking purposes, but not for irrigation. Ranchers engaged in raising cattle informed us that no water whatever had come down the river during the preceding winter, although during the summer of 1909, when the rainfall for the hot season was close to the average amount of 7 inches, floods came down after 15 or 20 showers. In some cases the flow of water lasted only two hours; in the height of the rainy season, however, that is at the end of July and beginning of August, a brook of more or less size flowed steadily for two weeks. The average duration of the floods was said to be about 36 hours. From this we infer that during a summer of average rainfall, surface water flows as far as the old village of Charco Yuma for 25 or 30 days during July and August. This conclusion is confirmed by the statements of Socoro Ruelas, a Mexican cattle rancher, who in boyhood and early manhood lived at the old stage station located in the midst of the ruins. In winter, according to his statement, water rarely reaches the place, and even the heavy showers of summer sometimes fail to send it so far. When he was a boy in the late seventies or early eighties the spring at the Nine-mile Water Hole increased so much as to send out a stream that was used for irrigation for a year or two. But at other times it completely dried up, so that there was no surface water within about 12 miles of Charco Yuma. From the spring of 1885 to August, 1887, according to the dates given by the Mexican, no water whatever, either in summer or winter, came down as far as the ruins, and people like the Hohokam who depend upon summer floods would have had no crop in 1885 and 1886, and only a poor one when the late rains of 1887 arrived.

In spite of what has just been said, there is a little cultivation on the opposite side of the Santa Cruz Valley, a mile north of the ruins of

Charco Yuma. Here, near the villageless station of Rillito on the Southern Pacific Railroad, a narrow strip of land containing some 300 acres and extending along the railroad for about 3 miles is cultivated by the stationmaster and a neighboring cattle rancher. "Talk about dry farming," said the stationmaster, "it's the easiest sort of thing. Five inches of rain a year is all we need here, and we get on an average twelve. Just look at my fields. They're not so good as usual, but they show what can be done in a bad year like this. It's all in the way you plow and harrow and roll." A little investigation, however, sufficed to show that the 300 acres are supplied with very effective irrigation, not artificial but natural. At this point mountainous spurs cause the broad waste-filled basin of the Santa Cruz to contract to a width of only a little over a mile. The rock floor of the basin lies near the surface and acts as a concealed dam to raise the level of the ground water. Also, the floods, when they come so far, spread out here and accumulate in pools. Nevertheless the crop was poor when I saw it because the rainfall of the winter of 1909-10 was less than the average, and was badly distributed, most of it falling early in the winter. The grain planted in September and October and even in early November grew fairly well, while that planted later failed to head. Even in the best part of the 300 acres, however, that is in the most moist depressions, the hay crop, for which the barley is planted, was expected to amount to only about 15 tons as compared with 95 in the preceding year.

At least a quarter and probably a third of the winters during the last 40 years, since records of precipitation began to be kept in the region, have been even more unpropitious than 1909-10. If the poor rainfall of that year could cause the diminution of the crops to the extent of five-sixths, it requires no demonstration to show that the fields must have been almost useless in the nine years since 1867 when the winter rainfall has been less than at that time. Outside of the 300 acres now in use many attempts at cultivation have been made near Charco Yuma, but without success. In years like 1904-5, to be sure, with nearly 15 inches of winter rain between October and April and 6 in the summer, from July to September, or like 1906-7 with nearly 8 in winter and 11 in summer, fine crops can be raised in many places, but this is the exception, not the rule.

To sum up the conditions at Charco Yuma, it appears that no permanent supply of water is available without the digging of wells at least 25 feet deep, a task highly difficult for a primitive people without iron tools. The nearest permanent supply of water is 8 miles away, and even that occasionally fails. A period of two years and more may pass without a single temporary flow of water. The total amount of land capable of cultivation amounts to about 300 acres sufficient to support 150 or 200 people in ordinary years, but the

yield from this land has fallen off as much as 85 per cent in recent dry years, and must fall off more in the frequent seasons which are worse than the one in question. Winter crops such as have just been mentioned, however, had no importance for the Hohokam, since they had no wheat, barley, oats, or other grains of the Old World, but depended almost solely upon maize and beans, which require summer rain. According to Ruclas, the Mexican, no flood waters reached Charco Yuma in 1885, when the summer rainfall amounted to only 3.07 inches, the minimum on record, nor in 1886 when it amounted to 4.27 inches. If no water reached the place with a rainfall of 4.27 inches we may safely infer that at least 5 inches would be required in order to raise any crop whatever. During the 45 years for which records are available, 15 summers, or one-third, have had a rainfall of less than 5 inches. We seem compelled to conclude that at present the total amount of land which could be cultivated under the Hohokam methods amounts to only 300 acres, which would yield no appreciable crop at least one year out of three, and poor crops about half of the rest of the time.

In spite of these untoward circumstances the Hohokam lived here in considerable numbers. On the left bank of the dry river bed, between the channel and the base of the jutting point of the Tucson Mountains, Mr. Herbert Brown, editor of the Tucson Star, showed us the remains of a large village. For nearly 2 miles we found pottery and other artifacts scattered along the base of the mountains, not thick as a rule, but at frequent intervals as if houses had been located here and there along the edge of the cultivated land just as we have seen to be the case farther upstream, or as the modern houses of the Papago Indians are located at San Xavier. In the center of the village the pottery is thicker. There we found a great boulder of andesitic lava almost buried in alluvium. It was studded with 24 round holes about 10 inches deep and 3 or 4 in diameter, while a similar block not far away contained 7 holes of the same sort. Long ago the Hohokam women must have gathered here with their stone pestles, and gossiped as they sat on the great rocks and pounded corn, beans, or other seeds to make flour for the daily bread of their husbands and sons. Not far away an elliptical inclosure of the kind which we have supposed to be a temple or place for religious ceremonials has a length of 210 feet and a width of 90, dimensions sufficient to indicate a village of considerable size. Back of the temple and the great grinding stone, if these are the proper terms, the whole eastern and northern face of the steep rocky hills is covered with low defensive walls, inclosing spaces 10 to 30 feet wide, where families appear to have taken refuge in times of danger. A rough estimate shows that these inclosures number several hundred, which gives some idea of the probable size of the village. In addition to the ruins already described there was still

another large village in this vicinity on the farther side of the Point of the Mountains, that is half or three-quarters of a mile downstream. Here for nearly a mile and a half along the gravel terrace above the alluvial plain of the Santa Cruz, and overlooking at a distance the 300 acres now under cultivation, pottery and the usual accompanying artifacts are thickly scattered. The central part of the village occupies an area of about 200 acres, while the surrounding part where population was less dense covers a slightly larger area. In the center of the village, pottery is thickly strewn, and the upper layers of earth are full of it to a depth of 2 feet, indicating very long occupation. This lower village was larger than the one on the other side of the mountains, and, to judge from the degree of ruin of its ceremonial chambers, it appears to have been occupied longer and abandoned earlier. Moreover, there are no defensive walls, so far as we could discover on the side of the hills facing it, although there are plenty on the other side. All these things suggest that the original village was downstream from the Point of the Mountains, and existed during a time of peace, prosperity and dense population, while the other village was occupied later, perhaps at a time when the water supply was becoming less so that it was necessary to move upstream above the rocky dam of the mountains. At the same time war-like conditions perhaps began to prevail, possibly because of the distress due to lack of rain, and accordingly the people of the village were obliged to build places of defence upon the mountain side.

Below Charco Yuma agricultural conditions become less and less favorable. Nevertheless ruins of villages are found at Nelson's Desert Ranch, 26 miles from Tucson, at Picacho, 16 miles farther down the Santa Cruz, and in several localities south of Toltec Station, which is about 55 miles northwest of Tucson. These last sites lie in a region where a recent attempt at irrigation has been made on a large scale. A dam of earth was thrown up to collect flood water, and canals were constructed to distribute it over a plain of the richest soil. My first knowledge of the project came from the sight of a cloud of dust which I saw from a mountain top many miles away. "That," said my companion, "is the dust of the 4,000 acres that the Santa Cruz Reservoir Co. plowed up and planted with barley last fall. Not a grain of their barley has come up in the whole 4,000 acres, and yet they are trying to sell farms." Later I rode through the dust of the great plowed field—dust ankle deep—and saw with my own eyes that there was not a vestige of any growing thing. During the winter no water came down to fill the reservoir; the next summer brought no better success, and the project was abandoned. The entire group of ancient villages in this region of unsuccessful irrigation below Charco Yuma must have contained as many people as the groups at either Jaynes or Charco Yuma. In every village of this



GRINDING STONE AT CHARCO YUMA, NEAR TUCSON, ARIZONA.

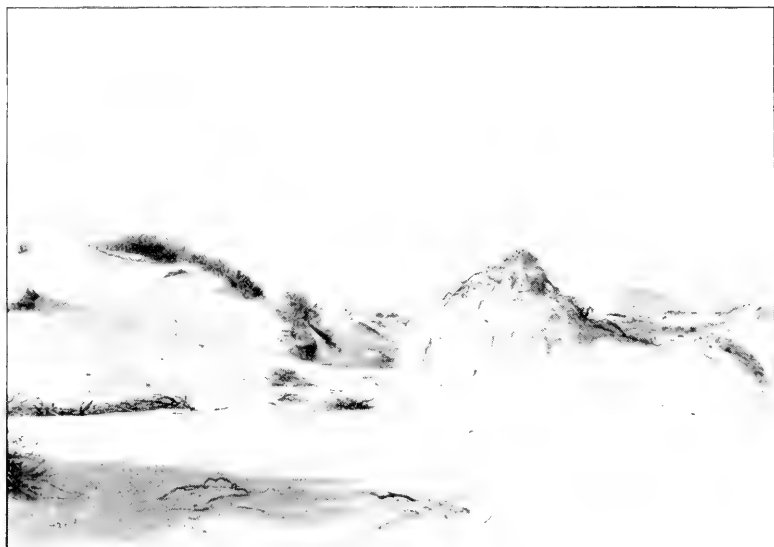

1. DUNES OF PURE GYPSUM NEAR THE DESICCATED LAKE OF OTERO, SOUTHERN NEW MEXICO.

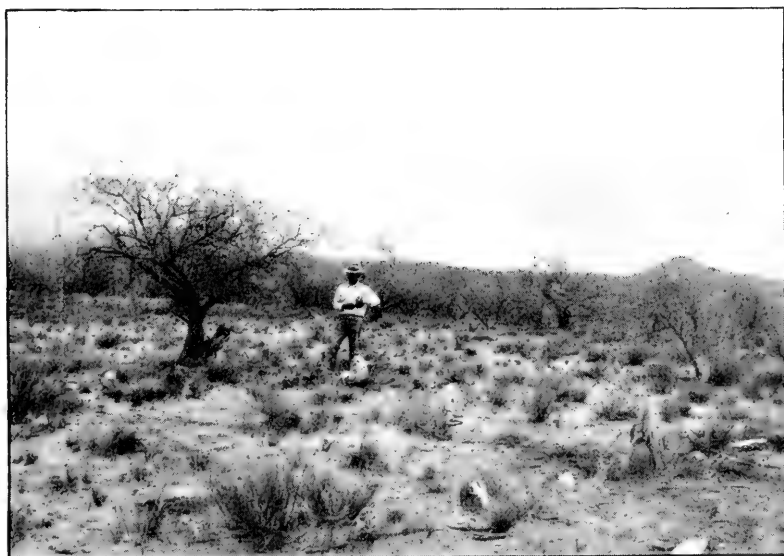

2. SITE OF A WATERLESS RUIN IN SANTA CRUZ BASIN AT RINCON.

The rows of stones in the foreground and extending to the left from the Mexican are parts of the foundations of ancient houses.

most remote group the problem not only of raising crops, but of obtaining drinking water, would apparently prevent primitive people from living there under present conditions. Wells a hundred or more feet deep, such as support the few far-scattered cattle ranches of modern times, were of course out of the question. Reservoirs were doubtless the common resource, but they were apparently constructed merely of earth without plaster, and at best they must have been shallow. If for 10 consecutive months no floods came down the river to this point, as happened in 1909-10, all the water must have disappeared by seepage or evaporation, to say nothing of daily use, long before the supply was replenished; while periods like 1884-1886, when there were no floods for at least 30 months, would inevitably cause the complete abandonment of such a village and probably the death of many of its inhabitants, by reason, not only of hunger and famine, but also of the wars and dissensions which would inevitably arise when all the country was in the throes of terrible drought.

To sum up the conditions in the Santa Cruz Valley, it appears that at present not more than four or five thousand people could find sustenance without modern railroads and other means of outside assistance. The part of the valley which is now capable of cultivation contains ruins which indicate that all the available land was utilized in the past. Below the point where irrigation is now possible there are three large groups of ruins, and the three together must have had as many people as the higher regions where there is still water. In other words, it seems as if the Santa Cruz Valley once had at least twice as many people as it could at present support, and half of these lived where the white man can not now get a living from agriculture.

Before leaving the Santa Cruz drainage area, we must describe two sites located at the headwaters of tributaries and affording phenomena different from those thus far discussed. The first is at Gibbon's ranch, east of Tucson, at the southern base of the Santa Catalina Mountains. This is one of the few places where the water supply depends upon a spring rather than a stream. In 1910 we found the site unoccupied, although a decaying adobe house stands beside a small reservoir supplied by two or three trickling little springs. The total amount of water in March, 1910, would scarcely have sufficed to irrigate 3 or 4 acres, an amount so small that the owner of the ranch did not find it worth while to practice agriculture at all, but turned his attention to cattle raising. Since his death or removal, no one has lived there. Some day, perhaps, a thrifty Chinese peasant will establish there a market garden. He will certainly be most skillful if he can make the water suffice for the support of more than two or three families. Yet once there was a respectable village here. East of the dry "wash" or sandy flood channel which occasionally carries water for an hour or two while rain is falling, my guide, Mr.

Bovee, and I counted the stone foundations of 28 houses in an area of 8 acres, while we found pottery quite thickly strewn over 40 acres. We doubtless missed some of the houses, either because their foundations have been concealed by the washing of gravel in floods, or because their appearance is insignificant. Hence we seem to be well within the limit if we say that the population of the village in its prime was probably as much as 120, whereas now the available water supply is sufficient for little more than one-tenth as many. I am well aware that the common objection to this conclusion is that the ancient Americans did not occupy all the houses of a village at once; that people built houses, and then if some one died they built others; and thus there might be many times as large a number of houses as there were families. This view, however, is unproved. Its basis, is first, the fact that certain modern tribes of Indians, few in number, and living largely in huts of temporary and easily constructed character, have the habit here described; and, second, the unfounded assumption that the population of the southwest in ancient, prehistoric times can not possibly have been so large as the ruins would seem to indicate, because the country can not now support so many people. In reply to this it may be said, first, that we have no knowledge of the customs of the Hohokam apart from what we learn from their ruins, nor do we even know that they were related to the modern Indians any more closely than we are supposed to be to our fellow Indo-Europeans, the Persians. In the second place, the habit of abandoning dwellings after some one has died in them is not at all common at the present time, and it rarely or possibly never prevails among a purely sedentary, agricultural people such as the Hohokam appear to have been. It is practically limited to tribes who wander from place to place and whose habitations are consequently of the nature of booths or mere temporary shelters, easily removed and easily renewed. In the third place, the size of the central structure of each ruined village, the supposed ceremonial chamber, is sufficient to indicate a considerable number of people. The stone foundations of the structure at Gibbon's ranch, for example, have a length of 105 feet, and it hardly seems probable that a mere handful of Hohokam, 10 to 20 in number, including women and children, would have built so large a building. Finally, it is unscientific to assume that conditions of climate have always been as they are to-day. It may be that those who hold this view are right, but they certainly are not justified in making the assumption when the matter has never yet been submitted to any rigorous mathematical investigation such as is here attempted.

After studying the ruins of the main Santa Cruz Valley I came to the conclusion that a mere examination of the map was sufficient to

indicate where ruins would be found. Accordingly I decided upon the head of the Rincon Valley, about 22 miles southeast of Tucson, as a test case. The expected ruins were found in the shape of several small villages, the chief of which contains the foundations of at least 18 houses. Probably there were once other houses in the valley, for pottery is found in several places where no foundations are visible. The present population consists of two Mexican and two American families, one of the latter being the forest ranger; but the arable land is said to amount to 150 or 200 acres, which would permit of a population of 20 or 25 families. The significant fact in this case is not the discrepancy between the present and past population. The number of inhabitants in the past was not limited by the amount of water available in the stream, but by the amount of level land in the narrow bottom of the valley. Apparently the Hohokam wanted more land than they could readily obtain. About a mile and a half east of the forest ranger's house and some 3 miles east of the prominent hill called Sentinel Butte, a grassy slope drops toward the northwest at the base of Rincon Peak, 8,465 feet high. The slope has a fall of about 10 degrees, and an altitude of from 3,300 to 3,500 feet above sea level. On the most favorable part of the slope, for a distance of about half a mile parallel to the upper Rincon, and for a width of half or two-thirds as much, one finds unmistakable terraces built apparently for purposes of agriculture. In general they are from 20 to 70 feet long and 2 or 3 feet high. The commonest location is at right angles to the minor drainage lines, each little swale being broken into terraces with a width of from 20 to 30 feet. In some cases the spaces between the swales are also terraced, the terrace walls in all cases being composed of pebbles and cobblestones. I searched carefully for pottery, but succeeded in finding only one or two coarse bits, quite in contrast to the abundant potsherds which occur not only among the foundations lower down the valley, but along the borders of the alluvial plain. The only other works of man among the terraces are some small stone circles, like the beds where the modern Indians cook the yucca to make the drink known as mescal, and a low round structure of bowlders. The whole hillside is almost exactly like hundreds in Palestine, Syria, and Asia Minor, or like others in Mexico and South America. Even the little round structure, about 7 feet in diameter, with its small doorway, suggests the watchmen's shelters in the terraced fields of Syria. There can scarcely be any doubt that the terraces were designed for agriculture. Apparently they were not intended for irrigation, for they are not properly arranged for this, nor does there appear to be any available source of water. They must have been intended for dry farming. Three or four miles down the valley, near the main village, a few simi-

lar terraces occur on a gravel slope east of the ruins and far above any available supply of water, so that here, too, dry farming appears to have been attempted.

Prof. Forbes of the Arizona Experiment Station, as has already been stated, says that dry farming is not now practicable in Arizona except by most careful and expensive methods of plowing and harrowing continued for two years in order to get a single crop. The terraced slope in the upper Rincon Valley, because of its proximity to the mountains, undoubtedly receives more rain than do many parts of the country. Over on the east side of the neighboring Santa Rita Mountains at an elevation considerably greater than that of our terraces, potatoes have been reported as grown without irrigation, but inquiry shows that they are watered naturally by springs seeping out above them. In the same region, at the mouth of Gardener's Canyon at an elevation of 5,000 feet, four or five settlers took up land and attempted real dry farming in 1909. The elevation is sufficient to insure moderately cool weather, and hence less evaporation than in the parching plains. The rainfall during the summer season of 1909, as measured at the Empire ranch, not far away, amounted to 9.39 inches as against an average of 7.93 for the preceding 15 years. Nevertheless, the corn of the settlers failed utterly; and the beans, the most reliable of all crops, gave so scanty a return that the farmers were completely discouraged. In the absence of records we can not say categorically that crops might not be raised on the terraces at Rincon. We can merely say that nothing of the kind has succeeded in this part of Arizona hitherto, and that in April, 1910, we found the terraces with no more sign of fresh vegetation than was apparent on the surrounding dry plains.

Apart from the immediate question of the possible climatic significance of the terraces, they are important in another aspect. Man-kind rarely labors except under the compulsion of some strong force such as hunger, fear, or ambition. The ancient Hohokam would scarcely have gone to the labor of making the terraces without some good motive. The obvious agricultural character of the terraces precludes the possibility of any religious significance, as does the fact that elsewhere such terraces are found closely associated with religious structures from which they are clearly differentiated. Defense apparently had nothing to do with the matter, for there seems to be no fortress near at hand, the terraces are in a decidedly undefensible location, and they are not protected by walls. The only adequate explanation would seem to be the need of more abundant areas of cultivation. Probably the Hohokam of the Rincon Valley found that the limited amount of land in the bottom of their narrow valley was not sufficient for their needs. Therefore, having somehow learned the art of making terraces as practiced in other

parts of the arid southwest or in Mexico, they built a considerable number, partly close to their main village, but chiefly on a slope of especially favorable location. This in itself may seem of small importance, but it is significant as indicating that probably the population was decidedly dense. Had there been abundant unused irrigable land either in the Rincon Valley or in neighboring regions, the Hohokam would scarcely have gone to the labor of building terraces. Hence we infer that the population of the country as a whole was as dense as is indicated by the abundant ruins.

The preceding pages have been devoted to the description of the phenomena of a single valley in southern Arizona. That valley was not chosen because of the strength of its evidences of climatic changes, but merely because it happened to be the first which I investigated and the one where I spent most time. Half a dozen others might have been chosen equally well. The same type of phenomena is displayed with equal clearness in the Altar Valley of northwestern Mexico, in the Chaco Valley, 500 miles to the northeast, in the northwestern corner of the State of New Mexico, and in numerous valleys between the two, and in the regions round about. Further details, however, would overcrowd this article and we must hasten on to consider another phase of the subject.

PART II. THE SUCCESSION OF CIVILIZATION.

Thus far we have dealt solely with the question of whether the climate of the past was different from that of the present. Having concluded that there is strong evidence that this was the case, we shall now attempt to ascertain whether the change from the past to the present took place gradually or in pulsatory fashion, and whether its various phases synchronize with similar phases in the Old World. The first evidence on this point is derived from alluvial terraces and lacustrine strands, and points distinctly toward pulsatory changes, but gives little clew to their dates. Coming to man's works, we find that a broad view of the ruins of the southwest seems to show that they belong to at least three periods. During each of these periods the area capable of cultivation appears to have been more extensive than at present, although only slightly so in the last period. In the middle period the arable area was larger than in the last, and in the earliest still larger. The last period dates back only to Spanish times. The best example for discussion here is the ruins of Gran Quivira in central New Mexico. These ruins lie on the top of a rounded hill about 200 feet above a broad open valley draining toward the south and a mile or more in width. The altitude of the region is over 6,000 feet, so that the temperature is comparatively low. The ruins consist of two distinct portions, Pueblo and Spanish, covering an area about 700 by 350 feet. All the buildings were con-

structed of rough rectangles of light gray limestone, whose character is such that long and arduous work would be required to get it out in large quantities without the aid of explosives. Inasmuch as the village was evidently built long before the coming of the Spaniards, we must assume that the Pueblos, or their predecessors, put themselves to a vast amount of labor in the process of quarrying, squaring, and transporting the stones of their numerous houses. Many of the dwellings were of two stories, and the height of the heaps of rocks makes it probable that some were of at least three stories. The rooms are all small, as is customary in this region, the majority not exceeding 7 by 9 feet. The exact number of rooms has never been counted, but if we assume that only half of the $5\frac{1}{2}$ acres covered by the ruins was actually built upon, and that the rooms, including the walls, had an average size of 10 feet by 10, there must have been about 1,100 rooms on the ground floor. The upper stories may be put at 400 rooms, although the actual number was probably two or three times as great. This gives 1,500 rooms as a low estimate, which would mean at least a thousand people.

When the Spaniards came to the country at the beginning of the seventeenth century, the village of Gran Quivira was evidently one of the most important in the district. Otherwise the canny fathers would not have built here one of their largest missions. Possibly a portion of the village was in ruins, and the rocks from it may have supplied materials for the large church with walls 5 feet thick and for the other structures which the Spaniards erected. Nevertheless the number of natives must have been considerable. The beginning of the Spanish régime here, as in the rest of New Mexico, appears to have been highly peaceful and prosperous. Its end, so far as Gran Quivira is concerned, seems to have come at the time of the Pueblo rebellion, which culminated in 1680. Since that time the site has been left as a center around which a multitude of traditions have gathered. One tradition ascribes its destruction to an earthquake, another to a flow of lava bursting forth some miles away, and still a third speaks of a river which has now disappeared.

The truth seems to be that there is no village now at Gran Quivira because there is no water and the land is too dry for successful cultivation except in years of good rainfall. A ranch is located in the valley below the ruins, but it is not permanently inhabited, although a little cultivation is carried on. Settlers have recently taken up land 10 to 15 miles to the north, but are having a very hard time. If the rainfall is propitious they can exist, but in 1909 none of them raised enough to live on. It scarcely need be added that all depend upon deep wells for water. So far as we can gather, the Pueblo Indians, like their Hohokam predecessors, knew nothing of lime or mortar and had no facilities for making water-tight cisterns. They



1. TERRACES APPARENTLY FOR CULTIVATION ON A DRY HILLSIDE AT TRINCHERAS. The prominent rectangle in the center appears to have been the site of a religious structure



2. TYPICAL FOREST OF SUHUARO OR GIANT CACTUS IN THE SANTA CRUZ VALLEY.



1. CLIFF DWELLINGS IN THE CANYON DE LOS FRIJOLES.



2. RUINS OF TUYONI IN THE CANYON DE LOS FRIJOLES.

constructed numerous reservoirs, however, and these were their main dependence in the dry season. One such reservoir still remains intact at Gran Quivira. It lies about a quarter of a mile east of the village in the mouth of a shallow arroyo, as dry valleys are here called. The reservoir is only about 75 feet in width and 5 feet deep. The owners of the ranch down below in the main valley say that during seven years of life here they have never seen any water in it except immediately after rain. My visit took place in the early spring of 1911, after a more than commonly rainy season. The day before I started from the railroad at Willard, 30 miles to the north, there was a heavy storm, and during the drive we were soaked in a pouring rain. Nevertheless the next morning the reservoir contained no water and showed no sign of having had more than a small pool in it the day before. In all the region within a score of miles of Gran Quivira there is only one permanent spring. That is located 7 miles to the west at Montezuma, and, as might be expected, it has its own ancient village. Strangely enough, however, the Montezuma village was apparently abandoned long before Gran Quivira. This suggests that the difficulty of raising crops was a more serious matter than the difficulty of obtaining water. At Montezuma the land does not lie so low and flat as at Gran Quivira, and is not flooded as are the lowlands of the latter place during summers, when the rainfall is unusually large. In considering these places the point to be borne in mind is this: We have before us two theories, which stand on an equal footing as to innate probability. The only question is which one best fits all the facts. One theory is that the climate of the past three centuries has been uniform, while the other is that the seventeenth century was considerably moister than the nineteenth, and that the eighteenth century was intermediate between the other two. Viewing the two theories without prejudice, the theory of change seems to fit the facts better than the theory of uniformity. Hence we may tentatively conclude that the seventeenth century was a period of relative humidity, although both the preceding and succeeding centuries may have been comparatively dry.

The other two periods of relative moisture may well be discussed together. One of the most striking examples of a former abundant population in a region now almost uninhabited is the Chaco Canyon in the northwestern corner of New Mexico. It lies just to the west of the wooded crest which forms the continental divide in this portion of the great southwestern plateau. As soon as the wooded area is left behind one comes out upon a barren treeless plateau at an elevation of 6,000 or 7,000 feet, a dreary region where one may ride 25 miles at a stretch without seeing a single habitation. The only inhabitants are a few nomadic Indians of the Navajo tribe and a handful of white settlers. The Indians and a few of the white men

keep sheep, while the rest of the white men, which means about one for every thousand square miles, are traders who supply the simple wants of the Indians, and incidentally make large profits. Here and there a few acres are cultivated by the Navajos, but not one family in ten possesses any arable land, and even those who have fields by no means get their main living or even a good share of it from agriculture.

The most remarkable portion of this region is the Chaco Canyon. In this steep-sided, flat-floored valley there are at the present time two Indians who are reasonably sure of a crop of corn each year. I saw their farms, unbelievably dreary wastes of drifting sand in the bottom of the canyon where two large branches join, and where there is consequently more water than anywhere else for 50 miles. The sand is a necessary adjunct of farming, for it is needed to act as a mulch to prevent the evaporation of the precious water. These two men between them have not more than 20 or 30 acres, if as much. Even their crops fail completely sometimes, as in 1903. During the last 16 years, that is, from 1895 to 1911, according to information given me by a trader's wife who has lived there during that time and who moved away because her husband was murdered by the Indians, the crop of all the Indians except the two just mentioned failed absolutely in the years 1902, 1903, and 1904, while good crops were raised in only two years, 1905 and 1908. During the remaining 11 years an Indian here and there raised a scanty crop, but none of them could get a living were it not for their cattle and horses.

The contrast between the past and the present is remarkable. In the Chaco Canyon or on the plateau on either side of it there are about 20 ruins of considerable size within a distance of 25 miles. Some of these, such as Pueblo Bonita, Chetwelketl, and others, are strongly built, compact structures, which must have sheltered hundreds of people, and the larger ones probably had one or two thousand denizens. There can scarcely have been less than 5,000 people in the canyon and its vicinity, and perhaps the number was much larger. Whether it be 10,000 or 1,000, however, matters little, for the main point is that we have here a series of strongly built, fortified villages whose inhabitants evidently cultivated a large amount of land where now no crops can be raised. These people, as appears from their pottery, their skulls, and their methods of architecture, belonged to a civilization different from and earlier than that of the modern Pueblos who inhabited Gran Quivira at the time of the coming of the Spaniards.

Yet the builders of the high walls which we now see in the Chaco Canyon were not the original inhabitants of the country. Digging down below their ruins one finds traces of an older occupation. Moreover, the largest villages with houses of several stories, which are now in chief evidence, invariably lie near to main lines of drainage



1. CLIFF DWELLINGS AT THE LARGE RUINS OF PUYÉ.



2. PREHISTORIC CARVINGS AT PUYÉ.

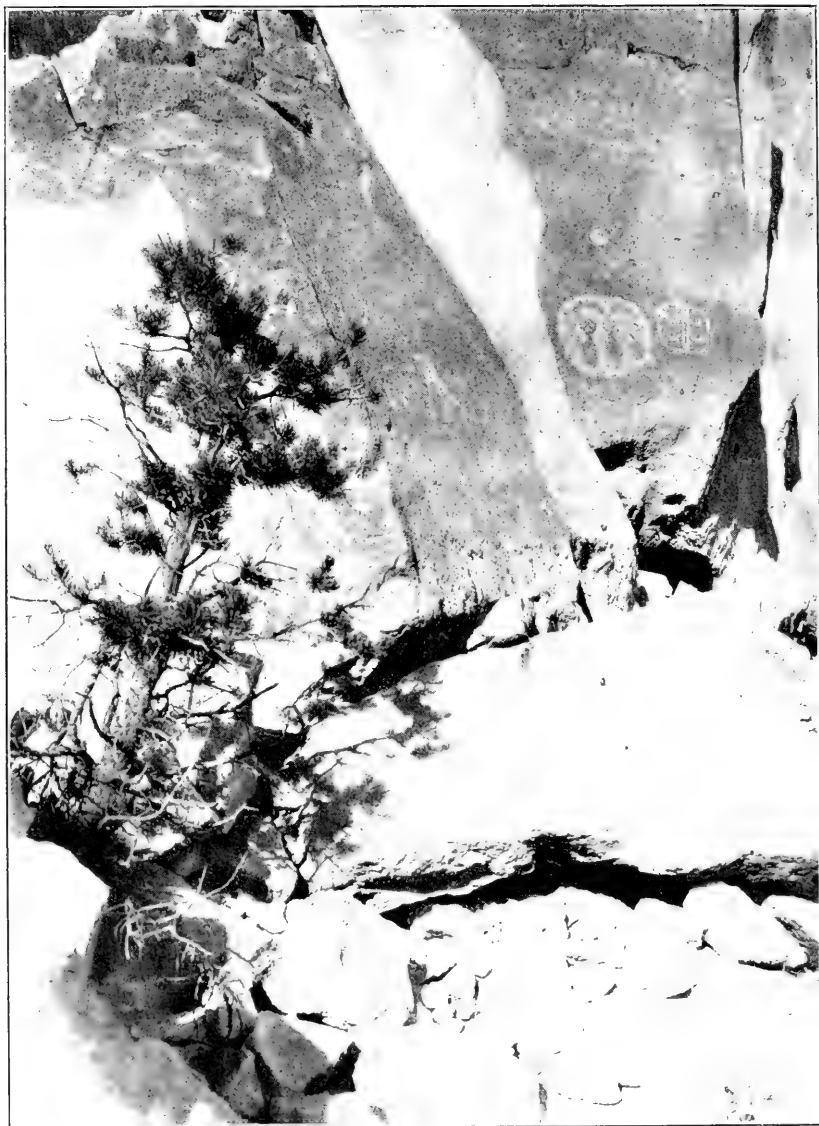

PICTOGRAPHS AT PUYÉ ON THE PAJARITAN PLATEAU, NEW MEXICO. "THE THREE SISTERS."

or to places where it is clear that a moderate increase in the amount of rainfall would cause permanent streams or springs to flow. Farther away on the top of the plateau, however, far from the larger ruins and remote from any except small valleys, numerous ruins of another, more primitive type are found. They are usually small, and are greatly ruined, and seem to belong to a time long anterior to the main large ruins.

One of the best places for the study of this older type of ruins is in the Pajaritan Plateau, 20 or 30 miles northwest of Santa Fe, the capital of New Mexico. I was taken to this region by Mr. Kenneth M. Chapman, curator and artist of the Archeological Museum of New Mexico. The plateau is a beautiful district covered with forests of juniper and piñon, which at higher altitudes give place to stately yellow pines set in open order with stretches of sparse grass between them. In spite of the deep soil, the grass, and the trees, we saw no sign of habitation, for except in a few insignificant spots in the bottoms of the canyons where irrigation is possible, all the great plateau is too dry for any cultivation below a level of about 8,000 feet. Soon after reaching the main top of the plateau we came upon the first of the great number of ruins which are scattered in every part of the plateau. These particular ones were cliff dwellings of the usual type, caves dug in the soft volcanic rock of the side of a shallow canyon, and fronted by rooms made of blocks of the same soft tufa. The number of such caves and cliff dwellings is literally thousands in this one Pajaritan Plateau. With them are associated the ruins of villages like those of the Chaco Canyon. After crossing several minor canyons, we found ourselves at the edge of the deep Canyon de Los Frijoles, or Bean Canyon, where a precipitous cliff fell away 400 feet or more at our feet. Unhitching the horses we left the wagon on the plateau, and turned the animals down a steep winding trail, blasted in part from the face of the solid rock. We had not followed them far when I uttered an involuntary exclamation of delight. I knew that we were to visit one of the most interesting ruins of New Mexico, but I had no idea of finding it in so picturesque a canyon. I had still less expectation of suddenly seeing far below us on a small level space at the base of the precipice a structure which at first sight suggested a Greek amphitheater. It was the village of Tuyoni, excavated by the School of American Archeology at Santa Fe in the four seasons from 1908 to 1911. The plan of the ruins is symmetrical, a circle slightly flattened on the north side, and containing from five to eight tiers of rooms arranged like the seats of a theater. Across the flattened end where the stage would be expected a line of rooms contains the remnants of three circular chambers or "kivas," designed for religious purposes, apparently analogous to the larger circular or elliptical structures which are

found so commonly among the ruins of adobe and wattle villages in the Santa Cruz Valley and other regions farther south.

The Canyon de Los Frijoles contains not only the main ruined village of Tuyoni and several smaller ones, but also a great number of caves and cliff dwellings. Doubtless the caves were at first the chief homes of the aborigines; but as time went on and a higher stage of civilization was reached, the excavations were used chiefly as store-rooms, and the main life of the households was conducted in rooms of stone plastered with mud. Often a house consisted of three tiers of rooms in front of a cave; and in many cases the rooms were built one on top of another to a height of three stories. Most of the rooms, like those of all the primitive people of the Southwest, as well as the modern pueblos, were entered through the roof. The small size of the rooms, not over 6 feet by 10 feet on an average, is surprising. The reason, however, seems clear. On the high Pajaritan Plateau the temperature often falls to 10° below zero F. The relatively dense population must quickly have used up all the available dead firewood for many miles around, and it was no easy task for a primitive people unsupplied with iron tools to cut firewood sufficient for anything more than the necessities of cooking. Farther south, or at lower altitudes, the rooms were larger, for there it was easy to keep warm. The low temperature does not appear to have diminished the number of inhabitants. Frijoles Canyon alone within a distance of not over a mile and a half up and down the narrow gorge, had a population of fully 2,000 souls, according to the estimates of Dr. Edgar L. Hewett, director of the School of American Archeology, who was personally in charge of the excavations. The actual number of rooms, including the village amphitheater, the caves, and the cliff dwellings, appears to have amounted to about 3,000. At the present time, according to Judge Abbot, who owns all the valley except the ruins, the amount of land that can be irrigated amounts to 21 acres. Manifestly the ancient Pajaritans climbed out of the canyon to their daily work, and cultivated the plateau where now not a solitary person can make a living from the fruits of the earth.

This leads us to a consideration of the older and more widely scattered occupation of the country. During our drive to Frijoles Canyon we watched carefully not only for cave dwellings and villages of the Tuyoni type, but for the location of little mounds which here and there at a distance from the main sources of water proclaim the location of houses scattered all over the plateau. One who is not closely on the watch may miss these entirely, for they are merely small heaps of stones. In the space of 7 miles we saw houses of this type within sight of the road in 49 different places. Inasmuch as several houses were often clustered in one group, the total number of dwellings was 67. They were obviously mere farmhouses, but some



1. RECTANGULAR FIELDS FOR DRY FARMING ON THE GRAVELLY SLOPE AT THE BASE OF THE GREAT TRINCHERA OF THE MAGDALENA BRANCH OF THE ATTAR RIVER IN NORTHERN SONORA, WHERE DRY FARMING IS NOW IMPOSSIBLE.

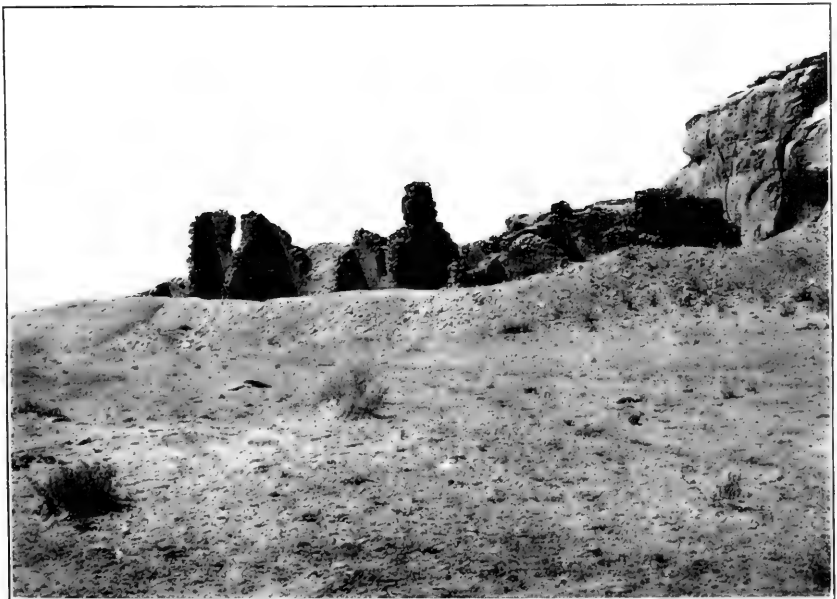

2. RUINS IN CHACO CANYON, NEW MEXICO, AT PUEBLO BONITA.

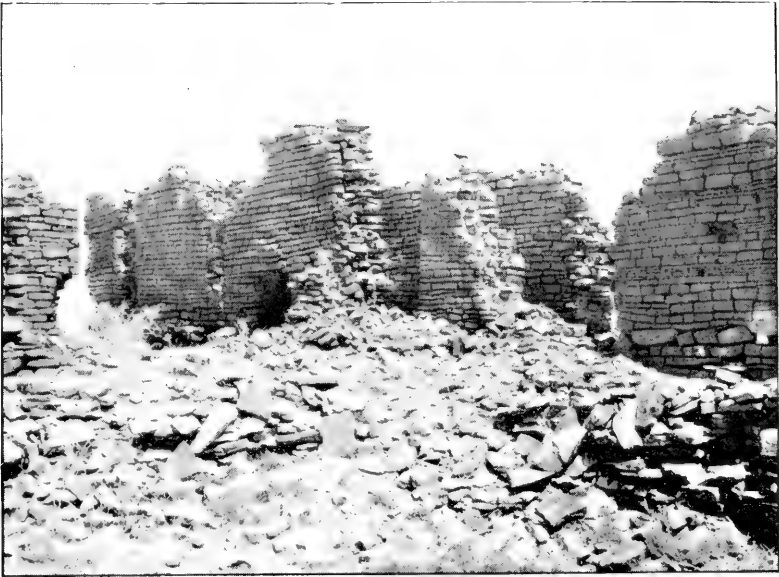

1. RUINS IN CHACO CANYON.



2. RUINS IN CHACO CANYON.

had from 8 to 20 rooms, and must have been inhabited by more than one family. Therefore in our 7-mile drive through the open, park-like forest we must have found within sight of the road the dwellings of approximately a hundred families. It would be a populous farming district in any part of England where one could find a hundred families on 7 miles of road. We can not, of course, assume that absolutely every one of these houses was occupied at one time, but it is not at all probable that any large number were vacant at a time when new ones were being built. Well-squared blocks of stone must in those days have been too valuable to permit of their being wasted when new houses were to be built. Even in these days when metal tools and explosives make it easy to quarry new stone, and when the population is much less dense than formerly, the great ruins of antiquity in western Asia are in constant danger of being utterly destroyed by the natives, who carry away the stone for use in new houses. In the days of the Pajaritans, when the blocks of stone had to be hewn with stone axes and carried from the quarries in the canyons on the backs of men, or rather of women, we can scarcely believe that the people were so extraordinarily industrious or so superstitious that they would leave good stones in ruins close at hand and go to the labor of dressing new ones. Therefore we believe that at the height of the prosperity of this region the site of practically every ruin was occupied by an inhabited farmhouse.

These scattered little ruins, almost unnoticed even by the archeologist, present one of the most interesting problems in American archeology. The potsherds found in them are of a different type from those found in the larger villages or in the majority of the cliff dwellings immediately around them. The pottery of the farms, as Mr. Chapman points out, is almost wholly a fine-grained ware painted white and adorned with geometrical designs in black. In the larger, more modern ruins, however, only a little of this is found, while the commonest kinds are a coarser white ware with more abundant curves in the designs, and a wholly different type of red ware adorned with black figures painted with a species of glaze. These differences, coupled with other evidence such as the manifestly greater age of the small isolated ruins, show that here, even more plainly than in the Chaco region, we have to do with two occupations as distinct from one another and from the later and far less extensive Pueblo occupation of the country as are the modern American and Spanish occupations. The first inhabitants spread far more widely than their successors. They seem to have felt no need of being near the main sources of water nor yet of gathering together as the later people did in places which could easily be defended. For a long period before the advent of the enemy, which finally displaced them, their lives were free and comfortable in their high forest homes.

How or why they vanished is as unknown to us as is their origin, but perchance we shall learn the story little by little. It will not be a story of peace and monotony, for those are not the conditions which prevail when a race comes into a country, nor when it is forced out. We can scarcely doubt that stirring times took place—raids, plunder, repeated invasions, great distress, and the final disappearance of one type of civilization and its replacement by another. And this painful process of a change of civilization took place not once alone, but at least twice. Formerly the cliff dwellers who built the compact villages like Tuyoni and Pueblo Alto were supposed to have been of the same race as the modern Pueblo Indians, but now we know that this is not true. Possibly, nay probably, the modern Pueblo is related to the second or village-building type of ancient inhabitants, whom we may call Pajaritans in distinction from the still older type who may, perhaps, be classed as Hohokam, but the relationship is not close. The bones of the dead, exhumed after centuries, tell something of the tale. The modern Pueblo Indian is brachycephalic, according to Dr. Hrdlička; his head is relatively broad, as anyone can tell by looking at him. Some, however, are dolicocephalic, with long heads, but these are in a minority. The present Indians are clearly of a mixed race. Their predecessors, on the contrary, were of a pure race, predominantly long-headed, like ourselves. Therefore we infer that they were conquered by invading broadheads, and that finally the invading broadheads and as many of the longheads as had neither fled nor perished became amalgamated into a single race. Perhaps the ancient farmers, the medieval villagers, and the modern Pueblo Indians were not the only races which have passed across the stage of history in the prehistoric days of America. In other parts of the Southwest faint glimmerings are seen of still other cultures, which show that change and movement have been as characteristic of the ancient history of America as of that of Europe and Asia.

The dates of the three types of civilization of which we have found evidence can not well be determined. Dr. Hewett believes that the traditions of the Pueblos may be relied upon as showing that it is at least 800 years since the villages of the Tuyoni type were occupied, but he attempts to assign no exact dates. One point, however, may here be emphasized. In Asia, as I have shown in "The Pulse of Asia," and more fully in "Palestine and its Transformation," we have evidence which suggests that each of the chief dry epochs has been characterized by great movements of peoples. The first such movement whose date is well defined was about 1200 B. C. At that time the ancestors of the Greeks came into their peninsula, the Hebrews entered Palestine, the Aramæans from Arabia spread out into Babylonia and all the neighboring lands, and Egypt was over-

whelmed by invaders from both the Libyan and Arabian deserts. The next great period of aridity culminated in the seventh century or thereabouts. Its approach was marked by the barbarian invasions of Europe, and its culmination by the Mohammedan outpouring from Arabia. Finally, the third of the more important dry epochs reached its climax in the thirteenth century A. D., when the hordes of Ghenghis Khan ravaged Asia from China to the Mediterranean. Besides these more intense periods of aridity there seem to have been others of minor importance, but these need not here be considered. The history of Asia during the last 3,000 years thus consists of three main epochs of moist climate and advancing civilization, separated by epochs of aridity and declining civilization accompanied by migrations and wars. In comparing America with Asia it is interesting to find that in the drier portions of the Western Hemisphere we also have three main periods of prosperity and apparently of abundant precipitation separated by epochs of decline and depopulation. Perhaps the ancient farming population of America, the Hohokam, may date from the period of moist climatic conditions at the time of Christ and earlier. Their disappearance may have been due to the aridity of the period which culminated in the seventh or eighth century. Then the village people, the Pajaritans, may have flourished in the Middle Ages, and may have been ousted by the twofold disaster of prolonged drought and fierce invasion which would have come to America about 1200 A. D. if conditions here were like those of Asia. And, finally, the occupation of places like Gran Quivira by the modern Pueblo Indians may have been made possible by the propitious conditions of relatively abundant rainfall which followed the aridity of the thirteenth century. I do not advance this as more than a working hypothesis, but as such it may suggest various lines of research hitherto neglected.

PART III. THE EVIDENCE OF THE TREES.

The evidence of climatic changes thus far presented probably seems much more conclusive to the writer than to the reader. I am well aware that when the name of an author once becomes identified with a theory his fellow workers are apt to discount his results. They know that a man is prone to find what he looks for, and that when certain facts are capable of two or more equally plausible explanations he is likely to choose in accordance with his preconceived ideas rather than according to the weight of the evidence. In searching for some method whereby this danger might be avoided I found no success until an article by Prof. A. E. Douglass, of the University of Arizona, appeared in the *Monthly Weather Review* for June, 1909, under the title "Weather Cycles in the Growth of Big Trees."

Prof. Douglass there shows that in dry regions the thickness of the rings of wood formed each year varies so closely in harmony with climatic conditions that it may be used as a measure of the climate of the past. Taking about 20 sections of trees from two to five hundred years of age, he made micrometer readings of the thickness of each individual ring, and thus obtained the average growth for each year. As a result he finds that the curves of growth and of rainfall for the 40 years or so since records are available present a marked agreement. Manifestly, then, the curves of growth may be used as a means of determining the rainfall in periods long antecedent to any human records. Douglass has so used them, and his analysis indicates cycles of precipitation with a periodicity of 11, 21.2, and 32.8 years, a result which agrees with the cycles indicated by records of rainfall. He did not attempt to investigate larger cycles, nor to determine the relation of the climate of periods separated by hundreds of years. Obviously this is possible, and it needs only an expansion of Douglass's method and a study of the sources of possible error to enable us to come to definite conclusions as to the nature of the climate at any time back to the youth of the oldest available trees.

During the year 1911 I began to make use of the method of Prof. Douglass and obtained some most interesting results. In the first place, Prof. H. S. Graves, Forester of the United States Forest Service, most courteously placed at my disposal several thousand "stem analyses," or measurements of the rings of trees by the members of his bureau in various parts of the United States. In the second place, I went to California on behalf of the Carnegie Institution, and with several assistants made similar analyses of 451 of the "Big Trees" or *Sequoia washingtoniana* of the Sierra Nevadas.

Let us first ascertain what may be learned from a study of the trees of New Mexico which grow in the mountains close to the ruins which we have hitherto been considering. The courtesies of the Forest Service have included not only the placing of a large number of stump analyses in my hands by the chief of the bureau, but also some most helpful compilations by other members of the service. I am especially indebted to Mr. A. B. Recknagel, chief of silviculture at Albuquerque, N. Mex., who has gathered a most valuable series of statistics for the yellow pines of that State, and has most generously allowed me to use them. His data are based on 645 trees from four of the United States forest reserves, scattered in such a way that they have approximately the same distribution as the ruins with which we have been dealing. In general, however, they lie at greater altitudes than the ruins, in the portion of the yellow-pine area where the trees grow best and where they are neither at the lower limit so as to be especially liable to injury by drought nor at the upper limit so as to be especially liable to injury by excessively

low temperature or long winters. Moreover, they were not selected with a view to any special characteristic other than age. All the available analyses of trees over 200 years of age were used, and to them were added an approximately equal number of younger trees in order to afford fair comparisons.

From Mr. Recknagel's figures I have computed how fast the average tree grows during the first, second, and third decade, and so on to the end. This shows that the average tree grows 0.46 inch during the first decade of its life, 0.63 during the third, 0.40 in the twelfth, and only 0.23 in the thirtieth. Obviously, if we are to compare the

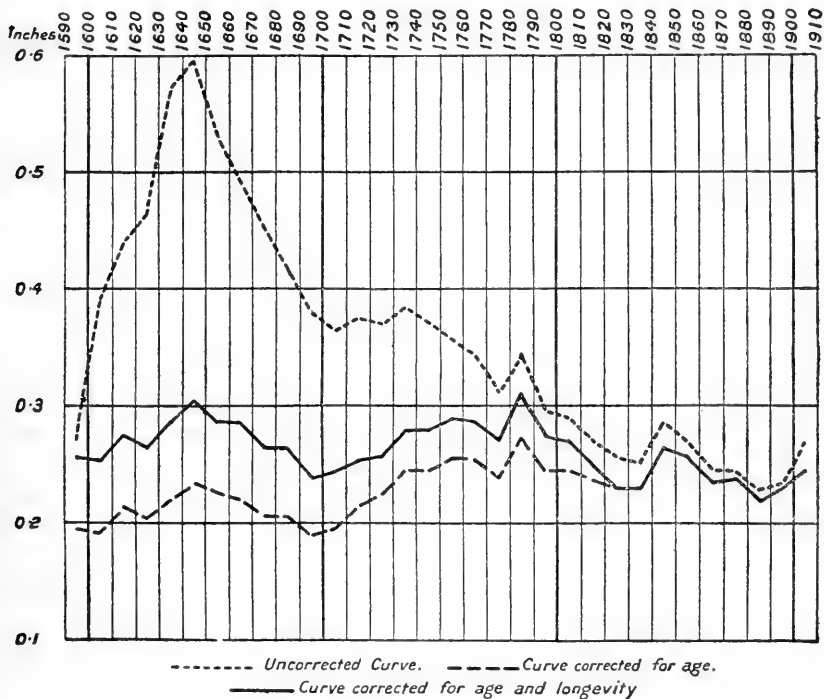

FIG. 1.—Curve of growth of 50 yellow pines over 280 years of age.

climate of different periods during the life of the tree, we must eliminate the differences due merely to the fact that the tree has grown older. Another correction must also be applied. A study of Mr. Recknagel's figures, as well as of many others, shows clearly that if a tree is to live to old age, it can not grow fast in its youth. That is, if we take a large number of trees so as to obtain averages, the tree which grows faster than the normal rate in its youth dies at less than the average age, while one which grows abnormally slowly stands a good chance of living to an exceptional age, provided the slow growth is not due to disease. These two types of correction

are purely mathematical, and do not depend upon the individual judgment of the investigator. While he is working out the calculations he can not have any idea of the exact results which will be obtained; nor can he make the results fit one theory rather than another except by willful manipulation.

The accompanying diagram, figure 1 (p. 407), shows the results of Mr. Recknagel's tree analyses when computed according to the method here described. The horizontal lines indicate the course of time from 1590 to 1910 A. D. The height of the curves indicates the relative rate of growth of the trees at any particular date. Figure 1 is given simply as an example to show the effect of the corrections. It is based upon the 50 oldest trees, which began growth at periods ranging from 1460 to 1590 A. D. The upper dotted line indicates the actual average rate of growth of these 50 trees without any correction whatever. The lower dash line is the same curve after the correction for age has been applied—that is, after allowance has been made for the fact that young trees grow faster than old. The solid line shows what happens to the curve when the correction for longevity is added to that for age—that is, when allowance is also made for the fact that during their youth trees which are to live to a great age regularly grow more slowly than the normal rate.

Turning now to the interpretation of the New Mexican curve, we find a surprisingly close agreement with our conclusions based on the evidence of terraces, archeology, and history. Before going on to discuss the matter I would emphasize the fact that these conclusions were all reached before the trees had been investigated. They have been set down above exactly as they were reached, at a period of from 15 to 5 months before any examination of the trees was made. The importance of this lies in the fact that the agreement of the mathematically derived tree curves with the conclusions derived from entirely different methods furnishes the strongest possible confirmation of the accuracy of those methods as employed both in America, Asia, and southern Europe. From the ruins of Gran Quivira, it will be remembered, we concluded that at the time of the Spanish occupation of New Mexico in the first half of the seventeenth century climatic conditions were distinctly more favorable than at present. About 1680 the ruins of Gran Quivira seem to have been finally abandoned at the time of the Pueblo rebellion. During the succeeding century conditions appear to have been somewhat better than during the one that ended in 1900, as appears probable from the ruins of Buzani, and one or two other places not here mentioned. The curve of the trees points to exactly the same conclusion. One reason why the Spaniards were able to establish themselves in New Mexico almost without a blow may have been that from 1600 to 1645 the amount of rain and the general conditions controlling the growth of



1. YOUNG AND MIDDLE-AGED SPECIMENS OF SEQUOIA WASHINGTONIANA.



2. A STUMP OF SEQUOIA WASHINGTONIANA.

A section cut from this stump was exhibited at the World's Columbian Exposition in Chicago in 1893, and is now in the American Museum of Natural History in New York City.

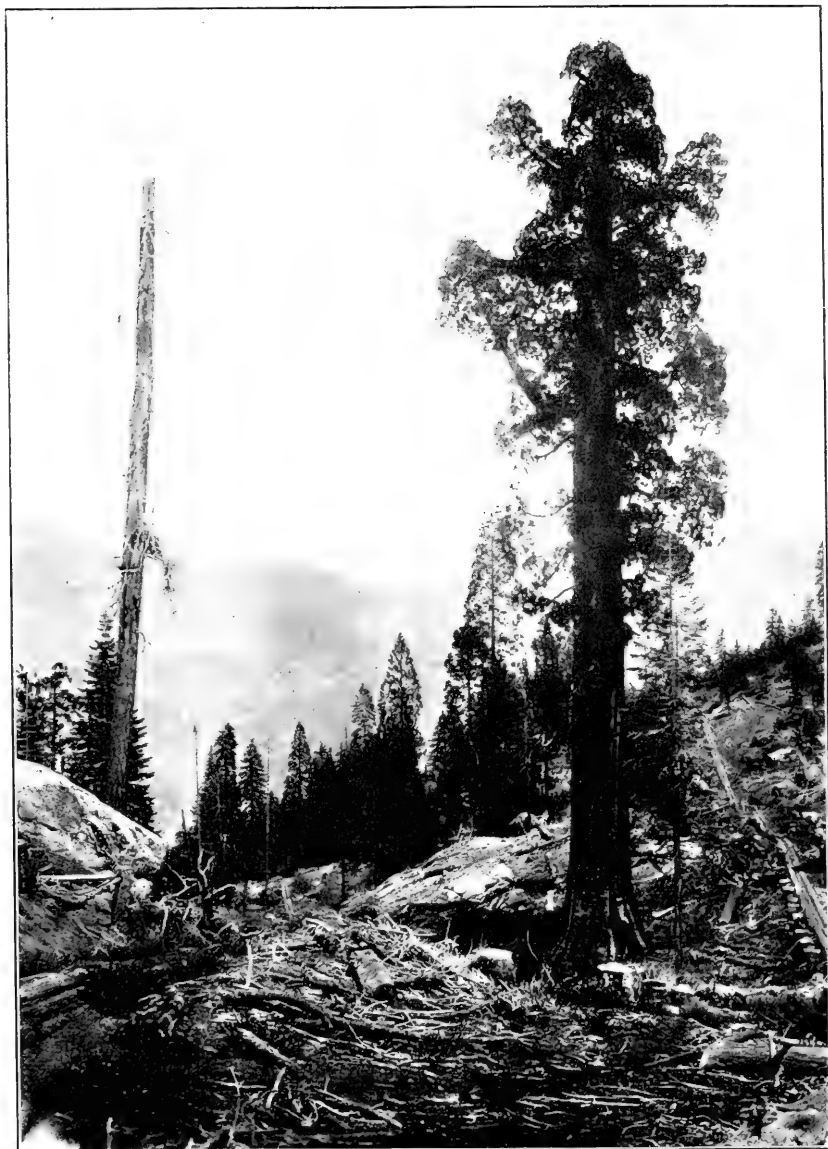

A SEQUOIA WASHINGTONIANA, 2,500 YEAR OLD.

vegetation were more and more favorable. Places like Gran Quivira were readily habitable and were growingly prosperous so far as their prosperity depended upon good crops. Under such circumstances the ignorant Pueblos would naturally look upon the coming of the Spaniards as a blessing. A decrease in rainfall begins to be apparent about 1645, but it is unimportant at first because the amount of growth of the trees, and impliedly of the crops, continues to be well above the normal until about 1665. Thereafter a rapid deterioration takes place, which culminates about 1680 or soon after. At that very time a widespread uprising took place against the Spaniards, the Pueblo rebellion, which ousted the Europeans for some years. Famine must have prevailed as the climate became drier, and the distress occasioned would almost surely lead the Indians to ascribe their misfortunes to their conquerors. Curiously enough a document has just come to light which confirms our conclusion as to famine. I am indebted to Mr. E. E. Free, of the Bureau of Soils of the United States Department of Agriculture, for calling my attention to an account of an old census given by Mr. J. W. Curd, in the *El Paso Times*. El Paso, although in Texas, lies almost at the middle of the southern boundary of New Mexico. The census is dated September 11, 1684, and contains a list of 109 Spanish families living near El Paso. It is signed by the Spanish governor. "While the document is nothing more than a dry and uninteresting census roll," to quote Mr. Curd, "it is illuminative of the terrible devastation and suffering that resulted from the Indian revolt in 1680. This revolt destroyed some 42 presidios and missions in New Mexico north of El Paso, and the remnant of Spaniards and friendly Indians took refuge in Guadalupe del Passo (El Paso). While the Mission Guadalupe was a rich one, and additional supplies were forwarded from Mexico City, the people still suffered from lack of clothing and food. The census shows that what crops were planted that year consisted only of maize, which, owing to drought, was an almost total failure. What maize was grown was eaten green, so there was no supply for winter." It is not here possible to carry the matter further. The curve speaks for itself. After 1680 conditions appear to have improved; the eighteenth century was a period of less rainfall than during the time of the early Spanish occupation, but of more than the last century.

The *Sequoia washingtoniana* of California is the largest and probably the oldest known tree. During the summer of 1911 I was able to make measurements of 200 stumps, which ranged from 6 to 25 feet in diameter, and from 250 to 3,150 years in age. Three were over 3,000 years old, and 40 began to grow 2,000 or more years ago. During 1912, 251 more were measured, 39 being over 2,000 years of age. The result of the tabulation and calculation of these 451 trees is shown in figure 2 in this article. The sequoia grows in a region which is

climatically similar to New Mexico, except that it is colder and has no rainy season in summer. Long, snowy winters and rains continuing well into the dry summer are the conditions which favor growth. The curve of the sequoia has been computed in the same way as that of the other trees. The period covered by the growth of the trees, however, is so great that the number of trees whose analyses are now available is not enough to give certainty to the corrections. Accordingly, after obtaining a curve corrected as accurately as possible both for age and longevity, I have tilted the whole line slightly in order to make the relative height at three or four fixed points correspond as nearly as may be with the height of the Caspian Sea at the same dates. This, however, has no effect upon the sinuosities of the curve, but merely upon the exact amount by which the earlier parts are higher than the later. Before we proceed to discuss the curve a word or two of explanation may be added. The horizontal lines indicate the growth in millimeters per decade. The extreme fluctuations of the early part of the curve give an exaggerated idea of the variability of the climate at that time. This is due to the small number of trees available. When more have been measured the extremely sharp character of the depressions and hollows, or of the arses and theses, as I have elsewhere called them, will disappear.

Examination of the curve shows that the climate of the interior of California has been subject to marked pulsations during the past 3,000 years. For instance, at the time of Christ the tree grew 30 per cent faster than at the end of the fifteenth century. Practically all the trees at the latter date were of large size with thoroughly developed root systems, and with a vast supply of strength stored up from the past. Moreover, they were growing high among the mountains where the supply of rain and snow was largest, and many of them were standing in swamps or beside brooks. If they could be so affected by drought as to show a decrease of 30 per cent in the amount of growth, other less favored plants must have suffered much worse. It is noticeable that in general the trees recover rapidly after a period of aridity and then fall off more slowly as another dry time approaches. This is important as an indication that climatic changes from dry to moist take place rapidly, while those in the reverse direction are slow. It bears also on another point. It may be suggested that the inequalities in the curve are due to accidents such as fires. In the first place, this is not probable, since the 451 trees were located in four different areas with a distance of 60 miles between the extremes and with high mountains and deep valleys intervening. The rapid rise and gradual fall of the curves, however, disproves any such supposition. An accident, such as a fire or anything else, would suddenly cause the trees to grow slowly, after which they would gradually recover, whereas the actual case is the reverse of this.

In figure 2 I have added a dotted line. This is the approximate curve of climatic pulsations in Asia as given in "Palestine and its Transformation." The two curves disagree in certain places, but on the whole they are in harmony. The disagreements may be due to the absence of data in compiling the Asiatic curve; for instance, between 1200 and 1000 B. C. I had no data whatever, and hence merely drew a straight line. In other cases the fact that indications of aridity happened to be especially well preserved at a certain time, such as the seventh century of our era, may have caused me to carry the Asiatic curve lower than was justifiable. It should be noted, however, that in the fully corrected sequoia curve the lowest point of all in the seventh century A. D. falls at the same time as the lowest point in the Asiatic curve, a significant agreement. Moreover, the longest almost continuous decline anywhere apparent in the California curve is from the time of Christ to the middle of the seventh century. The greatest disagreement between the two curves is found about 300 A. D. Whether there actually was disagreement at that time, or whether I have made a mistake in the Asiatic curve, I shall not here attempt to discuss. In general it may be said that the three noticeable depressions in the Asiatic curve, namely, 300, 650, and 1200 A. D., are possibly all exaggerated because special events due apparently to increasing aridity happened to culminate at those particular epochs.

In spite of certain distinct disagreements, the most noticeable fact about the curves is their agreement. Take the epoch centering

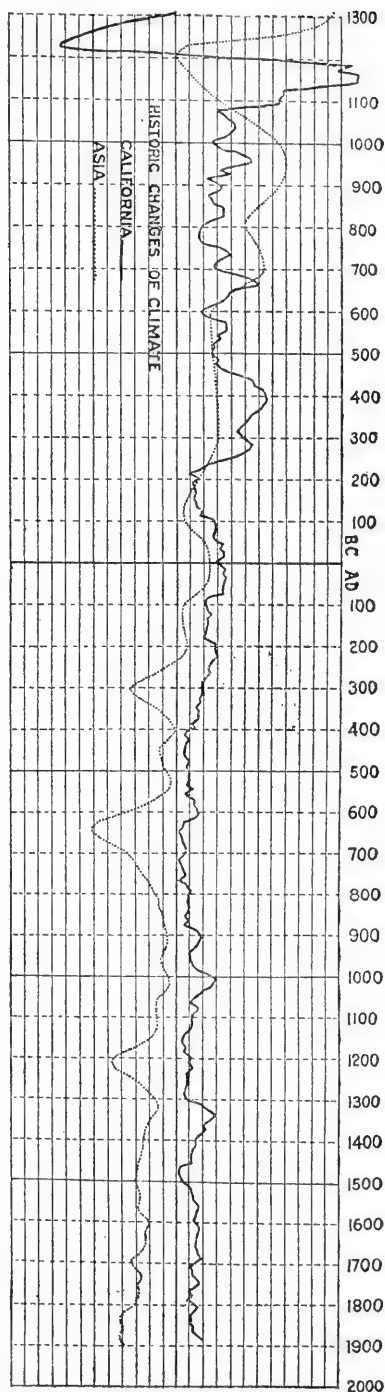

FIG. 2.—Curve of growth of the *Sequoia washingtoniana* of California (solid line), and changes of climate in Asia (dotted line).

at the time of Christ, for example, or those which center 1000 or 1600 A. D. The agreement is so close that it can scarcely be a matter of chance. Further discussion of the subject must be deferred for the present. We can here merely sum up the main conclusions. The study of the trees of New Mexico and California in the first place seems to confirm the conclusions derived from the ruins and physiographic evidences found in the drier parts of North America. It thus shows that the methods upon which those conclusions are based are sound, and that the results derived from such methods whether in America or Asia are valid. In the second place, the trees confirm the theory of pulsatory climatic changes. They apparently show that the climate of the earth is subject to pulsations having a period of centuries. In the third place, the rate of growth of the trees indicates that in the distant historic past the moist epochs were on the whole moister than the similar epochs in more recent times. Fourth and last, we are led to conclude that the *main* climatic changes of America are synchronous with those of Asia and are of the same kind. This does not mean that changes in tropical countries are like those in the Temperate Zone. It does indicate, however, that in the temperate continental regions of the world, in both the eastern and western hemispheres, periods of exceptional aridity or of exceptional moisture have occurred at approximately the same time, and have sometimes lasted for centuries. Hitherto this point has been open to question, and therefore historians and other students of man have been skeptical as to the possibility that climatic changes could have been of sufficient importance profoundly to influence history. With the fuller application of the methods here discussed, we shall soon be able to determine the exact nature and degree of climatic changes throughout historic time, and then we shall have the basis for a true appreciation of their effect upon history.

THE SURVIVAL OF ORGANS AND THE "CULTURE" OF LIVING TISSUES.¹

By R. LEGENDRE,

Preparator of Zoology, National Museum of Natural History, Paris.

[With 4 plates.]

The Nobel prize in medicine for 1912 has just been awarded to Dr. Alexis Carrel, a Frenchman, of Lyon, now employed at the Rockefeller Institute of New York, for his entire work relating to the suture of vessels and the transplantation of organs.

The remarkable results obtained in these fields by various experimenters, of whom Carrel is most widely known, and also the wonderful applications made of them by certain surgeons have already been published in *La Nature* (No. 1966, Jan. 28, 1911).

We will not repeat what has been said concerning these researches, but we will take the occasion of the awarding of the Nobel prize to mention other biological studies in which Dr. Carrel has been engaged.

The journals have frequently spoken lately of "cultures" of tissues detached from the organism to which they belonged; and some of them, exaggerating the results already obtained, have stated that it is now possible to make living tissues grow and increase when so detached.

Having given these subjects much study I wish to state here what has already been done and what we may hope to accomplish.

As a matter of fact we do not yet know how to construct living cells; the forms obtained with mineral substances by Errera, Stéphane Leduc, and others, have only a remote resemblance to those of life; neither do we know how to prevent death; but yet it is interesting to know that it is possible to prolong for some time the life of organs, tissues, and cells after they have been removed from the organism.

The idea of preserving the life of greater or lesser parts of an organism occurred at about the same time to a number of persons,

¹ Translated by permission from *La Nature*, Paris, No. 2058, Nov. 2, 1912.

and though the ends in view have been quite different the investigations have led to essentially similar results. The surgeons, who for a long time have transplanted various organs and grafted different tissues, bits of skin among others, have sought to prolong the period during which the grafts may be preserved alive from the time they are taken from the parent individual until they are implanted either

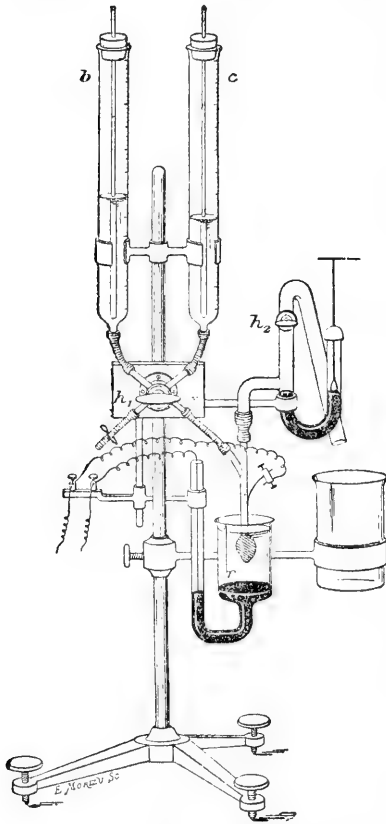

FIG. 1.—The apparatus of Kronecker for the study of the heart of the frog when removed from the animal. *b*, *c*, Tubes containing defibrinated blood; *h*, cock for distribution of the same; *r*, cup containing the isolated heart fixed upon the end of a two-way canula; *h*₂, cock upon an overflow tube communicating with a float manometer.

upon the same subject or upon another. The physiologists have attempted to isolate certain organs and preserve them alive for some time in order to simplify their experiments by suppressing the complex action of the nervous system and of glands which often render difficult a proper interpretation of the experiments. The cytologists have tried to preserve cells alive outside the organism in more simple and well defined conditions. These various efforts have already given, as we shall see, very excellent results both as regards the theoretical knowledge of vital phenomena and for the practice of surgery.

It has been possible to preserve for more or less time many organs in a living condition when detached from the organism. The organ first tried and which has been most frequently and completely investigated is the heart. This is because of its resistance to any arrest of the circulation and also because its survival is easily shown by its contractility. In man the heart has been seen to beat spontaneously and completely 25 minutes after a legal decapitation (Renard and Loye, 1887), and by massage of the organ its beating may be restored after it has been arrested for 40 minutes (Rehn, 1909). The heart of the dog has been known to beat 96 hours after death, that of the tortoise for 8 days, and Burrows (1911) observed the heart of an embryo chick to beat for 3 days after its removal.

By irrigation of the heart and especially of its coronary vessels the period of survival may be much prolonged.

The first experiments with artificial circulation in the isolated heart were made in Ludwig's laboratory and were improved by Kronecker (fig. 1), but they were limited to the frog and the inferior vertebrates. The observation made by Arnaud (1891) of the heart of the rabbit, that of Hedon and Gilis (1892) on the heart of a criminal showed that that organ recommences to beat when defibrinated blood is injected under pressure into the coronary arteries, and this led Langendorff (1895) to effect the survival of the heart of mammals by means of artificial coronary circulation. Locke (1901) substituted for defibrinated blood an artificial serum without globules. Since then experiments on the survival of the heart

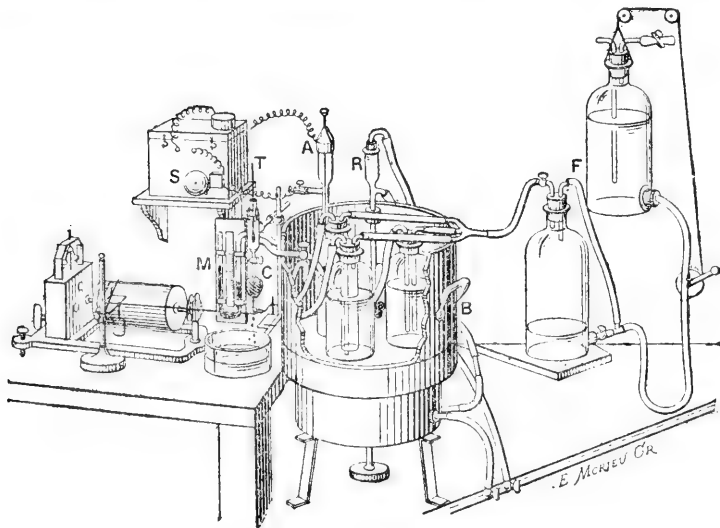

FIG. 2.—The apparatus of Pachon for the study of the survival of the isolated heart of mammals. T, reservoir of oxygen under pressure; B, water bath assuring a constant temperature; R, A, S, regulators of the temperature; T, M, thermometer and manometer for the serum at its entrance into the isolated heart C; at the left a cylinder for registering the contractions of the heart.

have multiplied and become classic. Artificial circulation has kept the heart of man contracting normally for 20 hours (Kuliabko, 1902), that of the monkey for 54 hours (Hering, 1903), that of the rabbit for 5 days (Kuliabko, 1902), etc. It has also enabled us to study the influence upon the heart of physical factors, such as temperature, isotonia; chemical factors, such as various salts and the different ions; and even complex pharmaceutical products. Kuliabko (1902) was even able to note contractions in the heart of a rabbit that had been kept in cold storage for 18 hours, and in the heart of a cat similarly kept after 24 hours.

The other muscular organs have naturally been investigated in a manner analogous to that which has been used for the heart;

and for the same reason, because it can be readily seen whether or not they are alive.

The striated muscles survive for quite a long time after removal, especially if they are preserved at the temperature of the body and care is taken to prevent their drying. By this method many investigations have been made of muscular contractions in isolated muscles. Landois has noted that the muscles of man may be made to contract two hours and a half after removal, those of the frog and the tortoise 10 days after. Recently Burrows (1911) has noted a slight increase in the myotomes of the embryo chick after they have been kept for 2 to 6 days in coagulated plasma.

The organs supplied with smooth muscular fibers also survive, at least so far as regards their muscular coat; the small intestine shows peristaltic movements a long time after the death of the animal; Cohnheim, Magnus (1904), and others have prolonged the duration of this action by bathing the intestine in defibrinated blood. Recently, Carnot and Glenard (1912) have studied digestion and the action of purgatives in the isolated small intestine; Hedon and Fleig have succeeded in obtaining contractions of the intestine 7 days after having placed it in cold storage. The stomach, preserved by Hofmeister and Schutz at a temperature of 37° C., in a moist chamber, showed regular periodic movements proceeding from the cardia to the pylorus. The large intestine, including the rectum, exhibited, according to Hedon and Fleig (1904), spontaneous rhythmic contractions after removal. Fleig (1910) was able to excite electrically the œsophagus of the rabbit after it had been kept in cold storage for 12 days, the pharynx and œsophagus of the frog after 17 days.

The ureter seems to be quite as resistant. Miss Stern (1903) noted its contractions in a solution of chloride of sodium; Hedon and Fleig (1904) in an artificial serum.

The uterus shows similar properties (Hedon and Fleig, 1904). Kurdinowski (1904) was able to preserve the life of that organ when detached from the body for 49 hours and 40 minutes, and succeeded twice in studying the mechanism of labor in it when isolated.

Nonmuscular organs may also survive a removal from the parent organism, but the proofs of their survival are more difficult to establish because of the absence of movements. Carrel (1906) grafted fragments of vessels that had been in cold storage for several days upon the course of a vessel of a living animal of the same species; in 1907 he grafted upon the abdominal aorta of a cat a segment of the jugular vein of a dog removed 7 days previously, also a segment of the carotid of a dog removed 20 days before; the circulation was reestablished normally; these experiments have, however, been criticized by Fleig, who thinks that the grafted fragments were dead and served merely as supports and directors for the regeneration of the

vessels upon which they were set. In 1909 Carrel removed the left kidney from a bitch, kept it out of the body for 50 minutes, and then replaced it; the extirpation of the other kidney did not cause the death of the animal, which remained for more than a year normal and in good health, thus proving the success of the graft. In 1910 Carrel succeeded with similar experiments on the spleen.

These last examples are quite too few to enable us to arrive at a positive conclusion. Scattered as they are, not yet repeated and checked by all the technical methods at our disposal, they furnish only an indication of the possibility of the survival of organs as delicate as the spleen and kidneys for some time after removal from the body.

Even the nervous system is not exempt from preservation outside of the organism. As early as 1885 Laborde showed that in a human head severed from the body artificial circulation commenced 20 minutes after the execution produced no movement, yet the cerebral cortex remained excitable by electricity for 50 minutes; in the case of another criminal cerebral excitability was preserved for 30 minutes without transfusion. In the dog, Loye observed the excitability to persist for 7 minutes; Brown-Séguard (1858) saw after 10 minutes spontaneous movements of the eyes and the face; Guthrie, Pike, and Stewart (1906) with artificial circulation observed reflex movements for 19 minutes, the corneal reflex for 27 minutes, respiratory movements for half an hour. In fishes Kuliabko preserved for several hours the activity of the nerve centers by circulating an artificial serum through the head; he observed that the centers of the cerebral cortex lose their excitability more quickly than those of the spinal cord; in the latter the respiratory center and that for the regulation of the heart show different degrees of vitality.

In frogs it has been known¹ since the time of Galvani (1781) that the hind legs of a skinned frog, connected by means of the sciatic nerves alone to a segment of the spinal cord, remained excitable for some hours. This very important experiment has been repeated many times and has led to very significant results: The discovery of the electro-motor property of muscular tissue and electric variation during its contraction (Matteucci, Du Bois-Reymond, 1837-1843). After that, Tyschetzky (1870), Biedermann (1883), Gad (1884), Ushinsky (1885) preserved for some time the spinal cords of frogs entirely removed from the body, in order to study in them the effects of electric currents. Finally, quite recently (1907-1911), Baglioni and his assistants have succeeded in isolating the entire cerebro-spinal axis of the toad (fig. 3, pl. 1) and preserving it alive for 31 hours and 35 minutes in artificial serum.

¹ Swammerdam had already in the seventeenth century isolated a frog's foot with its attached sciatic nerve.

Taken altogether these experiments show that the greater part, if not all, of the bodily organs are able to survive for more or less time after removal from the organism when favorable conditions are furnished. There is no doubt but what the observed times of survival may be considerably prolonged when we have a better knowledge of the serums that are most favorable and the physical and chemical conditions that are most advantageous.

If we can preserve the organs, we may expect to also keep alive the tissues and cells of which they are composed. Biologists have studied these problems, too, and have also obtained in this department some very interesting results.

The cells which live naturally isolated in the organism, such as the corpuscles of the blood and spermatozoa, were the first studied. The red corpuscles of the blood of the triton have been preserved alive in tubes for 8, 10, 12, and even 15 days and have multiplied by division (Jolly, 1903); the red corpuscles of the rabbit preserved for 12 days in cold storage (Fleig, 1910), then injected into the same animal or into an animal of the same species, produced in the urine no manifestation of globular destruction, which Fleig considers as a proof that the corpuscles were living. The white corpuscles, whose vitality is clearly shown by their amoeboid movements, have been preserved *in vitro* for 12 days (Cardile), 21 days (Recklinghausen), 25 days (Ranvier, 1895); those of the triton are still capable of movement after 4½ months of cold storage and those of the frog after 1 year (Jolly, 1910) (fig. 4, pl. 1).

Human spermatozoa have been observed by Fleig (1909) to be actively motile in semen after being preserved for two or three days at a temperature of 15°. Semen kept in cold storage for eight days and then rewarmed has also shown motile spermatozoa. Ywanoff (1907) was able to preserve in a suitable medium the spermatozoa of a bull at a temperature of 2°, with active movements for 12 days, and at the end of 24 hours obtained artificial fecundations.

The organized tissues have likewise been the object of numerous experiments. The ciliated epithelium of the larynx, trachea, and bronchi of mammals still vibrates 24 hours after death; Grawitz (1897) observed ciliary movements in the nasal epithelium of man 9 days after its removal during a surgical operation. Wentcher (1894) was able to successfully graft a fragment of human skin 50 hours after its removal. Ljungren (1898) succeeded in doing the same after it had survived for a month. Grawitz (1897) was able to graft a fragment of the cornea of a rabbit removed 12 days previously. Pruss (1900) kept a fragment of cartilage alive for 30 days.

Since 1910 experiments on the survival of tissues have multiplied and at the same time more knowledge has been obtained concerning the conditions most favorable to survival and the microscopical

appearances of the tissues so preserved. In 1910 Harrison, having placed fragments of an embryo frog in a drop of coagulated lymph taken from an adult, saw them continue their development for several weeks, the muscles and the epithelium differentiating, the nervous rudiments sending out into the lymph filaments similar to nerve fibers (fig. 5, pls. 2, 3). Since 1910, with the aid of Dr. Minot, I have succeeded in preserving alive the nerve cells of the spinal ganglia of adult dogs and rabbits by placing them in defibrinated blood of the same animal, through which there bubbled a current of oxygen. At zero and perhaps better at 15° - 20° , the structure of the cells and their colorable substance is preserved without notable change for at least four days; moreover, when the temperature is raised again to 39° , certain of the cells give a proof of their survival by forming new prolongations, often of a monstrous character. At 39° some of the ganglion cells which have been preserved rapidly lose their colorability and then their structure breaks up, but a certain number of the others form numerous outgrowths extremely varied in appearance. We have besides studied the influence of isotony, of agitation, and of oxygenation, and these experiments have enabled me to ascertain the best physical conditions required for the survival of nervous tissue. In 1910, Burrows, employing the technique of Harrison, obtained results similar to his with fragments of embryonic chickens. Since 1910 Carrel and Burrows applied the same method to what they call the "culture" of the tissues of the adult dog and rabbit; they have thus preserved and even multiplied cells of cartilage, of the thyroid, the kidney, the bone marrow, the spleen, of cancer, etc. Perhaps Carrel and his collaborators may be criticized for calling "culture" that which is merely a survival and for not having always distinguished between the phenomena of degeneration and those of real survival, but there still remains in their work a great element of real interest.

In conclusion, I will cite a beautiful series of experiments, conducted by Magitot in 1911, which give a good idea of what practical results may be expected to follow from these researches. Magitot preserved for 14 and even 25 days fragments of the cornea of the rabbit and was able after that to successfully graft them upon the eye of another animal. Soon after he applied these results to man; after an enucleation of the eyeball he removed the eye and preserved it in serum; seven days afterwards another man having presented himself whose cornea had been injured and rendered opaque by a jet of quicklime, Magitot cut an aperture in his cornea and grafted there a fragment of the cornea which he had preserved, and the graft succeeded perfectly, the man having, after some time, sufficient vision to be able to go about.

Such are, too briefly summarized, the experiments which have been made up to the present time. We can readily imagine the practical consequences which we may very shortly hope to derive from them, and the wonderful applications of them which will follow in the domain of surgery. Without going so far as the dream of Dr. Moreau depicted by Wells, since grafts do not succeed between animals of different species, we may hope that soon, in many cases, the replacing of organs will be no longer impossible, but even easy, thanks to methods of conservation and survival which will enable us to have always at hand materials for exchange.

The dream of to-day may be reality to-morrow.

There are also other consequences which will follow from these researches. I hope that they will permit us to study the physical and chemical factors of life under much simpler conditions than heretofore, and it is toward this end that I am directing my researches. They will enable us to approach much nearer the solution of the old insoluble problem of life and death. What indeed is the death of an organism all of whose parts may yet survive for some time?

These, then, are the researches made in this domain, fecund from every point of view, and the great increase in the number of experts who are taking them up, while it is a proof of their interest, gives hope for their rapid progress.

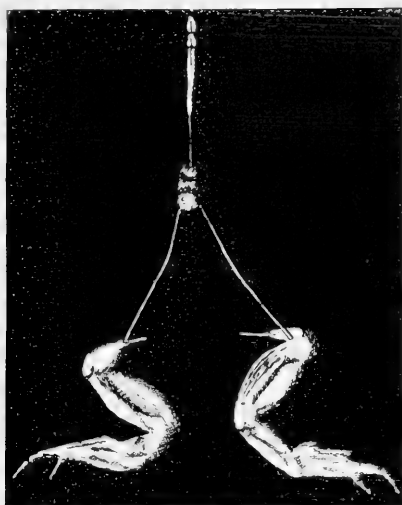

FIG. 3.—ENTIRE CEREBRO-SPINAL AXIS OF THE TOAD, ISOLATED AND KEPT ALIVE FOR 31 HOURS 35 MINUTES. (BAGLIONI, 1909.)

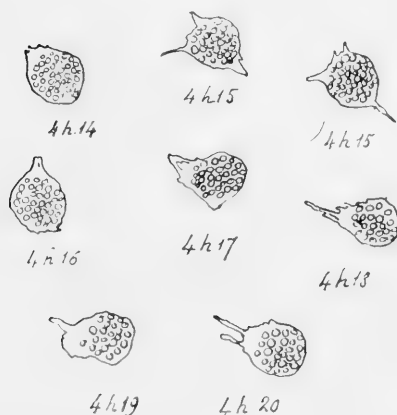

FIG. 4.—AMOEBOID MOVEMENTS OF A WHITE BLOOD CORPUSCLE OF A FROG AFTER BEING KEPT ALIVE FOR 10 MONTHS. (JOLLY, 1910.)



FIG. 5.—GROWTH OF NERVE FIBERS IN A FRAGMENT OF AN EMBRYONIC FROG (HARRISON, 1910.) (SEE ALSO PL. 3.)

A portion of the spinal cord is growing in coagulated lymph from fibers which are increasing more and more in length.

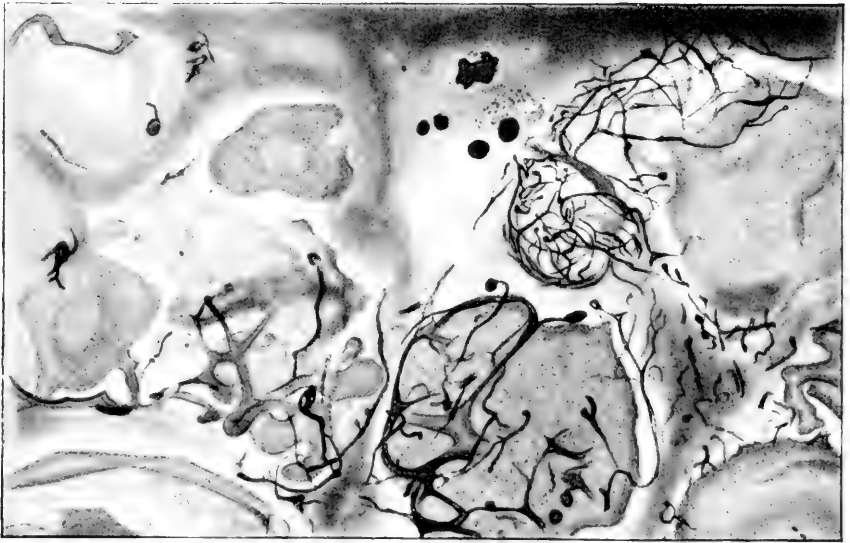

FIG. 6.—PERIPHERIC PART OF A SPINAL GANGLION OF AN ADULT DOG, KEPT ALIVE FOR 27 HOURS; THE NERVE CELLS HAVE GROWN UP MANY NEW EXTENSIONS. (LEGENDE AND MINOT, 1911.)



FIG. 7.—ONE CELL OF AN ADULT DOG'S GANGLION, SURROUNDED WITH NUMEROUS NEW EXTENSIONS. (LEGENDE AND MINOT 1911.)



FIG. 8.—FRAGMENT OF THE NERVOUS SYSTEM OF THE EMBRYO OF A CHICKEN HAVING PUSHED SOME NERVE FIBERS INTO THE SURROUNDING PLASMA.

ADAPTATION AND INHERITANCE IN THE LIGHT OF MODERN EXPERIMENTAL INVESTIGATION.¹

By PAUL KAMMERER, Vienna.

[With 8 plates.]

At the opening of the eighth session of the International Zoölogical Congress at Graz, in August, 1910, the Graz Tageblatt contained a leading article by Prof. Franz von Wagner, of the University of Graz, the introduction of which ended as follows:

Zoology has expanded tremendously since the publication of Darwin's works, both in breadth and profoundness, and the frail seedling of his day has developed into a sturdy tree with many branches. None of the newer fields of the scientific study of animals illustrate this more convincingly than the steady progress which has been made in recent years in Experimental Zoology. This, as a special study, in the systematic development of methods, has attacked not only the problem of the development of organic form, but has even attempted to solve the riddle of life, striving at the same time to impress upon biology, as far as possible, the stamp of an exact science. It is certainly not through chance that this phase of modern zoology will receive a great amount of attention in the congress at Graz.

During the sessions of the congress, many other individuals expressed similar opinions, among whom a goodly number presented papers or took part in the discussions. Of these there come to mind men of such note as Appelof, Gadow, and Plate, who emphasized the importance and absolute necessity of basic experimentation. Indeed, we dare not any longer be satisfied simply to observe final facts in nature as they present themselves completed to the observer and merely incorporate this mass of isolated data in a mountain of knowledge, but we must seek the causes which underlie these phenomena. This can not be accomplished by mere descriptions of these final products and a comparison of them, but by experimental analysis. In this, the factors which appear to us to be responsible for a definite phenomenon are isolated and allowed to react, or they are completely suppressed; that is, the conditions found in nature are artificially changed in many ways. These are the same methods which have always been applied in chemistry and physics, the so-

¹ A lecture delivered Dec. 14, 1910, before the Scientific Society of Berlin. Translated by permission from Himmel und Erde, Berlin, June, 1911, pp. 385-395; July, 443-457.

called natural sciences, which owe to this method their most wonderful advancement. It was very late, comparatively speaking, when the thought obtained that similar results might be expected in natural history, and a few decades of this opinion have led to great results.

I intend to-day to cover as far as possible, with many concrete examples, the facts which I brought before you in abstract form. We would, however, gain very little if I should attempt within the time at my disposal to touch upon all the branches of natural history to which experimentation has been applied. I therefore prefer to dwell upon only two leading questions viewed from the experimental viewpoint, and shall consider these in considerable detail. These are the old Lamarckian and Darwinian slogans "Adaptation and inheritance." In their reactions, which we wish especially to emphasize, both of them become united in a single world-stirring problem. Pure description and comparison could not give them their full meaning, they remained but empty terms, slogans, through which one was supposed to be able to explain everything, but which in truth possessed no explanation at all, and were therefore discredited, especially through the critical examination to which they were subjected by the genial August Weismann. The reaction between adaptation and inheritance, or, differently stated, the transmission of characters acquired through adaptation, the emphasizing of these characters, and the evolutionary effect produced thereby upon the parent stem of the organism, had scarcely any followers for a long time. It required and will require many tedious and prolonged experiments before that almost abandoned study will be revived in improved form, stronger and better entitled to consideration. We shall therefore, among all the problems of evolution, here confine our attention to adaptation and inheritance, but we shall constantly be in touch with that other large problem, that of reproduction. In this we shall give equal consideration to asexual reproduction by simple fission (*Paramaecium*)¹ or budding (worm *Aeolosoma*), the unisexual reproduction by parthenogenetic eggs (lower crustaceans), or close fertilization (higher plants), and even the bisexual reproduction through the union of ovum and spermatozoa of two distinct individuals, a male and a female (higher animals).

On account of the manifold adaptations of which we shall learn, the following problems of modern biology will be touched upon, namely, Embryogenesis, or germ development; Regeneration, or repeated growth (worm *Lumbriculus*); Involution or Concentration (worm *Aeolosoma*); Transplantation, or grafting (salamander, chicken, rabbit, guinea pig); Mendelian law (midwife toad); Intravitem staining, or coloring of living tissues (moth *Tineola*); Immunity, or

¹ The names of the organisms which furnish data for the problems of this lecture are added in parentheses to make it easier to locate them in the proper place.

resistance against bacterial or other poisons (chicken, mouse, rabbit, man).

As is well known, many of the lower plants and animals multiply by simple fission, and the resulting elements attain in course of time the form and size of the parent. Or they may multiply by having a bud developing on any part of the body, which in time assumes the form of the entire parent or animal upon which it is developed, usually separating from the parent to lead an independent existence. Multiplication of this type by fission or budding may occasionally occur in many higher animals or plants, especially so when they have been injured by mechanical separation, and each part possesses the power to regenerate the lost portion. In this asexual reproduction we realize best that the offspring resembles the parent, or in other words that the peculiarities of the parent have been transmitted to the offspring. We even accept this when the parents have acquired new characters in their individual existence, for why should the pieces possess different characters than the material from which they sprang unchanged?

Still, it is not necessarily true that newly acquired characters must appear in the progeny. Metalnikow fed Protozoa with grains of carmine and India ink. Although they devoured those indigestible particles at first, they nevertheless gradually learned to push them aside and to avoid them. But as soon as fission had rendered the organism into two daughter cells, these seemed to be ignorant of the indigestibility of the carmine or India ink, for they devoured both greedily.

Leaving out of consideration the constituents or peculiarities of those elementary building blocks of life, the so-called cells, this simple experiment, recently challenged, it is true, by Schäfer, demonstrates the following fundamental facts: That even in reproduction by simple fission germplasm, which contains the material for the next generation, must be distinguished from the purely individual somaplasm, which perishes with the single example. The bodily peculiarities, be they young or old, must be impressed upon the germplasm of the next generation in order that they may not become lost but may continue. With this, then, we state that asexual reproduction does not differ as far as their principles is concerned, from sexual reproduction. If we find transmission of acquired characters in organisms which multiply asexually, we may therefore attribute to them the same significance as in those which reproduce by the sexual methods.

Jennings found curiously misshaped examples of a Protozoan (the slipper animalcula *Paramecium*, fig. 1),¹ in densely populated cultures, where there was a lack of food.

Jennings transplanted one of these from the poor medium into one presenting favorable conditions and followed the progeny through 22

¹ The figures are reproduced on plates 1 to 8.

generations. In the resulting products of this repeated division, one part was always normal while the other inherited a hornlike process. There was considerable difference in the form and size of this process, as well as in its position; at times it appeared anteriorly, then in the middle or posteriorly, so that the progeny would obtain this process from the anterior or posterior extremity of the parent. From the nineteenth generation on, the process remained on the anterior end, assuming a peculiar function; the animal used it as a gliding shoe and moved upon it on the walls and bottom of the container.

While Jennings produced this horn like process through lack of food, McClendon produced the same by means of a centrifugal or rapid whirling of the Protozoan. In the first following fission the daughter cells each possessed a horn. Later, as in Jennings's experiments, only one of the daughter cells was provided with a horn, the second one, being normal, gave rise to normal progeny only.

Another new character, on the other hand, also resulting from insufficient food in cultures, made by Jennings and McClendon, could, in spite of transfer into a rich food medium, be transmitted even by apparently normal examples, namely, the tendency to incomplete fission (fig. 1*b*), in which the daughter individuals remain attached, forming chains. In this manner long wormlike colonies arise, from which now and then an individual becomes separated; this, however, produces chains again, directly, or these are formed by its progeny.

Similar fusion was produced by Stolc in a worm, *Aeolosoma hemprichi* (fig. 2), which multiplies by budding—that is, asexually, by the use of old culture water containing scant nourishment. In this case the phenomena is not transmitted to the progeny, again a reminder that asexual reproduction does not always embrace a complete transmission of all the characters, whether inherited or acquired. This worm normally has a smooth head and six pairs of bundles of setæ, on the sides of the body (1-V1). In the reproduction (fig. 2*T*), a new head and body with six pairs of bundles of bristles (setæ) are budded at the posterior end and later detached. But when subjected to starvation the bud fuses with the main stem into a single individual (fig. 2*b*), which now possesses more bundles (setæ) than the normal worm. If this individual be now placed in a fresh food medium and begins to bud there (b*T*), it will produce from the very beginning only individuals with six pairs of bundles of setæ. Likewise, the offspring are provided with the normal number of setæ, when budded from a parent which, instead of having an increased number of setæ produced by hunger, has a lesser number produced by mechanical separation (fig. 2*a*).

Another Polychæte fresh-water worm (*Lumbriculus*, fig. 3), possesses like the rest of the worms, the ability to develop into new worms, from pieces cut from the body. However, according to Morgulis, not all parts of the body are able to accomplish this. If five segments are taken from the anterior region of the body (*A*), these will yield exactly double as many caudal segments as five segments taken from the posterior portion (*B*) are able to yield. After 14 days the new tails, *a*, *b*, are detached and these now produce a new head anteriorly; *a*₁, *b*₁, so that complete worms, although they are somewhat dwarfed, are again produced. These dwarfed worms are again robbed of their tails and must sprout another last set of tails. But one of these forms (*B*), produces only about half as many tail segments as the other (*A*). This is the result of the stronger growth power of the anterior end of the original worm, while the other is the result of the lesser growth power of the posterior segments of the original worm. The peculiar abilities of these parts have been retained in spite of the fact that the pieces were finally subjected to the same process—that is, to produce caudal segments of the head end. Differently stated, the anterior end, derived from the posterior end, has acquired the character of lesser development and transmits this to its progeny even asexually.

Recently the question of acquired characters has been diligently studied in small crustaceans. Their reproduction is a sexual one, in so far as it does not take place through budding or fission, but through the production of true germ cells. But it does not agree with our idea of orthodox sexual reproduction, since many generations may pass without the appearance of males. The reproductive products at such times are purely feminine—that is, eggs which develop without having been fertilized by a male cell, the spermatozoan. We may distinguish this form of reproduction from sexual reproduction, in the restricted sense, or bisexual reproduction, as unisexual or parthenogenetic reproduction. The investigators who have been engaged in the study of these lower crustaceans, and have in part or wholly bred them parthenogenetically from unfertilized eggs, have avoided the criticism which has often been expressed where animals were produced by the bisexual method of reproduction, namely, that the changes obtained in these animals, the product of bisexual reproduction, were not due to an adaptation to the environment, but to the crossing of races, in which certain characters, which had up to this time been hidden in the germplasm, had come to the surface. To the breeding experiments, in which the above criticism can not apply, belongs, among others of recent date, also one of the most important older works, the experiments of Schmankevitsh (1875). This deals with the effect produced upon the form of the saline crustacean (*Artemia salina*, fig. 4, 1), by varying the salinity

of the medium in which it lives. These experiments have been more than once subjected to scathing criticism, which is undeserved, as can be demonstrated by an examination of the original sources. By increasing the salinity, *Artemia salina* passes in several generations nearer and nearer, and eventually completely into the related species *Artemia Mühlhausenii*. On the other hand, by reducing the salinity, it assumes a number of characters which are peculiar to a fresh-water species, the gillfoot (*Branchipus*, fig. 4, 2). This is most apparent in the gradually emphasized development of the appendages and the ciliation pending from them. These hairs are at first wanting (1*a*); then they appear scattered only on the tip of the terminal caudal segment (1*b-d*); but finally they surround the entire border as a fringe, having attained an equal length at the same time (1*e-f*).

Among the many experiments which have been made recently upon the lower crustaceans, those conducted by Woltereck upon the long-spined water flea (*Daphnia longispina*) may be mentioned. In the Untersee, near Lunz (lower Austria), lives a race in which the head helmet is low. By feeding these well, in the basin of a hothouse, Woltereck saw them develop into high-helmed forms. If one transplants these artificially produced high-helmed races into their former habitat within two years, then all their progeny returns to the low-helmed form. Later offspring, however, remain more high-helmed than the original stock, even when they are returned to normal conditions. Ostwald obtained a similar picture without inheritance in an allied genus, *Hyalodaphnia* (fig. 5). He placed high-helmed females (1*aa*₁), which contained eggs in the broodpouch that were undergoing development, in cold water (0° to 5° C.) and obtained (1*bb*₁) short-helmed young. Moderately high-helmed gravid females (11*aa*), placed in moderately warm water (8° to 18° C.), yielded moderately high-helmed young (11*bb*₁), while short-helmed females (111*aa*₁), placed in warm water (20° C.), produced high-helmed young (111*bb*₁).

I shall now cite a series of examples in which the transmission of an intentionally produced variation in higher plants and animals has been demonstrated. The offspring necessary for these demonstrations were produced by the usual bisexual methods—that is, through the fertilization of an ovum; both parents may have been subjected to the change-producing environment, or only one of the parents may have been changed, the other being normal. The nature of the experimental variation was as variable as the organism in which it was produced—small and large butterflies, flies, beetles, water and land salamanders, frogs, toads, lizards, chickens, dogs, guinea pigs, rabbits, rats, and mice. Various kinds of grain and higher flowering plants have yielded positive answers in our experiments: to say

nothing of the lower plants or animals, the bacteria, yeast, and smut fungi, the algæ, and flagellates. The characters which could be changed or newly formed in the higher organisms include size, form, color, developmental stages, habits of locomotion, food, reproduction, and nidification. Of all these groups of acquired changes, I can give only one or two examples. In many instances several of the mentioned groups of variations are combined in a single case, so that in spite of all the necessary concentration, quite a comprehensive survey of the field will result.

If we begin with a case which in a sense is not one of true transmission, for in this it is a foreign body, not a part of the animal which is transmitted by the parent to the offspring. Sitowski fed the caterpillars of a moth (*Tineola biselliella*) with an aniline dye, "Sudan red No. 111." The colored caterpillar developed into a complete moth, and these moth deposited colored eggs (fig. 6B), from which colored caterpillars emerged; normally the eggs and caterpillars are white (fig. 6b). Similar results were obtained by Gage with guinea pigs and by Riddle with chickens. These experiments are of interest because they show how easily the germ plasma is reached. In this case it was accomplished by an external chemical factor through the roundabout way of the somaplasm. In the body the fats are especially colored by the sudan red and in the egg the fatty substances which are attacked by it. We may consider the coloring of the living tissue (vital staining) comparable to the immigration of green algæ into the egg of the green fresh-water polyp (*Hydra viridis*). The green color of this polyp is due to microscopic low plants (algæ), which live in the cells of the polyp and even infest the maturing egg. M. Nussbaum has called this a transmission of an acquired character, for it stands to reason that this association with the algæ must have been acquired somewhere.

If we consider size, then we find a ready example which also embraces changes in color and food habit—the caterpillar of the gypsy moth *Lymantria s. Oeneria dispar*—in which the males are strongly differentiated from the females. These caterpillars feed naturally upon the leaves of the oak and fruit trees. Pictet fed them upon the hard leaves of the walnut. At first they fed poorly, but the following generation fed upon the nut leaves without hesitation. The resulting generation of moth are dwarfed and paler in both sexes. Traces of this are still recognizable after two generations, even when they have been returned to normal food. On the other hand, if one feeds two consecutive generations with the abnormal food, they return to the normal form, evidently because the caterpillar has learned to digest the strange food as well as that to which it was formerly accustomed. Feeding with the tender *Esparette* produces giant forms and saturated color, as well as gray, instead of yellow, breast

hairs. If the first generation is fed with walnut leaves, the second with oak leaves, and the third with *Esparsette*, then the characters of all three food-response forms are united in the last generation.

Schröder likewise obtained in the small willow-leaf beetle *Phratora vitellinae* (fig. 7, lower right) an inheritable food change, but which at the same time forced the animals affected to a change in locomotion combined with a change in reproduction. The larvæ of this beetle, usually fed upon the leaves of a smooth species of willow (fig. 7A), were unable to feed upon the surface and were forced to mine in the tissue of the leaf. When both willows were at the disposal of the resulting beetles (*B, b; C, c*, etc.), then these fastened their eggs, increasingly with each generation from the very beginning, freely to the new food plant.

Another experiment by Schröder affected the nidification of a small moth (*Gracilaria stigmatella*). The caterpillars of this moth are accustomed to roll in the tips of the willow leaves, which serve it as an abode and food. They are prevented from doing this when the tips of the leaves are cut off and are thus forced to roll up one or both edges of the leaf. The progeny of the third generation do this in part spontaneously, even when the leaves have not been mutilated.

Plants, too, yield positive results when they are examined for transmission of acquired characters. I will have to pass over the many examples which have been noted in the asexually reproduced spore plants, bacteria, yeasts, smuts, and algæ. I can only mention those produced sexually, usually by self-fertilization of the bisexual flowers.

Klebs grew Gamander-Ehrenpreis (*Veronica chamaedrys*), a species of quite constant form under especially favorable food conditions, in moist, well fertilized beds. If the feeding sap stream was driven into the flowering stalk by the cutting away of the main stem and any new lateral shoots which might develop, then these changed quite rapidly into leaf shoots. No new flowers with their accompanying bract were added, but in their place only broad coarsely serrate green leaves. The disposition to this leafy efflorescence is increased in the seedlings of such changed plants, even without mutilation in the free bed, and, under food conditions which were little more favorable than those in which the wild plants grew, several seedlings showed a change of their unbranched determinate flower stalks into branched indeterminate leaf shoots.

Recent experiments were made by Klebs upon the short-leaved live-for-ever (*Sempervivum acuminatum*). This was carefully grown and the development of the flower stalk watched; then the flowers were examined, and, if found normal, the whole flower stalk was cut off. New flower stalks now developed of a different form, with changes in the number and position of the flowers, pistils, and sta-

mens. The corolla was at times completely absent and the stamens were more or less changed into petals and whole flowers appeared as leaf rosettes. All these changes appeared at one time in one and the same plant. But never more than one of the several changes appeared in a single individual resulting from the close fertilized seeds of this plant; that is, either only a change in the position and the number of the flowering parts, or the changing of the flowers into leaves, or only the change of the stamens into petals occurred. The last two changes were emphasized in the seedlings. No changes could be demonstrated in the female flowers, for example, the complete lack of petals, but instead of this a new change not observed in the parent flower became manifested, namely, a peculiar distantly spaced position of the sepals, which was noticeable.

Blaringhem, by the use of mechanical methods, mutilation, and twisting of the main stem, attacked a normal race of maize, Indian corn (*Zea mays pennsylvanica*), to produce varying forms. As a result thereof, manifold abnormal forms appeared already in the parent plant, of which only a part recurred in the seedlings. Not transmissible was a variation, in which the seeds appeared separated upon the cob; nor a second, with chaffy ears and red instead of green leaves; nor a third, in which all the flowers of the ear, which normally should have all been pistilate, had been changed to staminate flowers, without a change of form or of the husk. The following changes, however, remained constant upon further cultivation, without renewed mutilation; a race with stamens upon the cob; that is, bisexual ears. Normally the ears, which develop on the side of the stem from the axil of the leaves of the Mays plant, are purely pistilate fruit-flowers, while the terminal spikes at the summit of the stem are purely staminate. However, the stamens growing between the pistilate flowers were unable to produce pollen. Blaringhem calls this race "*Zea mays* var. *pseudo-androgyna*;" i. e., "the false hermaphrodite." Another constant form was an early ripening race with many densely crowded somewhat irregular rows of seeds, possessing also a different form of stem and number of leaves. Blaringhem calls this "*Zea mays* var. *semi-praecox*," "the half early." Finally, a strongly different form, which blooms and ripens even earlier, with remarkably small ears and staminate spikes, in which the spikes, which should be purely staminate, are in part or wholly changed into mere scars; that is, they have assumed the form of the pistilate flower, which is intended to capture the pollen. Blaringhem calls this form, "*Zea mays praecox*," "the very early," and considers it a new distinct species.

All the experiments so far cited pertain to plants or invertebrate animals. To succeed in these experiments it is necessary to watch the particular organism for at least two generations, and to keep

them, in spite of the unnatural conditions, in such a state of health that they will undergo reproduction even while in captivity. On account of the short period of life and rapid sexual maturity, no great difficulties were encountered while using these lowly-organized animals. Among the plants, the gardeners and farmers have always looked to it that the technical problems pertaining to these were placed in their hands, even before experimentation, and the study of life phenomena upon the living object was undertaken by biology. A lesser consideration was bestowed upon the animals, especially the so-called "cold-blooded" vertebrates. Zoological gardens contained only mammals and birds. The use of aquaria and terraria as a pastime, which later on lent much assistance to the rearing of organisms for scientific purposes, was still in its infancy, when, with their aid, easily solved problems began to play a part in biology. They also play a part when it is desired to change the normal conditions under which an organism exists. While the botanist often knows, almost instinctively, how he must treat a plant which he receives for the first time, the zoologist, on the other hand, stands almost helpless, though dealing with much better known forms, when he finds them dying on his hands. For my own experiments I had selected charges which demanded considerable attention, and I had to arrange a special technique, step by step, to make it possible to keep these animals, mostly reptiles and amphibians, alive and to have them multiply. Owners of vivaria, who may be among my listeners, may answer that it is not at all difficult to keep a treetoad, toad, or salamander for years in very simple surroundings—a small box with moss and some water. This is very true, but such animals will never multiply under such conditions, although they may live a long time. Furthermore, such conditions would have hardly helped me, for example, to still have living midwife toads (*Alytes obstetricans*), which I collected in Appenzell in the summer of 1894, and some fire salamanders (*Salamandra maculosa*), which I have had since I was 12 years old, or more than 18 years. The difficulties reach their zenith when one considers the problem of keeping a shade and moisture loving salamander, in brilliant light, on dry sand and colored paper, placing only a small vessel with water and a very small nest of moist moss at its disposal, or when one takes care of a lizard, which normally loves dryness and sunlight, in comparatively cool, moist, and dark surroundings.

Formerly I succeeded in getting the animals experimented upon to reproduce out of doors in so-called out-of-door terraria, or large cement basins. The greater number of these pets have now become domesticated, and they perform these functions in smaller containers indoors.

And now to the experiments themselves, for I intend to give you a somewhat more complete account of my rearing of the midwife

toad (*Alytes obstetricans*). In order to understand this, it becomes necessary to say a few words about the ordinary method of reproduction in most of the toads and frogs (fig. 8). They deposit their small eggs, hundreds in number, in water. The eggs are surrounded by a jelly-like substance that unites them into bunches or strings (fig. 8a). Here the jelly-like covering swells at once about each dark-colored egg as a sharply-differentiated translucent ball (1b). The eggs remain without attention from the parents after deposition. The young (c) escape from the eggs. The free larvæ, so-called tadpoles, which at first are not provided with any special breathing apparatus, for they breathe with the outer skin (d), develop external gills after a few days (e), which are later retracted (f) and give way to inner gills (t). But still for weeks the larva remains without feet (h). It develops first the posterior (i), then the anterior extremities (k, l), after which the tail becomes shriveled and the narrow, horny jaw is replaced by the deeply cut mouth of the frog (m). Then the small complete frog jumps to land.

There is only a single exception to this rule in Europe, the so-called midwife toad, or egg-bearing toad (fig. 9). In this the deposition of eggs takes place on land and a comparatively small number of eggs (18-83) are produced, but which, on account of their great yolk mass, appear large and light colored (fig. 9, 2a). The jelly capsules which connect these eggs into a chain can not swell in the air, but, on the other hand, become contracted and fit closely to the surface of the egg. The male assists the female during oviposition by drawing the string of eggs from the cloaca. He also assists in the brooding of the eggs (comp. fig. 10, 7 ♂), winding the eggs about his thighs and carrying them about in this manner, until the young are ready to emerge. At this time the male with his burden enters the water, where the larvæ break their capsules. They do this not in the stage unprovided with special breathing organs, for this and the following stage, that with external gill, are passed over in the egg. The larva is still footless (fig. 9, 2b), but has internal gills. The succeeding developmental stages agree with those of other frogs and toads—two-legged (2c), four-legged (2d), shriveling of the tail, and habitat change from water to land in the completed toad (2e).

I was able to change the above-mentioned process considerably in four directions. In the first, the aquatic existence of the larva was much prolonged (fig. 9, the detail fig. 6). I gradually learned to what extent factors like darkness, cold, richness of oxygen in the water, overfeeding after previous starvation, and the early removal of the embryo from the egg, played in prolonging the metamorphic period of the toad. With each one of these factors I obtained larvæ which did not transform at the proper time, and which already in the larval stage attained considerable size, still, what is most important,

developed into adult toads at the advent of the reproductive period. The progeny resulting from these toads, in which the metamorphic changes had been delayed, underwent metamorphosis within the usual normal time. They therefore had failed to inherit the varying developmental process. It required the combination of all the above-mentioned factors to produce a sexually fertile toad larva (fig. 9, 6*d*). Their progeny (6*C*), although produced by the mating of the unique sexually fertile female larva with an ordinary completely developed mate, for years did not progress beyond the stage with developed hind legs and displayed little metamorphic energy.

Secondly, the independence of water, which is already expressed in the normal reproduction of the midwife toad, by the phases passed over out of water during development was pushed to the limit. If one hastens all the processes of development by the employment of warmth and retards the hatching by withdrawing light and placing them in comparatively dry surroundings, then one obtains gigantic eggs (fig. 9, 3*a*), in which the embryos remain until they have well-developed hind legs (3*b*). The toads developed from these are dwarfed and eggs laid by them are of lesser numbers than in the normal toad, and possess from the very beginning a great amount of yolk, much more than in the usual eggs, and it is a curious sight to see a dwarfed male perform his brooding function with the very large few eggs. If one continued to apply the same stimuli to the eggs, then one again obtained larvæ, with completely developed hind legs (3*D*); but if one transferred them into normal conditions as far as requirements of temperature, light, and moisture are concerned, larvæ were obtained, which at hatching possessed bud-like hind legs (3*C*).

Thirdly, one can develop the larvæ to the two-legged stage, away from water, simply on moist ground; in this, if danger of death threatens, one must return them to their normal element. The land larvæ (fig. 9, detail fig. 5) possess a thicker skin than the aquatic larvæ, which is easily observed by the fact that in the aquatic larvæ only (comp. fig. 9, 2*c*) the rumpmusculature is visible through the skin. The land larvæ possess also a narrower fin, but are stronger in the bones and musculature of the tail. The lungs are subjected to a curious modification in the aquatic larvæ; they are simple, smooth-walled tubes (2*d*); in land larvæ of the same age they have already been separated into lobules, alveoli, and sacs (5*a*), which approach, both in form and structure, those of the completed toad (2*E*). The toads developed from terrestrial larvæ are dwarfed. If one keeps the larva produced by these again out of water, then the ability to exist out of water is increased. A further stage (5*C*) is therefore reached than in the preceding generation, which extends to

the time when the fore limbs are about to erupt, and all adaptations to a terrestrial existence now appear emphasized.

The fourth cycle of adaptation and inheritance. If one keeps gravid midwife toads in a high temperature (of 25° to 30° C.), then they omit the brooding stages above described and return to the primitive methods of reproduction peculiar to the rest of the toads and frogs. The unusual heat forces the animals to seek coolness in the water basin, which is at all times at their disposal. Here the sexes meet and fertilization and oviposition take place. But the moment the gelatine capsule of the egg comes in contact with the water, it swells (fig. 9, detail fig. 4a) and loses its viscosity and therefore its property to draw itself tightly about the thighs of the male later upon drying. The male is therefore unable to fasten it to its posterior extremities. The string of eggs therefore remains in the basin, in which a few of them develop in spite of the changed conditions.

In the same proportion in which the seeking of the water and the completing of the reproductive processes without brooding become a habit, so that the animals even without the stimulus of high temperature conduct themselves in this manner, do certain changes occur in the eggs and larvæ which correspond to a closer approach to the original methods of reproduction of toads. The number of eggs and their ability to develop in water becomes decidedly increased. The aquatic eggs possess a lesser amount of yolk than the terrestrial eggs, and are therefore smaller and different in color, but owing to their swollen gelatine layer, they appear just as large as formerly. From these eggs emerge larvæ which belong to an earlier stage than those normally produced, representing an intermediate stage between this and that of the rest of the toads. They possess external gills, of which the midwife toad has only a single pair (the anterior), (fig. 9, detail fig. 4b). Toads produced from such larvæ are distinguished from normally produced individuals by being considerably larger.

In order to test the inheritance of these reproductive adaptations I permitted aquatic eggs derived from animals which had become accustomed to this mode of oviposition to develop under normal conditions, in a room in which the control animals are kept and in which these have kept normal. If the reproduction adaptation had become a changed instinct, then the transmission left nothing to be desired in the way of distinctness. The sexually matured young midwife toads sought the water with the beginning of their first reproductive period and deposited there their strings of numerous small, dark-colored eggs without bestowing any additional attention upon them. The aquatic eggs of later generations are still smaller and possess still thicker investments, the additional gelatine being obtained by a shortening of the spaces between the eggs in the string. The larvæ of later generations, derived from aquatic eggs (fig. 9, detail

figs. 4C, 4D), show an increase in dark pigment, a reduction of the yolk to its complete retrogression as well as changes in the gills, which become shortened, simplified, and coarser, and while usually only the first of the gill arches of the skeleton bears a gill, these appear on three of the free arches in the fourth generation (4D). The males, probably on account of the difficulty of clasping the female in the water, have developed as an adaptation coarse swellings on their thumbs, and also strengthened the musculature of the arms, which lend the forelimb a more inwardly flexed appearance. These are external sexual characters which hold good in all toads and frogs that mate in the water, but which are not normal, for the midwife toad normally mates on land.

The brooding instinct, or its absence, are peculiarities which fall to the lot of the male in the midwife toad. The character and development of the egg, on the other hand, are everywhere derived from the females. To cross normal midwife toads with such, in which the reproductive processes had been changed, presented some fascination. In our illustration (fig. 10) we have shown a normal male (7 ♂) with the affixed egg chain upon its thigh, in order to indicate that it will, if necessary, actually carry out the function of brooding. The changed male (8 ♂) is larger and has left the egg string with the smaller darker eggs, which are surrounded by a swelled capsule, lying unnoticed alongside of him. The normal females appear in the empty white field; it deposits its eggs, as we know, upon the earth. The larger changed female is in the shaded field because it deposits its eggs in the water. I cross in the one case (fig. 10, detail fig. 7P) a normal male with a changed female. The offspring (fig. 1) prove at their first reproduction to be perfectly normal; the males brooding, the females depositing their eggs on land. I thought nothing less than that the habit change on account of the introduction of the normal male in the parent generation had passed out. Alas, they reappeared in the second generation (F_2) almost exactly in a quarter of the offspring, the remaining three-fourths of the second generation being normal. An opposite crossing, a normal female with a changed male (fig. 10, detail fig. 8P), yielded the following results: The first generation (F_1) takes exactly after the male parent; that is, all the individuals exhibit the reproduction changes resulting from the experiment, the females deposit the eggs in the water and the males do not brood. The second generation is one-fourth normal and the remaining three-fourths are changed.

Let us now note the following scheme (fig. 11): It corresponds with the experiences which have frequently been obtained in crossing races of plants or animals. Namely, if one crosses a "dark" with a "light" race (fig. 11P), then one of the two peculiarities alone is dominant in the daughter or the first filial generation (F_1), for exam-

ple, the "dark" one. If one produces a second filial generation from a pair of this apparently dark race, (F_2), then "dark" again is dominant but only three-fourths, while the remaining fourth is "light" and causes the "light" of the grandparent to reappear. If one breeds from the "light," then "dark" never reappears; the "light" is and remains pure. If one continues to breed the three-quarter "dark" together, then one-fourth continues to breed pure "dark," which always yields "dark" offspring, but the remaining two-fourths, when bred together, yield in the third filial generation (F_3), another splitting into three-fourths "dark," of which one-fourth is pure strain "dark" and two-fourths mixed, and one-fourth which is pure "light" strain. This continues as long as the inbreeding permits of the development of offspring. This inheritance scheme, of which our picture cites the simplest possible case, is called Mendel's division scheme or prevalence rule, after its discoverer; that peculiarity which is entirely prevalent in the first generation and three-fourths in those following is called the dominant, and the name recessive is given to that peculiarity which is suppressed entirely in the first generation and reappears in one-fourth of those that follow. The numerical arrangement of these peculiarities in the progeny is usually not influenced by the sex of the parent bearing the dominant or recessive properties. This, however, is not true in the case of our crossings in the midwife toad.

It is true, however, that these experiments fall in line with Mendel's law, but the dominant factor is attached to the male, and a change in dominance depends upon whether we use a male possessing one or another peculiarity. On the other hand, the recessive character in the case of the midwife toad is attached to the female. I feel convinced that this unusual change in the distribution of the habit between the two sexes which we have considered is of importance. But this is secondary compared with the important result that acquired characters not only become transmitted but in the mixing with unchanged characters they follow Mendel's law. The acquired character, therefore, has a chance to come forth pure, in a certain percentage, from the mixture of characters, and is thus preserved. To this attaches, as we shall learn, a high degree of stability. The new character must have ceased to be a changing or unusual thing; it must have been transmitted to the organism, as we may say, in flesh and blood.

Next to the midwife toad, the fire salamander (*Salamandra maculosa*, figs. 12, 13), which lives in moist woods, has become a favorite of mine. If kept for several years upon yellow clay (fig. 12, P row), then his yellow markings become enriched at the expense of the black ground color. If half of the offspring of individuals which have thus become very yellow (fig. 12, F_1 row) be raised on yellow soil, the

amount of yellow increases and appears in broad regularly distributed longitudinal bands. The other half of the offspring if grown on dark soil become less yellow, always, however, in close relation with the opposing influence of the color of the surroundings, and likewise in a regular order—in this instance as rows of spots along the sides of the body.

If the parent generation of the fire salamander be raised on black garden soil (fig. 13, *P* row), after some years it becomes largely black, while the young kept upon black soil (F_1 row) have a row of small spots on the middle of the back. On the other hand, in young which in contrast with their parents have been raised on yellow soil, these spots fuse into a band.

If we use yellow paper instead of yellow soil and begin our experiment, as we did before, with scantily spotted individuals, then we obtain enlargement, but no increase in the number of the spots. If we take black paper, then we obtain a reduction in the size of the spots without reduction in intensity of coloration. The young bear the few spots in the middle, while the normal young from the control brood in mixed surroundings at once produce an irregular pattern of markings.

Heavy moisture produces an increase of the yellow, but only in the number of spots, none in the size of the spots. Numerous but still small spots may be observed in the progeny put back into less moist surroundings. Comparative dryness results in loss of brilliancy, but not in loss of size in the spots. The same phenomenon may be observed in the progeny which is again kept moist, especially when compared with the control brood which was kept under uniform conditions.

Striped fire salamanders occur not only as fancy products of breeding, but in some places (as in north Germany and southern Italy) they occur also in nature. If such examples be kept upon yellow soil, then the interruptions which may occur in their stripes are filled out and the completed bands become wider and send out cross bridges. If, on the other hand, animals with complete stripes be kept on black soil, the stripes become narrower and break up. I employed striped salamanders for another experiment, using some which had been caught wild and some produced by artificial rearing from spotted individuals. I exchanged the ovaries, grafting these of the striped salamanders upon the spotted ones and that of the spotted salamander upon the striped females. I can not enter upon all the combinations of these experiments, especially not upon the use of suitable males, which in the attaining of safe results become very much involved, and would require much repetition. But the following result will hardly be altered: The ovaries taken from a spotted female which were implanted upon a wide striped female uniformly

yielded spotted young, while the ovaries from a spotted female implanted on an experimentally changed striped individual yielded spotted, striped, and interrupted striped young. Commonly expressed, we reached the following conclusions:

1. If one deals with completed race characteristics which have become established in the foreign body, the so-called nurse, then the progeny will correspond to the characters of that individual from which the ovary originated, not to that individual into whose body the ovary has been transplanted.

2. If one deals with only recently acquired, newly produced, or other characters which have been taken out of their equilibrium, which in the body of the nurse may quantitatively diminish or increase, or may be on the point of becoming quantitatively changed, then the progeny resembles, at least in part of its characters, that individual by which they were carried in the undeveloped state. In this case only there passed from the bodily peculiarities, which were still easily changed, being as it were, still new and unaccustomed to their possessor, a sufficiently strong stimulus upon the reproductive elements.

These results may at some future time prove valuable in harmonizing the contradictions which have resulted from the experiments of other investigations in ovarian transplantation. For Guthrie, by exchanging the ovaries of black and white chickens, obtained an influence upon the chicks through the colored feather covering of the nurse. Magnus obtained the same results in black and white rabbits. Heape, on the other hand, in transplanting fertilized ova from white Angora rabbits into gray Belgian hares, obtained no such influences; nor did Castle by ovarian transplantation of black guinea pigs into white individuals; nor Poll, in the same operation upon gray and white mice; nor Morgan in operating upon *Ciona intestinalis*.

My experiments in transplanting may serve to straighten out the controversy between the so-called neo-Mendelists and neo-Lamarckists. Let us therefore return briefly to our crossing experiments with the midwife toad. Each hybridization is in reality a transplantation of the germ elements, in a nonoperative natural way. We noted that in a body with entirely different properties, those germ elements which were carried over into it during coition retained their own peculiarities, often with the greatest persistence; even to such an extent that they always reappeared unchanged in a certain percentage of the offspring. It is possible, indeed probable, that we are now in possession of the explanation of these phenomena, for we are dealing always only with well-fixed, old, constant peculiarities, which no longer exert a form or color-changing stimulus upon each other or their surroundings. In our midwife toad we are also dealing, not with peculiarities which, in the strict sense, are new, but with reawakened old peculiarities

which had become lost—a resuming of the abandoned lines of development of the forefathers. It was on account of this that these reversions or atavistic characters could be carried to a high or at least sufficiently balanced degree. If these had been newly acquired characters and transmissible in pure strains, their diversion in the Mendelian sense would nevertheless have been impossible, for I have been convinced of this recently by completed control experiments with animals which had enjoyed the peculiar adaptation for a short period only. In these, neither of the two peculiarities of the parents is completely dominant in the offsprings, but they stand midway between their producers, and the acquired character pales, fades, becomes enfeebled, and is finally lost.

I do not wish to close my observations without considering another phase of the inheritance of acquired characters, namely, the transmission of acquired disease and the transmission of acquired resistance against toxin.

Strictly considered in the light of experimental investigation, we possess only the classical experiments of Brown-Séguard, Westphal, and Obersteiner that deal with transmission of disease. These were responsible for epilepsy produced in the guinea pig by operation. Brown-Séguard and Obersteiner severed some cords of the spinal cord, or more frequently the hip nerve in their guinea pigs; Westphal tapped them on the head with a hammer once or several times.

The most marked results of these interferences consist in epileptic cramps, as well as an occasional change of the eyeball, namely, a whitish dulling of the cornea and protrusion. These changes produced by disease are found again in a part of the progeny; even the second generation possesses at times a tendency to epileptic attacks from the first without a repetition of the operation. These experiments have since been twice tested; first, by Sommer with completely negative results; but this can scarcely be considered conclusive on account of the limited amount of material experimented upon; and second, by Macisza and Wrzosek, in which the older observations were completely verified and their scope only slightly restricted by the fact that incomplete attacks could be produced in a few healthy young, from normal parents, a fact not observed by any of the previous investigators.

As regards the inheritable transmission of protection against bacterial or other toxins, we have the pioneer experiments of Ehrlich, now famous for his remedy for syphilis, on mice protected against rizin and abrin; also those of Tizzoni and Cattaneo on mice protected against tetanus and rabbits protected against hydrophobia; finally, those of Behring upon rabbits protected against diphtheria; but these are not quite beyond challenge, since the transmission of toxin resistance upon the progeny was then observed only when both parents, or

at least the female, was protected against toxins and not when the male alone possessed this peculiarity. The doubt was therefore not excluded that the transmission may have taken place not by true inheritance of the undeveloped germ, but later through the placenta, or even by way of the milk of the mother, while nursing. The latter possibility appeared all the more reasonable, since analagous experiment by Lustig upon chickens protected against abrin in which both of the questioned sources of error were eliminated yielded completely negative results. But final positive proof was furnished by experiments made by Gley and Charrin, who, by the use of rabbits and the toxin produced by the pus-producing *Bacillus pyocyaneus*, achieved that which Ehrlich and his followers had been unable to do, namely, the transmission of the resistance by immunity—in this case against a disease-producing poison produced by bacteria—through the male alone.

This wonderful new result, together with all those previously attained, opens an entirely new path for the improvement of our race, the purifying and strengthening of all humanity—a more beautiful and worthy method than that advanced by fanatic race enthusiasts, which is based upon the relentless struggle for existence, through race hatred and selection of races, which doubtless are thoroughly distasteful to many. This will never save human society from degeneration; it will not qualify man for greater efforts or higher aims. These must be acquired solely and alone by our own labor toward a well-determined end. If acquired characters, impressions of the individual life, can, as a general thing, be inherited, the works and words of men undoubtedly belong with them. Thus viewed, each act, even each word, has an evolutionary bearing. The acquiring of new characters may prove an inherited burden if unhealthy conditions and overindulgence, or lack in all things, or bad passions ruin our body, and therefore our reproductive cells, so that even good germs become strangled in it. But the active striving for definite, favorable, new qualities will in a like manner yield the power to transmit the capabilities which we have acquired, the activities which we have busily practiced, the overcoming of trials and illness—will leave somewhere their impress upon our children or our children's children. Even if ever so much weakened; even if only in disposition or tendency, not in completed form; even if completely concealed for generations, some reflection of that which we have been and what we have done must be transmitted to our descendants. We know, unfortunately, all too little about this, because well-planned breeding experiments are impossible in man, and because statistical investigation, which we offered in their place, is frequently full of error. We are therefore forced to draw our conclusions from the better-known case of the plants and animals; and

just such cases make it seem probable that our descendants will learn quicker what we knew well; will execute easier what we accomplished with great effort; will be able to withstand what injured us almost to the point of death. In a word, where we sought, there they will find; where we began, there they will accomplish; and where we are still fighting with uncertain results, there they will be victorious.

EXPLANATION OF PLATE FIGURES.

- FIG. 1.—*Slipper animalacule* (Paramaecium).—1, normal, more enlarged, and less schematic; 1a, offspring resulting by fission from an example which has been distorted by hunger, every time one offspring with a hornlike process; 1b, incomplete fission the fission products remain attached to each other. (After Jennings and McClendon, from Przibram's *Experimentalzoologie*, vol. 3.)
- FIG. 2.—*Aeolosoma hemprichii*.—Upper left-hand figure normal worm, *T*, budding; *a*, a worm in which the end was cut off, in spite of which a new worm is budding in *aT*; *b*, bud fused with the stem part, in *bT*, producing, in spite of this, another normal bud. (After Štolč, from Przibram's *Experimentalzoologie*, vol. 3.)
- FIG. 3.—*Lumbriculus*.—Above normal worm *A5* anterior, *B5*, posterior segments, which are cut away and produce tails, *a*, *b*; in *a* and *b* these separated tails have acquired new heads; in *a* and *b* the latter have each grown another set of tails. (After Morgulis, from Przibram's *Experimentalzoologie*, vol. 3.)
- FIG. 4.—The approach of the Salinecrustacean (*Artemia*) (1) to *Branchipus* (2). When the saline contents of medium are reduced. 1a-f, gradations of the posterior segment of the abdomen of the Salinecrustacean; 2g, posterior segment of the abdomen of *Branchipus*. (After Schmankewitsch, from Przibram's *Experimentalzoologie*, vol. 3.)
- FIG. 5.—A water flea (*Hyalodaphnia*). To the left high, right low helmed females, with eggs in the brood pouch. In the middle are the results of three experiments (1-111), represented by sketches of the head outline; *aa*, females; *bb*, young. (After Ostwald, from Przibram's *Experimentalzoologie*, vol. 3.)
- FIG. 6.—Vital staining in the moth *Tineola biselliella*.—A caterpillar stained with sudan red. *B*, colored egg, deposited by a moth developed from the stained caterpillar; *b*, normal, colorless egg. (After Sitowski, from Przibram's *Experimentalzoologie*, vol. 3.)
- FIG. 7.—Changing the small willow leaf beetle (*Phratora vitellinas*) from a smooth leaf (*A*) to a strongly woolly willow leaf (*a*). In *B* most of the eggs have been deposited upon the original food plant (above); in *b* the eggs have been placed upon the new food plant. Analog in *C*, *c*, *D*, in which an increasing number of eggs are deposited upon the new food plant. The numerical difference in the number of the eggs deposited is indicated by the number of circles alongside of the twigs. To the right below is the beetle. (After Schröder, from Przibram's *Experimentalzoologie*, vol. 3.)
- FIG. 8.—Development and metamorphosis of an ordinary frog. *a*, freshly deposited eggs; *b*, with swollen capsule; *c*, before hatching; *d*, freshly hatched larva; *e*, with external gills; *f*, external gills retrogressing; *g*, *h*, footless larva with internal gills; *i*, larva with hind legs; *k*, with the beginning of front legs; *l*, with all four legs; *m*, after discarding the horny jaw and almost complete shriveling of the tail. (After Brehm.)
- FIG. 9.—Adaptation of the midwife toad (*Alytes obstetricans*). 2, normal development; *a*, egg; *b*, freshly hatched larva; *c*, two-legged *d* four-legged larva; *e*, newly developed toad; *δ*, lung of larva; *ε*, lung of complete toad. 3, development from "giant eggs"; *a*, egg; *b*, newly hatched larva; *C*, newly hatched off-

spring without *DD* with continued development from giant eggs. 4, development from "aquatic eggs; *a*, egg"; *b*, newly hatched young, alongside of which is its head with one pair of external gills; *C*, in the same way the larva of the first; *D*, the fourth generation (here with three pairs of gills). 5, land larva; 5*C*, offspring of same; 5*a*, land larva, young. 6, giant larva; *d*, sexually mature larva; 6*a*, lungs of same; 6*C*, the offspring of same. (After Kammerer, from Przibram's *Experimentalzoologie*, vol. 3.)

FIG. 10.—Crossings between normal and changed midwife toads. 7, normal brooding male (σ), with changed, water depositing female (φ). 8, normal land depositing female (φ), with changed, nonbrooding male (σ). *P*, parents; *F*₁, children; *F*₂, grandchildren. (After Kammerer, from Przibram's *Experimentalzoologie*, vol. 3).

FIG. 11.—Scheme of inheritance according to the Mendelian or prevailing law. *P*, parents; *F*₁, children; *F*₂, great-grandchildren.

FIG. 12.—Color adaptation of the fire salamander (*Salamandra maculosa*) to yellow earth and the transmission of this adaptation with the appearance of a symmetric color pattern in the daughter generation. "*P*-line," *F*₁-line, denote the color changing process of a single parent pair of parents (*P*, parents -*F*₁). The time element in each two stages of the *P*-line requires two years, that of the *F*₁-line, one year. (After Kammerer.)

FIG. 13.—Color adaptation of the fire salamander (*Salamandra maculosa*) to black garden earth and the transmission of this adaptation with the appearance of a symmetric color pattern in the daughter generation. All details as in figure 12, which see. (After Kammerer.)





FIG. 1.—SLIPPER ANIMALCULE. (EXPLANATION ON PAGE 440.)

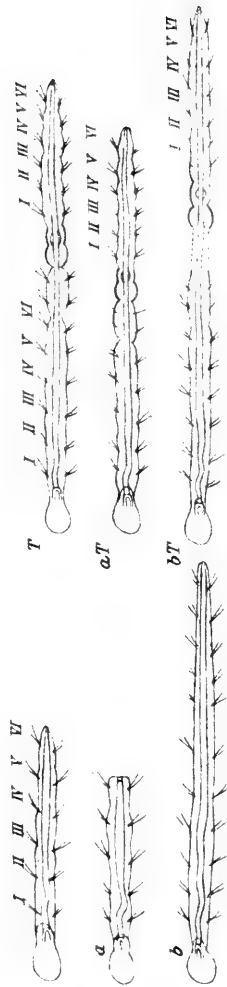

FIG. 2.—AELOSOMA HEMPRICHI. (EXPLANATION ON PAGE 440.)

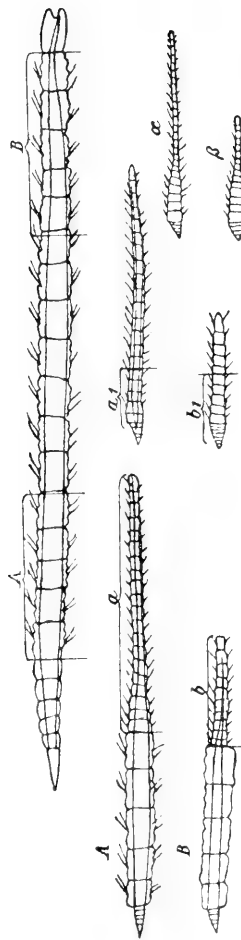

FIG. 3.—LUMBRICULUS. (EXPLANATION ON PAGE 440.)

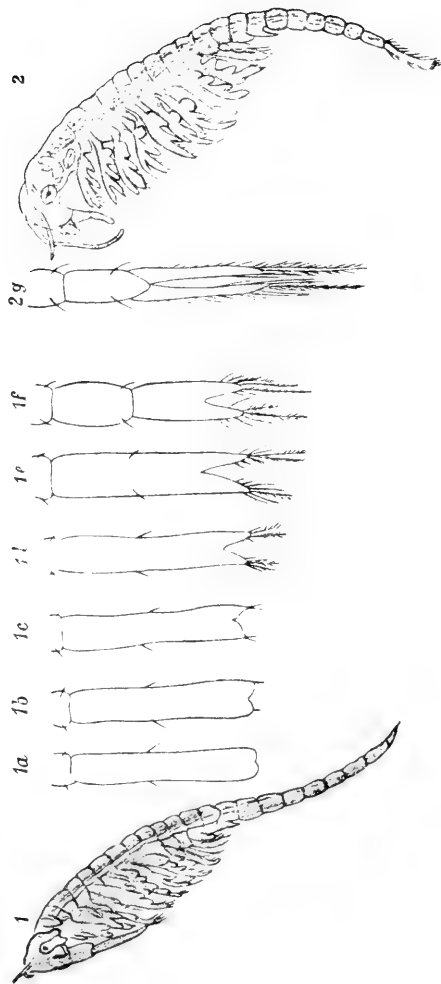

FIG. 4.—APPROACH OF ARTEMIA TO BRANCHIPUS. (EXPLANATION ON PAGE 440.)

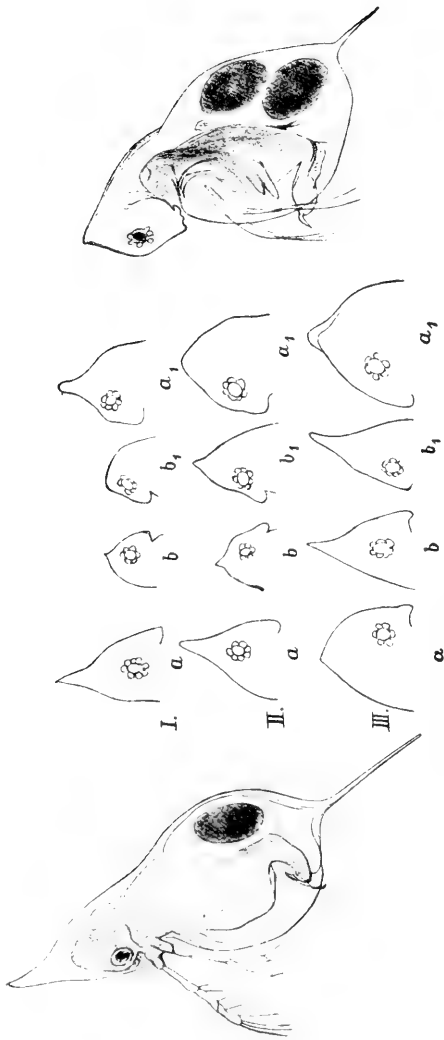

FIG. 5.—A WATER FLEA (HYALODAPHNIA) (EXPLANATION ON PAGE 440.)



FIG. 6.—VITAL STAINING IN MOTH TINEOLA. (EXPLANATION ON PAGE 440.)

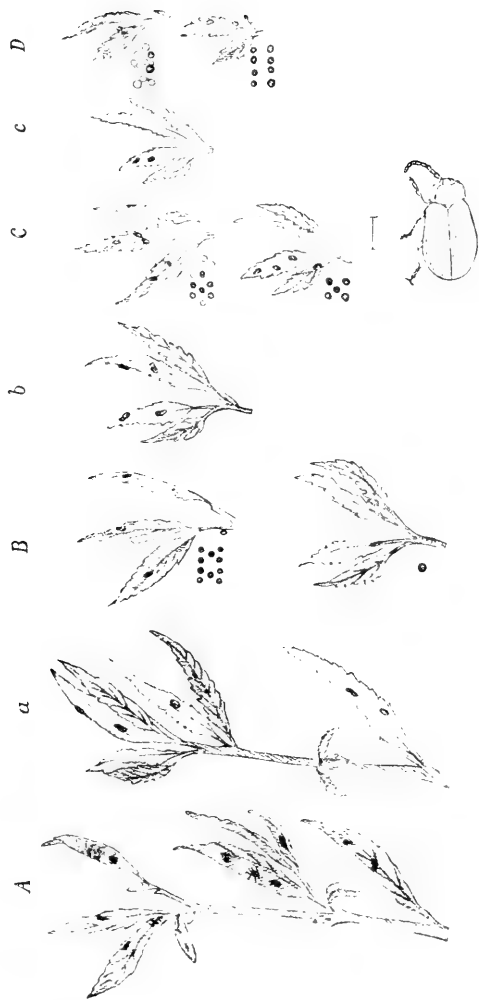

FIG. 7.—WILLOW-LEAF BEETLE. (EXPLANATION ON PAGE 440.)

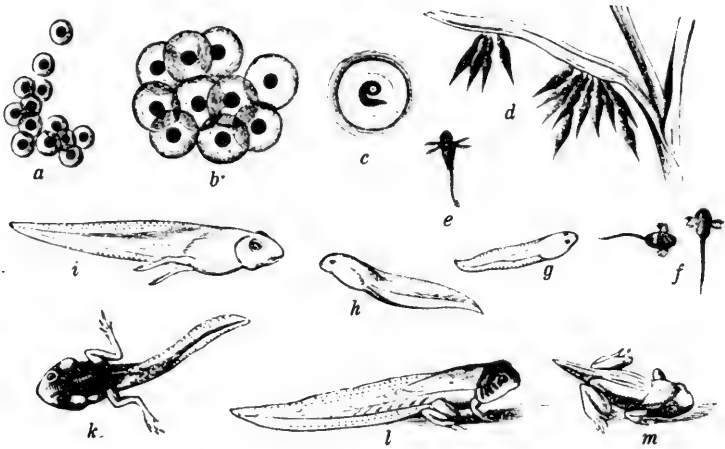

FIG. 8.—METAMORPHOSIS OF FROG. (EXPLANATION ON PAGE 440.)



FIG. 9.—ADAPTATION OF MIDWIFE TOAD. (EXPLANATION ON PAGE 440.)

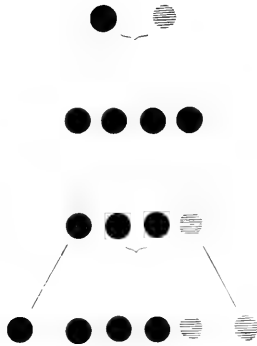

FIG. 11.—SCHEME OF INHERITANCE. (EXPLANATION ON PAGE 440.)

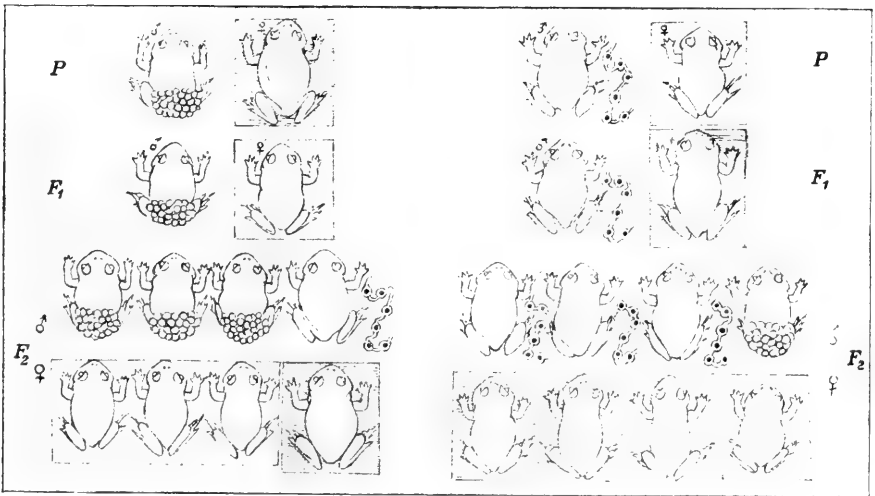
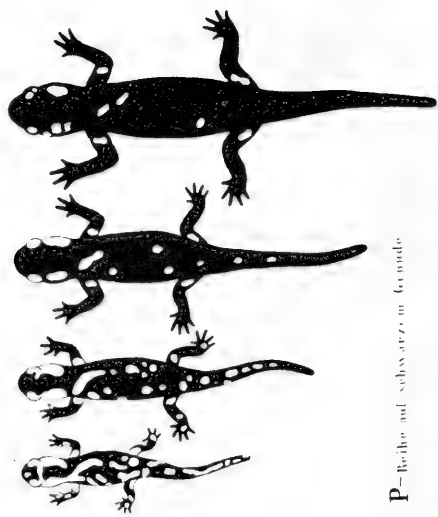
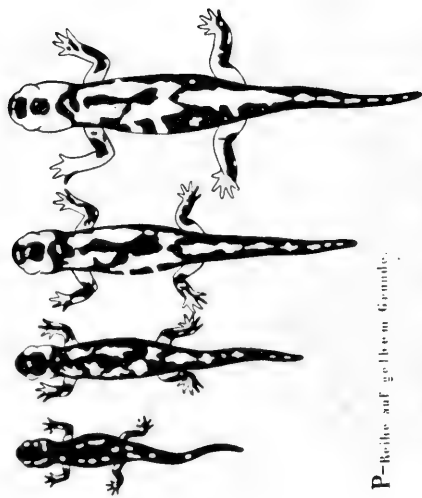

FIG. 10.—CROSSINGS BETWEEN NORMAL AND CHANGED MIDWIFE TOADS. (EXPLANATION ON PAGE 440.)



P-Reihe auf schwarzem Grunde



P-Reihe auf gelbem Grunde

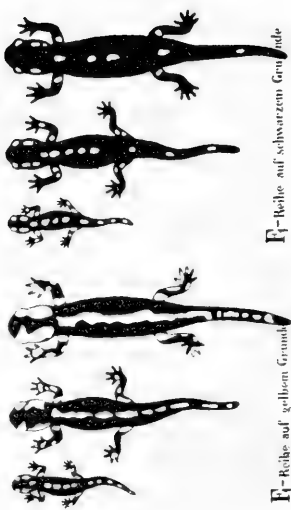

F-Reihe auf schwarzem Grunde

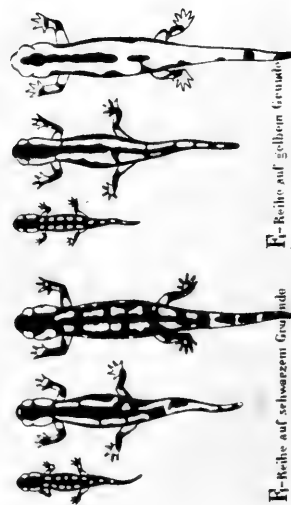

F-Reihe auf schwarzem Grunde

FIG. 13.—COLOR ADAPTATION OF FIRE SALAMANDER TO BLACK EARTH. (EXPLANATION ON PAGE 440.)

FIG. 12.—COLOR ADAPTATION OF FIRE SALAMANDER TO YELLOW EARTH. (EXPLANATION ON PAGE 440.)

THE PALEOGEOGRAPHICAL RELATIONS OF ANTARCTICA.¹

By CHARLES HEDLEY, F.L.S.,
Assistant Curator of the Australian Museum, Sydney, New South Wales.

1. INTRODUCTION.

Testimony in support of alteration in temperature and contour of Tertiary Antarctica is almost wholly based on a comparison of the living fauna and flora of surrounding countries. While biologists in general, led by Wallace, Selater, and Hutton, opposed the idea of an extended and habitable Antarctica, geographers hesitated to adopt an hypothesis the arguments for which lay in a foreign field. But of late years most of those engaged in its discussion have been supporters of extension, so that the theory has advanced from the position of a disparaged heresy to that of an established view.

Accustomed to rely on biological evidence in the form of paleontology for important and far-reaching generalizations, geology may now accept from biology this theory of former Antarctic extension. Thereby is acquired a correlation of climate, of time, and of continental change, while incidentally a new light is thrown on the question of the permanence of ocean basins.

It seemed nothing unusual to find a similar fauna and flora, even to the extent of a large proportion of identical species, on the subantarctic islands all around the world. But collectors working in South Temperate and even in South Tropical Zones were surprised to find related species and genera in opposite hemispheres. This correspondence is more pronounced in primitive groups and grows clearer southward.

First, it was realized when the famous botanist, Sir J. D. Hooker, pointed to the distribution of the southern pines as indicating a common origin. (Hooker, *London Journal of Botany*, vol. 4, 1845, p. 137.)

The relations of a southern fauna linking Australasia to South America were sketched firm and clear by a master hand in Prof. Huxley's essay on the classification and distribution of the gallinaeous birds. (Huxley, *Proc. Zool. Soc.* 1868, p. 294.)

¹ Reprinted by permission from the Proceedings of the Linnean Society of London, session 124, 1911-12. Read June 6, 1912.

According to Ortmann, first Rüttimeyer definitely proposed radiation from Antarctica as the solution of the problem. (Rüttimeyer, *Ueber die Herkunft unserer Thierwelt*, 1867, p. 15.)

Our knowledge of this subject was much advanced by Dr. H. O. Forbes. (Forbes, *Roy. Geogr. Soc. Suppl. Papers*, III, 1893.) Starting from the fossil avifauna of the Chatham Islands, he reviewed the community of southern faunas and interpreted it by antarctic distribution. As the means of dispersal he mapped a vast continent stretching continuously from Madagascar to South America and Fiji during the "northern glacial epoch."

It was suggested by the present writer that a far smaller area of continental land, of an earlier date and of unstable form, was indicated by its surviving refugees (Hedley, *Proc. Roy. Soc. N. S. Wales*, vol. 29, 1896, p. 278), and that the last Antarctic phase as reflected by these might be expressed in arms reaching on one side to Tasmania, on the other to Cape Horn, while previous phases may have been represented by other rays extending to New Zealand, Madagascar, Ceylon, and perhaps South Africa.

A study of terrestrial and fluviatile mollusca induced Ancey to subscribe to these suggestions. (C. F. Ancey, *Journ. de Conch.*, vol. 49, 1901, p. 12.)

Dr. Ortmann, while investigating the South American Tertiary invertebrates, accepted my amendments to Forbes's proposition. To a clear exposition of the subject he added a map and bibliography. (Report Princeton University Expedition to Patagonia, vol. 4, pt. 2, 1902, pp. 310-324.)

The distribution of southern earthworms was discussed by Prof. W. B. Benham. (*Proc. Austr. Assoc. Adv. Sci.* 1902, pp. 319-343.) In his opinion the Acanthodrilids, a primitive group, originated in New Zealand and spread by way of Antarctica to South America. He emphasized the fact that the union they indicated between Antarctica and New Zealand was not synchronous with the Australian connection.

Examining the mammalian fauna A. Gaudry considered that unless Tertiary Patagonia was united to Antarctica its paleontological history would be incomprehensible. (*Compt. Rend.*, vol. 141, 1905, p. 806.)

From a study of the fresh-water crustacea of Tasmania, Mr. Geoffrey Smith concludes that certain elements of this fauna "reached their present range by means of an Antarctic connection between the southernmost projections of Australia, South America, and New Zealand." (*Trans. Linn. Soc. Lond.*, ser. 2, *Zool.*, vol. 9, 1909, p. 67.) His analysis revealed the presence in Tasmania of another element which he derived from the northern hemisphere and which

he supposed to have traveled down the Andean Chain and crossed to Australasia by the Antarctic route.

Summing up a biological examination of the southern islands of New Zealand, Prof. C. Chilton concludes: "The evidence pointing to former extensions of land from the Antarctic Continent northward, and to the warm climate that was enjoyed by this continent in early Tertiary times, seems to offer a fairly satisfactory explanation of the facts before us." (Subantarctic Islands of New Zealand, vol. 2, 1909, p. 467.) A full bibliography is included in this article.

Finally, Osborn describes the hypothetical reconstruction of Antarctica as "one of the greatest triumphs of recent biological investigation." ("The Age of Mammals," 1910, p. 75.)¹

2. ARGUMENT.

The distribution records of recent and fossil species upon which the generalizations of the foregoing authors depend have never been denied. Indeed, they continue to increase with the progress of science.

To other, and usually earlier, authors these views presented two insuperable difficulties. One is the extreme change in climate which formerly permitted temperate and subtropical animals and plants to exist where cold is now so intense. The other is the demand for the existence of Tertiary land where an ocean now extends so broad and deep as that between Antarctica and Tasmania or New Zealand.

To evade these difficulties and yet explain existing distribution the following three alternatives have been advanced:

I.

That decadent groups were expelled from their original seats by more vigorous competitors; retreating from a northern center to the ends of the earth, such groups divided into fugitive parties which converged as southern lands approached the pole. Or discontinuous distribution in southern continents were simply considered remnants of a former universal distribution. (Wallace, "The Geographical Distribution of Animals," vol. 1, 1876, p. 398; Pfeffer, Zool. Jahrb. Suppl. vol. 8, 1905, pp. 407-442.)

But whereas, under the circumstances postulated, the northern wanderers would be expected to diminish and to vary as they receded, the

¹ While this article was in the press there reached me an important memoir by Dr. Pilsory on "The Non-Marine Mollusca of Patagonia." (Rep. Princeton Univ. Exped. Patagonia, III, 1912, pt. v, pp. 513-633.) My friend considers Antarctica rather as a road for migration, especially an American exit, than as a center of evolution. He takes exception to my derivation of Australian *Acaevidae* from Antarctica and suggests that the group arose in Gondwana Land. On reconsideration I would still maintain that the south-easterly increasing distribution of Australian *Acaevidae* indicates their immediate Antarctic origin. But previous to an Antarctic sojourn the group may have been Gondwana bred. This memoir heightens the resemblance between east and west. *Gundlachia*, *Diplodon*, and *Radiodiscus* are common, *Petterdiana* scarcely differs from *Littoridina*, and *Potamolithis* appears to have Tasmanian relatives.

southern forms in question became more alike and more numerous proceeding south. Thus radiation rather than convergence is indicated.

II.

That birds, winds, or circumpolar currents, by a process of picking up and setting down passengers from the continents or islands by the way, established a uniformity of fauna and flora. Thus, Dr. Michaelson writes (*Journ. West. Aust. Nat. Hist. Soc.*, vol. 5, July, 1908, p. 13): "There is no need for the supposition of an ancient great Antarctic continent which connected Australia and South America, as some scientific men still suppose. Certain littoral Oligochæta, consisting of euryhaline forms, for which the salt sea is no barrier, can be transported by the west wind drift over the stations on the different islands lying between one continent and another."

The flora of the circumantarctic islands, as instanced by Kerguelen, was thought by W. Schimper to have been conveyed by sea birds and ocean drift (*Schimper, Wissenschaft. Ergebn. Valdivia*, vol. 2, 1905, p. 75). Although this might apply to species which recur through several archipelagoes, such would not explain the presence of endemic plants and on Kerguelen the occurrence of an endemic snail, *Amphidoza hookeri*.

Such transport accounts only for a wide range of individual species capable of air or water carriage. It has doubtless been a small but real factor in distribution. But it does not account for the existence of related and representative species, for the subtropical element, or for the species incapable of such conveyance. Prof. W. B. Benham raises the objection that a species might drift yet never land: "When I stood at the top of the sheer cliffs, some 500 feet to 1,000 feet in height, which form the whole of the west coast of Auckland Island and saw the tremendous breakers which even in moderately calm weather dash with incredible force against the rocks, I was more than ever convinced that the west-wind drift can not account for the transference of Oligochæta from the various land surfaces of this subantarctic region." (Benham, "Subantarctic Islands of New Zealand," vol. 1, 1909, p. 254.)

III.

That a trans-Pacific continent conveyed to New Zealand, Australia, and South America a common stock otherwise recognized as the Antarctic element. (Hutton, *Proc. Linn. Soc. N. S. Wales*, vol. 21, 1896, p. 36; Baur, "American Naturalist," vol. 31, 1897, p. 661.)

This alternative seems the weakest. Had a trans-Pacific bridge really disseminated the species under discussion then they should be best developed in the central remaining portion (for instance, in Tahiti or Samoa) and least at the extremity (as in Chile or Tasmania).

Actually the reverse is the case. South America is the most closely associated with Tasmania, then New Zealand is less so, and the mid-Pacific islands not at all.

Those who consider the demand for land between Tasmania and Antarctica as exorbitant are not consistent in asking so much larger a grant in the Pacific.

Another difficulty is why that South American contingent which flooded Tertiary Antarctica, and then Australia, failed to include such characteristic South American fauna as the humming birds, platyrrhine monkeys, hystricomorph rodents, edentates, or notoungulates. Dr. von Jhering explains (*Trans. N. Z. Inst*, vol. 24, 1891, p. 431, and *N. Jahrb. f. Mineralogie, etc., Beil.-Bd.*, vol. 32, 1911, p. 176, pl. v) that two former subcontinents of late Mesozoic or early Tertiary age are now fused in the present South America. Before the rise of the Andes these were separated from each other by a broad sea and maintained distinct fauna and flora. The southern tract, which he calls "Archiplata," comprised what is now Chile, Argentina, and southern Brazil. The northern area, called "Archiguyana," embraced northern Brazil, Venezuela, and Guiana.

It was from Archiplata that the last phase of Antarctica had its American derivatives, and that at a time when many forms now regarded as typically South American had not yet reached Archiplata. Not until after Antarctica was released from Archiplata did the latter join Archiguyana, and then the southern fauna suffered the usual fate from the incursion of the more highly organized northern types.

3. THE AUSTRAL FAUNA AND FLORA.

More space than is here available would be required to enumerate the Antarctic refugees in austral lands. A few of the more striking instances are now selected.

Recent marsupials are restricted to Australasia and to the Americas, the monotremes to the former. It seems to have been assumed generally that marsupials necessarily had a European origin and traveled across Siberia to North America. A shorter connection between western Europe and South America by way of Archhelenis is at any rate worth debate. Had the entry to Australia been by the Malay Archipelago, as opponents of the Antarctic hypothesis advance, then stragglers by the way should have lingered in the East Indies. In Australasia marsupials and monotremes are least developed in the north; proceeding southward, more groups successively appear, till ultimately Tasmania has, as Prof. Spencer expressed it, "a condensation of most that is noteworthy in the Australian region." (Spencer, *Proc. Austr. Assoc. Adv. Sci.* 1892, p. 106.) Indeed, the most convincing proof of the Antarctic theory is the fact that in Australasia the South American affinities regularly increase as Tasmania is approached

and there attain their maximum. Those who deny marsupial migration across Antarctica are obliged to assume that the Thylacinidæ were independently evolved in each hemisphere. That Tasmania was the point of entry is supported by the discovery in Tasmania of the earliest fossil Australian marsupial. This, *Wynyardia bassiana*, is apparently one of the Phalangeridæ, but the unique example is too imperfect for positive identification. (Spencer, Proc. Zool. Soc. 1900, p. 776.) Local geologists class the stratum in which it occurred as Eocene, but English and American geologists are less disposed to grant these beds such antiquity.

If marsupials had not been available, the case could have been made as clear from herpetological evidence. And, indeed, were the vertebrata disregarded, the hypothesis could still be as well established from the invertebrata or the plants.

Among the reptiles, 50 genera of the Iguanidæ are known, all of which are confined to the New World, chiefly South America, except one genus in Fiji and two in Madagascar. Australian snakes are divisible into the venomous and the nonvenomous groups. All the venomous are of the family Elapidæ, related to South American types; they focus in Tasmania, where nonvenomous snakes are absent. The nonvenomous snakes are of Asiatic or Papuan affinity, and focus in North Queensland. The majority of Australian frogs are also akin to South American forms.

A family of large snails, conspicuous for the size and beauty of the shell and distinct in structural features, called by Dr. Pilsbry the Macroogona, has the following distribution: In South America, chiefly tropical, *Macrocyclus* 1 species, *Strophochilus* 51 species, and *Gonyostomus* 5 species; in Madagascar, *Ampelita* 54 species and *Helicophanta* 16 species; in the Seychelles, *Stylodonta* 2 species; in Ceylon, *Acavus* 7 species; in the Moluccas, *Pyrochilus* 4 species; in Tasmania, *Anoglypta* 1 species and *Caryodes* 1 species; in Eastern Australia, *Pedinogyra* 1 species and *Panda* 4 species. The Chilean *Macrocyclus* and the Queensland *Pedinogyra* by shell characters pair together, while *Helicophanta* is a match for *Panda*. The absence of this family from New Zealand, its preponderance of species in Madagascar, of genera in Tasmania with Australia, and its development in the Tropics are remarkable characters of this old austral group.

The snail family *Bulimulidæ* is characteristic of South America, beyond which two genera stray into the West Indies and North America, and two others, *Bothriembryon* and *Placostylus*, occur in Australasia. The first ranges from Tasmania to West Australia, and forms an exception to Antarctic rule by having its distribution center in the latter. Indeed, *Bothriembryon* and the fluviatile crustacean *Charaps* raise a suspicion that West Australia had direct relations with Antarctica prior to and independent of the Tasmanian Isthmus.

Placostylus extends from New Zealand to Fiji and New Guinea, "giving testimony," as Pilsbry remarks, "to the former existence of an Antarctic land connecting the austral continents of the two hemispheres." (Man. Conch., Index, vols. 10-14, 1902, p. ix.)

The Buprestidæ, a family of large and handsome beetles, exhibit a striking affinity between Australia and South America; so much so that, opposed as Wallace was to the Antarctic connection, he here conceded that some exchange between the two areas was required. He thought that it took the form of larvæ in floating timber drifting round the Antarctic seas in a warm period.

Among early Tertiary vegetation brought from Seymour Island in the Antarctic by Dr. Nordenskjöld's expedition, Dusén has recognized a species of *Fagus* and an *Araucaria* like *A. brasiliensis*. (Schwedische Sudpolar. Exp., Bd. III, Lief 3, 1908.) In the light of this discovery the range of the living species of these genera acquires an importance for the student of the Antarctic hypothesis. The distribution of the beech trees is a particularly interesting one, for on the principle of Antarctic extension it is simple and intelligible, but without it is complicated and inexplicable.

This genus *Fagus*, *sensu lato*, has two representatives in Europe, one in North America, and several in China and Japan. But in South America there are 11, in New Zealand 7, and in Tasmania with Australia 3. The northern forms are deciduous, but with one or two exceptions the southern are evergreen. The genus being a natural one is certainly not of polyphyletic origin, and the question before us is, from what center of migration has it spread? Did the southern species radiate from the south or converge from the north? It is a strong argument for a southern origin that the bulk of the species are southern. Again, the evergreen state is primitive, the deciduous derived, and this indicates that the northerners are offshoots from an evergreen stock. Thirdly, the southern species more closely resemble each other than any northern does any southern form. Even, as Mr. Rodway (Proc. Austr. Assoc. Adv. Sci., 1912) points out, the same parasite afflicts Tasmanian and South American trees. This agrees better with radiation from the south than with convergence from the north.

Another aspect of Antarctic distribution is presented by the genus *Araucaria*. None of the 15 existing species reach the Northern Hemisphere, so the complication of a boreal factor is absent. It is chiefly subtropical and characterizes a zone external to that of *Fagus*. In South America there are three species, in New Caledonia eight, in Norfolk Island one, in New Guinea one, and in Australia two. The latter pair are unlike each other, but one, *A. bidwilli*, from Queensland, stands very close to the Chilean *A. imbricata*. This indicates that the genus had already differentiated almost to its present

extreme before the migration route between Australia and South America had closed. The large and heavy seeds of these trees possess no floating power and are unfitted for dispersal by birds. As Dr. Guppy remarks of the Fijian Kauri pine, "they may well be cited in support of any continental hypothesis." (Guppy, "Naturalist in the Pacific," vol. 2, 1906, p. 301.)

The preponderance of *Araucaria* in the Pacific is enforced by a related genus *Agathis*. If statistics carry a meaning, *Fagus* would seem to have come to Australasia from America, while *Araucaria* made the reverse journey.

The remarkable and well-known genus *Fuchsia* includes 69 species. Four of these are natives of New Zealand, the rest inhabit South America, Mexico, and the West Indies. These figures are almost exactly reversed for the shrubby evergreen *Veronicas*, plants conspicuous in any New Zealand landscape, totally absent from Australia or Tasmania, and represented by a few stragglers in South America and Fuegia.

4. DEDUCTIONS.

If it be resolved that the community of austral life is explicable only by former radiation along land routes from the south polar regions, we reach a position to probe deeper into the intricacies of the problem.

In the scheme propounded by Dr. H. O. Forbes, the austral forms inhabited one vast continent, nearly a third of the Southern Hemisphere, at the same (? Pleistocene) time. But an analysis of the fauna in question shows that some groups avoid Tasmania and others avoid New Zealand. Clearly the Antarctica that supplied Australia with an abundant fauna of marsupials, monotremes, snakes, frogs, and so on, was not in touch with New Zealand, where these animals are conspicuously absent. Benham has emphasized the fact that the *Acanthrodrilids*, Antarctic earthworms, failed to reach Tasmania. When they, the *fuschias* and other associates, spread backward and forward from New Zealand to South America, it is equally clear that the road to Tasmania was barred to them. Iredale remarks (*Proc. Malac. Soc.*, vol. 9, 1910, p. 160) that the Antarctic element in the New Zealand Polyplacophora, a marine molluscan group, is distinct from that which reached Tasmania from the south. The differences are both positive and negative, and are not due merely to the more southern latitude of New Zealand preserving a larger proportion of cold types. When circumstances allowed *Iguanidæ* to wander from South America in two genera to Madagascar and in another to Fiji, the Australian road was apparently closed to them.

It becomes increasingly apparent that the Antarctic source of austral life was not simple but compound. This complexity has

probably been the chief hindrance to its recognition. The problem before us is, Was the complexity that of time or space, or both?

Shall we suppose, for instance, that at the close of a glacial period an Antarctic continent bare of life received a fauna and flora from one neighbor, then developed and transmitted it to another; that a subsequent glaciation swept all life away from the polar area; that a warm interglacial period succeeded when another transfer, but between different neighbors, took place? So that the fauna of New Zealand might represent the life of one interglacial Antarctic phase and that of Australia another.

Or shall we consider that Tertiary Antarctica was an archipelago, the islands of which carried such different fauna and flora that emigrants from one quarter differed from those of another. It is not yet known whether the area between King Edward VII Land and Graham Land is a lobe of the continent or an archipelago, or an independent island. (Darwin, Proc. Roy. Soc. A., vol. 84, 1910, p. 420; and Mawson, Geogr. Journ., vol. 37, 1911, map, p. 613.) In the latter case it is possible that King Edward VII Land may have joined New Zealand, while Tasmania was separately linked to South Victoria Land. Under these circumstances New Zealand and Tasmania may have simultaneously imported an Antarctic and yet a different fauna and flora.

Or both conditions of interglacial succession and insularity may have combined in the past to produce present effects.

Prof. H. Pilsbry has shown (Proc. Acad. Nat. Sci. Philad., 1900, p. 568) that the land molluscan faunas of the Marquesas, Hawaii, and Society Islands are closely related, and that though of primitive type they are harmonic such as befits continental land, not a drift selection such as oceanic islands have. He proposes them as witness to the existence of a Paleozoic or early Mesozoic land mass. The tree lobelias also testify to the antiquity and association of these distant Pacific archipelagoes. (Guppy, "A Naturalist in the Pacific," vol. 2, 1906, p. 250.) Their relations are with the alpine floras of South America and equatorial Africa. A third of the mountain flora of Hawaii is derived from high southern latitudes. It is now suggested that these primitive continental plants and animals reflect a meridional Pacific land ray, the first visible vestige of Antarctic extension, as Tasmania was the last. To carry a cold flora across the Equator the land must have been lofty and continuous. In such a range some might see the rib of a former tetrahedral world.

As the Eocene was both a warm period and a time when land was largely developed in the Patagonian area, it is likely that the Archiplatan fauna then or earlier entered Antarctica. If the Tasmanian fossil *Wynyardia* is rightly dated Eocene, then during that age some at least of the American migrants reached Australia.

Whereas New Zealand in its relation with South America, via Antarctica, appears both as a giver and a receiver, Australia, on the contrary, seems to have made no return to South America, but to have received all and given nothing.¹ No Eucalypts, for instance, crossed from Tasmania to Patagonia. One explanation may be that Australia was then too poor to afford emigrants. Another and more probable explanation is that Antarctica, having received a fauna and flora from Archiplata, was severed from it before joining Australia. Thus a stream of migration would be forced forward and checked backwards.

The austral fauna and flora appears extending in successive zones from the far south to the Tropics. In New Zealand the warmth-loving plants and animals, such as the Kauri pine (a relation of *Araucaria*) and *Placostylus* snail, have been thrust to a northern refuge, while diminished temperature has probably exterminated others. The *Araucaria* and iguanas, the fresh-water fish *Osteoglossum*, are examples of tropical austral forms of which a long list could be compiled.

It is unlikely that the Antarctica that bore this tropical and subtropical assembly reached much more broadly to the Tropics than does the present continent. Had it done so, more traces would have been left of such extension in the South Sea Islands on the one side or in South Africa on the other.

But if the subtropical flora and fauna had in the Tertiary extended unbroken across the pole from Fuegia to Tasmania, what then became of the ancestors of the present subantarctic and south alpine life? Why were not these frigid forms driven from off the face of the earth when the heart of the Antarctic itself enjoyed a genial climate?

The discovery by Sir E. Shackleton of a plateau 10,000 feet high near the South Pole suggests a solution of the difficulty. If such a plateau existed when the climate was at its warmest, then the tropical migrants could have found a congenial climate on the coast, while the ancestors of the Kosciusko and Kerguelen plants and animals took refuge on the plateau heights. The inference is that such a plateau did then exist.

If the land connection between the Antarctic and Tasmania had broken down during the warmest period of the interglacial phase, it would have isolated the flora and fauna at a time when the cold elements were gathered together on the central plateau heights, while the temperate and subtropical elements possessed the Antarctic periphery. In that case the cold forms would have had no oppor-

¹ Ortmann (Proc. Am. Philos. Soc., xli, 1902, p. 340) considers that the fresh-water crustacea *Parastacidae* spread from Australia into Antarctica and thence into Chili. But the distribution of this group in Australia as detailed by G. Smith (Proc. Zool. Soc., 1912, p. 149) appears to me to be that of immigrants from an east and west base. respectively.

tunity to escape to the alpine stations of New Zealand or Australia, or to occupy the subantarctic islands.

The conclusion is therefore drawn that the land link was maintained during the period of refrigeration, and that from the Antarctic focus first the subtropical, then the temperate, lastly the alpine forms were expelled, each to gain a fresh footing in lower latitudes.

Possibly associated with the formation of great ice masses, a paroxysm of diastrophic energy ensued. This, which perhaps has not yet subsided, effected the destruction of the antarctic bridge, and to it may be due the recent disarticulation of the Dominion of New Zealand and the severance of Tasmania from its parent continent.

In the long perspective of past time Antarctica appears to fade and form like a summer cloud, now extending a limb, now shedding it, now resolving into a continent, now dissolving into an archipelago. At present it lies dead and cold under its white winding-sheet of snow. By the light of the magician's lamp we watch the summer of the cycles dawn. The glow of life returns, the ice mask melts, green spreads a mantle. At last a vision comes of rippling brooks, of singing birds, of blossoming flowers, and of forest glades in the heart of Antarctica.

THE ANTS AND THEIR GUESTS.¹

By P. E. WASMANN, S. J.,

Ignatius College, Valkenburg, Holland.

[With 10 plates.]

One hundred years of biological investigation of ants have passed since, in 1810, the Genevan Peter Huber published his "Recherches sur les mœurs des Fourmis indigènes." Therefore, since we celebrate this year a centenary of ant biology, let us first briefly review the development of myrmecology. Its character is a truly international one, in that investigators of the most distinct countries and nations have participated in it.

The *classification* of ants, already founded by Latreille, received a new impetus through Gustave Mayr about the middle of the previous century. Toward its completion August Forel, Carlo Emery, Ernest André, W. M. Wheeler, Ruzsky, Santschi, and others have distinguished themselves, so that we now know more than 5,000 species and subspecies, living and fossil, in this family. The *anatomy* of ants has been greatly advanced through the older works of Meinert, Forel, etc., and particularly through the numerous publications of Charles Janet. Recently one has turned also to the microscopic study of the development of the polar bodies within the eggs of ants. However, that which interests us most here is the development of bionomics, the knowledge of the behavior of ants.

The work of the father of biological ant study, Peter Huber, has been successfully continued by August Forel and later by Rudolf Brun in Switzerland, by Carlo Emery in Italy, by Sir John Lubbock (Lord Avebury) and recently by Horace Donisthorpe in England, by Gottfried Adlerz in Sweden, by Ernest André, H. Piéron, and most especially by Charles Janet in France, in North America by McCook, later on by Miss A. Fielde, Miss Buckingham, and through numerous important works by William Morton Wheeler, in Tunisia by F. Santschi, in Algeria by V. Cornetz, in Russia by Karawaiew, in Japan by M. Yano, in Brazil by H. v. Ihering, E. Goeldi, and G. Huber, in Germany by Viehmeyer, Escherich, and Reichensperger, in Belgium

¹ Translated by permission from 1^{er} Congrès International d'Entomologie, Bruxelles (August, 1910) Mémoires, vol. 2, pp. 209-232. With emendations and additions by the author.

by de Lannoy and Bondroit, etc. The names of those investigators who have especially distinguished themselves in separate branches of ant bionomics—the knowledge of the relation of ants to their guests, the study of the mode of foundation of the ant colonies, the development of social parasitism and of slavery, the investigations of the fungus gardens of the leaf-cutting ants, the construction of the nests of the highly interesting weaver ants, who use their larvæ as weaver's shuttles, etc.—are much too numerous to make their separate mention possible in this brief space.

Through its rapid progress in all directions the modern study of ants has become on the one hand such a richly developed and richly ramified special science that it is no longer possible for the individual investigator to master the entire field. Division of labor, therefore, more and more took place, particularly also in the investigation of the myrmecophilous Arthropoda, which demands the collaboration of specialists in the most distinct classes and orders of arthropods.

On the other hand the bionomic science of ants, particularly, has stepped forth from the confines of a special science. Comparative psychology has in an increased measure turned its attention toward the psychological valuation of ant activities. The theory of descent has found among the ant guests a multitude of interesting proofs for the formation of new species, genera, and families of insects through adaptation to a myrmecophilous life. It has also found in the hypothetical phylogeny of social parasitism and of slavery among the ants one of the most instructive examples for the development of instinct. Social science has even made the attempt to find in the ant communities the prototypes for human social customs. But by all means it must be considered here that the ants, in spite of the great analogy which shows itself between many activities of their social instincts and human intellectual acts, are not miniature human beings. Scientific ant study has long ago withdrawn from the romanticism of humanization and sees in the wonderful accomplishments of the little ant brain instinctive activities, which, however, within certain limits, are plastically modifiable through sensory experiences of the individual. Science can therefore neither accept the ants as mere reflex machines nor as intellectual miniature humans. The truth with regard to the psychology of ants lies rather midway between these two extremes.

For lack of time I must unfortunately deny myself a more detailed development of all these highly interesting relations of ant biology, and must limit myself to placing before you, with the help of stereopticon pictures,¹ some especially fascinating main points in the life of the ants and of their guests.

¹ Of the 40 photographic lantern slides of the lecture only a part is here reproduced.

1.—ORGANIZATION OF THE ANT SOCIETIES.

The simple ant colony represents a family in the narrower or wider sense. It comprises one or more generations of the descendants of one or more females of the same species of ant. The tribal mother is the fertilized queen, who has founded the colony. The descendants are in part wingless forms of the female sex, the so-called workers, in part young winged males and females, and in part also others, still young, though already fertilized and deſalated, queens. The worker cast may again divide itself into different forms, namely, into true workers and into soldiers, which latter are distinguished from the workers by the prodigious structure of their heads or mandibles. Soldiers occur among our Palearctic ants only in a few genera (*Colobopsis*, *Cataglyphis*, *Pheidole*). The workers themselves can again divide into large and small individuals, of which the former are sometimes, as for example in *Camponotus*, veritable giants in comparison with the latter. This dimorphism is much further developed still in exotic genera, like *Pheidologethon*. In some species of ants there are found at the side of the winged females, which shed their wings only after pairing, wingless true females as well, the so-called ergatoid queens. A typical example of these, which was already known to Peter Huber, is offered by the amazon ant (*Polyergus rufescens*) (compare fig. 8a).¹ In the tropical legionary and driver ants (*Eciton* and *Dorylus*) even wingless females alone occur, and moreover of relatively enormous size. In some species of ants there is even a manyfold pleomorphism of the females which finds expression in different transitions between females and workers. Much rarer are the wingless, and then mostly workerlike (ergatoid) males; they are known in but few species of ants, and occur either along with the normal winged males or as the only male form. An example of the last kind is shown in the shining guest ant, *Formicoxenus nitidulus* (fig. 1), where the males, on account of their great similarity to the workers, remained unnoticed 38 years, until Adlerz discovered them in 1884.

With many species of ants one can find several queens together in the same colony. With our hill ant, *Formica rufa*, their number in a single nest may even reach toward 100. Furthermore, an ant colony may possess several nests, which are simultaneously or alternately inhabited. So-called seasonal nests, which are changed according to the time of year, have been observed, for example, in *Formica sanguinea* and *Prenolepis longicornis*. By the plurality of queens in a single colony the ant states differ strikingly from the states of the honey bees. The latter bear by comparison more a monarchical, the former a republican character, since the queen with the ants forms

¹The figures 1 to 33 are arranged on plates 1 to 10.

the center of the instinctive activities to a much less degree than with the bees. The greater individual autonomy of the ant workers, in comparison with those of the bees, rests perhaps in large measure on their greater longevity, which in the *Formica* species is generally 3 years. The duration of life of the queens may even exceed 12 years.

Polymorphism forms, it is true, the organic basis of the ant societies, establishing division of labor between the members of the same colony. But the evolution of the organic-psychic potentialities slumbering within the egg results through the nursing instincts on the part of the workers. What is intended to be a male or a female appears, similarly as with the bees, to be already determined in advance within the egg.¹ But upon the differentiation of the various forms of the female sex nursing has a determining influence. From the fertilized eggs of one and the same *Formica* queen there may be reared either winged females or wingless workers or intermediate forms. Particularly those mixed forms designated as pseudogynes, which we shall find to be an effect of the *Lomechusa*-breeding, offer proof of this explanation.

2. SOCIAL PARASITISM AND SLAVERY AMONG THE ANTS.

If the population of an ants' nest belongs to a single species of ant it is called a simple (unmixed) colony. If, however, it is composed of different species of ants, we speak, according to Forel's example, either of compound nests or of mixed colonies; in the former the ants only live side by side; in the latter they combine into a single household with common care of the young. These are the two subdivisions into which the social symbiosis between ants of different species divides. We shall here only give our attention to the mixed colonies, and moreover with particular regard to the development of social parasitism and of slavery. This is one of the most interesting chapters in the phylogenetic development of instincts in the animal kingdom.

Peter Huber had already discovered that in the colonies of the sanguine ants (*Formica sanguinea*) and of the Amazon ants (*Polyergus rufescens*) there live in addition to the master species the workers of a slave species, which are robbed as pupæ by the former from the nests of the slave species and are then reared as auxiliary ants. These are, therefore, slavemaking (dulotic) colonies. But there are still other mixed colonies in which the auxiliary ants do not get into association with the master species through capture; these range among the social parasites. Since Charles Darwin (1859) diverse hypotheses on the origin of slavery have been proposed. Recently, by employing the phenomena of social parasitism for comparison,

¹ That not only males but also workers originate from parthogenetic eggs (Reichenbach, Comstock, etc., in *Lasius*, Tanner in *Atta*), is in any case a rare exception.

some light at least has been shed upon this interesting problem. All investigators agree that the phylogenetic history of social parasitism and of slavery in ants does not represent a simple line of development, but a number of different, parallel lines independent of each other. But upon the closer relations between social parasitism and slavery the views deviate from each other. You will therefore excuse it if here I follow only briefly my own train of thought, as I have explained it more fully in the *Biologisches Centralblatt*, 1909.¹

Let us begin with the dependent foundation of colonies and its relation to social parasitism and to slavery in *Formica*. The original method here also—as with ants in general—must have been the independent foundation of colonies, as, for example, we find it to-day in the *fusca* group. Here the females (fig. 5a), after the marriage flight, are able to found their new colonies independently; that is, without the help of the workers. How have social parasitism and slavery arisen from this root? The first step probably consisted in the transition to an acervicolous life in the workers, through which the colonies became richer in individuals and could control a larger area surrounding their hills, as we see it in the *rufa* group. Thereby, however, the opportunity was offered to the females to found their new settlements with the help of workers of their own species. As a second step in the parasitic and dulotic direction then followed, through this same means, in the females of the *rufa* group, that they abandoned the independent foundation of colonies and became dependent upon the assistance of workers, therefore passing over to the dependent foundation of colonies. It is in any case a remarkable phenomenon that all parasitic forms of *Formica*, of the Old World as well as of the New, are acervicolous and belong to the *rufa* group or stand in nearest relationship to it. The latter is also true for the dulotic *sanguinea* group, which is connected with the *rufa* group by morphological transitions. In the *rufa* group we have, furthermore, biological transitions from the facultative mode of social parasitism to the obligatory. *Formica rufa* (fig. 2) and *F. pratensis* found their colonies mostly with the assistance of workers of their own species, only facultatively with strange auxiliary ants (*F. fusca*, fig. 4b). With *Formica truncicola* (fig. 3), *F. exsecta* (fig. 4a and 5b), and *F. pressilabris* in Europe, as well as with *Formica consocians* and a series of other North American forms discovered by Wheeler, the latter mode of colony foundation is already obligatory.

With several North American parasitic *Formicas* described by Wheeler, as well as in our *Formica exsecta* (fig. 5b) and *F. pressilabris*, the small size of the females is striking and already represents a further step in the advance to parasitic adaptation, while for example

¹ Ueber den Ursprung des sozialen Parasitismus, der Sklaverei und der Myrmecophilie bei den Ameisen.

in *Formica rufa*, *F. pratensis*, and *F. exsectoides* the females are very large and do not yet show any trace of parasitic modifications. All the *Formica* species just mentioned, whose females either facultatively or obligatorily found their colonies with the aid of the workers of an alien species of auxiliary ant, form only temporarily mixed colonies. After the death of the original auxiliary ants—about three years after their foundation—these colonies again become simple, unmixed ant colonies and as such may still continue to increase for decades. Permanently mixed colonies we find, on the contrary, with the dulotic *Formica* species, which, after the dying off of the original auxiliary ants, procure new ones for themselves by the capture of pupæ. How do these forms link with the preceding and especially with a *rufa*-like initial stage of social parasitism?

When with a large strong acervicolous species of *Formica*, which had already passed over from the independent to the dependent foundation of colonies, a change occurs in the mode of nutrition of the workers, conditioned by climatic changes,¹ so that it lives more and more exclusively by preying upon insects and furthermore particularly upon the pupæ of strange ants, then the basis is offered for the origin of slavery; for provision is already made, through the dependent foundation of these colonies, that among the captured strange pupæ precisely those of the auxiliary species shall be reared. Even *Formica truncicola* and *F. exsecta*, which in nature are not slave makers, in those of their colonies which have again become simple retain the inclination to rear the worker pupæ of the species of their former auxiliary ant, if they are given them in artificial nests, while they devour the pupæ of other alien species or at least kill the workers emerging from them. The origin of slavery in a *Formica* form like *F. sanguinea* (fig. 6) depends, then, upon two agents: (1) Upon the dependent foundations of colonies by their females with the assistance of a strange species of ant; (2) upon the inclinations of their workers to capture strange pupæ as prey. According to this view the hypothetical origin of slave making within the genus *Formica* is thus to be followed back to a common root with the origin of social parasitism within the same genus, namely, to an incipient stage of dependent foundation of colonies which is to some degree comparable to the present state of *F. rufa*. In any case, the inclination to prey upon pupæ does not in itself suffice to explain the origin of dulosis in *Formica* or in any other genus of ants; for there are many species of ants, especially in the subfamily Dorylinæ, which pillage the pupæ of strange ants and notwithstanding do not rear slaves from them, because precisely the first of the two above-named agents, the dependent foundation of their colonies by means of an

¹ How the change of a forest climate to a prairie climate can offer this occasion, I have shown especially for *Formica sanguinea*.

auxiliary species, is absent. Hence, the main question in the explanation of slavery is not: Why does this species of ant in question capture strange pupæ as prey? but: Why does it rear auxiliaries from them? This second question remains also unsolved if one (with Emery and Viehmeyer) attempts to derive dulosis directly out of a "primitive predatory female state," for which, moreover, any supporting facts are wanting; for, as Emery has himself first shown (1909), the present-day parasitic and dulotic ants are to be phylogenetically derived from their present-day auxiliary ants; there, however, we find nowhere such primitive predaceous females, but indeed manifold conditions of dependence in the foundation of colonies by one species upon those of another species. Let it be, moreover, expressly remarked that the hypothesis of the origin of dulosis in *Formica* can not be simply extended to the other dulotic genera of ants; for example, among the myrmicines. Other reciprocal relations, also, than those of facultative social parasitism, may there have led to the origin of slave making (*Harpagoxenus-Leptothorax*). In any case, the origin of slavery can not be explained through the accidental survival of captured ant pupæ within a strange nest (Ch. Darwin).

Probably starting from a *sanguinea*-like state, and linked phylogenetically with the development of dulosis within the genus *Formica*, the genus *Polyergus* represents the culmination of the slave-making instinct within the subfamily of Camponotini. If we compare the mandibular structure of the European amazon ant (*Polyergus rufescens*) with that of our *Formica sanguinea* (fig. 7), a remarkable difference is shown. *Formica sanguinea* (fig. 7a) has normal triangular mandibles with a toothed inner margin ("Kaurand"); *Polyergus*, on the contrary (fig. 7b) has narrow, sharply pointed sickle-mandibles. In these morphological distinctions the difference in the dulotic instinct of the two is also expressed: *Formica sanguinea* is at a more primitive stage of the development of that instinct; and it is even developed to a different extent in the different North American races of this species, as Wheeler has particularly shown. *F. sanguinea* keeps comparatively few slaves, can even dispense with them entirely, and is not dependent upon them. The amazon ant, on the contrary, in its European and in its North American races, stands at the apex of dulosis, exists only by the capture of slaves and in that connection develops the most brilliant warrior talent that we know in the entire animal kingdom. Its mandibles are modified to be solely weapons for killing and are unsuited for domestic occupations; furthermore it has even lost the instinct of feeding by itself and must be fed out of the mouths of its slaves. The excessive development of dulosis is here already connected with distinct characteristics of parasitic degeneration. Its mandibular structure gives expression to both sides, the light and the shadow of its organic and

psychic development. The frequent appearance of a wingless female form, so-called ergatoid queens (fig. 8a), points, furthermore, toward the beginning of inbreeding, although the normal female form is still always more numerous than the ergatoid.

With the genus *Polyergus* the development of dulosis within the subfamily of Camponotinae is concluded. Let us therefore now turn to the Myrmicinae. An entirely isolated position is occupied by the European and North American genus *Harpagoxenus* (*Tomognathus*). Very likely it is to be phylogenetically derived from the genus of its auxiliary ant *Leptothorax*; the males are hardly distinguished from those of the latter. The European *Harpagoxenus sublaevis* (fig. 9a), which formerly was considered to be a strictly boreal form, has also been found in Saxony by Viehmeyer; he also there discovered winged, normal females, besides the already known ergatoid female form (fig. 9a), which appears to be the only one in Scandinavia. Probably *Harpagoxenus* originally arose through a mutation of female forms in a parent species belonging to *Leptothorax*. This does not exclude the possibility that it later may have lived in compound nests together with its present-day auxiliary ant (*Wasmann* and Viehmeyer), before it arrived at dulosis.

Another line of development of the slavery instinct among the myrmicines is formed by the genus *Strongylognathus*, which probably must be derived from the genus of its auxiliary ant *Tetramorium*. The southern species of this Mediterranean genus are still powerful and populous slave raiders, which are able to procure the pupæ of the species of their auxiliaries (*Tetramorium cæspitum*) by force. The northern species, *Strongylognathus testaceus* (fig. 10), which occurs in middle Europe as far as Holland, has, on the contrary, passed over to permanent social parasitism in that its colonies harbor, besides the workers, also a female of *Tetramorium*, which is furnished them by the new auxiliaries. The workers of *Strongylognathus testaceus* no longer undertake slave raids; they are likewise too small and too few in numbers for this purpose. Probably it was the northern climatic conditions which in this case externally caused the change from dulosis to permanent social parasitism; for when a southern slave-capturing ant penetrates northward, its slave raids, the execution of which is restricted to a certain optimum temperature, become constantly rarer and finally cease altogether. In *Strongylognathus testaceus*, in connection herewith, the size and the number of worker individuals, have also sunk considerably, all indications of a parasitic degeneration of the species. The sabre-shaped jaws of this small ant are, as it were, no longer more than phylogenetic mementoes of its brilliant dulotic past. The previous history of the genus *Strongylognathus* up to that stage where the southern slave-making species still stand to-day, is just as problematical as the future further devel-

opment of social parasitism in the northern species; we can only supplement both conjecturally, the former through comparison with *Polyergus* among the camponotines, the latter through comparison with the workerless parasitic ants, to which we will now pass on.

When with a formerly dulotic species like *Strongylognathus testaceus*, parasitic degeneration proceeds further, its own worker form will finally become completely extinct and will be replaced by that of the auxiliary ant, so that the one-time master species continues to exist only as males and females. We know a considerable number of such workerless parasitic ants from the palearctic and nearctic regions, recently also one from the East Indies (*Wheeleriella Wroughtoni* For.). One of the palearctic species, *Wheeleriella Santschii* (fig. 11), has been discovered in Tunisia by Santschi within the colonies of *Monomorium salomonis* and possesses, as also the North American genera *Epoecus*, *Symphoidole*, and *Epipheidole*, winged, still fairly normal, sexual forms. Upon the lowest level of degeneration, however, stands our little, black parasitic ant *Anergates atratulus*, living with *Tetramorium*, and whose males (fig. 12) are pupa-like, and the fertilized females of which, to impede the extinction of the species by their fertility, have developed an enormous physogastry. But for none of these workerless parasitic ants can we prove with certainty that their parasitism has sprung from a former dulosis. There are still three other ways which theoretically lead to the same goal, namely: The further development of a former temporary parasitism, the parasitic degeneration of a former guest relation, and finally the relatively sudden (mutation-like) appearance of a new dimorphism in the female (and later also in the male) of the former parent form and present auxiliary species. In those cases where, for example as in *Symphoidole*, *Epipheidole*, and *Epixenus*, the parasitic genus is very similar to the sexual forms of the host genus, the last explanation should even be the most probable. This is also verified through the discovery in Portugal of a new parasitic Pheidole species, *Ph. symbiotica*, whose males and ergatoid females live in the nests of *Pheidole pallidula*. In the latter cases we have to assume a relatively rapid origin of the workerless parasitic species, as this has probably never (since its separation from the parent species) possessed a worker form of its own, and therefore also needed no time to "lose" it. In other cases, however, where the parasitic ant departs very widely from its present auxiliary species and presumably former parent species, there was probably a longer course of development necessary, connected with a real dying out of its own worker form. This applies, for example, to *Anergates atratulus*, for which genus we can only conjecturally assume *Tetramorium* as parent form, and for which it is not at all so unlikely that it sprang from a former dulotic form by an intermediate stage similar to that of

the present-day *Strongylognathus testaceus*—the more so as *Strongylognathus* lives with *Tetramorium* and is to be derived from this same genus. But in the meantime more than conjectures are not at our command for the phyletic history of *Anergates*.

The investigations hitherto made concerning the hypothetical phyletic past of social parasitism and of slavery have in any case led to the recognition that this history forms only an ideal unit, but in reality is composed of a multitude of really distinct lines of development, which, in different genera and species in the different subfamilies of ants, have begun at different times and up to the present have progressed to different points. The more we succeed, by means of new observations and experiments, in establishing these separate lines of origin, the more we will also proceed in our general knowledge of phylogenetic connection between parasitism and slavery among the ants. Just as in the morphologico-paleontological domain, so also here a true enrichment of our knowledge is not to be expected from general theoretical reflections, but from critical detailed investigations.

3.—TRUE MYRMECOPHILY (SYMPHILY).

While the living together of ants of different species comes under the concept of social symbiosis, their association with nonsocial animals, particularly with other arthropods, is designated as individual symbiosis. Therefore we are to deal here with the so-called ant guests or myrmecophiles from other families or orders of insects and of the remaining arthropods. The number of normal ant guests in 1894 already amounted to about 1,200; to-day we may estimate them at more than 2,000. Their relations to the ants are very various and may be divided into five main classes, which, however, are connected by many transitions. We distinguish symphiles or true guests, *synœketes* or indifferently tolerated tenants, *synechthrans* or actively pursued tenants; furthermore parasites (ento- and ectoparasites), and finally trophobionts or food-producing animals of the ants. I shall here only briefly enter into the first of these classes, because we shall afterwards become acquainted with many an interesting staphylinid in connection with the legionary ants, and particularly for the reason that Mr. Donisthorpe is to deliver a lecture on the indigenous ant guests.

The true ant guests (symphiles) are hospitably cared for by the ants on account of certain exudations, which are volatile products of the fatty tissues (in the *Lomechusini*) or of adipoid glandular tissues (*Clavigerinæ*, *Paussidæ*, etc.), while with the physogastric termite guests the blood tissue is the principal exudating tissue. The external exudatory organs are very diversely developed; yellow hair tufts, dermal pores, dermal cavities, etc., at which the hosts lick

their guests. The exudations of the true guests, as, for example, the saccharin containing secretions of the aphids, do not appear to be a food for the ants, but only an agreeable stimulant.

Among the myrmecophilous Coleoptera there are three principal groups which are prominent on account of their true guest relation to the ants: The Lomechusini among the Staphylinidæ, the Clavigerinæ among the Pselaphidæ, and finally among the Paussidæ by far the majority of the genera from Pleuropterus to Paussus. The remaining symphiles among the Coleoptera I do not mention here.

a. The true guest relation is most highly developed with the Lomechusini, in so far as these beetles are not only licked by their hosts (first step), but also are fed regularly from their mouths (second step), and finally also the larvæ of these beetles are reared by the ants like their own brood (third step). The largest representative of the Lomechusini is the European *Lomechusa strumosa* (fig. 13), which lives with *Formica sanguinea* as its single host and also has its larvæ (fig. 14) reared there. These latter, although they possess six legs, imitate in their attitude the immovable larvæ of the ants and are fed by their hosts like the ant larvæ, indeed even far more eagerly than these. Beyond this, however, they feed themselves, particularly in earliest youth, from the eggs and young larvæ of the ants and devour them in large numbers; on this account they are in fact the worst enemies of their hosts. The species of the genus *Atemeles* are not, like *Lomechusa*, restricted to a single host, but regularly have two hosts. During autumn and winter the beetles live with the little red ant, *Myrmica*, and then in the spring, at the time of propagation, pass over to *Formica*, where they have their larvæ reared; and furthermore every *Atemeles* species or race has a definite *Formica* species or race as larval host. The double host relation of *Atemeles* postulates a much higher degree of initiative of these beetles toward the ants than we find with *Lomechusa*. The *Atemeles*, by "active mimicry," imitate the behavior of the ants to a high degree, particularly in demanding to be fed (fig. 15). The damage which their larvæ inflict on the *Formica* brood is similar to that of *Lomechusa*. In North America the Lomechusini are represented by the genus *Xenodusa* (fig. 16), the species of which have a double host relation, like *Atemeles*, but with *Camponotus* as second host in place of *Myrmica*. Their larvæ are reared with *Formica* at the expense of the brood of the ant, as in the above genera.

How seriously the *Formica* species are harmed by the larvæ of the Lomechusini is also shown by the fact that through their continued rearing the normal brood-nursing instinct of the ants is pathologically altered—namely, in place of true females they rear malformed individuals, intermediate between workers and females, the so-called pseudogynes, which are perfectly useless for the ant

community. They are worker-like forms with inflated humped female mesonotum. The rearing of pseudogynes occurs most frequently with our *Formica sanguinea* (fig. 17, *a* worker, *b* pseudogyne), which rear the larvæ of the single-hosted *Lomechusa strumosa*. Here, too, I was able to prove by the statistical method the connection between the rearing of the adopted larvæ and the formation of pseudogynes. The rearing of the larvæ of *Atemeles* and *Xenodusa* leads to the origin of pseudogynes less frequently because these beetles, in consequence of their double host relation, do not always get back into the same individual *Formica* colonies in which they have themselves been reared. Through the increase of pseudogynes within a nest the destruction of the host colony is finally brought about. Therefore the avowedly so "intelligent" *Formica* in fact actually rear, in the larvæ of the *Lomechusini*, their worst enemies.

When, however, we follow the phylogenetic development of symphily, in which amical selection, that is, the instinctive selection practiced by the ants toward their guests, plays a large rôle, we must even say: In the *Lomechusini* the ants have brought up for themselves their worst enemies! To enter more closely into the psychological and phylogenetic phases of this interesting problem here the short time unfortunately prohibits.

b. The relations of the club-horned beetles (*Clavigerinæ*) to the ants are much more harmless. The beetles are eagerly licked by their hosts and fed from their mouths, but do no harm to the ant brood, although they sometimes gnaw at diseased or wounded larvæ. We already know, principally through Raffray's works, 40 genera of *Clavigerinæ* with far above 100 species. The habits of our little yellow *Claviger testaceus* have become very well known since 1818, and yet the larvæ of all the *Clavigerinæ* are still undiscovered. A picture of the adaptational characters of these beetles is offered by the gigantic club-horned beetle, 4 mm. in length, from Madagascar, *Miroclaviger cervicornis* (fig. 18), which, besides a large abdominal cavity, shows richly-developed yellow tufts of hairs on different parts of the body.

c. The beetle family *Paussidæ*, which is so rich in diversity of form, is very fruitful for the study of myrmecophilous adaptation, but here can be treated only very briefly. Already in the Oligocene of the Baltic amber we find six genera, of which three (*Pleuropterus*, *Paussoides* and *Paussus*) probably at that time already belonged with the true ant-guests, while two others (*Arthropterus* and *Cerapterus*) in their representatives of our time still show the primitive protective type. Among the present-day genera we already find symphilous characters in *Pleuropterus* (fig. 19), in spite of the still 10-jointed antennæ, in that the cavities of the pronotum and of the bases of the elytra serve as exudatory organs. With the further development of symphily in

the Paussidæ there is remarkable a progressive reduction in the number of antennal joints. At the highest step, in Paussus, the antennæ are only 2-jointed and the antennal club assumes the most diverse forms,¹ among which the conch shape stands in the most intimate association with symphily. A fine example of this is offered by *Paussus howa* (fig. 20) from Madagascar, which lives with *Ischnomyrmex Swammerdami*. Within the interior of the conch-shaped antennal cup there lies a great layer of glandular cells, as it is shown in the accompanying section of the antennæ of *Paussus cucullatus* (fig. 21). But also beneath the frontal pores, beneath the pronotal pits and in the pygideal region there is found adipoid glandular tissue in large extent, and with many Paussus the symphylous trichome structures (reddish yellow hair tufts, etc.) are also richly developed in the most diverse manner and on the most diverse parts of the body.² In spite of the high development of their exudatory organs, the Paussus, as far as is at present known, are only licked by the ants, not fed from their mouths; they live rather predatorily upon the ant brood. The larvæ of Paussus (of *P. Kannegieteri*), described for the first time with certainty by Böving, are likewise carnivorous, although their physogastry and the glandular tissues at the tip of their abdomen point surely enough to an incidental true guest relation.

4.—MEANS OF PROCURING FOOD AMONG THE ANTS.

The means employed by the ants to procure food are more diversified and offer more analogies with human business activities than we find anywhere else in the animal kingdom. For many of our native ants the principal source of food is the keeping of "cattle," that is, the occupation with plant lice and scale insects, which in part they visit outside the nest and partly keep within their nests, and which they induce to give off their saccharine excrements by stroking them with the antennæ ("milking"). The honey-secreting caterpillars of some butterflies, too, particularly from the family Lyce-nidæ, are used similarly by native and tropical ants as "cattle," and also tropical Homoptera larvæ furnish a rich contingent for this purpose. Certain native ants (for example, *Lasius flavus*) even keep the eggs of the plant lice within their nests during the winter. Furthermore, within six different genera of different parts of the globe there are honey ants which feed up a worker cast into living "honey pots," from whose crops, in times of drought, the colony procures its food. The classical example, already described by McCook, is the honey ant of the Garden of the Gods in Colorado (*Myrmeco-*

¹ Species with lenticuliform antennal club, like *P. arabicus* and *P. Favieri*, according to Escherich's observations, stand on a lower plane of symphily than *P. turcius*, which has a conch-shaped antennal club.

² On the exudatory organs and exudatory tissues of the Paussidæ see "Zur näheren Kenntniss des echten Gastverhältnisses" (Biol. Centralbl., 1903) and "Modern biology and the theory of evolution (London, 1910), p. 364 ff.

cystus hortideorum). Other ants, again, are harvesters, who collect supplies of seeds and store them away in the granaries of their nests. For over 100 years the account in the Holy Bible of the harvesting ants of Palestine was supposed to be a fable, until, through the observations on the genus *Messor* in the Mediterranean region, it was gloriously verified. Recently Neger has even found that *Messor barbarus* works the seeds over into a kind of ant bread. The classical "agricultural ants" of North America belong to the genus *Pogonomyrmex*, and, although the exaggerated romanticism of the "agriculture" of *Pog. barbatus* has been destroyed by Wheeler's critical investigations, yet the habits of these harvesters are still very interesting. Even greater interest has been excited by the fungus growing ants, particularly since the researches of Möller (1893). The habits of the American leaf-cutting ants, from the group of *Attini*, has been thereby placed in a new light, especially since, through the observations of v. Ihering, E. Goeldi, and particularly Jacob Huber (1905), we are also informed regarding the ingenious manner in which the queen of *Atta sexdens* starts and cultivates the new fungus garden, when, after her marriage flight, she founds her new colony. That in this apparently highly intelligent "cultivation of vegetables" by the ants we are dealing with an hereditary instinct, is verified moreover through the analogy with the fungus growing of the termites, among whom this custom, particularly in the large genus *Termes*, is still more widely prevalent, although the termites stand psychically below the ants. A dainty fungus garden, of the size of a walnut, from the nest of a small guest termite (*Microtermes globicola*), which lives in the hills of *Termes Redemanni* in Ceylon, is shown in the accompanying enlarged illustration (fig. 22). Many other ants, finally, live by the hunt, particularly for insects. With our large heap-building hill ants (*Formica rufa* and *F. pratensis*) this means of gaining a livelihood is truly enough only secondary in comparison with the visits to plant lice and scale insects. In any case it is important enough to place these and other acervicolous species of *Formica* of the *rufa* and *exsecta* groups as eminently "useful" under the protection of forestry laws. The sanguine robber ant (*Formica sanguinea*) even occupies herself almost exclusively with hunting, and leaves the cultivation of plant lice to her slaves.

But the carnivorous hunting ants are far more numerous among the tropical and subtropical species, among the *Ponerinæ* (*Lobopelta*, etc.), and most particularly among the *Dorylinæ*.

5.—THE DORYLINÆ AND THEIR GUESTS.

The subfamily of *Dorylinæ* comprises the hunting ants, which, partly above ground and partly subterraneanly, go about in quest

of prey and therefore are mostly restless wandering ants. They are the scourge of the host of lesser animal life in the tropics. They lack composite (reticulate) eyes; in their place there are simple ocelli, which, however, are frequently rudimentary or disappear altogether. When these are well developed, as for example in *Eciton Burchelli*, they can even distinguish colors, as follows from the comparison of the coloration of their guests.¹ Nevertheless the dorylines, on account of their raids, depend upon touch and smell to a still higher degree than the other ants. Most of the *Eciton* of the Neotropical region, legionary ants, undertake their hunting expeditions, already mentioned by Rengger, Belt, and Bates, in great armies above ground; likewise the *Anomma* of Africa, already observed by Smeathman, which carry on their hunting drives for all small animals in frequently gigantic armies, on which account they have been given the name "driver ants." *Anomma* is a subgenus of *Dorylus*, the species of which, on account of carrying on their hunts above ground, are mostly dark colored, but whose pale colored allies (*Dorylus*, *sensu stricto*), as well as those of the genus *Ænictus*, hunt subterraneanly. The trimorphism of the worker form of *Anomma Wilverthi* is to be seen from figure 23. To be sure it is connected by intermediate forms. The smallest worker form, on account of the reduced number of antennal joints, might be taken, if one found it alone, for a different genus. As well with *Anomma* as with *Eciton* two kinds of armies are to be distinguished, foraging armies and emigrating armies. Only with the latter are the gigantic, entirely wingless females and the likewise very large, often de-alated males carried along; with *Anomma* they are transported across open expanses only within covered tunnels. In emigrating to a new hunting region a new nest is occupied (Vosseler in East Africa and Luja on the lower Congo), which for weeks serves as a base for the foraging expeditions. That these nests contain a fauna of guests,² principally beetles, which live from the prey of their hosts, can estrange but little. But that these ants are accompanied on their hunting expeditions by a host of guests, particularly of the family of short-winged beetles (*Staphylinidæ*), is the more remarkable, as one would suppose that the hunters would at the start seize upon this readily available game. And yet the *Eciton* of America as well as the *Anomma-Dorylus* of Africa possess the largest number of guests of all tropical ants!

The theory of descent to some extent explains this riddle. The greater the necessity for adaptation in relation to a certain enemy is, the greater will also be—supposing the capability for adaptation,

¹ Die psychischen Fähigkeiten der Ameisen, 2 ed., 1909, Chapter VI.

² The guests of the nest of *Anomma Wilverthi*, which E. Luja has found in several nests near Kondue, are still to be described.

which in the Staphylinidæ is a very extensive one—the frequency and the height of adaptation. From this is to be understood, not only the large number of doryline guests among the Staphylinidæ—up to now about 40 genera have been described—but the high degree of adaptation, as well, which many of them show.

Three principal morphologico-biological adaptational types meet us here: The symphile type, the mimicry type, and the protective type. The first makes the guests agreeable to their hosts through exudations, the second simulates to them their own kind, the third makes them unassailable to the mandibles of the ants. These three types of adaptation occur also with other myrmecophiles, but their development with the guests of the foraging ants is a peculiar one, corresponding to the character of the hosts; and besides it is a very similar one in the neotropical Eciton guests to that in the African Anomma guests, although the genera which represent these types in the two hemispheres do not stand in any closer systematic relationship to each other. Their similarity therefore rests upon convergence as the result of similar conditions for adaptation.

The principal representative of the symphile type of the Anomma guests of Africa is *Sympolemon anommatis*, the “war companion of the driver ants” (fig. 24). The slender form of its body is conditioned by its manner of locomotion as companion of its rapidly running host. It moves even more rapidly than these, in that it uses its abdomen as a propelling spring, to shoot ahead with the speed of an arrow, as an observer (F. Hermann Kohl) expresses himself. Series of sections of the abdomen disclosed to me the mechanism of this propelling spring. We see in the sagittal section how the chitinous hoops project into the lumen of the abdomen and serve as surface of attachment for strong bundles of muscles (See fig. 25). On the long legs the feet (tarsi) are rudimentary and transformed into slipper-like, densely hairy structures, which serve partly as clasping organs, but partly also represent an analogy to the plumed feet of the prairie fowl (*Syrnhaptes*). Among the Brazilian Eciton guests *Ecitogaster* is most similar to *Sympolemon* in form of body and structure of antennæ. Also, the structure of the tongue of both indicates that these guests are fed from the mouths of their hosts.

Most remarkable is the mimicry type of the doryline guests. It is primarily a “tactile mimicry” which appears to be calculated to deceive, passively and actively, the tactile sense of the antennæ of their hosts.

The passive deception is brought about by the similarity of form of the separate body segments of the guest with those of the host, the active deception through the similarity of antennal structure between guest and host. This mimicry reaches its highest degree in *Mimeciton* (fig. 26) among the ecitophilous Staphylinidæ and with

Dorylomimus (fig. 27) and especially with *Mimanomma* (fig. 27a) among the anommatophiles. In these genera no legitimate similarity of coloration between guest and host exists, because the latter possess only rudimentary ocelli (*Eciton prædator*) or have no eyes whatever (*Anomma Wilverthi* and *A. Sjöstedi*). In the guests of such *Eciton*, however, as have well-developed ocelli there is furthermore added to the tactile mimicry a very exact similarity of coloration of the guest with the same size worker-form of the host, for example in *Ecitophya* (fig. 28), *Ecitomorpha*, and *Ecitonidia*.

At the highest stage of the mimicry type, in *Mimanomma*, *Mimeciton*, *Dorylomimus* and *Ecitophya*, mimicry even forms the foundation for a true guest relation; this has even been established by direct observation for *Dorylomimus Kohli* (F. Kohl).

An analogous tactile mimicry to that with the ecitophilous Staphylinidæ is found also among the ecitophilous Proctotrypidæ (Hymenoptera) in the genera *Mimopria* and *Ecitopria*.

The protective type of the New World *Eciton* guests is represented principally by the genus *Xenocephalus* (fig. 29), in which the head and the extremities are covered by a protecting roof. Among the Old World doryline guests we meet an analogous, but less perfect, protective type in *Pygostenus* and related genera. The highest development of the protective type of dorylophilous Staphylinidæ, however, is reached in the genus *Trilobitideus* (fig. 30), standing entirely isolated,¹ and of which several species live with *Dorylus* and *Anomma*; a flat, leaflike form of body fitting closely to the ground, which is furthermore covered with conical humps on the upper surface. When a foraging ant seeks to grasp this guest with her mandibles she can only seize him at one of the humps and at the most hurl him away, if her mandibles do not at once glance off. The insect, in which not even elytra are present, resembles rather a silphid larva than a full-grown beetle. Unfortunately we must here be content with these few examples from the extraordinarily rich field of the adaptational characters of the doryline guests.

6.—NEST BUILDING AMONG THE ANTS.

An ants' nest is an irregular system of passages and chambers, which serve as the home of the ants and their brood; it is no highly finished structure like the bee comb, and on that account is of no rigid pattern, but capable of an almost unlimited adaptability to the most diverse materials and locations. Beginning with the minute hollow in the earth or crack in the bark, measuring but a few millimeters, to the large domes of our hill ants and the still more extensive nests of some of the large *Atta* of America, we find all

¹ Quite recently a new genus, *Phyllodinarda*, found with *Anomma* in Kamerun, has proven the affinity of *Trilobitideus* with the Aleocharinæ.

transitions in the size of an ants' nest. Likewise there is hardly a location where ants can not establish their nest, hardly a material of which it can not consist. Through Forel and other investigators the exceeding diversity in the manner of nest construction among the ants has been long known. There are distinguished, earth nests, nests under stones, earth heaps above ground, heaps of dry plant material mixed more or less with earth; nests under bark, in hollow galls, in hollow stalks, and hollow trees; nests in rotten stumps or chiseled out of solid wood; carton nests, which are either placed between roots or in hollow trees or hang free from the branches; finally web nests, which may consist of leaves spun together or of other hollows carpeted on the inside with a web. Furthermore, any already existing hollow space may be transformed into an ants' nest, should it be a piece of roofing paper, the cover of a tin of preserves, dried cow manure, or an old skull of a horse, in which last P. Schupp once found a nest of *Camponotus rufipes* in Rio Grande do Sul. Also numerous are the stolen nests which formerly belonged to other species of ants or to termites and were either taken possession of after having been vacated by the builders or already before that.

The photograph of a gigantic nest of *Formica rufa*, near Luxemburg, which is 17 meters in circumference, may serve as an example of a typical ant hill (fig. 31). A carton nest of *Cremastogaster Stadelmanni dolichocephala* Santschi, 1.10 meters in length, which is in the Natural History Museum of Luxemburg, is shown in figure 32, as it was photographed in its natural situation, hanging upon a high tree in Kondué, by E. Luja. Finally, a web-nest of *Polyrhachis laboriosa* from Kondué (E. Luja) is shown in figure 33. This consists of leaves spun together, the surfaces of which are carpeted with web. The upper outer layer, into which wood-mold has been abundantly introduced, appears to be prepared by the ants, as according to F. Kohl's observations is also the case with *Oecophylla longinoda* on the upper Congo, by means of their mandibles and the secretion of the mandibular glands, while the web itself comes from another source with which we shall now become acquainted.

These web nests of the ants are of high psychological interest.

For the spinning substance utilized in them does not come from the ants themselves, but from their larvæ which the workers grasp with their mouths and employ as "weaver's shuttle"! They conduct the mouth of the larva, from which the spinning substance issues, from one leaf margin to another and thus weave their nest. When 20 years ago Ridley's first information concerning this reached Europe from the East Indies, it sounded hardly credible. Now, however, they have been concordantly verified by many investigators, for *Oecophylla smaragdina* in Ceylon through Doflein and Bugnion, for *Oecophylla longinoda* on the Congo through F. Kohl, etc. With the

Oecophylla species this method of nest construction is general, in the genus *Polyrhachis* it only pertains to a part of the species, while others construct carton nests. Of the genus *Camponotus*, finally, it is only known of one species, *C. senex* of Brazil, and of the genus *Technomyrmex* we likewise know spun nests with but a single species (*T. bicolor textor* Forel).

That ants use their own larvæ as weaver's shuttle for spinning, and so utilize the spinning faculty of their larvæ in a practical manner for nest construction, is, to be sure, psychologically most remarkable. It is an employment of "tools" which are independent of the body of the animal and do not originate from it, while, for example, the web with which the spider catches its prey is a product of the glands of its own body. Such a well guaranteed and ingenious employment of tools, as the ants demonstrate in the construction of their web nests, we seek in vain elsewhere in free nature, even among the higher vertebrates. Yet we must not overestimate this fact psychologically. There are here concerned, as with all other specific modes of nest construction in ants, hereditary instincts, over the phylogenetic origin of which, however, the deepest darkness still rests. In any case we must not consider a species of *Polyrhachis* which constructs webs by means of its larvæ as more "intelligent" than another species of the same genus which employs the secretion of its mandibular glands to build a carton nest. In the same way we must not designate *Camponotus senex* as the "most intelligent" species of its genus because it builds web nests, while other species construct theirs in wood, etc. All the different nest-building instincts are objectively appropriate in their way, but do not depend upon the intelligent reflection of the individual being, because they prove to be hereditary instincts. Their exercise is, nevertheless, no mere reflex mechanism, because it takes place under the influence of the sensory perceptions and sensory experiences of the individual. Here, too, we must therefore keep ourselves midway between two equally erroneous extremes in the psychological explanation of animal life. Then we also shall "learn wisdom" from the ants on considering their ways.

EXPLANATION OF FIGURES ON PLATES 1-10.

[The micro-photographs for the most part have been taken with a Zeiss Tessar 1:6, 3.]

PLATE 1.

- FIG. 1. *Formicoxenus nitidulus* Nyl. (shining guest-ant), ergatoid male and worker (8 : 1).
 FIG. 2. *Formica rufa* L. (red hill-ant), queen and small worker (3 : 1).
 FIG. 3. *Formica truncicola* Nyl., winged female (4 : 1).
 FIG. 4. a. Worker of *Formica exsecta* Nyl.,
 b. Worker of *Formica fusca* L. (4 : 1).
 FIG. 6. *Formica sanguinea* Latr., worker (3, 5 : 1).

PLATE 2.

- FIG. 5. *a.* *Formica fusca* L., small queen;
b. *Formica exsecta* Nyl., winged female (4 : 1).
 FIG. 7. *a.* Head of *Formica sanguinea* Ltr., worker;
b. Head of *Polyergus rufescens* Ltr., worker (6 : 1).
 FIG. 8. *Polyergus rufescens* Latr. (Amazon ant): *a.* Ergatoid queen; *b.* Worker (4 : 1).

PLATE 3.

- FIG. 9. *a.* *Harpagoxenus (Tomognathus) sublaevis* Nyl., ergatoid queen;
b. *Leptothorax acervorum* F., worker (slave) (5 : 1).
 FIG. 10. *Strongylognathus testaceus* Schenk, worker (12 : 1).
 FIG. 11. *Wheeleriella Santschii* Forel, winged female, dorsal and lateral view (5 : 1).
 FIG. 12. *Anergates atratulus* Schenk, pupa-like male (12 : 1).
 FIG. 14. Larva of *Lomechusa strumosa* F. (5 : 1).

PLATE 4.

- FIG. 13. *Lomechusa strumosa* F. (5 : 1):
a. With turned up abdomen;
b. With extended abdomen, to show the yellow hair-tufts.
 FIG. 15. *Atemeles pratensis* Wasm. being fed by *Formica pratensis* Deg. (6 : 1).
 FIG. 16. *Xenodusa cava* Lec. (North America) (5 : 1).
 FIG. 17. *a.* *Formica sanguinea* Ltr., worker (4 : 1).

PLATE 5.

- FIG. 17*b.* *Formica sanguinea* Ltr. (Pseudogyne) (4 : 1).
 FIG. 18. *Miroclaviger cervicornis* Wasm., Madagascar (12 : 1).
 FIG. 19. *Pleuropterus Dohrni* Rits. subsp. *Lujae* Wasm., Congo (5 : 1).
 FIG. 20. *Paussus howa* Dohrn Madagascar (5 : 1).

PLATE 6.

- FIG. 21. Section through the layer of glandular cells of the antennal cup of *Paussus cucullatus* Westw. (1000 : 1). (Zeiss, Apochrom. 2.0, 1.30, compensational ocular 4.)
 FIG. 22. Fungus garden of *Microtermes globicola* Wasm., Ceylon (1, 5 : 1).

PLATE 7.

- FIG. 23. *Anomma Wilverthi* Em., three workers from the same army (3 : 1), Congo.
 FIG. 24. *Symplolemon anommatis* Wasm., Congo (6 : 1).
 FIG. 25. Sagittal section through the abdomen of *Symplolemon anommatis*, to show the bundles of muscles (20 : 1).

PLATE 8.

- FIG. 26. *Mimeciton pulex* Wasm., male and female, Brazil (10 : 1).
 FIG. 27. *Dorylomimus Kohli* Wasm., Congo (8 : 1).
 FIG. 27*a.* *Mimanomma spectrum* Wasm., Kamerun (9 : 1).
 FIG. 28. *Ecitophya simulans* Wasm., Brazil (4 : 1).
 FIG. 29. *Xenocephalus gigas* Wasm., Brazil (4 : 1).
 FIG. 30. *Trilobitideus insignis* Wasm., Congo (11 : 1).

PLATE 9.

- FIG. 31. Gigantic nest of *Formica rufa* L., Luxemburg (17 m. circumference).

PLATE 10.

- FIG. 32. Carton nest of *Cremastogaster Stadelmanni* subsp. *dolichocephala* Santschi (hanging on the tree), Congo (1 : 44).
 FIG. 33. Web nest of *Polyrhachis laboriosa* Sm., Congo (1 : 2).

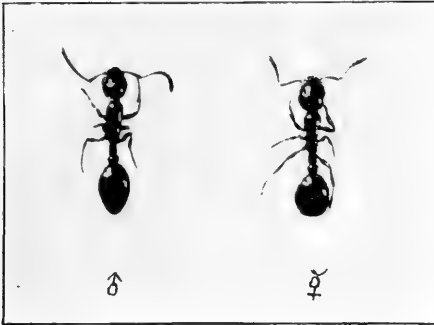

1

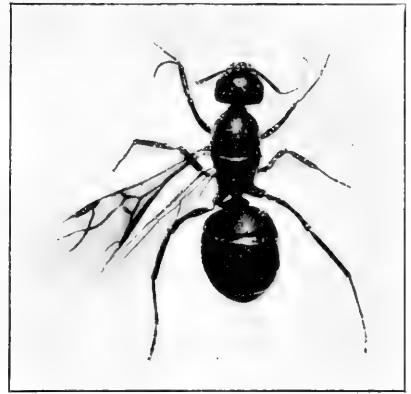

3

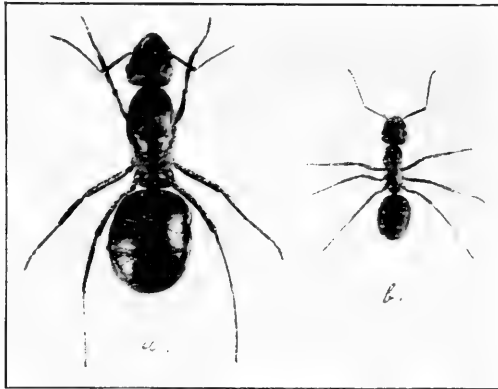

2

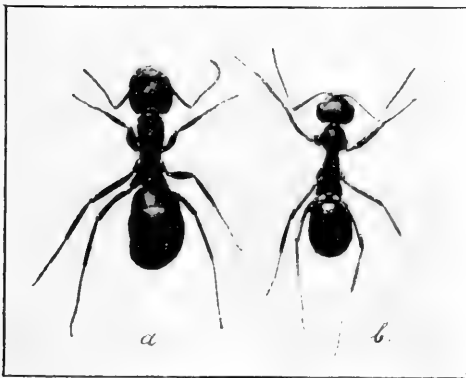

4



6

Fig. 1. —*Formicocercus nitidulus* Nyl. (shining guest-ant), ergatoid male and worker (8:1).
 Fig. 3.—*Formica truncicola* Nyl., winged female (4:1).
 Fig. 2.—*Formica rufa* L. (red hill ant), queen and small worker (3:1).
 Fig. 4.—a, Worker of *Formica exsecta* Nyl.; b, Worker of *Formica fusca* L. (4:1).
 Fig. 6.—*Formica sanguinea* Latr., worker (3.5:1).

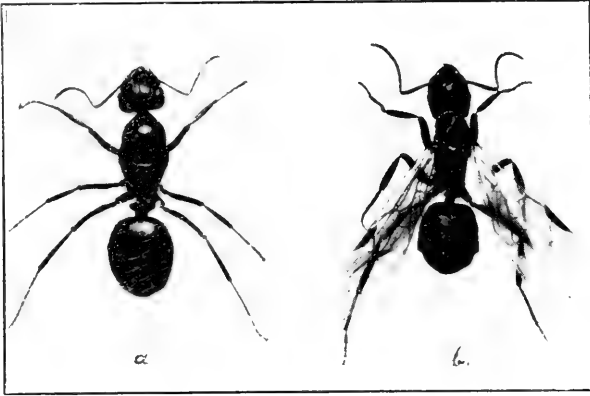

5

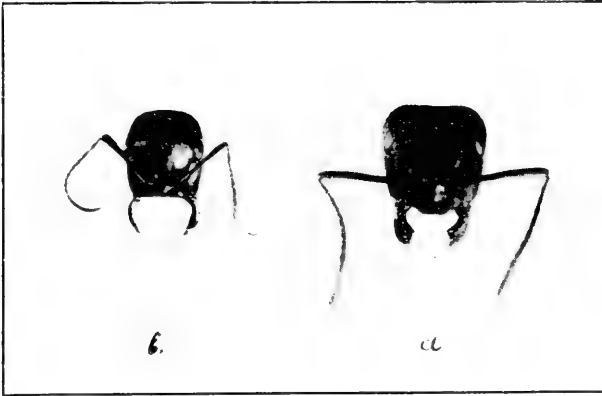

7

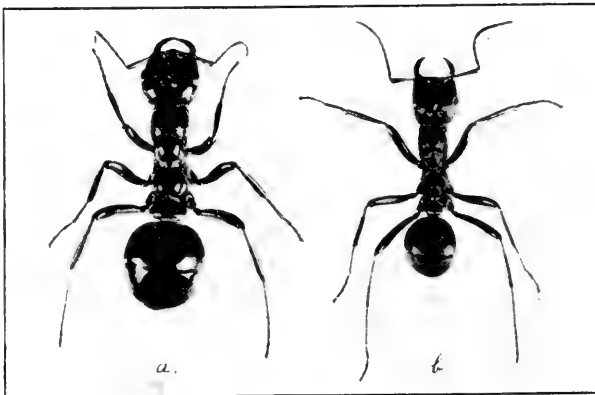

8

Fig. 5.—*a.* *Formica fusca* L., small queen; *b.* *Formica cesceta* Nyl., winged female (4:1).
 Fig. 7.—*a.* Head of *Formica sanguinea* Ltr., worker; *b.* Head of *Polyergus rufescens* Ltr., worker
 (6:1).
 Fig. 8.—*Polyergus rufescens* Ltr. (Amazon ant): *a.* Ergatoid queen; *b.* Worker (4:1).



9



10



11



12



14

Fig. 9.—*a*. *Harpagoxenus* (*Tomognathus*) *sublaevis* Ny1, ergatoid queen; *b*. *Leptothorax acropygus* F., worker (slave) (5:1).
 Fig. 10.—*Stranglophomyia testaceus* Schenk, worker (12:1).
 Fig. 11.—*Wheelerella Sanschii* Forel, winged female, dorsal and lateral view (5:1).
 Fig. 12.—*Auripiles atrotubus* Schenk, pupa-like male (12:1).
 Fig. 14.—Larva of *Tomochusa strimosa* F. (5:1).



13

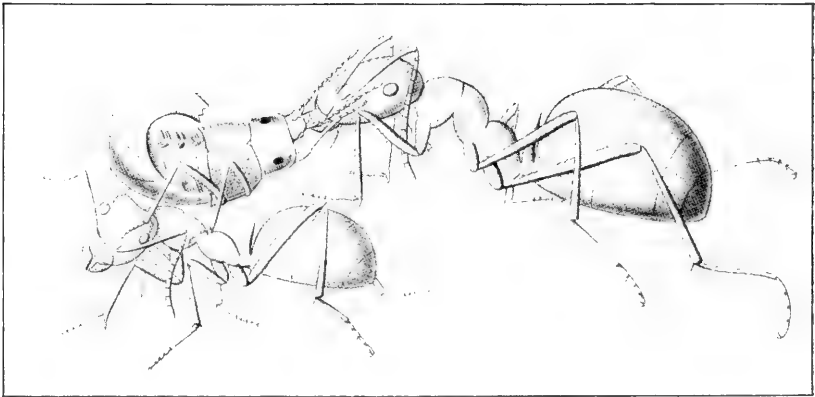

15



16



17

Fig. 13.—*Leucoloma stratum* F. (5:1): *a.* With turned up abdomen; *b.* With extended abdomen, to show the yellow hair-tufts.
 Fig. 15.—*Methylis probovisoides* Wasm., being fed by *Formica peat-osis* Deg. (6:1).
 Fig. 16.—*Xenoloma cava* Lee, (North America) (5:1).
 Fig. 17.—*a.* *Formica sanguinea* Ltr. (worker) (4:1).



17



18



19



20

- FIG. 17. *b.* *Formica sanguinea* Ltr. (pseudogyne) (4:1).
FIG. 18. *Mecodactylus cervicaris* Wasm., Madagascar (12:1).
FIG. 19. *Phloeopterus Dohrn* Knts. subsp. *Lujae* Wasm., Congo (5:1).
FIG. 20. *Pseudoscorpion* Dohrn. Madagascar (5:1).



Fig. 21.—Section through the layer of glandular cells of the antennal cup of *Paussus cucullatus* Westw. (1000:1) (Zeiss, Apochrom. 2.0, 1.30, compensational ocular 4.)

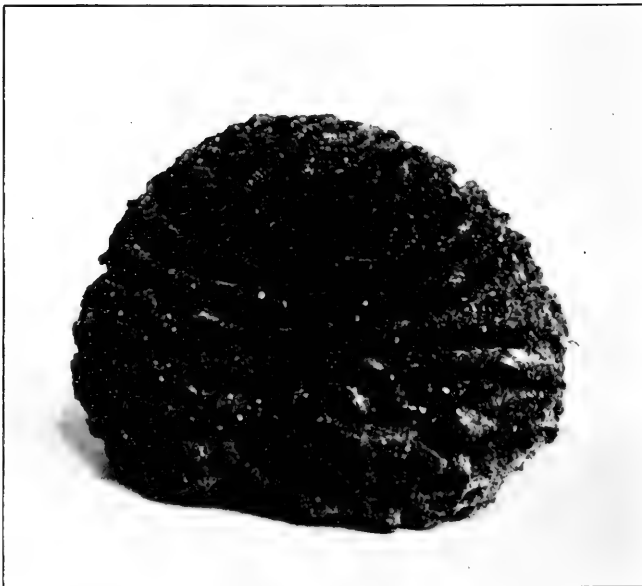
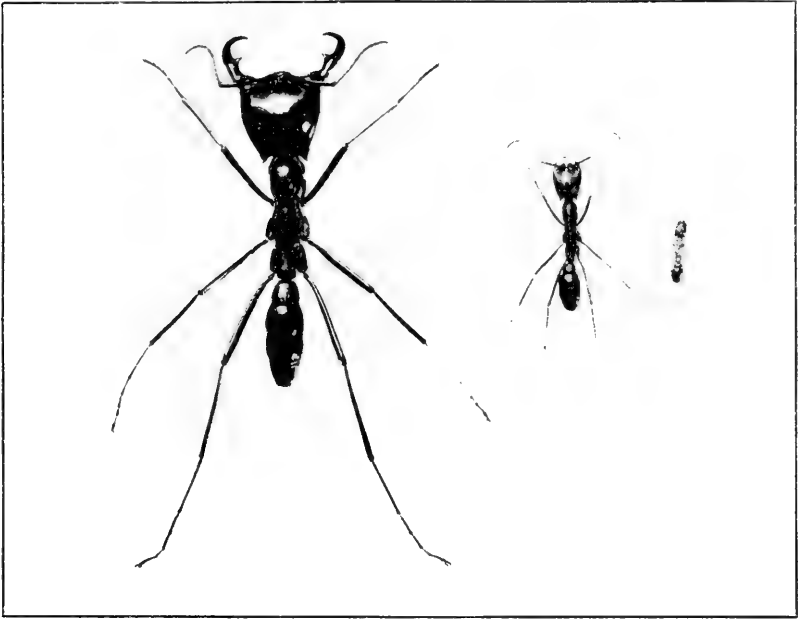
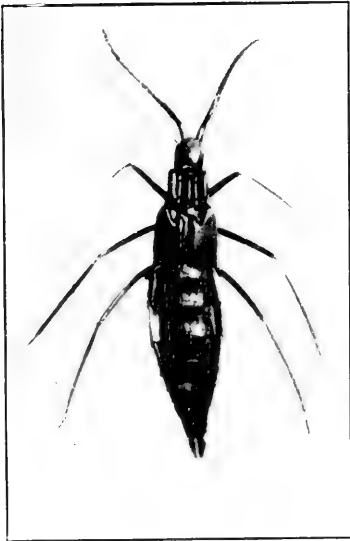

Fig. 22.—Fungus garden of *Microtermes globicola* Wasm., Ceylon (1.5:1).



23



24



25

Fig. 23.—*Anomma Wilkesi* Em., three workers from the same army (3:1), Congo.

Fig. 24.—*Symplocon anomalis* Wasm., Congo (6:1).

Fig. 25.—Sagittal section through the abdomen of *Symplocon anomalis*, to show the bundles of muscles (20:1).

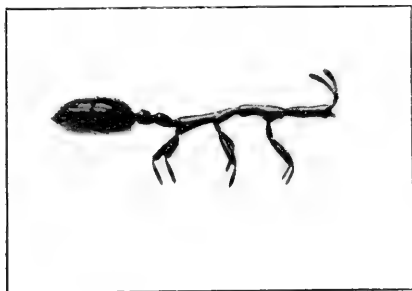

27a



28

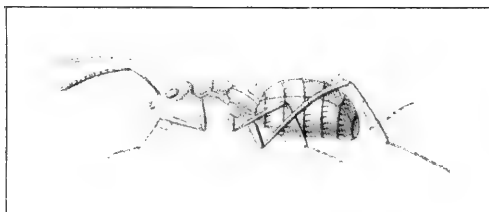

27



29



26

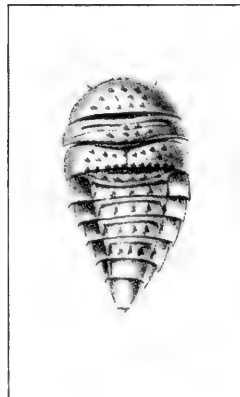

30

- Fig. 27a. *Minuomonna spectrum* Wasm., Kamerun (9:1).
 Fig. 28. *Echilophya simulans* Wasm., Brazil (4:1).
 Fig. 27. *Dorulomimus Kolli* Wasm., Congo (8:1).
 Fig. 29. *Xenocryptus gignis* Wasm., Brazil (4:1).
 Fig. 26. *Minuomonna pulchra* Wasm., male and female, Brazil (10:1).
 Fig. 30. *Tribolbitidus insularis* Wasm., Congo (11:1).

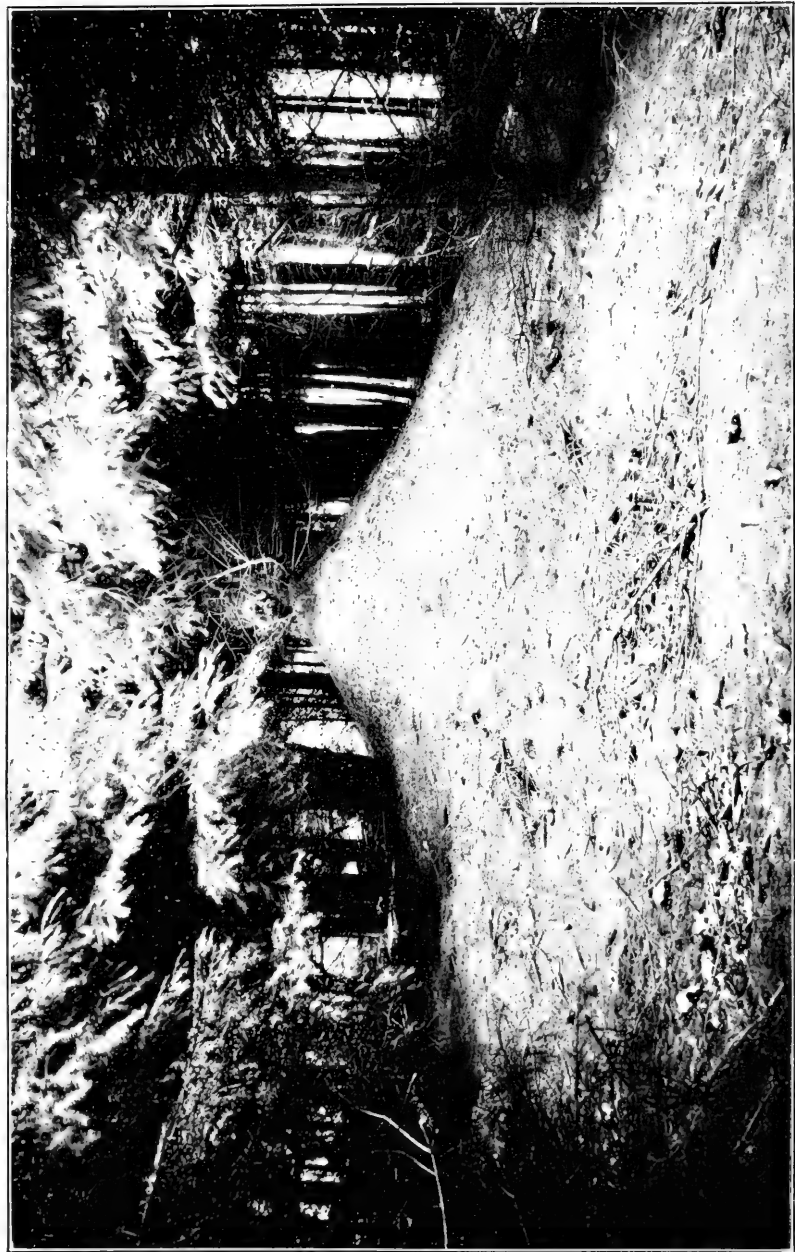

FIG. 31.—Giantlike nest of *Pompilus viciae* L., Luxembourg (17 m. circumference).



Fig. 32.—Carton nest of *Cremastogaster Stadlmanni* subsp. *dolichocephala* Santschi (hanging on the tree), Congo (1:41).



Fig. 33.—Web nest of *Polyrhachis laboriosa* Sm., Congo (1:2).

THE PENGUINS OF THE ANTARCTIC REGIONS.¹

By L. GAIN,

Doctor of Science, Naturalist of the Charcot Expedition.

[With 9 plates.]

Owing to the numerous scientific observations made since the close of the last century by various expeditions in the south polar regions certain vertebrate animals inhabiting those frozen lands are to-day well known.

Of the 36 species of birds met below 60° south latitude, there are 5 belonging to a single family, that of the Spheniscidæ, which particularly attract the attention of voyagers. We allude to the penguins.²

Penguins are the true inhabitants of these polar regions; from whatever direction one approaches the south, he is always sure to meet them. It is they that by their numerous rookeries, by their continual movement, and by their cries animate this land to which they bring life; it is they that relieve navigation in the polar regions from the monotony that it would finally have, if they were not there to strike between whiles a gay, lively note in the polar landscape.

These penguins differ widely from other birds. Their wings, without quills, provided only with little feathers that one might compare to scales, form mere paddles unfit for flight; plantigrades, they walk heavily, slowly, and when they wish to quicken their pace they fall flat on the ground, making their way through the snow by the aid of their feet and of their little wings, which also serve to balance them. Spending almost all their life in the sea, where they seek the crustaceans and small fish upon which they feed, they are wonderful swimmers, of an extraordinary suppleness and activity.

¹ Translated by permission (with additions by the author) from *La Nature*, Paris, No. 2041, July 6, 1912.

² This name was first given to them by the Spanish navigators of the seventeenth century; they called them *pinguinos*, from *pengüigo*, meaning *grease*, a name given them because of the abundance of fat with which these birds are covered.

One can not give a more exact idea of the penguin than by reprinting these few lines of M. Racovitzá, the eminent naturalist of the *Belgica* expedition:

Imagine a little old man, standing erect, provided with two broad paddles instead of arms, with a head small in comparison with the plump, stout body; imagine this creature with his back covered with a dark coat spotted with blue, tapering behind to a pointed tail that drags on the ground, and adorned in front with a glossy white breastplate. Have this creature walk on his two feet, and give him at the same time a droll little waddle and a continual movement of the head; you have before you something irresistibly attractive and comical.

Penguins have inhabited the Antarctic continent from very remote geological periods. We will only remind our readers of the discoveries of the Swedish expedition of Dr. Otto Nordenskjöld, who found on Seymour Island fossil bones belonging to five species, each of which formed the type of a new genus, and which lived, according to Dr. Wiman, who made a study of them, at the beginning of the Tertiary period, in the Eocene epoch.

At the present time, confining ourselves entirely to the birds found below 60° south latitude, five species inhabit these southern lands; among these five, two—the Emperor and the Adelie—are distributed over the whole circumference of the Antarctic continent; the other three are confined to the neighborhood of the South American Antarctic regions.

There is first of all the Macaroni penguin (*Catarrhactes chrysolophus*), of which some rookeries of a few hundred individuals are found on the South Shetland Islands, particularly on Deception Island. It has a height of 60 centimeters; the back and head are bluish-black with a velvety luster; above the eyes, bands of elongated eyebrows, golden-yellow, meet on the forehead; the iris is garnet, the beak reddish-brown with the commissure of the mandibles pale purple. It is a quiet, peaceful, trusting creature, letting itself be easily approached when on its nest, and even caressed, rarely trying to give a blow with beak or wing. The rookeries of these Macaroni penguins are often intermingled with those of the Antarctic penguin, with which they live on good terms. In their nest, which consists of a mere depression in the ground, they lay toward the end of November an egg of a slightly bluish-white, on which the parents sit alternately.

Of the five species of Antarctic penguins, *Catarrhactes chrysolophus* is the one that ventures the shortest distance southward, not going below 63° south latitude. Solitary individuals have been seen in the South Orkney Islands; farther north one finds them in South Georgia and even in the Falklands, and in the east on Prince Edward, Marion, Kerguelen, and Heard Islands.

The Antarctic penguin (*Pygoceles antarctica*), slightly smaller than the preceding, is easily distinguished from the other penguins by the



1

ANTARCTIC PENGUIN.



2

ADELIE PENGUIN.



3

EMPEROR PENGUIN
SALUTING.



4

GENTOO PENGUIN.

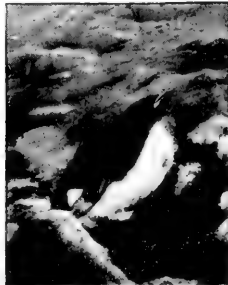

5

MARCONI PENGUIN.

black line across its throat. It is as noisy as the Macaroni is quiet, as pugnacious as the other is peaceful. It lives in huge rookeries that inclose sometimes as many as several hundred thousands of individuals. There are usually two eggs in each nest. When one penetrates into one of these cities, during the season of reproduction, he is immediately greeted by a deafening hubbub of discordant croaking, or of prolonged puffing accompanied by violence, blows from beak and wing, which makes one hesitate to enter into the midst of this hostile crowd.

The Antarctic penguins place their rookeries sometimes at a height of more than a hundred meters, and in order to reach the sea to seek the crustaceans of the genus *Euphausia* on which they live, they must often make a real journey; one sees them set off in little bands, in Indian file, following the paths that they have worn in the snow as a result of their incessant trips, and looking for the most favorable and least dangerous places along the cliff in order to descend to the shore.

On beaches accessible to rookeries, there is usually a host of birds gathered there by the thousand, reminding one of the throngs of human beings that are attracted on fine summer days to our great beaches in France. They chat little; simply a few reflections whispered in a low tone, while in the distance one hears the stir of the noisy city. In little troops the penguins take advantage of a momentary calm of the waves to throw themselves into the water and go hunting, while others are coming back from the open sea, uttering a joyous caw, caw, and seeking the most favorable spot for landing; heads rising from the water, a last dive, and the wave, rolling in and invading the beach, casts up the troops of penguins that are coming back from the fishing; then comes the climb up the cliff, the return to the rookery where they are to take their post as guardians of the nests and allow those who are awaiting them to set off in their turn for the sea.

Rookeries of this penguin are not found south of 65° latitude; one encounters them not only in South American Antarctic regions, but in South Georgia, the Falkland Islands, and Bouvet.

The third species inhabiting the Antarctic regions of South America is the Gentoo penguin (*Pygoscelis papua*), distinguished by the white spot above each eye and by its red beak. Its rookeries, less important than those of the Antarctic penguin, are situated to the north of the polar circle; in the circum-Antarctic zone it is found as far as the Falklands and toward the east up to Macquarie Island. Very different from the preceding species, these birds are much quieter, living in the greatest peace with one another; they receive visits from human beings with less protest, but with more uneasiness. Careful of their own appearance and of their rookery, their nests

are also better constructed, most frequently made of stones to which they add some tail feathers. In November they lay two eggs, white, slightly tinged with azure. Fond of family life, these penguins show great care in bringing up their offspring. If they are timid, careless, and awkward, they have at least one good quality—the tenderness they show toward their young.

Much more interesting is the Adelie penguin (*Pygoscelis adeliæ* Hombron and Jacquinot). Its head and back are black with bluish reflections, its short beak brownish-black, the pupil of the eye encircled with a white iris.

From whatever side one approaches the Antarctic, whether from south of America or from the longitude of Africa or of Australia, throughout the circumference of this vast polar continent, the Adelie penguin is always one of the animals encountered by the voyager on his route. This bird is everywhere, watches over everything; it is to him, indeed, that the Antarctic belongs. Curious, unruly, violent, a chatterbox and blusterer, of an extraordinary liveliness, you should see him dart like an arrow from the water to a height of more than 2 meters, and fall vertically down again on the piece of ice or the rock chosen for his resting place.

Never leaving these regions nor passing north of 60° south latitude, they people the isles of the frontier, the low elevations of the Antarctic continent, on which, during a few months of the year, the snow in melting leaves some clear spaces of soil.

On slightly uneven locations they settle in numerous colonies, during the period of breeding and raising their young, forming these noisy cities, these rookeries, which number thousands, often even tens of thousands, and sometimes even hundreds of thousands of individuals.

After having abandoned their rookeries for the winter, which they pass on the open sea, opposite the land ice, the Adelies return in October to their cities and immediately take possession of their rocks again. Indeed these rocks are really theirs, for according to the observations made on the spot at Petermann's Island, where the *Pourquoi Pas* wintered, I have ascertained, in the case of the Gentoo as well as of the Adelie, that the same birds come back to the same rookery year after year.

When the expedition arrived at Petermann's Island in February, 1909, I put on the right leg of several penguins (young and old) some celluloid rings of various colors, according to the age of the birds. In October and November, 1909, on the return of the birds to their rookeries I had the good fortune to recover a score of adults marked by me nine months before. I did not, however, recover any of the young, which seems to indicate that they do not return to their birth-place and do not mate until 2 years old.



1. MARCONI PENGUINS AT THE OPENING OF SPRINGTIME RETURNING TO THE OLD ROOKERIES.



2. CORNER OF A ROOKERY OF MARCONI PENGUINS.

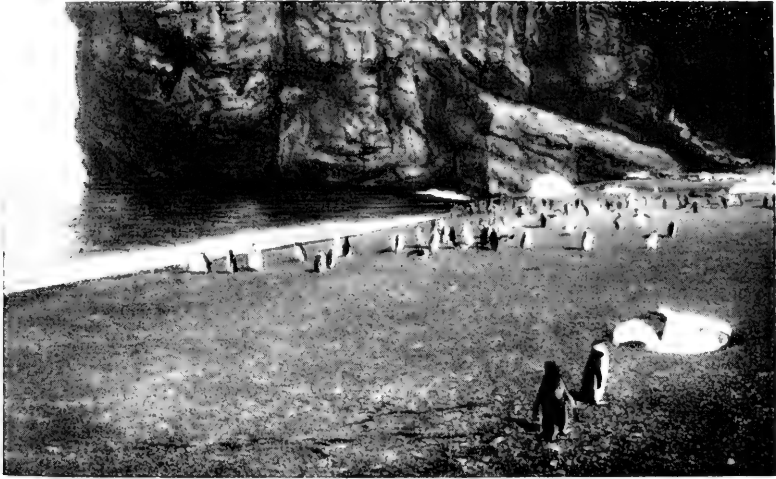

1. PENGUINS ON THE BEACH AT DECEPTION ISLAND.



2. CORNER OF AN ENORMOUS ROOKERY OF ANTARCTIC PENGUINS ON DECEPTION ISLAND (SOUTH SHETLANDS).

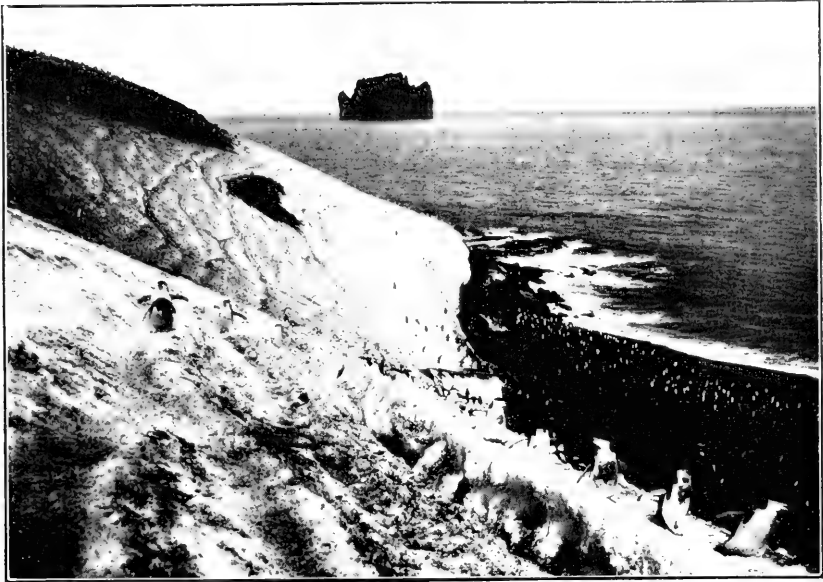

1. IN ORDER TO GO TO SEA THE ANTARCTIC PENGUINS MUST SOMETIMES MAKE A LONG JOURNEY TO FIND A POINT ALONG THE CLIFFS WHERE THEY CAN REACH THE BEACH.



2. THE FISHING DONE, SOME PENGUINS ARE RETURNING TO THE ROOKERY.

who attack, probably with pretty words, dares not decide too quickly. She is intimidated and these attacks of gallantry are generally ended by a regular battle between the suitors; but we can not say with certainty whether the victor in the contest inevitably becomes the husband of the lady Adelie.

What confusion in these cities of the Adelie; how many quarrels over stolen pebbles and property rights; how many battles, too, started by jealous husbands! And all this occurs on ground wet with melting snow, stained with mud the color of wine dregs.

The Adelies lay two, very rarely three, eggs. They are slightly greenish-white; their weight varies between 125 and 135 grams. The laying begins in the first days of November and ends by the last of December. Male and female alternately sit on the nest.

The female takes great care of the eggs; several times during the day she turns them with her beak, then she rests on them so as to bring in contact with the shell the region of the abdomen which on a longitudinal median surface is destitute of feathers. The lower part of the egg rests on the feet of the bird.

Incubation lasts from 33 to 36 days.

The first broods hatch in the latter half of December. On hatching they are covered with a uniformly blackish-gray down, darker on the head, which they keep for seven or eight weeks.

After the hatching of the eggs, which ends in the first half of January, the city presents great animation. The parents must assume the difficult task of nourishing the broods, which are rapidly developing. Also, when the hatching is over, the male and female in turn abandon the nest to go a-fishing.

One then sees the Adelie quit the rookery in little flocks, which always follow the same route, and in fleeing make veritable paths in the snow to reach some point on the coast where it will be easy to launch out to sea.

The penguins remain in the sea only long enough for the fishing. There, in fact, they encounter their formidable enemies, the killers and the seals. The heron seal (*Lobodon carcinophagus*), the Weddell seal (*Leptomychotes Weddelli*), and especially the fierce sea leopard (*Hydrurga leptonyx*), take for their nourishment an ample supply of penguins.

The fishing ended, always in companies, the birds return to the rookery, where they are impatiently awaited by their offspring.

With its great belly, which reaches to its feet, the young bird has a very clumsy appearance. Sometimes completely satiated, it remains in place without being able to stir; at other times, moved by hunger, it runs after some adult returning from the sea; it harasses that unfortunate until it finally yields. Through a sort of regurgitation, the bird causes part of the food to return into the throat, where the



1. ADELIE PENGUINS WAITING FOR THE MELTING OF THE SNOW SO AS TO BUILD THEIR NESTS ON THE ROCKS BENEATH. IN THE BACKGROUND ARE TWO MALES OF THE SAME TASTE SEEKING THE LOVE OF THE SAME FEMALE.



2. CONSTRUCTION OF A NEST. AN ADELIE PENGUIN CARRYING A STONE IN HIS BEAK.



1. ADELIE PENGUINS MOLTING. THE SNOW IS COVERED WITH FEATHERS.

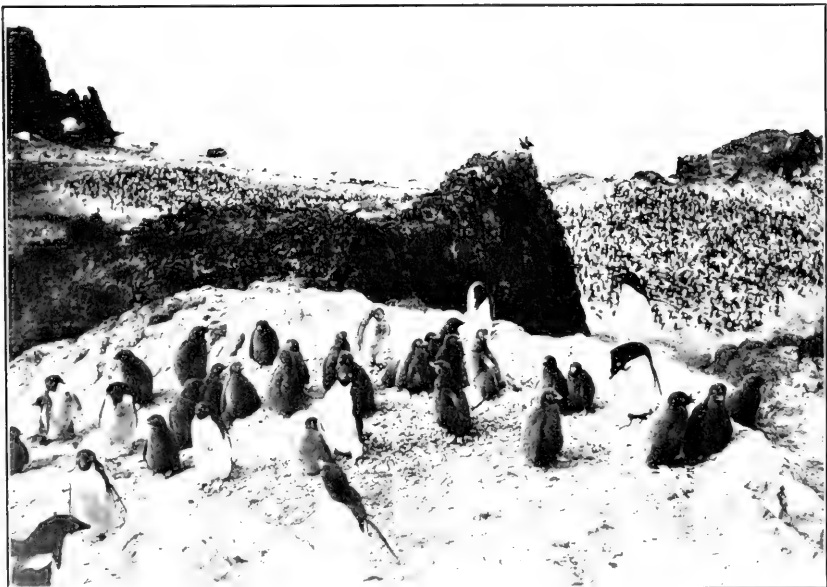

2. IN THE DANGEROUS PARTS OF THE ROOKERY THE ADULT ADELIE PENGUINS STAND AS SENTINELS AND REDOUBLE THEIR WATCHFULNESS.



1. FIGHT OF ADELIE PENGUINS.



2. THE FEEDING OF A YOUNG ADELIE PENGUIN.



1. CORNER OF A ROOKERY OF ADELIE PENGUINS. YOUNG ARE SEEN IN EACH NEST.

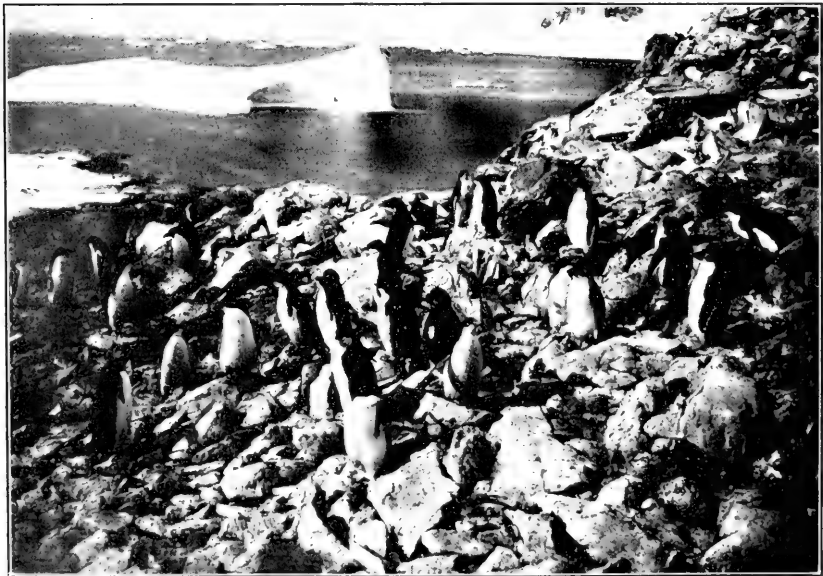

2. YOUNG ADELIE PENGUINS ABANDONING THE ROOKERY.

young glutton, burying its head almost entire in the beak of the adult, searches for it.

In general, the broods abandon the nests a few at a time. The young now keep together in small groups, moving about, splashing in the midst of the reddish mud, with which they are covered from head to foot. The very disagreeable odor which comes from them leaves some doubt as to the good hygiene of these animals. Each group is confided to the care of some adults which carefully watch over all these noisy and already inquisitive young creatures. One side of the rookery ends in a cliff overhanging the sea or a ravine, some adults standing there as sentinels. Woe to the curious little one that ventures too near the dangerous spot; the watchman, with a light stroke of the beak or of the wing, reminds the rash bird of the duty of obedience and of the need of returning to the ranks.

In February the young, little by little, change the down for the plumage which they wear for a year or until the next molt. They are now distinguished from the adults by the absence of the white iris, also by the color of the throat, which is white instead of black, the line of white and black crossing the cheek below the eye. It is not until the next molting at the end of a year, in February or March, that they take on the plumage of the adult. At the end of February the young can care for themselves; they leave the rookeries and ramble in groups along the coast. From day to day their number diminishes. They leave in March, going northward to dwell on the open sea.

The parents have done their work. Having labored for their offspring during four months, they must now think of themselves. Winter approaches, they must form the new habit which will enable them to endure bad weather. They go to rest on the snow or in some crevice of the rocks, sheltered from the prevailing winds. They remain there in the same place, without moving, during the entire molting season; that is to say, for 20 days. They are compelled to live on their reserve fat. They become unsightly, resembling birds poorly stuffed, eaten by insects.

At the end of March, when the molting is over, the birds in small flocks gradually leave their city, to which they will again return at the close of winter, after seven months' absence.

Finally, the last species, which, like the Adelie, is distributed over the whole extent of the Antarctic continent, is the Emperor Penguin (*Aptenodytes Forsteri*), a bird of large size, sometimes reaching a height of 1 meter 10 centimeters and a weight of 40 kilograms. It is a very beautiful bird; its head is jet black; on each side of the head a band of golden yellow diminishes gradually toward the neck and ventral regions; the back is bluish-gray, the beak to the base of the mandibles purplish-rose. The Emperor does not leave the polar regions, where the birds are found in small groups

on the icebergs. If two groups happen to meet, the leaders bow to each other, lowering their beaks on their breasts; remaining in this position, they hold a long discourse; then, compliments having been exchanged, they raise their heads and describe a great circle with their beaks. They act in the same way toward men, who generally have great difficulty in understanding this mimicry, obliging the penguin to begin over again.

The habits of this penguin are very different from those of the birds that we have just considered. The mode of reproduction is very peculiar, and has been ably studied by Mr. Wilson, naturalist of the *Discovery* expedition. It occurs in the dead of winter, in the middle of the polar night, at the end of June in cold that may reach 50 C.^o below zero when the Emperors gather together near the continent, on a solid iceberg, to lay a single egg. There are no preparations, no nest.

To keep the egg off the ice, the penguin places it on his feet, held between his legs, protected by a fold of skin covered with feathers at the base of the abdomen. As the incubation lasts nearly two months, the birds, of which not many are engaged in brooding, pass the egg to one another in turn. At the beginning of September the young is hatched. As there is only one chick to ten or so adults, and as every one of the latter wishes to brood, there is much jostling and struggling to get possession of the little one, that brings upon the poor creature unintentional wounds, sometimes causing its death.

Toward the end of October migration toward the north takes place, the birds letting themselves be carried off on fragments of ice broken from the iceberg; the chicks, still covered with down, are carried by their parents. In January they lose this down and from this time on they provide for themselves.

While the young live on the outskirts of the icebergs the adults return south to seek solid ice on which they go to molt, then in the month of June they come together again, and the cycle that we have just briefly described begins anew.

We have been obliged to pass very rapidly over the study of these birds, of which we have been able to give only a slight sketch.

But it is easy to understand that the Antarctic region possesses a distinct avian fauna, characterized by several very remarkable zoological types, and presenting very nearly the same composition throughout its extent. Different members of this fauna extend to very variable distances over certain adjacent lands, in such a way as to exert a greater or less influence on the characteristics of the ornithological population of neighboring regions.

THE DERIVATION OF THE EUROPEAN DOMESTIC ANIMALS.¹

By Prof. Dr. C. KELLER (Zurich).

The tremendous advances made in zoogeographic investigations, especially those of the last decade, are very gratifying, and the results have proven especially fruitful in shedding new light upon certain geological problems, but they likewise emphasize another fact, namely, that in dealing with zoogeographic questions zoologists have so far concerned themselves chiefly with wild faunas. The domesticated fauna seems to have been overlooked and it is seldom indeed that a modern zoogeographic work touches this phase in more than an exceedingly superficial way. Although the domesticated fauna is still considered a negligible quantity by many, this is evidently due to old traditions which one might well dispense with at the present time.

It is true that this relatively young fauna, produced under the influence of man, can throw no light upon general geographic and geologic problems, but it becomes important in the history of culture and offers valuable points in the discussion of anthropological questions. The faunal character of a given region is very often dominated by the domesticated fauna, and while the latter is small as far as the number of species is concerned, yet it makes up for this by a large number of individuals. The domesticated animals enter into close competition with the surrounding wild fauna and force it into the background or even to extinction. A long account might be written upon the changes which have thus taken place in certain regions. I will simply allude to what has occurred in North America, South Africa, and Australia, where the native fauna was forced to retreat all along the line, in parts even exterminated, during the last century, to make room for an entirely new fauna, that of the domesticated species. On European soil these changes took place in a less vigorous manner, though the keeping of domesticated animals had its beginning here in neolithic times, when it was very generally

¹ Translated by permission from *Verhandlungen des VIII Internationalen Zoologen-Kongresses zu Graz*. 15-20 Aug., 1910, pp. 356-365. Jena, 1912.

practiced in southern Europe. The native fauna gave way very slowly but steadily.

It is not my desire to discuss all phases of this process, which extends back into ancient, yes, even into prehistoric times. I omit a consideration of changes in the native fauna and will confine myself entirely to the introduction of domesticated animals, so far as we can at present determine the individual phases of this process in Europe. The solution of this problem has been attempted at various times, but the result has until very recently been incomplete. We shall attempt to demonstrate here what constitutes autochthonous derivation and what has been added from foreign sources.

It is evident that the phylogenetic relationships had to be established before these tangled problems could be approached. Half a century ago the task seemed hopeless. It is sufficiently significant that the celebrated and venerable master of biology, Charles Darwin, as late as 1859, in the first chapter of his path-breaking work, "Origin of Species," gave utterance to the statement that "The origin of most of our domestic animals will probably forever remain vague." This really sounded pessimistic, almost like a scientific "Lasciate ogni speranza!"

To-day we no longer worship this pessimism, for bit by bit, though not without much effort, we have had many surprising glimpses into the history of the domesticated animals of Europe.

In the same year, 1859, a French investigator, Isidore Geoffroy St. Hilaire, approached these problems in a decidedly optimistic manner. He tried to determine the time of appearance and the geographic derivation of our domesticated animals. The Orient and particularly Asia, seemed to him to be the original home of most of these animals, especially those which were attached to the home in the most remote times, that is, the dog, horse, ass, pig, camel, goat, sheep, cow, pigeon, and the hen. It is true, he approaches the subject rather one-sidedly, since he bases his deductions chiefly upon cultural history and does not permit the necessary analytic comparative anatomy to assume its proper place. He later received considerable aid from Victor Hehn who followed, entirely one-sided, linguistic methods. His well-known work, "Kulturpflanzen und Haustiere in ihrem Übergang aus Asien nach Griechenland und Italien," which received an altogether undeserved attention, has not always been accorded favorable criticism from the scientific side, and even after its careful revision by Schrader it may be looked upon as out of date.

In 1862 Ludwig Rüttimeyer's classic "Fauna der Pfahlbauten" appeared and formed the turning point in the investigations of the history of European domestic animals. In this work, through prehistoric and comparative anatomic methods, facts were adduced in a

scientific and unchallengeable manner, showing that already with the beginning of the Lake Dwellings a goodly number of domestic animals had made their appearance in Europe. They were somewhat different, it is true, from the present forms, being more primitive and simpler in their race fusion, but nevertheless the races of to-day have their foundation in many instances in those of the Lake Dwellings. Rüttimeyer's opinions, although many times attacked, have in the main remained unshaken. Rüttimeyer was not satisfied to simply expound the historic facts, but he attempted in a number of cases to connect these animals with their wild progenitors by comparative anatomic studies. It is true the material available at that time was very limited. The domestic animals of Asia and Africa were little known. Even Europe, which might have furnished valuable keys to the situation, was insufficiently explored, and in fact remains so to-day. The genial Rüttimeyer nevertheless recognized the relations with ancestral forms perfectly correctly. He cleared up the cattle question and in conjunction with Hermann v. Nathusius, determined in a different manner the derivation of the domestic pig. Other derivation questions, which he did not deem sufficiently clear, he left open for future consideration.

Charles Darwin hailed Rüttimeyer's discoveries with great enthusiasm in England. He was even stimulated to undertake personal investigations, which resulted in a commendable expounding of the derivation of the pigeons, chickens, and rabbits. Even in the phylogeny of the dogs, he developed correct and basic principles.

Other questions of the day forced the problem of domestic animals into the background, whence it later emerged to a prominent position. A retrogressive movement tended to discredit the Darwinian basis. But the domestic species were responsible for the most important foundation of the Darwinian teachings, and a careful revision of these, therefore, seemed absolutely necessary to support these doctrines. In fact, the study of the history of the domestic animals of Europe and other places had never ceased. Austria has at all times displayed a lively interest in such problems. I will remind you of Fitzinger, who followed domesticated animal geography until 1876. The labors of Wilkens and especially those of Leopold Adametz have thrown much light upon the cattle question viewed from the zootechnic standpoint, while those of Woldrich and Jeteles have emphasized the prehistoric side. In Germany the labors of Alfred Nehring are well known. With the assistance of my students I have personally attacked the problem of the domesticated animal in all its phases, and thus a lot of material has accumulated, which will give us a clearer insight into the question. If we examine the derivation

of European domestic animals in the light of our present knowledge, we find it evident that they came to us from various sources.

In the first place, we have a large contingent which is of European origin, and this we must designate as having been derived in an autochthonous manner.

Alfred Nehring furnished the convincing proof about the horse, that the heavy, calm strains, which one designates as occidental horses, are traceable to a diluvial wild-horse ancestor of middle Europe.

The pigs with the sharp backs, still strongly represented in the northern Alps, especially in Bavaria and northern Germany, were shown by Hermann v. Nathusius and Ludwig Rüttimeyer to be descendants of the wild pig of Europe; and the short-tailed domestic sheep, which at present have been forced far to the north, appear very probably to have been derived from the south European mouflon. No investigator doubts, since Rüttimeyer made his brilliant investigations, that the heavy cattle of the steppes of southeastern Europe and the lowland cattle of northwestern Europe have sprung from the aurochs (*Bos primigenius*), which persisted as a wild animal down to historic times. In spite of all the remonstrances made to me, I am still forced, even more than ever, by my recent investigations, which will be published in a large monograph in the near future, to consider the mainland of Greece as the starting point of the *Bos primigenius* domestication in the early Mycenaean times. The entire process is clearly represented on the noted gold goblet of Vaphio, which undoubtedly is based upon close observation in nature. One might object, saying that no osteological finds of the ur (aurochs) have been made in that region. But yet I have recently demonstrated by means of old Cretan ur pictures and undoubted ur bones that *Bos primigenius* lived in that region up to the early historic period all objections must vanish. The latest finds tell us that even before the Mycenaean period the domesticating of animals had begun in Crete. The latest efforts to prove that the ur was first domesticated in Mesopotamia appear to me to be entirely misplaced.

To the smaller domesticated animals, Europe has but comparatively recently—that is, in historic times—added the rabbit, the goose, and the duck. A second category of domestic animals in Europe is surely of Asiatic origin—that is, introduced. This is not surprising, for Europe, geographically considered, is only an Asiatic dependency. Nothing seems more natural than that this colossus land should have given us much from its overabundance of domestic animals. I feel certain that the spitz dog, like the peat dog of the Lake Dwellers, came from western Asia. Even of more certain Asiatic origin are the bronze dogs, whose little-altered descendants greet us to-day in the form of the shepherd dog, both of which have sprung

from the Indian wolf. It is easily demonstrated that the original home of the great "dogge" is to be found in the highlands of Tibet. They became established in Europe at the time of Alexander the Great, and appeared in our northern Alps at the beginning of the first century, where they were distributed by the Romans. They have been demonstrated in the Roman-Helvetian colony of Vin-donissa and in southern Germany.

That the domestic goat, which was kept by the oldest Lake Dwellers, is of west Asiatic origin, and derived from the Bezoar goat, is universally acknowledged. It came through the Aegean Islands.

In very early times, during the Mycenaean period, wool sheep reached Greece and the rest of southern Europe. The story of the "Golden Fleece" points toward Colchis, to the east of the Black Sea, as its original home, and zoogeographic facts point favorably in that direction.

As for our pigs, the investigations of Rüttimeyer and Nathusius have proved that even in prehistoric times Asiatic blood reached Europe. The banded pig (*Sus vittatus*) distributed over southeast Asia is the wild pig from which the domesticated Asiatic pig has been developed. All doubts about this are dispelled by the anatomic facts of the case. Southern Europe has always kept these pigs to the exclusion of all others. I was able to demonstrate their presence in the Aegean Archipelago, even as far back as the neolithic period. The examination which I conducted upon the skulls of the Spanish and Sardinian domesticated pigs showed that even to-day the Asiatic race has retained its pure strain in the Mediterranean region. It was long unknown which ocean route had been used in the transportation of this animal, in so far as the Semitic culture of Mesopotamia probably refused this domestic animal. Lippert expressed the opinion that it might have reached the west along the northern border of Mesopotamia. The investigations of J. U. Dürst upon the bone remains from the old culture strata of Anau in Turkestan have substantiated these opinions in every way.

There can be no doubt that Asia gave to Europe from its wealth of domesticated horses. The dainty oriental horses prevail over others even to-day in the east and south of our continent. But whether, in addition to the Przewalsky horse, another ancestral horse will have to be considered has not been completely established as yet. But that horses were first domesticated in the interior of Asia has been established from the historic cultural fact that the domestic horse appeared first in large numbers, historically considered, in the interior of Asia.

The prehistoric presence of the domestic horse is known for Turkestan, where it occurs in the very oldest culture strata. This has the characters of the oriental horse and was of small size. It may have become distributed over Asia Minor at an early period, whence it

most likely reached Europe through the old Cretan and Minos culture. Arthur Evans discovered pictures at Knossos in which horses were transported upon ships.

In a few words I would like to point out that the species of camels appeared first under domestication in the interior of Asia and that their distribution was relatively late. Europe received this Asiatic contribution only in the south, and there even only locally. As a curiosity it might be mentioned that the camel appeared in the northern Alps at the beginning of the first century. I received a fragment of an upper jaw from the Helvetian-Roman colony Vindonissa. The Romans probably only introduced single animals for show, for it is hardly possible that they were used for agricultural purposes.

The oldest center of domesticated cattle is situated in southeast Asia. I devoted many years to the cattle question and was able to demonstrate upon the basis of proper anatomical material that a single species, the banteng (*Bos sondaicus*), which still exists in the wild state in those regions, constitutes the sole progenitor of that stock. This stock migrated westward, namely, into Africa, and the smaller races reached Europe, even in prehistoric times, where they have continued to the present day as the smaller, short-horned race. The Asiatic stock is the richest in individuals and the most universally distributed.

Of our domestic birds, the hen, as Darwin has pointed out, is of southeast Asiatic origin. In those regions alone combed chickens occur in a wild state. We can follow the route of the hen over Persia to Greece, where it arrived in the middle of the first century B. C.; that is, in historic times.

The peacock also comes from southern Asia.

The pigeon is probably of west Asiatic origin, for in history it appears first in the southeast corner of the Mediterranean, where it is frequently associated with cultural rites. On the other hand, the pigeon was already well established during the older dynasties of Egypt, and it is not impossible that it was first domesticated in the valley of the Nile. We do not wish to discredit a considerable contribution from Asia, but I have for years defended the position that Africa has furnished us more than we have been accustomed to admit. This African importation is quite considerable.

Even the short-horned cattle, which reached Europe during the neolithic period and which has maintained its primitive form in southern Europe, and has continued as the brown cattle of the central Alps, it seems most plausible to me, appears to have reached Europe from Asia by way of Africa. Even Rüttimeyer noticed that the typical form was found in north Africa. Lately Prof. Naville has found a wonderful stone statue of a sacred cow of the eighteenth

dynasty, whose head corresponds wonderfully with that of the Sardinian cattle. Western Asia never did possess a sufficiently great abundance of cattle to part with a considerable quantity of it. It is also a remarkable fact that short-horned cattle appear relatively late and scantily in the cultural strata. It is possible that this cattle may have reached western Asia by way of Egypt and Syria, for the culture of the Nile Valley is much older than that of western Asia.

Of undoubted African origin is the peat sheep, that small goat-like race of sheep which was first demonstrated in the Lake Dwellings of Switzerland, and which has maintained itself, almost as a pure strain, to the turning of the century, in small remnants, in the lesser isolated valleys of the Bündneroberland. The characters of the skull and the long tail point to a half sheep. Old Egyptian pictures teach us that the African maned sheep was domesticated at an early period in the Nile Valley; and I surmise that the peat sheep has made its way from Egypt over Greece to Europe. I base my conclusions on this point upon a few sheep pictures from the Mycenaic period. Lately I found not only peat sheep remains of the neolithic period in Crete, but also, to my great surprise, many herds of small, pure strain, peat sheep in the hills of Crete, which have been able to maintain themselves there in full vigor to the present time. Of African source is also the domestic ass, whose derivation from the African wild ass was completely demonstrated by Darwin. This animal entered Europe at a very early date, but became an agricultural element only in the lands along the Mediterranean. Its domestication dates far back in Africa. It was pressed into service long before the horse, and was probably first domesticated by the old Hamites.

That the house cat is of African origin goes without challenge; likewise that it was extracted from the Nubian cat. It is missing in our Lake Dwelling period, and has made only slow progress in historic times in Europe.

Africa, and especially Egypt, has also furnished us some of our dogs. The Paria dogs of Turkey and southern Bulgaria, which I had a chance to observe recently in Constantinople, are related to the Paria dogs of Egypt.

The greyhounds are undoubtedly of African origin and are derived from the Abyssinian wolf (*Canis simensis*). In the time of the older dynasties the greater part still possessed erect ears, and they were greatly prized in the land of the Pharaohs. This old race, which one finds so often represented on antique mural paintings, became extinct in the Nile Valley at an unknown period. Their progeny has, through further domestication and breeding, become strongly changed, but not entirely lost. I recently found living on the east Spanish islands of Mallorca and Ibiza a strong colony of the erect-eared greyhound of old Egypt. In 1909 I was able to demonstrate

a second colony on the island of Crete. For the long-eared hunting dogs we will also have to assume an African origin, for they appear first in the oldest dynasties; in fact, it is questionable if they have not been demonstrated in neolithic times, though this seems to be carrying things a little too far. Hunting dogs reached the lands of the Mediterranean from Egypt, where they are still, numerically speaking, best represented.

In conclusion, I wish to answer the question: From what places in Asia and Africa did the animals emigrate to reach Europe?

This question is most intimately related with the derivation of the sum total of European culture, of which the domestic animals form a considerable part of the cultural acquirement.

How far the lands of the Caucasus have figured as an entrance port remains to be determined. It is important to consider next the *Ægean Isles* as an intermediary, for these form a bridge to Europe. Here one has recently discovered a peculiar island culture, which, in many respects, might be considered Mycenaean. This, of course, is uncertain. To our great surprise, a much older and much more remarkable culture has been discovered on the island of Crete in the last 10 years. Following Arthur Evans, one now calls this the "Minoic culture." This must be considered the root from which the later Mycenaean culture sprang.

I convinced myself in 1909 by examinations made on the spot that the Minoic bone remains and pictures embrace the most important domesticated animals of Europe.

Old Crete, indeed, formed a stepping-stone over which most of the domestic animals of Asia and Africa passed to reach the mainland of Europe. The geographic position of Crete was exceedingly well suited to play this intermediary rôle, for in the first place this island lies equidistant from the three continents, and, besides, it possessed a considerable navy even at the time of Minos, whose ships were in close touch with the east and south. Even as far back as 3000 B. C. a decided cultural influence from Egypt affected this large island of the *Ægean Sea*, while the Asiatic influence was still scarcely recognizable. Painting and sculpture show remarkable progress at an early period, of which the animal representations possess an especial interest to us. Bone finds also are not absent, and these documents furnish us with valuable data concerning the trend taken by wanderings of the domestic animals.

Crete was, even during the neolithic culture period, a prominent center; for example, the neolithic deposits in Knossos, attained the size of 6 meters or more. In these I was able to demonstrate remains of the peat sheep, the peat pig, and peat cattle. These races, therefore, have undoubtedly been transmitted to us over Crete.

In Mochlos, an ancient culture station on the Bay of Mirabella, I found upon the lid of a vessel made of black steatite the splendidly carved figure of an erect-eared greyhound. Such greyhounds as were bred in Egypt had evidently reached Crete 2000 years B. C. They appeared then frequently upon ancient Cretan coins, such as those of Kydonia. The greyhounds of Crete were famous in ancient days and were exported in great numbers to the mainland of Greece.

The same route was followed by the cat. That their original home is to be found in the Nile Valley may be assumed. They reached Crete during the later Minoic period, for we know of a mural painting belonging to the period of about 1500 B. C. which comes from Phästos and represents the domestic cat quite well. This animal also appears upon a Mycenaic terra cotta from Gournia. It arrived in Greece much later.

Horses were obtained in Asia Minor. A picture from Knossos represents their transportation by boat very graphically. In a similar manner the ass must have reached Crete and Greece from north Africa.

It can be shown with considerable certainty that the pigeon reached Europe by way of Crete. It is pictured at the time of Minos, and is associated with cultural rites. It probably reached Sicily from Crete.

An important domestic bird of Egypt, the Nile goose, was also brought to Crete. Its picture occurs upon an earthenware coffin, excavated at Gortyna; but this bird disappeared there as in its old home and was unable to reach the mainland of Europe.

If we recall that ancient Crete, even during the Hero period, and in the beginning of the earliest historic period, extended its culture over the Cyclades and even subjugated Athens and possessed colonies in Asia Minor, then we will understand its bearing on the distribution of the domesticated animal culture. The great period of Minos Island is past, for already at the conclusion of the Trojan War a decline began, and its independence was lost to the Romans at the beginning of the first century. But the domesticated animals of that ancient period remained and persist as living relics even to the present day.

I have been taught by an examination of the domestic animals of Crete as they exist to-day that the old peat cattle, the Cretan dogs, and the goat-like peat sheep are living witnesses of that ancient domestic animal migration whose ultimate goal was Europe.

LIFE: ITS NATURE, ORIGIN, AND MAINTENANCE.¹

By E. A. SCHÄFER, LL.D., D.Sc., M.D., F.R.S.,
Professor of Physiology in Edinburgh.

PREFACE.

In the following essay, which formed the presidential address to the British Association at its meeting in Dundee in 1912, I have tried to indicate in clear language the general trend of modern biochemical inquiries regarding the nature and origin of living material and the manner in which the life of multicellular organisms, especially that of the higher animals and man, is maintained. I have also stated the conclusions which it appears to me may legitimately be drawn from the result of those inquiries, without ignoring or minimizing such difficulties as these conclusions present.

There is, it may be admitted, nothing new in the idea that living matter must at some time or another have been formed from lifeless material, for in spite of the dictum *omne vivum e vivo*, there was certainly a period in the history of the earth when our planet could have supported no kind of life, as we understand the word; there can, therefore, exist no difference of opinion upon this point among scientific thinkers. Nor is it the first time that the possibility of the synthetic production of living substance in the laboratory has been suggested. But only those who are ignorant of the progress which biochemistry has made in recent years would be bold enough to affirm that the subject is not more advanced than in the days of Tyndall and of Huxley, who showed the true scientific instinct in affirming a belief in the original formation of life from lifeless material and in hinting at the possibility of its eventual synthesis, although there was then far less foundation upon which to base such an opinion than we of the present day possess. The investigations of Fischer, of Abderhalden, of Hopkins, and of others too numerous to mention, have thrown a flood of light upon the constitution of the materials of which living substance is composed; and, in particular, the epoch-making researches of Kossel into the chemical composition of nuclear

¹ An address delivered to the British Association for the Advancement of Science, at its meeting at Dundee in September, 1912. Reprinted by permission from pamphlet copy printed by Longmans, Green & Co., London, 1912.

substance—which in certain forms may be regarded as the simplest type of living matter, while it is certainly the *fons et origo* of all active chemical processes within most cells—have shown how much less complex in chemical nature this substance may be than physiologists were a few years ago accustomed to regard it. On this and other grounds it has lately been independently suggested by Prof. Minchin that the first living material originally took the form, not of what is commonly termed protoplasm, but of nuclear matter or chromatin: a suggestion which appears by no means improbable.

If the honored names of Charles Darwin, Ernst Hæckel, and August Weismann are not found in the following pages, it is because exigencies of space and time rendered it necessary to deal mainly with the more modern developments of this chapter of evolutionary history. For other but not less cogent reasons all metaphysical speculations on the subjects dealt with have been avoided. The study of natural knowledge, as the Royal Society still quaintly describes in its title the investigation of the phenomena of nature, is never properly advanced if mixed up with the “supernatural” or if metaphysics is appealed to for the explanation of scientific problems which can not at once be solved by ordinary scientific methods; and it behooves us to eliminate all considerations involving the intervention of superantural agencies just as much in connection with scientific inquiries into the nature and origin of life as with all other matters which are properly the subject of scientific investigation. This is not materialism, but common sense.

The first part of the subject of this address is dealt with at considerable length and in a strictly scientific spirit by Le Dantec in “The Nature and Origin of Life,” as well as by Dastre in the book mentioned on the next page. To works such as these the reader is referred for the numerous details which it is impossible to include within the limits of a short essay.

DEFINITION.

Everybody knows, or thinks he knows, what life is; at least we are all acquainted with its ordinary, obvious manifestations. It would therefore seem that it should not be difficult to find an exact definition. The quest has, nevertheless, baffled the most acute thinkers. Herbert Spencer devoted two chapters of his “Principles of Biology” to the discussion of the attempts at definition which had up to that date been proposed, and himself suggested another. But at the end of it all he is constrained to admit that no expression had been found which would embrace all the known manifestations of animate, and at the same time exclude those of admittedly inanimate, objects.

The ordinary dictionary definition of life is “the state of living.” Dastre, following Claude Bernard, defines it as “the sum total of

the phenomena common to all living beings.”¹ Both of these definitions are, however, of the same character as Sidney Smith’s definition of an archdeacon as “a person who performs archidiaconal functions.” I am not myself proposing to take up your time by attempting to grapple with a task which has proved too great for the intellectual giants of philosophy, and I have the less disposition to do so, because recent advances in knowledge have suggested the probability that the dividing line between animate and inanimate matter is less sharp than it has hitherto been regarded, so that the difficulty of finding an inclusive definition is correspondingly increased.

As a mere word “life” is interesting in the fact that it is one of those abstract terms which has no direct antithesis, although probably most persons would regard “death” in that light. A little consideration will show that this is not the case. “Death” implies the preexistence of “life.” There are physiological grounds for regarding death as a phenomenon of life—it is the completion, the last act of life. We can not speak of a nonliving object as *possessing* death in the sense that we speak of a living object as *possessing* life. The adjective “dead” is, it is true, applied in a popular sense antithetically to objects which have never possessed life, as in the proverbial expression “as dead as a doornail.” But in the strict sense such application is not justifiable, since the use of the terms “dead” and “living” implies either in the past or in the present the possession of the recognized properties of living matter. On the other hand, the expressions *living* and *lifeless*, *animate* and *inanimate* furnish terms which are undoubtedly antithetical. Strictly and literally the words “animate” and “inanimate” express the presence or absence of “soul,” and not infrequently we find the terms “life” and “soul” erroneously employed as if identical. But it is hardly necessary for me to state that the remarks I have to make regarding “life” must not be taken to apply to the conception to which the word “soul” is attached. The fact that the formation of such a conception is only possible in connection with life, and that the growth and elaboration of the conception has only been possible as the result of the most complex processes of life in the most complex of living organisms has doubtless led to a belief in the identity of life with soul. But unless the use of the expression “soul” is extended to a degree which would deprive it of all special significance, the distinction between these terms must be strictly maintained. For the problems of life are essentially problems of matter; we can not conceive of life in the scientific sense as existing apart from matter. The phenomena of life are investigated, and can only be investigated, by the same methods as all other phenomena of matter, and the general results of such investigations tend to

¹ *La vie et la mort*, English translation by W. J. Greenstreet, 1911, p. 54.

show that living beings are governed by laws identical with those which govern inanimate matter. The more we study the manifestations of life the more we become convinced of the truth of this statement and the less we are disposed to call in the aid of a special and unknown form of energy to explain those manifestations.

PHENOMENA INDICATIVE OF LIFE—MOVEMENT.

The most obvious manifestation of life is "spontaneous" movement. We see a man, a dog, a bird move, and we know that they are alive. We place a drop of pond water under the microscope, and see numberless particles rapidly moving within it; we affirm that it swarms with "life." We notice a small mass of clear slime changing its shape, throwing out projections of its structureless substance, creeping from one part of the field of the microscope to another. We recognize that the slime is living; we give it a name—*Amœba limax*—the slug amœba. We observe similar movements in individual cells of our own body; in the white corpuscles of our blood, in connective tissue cells, in growing nerve cells, in young cells everywhere. We denote the similarity between these movements and those of the amœba by employing the descriptive term "amœboid" for both. We regard such movements as indicative of the possession of "life"; nothing seems more justifiable than such an inference.

But physicists¹ show us movements of a precisely similar character in substances which no one by any stretch of imagination can regard as living; movements of oil drops, of organic and inorganic mixtures, even of mercury globules, which are indistinguishable in their character from those of the living organisms we have been studying: movements which can only be described by the same term amœboid, yet obviously produced as the result of purely physical and chemical reactions causing changes in surface tension of the fluids under examination.² It is therefore certain that such movements are not specifically "vital," that their presence does not necessarily denote "life." And when we investigate closely, even such active movements as those of a vibratile cilium or a phenomenon so intimately identified with life as the contraction of a muscle, we find that these present so many analogies with amœboid movements as to render it certain that they are fundamentally of the same character and produced in much the same manner.³ Nor can we for a moment doubt that the

¹ G. Quinke, *Annal. d. Physik u. Chem.*, 1870 and 1888.

² The causation not only of movements but of various other manifestations of life by alterations in surface tension of living substance is ably dealt with by A. B. Macallum in a recent article in *Asher and Spiro's Ergebnisse der Physiologie*, 1911. Macallum has described an accumulation of potassium salts at the more active surfaces of the protoplasm of many cells, and correlates this with the production of cell activity by the effect of such accumulation upon the surface tension. The literature of the subject will be found in this article.

³ G. F. Fitzgerald (*Brit. Assoc. Reports*, 1893, and *Scient. Trans. Roy. Dublin Society*, 1898) arrived at this conclusion with regard to muscle from purely physical considerations.

complex actions which are characteristic of the more highly differentiated organisms have been developed in the course of evolution from the simple movements characterizing the activity of undifferentiated protoplasm; movements which can themselves, as we have seen, be perfectly imitated by nonliving material. The chain of evidence regarding this particular manifestation of life—movement—is complete. Whether exhibited as the amœboid movement of the proteus animalcule or of the white corpuscle of our blood; as the ciliary motion of the infusorian or of the ciliated cell; as the contraction of a muscle under the governance of the will, or as the throbbing of the human heart responsive to every emotion of the mind, we can not but conclude that it is alike subject to and produced in conformity with the general laws of matter by agencies resembling those which cause movements in lifeless material.¹

ASSIMILATION AND DISASSIMILATION.

It will perhaps be contended that the resemblances between the movements of living and nonliving matter may be only superficial, and that the conclusion regarding their identity to which we are led will be dissipated when we endeavor to penetrate more deeply into the working of living substance. For can we not recognize along with the possession of movement the presence of other phenomena which are equally characteristic of life and with which nonliving material is not endowed? Prominent among the characteristic phenomena of life are the processes of assimilation and disassimilation, the taking in of food and its elaboration.² These, surely, it may be thought, are not shared by matter which is not endowed with life. Unfortunately for this argument, similar processes occur characteristically in situations which no one would think of associating with the presence of life. A striking example of this is afforded by the osmotic phenomena presented by solutions separated from one another by semipermeable membranes or films, a condition which is precisely that which is constantly found in living matter.³

It is not so long ago that the chemistry of organic matter was thought to be entirely different from that of inorganic substances.

¹ "Vital spontaneity, so readily accepted by persons ignorant of biology, is disproved by the whole history of science. Every vital manifestation is a response to a stimulus, a provoked phenomenon. It is unnecessary to say this is also the case with brute bodies, since that is precisely the foundation of the great principle of the inertia of matter. It is plain that it is also as applicable to living as to inanimate matter."—Dastre, *op. cit.*, p. 280.

² The terms "assimilation" and "disassimilation" express the physical and chemical changes which occur within protoplasm as the result of the intake of nutrient material from the circumambient medium and its ultimate transformation into waste products which are passed out again into that medium; the whole cycle of these changes being embraced under the term "metabolism."

³ Ledue (*The Mechanism of Life*, English translation by W. Deane Butcher, 1911) has given many illustrations of this statement. In the report of the meeting of 1867 in Dundee is a paper by Dr. J. D. Heaton (*On Simulations of Vegetable Growths by Mineral Substances*) dealing with the same class of phenomena. See also J. Hall-Edwards, *Address to Birmingham and Midland Institute*, November, 1911. The conditions of osmosis in cells have been especially studied by Hamburger (*Osmotischer Druck und Ionenlehre*, Wiesbaden, 1902-4).

But the line between inorganic and organic chemistry, which up to the middle of the last century appeared sharp, subsequently became misty and has now disappeared. Similarly the chemistry of living organisms, which is now a recognized branch of organic chemistry, but used to be considered as so much outside the domain of the chemist that it could only be dealt with by those whose special business it was to study "vital" processes, is passing more and more out of the hands of the biologist and into those of the pure chemist.

THE COLLOID CONSTITUTION OF LIVING MATTER.

Somewhat more than half a century ago Thomas Graham published his epoch-making observations relating to the properties of matter in the colloidal state, observations which are proving all-important in assisting our comprehension of the properties of living substance. For it is becoming every day more apparent that the chemistry and physics of the living organism are essentially the chemistry and physics of nitrogenous colloids. Living substance or protoplasm always, in fact, takes the form of a colloidal solution. In this solution the colloids are associated with crystalloids (electrolytes), which are either free in the solution or attached to the molecules of the colloids. Surrounding and inclosing the living substance thus constituted of both colloid and crystalloid material is a film, probably also formed of colloid, but which may have a lipoid substratum associated with it (Overton). This film serves the purpose of an osmotic membrane, permitting of exchanges by diffusion between the colloidal solution constituting the protoplasm and the circumambient medium in which it lives. Other similar films or membranes occur in the interior of protoplasm. These films have in many cases specific characters, both physical and chemical, thus favoring the diffusion of special kinds of material into and out of the protoplasm and from one part of the protoplasm to another. It is the changes produced under these physical conditions, associated with those caused by active chemical agents formed within protoplasm and known as *enzymes*, that effect assimilation and disassimilation. Quite similar changes can be produced outside the body (*in vitro*) by the employment of methods of a purely physical and chemical nature. It is true that we are not yet familiar with all the intermediate stages of transformation of the materials which are taken in by a living body into the materials which are given out from it. But since the initial processes and the final results are the same as they would be on the assumption that the changes are brought about in conformity with the known laws of chemistry and physics, we may fairly conclude that all changes in living substance are brought about by ordinary chemical and physical forces.

SIMILARITY OF PROCESSES OF GROWTH AND REPRODUCTION IN LIVING AND NONLIVING MATTER.

Should it be contended that growth and reproduction are properties possessed only by living bodies and constitute a test by which we may differentiate between life and nonlife, between the animate and inanimate creation, it must be replied that no contention can be more fallacious. Inorganic crystals grow and multiply and reproduce their like, given a supply of the requisite pabulum. In most cases for each kind of crystal there is, as with living organisms, a limit of growth which is not exceeded, and further increase of the crystalline matter results not in further increase in size but in multiplication of similar crystals. Leduc has shown that the growth and division of artificial colloids of an inorganic nature, when placed in an appropriate medium, present singular resemblances to the phenomena of the growth and division of living organisms. Even so complex a process as the division of a cell nucleus by karyokinesis as a preliminary to the multiplication of the cell by division—a phenomenon which would *prima facie* have seemed and has been commonly regarded as a distinctive manifestation of the life of the cell—can be imitated with solutions of a simple inorganic salt, such as chloride of sodium, containing a suspension of carbon particles; which arrange and rearrange themselves under the influence of the movements of the electrolytes in a manner indistinguishable from that adopted by the particles of chromatin in a dividing nucleus. And in the process of sexual reproduction, the researches of J. Loeb and others upon the ova of the sea urchin have proved that we can no longer consider such an apparently vital phenomenon as the fertilization of the egg as being the result of living material brought to it by the spermatozoon, since it is possible to start the process of division of the ovum and the resulting formation of cells, and ultimately of all the tissues and organs—in short, to bring about the development of the whole body—if a simple chemical reagent is substituted for the male element in the process of fertilization. Indeed, even a mechanical or electrical stimulus may suffice to start development. “*Kurz und gut,*” as the Germans say, vitalism as a working hypothesis has not only had its foundations undermined, but most of the superstructure has toppled over, and if any difficulties of explanation still persist, we are justified in assuming that the cause is to be found in our imperfect knowledge of the constitution and working of living material. At the best, vitalism explains nothing, and the term “vital force” is an expression of ignorance which can bring us no further along the path of knowledge. Nor is the problem in any way advanced by substituting for the term “vitalism” “neovitalism,” and for “vital force” “biotic energy.”¹ “New presbyter is but old priest writ large.”

¹ B. Moore, in *Recent Advances in Physiology*, 1906; Moore and Roaf, *ibid.*; and *Further Advances in Physiology*, 1909. Moore lays especial stress on the transformations of energy which occur in protoplasm. See on the question of vitalism Gley (*Revue Scientifique*, 1911) and D'Arcy Thompson (address to Section D at Portsmouth, 1911).

POSSIBILITY OF THE SYNTHESIS OF LIVING MATTER.

Further, in its chemical composition we are no longer compelled to consider living substance as possessing infinite complexity, as was thought to be the case when chemists first began to break up the proteins of the body into their simpler constituents. The researches of Miescher, which have been continued and elaborated by Kossel and his pupils, have acquainted us with the fact that a body so important for the nutritive and reproductive functions of the cell as the nucleus—which may be said indeed to represent the quintessence of cell life—possesses a chemical constitution of no very great complexity; so that we may even hope some day to see the material which composes it prepared synthetically. And when we consider that the nucleus is not only itself formed of living substance, but is capable of causing other living substance to be built up—is, in fact, the directing agent in all the principal chemical changes which take place within the living cell—it must be admitted that we are a long step forward in our knowledge of the chemical basis of life. That it is the form of nuclear matter rather than its chemical and molecular structure which is the important factor in nuclear activity can not be supposed. The form of nuclei, as every microscopist knows, varies infinitely, and there are numerous living organisms in which the nuclear matter is without form, appearing simply as granules distributed in the protoplasm. Not that the form assumed and the transformations undergone by the nucleus are without importance; but it is none the less true that even in an amorphous condition the material which in the ordinary cell takes the form of a “nucleus” may, in simpler organisms which have not in the process of evolution become complete cells, fulfill functions in many respects similar to those fulfilled by the nucleus of the more differentiated organism.

A similar anticipation regarding the probability of eventual synthetic production may be made for the proteins of the cell substance. Considerable progress in this direction has indeed already been made by Emil Fischer, who has for many years been engaged in the task of building up the nitrogenous combinations which enter into the formation of the complex molecule of protein. It is satisfactory to know that the significance of the work both of Fischer and of Kossel in this field of biological chemistry has been recognized by the award to each of these distinguished chemists of a Nobel prize.

THE CHEMICAL CONSTITUTION OF LIVING SUBSTANCE.

The elements composing living substance are few in number. Those which are constantly present are carbon, hydrogen, oxygen, and nitrogen. With these, both in nuclear matter and also, but to a less degree, in the more diffuse living material which we know as

protoplasm, phosphorus is always associated. "Ohne Phosphor kein Gedanke" is an accepted aphorism; "Ohne Phosphor kein Leben" is equally true. Moreover, a large proportion, rarely less than 70 per cent, of water appears essential for any manifestation of life, although not in all cases necessary for its continuance, since organisms are known which will bear the loss of the greater part if not the whole of the water they contain without permanent impairment of their vitality. The presence of certain inorganic salts is no less essential, chief amongst them being chloride of sodium and salts of calcium, magnesium, potassium, and iron. The combination of these elements into a colloidal compound represents the chemical basis of life; and when the chemist succeeds in building up this compound it will without doubt be found to exhibit the phenomena which we are in the habit of associating with the term "life."¹

SOURCE OF LIFE—THE POSSIBILITY OF SPONTANEOUS GENERATION.

The above considerations seem to point to the conclusion that the possibility of the production of life, i. e., of living material, is not so remote as has been generally assumed. Since the experiments of Pasteur, few have ventured to affirm a belief in the spontaneous generation of bacteria and monads and other micro-organisms, although before his time this was by many believed to be of universal occurrence. My esteemed friend Dr. Charlton Bastian is, so far as I am aware, the only scientific man of eminence who still adheres to the old creed, and Dr. Bastian, in spite of numerous experiments and the publication of many books and papers, has not hitherto succeeded in winning over many converts to his opinion. I am myself so entirely convinced of the accuracy of the results which Pasteur obtained—are they not within the daily and hourly experience of everyone who deals with the sterilization of organic solutions?—that I do not hesitate to believe, if living torulæ or mycelia are exhibited to me in flasks which had been subjected to prolonged boiling after being hermetically sealed, that there has been some fallacy either in the premises or in the carrying out of the operation. The appearance of organisms in such flasks would not furnish to my mind proof that they were the result of spontaneous generation. Assuming no fault in manipulation or fallacy in observation, I should find it simpler to believe that the germs of such organisms have resisted the effects of prolonged heat than that they became generated spontaneously. If spontaneous generation is possible, we can not expect it to take the form of living beings which show so marked a degree of differentiation, both structural and functional, as the organisms which are described

¹ The most recent account of the chemistry of protoplasm is that by Botazzi (*Das Cytoplasma u. die Kôrpersäfte*) in Winterstein's *Handb. d. vergl. Physiologie*, Bd. I, 1912. The literature is given in this article.

as making their appearance in these experimental flasks.¹ Nor should we expect the spontaneous generation of living substance of any kind to occur in a fluid the organic constituents of which have been so altered by heat that they can retain no sort of chemical resemblance to the organic constituents of living matter. If the formation of life, of living substance, is possible at the present day—and for my own part I see no reason to doubt it—a boiled infusion of organic matter, and still less of inorganic matter, is the last place in which to look for it. Our mistrust of such evidence as has yet been brought forward need not, however, preclude us from admitting the possibility of the formation of living from nonliving substance.²

LIFE A PRODUCT OF EVOLUTION.

Setting aside, as devoid of scientific foundation, the idea of immediate supernatural intervention in the first production of life, we are not only justified in believing, but compelled to believe, that living matter must have owed its origin to causes similar in character to those which have been instrumental in producing all other forms of matter in the universe; in other words, to a process of gradual evolution.³ But it has been customary of late amongst biologists to shelve the investigation of the mode of origin of life by evolution from nonliving matter by relegating its solution to some former condition of the earth's history, when, it is assumed, opportunities were accidentally favorable for the passage of inanimate matter into animate; such opportunities, it is also assumed, having never since recurred and being never likely to recur.⁴

¹ It is fair to point out that Dr. Bastian suggests that the formation of ultra microscopic living particles may precede the appearance of the microscopic organisms which he describes.—*The Origin of Life*, 1911, p. 65.

² The present position of the subject is succinctly stated by Dr. Chalmers Mitchell in his article on "Abiogenesis" in the *Encyclopedia Britannica*. Dr. Mitchell adds: "It may be that in the progress of science it may yet be possible to construct living protoplasm from nonliving material. The refutation of abiogenesis has no further bearing on this possibility than to make it probable that if protoplasm ultimately be formed in the laboratory, it will be by a series of steps, the earlier steps being the formation of some substance or substances now unknown which are not protoplasm. Such intermediate stages may have existed in the past." And Huxley in his presidential address at Liverpool in 1870 says: "But though I can not express this conviction (i. e., of the impossibility of the occurrence of abiogenesis, as exemplified by the appearance of organisms in hermetically sealed and sterilized flasks) too strongly, I must carefully guard myself against the supposition that I intend to suggest that no such thing as abiogenesis ever has taken place in the past or ever will take place in the future. With organic chemistry, molecular physics, and physiology yet in their infancy and every day making prodigious strides, I think it would be the height of presumption for any man to say that the conditions under which matter assumes the properties we call 'vital' may not some day be artificially brought together."

³ The arguments in favor of this proposition have been arrayed by Meldola in his *Herbert Spencer Lecture*, 1910, pp. 16-24. Meldola leaves the question open whether such evolution has occurred only in past years or is also taking place now. He concludes that whereas certain carbon compounds have survived by reason of possessing extreme stability, others—the precursors of living matter—survived owing to the possession of extreme lability and adaptability to variable conditions of environment. A similar suggestion was previously made by Lockyer, *Inorganic Evolution*, 1900, pp. 169, 170.

⁴ T. H. Huxley, presidential address, 1870; A. B. Macallum, "On the Origin of Life on the Globe," in *Trans. Canadian Institute*, vol. 8.

Various eminent scientific men have even supposed that life has not actually originated upon our globe, but has been brought to it from another planet or from another stellar system. Some of my audience may still remember the controversy that was excited when the theory of the origin of terrestrial life by the intermediation of a meteorite was propounded by Sir William Thomson in his presidential address at the meeting of this association in Edinburgh in 1871. To this "meteorite" theory¹ the apparently fatal objection was raised that it would take some 60,000,000 years for a meteorite to travel from the nearest stellar system to our earth, and it is inconceivable that any kind of life could be maintained during such a period. Even from the nearest planet 150 years would be necessary, and the heating of the meteorite in passing through our atmosphere and at its impact with the earth would, in all probability, destroy any life which might have existed within it. A cognate theory, that of *cosmic panspermia*, assumes that life may exist and may have existed indefinitely in cosmic dust in the interstellar spaces (Richter, 1865; Cohn, 1872), and may with this dust fall slowly to the earth without undergoing the heating which is experienced by a meteorite. Arrhenius,² who adopts this theory, states that if living germs were carried through the ether by luminous and other radiations, the time necessary for their transportation from our globe to the nearest stellar system would be only 9,000 years, and to Mars only 20 days!

But the acceptance of such theories of the arrival of life on the earth does not bring us any nearer to a conception of its actual mode of origin; on the contrary, it merely serves to banish the investigation of the question to some conveniently inaccessible corner of the universe and leaves us in the unsatisfactory position of affirming not only that we have no knowledge as to the mode of origin of life—which is unfortunately true—but that we never can acquire such knowledge—which it is to be hoped is not true.³ Knowing what we know, and believing what we believe, as to the part played by evolution in the development of terrestrial matter, we are, I think (without denying the possibility of the existence of life in other parts of the universe⁴), justified in regarding these cosmic theories as inherently improbable—at least in comparison with the solution of the problem which the evolutionary hypothesis offers.⁵

¹ First suggested, according to Dastre, by de Salles-Guyon (Dastre, op. cit., p. 252). The theory received the support of Helmholtz.

² *Worlds in the Making*, transl. by H. Borns, Chap. VIII, p. 221, 1908.

³ "The History of science shows how dangerous it is to brush aside mysteries—i. e., unsolved problems—and to interpose the barrier placarded 'eternal—no thoroughfare.'"—R. Meldola, Herbert Spencer Lecture, 1910.

⁴ Some authorities, such as Errera, contend with much probability, that the conditions in interstellar space are such that life, as we understand it, could not possibly exist there.

⁵ As Verworn points out, such theories would equally apply to the origin of any other chemical combination, whether inorganic or organic, which is met with on our globe, so that they lead directly to absurd conclusions.—*Allgemeine Physiologie*, 1911.

THE EVOLUTIONARY HYPOTHESIS AS APPLIED TO THE ORIGIN OF LIFE.

I assume that the majority of my audience have at least a general idea of the scope of this hypothesis, the general acceptance of which has within the last 60 years altered the whole aspect not only of biology, but of every other branch of natural science, including astronomy, geology, physics, and chemistry.⁴ To those who have not this knowledge I would recommend the perusal of a little book by Prof. Judd, entitled "The Coming of Evolution," which has recently appeared as one of the Cambridge manuals. I know of no similar book in which the subject is as clearly and succinctly treated. Although the author nowhere expresses the opinion that the actual origin of life on the earth has arisen by evolution from nonliving matter, it is impossible to read either this or any similar exposition in which the essential unity of the evolutionary process is insisted upon without concluding that the origin of life must have been due to the same process, this process being, without exception, continuous, and admitting of no gap at any part of its course. Looking therefore at the evolution of living matter by the light which is shed upon it from the study of the evolution of matter in general, we are led to regard it as having been produced, not by a sudden alteration, whether exerted by natural or supernatural agency, but by a gradual process of change from material which was lifeless, through material on the borderland between inanimate and animate, to material which has all the characteristics to which we attach the term "life." So far from expecting a sudden leap from an inorganic, or at least an unorganized, into an organic and organized condition, from an entirely inanimate substance to a completely animate state of being, should we not rather expect a gradual procession of changes from inorganic to organic matter, through stages of gradually increasing complexity until material which can be termed living is attained? And in place of looking for the production of fully formed living organisms in hermetically sealed flasks, should we not rather search Nature herself, under natural conditions, for evidence of the existence, either in the past or in the present, of transitional forms between living and nonliving matter?

The difficulty, nay the impossibility, of obtaining evidence of such evolution from the past history of the globe is obvious. Both the hypothetical transitional material and the living material which

⁴ As Meldola insists, this general acceptance was in the first instance largely due to the writings of Herbert Spencer: "We are now prepared for evolution in every domain. * * * As in the case of most great generalizations, thought had been moving in this direction for many years. * * * Lamarck and Buffon had suggested a definite mechanism of organic development, Kant and Laplace a principle of celestial evolution, while Lyell had placed geology upon an evolutionary basis. The principle of continuity was beginning to be recognized in physical science. * * * It was Spencer who brought these independent lines of thought to a focus, and who was the first to make any systematic attempt to show that the law of development expressed in its widest and most abstract form was universally followed throughout cosmical processes, inorganic, organic, and superorganic."—Op. cit., p. 14.

was originally evolved from it may, as Macallum has suggested, have taken the form of diffused ultra-microscopic particles of living substances;¹ and even if they were not diffused but aggregated into masses, these masses could have been physically nothing more than colloidal watery slime which would leave no impress upon any geological formation. Myriads of years may have elapsed before some sort of skeleton in the shape of calcareous or siliceous spicules began to evolve itself, and thus enabled "life" which must already have possessed a prolonged existence, to make any sort of geological record. It follows that in attempting to pursue the evolution of living matter to its beginning in terrestrial history we can only expect to be confronted with a blank wall of nescience.

The problem would appear to be hopeless of ultimate solution, if we are rigidly confined to the supposition that the evolution of life has only occurred once in the past history of the globe. But are we justified in assuming that at one period only, and as it were by a fortunate and fortuitous concomitance of substance and circumstance, living matter became evolved out of nonliving matter—life became established? Is there any valid reason to conclude that at some previous period of its history our earth was more favorably circumstanced for the production of life than it is now?² I have vainly sought for such reason, and if none be forthcoming the conclusion forces itself upon us that the evolution of nonliving into living substance has happened more than once—and we can be by no means sure that it may not be happening still.

It is true that up to the present there is no evidence of such happening; no process of transition has hitherto been observed. But on the other hand, is it not equally true that the kind of evidence which would be of any real value in determining this question has not hitherto been looked for? We may be certain that if life is being produced from nonliving substance it will be life of a far simpler character than any that has yet been observed—in material which we shall be uncertain whether to call animate or inanimate, even if we are able to detect it at all, and which we may not be able to visualize physically even after we have become convinced of its existence.³ But we can look with the mind's eye and follow in imagination the transformation which nonliving matter may have

¹ There still exist in fact forms of life which the microscope can not show us (E. A. Minchin, presidential address to Quckett Club, 1911), and germs which are capable of passing through the pores of a Chamberland filter.

² Chalmers Mitchell (Art. "Life," *Encycl. Brit.*, eleventh edition) writes as follows: "It has been suggested from time to time that conditions very unlike those now existing were necessary for the first appearance of life, and must be repeated if living matter is to be reconstituted artificially. No support for such a view can be derived from observations of the existing conditions of life."—Cf. also J. Hall-Edwards, *op. cit.*

³ "Spontaneous generation of life could only be perceptually demonstrated by filling in the long terms of a series between the complex forms of inorganic and the simplest forms of organic substance. Were this done, it is quite possible that we should be unable to say (especially considering the vagueness of our definitions of life) where life began or ended."—K. Pearson, *Grammar of Science*, second edition, 1900, p. 350.

undergone and may still be undergoing to produce living substance. No principle of evolution is better founded than that insisted upon by Sir Charles Lyell, justly termed by Huxley "the greatest geologist of his time," that we must interpret the past history of our globe by the present; that we must seek for an explanation of what has happened by the study of what is happening; that, given similar circumstances, what has occurred at one time will probably occur at another. The process of evolution is universal. The inorganic materials of the globe are continually undergoing transition. New chemical combinations are constantly being formed and old ones broken up; new elements are making their appearance and old elements disappearing.¹ Well may we ask ourselves why the production of living matter alone should be subject to other laws than those which have produced, and are producing the various forms of nonliving matter; why what has happened may not happen. If living matter has been evolved from lifeless in the past, we are justified in accepting the conclusion that its evolution is possible in the present and in the future. Indeed, we are not only justified in accepting this conclusion, we are forced to accept it. When or where such change from nonliving to living matter may first have occurred, when or where it may have continued, when or where it may still be occurring, are problems as difficult as they are interesting, but we have no right to assume that they are insoluble.

Since living matter always contains water as its most abundant constituent, and since the first living organisms recognizable as such in the geological series were aquatic, it has generally been assumed that life must first have made its appearance in the depths of the ocean.² Is it, however, certain that the assumption that life originated in the sea is correct? Is not the land surface of our globe quite as likely to have been the nidus for the evolutionary transformation of nonliving into living material as the waters which surround it? Within this soil almost any chemical transformation may occur; it is subjected much more than matters dissolved in sea water to those fluctuations of moisture, temperature, electricity, and luminosity which are potent in producing chemical changes. But whether life, in the form of a simple slimy colloid, originated in the depths of the sea or on the surface of the land, it would be equally impossible for the geologist to trace its beginnings, and were it still becoming evolved in the same situations, it would be almost as impossible for the microscopist to follow its evolution. We are therefore not likely to obtain direct

¹ See on the production of elements, W. Crookes, Address to Section B, Brit. Assoc., 1886; T. Preston, *Nature*, Vol. LX, p. 180; J. J. Thomson, *Phil. Mag.*, 1897, p. 311; Norman Lockyer, *op. cit.*, 1900; G. Darwin, *Pres. Addr. Brit. Assoc.*, 1905.

² For arguments in favor of the first appearance of life having been in the sea, see A. B. Macallum, "The Paleochemistry of the Ocean," *Trans. Canad. Instit.*, 1903-4.

evidence regarding such a transformation of nonliving into living matter in nature, even if it is occurring under our eyes.

An obvious objection to the idea that the production of living matter from nonliving has happened more than once is that, had this been the case, the geological record should reveal more than one paleontological series. This objection assumes that evolution would in every case take an exactly similar course and proceed to the same goal—an assumption which is, to say the least, improbable. If, as might well be the case, in any other paleontological series than the one with which we are acquainted, the process of evolution of living beings did not proceed beyond Protista, there would be no obvious geological evidence regarding it; such evidence would only be discoverable by a carefully directed search made with that particular object in view.¹ I would not by any means minimize the difficulties which attend the suggestion that the evolution of life may have occurred more than once or may still be happening, but, on the other hand, it must not be ignored that those which attend the assumption that the production of life has occurred once only, are equally serious. Indeed, had the idea of the possibility of a multiple evolution of living substance been first in the field, I doubt if the prevalent belief regarding a single fortuitous production of life upon the globe would have become established among biologists—so much are we liable to be influenced by the impressions we receive in scientific childhood.

FURTHER COURSE OF EVOLUTION OF LIFE.

Assuming the evolution of living matter to have occurred—whether once only or more frequently matters not for the moment—and in the form suggested, viz, as a mass of colloidal slime possessing the property of assimilation and therefore of growth, reproduction would follow as a matter of course, for all material of this physical nature—fluid or semifluid in character—has a tendency to undergo subdivision when its bulk exceeds a certain size. The subdivision may be into equal or nearly equal parts, or it may take the form of buds. In either case every separated part would resemble the parent in chemical and physical properties, and would equally possess the property of taking in and assimilating suitable material from its liquid environment, growing in bulk, and reproducing its like by subdivision. *Omne vivum e vivo*. In this way from any beginning of living material a

¹ Lankester (Art. "Protozoa," *Encycl. Brit.*, tenth edition) conceives that the first protoplasm fed on the antecedent steps in its own evolution. F. J. Allen (*Brit. Assoc. Reports*, 1896), comes to the conclusion that living substance is probably constantly being produced, but that this fails to make itself evident owing to the substance being seized and assimilated by existing organisms. He believes that "in accounting for the first origin of life on this earth it is not necessary that, as Pflüger assumed, the planet should have been at a former period a glowing fireball." He "prefers to believe that the circumstances which support life would also favor its origin." And elsewhere: "Life is not an extraordinary phenomenon, not even an importation from some other sphere, but rather the actual outcome of circumstances on this earth."

primitive form of life would spread, and would gradually people the globe. The establishment of life being once effected, all forms of organization follow under the inevitable laws of evolution. *Ce n'est que le premier pas qui coûte!*

We can trace in imagination the segregation of a more highly phosphorized portion of the primitive living matter, which we may now consider to have become more akin to the protoplasm of organisms with which we are familiar. This more phosphorized portion might not for myriads of generations take the form of a definite nucleus, but it would be composed of material having a composition and qualities similar to those of the nucleus of a cell. Prominent among these qualities is that of catalysis—the function of effecting profound chemical changes in other material in contact with it without itself undergoing permanent change. This catalytic function may have been exercised directly by the living substance or may have been carried on through the agency of the enzymes already mentioned, which are also of a colloid nature but of simpler constitution than itself, and which differ from the catalytic agents employed by the chemist in the fact that they produce their effects at a relatively low temperature. In the course of evolution special enzymes would become developed for adaptation to special conditions of life, and with the appearance of these and other modifications a process of differentiation of primitive living matter into individuals with definite specific characters gradually became established. We can conceive of the production in this way from originally undifferentiated living substance of simple differentiated organisms comparable to the lowest forms of Protista. But how long it may have taken to arrive at this stage we have no means of ascertaining. To judge from the evidence afforded by the evolution of higher organisms it would seem that a vast period of time would be necessary for even this amount of organization to establish itself.

FORMATION OF THE NUCLEATED CELL.

The next important phase in the process of evolution would be the segregation and molding of the diffused or irregularly aggregated nuclear matter into a definite nucleus around which all the chemical activity of the organism will in future be centered. Whether this change were due to a slow and gradual process of segregation or of the nature of a jump, such as nature does occasionally make, the result would be the advancement of the living organism to the condition of a complete nucleated cell: a material advance not only in organization but—still more important—in potentiality for future development. Life is now embodied in the cell, and every living being evolved from this will itself be either a cell or a cell aggregate. *Omnis cellula e cellula.*

ESTABLISHMENT OF SEXUAL DIFFERENCES.

After the appearance of a nucleus—but how long after it is impossible to conjecture—another phenomenon appeared upon the scene in the occasional exchange of nuclear substance between cells. In this manner became established the process of sexual reproduction. Such exchange in the unicellular organism might and may occur between any two cells forming the species, but in the multicellular organism it became—like other functions—specialized in particular cells. The result of the exchange is rejuvenescence; associated with an increased tendency to subdivide and to produce new individuals. This is due to the introduction of a stimulating or catalytic chemical agent into the cell which is to be rejuvenated, as is proved by the experiments of Loeb already alluded to. It is true that the chemical material introduced into the germ cell in the ordinary process of its fertilization by the sperm cell is usually accompanied by the introduction of definite morphological elements which blend with others already contained within the germ cell, and it is believed that the transmission of such morphological elements of the parental nuclei is related to the transmission of parental qualities. But we must not be blind to the possibility that those transmitted qualities may be connected with specific chemical characters of the transmitted elements; in other words, that heredity also is one of the questions the eventual solution of which we must look to the chemist to provide.

AGGREGATE LIFE.

So far we have been chiefly considering life as it is found in the simplest forms of living substance, organisms for the most part entirely microscopic and neither distinctively animal nor vegetable, which have sometimes been grouped together as a separate kingdom of animated nature—that of Protista. But persons unfamiliar with the microscope are not in the habit of associating the term “life” with microscopic organisms, whether these take the form of cells or of minute portions of living substance which have not yet attained to that dignity. We most of us speak and think of life as it occurs in ourselves and other animals with which we are familiar; and as we find it in the plants around us. We recognize it in these by the possession of certain properties—movement, nutrition, growth, and reproduction. We are not aware by intuition, nor can we ascertain without the employment of the microscope, that we and all the higher living beings, whether animal or vegetable, are entirely formed of aggregates of nucleated cells, each microscopic and each possessing its own life. Nor could we suspect by intuition that what we term our life is not a single indivisible property, capable of being blown out with a puff like the flame of a candle; but is the aggregate of the

lives of many millions of living cells of which the body is composed. It is but a short while ago that this cell constitution was discovered: it occurred within the lifetime, even within the memory, of some who are still with us. What a marvelous distance we have traveled since then in the path of knowledge of living organisms! The strides which were made in the advance of the mechanical sciences during the nineteenth century, which are generally considered to mark that century as an age of unexampled progress, are as nothing in comparison with those made in the domain of biology, and their interest is entirely dwarfed by that which is aroused by the facts relating to the phenomena of life which have accumulated within the same period. And not the least remarkable of these facts is the discovery of the cell structure of plants and animals.

EVOLUTION OF THE CELL AGGREGATE.

Let us consider how cell aggregates came to be evolved from organisms consisting of single cells. Two methods are possible, viz: (1) The adhesion of a number of originally separate individuals; (2) the subdivision of a single individual without the products of its subdivision breaking loose from one another. No doubt this last is the manner whereby the cell aggregate was originally formed, since it is that by which it is still produced, and we know that the life history of the individual is an epitome of that of the species. Such aggregates were in the beginning solid; the cells in contact with one another and even in continuity; subsequently a space or cavity became formed in the interior of the mass, which was thus converted into a hollow sphere. All the cells of the aggregate were at first perfectly similar in structure and in function; there was no subdivision of labor. All would take part in effecting locomotion; all would receive stimuli from outside; all would take in and digest nutrient matter, which would then be passed into the cavity of the sphere to serve as a common store of nourishment. Such organisms are still found, and constitute the lowest types of Metazoa. Later one part of the hollow sphere became dimpled to form a cup; the cavity of the sphere became correspondingly altered in shape. With this change in structure differentiation of function between the cells covering the outside and those lining the inside of the cup made its appearance. Those on the outside subserved locomotor functions and received and transmitted from cell to cell stimuli, physical or chemical, received by the organism; while those on the inside, being freed from such functions, tended to specialize in the direction of the inception and digestion of nutrient material, which, passing from them into the cavity of the invaginated sphere, served for the nourishment of all the cells composing the organism. The further course of evolution produced many

changes of form and ever-increasing complexity of the cavity thus produced by simple invagination. Some of the cell aggregates settled down to a sedentary life, becoming plantlike in appearance and to some extent in habit. Such organisms, complex in form but simple in structure, are the sponges. Their several parts are not, as in the higher Metazoa, closely interdependent; the destruction of any one part, however extensive, does not either immediately or ultimately involve death of the rest; all parts function separately, although doubtless mutually benefiting by their conjunction, if only by slow diffusion of nutrient fluid throughout the mass. There is already some differentiation in these organisms, but the absence of a nervous system prevents any general coordination, and the individual cells are largely independent of one another.

Our own life, like that of all the higher animals, is an *aggregate life*; the life of the whole is the life of the individual cells. The life of some of these cells can be put an end to; the rest may continue to live. This is, in fact, happening every moment of our lives. The cells which cover the surface of our body, which form the scarf skin and the hair and nails, are constantly dying and the dead cells are rubbed off or cut away, their place being taken by others supplied from living layers beneath. But the death of these cells does not affect the vitality of the body as a whole. They serve merely as a protection or an ornamental covering, but are otherwise not material to our existence. On the other hand, if a few cells, such as those nerve cells under the influence of which respiration is carried on, are destroyed or injured, within a minute or two the whole living machine comes to a standstill, so that to the bystander the patient is dead; even the doctor will pronounce life to be extinct. But this pronouncement is correct only in a special sense. What has happened is that, owing to the cessation of respiration, the supply of oxygen to the tissues is cut off. And since the manifestations of life cease without this supply, the animal or patient appears to be dead. If, however, within a short period we supply the needed oxygen to the tissues requiring it, all the manifestations of life reappear.

It is only some cells which lose their vitality at the moment of so-called "general death." Many cells of the body retain their individual life under suitable circumstances long after the rest of the body is dead. Notable among these are muscle cells. McWilliams showed that the muscle cells of the blood vessels give indications of life several days after an animal has been killed. The muscle cells of the heart in mammals have been revived and caused to beat regularly and strongly many hours after apparent death. In man this result has been obtained as many as 18 hours after life has been pronounced extinct (Kuliabko); in animals after days have elapsed. Waller has shown that indications of life can be elicited from various tissues many

hours and even days after general death. Sherrington observed the white corpuscles of the blood to be active when kept in a suitable nutrient fluid weeks after removal from the blood vessels. A French histologist, Jolly, has found that the white corpuscles of the frog, if kept in a cool place and under suitable conditions, show at the end of a year all the ordinary manifestations of life. Carrell and Burrows have observed activity and growth to continue for long periods in the isolated cells of a number of tissues and organs kept under observation in a suitable medium. Carrell has succeeded in substituting entire organs obtained after death from one animal for those of another of the same species, and has thereby opened up a field of surgical treatment the limits of which can not yet be described. It is a well-established fact that any part of the body can be maintained alive for hours isolated from the rest if perfused with serum (Kronecker, frog heart), or with an oxygenated solution of salts in certain proportions (Ringer). Such revival and prolongation of the life of separated organs is an ordinary procedure in laboratories of physiology. Like all the other instances enumerated, it is based on the fact that the individual cells of an organ have a life of their own which is largely independent, so that they will continue in suitable circumstances to live, although the rest of the body to which they belonged may be dead.

But some cells, and the organs which are formed of them, are more necessary to maintain the life of the aggregate than others, on account of the nature of the functions which have become specialized in them. This is the case with the nerve cells of the respiratory center, since they preside over the movements which are necessary to effect oxygenation of the blood. It is also true for the cells which compose the heart, since this serves to pump oxygenated blood to all other cells of the body; without such blood most cells soon cease to live. Hence we examine respiration and heart to determine if life is present; when one or both of these are at a standstill we know that life can not be maintained. These are not the only organs necessary for the maintenance of life, but the loss of others can be borne longer, since the functions which they subserve, although useful or even essential to the organism, can be dispensed with for a time. The life of some cells is therefore more, of others less, necessary for maintaining the life of the rest. On the other hand, the cells composing certain organs have in the course of evolution ceased to be necessary, and their continued existence may even be harmful. Wiedersheim has enumerated more than a hundred of these organs in the human body. Doubtless nature is doing her best to get rid of them for us, and our descendants will some day have ceased to possess a vermiform appendix or a pharyngeal tonsil; until that epoch arrives we must rely for their removal on the more rapid methods of surgery.

MAINTENANCE OF LIFE OF CELL AGGREGATE IN HIGHER ANIMALS.

We have seen that in the simplest multicellular organisms, where one cell of the aggregate differs but little from another, the conditions for the maintenance of the life of the whole are nearly as simple as those for individual cells. But the life of a cell aggregate such as composes the bodies of the higher animals is maintained not only by the conditions for the maintenance of the life of the individual cell being kept favorable, but also by the coordination of the varied activities of the cells which form the aggregate. Whereas in the lowest Metazoa all cells of the aggregate are alike in structure and function and perform and share everything in common, in higher animals (and for that matter in the higher plants also) the cells have become specialized, and each is only adapted for the performance of a particular function. Thus the cells of the gastric glands are only adapted for the secretion of gastric juice, the cells of the villi for the absorption of digested matters from the intestine, the cells of the kidney for the removal of waste products and superfluous water from the blood, those of the heart for pumping blood through the vessels. Each of these cells has its individual life and performs its individual functions. But unless there were some sort of cooperation and subordination to the needs of the body generally, there would be sometimes too little, sometimes too much, gastric juice secreted; sometimes too tardy, sometimes too rapid, an absorption from the intestine; sometimes too little, sometimes too much, blood pumped into the arteries, and so on. As the result of such lack of cooperation the life of the whole would cease to be normal and would eventually cease to be maintained.

We have already seen what are the conditions which are favorable for the maintenance of life of the individual cell, no matter where situated. The principal condition is that it must be bathed by a nutrient fluid of suitable and constant composition. In higher animals this fluid is the lymph, which bathes the tissue elements and is itself constantly supplied with fresh nutriment and oxygen by the blood. Some tissue cells are directly bathed by blood; and in invertebrates, in which there is no special system of lymph vessels, all the tissues are thus nourished. All cells both take from and give to the blood, but not the same materials or to an equal extent. Some, such as the absorbing cells of the villi, almost exclusively give; others, such as the cells of the renal tubules, almost exclusively take. Nevertheless, the resultant of all the give and take throughout the body serves to maintain the composition of the blood constant under all circumstances. In this way the first condition of the maintenance of the life of the aggregate is fulfilled by insuring that the life of the individual cells composing it is kept normal.

The second essential condition for the maintenance of life of the cell aggregate is the coordination of its parts and the due regulation of their activity, so that they may work together for the benefit of the whole. In the animal body this is effected in two ways: First, through the nervous system; and, second, by the action of specific chemical substances which are formed in certain organs and carried by the blood to other parts of the body, the cells of which they excite to activity. These substances have received the general designation of "hormones" (*ὁρμῶν*, to stir up), a term introduced by Prof. Starling. Their action, and indeed their very existence, has only been recognized of late years, although the part which they play in the physiology of animals appears to be only second in importance to that of the nervous system itself; indeed, maintenance of life may become impossible in the absence of certain of these hormones.

NERVOUS SYSTEM IN MAINTENANCE OF AGGREGATE LIFE.

Before we consider the manner in which the nervous system serves to coordinate the life of the cell aggregate, let us see how it has become evolved.

The first step in the process was taken when certain of the cells of the external layer became specially sensitive to stimuli from outside, whether caused by mechanical impressions (tactile and auditory stimuli) or impressions of light and darkness (visual stimuli) or chemical impressions. The effects of such impressions were probably at first simply communicated to adjacent cells and spread from cell to cell throughout the mass. An advance was made when the more impressionable cells threw out branching feelers amongst the other cells of the organism. Such feelers would convey the effects of stimuli with greater rapidity and directness to distant parts. They may at first have been retractile, in this respect resembling the long pseudopodia of certain Rhizopoda. When they became fixed they would be potential nerve fibers and would represent the beginning of a nervous system. Even yet (as Ross Harrison has shown), in the course of development of nerve fibers, each fiber makes its appearance as an amœboid cell process which is at first retractile, but gradually grows into the position it is eventually to occupy and in which it will become fixed.

In the further course of evolution a certain number of these specialized cells of the external layer sank below the general surface, partly perhaps for protection, partly for better nutrition, they became nerve cells. They remained connected with the surface by a prolongation which became an afferent or sensory nerve fiber, and through its termination between the cells of the general surface continued to receive the effects of external impressions; on the other

hand, they continued to transmit these impressions to other, more distant cells by their efferent prolongations. In the further course of evolution the nervous system thus laid down became differentiated into distinct *afferent*, *efferent*, and *intermediary* portions. Once established, such a nervous system, however simple, must dominate the organism, since it would furnish a mechanism whereby the individual cells would work together more effectually for the mutual benefit of the whole.

It is the development of the nervous system, although not proceeding in all classes along exactly the same line, which is the most prominent feature of the evolution of the Metazoa. By and through it all impressions reaching the organism from the outside are translated into contraction or some other form of cell activity. Its formation has been the means of causing the complete divergence of the world of animals from the world of plants, none of which possess any trace of a nervous system. Plants react, it is true, to external impressions, and these impressions produce profound changes and even comparatively rapid and energetic movements in parts distant from the point of application of the stimulus—as in the well-known instance of the sensitive plant. But the impressions are in all cases propagated directly from cell to cell—not through the agency of nerve fibers; and in the absence of anything corresponding to a nervous system it is not possible to suppose that any plant can ever acquire the least glimmer of intelligence. In animals, on the other hand, from a slight original modification of certain cells has directly proceeded in the course of evolution the elaborate structure of the nervous system with all its varied and complex functions, which reach their culmination in the workings of the human intellect. "What a piece of work is a man! How noble in reason! How infinite in faculty! In form and moving how express and admirable! In action how like an angel! In apprehension how like a god!" But lest he be elated with his psychical achievements, let him remember that they are but the result of the acquisition by a few cells in a remote ancestor of a slightly greater tendency to react to an external stimulus, so that these cells were brought into closer touch with the outer world; while on the other hand, by extending beyond the circumscribed area to which their neighbors remained restricted, they gradually acquired a dominating influence over the rest. These dominating cells became nerve cells; and now not only furnish the means for transmission of impressions from one part of the organism to another, but in the progress of time have become the seat of perception and conscious sensation, of the formation and association of ideas, of memory, of volition, and all the manifestations of the mind.

REGULATION OF MOVEMENTS BY NERVOUS SYSTEM—VOLUNTARY
MOVEMENTS.

The most conspicuous part played by the nervous system in the phenomena of life is that which produces and regulates the general movements of the body—movements brought about by the so-called voluntary muscles. These movements are actually the result of impressions imparted to sensory or afferent nerves at the periphery, e. g., in the skin or in the several organs of special sense; the effect of these impressions may not be immediate, but can be stored for an indefinite time in certain cells of the nervous system. The regulation of movements—whether they occur instantly after reception of the peripheral impression or result after a certain lapse of time; whether they are accompanied by conscious sensation or are of a purely reflex and unconscious character—is an intricate process, and the conditions of their coordination are of a complex nature, involving not merely the causation and contraction of certain muscles, but also the prevention of the contraction of others. For our present knowledge of these conditions we are largely indebted to the researches of Prof. Sherrington.

INVOLUNTARY MOVEMENTS—EFFECTS OF EMOTIONS.

A less conspicuous but no less important part played by the nervous system is that by which the contractions of involuntary muscles are regulated. Under normal circumstances these are always independent of consciousness, but their regulation is brought about in much the same way as is that of the contractions of voluntary muscles, viz, as the result of impressions received at the periphery. These are transmitted by afferent fibers to the central nervous system, and from the latter other impulses are sent down, mostly along the nerves of the sympathetic or autonomic system of nerves, which either stimulate or prevent contraction of the involuntary muscles. Many involuntary muscles have a natural tendency to continuous or rhythmic contraction, which is quite independent of the central nervous system. In this case the effect of impulses received from the latter is merely to increase or diminish the amount of such contraction. An example of this double effect is observed in connection with the heart, which, although it can contract regularly and rhythmically when cut off from the nervous system and even if removed from the body, is normally stimulated to increased activity by impulses coming from the central nervous system through the sympathetic, or to diminished activity by others coming through the vagus. It is due to the readiness by which the action of the heart is influenced in these opposite ways by the spread of impulses generated during the nerve storms which we term "emotions" that in the

language of poetry, and even of every day, the word "heart" has become synonymous with the emotions themselves.

The involuntary muscle of the arteries has its action similarly balanced. When its contraction is increased the size of the vessels is lessened and they deliver less blood; the parts they supply accordingly become pale in color. On the other hand, when the contraction is diminished the vessels enlarge and deliver more blood; the parts which they supply become correspondingly ruddy. These changes in the arteries, like the effects upon the heart, may also be produced under the influence of emotions. Thus "blushing" is a purely physiological phenomenon due to diminished action of the muscular tissue of the arteries, whilst the pallor produced by fright is caused by an increased contraction of that tissue. Apart, however, from these conspicuous effects, there is constantly proceeding a less apparent but not less important balancing action between the two sets of nerve fibers distributed to heart and blood vessels, which are influenced in one direction or another by every sensation which we experience, and even by impressions of which we may be wholly unconscious, such as those which occur during sleep or anesthesia, or which affect our otherwise insensitive internal organs.

REGULATION OF SECRETION AND BODY TEMPERATURE.

A further instance of nerve regulation is seen in secreting glands. Not all glands are thus regulated, at least not directly; but in those which are the effects are striking. Their regulation is of the same general nature as that exercised upon involuntary muscle, but it influences the chemical activities of the gland cells and the outpouring of secretion from them. By means of this regulation a secretion can be produced or arrested, increased or diminished. As with muscle, a suitable balance is in this way maintained, and the activity of the glands is adapted to the requirements of the organism. Most of the digestive glands are thus influenced, as are the skin glands which secrete sweat. And by the action of the nervous system upon the skin glands, together with its effect in increasing or diminishing the blood supply to the cutaneous blood vessels, the temperature of our blood is regulated and is kept at the point best suited for maintenance of the life and activity of the tissues.

EFFECTS OF EMOTIONS ON SECRETION.

The action of the nervous system upon the secretion of glands is strikingly exemplified, as in the case of its action upon the heart and blood vessels by the effects of the emotions. Thus an emotion of one kind, such as the anticipation of food, will cause saliva to flow—"the mouth to water;" whereas an emotion of another kind, such as fear

or anxiety, will stop the secretion, causing the "tongue to cleave unto the roof of the mouth," rendering speech difficult or impossible. Such arrest of the salivary secretion also makes the swallowing of dry food difficult. Advantage of this fact is taken in the "ordeal by rice" which used to be employed in the East for the detection of criminals.

REGULATION BY CHEMICAL AGENTS.

The activities of the cells constituting our bodies are controlled, as already mentioned, in another way than through the nervous system, viz, by chemical agents (hormones) circulating in the blood. Many of these are produced by special glandular organs, known as internally secreting glands. The ordinary secreting glands pour their secretions on the exterior of the body or on a surface communicating with the exterior; the internally secreting glands pass the materials which they produce directly into the blood. In this fluid the hormones are carried to distant organs. Their influence upon an organ may be essential to the proper performance of its functions or may be merely ancillary to it. In the former case removal of the internally secreting gland which produces the hormone, or its destruction by disease, may prove fatal to the organism. This is the case with the suprarenal capsules, small glands which are adjacent to the kidneys, although having no physiological connection with these organs. A Guy's physician, Dr. Addison, in the middle of the last century showed that a certain affection, almost always fatal, since known by his name, is associated with disease of the suprarenal capsules. A short time after this observation a French physiologist, Brown-Séquard, found that animals from which the suprarenal capsules are removed rarely survive the operation for more than a few days. In the concluding decade of the last century interest in these bodies was revived by the discovery that they are constantly yielding to the blood a chemical agent (or hormone) which stimulates the contractions of the heart and arteries and assists in the promotion of every action which is brought about through the sympathetic nervous system (Langley). In this manner the importance of their integrity has been explained, although we have still much to learn regarding their functions.

THYROID AND PARATHYROIDS.

Another instance of an internally secreting gland which is essential to life, or at least to its maintenance in a normal condition, is the thyroid. The association of imperfect development or disease of the thyroid with disorders of nutrition and inactivity of the nervous system is well ascertained. The form of idiocy known as cretinism and the affection termed "myxœdema" are both associated with deficiency of its secretion; somewhat similar conditions to these are produced by the surgical removal of the gland. The symptoms are alleviated

or cured by the administration of its juice. On the other hand, enlargement of the thyroid, accompanied by increase of its secretion, produced symptoms of nervous excitation, and similar symptoms are caused by excessive administration of the glandular substance by the mouth. From these observations it is inferred that the juice contains hormones which help to regulate the nutrition of the body and serve to stimulate the nervous system, for the higher functions of which they appear to be essential. To quote M. Gley, to whose researches we owe much of our knowledge regarding the functions of this organ, "*La genèse et l'exercice des plus hautes facultés de l'homme sont conditionnés par l'action purement chimique d'un produit de sécrétion. Que les psychologues méditent ces faits.*"

The case of the parathyroid glandules is still more remarkable. These organs were discovered by Sandström in 1880. They are four minute bodies, each no larger than a pin's head, embedded in the thyroid. Small as they are, their internal secretion possesses hormones which exert a powerful influence upon the nervous system. If they are completely removed, a complex of symptoms, technically known as "tetany," is liable to occur, which is always serious and may be fatal. Like the hormones of the thyroid itself, therefore, those of the parathyroids produce effects upon the nervous system, to which they are carried by the blood, although the effects are of a different kind.

PITUITARY GLAND.

Another internally secreting gland which has evoked considerable interest during the last few years is the pituitary body. This is a small structure no larger than a cob nut attached to the base of the brain. It is mainly composed of glandular cells. Its removal has been found (by most observers) to be fatal—often within two or three days. Its hypertrophy, when occurring during the general growth of the body, is attended by an undue development of the skeleton, so that the stature tends to assume gigantic proportions. When the hypertrophy occurs after growth is completed, the extremities, viz, the hands and feet and the bones of the face, are mainly affected; hence the condition has been termed "acromegaly" (enlargement of extremities). The association of this condition with affections of the pituitary was pointed out in 1885 by a distinguished French physician, Dr. Pierre Marie. Both "giants" and "acromegalists" are almost invariably found to have an enlarged pituitary. The enlargement is generally confined to one part—the anterior lobe—and we conclude that this produces hormones which stimulate the growth of the body generally and of the skeleton in particular. The remainder of the pituitary is different in structure from the anterior lobe and has a different function. From it hormones can be extracted which, like those of the suprarenal capsule, although not

exactly in the same manner, influence the contraction of the heart and arteries. Its extracts are also instrumental in promoting the secretion of certain glands. When injected into the blood they cause a free secretion of water from the kidneys and of milk from the mammary glands, neither of which organs are directly influenced (as most other glands are) through the nervous system. Doubtless under natural conditions these organs are stimulated to activity by hormones which are produced in the pituitary and which pass from this into the blood.

The internally secreting glands which have been mentioned (thyroid, parathyroid, suprarenal, pituitary) have, so far as is known, no other function than that of producing chemical substances of this character for the influencing of other organs, to which they are conveyed by the blood. It is interesting to observe that these glands are all of very small size, none being larger than a walnut, and some—the parathyroids—almost microscopic. In spite of this, they are essential to the proper maintenance of the life of the body, and the total removal of any of them by disease or operation is in most cases speedily fatal.

PANCREAS.

There are, however, organs in the body yielding internal secretions to the blood in the shape of hormones, but exercising at the same time other functions. A striking instance is furnished by the pancreas, the secretion of which is the most important of the digestive juices. This—the pancreatic juice—forms the external secretion of the gland, and is poured into the intestine, where its action upon the food as it passes out from the stomach has long been recognized. It was, however, discovered in 1889 by Von Mering and Minkowski that the pancreas also furnishes an internal secretion, containing a hormone which is passed from the pancreas into the blood, by which it is carried first to the liver and afterwards to the body generally. This hormone is essential to the proper utilization of carbohydrates in the organism. It is well known that the carbohydrates of the food are converted into grape sugar and circulate in this form in the blood, which always contains a certain amount; the blood conveys it to all the cells of the body, and they utilize it as fuel. If, owing to disease of the pancreas or as the result of its removal by surgical procedure, its internal secretion is not available, sugar is no longer properly utilized by the cells of the body and tends to accumulate in the blood; from the blood the excess passes off by the kidneys, producing diabetes.

DUODENUM.

Another instance of an internal secretion furnished by an organ which is devoted largely to other functions is the "prosecretin" found in the cells lining the duodenum. When the acid gastric juice

comes into contact with these cells it converts their prosecretin into "secretin." This is a hormone which is passed into the blood and circulates with that fluid. It has a specific effect on the externally secreting cells of the pancreas and causes the rapid outpouring of pancreatic juice into the intestine. This effect is similar to that of the hormones of the pituitary body upon the cells of the kidney and mammary gland. It was discovered by Bayliss and Starling.

INTERNAL SECRETIONS OF REPRODUCTIVE ORGANS.

The reproductive glands furnish in many respects the most interesting example of organs which—besides their ordinary products, the germ and sperm cells (ova and spermatozoa)—form hormones which circulate in the blood and effect changes in cells of distant parts of the body. It is through these hormones that the secondary sexual characters, such as the comb and tail of the cock, the mane of the lion, the horns of the stag, the beard and enlarged larynx of a man, are produced as well as the many differences in form and structure of the body which are characteristic of the sexes. The dependence of these so-called secondary sexual characters upon the state of development of the reproductive organs has been recognized from time immemorial, but has usually been ascribed to influences produced through the nervous system, and it is only in recent years that the changes have been shown to be brought about by the agency of internal secretions and hormones, passed from the reproductive glands into the circulating blood.¹

CHEMICAL NATURE OF HORMONES.

It has been possible in only one or two instances to prepare and isolate the hormones of the internal secretions in a sufficient condition of purity to subject them to analysis, but enough is known about them to indicate that they are organic bodies of a not very complex nature, far simpler than proteins and even than enzymes. Those which have been studied are all dialysable, are readily soluble in water, but insoluble in alcohol, and are not destroyed by boiling. One at least—that of the medulla of the suprarenal capsule—has been prepared synthetically, and when their exact chemical nature has been somewhat better elucidated it will probably not be difficult to obtain others in the same way.

From the above it is clear that not only is a coordination through the nervous system necessary in order that life shall be maintained in a normal condition, but a chemical coordination is no less essential. These may be independent of one another; but on the other hand they may react upon one another. For it can be shown that the production of some at least of the hormones is under the influence of

¹ The evidence is to be found in F. H. A. Marshall, *The Physiology of Reproduction*, 1911.

the nervous system (Biedl, Asher, Elliott); whilst, as we have seen, some of the functions of the nervous system are dependent upon hormones.

PROTECTIVE CHEMICAL MECHANISMS.

Time will not permit me to refer in any but the briefest manner to the protective mechanisms which the cell aggregate has evolved for its defense against disease, especially disease produced by parasitic microorganisms. These, which with few exceptions are unicellular, are without doubt the most formidable enemies which the multicellular Metazoa, to which all the higher animal organisms belong, have to contend against. To such microorganisms are due *inter alia* all diseases which are liable to become epidemic, such as anthrax and rinderpest in cattle, distemper in dogs and cats, smallpox, scarlet fever, measles, and sleeping sickness in man. The advances of modern medicine have shown that the symptoms of these diseases—the disturbances of nutrition, the temperature, the lassitude or excitement, and other nervous disturbances—are the effects of chemical poisons (toxins) produced by the microorganisms and acting deleteriously upon the tissues of the body. The tissues, on the other hand, endeavor to counteract these effects by producing other chemical substances destructive to the microorganisms or antagonistic to their action: these are known as *antibodies*. Sometimes the protection takes the form of a subtle alteration in the living substance of the cells which renders them for a long time, or even permanently, insusceptible (immune) to the action of the poison. Sometimes certain cells of the body, such as the white corpuscles of the blood, eat the invading microorganisms and destroy them bodily by the action of chemical agents within their protoplasm. The result of an illness thus depends upon the result of the struggle between these opposing forces—the microorganisms on the one hand and the cells of the body on the other—both of which fight with chemical weapons. If the cells of the body do not succeed in destroying the invading organisms, it is certain that the invaders will in the long run destroy them, for in this combat no quarter is given. Fortunately we have been able, by the aid of animal experimentation, to acquire some knowledge of the manner in which we are attacked by microorganisms and of the methods which the cells of our body adopt to repel the attack, and the knowledge is now extensively utilized to assist our defense. For this purpose protective serums or antitoxins, which have been formed in the blood of other animals, are employed to supplement the action of those which our own cells produce. It is not too much to assert that the knowledge of the parasitic origin of so many diseases and of the chemical agents which on the one hand cause, and on the other combat, their symptoms, has transformed medicine from a mere art practiced empirically into a real science

based upon experiment. The transformation has opened out an illimitable vista of possibilities in the direction not only of cure, but, more important still, of prevention. It has taken place within the memory of most of us who are here present. And only last February the world was mourning the death of one of the greatest of its benefactors—a former president of this association¹—who, by applying this knowledge to the practice of surgery, was instrumental, even in his own lifetime, in saving more lives than were destroyed in all the bloody wars of the nineteenth century!

SENESCENCE AND DEATH.

The question has been debated whether, if all accidental modes of destruction of the life of the cells could be eliminated, there would remain a possibility of individual cell life, and even of aggregate cell life, continuing indefinitely; in other words, Are the phenomena of senescence and death a natural and necessary sequence to the existence of life? To most of my audience it will appear that the subject is not open to debate. But some physiologists (e. g., Metchnikoff) hold that the condition of senescence is itself abnormal; that old age is a form of disease or is due to disease, and, theoretically at least, is capable of being eliminated. We have already seen that individual cell life, such as that of the white blood corpuscles and of the cells of many tissues, can under suitable conditions be prolonged for days or weeks or months after general death. Unicellular organisms kept under suitable conditions of nutrition have been observed to carry on their functions normally for prolonged periods and to show no degeneration such as would accompany senescence. They give rise by division to others of the same kind, which also, under favorable conditions, continue to live, to all appearance indefinitely. But these instances, although they indicate that in the simplest forms of organization existence may be greatly extended without signs of decay, do not furnish conclusive evidence of indefinite prolongation of life. Most of the cells which constitute the body, after a period of growth and activity, sometimes more, sometimes less prolonged, eventually undergo atrophy and cease to perform satisfactorily the functions which are allotted to them. And when we consider the body as a whole, we find that in every case the life of the aggregate consists of a definite cycle of changes which, after passing through the stages of growth and maturity, always leads to senescence, and finally terminates in death. The only exception is in the reproductive cells, in which the processes of maturation and fertilization result in rejuvenescence, so that instead of the usual downward change toward senescence, the fertilized ovum obtains a new lease of life, which is carried on into the new-formed organism. The latter

¹ Lord Lister was president at Liverpool in 1896.

again itself ultimately forms reproductive cells, and thus the life of the species is continued. It is only in the sense of its propagation in this way from one generation to another that we can speak of the indefinite continuance of life; we can only be immortal through our descendants!

AVERAGE DURATION OF LIFE AND POSSIBILITY OF ITS PROLONGATION.

The individuals of every species of animal appear to have an average duration of existence.¹ Some species are known the individuals of which live only for a few hours, whilst others survive for a hundred years.² In man himself the average length of life would probably be greater than the three-score and ten years allotted to him by the Psalmist if we could eliminate the results of disease and accident; when these results are included it falls far short of that period. If the terms of life given in the purely mythological part of the Old Testament were credible, man would in the early stages of his history have possessed a remarkable power of resisting age and disease. But, although many here present were brought up to believe in their literal veracity, such records are no longer accepted even by the most orthodox of theologians, and the nine hundred odd years with which Adam and his immediate descendants are credited, culminating in the 969 of Methuselah, have been relegated, with the account of Creation and the Deluge, to their proper position in literature. When we come to the Hebrew Patriarchs, we notice a considerable diminution to have taken place in what the insurance officers term the "expectation of life." Abraham is described as having lived only to 175 years, Joseph and Joshua to 110, Moses to 120; even at that age "his eye was not dim nor his natural force abated." We can not say that under ideal conditions all these terms are impossible; indeed, Metchnikoff is disposed to regard them as probable; for great ages are still occasionally recorded, although it is doubtful if any as considerable as these are ever substantiated. That the expectation of life was better then than now would be inferred from the apologetic tone adopted by Jacob when questioned by Pharaoh as to his age: "The days of the years of my pilgrimage are an hundred and thirty years; few and evil have the days of the years of my life been, and have not attained unto the days of the years of the life of my fathers in the days of their pilgrimage." David, to whom, before the advent of the modern statistician, we owe the idea that 70 years is to be regarded as the normal period of life,³

¹ This was regarded by Buffon as related to the period of growth, but the ratio is certainly not constant. The subject is discussed by Ray Lankester in an early work, *On Comparative Longevity in Man and Animals*, 1870.

² The approximately regular periods of longevity of different species of animals furnishes a strong argument against the theory that the decay of old age is an accidental phenomenon, comparable with disease.

³ The expectation of life of a healthy man of 50 is still reckoned at about 20 years.

is himself merely stated to have "died in a good old age." The periods recorded for the Kings show a considerable falling off as compared with the Patriarchs; but not a few were cut off by violent deaths, and many lived lives which were not ideal. Amongst eminent Greeks and Romans few very long lives are recorded, and the same is true of historical persons in mediæval and modern history. It is a long life that lasts much beyond 80; three such linked together carry us far back into history. Mankind is in this respect more favored than most mammals, although a few of these surpass the period of man's existence.¹ Strange that the brevity of human life should be a favorite theme of preacher and poet when the actual term of his "erring pilgrimage" is greater than that of most of his fellow creatures.

THE END OF LIFE.

The modern applications of the principles of preventive medicine and hygiene are no doubt operating to lengthen the average life. But even if the ravages of disease could be altogether eliminated, it is certain that at any rate the fixed cells of our body must eventually grow old and ultimately cease to function; when this happens to cells which are essential to the life of the organism, general death must result. This will always remain the universal law, from which there is no escape. "All that lives must die, passing through nature to eternity."

Such natural death unaccelerated by disease—is not death by disease as unnatural as death by accident?—should be a quiet, painless phenomenon, unattended by violent change. As Dastre expresses it, "The need of death should appear at the end of life, just as the need of sleep appears at the end of the day." The change has been led gradually up to by an orderly succession of phases, and is itself the last manifestation of life. Were we all certain of a quiet passing—were we sure that there would be "no moaning of the bar when we go out to sea"—we could anticipate the coming of death after a ripe old age without apprehension. And if ever the time shall arrive when man will have learned to regard this change as a simple physiological process, as natural as the oncoming of sleep, the approach of the fatal shears will be as generally welcomed as it is now abhorred. Such a day is still distant; we can hardly say that its dawning is visible. Let us at least hope that, in the manner depicted by Dürer in his well-known etching, the sunshine which science irradiates may eventually put to flight the melancholy which hovers, batlike, over the termination of our lives, and which even the anticipation of a future happier existence has not hitherto succeeded in dispersing.

¹"Hominis ævum cæterorum animalium omnium superat præter admodum paucorum."—Francis Bacon, *Historia vitæ et mortis*, 1637.



THE ORIGIN OF LIFE: A CHEMIST'S FANTASY.¹

By H. E. ARMSTRONG.

"Behold, the beginning of philosophy is the observation of how men contradict each other and the search whence cometh this contradiction and the censure and mistrust of bare opinion. And it is an inquiry into that which seems, whether it rightly seems; and the discovery of a certain rule, even as we have found a balance for weights and a plumb-line for straight and crooked. This is the beginning of philosophy."—EPICETUS.

The presidential address delivered recently to the British Association at Dundee by Prof. Schäfer and the subsequent independent discussion, at a joint sitting of the physiological and zoological sections of the Association, of the subject considered in the president's discourse will at least have served as a corrective to the wave of vitalism that has passed over society of late years, owing to the pervasive eloquence of Bergson and other writers who have elected to discuss the problems of life, mainly from the metaphysical and psychological points of view, with little reference to the knowledge gained by experimental inquiry.

As Prof. Schäfer himself remarked, the problem of the origin of life is at root a chemical problem. It is somewhat surprising, therefore, that the chemists were not invited to join in the debate at Dundee. Judging from the remarks that fell from several of the speakers, their sobering presence was by no means unnecessary. It is clear that, so long as biologists are satisfied with the modicum of chemistry which is now held to serve their purpose, they will never be able to escape from the region of vague surmise.

On the Tuesday Prof. Macallum fancifully pictured the earth as at one time "a gigantic laboratory where there had been a play of tremendous forces, notably electricity, which might have produced millions of times organisms that survived but a few hours, but in which also, by a favorable conjunction of those forces, what we now call life might have come into existence." I think I heard him then refer to the great stores of oil we now possess and imply that they

¹ Reprinted by permission from *Science Progress in the Twentieth Century*, No. 26, October, 1912. London, pp. 312-329.

came into existence in those times. Chemists and geologists would be in agreement, I believe, that these oils were formed at a somewhat late geological epoch and that they are derived from fatty materials laid down as remains of organisms.

Prof. Benjamin Moore, brimming over with biotic energy, afterwards told us that "something more than structure was necessary for life." He preferred a dynamic view which embraced energy, motion, and change; * * * all the actions of the cell were concerned with the liberation of energy and its transformation into many forms. For the origin of life * * * it was necessary to start with the formation of organic bodies. The colloids, which were large aggregates of molecules, began to show the properties of dawning life, but it was needful also to get an energy transformer attached to the colloid. He also insisted that "the problem was metaphysical at the present moment, as through all the ages the process of life was going on. As soon as the colloids got under the influence of sunlight they started synthesizing organic bodies. That process was going on now."

In making such statements Prof. Moore allowed his imagination to run away with him; his assertions can not be justified. Vague, sweeping generalities are out of place in such a discussion. Unless the steps be made clear, there can be no logic in the argument.

No doubt something more than structure is necessary for life. Nevertheless life is dependent on structure—just as is the activity of the steam engine. The steam engine is essentially a dynamic machine; it lives only when fuel is burnt under its boiler, but the energy liberated in combustion is brought into action through the agency of a complex mechanism. And it is worth noting that by a slight extension of this mechanism the engine may be made to "remember," and even talk. Thus, if it be caused to draw a steel tape across the magnetic pole of a telephone while the drum of the instrument is being talked at, the message is taken down by the tape; if the tape be then drawn back in the reverse direction, the drum of the telephone will speak and deliver the message remembered in the tape. Surely such an analogy with life is worth considering. Of course it will be said that the engine is fashioned by an intelligence external to itself and if we suppose that life may have been self-constituted, to obtain a hearing we must discover the means of self-constitution.

Sir William Tilden, in a letter to *The Times* (Sept. 10, 1912), after referring to the various raw materials available on the earth, remarks:

I venture to think that no chemist will be prepared to suggest a process by which, from the interaction of such materials, anything approaching a substance of the nature of a proteid could be formed or, if by a complex series of changes a compound of this kind were conceivably produced, that it would present the characters of living protoplasm.

He appears to deprecate discussion of the problem, judging from the concluding sentence of his letter:

Far be it from any man of science to affirm that any given set of phenomena is not a fit subject of inquiry and that there is any limit to what may be revealed in answer to systematic and well-directed investigation. In the present instance, however, it appears to me that this is not a field for the chemist nor one in which chemistry is likely to afford any assistance whatever.

I agree with Sir William Tilden that Prof. Schäfer's address "leaves us exactly where we were" and that the "earlier part of the discourse leaves open the question as to a criterion by which living may be distinguished from nonliving matter." But I can not accept his statement that "we have at present, therefore, no clear idea as to what life is, and therefore no clear road open to the study of the conditions under which it originated."

Like Prof. Schäfer, I do not find myself in the least helped by the idea that life has originated elsewhere; by adopting such a conclusion we only shift the difficulty a stage farther back. I agree, too, with Prof. Minchin in thinking that if life had reached us from other worlds it would have found our earth unprepared to receive it and would have been starved out of existence; this question of food supply has not been taken into consideration by the advocates of the hypothesis. If there be life elsewhere, on other worlds than ours, the probability is that it more or less resembles life as we know it. To judge from spectroscopic evidence, the materials of which our world consists are those which constitute the cosmos. There is but one element in which the potency of life can be said to exist—the element carbon; the complexities and variations which are met with in animate material are only possible apparently in a material of which carbon is the essential constituent. Carbon stands alone among the elements. It is the only one known to us whose atoms hang together in large numbers and can be arranged in a great variety of patterns. The peculiarities of animate matter may certainly be said to be in large measure determined by the presence of carbon, though nitrogen and oxygen, of course, play an all-important part. Our peculiarities may well prove to be traceable ultimately to those of the elements of which we are built—indeed it can not well be otherwise—yet the difference must be vast between elementary material and living material. It is waste of time, I believe, to pay much attention to the argument from analogy; indeed I feel that Prof. Schäfer relied too much on analogy in the earlier part of his address.

As Dr. Haldane points out, "Living organisms are distinguished from everything else that we at present know by the fact that they maintain and reproduce themselves with their characteristic structure and activities. Nothing resembling this phenomenon is at

present known to us in the inorganic world." I do not understand, however, why he goes on to say, "and if, as we may confidently hope, similar phenomena are ultimately found in what we at present call the inorganic world, our present conception of that world as a mere world of matter would be completely altered." Of course it would, but the eventuality is one that I, as a chemist, can not contemplate as possible; far from having confident hope, I believe such discovery to be out of the question.

Prof. Schäfer says the contention is fallacious that growth and reproduction are properties possessed only by living bodies and refers to the growth of crystals; but in this and not a few other cases, as I have said, he carries the argument from analogy too far. The growth of crystals is a process of mere apposition of like simple units, which become assembled, time after time, in similar fashion like so many bricks; and there is no limit to crystal growth. Given proper conditions, large crystals inevitably increase at the expense of the smaller similar crystals present along with them in a solution; hence it is that occasionally in nature, crystals are met with of huge size. The multiplication of similar crystals is the consequence of the presence of a multiplicity of nuclei in a solution; nothing corresponding to cell division is ever observed in cases of inorganic growth. Organic growth is clearly a process of extreme complexity, one that involves the association by a variety of operations of a whole series of diverse units.

It is impossible to regard demonstrations such as Leduc has given with silica and other simple colloids as in any way comparable with the phenomena of organic growth.

Moreover, Loeb's experiments are wrongly quoted by Schäfer as instances of *sexual* reproduction. What Loeb has done has been to show that the life cycle may be started afresh by the introduction of an excitant into the ovum and has thereby shown that the process of fertilization by the spermatozoon is one in which at least two events are scored, the one being the incorporation of male elements with female elements, whereby biparental inheritance is secured, the other the introduction of an excitant (hormone) which conditions the renewal of the vital cycle of the organism; but the development is that of an incomplete being whose somatic cells lack half the normal number of chromosomes.

Three years ago, in my address to Section B of the British Association at Winnipeg, I had the temerity to do what Sir William Tilden says no chemist will be prepared to do, as witness the following passage:

The general similarity of structure throughout organized creation may well be conditioned primarily by properties inherent in the materials of which all living things are composed—of carbon, of oxygen, of nitrogen, of hydrogen, of phosphorus, of sul-

phur. At some early period, however, the possibilities became limited and directed processes became the order of the day. From that time onward the chemistry prevailing in organic nature became a far simpler chemistry than that of the laboratory; the possibilities were diminished, the certainties of a definite line of action were increased. How this came about it is impossible to say; mere accident may have led to it. Thus we may assume that some relatively simple asymmetric substance was produced by the fortuitous occurrence of a change under conditions such as obtain in our laboratories and that consequently the enantiomorphous isomeric forms of equal opposite activity were produced in equal amount. We may suppose that a pool containing such material having been dried up dust of molecular fineness was dispersed; such dust falling into other similar pools near the crystallization point may well have conditioned the separation of only one of the two isomeric forms present in the liquid. A separation having been once effected in this manner, assuming the substance to be one which could influence its own formation, one form rather than the other might have been produced. An active substance thus generated and selected out might then become the origin of a series of asymmetric syntheses. How the complicated series of changes which constitute life may have arisen we can not even guess at present; but when we contemplate the inherent simplicity of chemical change and bear in mind that life seems but to depend on the simultaneous occurrence of a series of changes of a somewhat diverse order, it does not appear to be beyond the bounds of possibility to arrive at a broad understanding of the method of life. Nor are we likely to be misled into thinking that we can so arrange the conditions as to control and reproduce it; the series of lucky accidents which seem to be required for arrangements of such complexity to be entered upon is so infinitely great.

It is permissible now, perhaps, to enter somewhat more at length into an explanation of the changes contemplated in this passage.

Growth most certainly proceeds on determined lines—"directive influences are the paramount influences at work in building up living tissues" (Winnipeg address). What Prof. Schäfer has not pointed out, in contrasting the growth of inorganic and of animal matter, is that nature now works on very narrow lines, making use of but little of the wealth of material primarily at her disposal. Selective influences must have been at work from the earliest stages of the evolution of life onward. It is in this respect, perhaps, more than any other that the inorganic differs so greatly from the organic; it is this circumstance, too, more than any other which makes it so improbable that life should arise frequently *de novo* from simple materials not themselves the products of vital action.

To give an example, the hexose, glucose—a constituent of every plant and animal—is one of 16 isomeric compounds, all represented by the formula

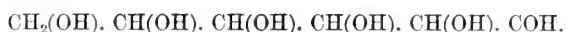

Of these 16 compounds, 14 have actually been prepared in the laboratory, and they differ considerably in properties. The differences are due to the different distribution in space of the H and OH groups relatively to the carbon atoms. The 16 compounds form 8 pairs, and as the individual members of each pair have the power of rotating

polarized light in opposite directions, though to an equal extent, they may be said to be half right-hand and half left-hand material.

Two other hexose sugars isomeric with glucose occur naturally—galactose and mannose; but the three compounds all belong to the one series and all may be said to be right-hand material.

Besides these three hexose sugars, plants also contain the ketose, fructose, which is isomeric with glucose and differs from it only in containing the CO group as the second instead of as the terminal member in the chain of radicles composing the molecule:



Fructose is convertible into glucose, and vice versa. Natural fructose and glucose are both right-hand material. Nature apparently is single handed and can make and wear only right-hand gloves.

It is possible to prepare such compounds in the laboratory from the simplest materials, starting from carbonic acid— $\text{CO}(\text{OH})_2$ —the compound from which the plant derives carbon. By reduction this is first converted into formaldehyde, COH_2 . When digested with weak alkali, this aldehyde is in part converted into fructose; the fructose that is formed, however, is not merely the form which is found in plants but a mixture of this with an equal proportion of the left-hand form. When the chemist makes gloves, he usually can not help making them in pairs for both hands.

Some directive influence is clearly at work in the plant—the formaldehyde molecules, which it undoubtedly makes use of as primary building material, in some way become so arranged that when they interact they give only the right-hand form of sugar. There is reason to think, moreover, that the action takes place only in this one direction—that the sugar is the only product. My own belief is that the synthesis is effected against a sugar template¹ just as a brick arch is built upon a wooden template curved as the arch is to be curved.

A similar argument is applicable to the albuminoid or protein matters derived from animal and vegetable materials; in fact, to nearly all the natural optically active substances; these are all formed under directive influences. It is not improbable that, excepting a few which presumably are products of retrograde changes, they are all of one type—right-hand material—and apparently they stand in close genetic connection.

Prof. Minchin has difficulty, he says, in understanding how the complex proteins could have arisen in nature. But the difficulty in accounting for these is no greater than that involved in accounting for the formation of the sugars. The chief difference between the two classes of compound is that whereas the sugars are composed of like simple units, the albuminoids consist of unlike simple units,

¹ Proceedings of the Royal Society, 1904, vol. 73, 541.

chiefly the various amino-acids. The carbohydrate may be compared with a house built of bricks alone, the albuminoids with a house built partly of bricks and partly of stone slabs of various shapes and sizes; the latter form of construction permits of a greater variety of pattern but the same building operations are involved in the use of the two kinds of material; though the constructive units are different, in both cases, the pieces are placed in position and fixed by means of mortar in a similar way.

The directive influences at work and which preside over synthetic operations in the plant and animal cell are undoubtedly the enzymes; these apparently serve as templates and either promote synthesis by dehydration or the reverse change of hydrolysis, according as the degree of concentration is varied.

But how, it will be asked, could action have taken place in times prior to the existence of enzymes? What are enzymes, and how did they arise?

The activity of enzymes is comparable with that of acids and alkalis, the former especially, with the exception that enzymes act selectively; but whereas acids will hydrolyze every kind of ethereal compound and are active in proportion to their strength and the concentration of the solution in which they are operative, enzymes will act only on particular compounds; hence their special value as "vital" agents. And the same distinction is to be made with respect to the synthetic activity of the two groups of agents.

At present our knowledge of enzymes is vague; we know little of their structure. At most we can assert that they are colloid materials and that in some way or other they are adaptable to the compounds upon which they act. The picture I form of an enzyme is that of a minute droplet of jelly to which is attached a protuberance very closely resembling if not identical with the group to which the enzyme can be affixed. A geometer caterpillar attached by its hind legs to a twig, with body raised so as to bring the mouth against a leaf on the twig, affords a rough analogy, to my thinking, of the *system* within which, and within which alone, an enzyme is active.

In the beginning of things, carbonic acid was doubtless superabundant and reducing agents were not far to seek; under such conditions formaldehyde may well have been an abundant natural product. The production of fructose sugar, if not of glucose, would be practically a necessary sequence to that of formaldehyde.

But at this early stage, under natural conditions, gloves were always made in pairs, left-hand and right-hand in equal numbers; by chance, somewhere, something happened by which the balance was disturbed; some of the left-hand gloves were destroyed, perhaps.

It is well known that if a crystal be placed in a saturated solution of its own substance, the surface molecules will attract like molecules

from the solution and the crystal will grow. It is not unlikely that a substance may exercise attraction over molecules which are its own proximate constituents—that glucose, for example, may exercise a preferential attraction over molecules of formaldehyde; if such be the case, glucose may itself serve to influence and promote the formation of glucose from formaldehyde.

Granting such a possibility, if by some accident right-hand molecules preponderated in a solution in which the conditions were favorable to the synthesis of new molecules, the influence of pattern would prevail and a larger proportion of right-hand material would be formed. In course of time the left-hand material would die out and only right-hand material would be present—as in the world to-day. The argument is applicable to compounds generally.

Even the formation of enzymes may be accounted for. Under the influence of acid or alkali, colloid particles may well have entered into association with this or that group. But when once formed fortuitously enzymes probably would become the models or templates upon which new molecules would be formed, much after the manner of the dressmaker's model upon which the dress bodice is fashioned.

But it will be said, "Granted even that simple substances can be formed in such ways, surely it is impossible to account for the production of protoplasm." No doubt, this is difficult, especially as the thing we are asked to account for can not be defined. I am tempted here again to quote Epictetus:

Whence then shall we make a beginning? If you will consider this with me, I shall say first that you must attend to the sense of words.

So I do not now understand them?

You do not.

How then do I use them?

As the unlettered use written words or as cattle use appearances; for the use is one thing and understanding another. But if you think you understand, then take my word you will and let us try ourselves whether we understand it.

The word "protoplasm" means so little to most people, so much to a few. It is the convenient cloak of an appalling amount of ignorance—perhaps the scientific equivalent of the "Don't fidget, child," addressed to the too inquiring youngster or the biological paraphrase of the older chemist's catalytic action.

Is protoplasm one or many things? A medium or a substance. In saying that, "Living substance or protoplasm takes the form of a colloidal solution. In this solution the colloids are associated with crystalloids which are either free in the solution or attached to the molecules of the colloids," Prof. Schäfer scarcely helps us to a definition. Nor are his later suggestions much more helpful. Speaking of the differential septum by which living substance is usually surrounded, he says, "This film serves the purpose of an osmotic

membrane, permitting of exchanges by diffusion between the colloid solution constituting the protoplasm and the circumambient medium in which it lives. Other similar films or membranes occur in the interior of protoplasm."

One thing only is certain—that protoplasm can not be a solution or anything approaching to a solution in character; diverse structure it must have, structure of infinite delicacy and complexity.

Judging from his reference to the simplicity of nuclear material, it would seem that Prof. Schäfer is prepared to regard protoplasm as by no means very complex. But it is inconceivable that the germ plasm, carrying within itself as it apparently does all the formative elements of the complete organism, should be simple in structure. It must contain a complete series of interconnected templates from which growth can proceed. I have elsewhere stated that protoplasm may be pictured as made up of a large number of curls, like a judge's wig, all in communication through some center, connected here and there perhaps also by lateral bonds of union. If such a point of view be accepted, it is possible to account for the occurrence, in some sections, of the complex interchanges which involve work being done upon the substances there brought into interaction, the necessary energy being drawn from some other part of the complex where the interchanges involve a development of energy. (Winnipeg address.)

My metaphorical wig as a whole may be taken as representing the racial type—the curls as corresponding to separate characters.

I can imagine so complex a structure being formed by a series of fortuitous accidents in course of time, but taking into account the extraordinary fixity of natural types, so well expressed in Tennyson's lines—

So careful of the type she seems,
So careless of the single life,

it seems to me improbable that a like series of accidents should recur. It is on grounds such as these that I can not accord my sympathy to statements such as Dr. Bastian has made and that I can not accept the suggestion put forward by Prof. Schäfer that life conceivably is arising *de novo* at the present day, let alone that it is the easy process suggested so light-heartedly by Prof. Moore. Where are the materials? Can we say that they exist anywhere?

It is useless for biologists to live in a higher empyrean of their own and to disregard the minuter details which chemical study alone can unravel; they will never be able to solve the complex problems of life or even to grasp their significance unless they pay more attention to the ways in which building stones are shaped and mortar made and in which edifices are gradually reared from such materials.

I have no desire to take exception to the general trend of Prof. Schäfer's address, but I can not help thinking that he altogether underrates the complexity of vital chemical processes; while believing that, as he says, "we may fairly conclude that all changes in living substance are brought about by ordinary chemical and physical forces" and that "at the best, vitalism explains nothing," I am in no way prepared to underrate the difficulties before us in finding satisfactory explanations of the origin of life.

I see no reason to suppose that life may be originating *de novo* at the present time nor do I believe that we shall ever succeed in effecting the synthesis of living matter.

With regard to Prof. Moore's statement that all the actions of the cell are concerned with the liberation of energy and its transformation into many forms, there is nothing to show that the forms of energy that are operative during life are in any way peculiar. Energy is inherent in matter; apparently its primary form is that known to us as electrical energy; and inasmuch as Faraday's dictum that chemical affinity and electricity are forms of the same power is incontrovertible, moreover as electricity in its passage through matter is frittered down into heat, the mechanical effects associated with life are easily accounted for. As to the origin of consciousness and of psychical phenomena generally we know nothing; at most we can assert that we are conscious of consciousness. The effects of consciousness may well be the outcome of simple mechanical displacements of molecules such as take place in the steel tape previously referred to in its passage across a magnetic field varying in intensity. If nervous impulses are conveyed not along continuous tracts but through the agency of interdigitating fibers, a mere alteration in the lengths of these fibers would condition a variation of the impulse; the actual conductivity of a continuous fiber would vary also if chemical changes were to take place within its substance. It is easy to see how chemical changes occurring within a nerve or muscle cell would involve an alteration in the osmotic state, which would necessarily be followed by the influx or efflux of water according as the alteration involved an increase or diminution of the number of molecules in solution. Oscillatory hydraulic changes of this type may well be at the bottom of both nervous and muscular activity in the organism; in fact, there is every reason to believe that we are but hydraulic engines.

According to Prof. Moore, the colloid shows the properties of dawning life; whatever this may mean, I understand him to say that to make it live it is necessary to get an energy transformer attached to it. It is surprising how little life there is in those who live, how slowly lessons are learnt. The conditions which determine the transformations of energy were laid down generations ago by Fara-

day, but are disregarded to the present day. There is little that is mysterious about them; all that is required is a proper arrangement of parts. To give an example, a lump of zinc in diluted sulphuric acid constitutes a binary system brimful of latent energy—of energy awaiting transformation but untransformable so long as the system remains binary. On coupling the conjoined metal and acid by means of a relatively electronegative conductor, however, interaction at once sets in, the metal attacks the acid and the acid the metal and energy is set free—primarily as electricity, secondarily as heat. Nothing can stop the transformation if the ternary system be constituted. Apparently no special energy transformer is required, but merely a proper arrangement of parts. Given the proper arrangement, action is bound to take place, provided always that the system be one in which there is an overplus of energy.

And here comes the rub. In the case of organisms, not a few changes take place which can only occur if energy be supplied. The assimilation of carbon by plants is a case in point. Ordinarily this is effected through the agency of sunlight; but it is clear that in some cases, as in the fermentation of sugar, for example, energy set free in a change taking place in one part of a complex molecule may serve to make up a deficiency preventing the spontaneous occurrence of a change of the reverse order in another part of the molecule. It is an important office of the protoplasmic complex apparently to “negotiate” such exchange or transference of energy.

With reference to Dr. Haldane’s statement that we can not express the observed facts by means of physical and chemical conceptions but must have recourse to the conception of organic unity, I am at a loss in the first place to understand what this conception is, if it be inconsistent with chemical conceptions. I am afraid the vague indeterminate phases of the philosopher make little appeal to the hard heart of the fact worshipper. My position is that while we do not attempt to account for that we do not understand or can not express clearly, all that we do understand is well within our compass to explain; moreover that our power of understanding is growing every day.

I do not see how Prof. Schäfer and those of us who are with him can be said to have ignored the actual fact of the maintenance in “organic unity” of the numerous physical and chemical processes which we can distinguish within the living body. It is far from being the fact that “The more detailed and exact our knowledge has become of the marvelous intricacies of structure and function within the living body the more difficult or rather the more completely impossible has any physico-chemical theory of nutrition and reproduction become.” Or that “the difficulty stands out in its fullest prominence in connection with the phenomena of reproduction and heredity.”

To make my meaning clear, let me go back to my wig. Assuming the primordial wig to have come into existence through a series of lucky, fortuitous accidents, assisted by certain peculiarities inherent in the primary material and favored by the special conditions of the environment—wigs have ever since been made much on the pattern of the first wig though variations have taken place from time to time.

Each new wig is constructed on top of an old wig and when a new wig is ready, "division" takes place and the new wig is removed to a new "cell" together with a supply of tools and materials required for wig making. According to the material available, while the general pattern is maintained intact, variations may be introduced into individual curls. But two kinds of wigs are to be thought of, simple wigs—male and female—and compound wigs, the latter being made by superposing two simple wigs after such alterations have been made in each as to permit of their superposition; obviously, when the compound wigs are separated and worn as simple wigs, the new simple wigs differ somewhat from the old though they are very like them in general character; also it will be clear that all sorts of combinations of simple wigs may be made.

Obviously my metaphorical wigs correspond to nuclei and the tools and materials used in making them to the cytoplasmic elements—assuming that the nucleus is the formative element of the cell. Having thus put wigs on the green, I trust that I have met the challenge given by Dr. Haldane and that it will be obvious that even the problems of reproduction and heredity, if not those of immunity, may be dealt with from some such point of view as that I have ventured to state.

The assertion has been made¹ recently that the scientific world "is beginning on all sides to admit the necessity for postulating the cooperation of some 'outside' factor. Lodge in England, Bergson in France, and Driesch in Germany are the most conspicuous apostles of the new movement."

This is but one of the many such statements made of late. An apostle after all is but a messenger and the character of a message depends a good deal on the instruction the messenger has received, though imagination may contribute a good deal to its ultimate adornment. The messages delivered to the public on such a subject are apt to be somewhat imaginary. It is clear that they can not be even an approximation to truth, when no notice is taken by those who convey them of the results achieved by the toiling workers in the distant adits of the mine of science. Philosophers must go to school and study in the purlieus of experimental science, if they desire to speak with authority on these matters.

¹ "Involution," by Lord Ernest Hamilton.

Here again I am served by the old Greek cynic, "The beginning of philosophy, at least with those who lay hold of it as they ought, is the consciousness of their own feebleness and incapacity in respect of necessary things." Such sayings make us wonder at the lack of appreciation displayed by the sage of Chelsea in making Sartor say, "The 'Enchiridion of Epictetus' I had ever with me, often as my sole companion, and regret to mention that the nourishment it yielded was trifling." But he too was a philosopher.

After telling us that the cell is now defined as a vital unit consisting of an individual mass of the living substance protoplasm containing at least one nucleus; and that the protoplasm of an ordinary cell is differentiated into two distinct components—the cytoplasm or bodyplasm and the nucleus—Prof. Minchin raises the question whether the cytoplasm or the nucleus is to be regarded as the more primitive. He can not conceive, he says, that the earliest living creature could have come into existence as a complex cell, with nucleus and cytoplasm distinct and separate; and he is forced to believe that a condition in which a living body consisted only of one form or type of living matter preceded that in which the body consisted of two or more structural components.

The issue thus raised is an important one. Regarding the cell as the vital unit, as "the simplest protoplasmic organ which is capable of living alone," in other words, capable of growing and of reproducing itself, the question I venture to put is whether life did not begin only when the cell was first constituted, whether the materials formed prior to this period, however complex, were not all incoordinated and therefore inanimate.

The term "cell" unfortunately has had somewhat different meanings attached to it. At first, as Prof. Minchin tells us, only the limiting membrane or cell wall was thought of, the fluid or viscous contents being regarded as of secondary importance; the primary meaning, in fact, was that of a little box or capsule. It then became apparent that the fluid contents were the essential living part, the cell wall merely an adaptive product of the contained living substance or protoplasm. Consequently the cell was defined as a small mass or corpuscle of the living substance, which might either surround itself with a cell wall or remain naked and without any protective envelope. Further advance involved the recognition of a nucleus as an essential component of the cell.

I can not think of a naked mass of protoplasm, call it chromatin (stainable substance) or what you will, playing the part of an organism; at most I imagine it would function as yeast zymase functions.

If it is to grow and be reproduced, the nuclear material must be shut up along with the appropriate food materials and such con-

structive appliances as are required to bring about the association of the various elements entering into the structure of the organism. The inclosure of the naked protoplasmic mass within a differential septum (cell wall) through which only the simpler food materials could gain an entry seems to me, therefore, a necessary act in the evolution of life. From this point of view, it matters little which came first—chromatin or cytoplasm.

The argument put forward by Mr. Eccles in support of the contention that nuclear material is the more primitive, based on the preponderance of the open chain derivative arginine in the nucleus and of benzenoid derivatives, such as tyrosine in the cytoplasm, can not be regarded as valid. The difference between open and closed chain compounds is not such that chemists can regard one as more primitive than the other, except it be that the open is the first to receive attention in the textbooks; and arginine, if not the most, is one of the most complex products hitherto separated from albuminoid materials, far more so than tyrosine:

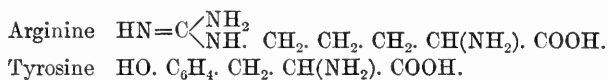

Arginine probably owes its value as a nuclear material to the many points of attachment its nitrogen atoms offer—in other words, to its complexity.

Prof. Minchin would restrict the term "cell" to organisms in which the protoplasm is differentiated into cytoplasm and nucleus definitely marked off from one another and would therefore deny the term "cell" to bacteria and their allies. But bacteria apparently consist of materials differing but little in complexity from those met with in higher organisms and they contain a variety of enzymes. The separation of the nucleus within a special differential septum would appear merely to mark it off as a separate factory within which special operations can be carried on apart from those effected in the cytoplasm; the extrusion of nucleoli from the nucleus during the vegetative stage is particularly significant from this point of view, especially as the nucleoli within and without the nucleus stain differently.¹ The differentiation of the nucleus, therefore, may be merely a mark of a higher stage of organization, but to make the distinction suggested between bacteria and other forms appears to me to be unjustifiable.

From the point of view I am advocating, every organism must possess some kind of nucleus—visible or invisible; some formative center around which the various templates assemble that are active

¹ See especially "Observations on the history and possible function of the nucleoli in the vegetative cells of various animals and plants," by C. E. Walker and Frances M. Tozer, *Quart. Journ. Exp. Physiol.*, 1909, 2, 187.

in directing the growth of the organism. The cell, in other words, is the unit factory and its definition should be made independent of microscopic appearances.

To conclude: All speculation as to the origin of life must savor of the academic; it can have no very definite outcome unless it be verified experimentally, and at present it seems improbable that such verification will be possible. But speculation is none the less legitimate and desirable on account of the fundamental issues to be considered.

In discussing the problems of heredity, in dealing with disease, we are groping in the dark so long as we are ignorant of the precise nature of the vital processes and of the minute details of organic structure; no effort should be spared, therefore, to unravel these. The results of modern cytological inquiry are very marvelous but unsatisfactory. We need to know far more of living material, especially in the vegetative stage; the chemist has difficulty in accepting the findings of the morphologist at their face value; he can not avoid the feeling that not a few of the "structures" described may be artefacts bearing but a distant resemblance to the living forms, as structure is usually brought into evidence by staining and this can not take place until the differential septa of cells are broken down and rendered permeable; so that the staining and fixing process is one that must be attended with chemical changes, among which coagulation effects are to be reckoned. But the appearances in many cases are too definite, too wonderful, to be mere artefacts.

What is now needed is the combination of the eyes of the cytologist with those of the chemist and with those of the physiologist, the collaboration of the student of external structure, and the student of function. Continued specialization can only carry us farther away from the goal we are all striving for, though vaguely, because we have no settled combined scheme of action.



THE APPEARANCE OF LIFE ON WORLDS AND THE HYPOTHESIS OF ARRHÉNIUS.¹

By ALPHONSE BERGET,
Professor at the Paris Institute of Oceanography.

The problem of cosmogony is one of those that has most disturbed the mind of man. No question, indeed, is more perplexing than that of finding out whence comes the earth, whence comes the sun about which it gravitates with its sister planets, toward what goal is it carried by that slow evolution that it undergoes.

To this question Laplace was the first to give a scientific answer. Starting from the results of the observation of the nebulae, different forms of which we can observe in the sky at different stages of their history, he formulated, by a true flash of genius, that wonderful theory that bears his name. According to his conception, an incandescent nebula, radiating its heat gradually toward cold space, would contract as it cooled; these successive contractions would by degrees have agglomerated the constituent matter of the nebula into a "nucleus," at first gaseous, then igneous fluid, the sun. In proportion as the dimensions of this revolving nucleus—the total mass of which remained the same—was diminishing, its momentum of inertia was also diminishing, its velocity of rotation was increasing, and consequently the centrifugal force was increasing at the same time. A depression was formed on the still plastic nucleus near the axis of rotation; the equator expanded and gradually a ring was detached from it, which on breaking gave birth to a new planet, by the condensing of the matter of which it was formed. This planet began to revolve around the nucleus and on itself, in the same direction as that of the rotary motion of the central nucleus. Thus must the earth have been born, thus must have been born the other planets, fragments detached from the central sun, and necessarily containing the same chemical elements.

When Laplace advanced this hypothesis, certain astronomical facts that are known to-day were yet unknown, notably the inverse rotation of the satellites of distant planets. Nothing was known of the existence of new forces that modern physics has just discovered

¹ Translated by permission from *Biologica*, Paris, 2d year, No. 13, January 15, 1912.

in the course of the last few years. Perhaps it is fortunate that the famous astronomer did not know these "new facts." They would have destroyed the unity of the system of the universe as he saw it, and the complication introduced by instances of exception would doubtless have prevented him from formulating his hypothesis, so grand in its unaffected simplicity.

To-day we know that the Laplace theory must be modified in some points. As a whole, however, it is still in force; it is a citadel which in spite of everything resists all assaults, as H. Poincaré has so well said. It is enough, therefore, to reconcile it with the new conquests of science; that is what the illustrious physicist of Stockholm, Prof. Svante Arrhénius, has done.

The Swedish scientist introduced into the theory of the evolution of worlds a second force as necessary to consider as universal gravitation, that is, the *pressure of radiation*, the conception of which is due to J. Clerk-Maxwell, and the reality of which has been demonstrated by the experiments of Lebedeff. This pressure is exerted upon every surface exposed to a radiation by the very action of this radiation; it is equivalent, in the immediate neighborhood of the solar surface, to nearly 2 milligrams a square centimeter.

As the dimensions of a very small spherule of matter decrease, the importance of the surface in comparison with the mass increases at the same time. Now the attraction of gravitation is dependent on the mass, while the pressure of radiation is dependent on the extent of surface. One can readily conceive, therefore, that in the case of very tenuous particles the pressure of radiation may exceed the attractive force of gravitation; in the case of nontransparent spherules the 0.0015 of a millimeter in diameter the two forces are in equilibrium; and if the diameter of the particle falls below this amount, the repelling force is the stronger and the particle is driven away from the radiating body. On tiny particles whose diameter would amount to as little as the 0.00016 of a millimeter, the pressure of radiation would be ten times as great as the attracting force. These dimensions are realized in the spores of bacteria. The small mass of these microscopic granules increases the importance of their surface, and the resistance of the air has such force over them that this tiny mass dropped into the air would not fall a hundred meters in a year. The slightest wind carries them off into the atmosphere and may take them to the limits of our gaseous envelope, where the pressure of the air is not more than a very small fraction of a millimeter of mercury; that is, to an altitude of 100 kilometers.

It is this pressure of radiation that Arrhénius has given a place in the formation of worlds. It drives away from the stars the fine "cosmic dust" which the constant eruptions of these incandescent stars throw out every moment; especially, it is this dust which con-

stitutes the coronal atmosphere of the sun. These expelled particles bear a negative electrical charge. They are going to come in contact with these cold, gaseous masses of rarified molecules, containing helium and hydrogen, called "nebulae." These nebulae contain a very small number of molecules; hence their low temperature. When the electrically charged particles reach them, the former make the periphery luminous, and then these nebulae are visible to observers on the earth; the dust which is agglomerated into meteorites, however, becomes centers of condensation for these nebulae. Let a dark body, such as the moon is to-day, such as the sun will be later, happen to penetrate into such surroundings in the course of its peregrinations lasting myriads of centuries, it will become still more easily a center about which nebulous matter would accumulate while it becomes heated; the nucleus becomes incandescent, a sun will be born. Finally, let two dark suns collide in the infinity of space and time; the violence of the shock is enough to volatilize their matter; the breaking of their envelopes would release the igneous matter so long imprisoned beneath their cooled crusts; like two gigantic shells they "explode" and the endothermic components that their centers contain, held under enormous pressures, set free masses of gas that escape in spiral spirts. Then the stages of which Laplace conceived can begin to follow each other, generating planets; one or two "nuclei" exist in the midst of the nebulous spheres surrounding them; we have watched the resurrection of a world. These collisions are not idle hypotheses, we witness them in the heavens each time that a new star appears, like the "nova Persei," for example; we have seen a world born, but reborn from a dead world. It is a perpetual cycle that recommences in this manner, a cycle the mechanism of which has been pointed out for the first time by the brilliant genius of Arrhénus.

Such is, too briefly summarized, the Swedish physicist's principle of the theory of cosmogony. But he has not been content with explaining the evolution of "cosmic" matter. He has asked himself—and it is this that will interest the reader of *Biologica* more especially—how life could appear on a world thus created; he has tried to find out whether living germs, having left a world where they found their conditions of existence realized, can endure the long journey through intersidereal space and bring to another world the germ of life which is in themselves, becoming the starting point of a series of living beings brought slowly, by an evolution parallel to that of the planet that sustains them, to gradually increasing degrees of perfection; in a word, to "higher" states.

Swante Arrhénus answers this question by the elegant, original, and seductive form that he has known how to give to the doctrine

of Panspermy, adapting it to the most recent advancement of modern physics.

The doctrine of Panspermy is not new; Richter was the first to advance it, about 1865. Later it received the distinguished support of the illustrious English physicist, Lord Kelvin, and in Germany Helmholtz lent it the aid of his great authority.

In its first form, this doctrine assumed that meteorites, fragments resulting from the collision between two dark bodies of the heavens, come in contact with a sun and bring there germs that the explosion has not had time to destroy, as, when one blows up a quarry with dynamite, certain pieces of rock may roll to the bottom of the mountain, remaining covered with vegetation, with living germs that have stayed intact. Under these conditions meteorites could admit of organic "inclusions," which could carry life to celestial bodies yet devoid of it.

However, examination of this hypothesis in this very simple form raises objections, the principal of which is the stupendous temperature to which the germs would be immediately subjected. Merely the sudden stopping of the earth in its motion, even without the intervention of a collision, would suffice to volatilize its matter as a result of the quantity of heat liberated; if, in addition, there should be a collision of two celestial masses, with the liberation of the igneous matter composing their respective nuclei, it is almost certain that not a living organism would escape this thermic manifestation, which would reduce them to their gaseous elements. It is, then, very difficult to admit of the conveyance of germs by meteorites considered as "fragments" from a celestial cataclysm.

Arrhénius has completely modified the hypothesis of Panspermy by adapting it to the demands and achievements of modern physics. He has considered the possibility of the conveyance of germs themselves, independently of all mineral aid, and this by bringing into play the "pressure of radiation" of which we have spoken in the beginning of this article, when we explained in broad outline the cosmogonic hypothesis of the Swedish physicist.

We have said that by direct measurement the pressure of radiation on a spherule the 0.00016 of a millimeter in diameter (or 0.16 of a micron) might be 10 times as strong as the attractive force resulting from universal gravitation. Now germs of these reduced dimensions do exist. Botanists know for a certainty that the spores of many bacteria have a diameter of 0.3 to 0.2 of a micron, and that beyond doubt there exist some even much smaller; the progress of the ultra-microscope is beginning to enable us to see these germs of the order of one-tenth of a micron in size.

Let us imagine such a microorganism swept off the surface of the earth by a current of air that carries it as far as the higher atmosphere,

say to the altitude of approximately a hundred kilometers. When it has reached that point it is subjected to another category of forces susceptible of acting on it; these are forces of an electrical kind.

It is, indeed, at about that altitude that radiations produce polar auroras. These auroras are caused by the arrival into the atmosphere of the earth of cosmic dust coming from the sun and driven from it by the pressure of radiation. This dust is charged negatively, and its discharge makes luminous the region of the atmosphere in which it is. Under these conditions, if a spore coming from the earth's surface is also negatively charged by contact with the electrically charged dust, it may be repelled by the latter, which will drive it toward intersidereal space as a result of the electrostatic repulsion of two charges of the same sign. Calculation shows that an electrical field of 200 volts a meter is enough to produce on a spherule the 0.16 of a micron in diameter a repulsion greater than gravitation; now, the field usually observed in the atmospheric air is greater. Electrostatic repulsion of germs that have reached the higher atmosphere is, then, not only qualitatively, but even quantitatively possible.

We have our germ, then, started on its intersidereal journey. Let us put aside for a time the conditions of existence and destruction that it may encounter among the stars, circumstances that we shall study in a moment. We are going to find out first of all the conditions of time of such a journey, effected under the influence of the pressure of radiation which acts on the germ as soon as it is at a sufficient distance from the earth. On its way it will be caught, in the neighborhood of a celestial body, by some larger particle of the order of size of a micron, which forms a portion of that dust scattered profusely around the solar systems. Once carried away by this particle, which, because of its greater size, is more subject to the action of attraction than to that of the repelling force, it can then penetrate into the atmosphere of the planets that it will happen to encounter.

If we assume that this traveling germ has a density equal to that of water, which is obviously accurate for living germs, we find that it will need nearly 20 days for it to reach the planet Mars, 80 to reach Jupiter, 15 months to get to the distant planet of Neptune. These are only planets forming part of our own solar system. If we try to find the time necessary for this germ to reach the solar system nearest to ours, that is, the system whose central sun is the star α of the constellation of the Centaur, we will find the duration of the journey to be approximately 9,000 years.

How will our germ, living at the time of its departure, act in the course of this long journey?

Interstellar space has a very low temperature; it is near the *absolute zero* of the physicists, which is 273° C. below the temperature

of melting ice. Arrhénius estimates the temperature of nebular space at -220° (53° absolute), taking physical observations as a basis. The germ that is traveling across this space under the impulse of the pressure of radiation must, then, endure for months, years, or even centuries, a temperature of 220° C. below zero; what is going to be the result from the viewpoint of its vitality, and more than all, from the point of view of its germinative power?

Modern physicists and physiologists answer this question victoriously. In the laboratory of the Jenner Institute in London, scientists have quite recently met with success in keeping in liquid oxygen for 20 hours, at a temperature of 250° C. below zero, spores of bacteria which have completely retained their germinative power after this severe test. And Prof. MacFayder has kept living germs for *more than six months* at 200° C. below zero, not only without their germinative power having been destroyed, but even without its having been injured in the slightest degree.

Svante Arrhénius points out that this preservation of germinative power at very low temperatures is the most natural thing possible. This power, indeed, ought to disappear only under the influence of some chemical reaction, and it is known that these reactions take place more and more slowly as the temperature of the medium is lowered. At the temperature of interstellar space, reactions of life ought to be produced by an activity a thousand million times weaker than at a temperature of 10° C., and at a temperature of 220° C. below zero the power of germination would not diminish more during 3,000,000 years than it diminishes in a day at the temperature with which we are familiar, 10° C. below zero.¹ All fear in regard to the prolonged action of cold is therefore removed—it is, then, without injurious effect on the germinative faculty of spores.

Time, acting alone, seems equally harmless. Have not bacteria been found, in fact, in a Roman vault, which have certainly remained untouched for 1,800 years and which, nevertheless, were perfectly capable of germination after this long interval?

As to the influence of the absolute aridity of interstellar space, an agency that is added to that of cold and that of time, neither does this appear to be dangerous to our germ of life. Schraeder has shown that a green alga, *Pleurococcus*, can live three months in a medium that has been completely desiccated by sulphuric acid. Prof. Maquenne, of the French Institute, has gone still further. He has demonstrated, with experiment and observation at hand, that seeds can stay several years in a Crookes tube—that is, in almost complete vacuum, without losing their germinative power, and Paul Becquerel

¹ Arrhénius. *The Evolution of Worlds* (Seyrig translation), p. 238.

has observed identical results on the spores of Mucoraceæ and of bacteria.

Paul Becquerel has carried his experiments still further. In the Leyden laboratory he has subjected bacteria and spores for three weeks to the combined influence of vacuum, cold (-253° C.), and absolute aridity. Their vitality remained perfect.

The "circumambient conditions" of intersidereal space are therefore not hostile to the vitality of a germ that would travel there, even for a very extensive period.

Another objection, however, has been made to the theory of Arrhénus, one that is, at least at first glance, more serious—this is the deadly effect of ultra-violet radiations on living germs.

It is known, in fact, that this action exists. It even exists so certainly that drinking water is beginning to be sterilized industrially by utilizing the microbicide action of ultra-violet rays. Now, these rays, absorbed in great part by the atmosphere of the planets, travel freely through interstellar space. Will they not "kill" our wandering germs in the course of their journey from one world to another and destroy forever their germinative power?

Paul Becquerel's experiments seem to support this possibility of the death of germs through the action of ultra-violet rays. This investigator has placed dry spores in vacuum tubes, closed by a sheet of quartz that allowed the passage of ultra-violet rays with which the germs under observation were illuminated. At the end of six hours the most resistant spores are killed. The journey of a living germ in a space freely illuminated by ultra-violet light would therefore be full of dangers for the life of this germ, which would be exposed to a quick death.

But to these experiments, carried out with a care and a skill that make the result indisputable, there are some opposing arguments.

First of all, it must be noted that the death of the germ is not *instantaneous*; several hours were needed to destroy it, even under the action of a powerful light brought into immediate proximity with the microorganism subjected to its effects. Now, the *intensity* of radiations varies in inverse ratio with the squares of the distances. Therefore at the distance of the orbit of Neptune, solar radiation is nearly a thousand times weaker than at the distance of the earth from the radiating body, and at half the distance of the star *a* of the Centaur, this radiation would be twenty thousand million times weaker. A man resists the heat of a furnace before which he stands, when he would die if he were thrust into the fire.

The work of Dr. Roux seems to have shown that it is an oxydizing action due to the constitution of the atmospheric medium that causes the deadly effect of the light on the germ, for the illustrious

scientist has made a series of researches in the course of which spores in a vacuum have resisted *for several months* the illumination of a very strong solar light which, had they been in the air, would undoubtedly have killed them.

So one can conceive that a living germ, wandering through space and coming from a body on which life has already been manifested, can travel for a long time, meanwhile escaping causes of destruction that surround it, and arrive on a world still devoid of life, where conditions of temperature are such that life begins to become possible there.

It is enough that among the thousand millions of thousand millions of germs sent off into the infinite by the pressure of radiation, *a single one* shall reach a planet that has been without life up to that time, in order to become there the point of departure of manifold organisms that will slowly evolve from it. The minuteness of such a germ moderates its fall through the atmosphere of this planet enough so that it does not become heated as a result of its friction in the atmosphere to a temperature sufficient to kill it. Having entered the atmosphere of the new planet, it will follow its eddies and currents, it will fall on a substratum, either solid or liquid, which will offer it the "optima" conditions of development, life will be born on the surface of a world lifeless till that time. "And, even if there should elapse millions of years between the moment when a planet is susceptible of carrying life and the moment when a germ first falls upon it and develops there in order to take possession of it for organic life, that is very little in comparison with the extent of time during which this life will be able to exist there in complete development."¹

And so, according to this magnificent conception of the Swedish physicist, life can be carried from one planet to another. Germs swept away by ascending air currents which carry them to the limits of the atmosphere are repelled by the electrically charged dust that has penetrated there, coming from suns that have driven it away by the repelling pressure of their radiation. After they have arrived in space they attach themselves to some straying grains of dust of greater dimensions than theirs and consequently capable of obeying the attraction of a neighboring planet rather than the repelling force of radiation; they then penetrate into the atmosphere of this new planet and bring life to it, if life has not yet developed there.

And in that case one is forced to the conclusion that if all beings that live on a certain planet are derived from one initial germ, they have been able to reproduce in their almost infinite variety only by the evolution of forms that can have come from this original germ.

¹ Arrhénius, *ibid.*, p. 241.

Formed of cells composed of direct combinations of carbon, hydrogen, and nitrogen, they have in themselves a necessary analogy to their constituent matter.

The elements that constitute this matter are those of the traveling germs, and the latter may fall either on one planet or another; there must, therefore, also be some analogy between the beings living on the planets of a solar system and those living on the earth, with still more reason if they inhabit planets that revolve around the same sun. And so the naïvete seems childish that makes people conceive of the "Martians" as strange creatures possessing the unknown functions of the animals of the earth.

Another conclusion is also forced upon us: "Life is an eternal rebeginning"; and this conclusion of Arrhénius in what concerns the world of life is the same as that indicated by his theory of the universe, namely, that new celestial bodies are born from the collision of two dark suns. It is the eternal cycle of which the "ring" is the symbol.



THE EVOLUTION OF MAN.¹

By Prof. G. ELLIOT SMITH, M. A., M. D., Ch. M., F. R. S.

THE SCOPE OF EVOLUTION.

In a recent address Lord Morley referred to "evolution" as "the most overworked word in all the language of the day;" nevertheless, he was constrained to admit that, even when discussing such a theme as history and modern politics, "we can not do without it." But to us in this section, concerned as we are with the problems of man's nature and the gradual emergence of human structure, customs, and institutions, the facts of evolution form the very fabric the threads of which we are endeavoring to disentangle; and in such studies ideas of evolution find more obvious expression than most of us can detect in modern politics. In such circumstances we are peculiarly liable to the risk of "overworking" not only the word "evolution," but also the application of the idea of evolution to the material of our investigations.

My predecessor in the office of president of this section last year uttered a protest against the tendency, to which British anthropologists of the present generation seem to be peculiarly prone, to read evolutionary ideas into many events in man's history and the spread of his knowledge and culture in which careful investigation can detect no indubitable trace of any such influences having been at work.

I need offer no apology for repeating and emphasizing some of the points brought forward in Dr. Rivers's deeply instructive address; for his lucid and convincing account of the circumstances that had compelled him to change his attitude toward the main problems of the history of human society in Melanesia first brought home to me the fact, which I had not clearly realized until then, that in my own experience, working in a very different domain of anthropology on the opposite side of the world, I had passed through phases precisely analogous to those described so graphically by Dr. Rivers. He told

¹ Address delivered before the Anthropological Section at the Dundee meeting of the British Association for the Advancement of Science in September, 1912. Reprinted by permission from *Nature*, London, Sept. 28, 1912. It represents the address as it was delivered at the meeting; it is a somewhat condensed and rearranged form of that appearing in the association's reports.

us that in his first attempts to trace out "the evolution of custom and institution" he started from the assumption that "where similarities are found in different parts of the world they are due to independent origin and development, which in turn is ascribed to the fundamental similarity of the workings of the human mind all over the world, so that, given similar conditions, similar customs and institutions will come into existence and develop on the same lines." But as he became more familiar with the materials of his research he found that such an attitude would not admit of an adequate explanation of the facts, and he was forced to confess that he "had ignored considerations arising from racial mixture and the blending of cultures."

I recall these statements to your recollection now, not merely for the purpose of emphasizing the far-reaching significance of an address which is certain to be looked back upon as one of the most distinctive and influential utterances from this presidential chair, nor yet with the object of telling you how, in the course of my investigations upon the history of the people in the Nile Valley,¹ I also started out to search for evidences of evolution, but gradually came to realize that the facts of racial admixture and the blending of cultures were far more obtrusive and significant. My intention is rather to investigate the domain of anthropology in which unequivocal evolutionary factors have played a definite rôle; I refer to the study of man's genealogy, and the forces that determined the precise line of development his ancestors pursued and ultimately fashioned man himself.

I suppose it is inevitable in these days that one trained in biological ways of thought should approach the problems of anthropology with the idea of independent development as his guiding principle; but the conviction must be reached sooner or later, by every one who conscientiously, and with an open mind, seeks to answer most of the questions relating to man's history and achievements—certainly the chapters in that history which come within the scope of the last 60 centuries—that evolution yields a surprisingly small contribution to the solution of the difficulties which present themselves. Most of the factors that call for investigation concerning the history of man and his works are unquestionably the direct effects of migrations and the intermingling of races and cultures.

But I would not have you misunderstand my meaning. Nothing could be further from my intention than to question the reality of evolution, as understood by Charles Darwin, and the tremendous influence it is still exerting upon mankind. In respect of certain perils man may, perhaps, have protected himself from "the general operation of that process of natural selection and survival of the fittest

¹ "The Ancient Egyptians," Harpers, 1911.

which, up to his appearance, had been the law of the living world" (Sir Ray Lankester); but it has been demonstrated quite definitely that man, in virtue of these very heightened powers, which, to some observers, seem to have secured him an immunity from what Sir Ray Lankester calls "nature's inexorable discipline of death," is constantly exposing himself to new conditions that favor the operations of natural selection, as well as other forms of "selection" to which his increased powers of intelligent choice and his subjection to the influences of fashion expose him.

It is not, however, with such contentious matters as the precise mode of operation of evolution at the present day that I propose to deal; nor yet with the discussion of when and how the races of mankind became specialized and differentiated the one from the other. It is the much older story of the origin of man himself and the first glimmerings of human characteristics amidst even the remotest of his ancestors to which I invite you to give some consideration to-day.

In a recently published book¹ the statement is made that "the uncertainties as to man's pedigree and antiquity are still great, and it is undeniably difficult to discover the factors in his emergence and ascent." There is undoubtedly the widest divergence of opinion as to the precise pedigree; nevertheless, there seems to me to be ample evidence now available to justify us sketching the genealogy of man and confidently drawing up his pedigree as far back as Eocene times—a matter of a million years or so—with at least as much certainty of detail and completeness as in the case of any other recent mammal; and if all the factors in his emergence are not yet known, there is one unquestionable, tangible factor that we can seize hold of and examine—the steady and uniform development of the brain along a well-defined course throughout the primates right up to man—which must give us the fundamental reason for "man's emergence and ascent," whatever other factors may contribute toward that consummation.

What I propose to attempt is to put into serial order those vertebrates which we have reason to believe are the nearest relatives to man's ancestors now available for examination and to determine what outstanding changes in the structure of the cerebral hemispheres have taken place at each upward step that may help to explain the gradual acquirement of the distinctively human mental faculties, which, by immeasurably increasing the power of adaptation to varying circumstances and modifying the process of sexual selection, have made man what he is at present.

The links in the chain of our ancestry supplied by paleontology are few and of doubtful value if considered apart from the illumination of comparative anatomy.

¹ J. A. Thomson and P. Geddes, "Evolution," 1912, p. 102.

Psychologists have formulated certain definite phases through which the evolution of intelligence must have passed in the process of gradual building up of the structure of the mind. The brain in a sense is the incarnation of this mental structure; and it seemed to me that it would be instructive, and perhaps useful, to employ the facts of the evolution of the brain as the cement to unite into one comprehensive story the accumulations of knowledge concerning the essential facts of man's pedigree and the factors that have contributed to his emergence, which have been gathered by workers in such diverse departments of knowledge as zoology and comparative anatomy, geology and paleontology, and physiology and psychology.

For it was the evolution of the brain and the ability to profit by experience, which such perfecting of the cerebral mechanism made possible, that led to the emergence of mammals, as I attempted to demonstrate in opening the discussion on the origin of mammals at the Portsmouth meeting last year;¹ and from the mammalia, by a continuation of this process of building up the cerebral cortex, or, if you prefer it, the structure of the mind, was eventually formed that living creature which has attained the most extensive powers of profiting by individual experience.

The study of the brain and mind, therefore, should have been the first care of the investigator of human origins. Charles Darwin, with his usual perspicuity, fully realized this; but since his time the rôle of intelligence and its instruments has been almost wholly ignored in these discussions, or when invoked at all wholly irrelevant aspects of the problems have been considered.

There can be no doubt that this neglect of the evidence which the comparative anatomy of the brain supplies is in large measure due to the discredit cast upon this branch of knowledge by the singularly futile pretensions of some of the foremost anatomists who opposed Darwin's views in the discussions which took place at the meetings of the British Association and elsewhere more than 40 years ago.

Many of you no doubt are familiar with Charles Kingsley's delightful ridicule of these learned discussions in the pages of "Water Babies." The controversy excited by Sir Richard Owen's contention that the great distinctive feature of the human brain was the possession of a structure that used to be called the hippocampus minor was not unjostled by the mark of his scathing satire.

The professor had even got up at the British Association and declared that apes had hippopotamus majors in their brains, just as men have. Which was a shocking thing to say; for, if it were so, what would become of the faith, hope, and charity of immortal millions? You may think that there are other more important differences between you and an ape, such as being able to speak, and make machines, and know right from wrong, and say your prayers, and other little matters of that kind; but that is only a

¹ Discussion on the "Origin of Mammals" at the meetings of Section D (Brit. Assoc. Reports, 1911, p. 424).

child's fancy, my dear. Nothing is to be depended upon but the great hippopotamus test. If you have a hippopotamus major in your brain, you are no ape, though you had four hands, no feet, and were more apeish than the apes of all aeries. Always remember that the one true, certain, final, and all-important difference between you and an ape is that you have a hippopotamus major in your brain and it has none. If a hippopotamus was discovered in an ape's brain, why, it would not be one, you know, but something else.

The measure of the futility of the contention thus held up to scorn can be more justly realized now; for some years ago I discovered that the feature referred to in Kingsley's burlesque phrase, "hippopotamus major," which Owen claimed to be distinctive of the human brain, and Huxley maintained was present also in apes, is quite a primitive characteristic, and the common property of the mammalia in general.

This illustration of the nature of the discussions which distracted attention from the real problems, although the most notorious one, is unfortunately characteristic of the state of affairs that prevailed when prejudice blinded men's eyes to the obvious facts that were calling so urgently for calm investigation.

MAN'S PEDIGREE.

No one who is familiar with the anatomy of man and the apes can refuse to admit that no hypothesis other than that of close kinship affords a reasonable or creditable explanation of the extraordinarily exact identity of structure that obtains in most parts of the bodies of man and the gorilla. To deny the validity of this evidence of near kinship is tantamount to a confession of the utter uselessness of the facts of comparative anatomy as indications of genetic relationships, and a reversion to the obscurantism of the dark ages of biology. But if anyone still harbors an honest doubt in the face of this overwhelming testimony from mere structure, the reactions of the blood will confirm the teaching of anatomy; and the susceptibility of the anthropoid apes to the infection of human diseases, from which other apes and mammals in general are immune, should complete and clinch the proof for all who are willing to be convinced.

Nor can anyone who, with an open mind, applies similar tests to the gibbon refuse to admit that it is a true, if very primitive, anthropoid ape, nearly related to the common ancestor of man, the gorilla, and the chimpanzee. Moreover, its structure reveals indubitable evidence of its derivation from some primitive Old World or catarrhine monkey akin to the ancestor of the langur, the sacred monkey of India. It is equally certain that the catarrhine apes were derived from some primitive platyrrhine ape; the other, less modified, descendants of which we recognize in the South American monkeys of the present day; and that the common ancestor of all these primates was a lemuroid nearly akin to the curious little spectral tarsier, which still haunts the forests of Borneo, Java, and the neighboring

islands, and awakens in the minds of the peoples of those lands a superstitious dread—a sort of instinctive horror at the sight of the ghost-like representative of their first primate ancestor.

This much of man's pedigree will, I think, be admitted by the great majority of zoologists who are familiar with the facts; but I believe we can push the line of ancestry still further back, beyond the most primitive primate into Haeckel's suborder Menotyphla, which most zoologists regard as constituting two families of insectivora. I need not stop to give the evidence for this opinion, for most of the data and arguments in support of it have recently been summarized most excellently by Dr. W. K. Gregory.¹

This group includes the oriental tree shrews and the African jumping shrews. The latter (*Macroscelididæ*), living in the original South African home of the mammalia, present extraordinarily primitive features linking them by close bonds of affinity to the marsupials. The tree shrews (*Tupaïidæ*), however, which range from India to Java, while presenting very definite evidence of kinship to their humble African cousins, also display in the structure of their bodies positive evidence of relationship to the stem of the aristocratic primate phylum.

Quite apart from the striking similarities produced by identical habits and habitats, there are many structural identities in the tree shrews and lemuroids, not directly associated with such habits, which can be interpreted only as evidences of affinity.

THE NEOPALLIUM AND ITS RELATION TO THE ABILITY OF LEARNING BY EXPERIENCE.

Having now sketched the broad lines of man's pedigree right back to the most primitive mammals, let us next consider what were the outstanding factors that determined the course of his ancestors' progressive evolution.

The class mammalia, to which man belongs, is distinguished in structure from all other vertebrates mainly by the size and high development of the brain, and, as regards the behavior of its members, by the fact that they are able in immeasurably greater degree than all other animals, not excluding even birds, to profit by individual experience. The behavior of most, or perhaps it would be more correct to say all, animals, however complex and nicely adapted to their circumstances it may seem, is essentially instinctive; and the main problem we have to solve, in attempting to explain the emergence of the distinctive attributes of the creature which in greater measure than any other has succeeded in subordinating its instincts to reason, is the means by which it has become possible for the effects of individual experience to be brought to bear upon conduct.

¹ "The Orders of Mammals," Bull. Amer. Mus. Nat. Hist., vol. 27, 1910, p. 321.

The ability to learn by experience necessarily implies the development, somewhere in the brain, of a something which can act not only as a receptive organ for impressions of the senses and a means for securing that their influence will find expression in modifying behavior, but also serve in a sense as a recording apparatus for storing such impressions, so that they may be revived in memory at some future time in association with other impressions received simultaneously, the state of consciousness they evoked, and the response they called forth.

Such an organ of associative memory is actually found in the brain of mammals. It is the cortical area to which 11 years ago I applied the term "neopallium."¹ Into it pathways lead from all the sense organs; and each of its territories, which receives a definite kind of impression, visual, acoustic, tactile, or any other, is linked by the most intimate bonds with all the others. In spite of the disapproval of the psychologists, we can indeed regard the neopallium as fulfilling all the conditions of the *sensorium commune*, which Aristotle and many generations of philosophers have sought for 20 centuries; for it is unquestionably a "unitary organ the physical processes of which might be regarded as corresponding to the unity of consciousness." (Wm. MacDougall.)

Nothing that happens in this area in the course of its enormous expansion and differentiation in the higher mammals materially affects this fundamental purpose of the neopallium, which continues to remain a unifying organ that acts as a whole, though each part is favorably placed to receive and transmit to the rest its special quota to the sum total of what we may call the materials of conscious life.

The consciousness which resides, so to speak, in this neopallium, and is fed by the continual stream of sensory impressions pouring into it and awakening memories of past sensations, can express itself directly in the behavior of the animal through the intermediation of a part of the neopallium itself, the so-called motor area, which is not only kept in intimate relation with the muscles, tendons, and skin by sensory impressions, but controls the voluntary responses of the muscles of the opposite side of the body.

THE DIFFERENTIATION OF MAMMALS AND THE EFFECTS OF SPECIALIZATION.

The possession of this higher type of brain enormously widened the scope for the conscious and intelligent adaptation of the animal to varying surroundings, and in the exercise of this newly acquired ability to learn from individual experience, and so appreciate the possibilities of fresh sources of food supply and new modes of life,

¹ "The Natural Subdivision of the Cerebral Hemisphere," *Journ. Anat. and Phys.*, vol. 35, 1901, p. 431
Arris and Gale lectures on the evolution of the brain, *Lancet*, Jan. 15, 1910, p. 153.

the way was opened for an infinite series of adaptations to varying environments, entailing structural modifications in which the enhanced plasticity of the new type of animal found expression.

Nature tried innumerable experiments with the new type of brain almost as soon as the humble Therapsid-like mammal felt the impetus of its new-found power of adaptation. In turn the Prototherian and Metatherian types of brain were tried before the more adaptable scheme of the Eutherian brain was evolved.

The new breed of intelligent creatures rapidly spread from their South African home throughout the whole world and exploited every mode of livelihood. The power of adaptation to the particular kind of life each group chose to pursue soon came to be expressed in a bewildering variety of specializations in structure, some for living on the earth or burrowing in it, others for living in trees or even for flight; others, again, for an aquatic existence. Some mammals became fleet of foot and developed limbs specially adapted to enhance their powers of rapid movement. They attained an early preeminence and were able to grow to large dimensions in the slow-moving world at the dawn of the age of mammals. Others developed limbs specially adapted for swift attack and habits of stealth successfully to prey upon their defenseless relatives.

Most of these groups attained the immediate success that often follows upon early specialization, but they also paid the inevitable penalty. They became definitely committed to one particular kind of life, and in so doing they had sacrificed their primitive simplicity and plasticity of structure and in great measure their adaptability to new conditions. The retention of primitive characters, which so many writers upon biological subjects, and especially upon anthropology, assume to be a sign of degradation, is not really an indication of lowliness. We should rather look upon high specialization of limbs and the narrowing of the manner of living to one particular groove as confessions of weakness, the renunciation of the wider life for one that is sharply circumscribed.

The stock from which man eventually emerged played a very humble rôle for long ages after many other mammalian orders had waxed great and strong. But the race is not always to the swift, and the lowly group of mammals which took advantage of its insignificance to develop its powers evenly and very gradually without sacrificing in narrow specialization any of its possibilities of future achievement, eventually gave birth to the dominant and most intelligent of all living creatures.

The tree shrews are small squirrel-like animals which feed on "insects and fruit, which they usually seek in trees, but also occasionally on the ground. When feeding, they often sit on their haunches, holding the food, after the manner of squirrels, in their

fore paws.”¹ They are of “lively disposition and great agility.”² These vivacious, large-brained little insectivores, linked by manifold bonds of relationship to some of the lowliest and most primitive mammals, present in the structure of their skull, teeth, and limbs undoubted evidence of kinship, remote though none the less sure, with their compatriots the Maylaysian lemurs, and it is singularly fortunate for us in this inquiry that side by side there should have been preserved from the remote Eocene times, and possibly earlier still, these insectivores, which had almost become primates, and a little primitive lemuroid, the spectral tarsier, which had only just assumed the characters of the primate stock, when nature fixed their types and preserved them throughout the ages, with relatively slight change, for us to study at the present day.

Thus we are able to investigate the influence of an arboreal mode of life in stimulating the progressive development of a primitive mammal and to appreciate precisely what changes were necessary to convert the lively, agile *Ptilocercus*-like ancestor of the primates into a real primate.

In the forerunners of the mammalia the cerebral hemisphere was predominantly olfactory in function, and even when the true mammal emerged and all the other senses received due representation in the neopallium the animal's behavior was still influenced to a much greater extent by smell impressions than by those of the other senses.

This was due not only to the fact that the sense of smell had already installed its instruments in and taken firm possession of the cerebral hemisphere long before the advent in this dominant part of the brain of any adequate representation of the other senses, but also, and chiefly, because to a small land-grubbing animal the guidance of smell impressions, whether in the search for food or as a means of recognition of friends or enemies, was much more serviceable than all the other senses. Thus the small creature's mental life was lived essentially in an atmosphere of odors, and every object in the outside world was judged primarily and predominantly by its smell. The senses of touch, vision, and hearing were merely auxiliary to the compelling influence of smell.

Once such a creature left the solid earth and took to an arboreal life all this was changed, for away from the ground the guidance of the olfactory sense lost much of its usefulness. Life amidst the branches of trees limits the usefulness of olfactory organs, but it is favorable to the high development of vision, touch, and hearing. Moreover, it demands an agility and quickness of movement that necessitates an efficient motor cortex to control and coordinate

¹ Flower and Lydekker, “Mammals, Living and Extinct,” 1891, p. 618.

² W. K. Gregory, *op. cit.*, p. 269, and pp. 279, 280.

such actions as an arboreal mode of life demands (and secures, by the survival only of those so fitted) and also a well-developed muscular sensibility to enable such acts to be carried out with precision and quickness. In the struggle for existence, therefore, all arboreal mammals, such as the tree shrews, suffer a marked diminution of their olfactory apparatus and develop a considerable neopallium in which relatively large areas are given up to visual, tactile, acoustic, kinæsthetic, and motor functions, as well as to the purpose of providing a mechanism for mutually blending in consciousness the effects of the impressions pouring in through the avenues of these senses.

Thus a more equable balance of the representation of the senses is brought about in the large brain of the arboreal animal, and its mode of life encourages and makes indispensable the acquisition of agility. Moreover, these modifications do not interfere with the primitive characters of limb and body. These small arboreal creatures were thus free to develop their brains and maintain all the plasticity of a generalized structure, which eventually enabled them to go far in the process of adaptation to almost any circumstances that presented themselves.

Amongst the members of this group, as in all the other mammalian phyla, the potency of the forces of natural selection was immensely enhanced by the fact that the inquisitiveness of an animal which can learn by experience—i. e., is endowed with intelligence—was leading these plastic insectivores into all kinds of situations which were favorable for the operation of selection. Various members of the group became specialized in different ways. Of such specialized strains the one of chief interest to us is that in which the sense of vision became especially sharpened.

THE ORIGIN OF PRIMATES.

Toward the close of the Cretaceous period some small arboreal shrew-like creature took another step in advance, which was fraught with the most far-reaching consequences, for it marked the birth of the primates and the definite branching off from the other mammals of the line of man's ancestry.

A noteworthy further reduction in the size of the olfactory parts of the brain, such as is seen in that of *Tarsius*,¹ quite emancipated the creature from the dominating influence of olfactory impressions, the sway of which was already shaken, but not quite overcome when its tupaioid ancestor took to an arboreal life. This change was associated with an enormous development of the visual cortex in the neopallium, which not only increased in extent so as far to exceed that

¹ "On the Morphology of the Brain in the Mammalia, with Special Reference to that of the Lemurs, Recent and Extinct," *Trans. Linn. Soc. Lond.*, second series; *Zoology*, vol. 8, part 10, February, 1903.

of Tupaia, but also became more highly specialized in structure. Thus, in the primitive primate, vision entirely usurped the controlling place once occupied by smell; but the significance of this change is not to be measured merely as the substitution of one sense for another. The visual area of cortex, unlike the olfactory, is part of the neopallium, and when its importance thus became enhanced the whole of the neopallium felt the influence of the changed conditions. The sense of touch also shared in the effects, for tactile impressions and the related kinæsthetic sensibility, the importance of which to an agile tree-living animal is obvious, assist vision in the conscious appreciation of the nature and the various properties of the things seen, and in learning to perform agile actions which are guided by vision.

An arboreal life also added to the importance of the sense of hearing; and the cortical representation of this sense exhibits a noteworthy increase in the primates, the significance of which it would be difficult to exaggerate in the later stages, when the simian are giving place to the distinctively human characteristics.

The high specialization of the sense of sight awakened in the creature the curiosity to examine the objects around it with closer minuteness, and supplied guidance to the hands in executing more precise and more skilled movements than the tree shrew attempts. Such habits not only tended to develop the motor cortex itself, trained the tactile and kinæsthetic senses, and linked up their cortical areas in bonds of more intimate associations with the visual cortex, but they stimulated the process of specialization within or alongside the motor cortex of a mechanism for regulating the action of that cortex itself—an organ of attention which coordinated the activities of the whole neopallium so as the more efficiently to regulate the various centers controlling the muscles of the whole body. In this way not only is the guidance of all the senses secured, but the way is opened for all the muscles of the body to act harmoniously so as to permit the concentration of their action for the performance at one moment of some delicate and finely adjusted movement.

In some such way as this there was evolved from the motor area itself, in the form of an outgrowth placed at first immediately in front of it, a formation, which attains much larger dimensions and a more pronounced specialization of structure in the primates than in any other order; it is the germ of that great prefrontal area of the human brain which is said to be "concerned with attention and the general orderly coordination of psychic processes,"¹ and as such is, in far greater measure than any other part of the brain, deserving of being regarded as the seat of the higher mental faculties and the crowning glory and distinction of the human fabric.

¹ J. S. Bolton "The Functions of the Frontal Lobes," *Brain*, 1903.

[By means of lantern slides representing Dr. Scharff's convincing elucidation of the modifications of the land connections during Tertiary times, a demonstration was given of the wanderings of the primates, which the facts of paleontology and comparative anatomy demand; the object being to direct attention to the fact that at each stage in the migrations of man's ancestors, menotyphlous, prosimian, platyrrhine, catarrhine, and anthropoid, the unprogressive members remained somewhere in the neighborhood of the home of their immediate ancestors, and that those which wandered into new surroundings had to struggle for their footing, and as the result of this striving attained a higher rank.

Other slides were shown to demonstrate the fact that in this series of primates there was a steady development of the brain—expansion and differentiation of the visual, tactile, and auditory centers, and development of the meeting territory between them; a marked growth and specialization of the motor centers, and the power of skilled movements, especially of the hands and fingers; and a regular expansion of the prefrontal area—along the lines marked out once for all when the first primate was formed from some menotyphlous progenitor.]

Thus the outstanding feature in the gradual evolution of the primate brain is a steady growth and differentiation of precisely those cortical areas which took on an enhanced importance in the earliest primates.

So far in this address I have been delving into the extremely remote, rather than the nearer, ancestry of man, because I believe the germs of his intellectual preeminence were sown at the very dawn of the Tertiary period, when the first anaptomorphid began to rely upon vision rather than smell as its guiding sense. In all the succeeding ages since that remote time the fuller cultivation of the means of profiting by experience, which the tarsiodid had adopted, led to the steady upward progression of the primates. From time to time many individuals, finding themselves amidst surroundings which were thoroughly congenial and called for no effort, lagged behind; and in *Tarsius* and the lemurs, the New World monkeys, the Old World monkeys, and the anthropoids, not to mention the extinct forms, we find preserved a series of these laggards which have turned aside from the highway which led to man's estate.

The primates at first were a small and humble folk, who led a quiet, unobtrusive, and safe life in the branches of trees, taking small part in the fierce competition for size and supremacy that was being waged upon the earth beneath them by their carnivorous, ungulate, and other brethren. But all the time they were cultivating that equable development of all their senses and limbs, and that special development of the more intellectually useful faculties of the mind which, in

the long run, were to make them the progenitors of the dominant mammal—the mammal which was to obtain the supremacy over all others, while still retaining much of the primitive structure of limb that his competitors had sacrificed. It is important, then, to keep in mind that the retention of primitive characters is often to be looked upon as a token that their possessor has not been compelled to turn aside from the straight path and adopt protective specializations, but has been able to preserve some of his primitiveness and the plasticity associated with it, precisely because he has not succumbed or fallen away in the struggle for supremacy. It is the wider triumph of the individual who specializes late, after benefiting by the many-sided experience of early life, over him who in youth becomes tied to one narrow calling.

In many respects man retains more of the primitive characteristics, for example, in his hands, than his nearest simian relatives; and in the supreme race of mankind many traits, such as abundance of hair, persist to suggest pithecoïd affinities, which have been lost by the more specialized negro and other races. Those anthropologists who use the retention of primitive features in the Nordic European as an argument to exalt the negro to equality with him are neglecting the clear teaching of comparative anatomy, that the persistence of primitive traits is often a sign of strength rather than of weakness. This factor runs through the history of the whole animal kingdom.¹ Man is the ultimate product of that line of ancestry which was never compelled to turn aside and adopt protective specialization either of structure or mode of life, which would be fatal to its plasticity and power of further development.

Having now examined the nature of the factors that have made a primate from an insectivore and have transformed a tarsioïd prosimian into an ape, let us turn next to consider how man himself was fashioned.

THE ORIGIN OF MAN.

It is the last stage in the evolution of man that has always excited chief interest and has been the subject of much speculation, as the addresses of my predecessors in this presidency bear ample witness.

These discussions usually resolve themselves into the consideration of such questions as whether it was the growth of the brain, the acquisition of the power of speech, or the assumption of the erect attitude that came first and made the ape into a human being. The case for the erect attitude was ably put before the association in the address delivered to this section by Dr. Munro in 1893. He argued that the liberation of the hands and the cultivation of their skill lay at the root of man's mental supremacy.

¹ "The Brain in the Edentata," *Trans. Linn. Soc.*, 1899.

If the erect attitude is to explain all, why did not the gibbon become a man in Miocene times? The whole of my argument has aimed at demonstrating that the steady growth and specialization of the brain has been the fundamental factor in leading man's ancestors step by step right upward from the lowly insectivore status, nay, further, through every earlier phase in the evolution of mammals—for man's brain represents the consummation of precisely those factors which throughout the vertebrata have brought their possessors to the crest of the wave of progress. But such advances as the assumption of the erect attitude are brought about simply because the brain has made skilled movements of the hands possible and of definite use in the struggle for existence; yet once such a stage has been attained the very act of liberating the hands for the performance of more delicate movements opens the way for a further advance in brain development to make the most of the more favorable conditions and the greater potentialities of the hands.

It is a fact beyond dispute that the divergent specialization of the human limbs, one pair for progression, and the other for prehension and the more delicately adjusted skilled action, has played a large part in preparing the way for the emergence of the distinctly human characteristics: but it would be a fatal mistake unduly to magnify the influence of these developments. The most primitive living primate, the spectral tarsier, frequently assumes the erect attitude, and uses its hands for prehension rather than progression in many of its acts, and many other lemurs, such as the *Indrisinæ* of Madagascar, can and do walk erect.

In the remote Oligocene, a catarrhine ape, nearly akin to the ancestors of the Indian sacred monkey, *Semnopithecus*, became definitely specialized in structure in adaptation for the assumption of the erect attitude; and this type of early anthropoid has persisted with relatively slight modifications in the gibbon of the present day. But if the earliest gibbons were already able to walk upright, how is it, one might ask, that they did not begin to use their hands, thus freed from the work of progression on the earth, for skilled work, and at once before men? The obvious reason is that the brain had not yet attained a sufficiently high stage of development to provide a sufficient amount of useful skilled work, apart from the tree climbing, for these competent hands to do.

The ape is tied down absolutely to his experience, and has only a very limited ability to anticipate the results even of relatively simple actions, because so large a proportion of his neopallium is under the dominating influence of the senses.

Without a fuller appreciation of the consequences of its actions than the gibbon is capable of, the animal is not competent to make the fullest use of the skill it undoubtedly possesses. What is implied

in acquiring this fuller appreciation of the meaning of events taking place around the animal? The state of consciousness awakened by a simple sensory stimulation is not merely an appreciation of the physical properties of the object that supplies the stimulus; the object simply serves to bring to consciousness the results of experience of similar or contrasted stimulations in the past, as well as the feelings aroused by or associated with them, and the acts such feelings excited. This mental enrichment of a mere sensation so that it acquires a very precise and complex meaning is possible only because the individual has this extensive experience to fall back upon; and the faculty of acquiring such experience applies the possession of large neopallial areas for recording, so to speak, these sensation factors and the feelings associated with them. The "meaning" which each creature can attach to a sensory impression presumably depends, not on its experience only, but more especially upon the neopallial provision in its brain for recording the fruits of such experience.

Judged by this standard, the human brain bears ample witness, in the expansion of the great temporo-parietal area, which so obviously has been evolved from the regions into which visual, auditory, and tactile impulses are poured, to the perfection of the physical counterpart of the enrichment of mental structure, which is the fundamental characteristic of the human mind.

The second factor that came into operation in the evolution of the human brain is merely the culmination of a process which has been steadily advancing throughout the primates. I refer to the high state of perfection of the cortical regulation of skilled movements, many of which are acquired by each individual in response to a compelling instinct that forces every normal human being to work out his own salvation by perpetually striving to acquire such manual dexterity.

This brings us to the consideration of the nature of the factors that have led to the wide differentiation of man from the gorilla. Why is it that these two primates, structurally so similar and derived simultaneously from common parents, should have become separated by such an enormous chasm, so far as their mental abilities are concerned?

There can be no doubt that this process of differentiation is of the same nature as those which led one branch of the Eocene tarsoids to become monkeys while the other remained prosimæ; advanced one group of primitive monkeys to the catarrhine status, while the rest remained platyrrhine; and converted one division of the Old World apes into anthropoids, while the others retained their old status. Put into this form as an obvious truism, the conclusion is suggested that the changes which have taken place in the brain to convert an ape into man are of the same nature as, and may be looked upon merely as a continuation of, those processes of evolution

which we have been examining in the lowlier members of the primate series. It was not the adoption of the erect attitude or the invention of articulate language that made man from an ape, but the gradual perfecting of the brain and the slow upbuilding of the mental structure, of which erectness of carriage and speech are some of the incidental manifestations.

The ability to perform skilled movements is conducive to a marked enrichment of the mind's structure and the high development of the neopallium, which is the material expression of that enrichment. There are several reasons why this should be so. The mere process of learning to execute any act of skill necessarily involves the cultivation, not only of the muscles which produce the movement, and the cortical area which excites the actions of these muscles, but in even greater measure the sensory mechanisms in the neopallium which are receiving impressions from the skin, the muscles, and the eyes, to control the movements at the moment, and incidentally are educating these cortical areas, stimulating their growth, and enriching the mental structure with new elements of experience. Out of the experience gained in constantly performing acts of skill the knowledge of cause and effect is eventually acquired. Thus the high specialization of the motor area, which made complicated actions possible, and the great expansion of the temporo-parietal area, which enabled the ape-man to realize the "meaning" of events occurring around it, reacted one upon the other, so that the creature came to understand that a particular act would entail certain consequences. In other words, it gradually acquired the faculty of shaping its conduct in anticipation of results.

Long ages ago, possibly in the Miocene, the ancestors common to man, the gorilla, and the chimpanzee became separated into groups, and the different conditions to which they became exposed after they parted company were in the main responsible for the contrasts in their fate. In one group the distinctively primate process of growth and specialization of the brain, which had been going on in their ancestors for many thousands, even millions, of years, reached a stage when the more venturesome members of the group, stimulated perhaps by some local failure of the customary food, or maybe led forth by a curiosity bred of their growing realization of the possibilities of the unknown world beyond the trees which hitherto had been their home, were impelled to issue forth from their forests, and seek new sources of food and new surroundings on hill and plain, wherever they could obtain the sustenance they needed. The other group, perhaps because they happened to be more favorably situated or attuned to their surroundings, living in a land of plenty which encouraged indolence in habit and stagnation of effort and growth, were free from this glorious unrest, and remained apes, continuing to lead

very much the same kind of life (as gorillas and chimpanzees) as their ancestors had been living since the Miocene or even earlier times. That both of these unenterprising relatives of man happen to live in the forests of tropical Africa has always seemed to me to be a strong argument in favor of Darwin's view that Africa was the original home of the first creatures definitely committed to the human career; for while man was evolved amidst the strife with adverse conditions, the ancestors of the gorilla and chimpanzee gave up the struggle for mental supremacy simply because they were satisfied with their circumstances; and it is more likely than not that they did not change their habitat.

The erect attitude, infinitely more ancient than man himself, is not the real cause of man's emergence from the simian stage; but it is one of the factors made use of by the expanding brain as a prop still further to extend its growing dominion, and by fixing and establishing in a more decided way this erectness it liberated the hand to become the chief instrument of man's further progress.

In learning to execute movements of a degree of delicacy and precision to which no ape could ever attain, and the primitive ape-man could only attempt once his arm was completely emancipated from the necessity of being an instrument of progression, that cortical area which seemed to serve for the phenomena of attention became enhanced in importance. Hence the prefrontal region, where the activities of the cortex as a whole are, as it were, focused and regulated, began to grow until eventually it became the most distinctive characteristic of the human brain, gradually filling out the front of the cranium and producing the distinctively human forehead. In the diminutive prefrontal area of *Pithecanthropus*,¹ and to a less marked degree, Neanderthal man,² we see illustrations of lower human types, bearing the impress of their lowly state in receding foreheads and great brow ridges. However large the brain may be in *Homo primigenius*, his small prefrontal region, if we accept Boule and Anthony's statements, is sufficient evidence of his lowly state of intelligence and reason for his failure in the competition with the rest of mankind.

The growth in intelligence and in the powers of discrimination no doubt led to a definite cultivation of the æsthetic sense, which, operating through sexual selection, brought about a gradual refinement of the features, added grace to the general build of the body, and demolished the greater part of its hairy covering. It also led to an intensification of the sexual distinctions, especially by developing

¹ Eug. Dubois, "Remarks upon the Brain-cast of *Pithecanthropus*," Proc. Fourth Internat. Cong. Zool., August, 1898, published Cambridge, 1899, p. 81.

² Boule and Anthony, "L'encéphale de l'homme fossile de la Chapelle-aux-Saints," L'Anthropologie, tome 22, No. 2, 1911, p. 50.

in the female localized deposits of fatty tissue, not found in the apes, which produced profound alterations in the general form of the body.

RIGHT-HANDEDNESS.

To one who considers what precisely it means to fix the attention and attempt the performance of some delicately adjusted and precise action it must be evident that one hand only can be usefully employed in executing the consciously skilled part in any given movement. The other hand, like the rest of the muscles of the whole body, can be only auxiliary to it, assisting, under the influence of attention, either passively or actively, in steadying the body or helping the dominant hand. Moreover, it is clear that if one hand is constantly employed for doing the more skilled work, it will learn to perform it more precisely and more successfully than either would if both were trained, in spite of what ambidextral enthusiasts may say. Hence it happened that when nature was fashioning man the forces of natural selection made one hand more apt to perform skilled movements than the other. Why precisely it was the right hand that was chosen in the majority of mankind we do not know, though scores of anatomists and others are ready with explanations. But probably some slight mechanical advantage in the circumstances of the limb, or perhaps even some factor affecting the motor area of the left side of the brain that controls its movements, may have inclined the balance in favor of the right arm; and the forces of heredity have continued to perpetuate a tendency long ago imprinted in man's structure when first he became human.

The fact that a certain proportion of mankind is left-handed, and that such a tendency is transmitted to some only of the descendants of a left-handed person, might perhaps suggest that one half of mankind was originally left-handed and the other right-handed, and that the former condition was recessive in the Mendelian sense, or that some infinitesimal advantage may have accrued to the right-handed part of the original community, which in time of stress spared them in preference to left-handed individuals; but the whole problem of why right-handedness should be much more common than left-handedness is still quite obscure. The superiority of one hand is as old as mankind, and is one of the factors incidental to the evolution of man.

It is easily comprehensible why one hand should become more expert than the other, as I have attempted to show; and the fact remains that it is the right hand, controlled by the left cerebral hemisphere, which is specially favored in this respect. This heightened educability of the (left) motor center (for the right hand) has an important influence upon the adjoining areas of the left motor

cortex. When the ape-man attained a sufficient degree of intelligence to wish to communicate with his fellows other than by mere instinctive emotional cries and grimaces, such as all social groups of animals employ, the more cunning right hand would naturally play an important part in such gestures and signs; and, although the muscles on both sides of the face would be called into action in such movements of the features as were intended to convey information to another (and not merely to express the personal feelings of the individual), such bilateral movements would certainly be controlled by the left side of the brain, because it was already more highly educated.

THE ORIGIN OF SPEECH.

[This argument was elaborated to explain the origin of speech. The increasing ability to perform actions demanding skill and delicacy received a great impetus when the hands were liberated for the exclusive cultivation of such skill; this perfection of cerebral control over muscular actions made it possible for the ape-man to learn to imitate the sounds around him, for the act of learning is a training not only of the motor centers and the muscles concerned, but also of the attention, and the benefits that accrued from educating the hands added to the power of controlling other muscles, such as those concerned with articulate speech.]

The usefulness of such power of imitating sounds could be fully realized in primitive man, not only because he had developed the parts of the brain which made the acquisition of such skill possible, but also because he had acquired, in virtue of the development of other cortical areas, the ability to realize the significance and learn the meaning of the sounds heard.]

I do not propose to discuss the tremendous impetus that the invention of speech must have given to human progress and intellectual development, in enabling the knowledge acquired by each individual to become the property of the community and be handed on to future generations, as well as by supplying in words the very symbols and the indispensable elements of the higher mental process.

We are apt to forget the immensity of the heritage that has come down to us from former generations of man, until we begin dimly to realize that for the vast majority of mankind almost the sum total of their mental activities consists of imitation or acquiring and using the common stock of beliefs. For this accumulation of knowledge and its transmission to our generation we are almost wholly indebted to the use of speech. In our forgetfulness of these facts we marvel at the apparent dullness of early man in being content to use the most roughly chipped flints for many thousands of years before he learned to polish them, and eventually to employ

materials better suited for the manufacture of implements and weapons. But when we consider how slowly and laboriously primitive man acquired new ideas, and how such ideas—even those which seem childishly simple and obvious to us—were treasured as priceless possessions and handed on from tribe to tribe, it becomes increasingly difficult to believe in the possibility of the independent evolution of similar customs and inventions of any degree of complexity.

The hypothesis of the "fundamental similarity of the working of the human mind" is no more potent to explain the identity of customs in widely different parts of the world, the distribution of megalithic monuments, or the first appearance of metals in America, than it is to destroy our belief that one man, and one only, originally conceived the idea of the mechanical use to which steam could be applied, or that the electric battery was not independently evolved in each of the countries where it is now in use.

In these discursive remarks I have attempted to deal with old problems in the light of newly acquired evidence; to emphasize the undoubted fact that the evolution of the primates and the emergence of the distinctively human type of intelligence are to be explained primarily by a steady growth and specialization of certain parts of the brain; that such a development could have occurred only in the mammalia, because they are the only plastic class of animals with a true organ of intelligence; that an arboreal mode of life started man's ancestors on the way to preeminence, for it gave them the agility; and the specialization of the higher parts of the brain incidental to such a life gave them the seeing eye; and in course of time also the understanding ear; and that all the rest followed in the train of this high development of vision working on a brain which controlled ever-increasingly agile limbs.

If, in pursuing these objects, I may have seemed to wander far from the beaten paths of anthropology, as it is usually understood in this section, and perhaps encroached upon the domains of the zoological section, my aim has been to demonstrate that the solution of these problems of human origins, which have frequently engaged the attention of the anthropological section, is not to be sought merely in comparisons of man and the anthropoid apes. Man has emerged not by the sudden intrusion of some new element into the ape's physical structure or the fabric of his mind, but by the culmination of those processes which have been operating in the same way in a long line of ancestors ever since the beginning of the Tertiary period.

If I have made this general conception clear to you, however clumsily I have marshaled the evidence and with whatever crudities of psychological statement it may be marred, I shall feel that this address has served some useful purpose.

THE HISTORY AND VARIETIES OF HUMAN SPEECH.¹

By DR. EDWARD SAPIR,
The Canadian Geological Survey.

Perhaps no single feature so markedly sets off man from the rest of the animal world as the gift of speech, which he alone possesses. No community of normal human beings, be their advance in culture ever so slight, has yet been found, or is ever likely to be found, who do not communicate among themselves by means of a complex system of sound symbols; in other words, who do not make use of a definitely organized spoken language. It is indeed one of the paradoxes of linguistic science that some of the most complexly organized languages are spoken by so-called primitive peoples, while, on the other hand, not a few languages of relatively simple structure are found among peoples of considerable advance in culture. Relatively to the modern inhabitants of England, to cite but one instance out of an indefinitely large number, the Eskimos must be considered as rather limited in cultural development. Yet there is just as little doubt that in complexity of form the Eskimo language goes far beyond English. I wish merely to indicate that, however much we may indulge in speaking of primitive man, of a primitive language in the true sense of the word we find nowhere a trace. It is true that many of the lower animals, for example, birds, communicate by means of various cries, yet no one will seriously maintain that such cries are comparable to the conventional words of present-day human speech; at best they may be compared to some of our interjections, which, however, falling outside the regular morphologic and syntactic frame of speech, are least typical of the language of human beings. We can thus safely make the absolute statement that language is typical of all human communities of to-day and of such previous times as we have historical knowledge of, and that language, aside from reflex cries, is just as untypical of all nonhuman forms of animal life. Like all other forms of human activity, language must have its history.

Much has been thought and written about the history of language. Under this term may be included two more or less distinct lines of inquiry. One may either trace the changes undergone by a partic-

¹ Lecture delivered at the University of Pennsylvania Museum, Apr. 1, 1911. (Reprinted by permission from *The Popular Science Monthly*, July, 1911.)

ular language or group of languages for as long a period as the evidence at hand allows, or one may attempt to pass beyond the limits of historically recorded or reconstructed speech, to reconstruct the ultimate origin of speech in general, and to connect these remote origins by means of reconstructed lines of development with historically attested forms of speech. Superficially the latter sort of inquiry is similar in spirit to the labors of the evolutionary biologist, for in both apparently heterogeneous masses of material are, by direct chronologic testimony, inference, analogy, and speculation reduced to an orderly historical sequence. As a matter of fact, however, the reconstruction of linguistic origins and earliest lines of development is totally different in kind from biological reconstruction, as we shall see presently.

Taking up the history of language in the sense in which it was first defined, we find that there are two methods by which we can follow the gradual changes that a language has undergone. The first and most obvious method is to study the literary remains of the various periods of the language of which we have record. It will then be found that not only the vocabulary, but just as well the phonetics, word morphology, and syntactic structure of the language tend to change from one period to another. These changes are always very gradual and, within a given period of relatively short duration, slight or even imperceptible in amount. Nevertheless, the cumulative effect of these slight linguistic changes is, with the lapse of time, so great that the form of speech current at a given time, when directly compared with the form of speech of the same language current at a considerably earlier time, is found to differ from the latter much as it might from a foreign language. It is true that the rate of change has been found to be more rapid at some periods of a language than at others, but it nevertheless always remains true that the changes themselves are not violent and sudden, but gradual in character. The documentary study of language history is of course the most valuable and on the whole the most satisfactory. It should not be denied, however, that there are dangers in its use. Literary monuments do not always accurately reflect the language of the period; moreover, orthographic conservatism hides the phonetic changes that are constantly taking place. Thus there is no doubt that the amount of change that English has undergone from the time of Shakespeare to the present is far greater than a comparison of present-day with Elizabethan orthography would lead the layman to suppose, so much so that I am quite convinced the great dramatist would have no little difficulty in making himself understood in Stratford-on-Avon to-day. For some languages a considerable amount of documentary historical material is available. Thus, the literary monuments that enable us to study the history of the English language succeed each other in a

practically uninterrupted series from the eighth century A. D. to the present time, while the course of development of Greek in its various dialects can be more or less accurately followed from the ninth century B. C., a conservative date for the Homeric poems, to the present time.

For some, in fact for most languages, however, literary monuments are either not forthcoming at all or else are restricted to a single period of short duration. At first sight it would seem that the scientific study of such languages would have to be limited to purely descriptive rather than historical data. To a considerable extent this is necessarily true, yet an intensive study will always yield at least some, oftentimes a great deal of, information of a historical character. This historical reconstruction on the basis of purely descriptive data may proceed in two ways. It is obvious that the various phonetic and grammatical features of a language at any given time are of unequal antiquity, for they are the resultants of changes that have taken place at very different periods; hence it is reasonable to suppose that internal evidence would, at least within modest limits, enable one to reconstruct the relative chronology of the language. Naturally one must proceed very cautiously in reconstructing by means of internal evidence, but it is oftentimes surprising how much the careful and methodically schooled student can accomplish in this way. Generally speaking, linguistic features that are irregular in character may be considered as relatively archaic, for they are in the nature of survivals of features at one time more widely spread. Not infrequently an inference based on internal evidence can be corroborated by direct historical testimony. One example will suffice here. We have in English a mere sprinkling of noun plurals in *-en*, such as *brethren* and *oxen*. One may surmise that nouns such as these are but the last survivals of a type formerly existing in greater abundance, and indeed a study of Old English or Anglo-Saxon demonstrates that noun plurals in *-en* were originally found in great number but were later almost entirely replaced by plurals in *-s*. There is, however, a far more powerful method of reconstructing linguistic history from descriptive data than internal evidence. This is the comparison of genetically related languages.

In making a survey of the spoken languages of the world, we soon find that though they differ from each other, they do so in quite varying degrees. In some cases the differences are not great enough to prevent the speakers of the two languages from understanding each other with a fair degree of ease, under which circumstances we are apt to speak of the two forms of speech as dialects of a single language; in other cases the two languages are not mutually intelligible, but, as in the case of English and German, present so many similarities of detail that a belief in their common origin seems warranted and

indeed necessary; in still other cases the two languages are at first glance not at all similar, but reveal on a closer study so many fundamental traits in common that there seems just ground for suspecting a common origin. If other languages can be found which serve to lessen the chasm between the two, and particularly if it is possible to compare them in the form in which they existed in earlier periods, this suspicion of a common origin may be raised to a practical certainty. Thus, direct comparison of Russian and German would certainly yield enough lexical and grammatical similarities to justify one in suspecting them to have diverged from a common source; the proof of such genetic relationship, however, can not be considered quite satisfactory until the oldest forms of German speech and Germanic speech generally have been compared with the oldest forms of Slavic speech and until both of these have been further compared with other forms of speech, such as Latin and Greek, that there is reason to believe they are genetically related to. When such extensive, not infrequently difficult, comparisons have been effected, complete evidence may often be obtained of what in the first instance would have been merely suspected. If all the forms of speech that can be shown to be genetically related are taken together and carefully compared among themselves, it is obvious that much information will be inferred as to their earlier undocumented history; in favorable cases much of the hypothetical form of speech from which the available forms have diverged may be reconstructed with a considerable degree of certainty or plausibility. If under the term "history of English" we include not only documented but such reconstructed history as has been referred to, we can say that at least in main outline it is possible to trace the development of our language back from the present day to a period antedating at any rate 1500 B. C. It is important to note that, though the English of to-day bears only a faint resemblance to the hypothetical reconstructed Indogermanic speech of say 1500 B. C. or earlier, there could never have been a moment from that time to the present when the continuity of the language was broken. From our present standpoint that bygone speech of 1500 B. C. was as much English as it was Greek or Sanskrit. The history of the modern English words *foot* and its plural *feet* will illustrate both the vast difference between the two forms of speech at either end of the series and the gradual character of the changes that have taken place within the series. Without here going into the actual evidence on which the reconstructions are based, I shall merely list the various forms which each word has had in the course of its history. Starting, then, with *foot*—*feet*, and gradually going back in time, we have *fūt*—*fīt*, *fōt*—*fēt*, *fōt*—*fēte*, *fōt*—*fōte*, *fōt*—*fōti*, *fōt*—*fōti*, *fōt*—*fōtir*, *fōt*—*fōtiz*, *fōt*—*fōtis*, *fōt*—*fōtes*, *fōd*—*fodes*, and finally *pōd*—*pōdes*, beyond

which our evidence does not allow us to go; the last forms find their reflex in Sanskrit *pād*—*pādas*.

All languages that can be shown to be genetically related—that is, to have sprung from a common source—form a historic unit to which the term linguistic stock or linguistic family is applied. If, now, we were in a position to prove that all known forms of speech could be classified into a single linguistic stock, the apparent parallel above referred to between linguistic and biological reconstruction would be a genuine one. As it is, we must content ourselves with operating with distinct and, as far as we can tell, genetically unrelated linguistic stocks. The documentary evidence and the reconstructive evidence gained by comparison enable us to reduce the bewildering mass of known languages to a far smaller number of such larger stock groups, yet the absolute number of these latter groups still remains disquietingly large. The distribution of linguistic stocks presents great irregularities. In Europe there are only three such represented: the Indogermanic or Aryan, which embraces nearly all the better known languages of the continent; the Ural-Altaiic, the best known representatives of which are Finnish, Hungarian, and Turkish; and the Basque of southwestern France and northern Spain. On the other hand, that part of aboriginal North America which lies north of Mexico alone embraces 50 or more distinct linguistic stocks so far as known at present. Some stocks, as, for instance, the Indogermanic just referred to and the Algonkin of North America, are spread over vast areas and include many peoples or tribes of varying cultures; others, such as the Basque and many of the aboriginal stocks of California, occupy surprisingly small territories. It is possible to adopt one of two attitudes toward this phenomenon of the multiplicity of the largest known genetic speech aggregates. On the one hand one may assume that the disintegrating effects of gradual linguistic change have in many cases produced such widely differing forms of speech as to make their comparison for reconstructive purposes of no avail, in other words, that what appear to us to-day to be independent linguistic stocks appear such not because they are in fact historically unrelated, but merely because the evidence of such historical connection has been so obscured by time as to be practically lost. On the other hand, one may prefer to see in the existence of mutually independent linguistic stocks evidence of the independent beginnings and development of human speech at different times and places in the course of the remote history of mankind; there is every reason to believe that in a similar manner many religious concepts and other forms of human thought and activity found widely distributed in time and place have had multiple origins, yet more or less parallel developments. It is naturally fruitless to attempt to decide between the monogenetic and polygenetic

standpoints here briefly outlined. All that a conservative student will care to do is to shrug his shoulders and to say, "Thus far we can go and no farther." It should be said, however, that more intensive study of linguistic data is from time to time connecting stocks that had hitherto been looked upon as unrelated. Yet it can hardly be expected that serious research will ever succeed in reducing the present Babel to a pristine unity.

Although we can not demonstrate a genetic unity of all forms of human speech, it is interesting to observe that there are several fundamental traits that all languages have in common. Perhaps these fundamental similarities are worthy of greater attention than they generally receive and may be thought by many to possess a high degree of significance. First of all, we find that in every known language use is made of exactly the same organic apparatus for the production of speech, that is, the glottal passage in the larynx, the nasal passages, the tongue, the hard and soft palate, the teeth and the lips. The fact that we are accustomed to consider all speech as self-evidently dependent on these organs should not blind us to the importance of the association. There is, after all, no *à priori* reason why the communication of ideas should be primarily through sound symbols produced by the apparatus just defined; it is conceivable that a system of sound symbols or noises produced by the hands and feet might have been developed for the same purpose. As a matter of fact, there are many systems of thought transference or language in the widest sense of the word, as a moment's thought will show, that are independent of the use of the ordinary speech apparatus. The use of writing will occur to every one as the most striking example among ourselves. Among primitive peoples we may instance, to cite only a couple of examples of such subsidiary forms of language, the gesture language of the Plains Indians of North America and the very highly developed drum language of several African tribes. From our present point of view it is significant to note that these and other such non-spoken languages are either, as in the case of practically all systems of writing, themselves more or less dependent on a phonetic system, that is, speech in the ordinary sense of the word, or else are merely auxiliary systems intended to replace speech only under very special circumstances. The fact then remains that the primary and universal method of thought transference among human beings is *via* a special articulating set of organs. Much loose talk has been expended by certain ethnologists on the relatively important place that gesture occupies in the languages of primitive peoples, and it has even been asserted that several so-called primitive languages are unintelligible without the use of gesture. The truth, however, is doubtless that the use of gesture is associated not with primitiveness, but rather with temperament. The Russian Jew and the Italian, for instance, non-

primitive as they are, make a far more liberal use of gestures accompanying speech than any of the aborigines of North America.

If we examine in a large way the structure of any given language, we find that it is further characterized by the use of a definite phonetic system, that is, the sounds made use of in its words are reducible to a limited number of consonants and vowels. It does not seem to be true, certain contradicting statements notwithstanding, that languages are to be found in which this phonetic definiteness is lacking and in which individual variation of pronunciation takes place practically without limit. It is of course freely granted that a certain amount of sound variation exists in every language, but it is important to note that such variation is always very limited in range and always takes place about a well-defined center. All known forms of speech, then, operate with a definite apparatus of sounds; statements to the contrary will in most cases be found to rest either on a faulty perception on the part of the recorder of sounds unfamiliar to his ear or on his ignorance of regular sound processes peculiar to the language. Naturally the actual phonetic systems found in various languages, however much they may resemble each other in this fundamental trait of definiteness, differ greatly in content, that is in the sounds actually employed or neglected. This is inevitable, for the vast number of possible and indeed existing speech sounds makes an unconscious selection necessary. Even so, however, it is at least noteworthy with what persistency such simple vowel sounds as *a* and *i* and such consonants as *n* and *s* occur in all parts of the world.

Even more than in their phonetic systems languages are found to differ in their morphologies or grammatical structures. Yet also in this matter of grammatical structure a survey from a broad point of view discloses the fact that there are certain deep-lying similarities, very general and even vague in character, yet significant. To begin with, we find that each language is characterized by a definite and, however complex, yet strictly delimited grammatical system. Some languages exhibit a specific type of morphology with greater clearness or consistency than others, while some teem with irregularities; yet in every case the structure tends to be of a definite and consistently carried out type, the grammatical processes employed are quite limited in number and nearly always clearly developed, and the logical categories that are selected for grammatical treatment are of a definite sort and number and expressed in a limited, however large, number of grammatical elements. In regard to the actual content of the various morphologies we find, as already indicated, vast differences, yet here again it is important to note with what persistence certain fundamental logical categories are reflected in the grammatical systems of practically all languages. Chief among these may be considered the clear-cut distinction everywhere made

between denominating and predicating terms; that is, between subject and predicate, or, roughly speaking, between substantive and verb. This does not necessarily imply that we have in all cases to deal with an actual difference in phonetic form between noun and verb, though as a matter of fact such differences are generally found, but simply that the structure of the sentence is such as to show clearly that one member of it is felt by the speaker and hearer to have a purely denominating office, another a purely predicating one. It may be objected that in Chinese, for instance, there is no formal distinction made between noun and verb. True, but the logical distinction of subject and predicate is reflected in the form of the Chinese sentence, inasmuch as the subject regularly precedes the predicate; thus, while the same word *may* be either noun or verb, in any particular sentence it necessarily *is* definitely one and not the other. Other fundamental logical categories will, on a more complete survey, be found to be subject to grammatical treatment in all or nearly all languages, but this is not the place to be anything but merely suggestive. Suffice it to remark on the widespread systematizing of personal relations; the widespread development of ideas of tense, number, and syntactic case relations; and the clear grammatical expression everywhere or nearly everywhere given to the largely emotional distinction of declarative, interrogative, and imperative modes.

Granted that there are certain general fundamental traits of similarity in all known languages, the problem arises of how to explain these similarities. Are they to be explained historically, as survivals of features deep-rooted in an earliest form of human speech that, despite the enormous differentiation of language that the lapse of ages has wrought, have held their own to the present day, or are they to be explained psychologically as due to the existence of inherent human mental characteristics that abide regardless of time and place? If the latter standpoint be preferred, we should be dealing with a phenomenon of parallel development. It is of course impossible to decide categorically between the two explanations that have been offered, though doubtless the majority of students would incline to the psychological rather than to the historical method. At any rate, it is clear that we can not strictly infer a monogenetic theory of speech from the fundamental traits of similarity that all forms of speech exhibit. Yet even though these are of psychologic rather than historic interest, it is important to have demonstrated the existence of a common psychological substratum, or perhaps we had better say framework, which is more or less clearly evident in all languages. This very substratum or framework gives the scientific study of language a coherence and unity quite regardless of any considerations of genetic relationship of languages.

In spite of the fact that, as we have seen, no tangible evidence can be brought to bear on the ultimate origin or origins of speech, many attempts have been made, particularly in the first half of the nineteenth century, when it was more common for historical and philosophical problems of extreme difficulty to be attacked with alacrity, to point out the way in which human speech originated or at least might have originated. From the very nature of the case these attempts could not but be deductive in method; hence, however plausible or ingenious in themselves, they have at best a merely speculative, not a genuinely scientific interest. We may therefore dispense with anything like a detailed inquiry into or criticism of these theories. Two of the most popular of them may be respectively termed the onomatopoeic or sound-imitative and the exclamatory theories. According to the former, the first words of speech were onomatopoeic in character; that is, attempts to imitate by the medium of the human organs of speech the various cries and noises of the animate and inanimate world. Thus the idea of a "hawk" would come to be expressed by an imitative vocable based on the actual screech of that bird; the idea of a "rock" might be expressed by a combination of sounds intended in a crude way to reproduce the noise of a rock tumbling down hill or of a rock striking against the butt of a tree, and so on indefinitely. In course of time, as these imitative words by repeated use became more definitely fixed in phonetic form, they would tend to take on more and more the character of conventional sound symbols; that is, of words, properly speaking. The gradual phonetic modifications brought on in the further course of time would finally cause them to lose their original onomatopoeic form. It may be freely granted that many words, particularly certain nouns and verbs having reference to auditory phenomena, may have originated in this way; indeed, many languages, among them English, have at various times, up to and including the present, made use of such onomatopoeic words. It is difficult, however, to see how the great mass of a vocabulary, let alone a complex system of morphology and syntax, could have arisen from an onomatopoeic source alone. The very fact that onomatopoeic words of relatively recent origin are found here and there in sharp contrast to the overwhelmingly larger non-onomatopoeic portion of the language accentuates, if anything, the difficulty of a general explanation of linguistic origins by means of the onomatopoeic theory.

The exclamatory theory, as its name implies, would find the earliest form of speech in reflex cries of an emotional character. These also, like the hypothetical earliest words of imitative origin, would in course of time become conventionalized and sooner or later so modified in phonetic form as no longer to betray their exclamatory origin.

The criticisms urged against the onomatopoetic theory apply with perhaps even greater force to the exclamatory one. It is, if anything, even more difficult here than in the former case to see how a small vocabulary founded on reflex cries could develop into such complex linguistic systems as we have actually to deal with. It is further significant that hardly anywhere, if at all, do the interjections play any but an inconsiderable, almost negligible, part in the lexical or grammatical machinery of language. An appeal to the languages of primitive peoples in order to find in them support for either of the two theories referred to is of little or no avail. Aside from the fact that their elaborateness of structure often seriously militates against our accepting them as evidence for primitive conditions, we do not on the whole find either the onomatopoetic or exclamatory elements of relatively greater importance in them than elsewhere. Indeed the layman would be often surprised, not to say disappointed, at the almost total absence of onomatopoetic traits in many American Indian languages for instance. In Chinook and related dialects of the lower course of the Columbia, onomatopoesis is developed to a more than usual extent, yet, as though to emphasize our contention with an apparent paradox, hardly anywhere is the grammatical mechanism of a subtler, anything but primitive character. We are forced to conclude that the existence of onomatopoetic and exclamatory features is as little correlated with relative primitiveness as we have found the use of gesture to be. As with the two theories of origin we have thus briefly examined, so it will be found to be with other theories that have been suggested. They can not, any of them, derive support from the use of the argument of survivals in historically known languages; they all reduce themselves to merely speculative doctrines.

So much for general considerations on language history. Returning to the gradual process of change which has been seen to be characteristic of all speech, we may ask ourselves what is the most central or basic factor in this never-ceasing flux. Undoubtedly the answer must be: Phonetic change or, to put it somewhat more concretely, minute or at any rate relatively trivial changes in pronunciation of vowels and consonants which, having crept in somehow or other, assert themselves more and more and end by replacing the older pronunciation, which becomes old-fashioned and finally extinct. In a general way we can understand why changes in pronunciation should take place in the course of time by a brief consideration of the process of language learning. Roughly speaking, we learn to speak our mother tongue by imitating the daily speech of those who surround us in our childhood. On second thoughts, however, it will be seen that the process involved is not one of direct imitation, but of indirect imitation based on inference. Any given

word is pronounced by a succession of various more or less complicated adjustments of the speech organs. These adjustments or articulations give rise to definite acoustic effects, effects which, in their totality, constitute speech. Obviously, if the child's imitative efforts were direct, it would have to copy as closely as possible the speech articulations which are the direct source of what it hears. But it is still more obvious that these speech articulations are largely beyond the power of observation and hence imitation. It follows that the actual sounds, not the articulations producing them, are imitated. This means that the child is subject to a very considerable period of random and, of course, wholly involuntary experimenting in the production of such articulations as would tend to produce sounds or combinations of sounds approximating more or less closely those the child hears. In the course of this experimenting many failures are produced, many partial successes. The articulations producing the former, inasmuch as they do not give results that match the sounds which it was intended to imitate, have little or no associative power with these sounds, hence do not readily form into habits; on the other hand, articulations that produce successes or comparative successes will naturally tend to become habitual. It is easy to see that the indirect manner in which speech articulations are acquired necessitates an element of error, very slight, it may be, but error nevertheless. The habitual articulations that have established themselves in the speech of the child will yield auditory results that approximate so closely to those used in speech by its elders, that no need for correction will be felt. And yet it is inevitable that the sounds, at least some of the sounds, actually pronounced by the child will differ to a minute extent from the corresponding sounds pronounced by these elders. Inasmuch as every word is composed of a definite number of sounds and as, furthermore, the language makes use of only a limited number of sounds, it follows that corresponding to every sound of the language a definite articulation will have become habitual in the speech of the child; it follows immediately that the slight phonetic modifications which the child has introduced into the words it uses are consistent and regular. Thus if a vowel *a* has assumed a slightly different acoustic shade in one word, it will have assumed the same shade in all other cases involving the old *a*-vowel used by its elders, at any rate in all other cases in which the old *a*-vowel appears under parallel phonetic circumstances.

Here at the very outset we have illustrated in the individual the regularity of what have come to be called phonetic laws. The term "phonetic law" is justified in so far as a common tendency is to be discovered in a large number of individual sound changes. It is important, however, to understand that phonetic law is a purely historic concept, not one comparable to the laws of natural science. The

latter may be said to operate regardless of particular times and places, while a phonetic law is merely a generalized statement of a process that took place in a restricted area within a definite period of time. The real difficulty in the understanding of phonetic change in language lies not in the fact of change itself, nor in the regularity with which such change proceeds in all cases affected, but, above all, in the fact that phonetic changes are not merely individual, but social phenomena; in other words, that the speech of all the members of a community in a given time and place undergoes certain regular phonetic changes. Without here attempting to go into the details of this process of the transformation of an individual phonetic peculiarity into a social one, we will doubtless not be far wrong in assuming that uniformity is at first brought about by a process of unconscious imitation, mutual to some extent, among the younger speakers of a restricted locality, later, perhaps, by the half-conscious adoption of the new speech peculiarity by speakers of neighboring localities, until, finally, it has spread either over the entire area in which the language is spoken or over some definite portion of it. In the former case the historic continuity of the language as a unit is preserved, in the latter a dialectic peculiarity has asserted itself. In the course of time other phonetic peculiarities spread that serve to accentuate the dialectic division. However, the ranges of operation of the different phonetic laws need not be coterminous, so that a network of dialectic groupings may develop. At least some of the dialects will diverge phonetically more and more, until in the end forms of speech will have developed that deserve to be called distinct languages. It can not be denied that, particularly after a considerable degree of divergence has been attained, other than purely phonetic characteristics develop to accentuate a difference of dialect, but every linguistic student is aware of the fact that the most easily formulated and, on the whole, the most characteristic differences between dialects and between languages of the same genetic group are phonetic in character.

True, some one will say, changes of a purely phonetic character can be shown to be of importance in the history of language, but what of changes of a grammatical sort? Are they not of equal or even greater importance? Strange as it may seem at first blush, it can be demonstrated that many, perhaps most, changes in grammatical form are at last analysis due to the operation of phonetic laws. Inasmuch as these phonetic laws affect the phonetic form of grammatical elements as well as of other linguistic material, it follows that such elements may get to have a new bearing, as it were, brought about by their change in actual phonetic content; in certain cases, what was originally a single grammatical element may in this way come to have two distinct forms, in other cases two originally distinct grammatical ele-

ments may come to have the same phonetic appearance, so that if circumstances are favorable, the way is paved for confusion and readjustment. Briefly stated, phonetic change may and often does necessitate a readjustment of morphologic groupings. It will be well to give an example or two from the history of the English language. In another connection we have had occasion to briefly review the history of the words *foot* and *feet*. We saw that there was a time when these words had respectively the form *fōt* and *fōti*. The final *i*-vowel of the second word colored, by a process of assimilation which is generally referred to as "umlaut," the *ō* of the first syllable and made it *ō̄*, later unrounded to *ē*; the final *i*, after being dulled to an *e*, finally dropped off altogether. The form *fōti* thus step by step developed into the later *fēt*, which is the normal Anglo-Saxon form. Note the result. In *fōti* and other words of its type the plural is expressed by a distinct suffix *-i*, in *fēt*, as in modern English *feet*, and in words of corresponding form it is expressed by an internal change of vowel. Thus an entirely new grammatical feature in English, as also in quite parallel fashion in German, was brought about by a series of purely phonetic changes, in themselves of no grammatical significance whatever.

Such grammatical developments on the basis of phonetic changes have occurred with great frequency in the history of language. In the long run, not only may in this way old grammatical features be lost and new ones evolved, but the entire morphologic type of the language may undergo profound modification. A striking example is furnished again by the history of the English language. It is a well-known feature of English that absolutely the same word, phonetically speaking, may often, according to its syntactic employment, be construed as verb or as noun. Thus, we not only *love* and *kiss*, but we also give our *love* or a *kiss*, that is, the words *love* and *kiss* may be indifferently used to predicate or to denominate an activity. There are so many examples in English of the formal, though not syntactic, identity of noun stem and verb stem that it may well be said that the English language is on the way to become of a purely analytic or isolating type, more or less similar to that of Chinese. And yet the typical Indogermanic language of earlier times, as represented say by Latin or Greek, always makes a rigidly formal, not merely syntactic, distinction between these fundamental parts of speech. If we examine the history of this truly significant change of type in English, we shall find that it has been due at last analysis to the operation of merely phonetic laws. The original Anglo-Saxon form of the infinitive of the verb *kiss* was *cyssan*, while the Anglo-Saxon form of the noun *kiss* was *cyss*. The forms in early middle English times became dulled to *kissen* and *kiss*, respectively. Final unaccented *-n* later regularly dropped off, so that the infinitive of the verb

came to be *kisse*. In Chaucer's day the verb and the noun were still kept apart as *kisse* and *kiss*, respectively; later on, as a final unaccented *-e* regularly dropped off, *kisse* became *kiss*, so that there ceased to be any formal difference between the verb and noun. The history of the Anglo-Saxon verb *lufian* "to love" and noun *lufu* "love" has been quite parallel; the two finally became confused in a single form *luv*, modern English *love*. Once the pace has been set, so to speak, for an interchange in English between verbal and nominal use of the same word, the process, by the working of simple analogy, is made to apply also to cases where in origin we have to deal with only one part of speech; thus, we may not only have a sick *stomach*, but we may *stomach* an injury (noun becomes verb), and, conversely, we may not only *write up* a person, but he may get a *write up* (verb becomes noun). It has, I hope, become quite clear by this time how the trivial changes of pronunciation that are necessitated by the very process of speech acquirement may, in due course of time, profoundly change the fundamental characteristics of language. So also, if I may be pardoned the use of a simile, may the slow erosive action of water, continued through weary ages, profoundly transform the character of a landscape. If there is one point of historic method rather than another that the scientific study of language may teach other historical sciences, it is that changes of the greatest magnitude may often be traced to phenomena or processes of a minimal magnitude.

On the whole, phonetic change may be said to be a destructive or at best transforming force in the history of language. Reference has already been made to the influence of analogy, which may, on the contrary, be considered a preservative and creative force. In every language the existing morphological groups establish more or less definite paths of analogy to which all or practically all the lexical material is subjected; thus a recently acquired verb like *to telegraph* in English is handled in strict analogy to the great mass of old verbs with their varying forms. Such forms as *he walks* and *he laughs* set the precedent for *he telegraphs*, forms like *walking* and *laughing* for *telegraphing*. Without such clear-cut grooves of analogy, indeed, it would be impossible to learn to speak, a corollary of which is that there is a limit to the extent of grammatical irregularity in any language. When, for some reason or other, as by the disintegrating action of phonetic laws, too great irregularity manifests itself in the morphology of the language, the force of analogy may assert itself to establish comparative regularity—that is, forms which belong to ill-defined or sparsely represented morphologic groups may be replaced by equivalent forms that follow the analogy of better-defined or more numerous represented groups. In this way all the noun plurals of English, if we except a few survivals like *feet* and *oxen*, have come to be characterized by a

suffixed -s; the analogical power of the old -s plurals was strong enough to transform all other plurals, of which Anglo-Saxon possessed several distinct types. The great power exerted by analogy is seen in the persistence with which children, whose minds are naturally unbiased by tradition, use such forms as *foots* and *he swimmèd*. Let us not smile too condescendingly at the use of such forms; it may not be going too far to say that there is hardly a word, form, or sound in present-day English which was not at its first appearance looked upon as incorrect.

The disintegrating influence of phonetic change and the leveling influence of analogy are perhaps the two main forces that make for linguistic change. The various influences, however, that one language may exert upon another, generally summed up in the word "borrowing," are also apt to be of importance. As a rule such influence is limited to the taking over or borrowing of certain words of one language by another, the phonetic form of the foreign word almost always adapting itself to the phonetic system of the borrowing language. Besides this very obvious sort of influence, there are more subtle ways in which one language may influence another. It is a very noteworthy phenomenon that the languages of a continuous area, even if genetically unrelated and however much they may differ among themselves from the point of view of morphology, tend to have similar phonetic systems or, at any rate, tend to possess certain distinctive phonetic traits in common. It can not be accidental, for instance, that both the Slavic languages and some of the neighboring but absolutely unrelated Ural-Altaic languages (such as the Cheremiss of the Volga region) have in common a peculiar dull vowel, known in Russian as *yerí*, and also a set of palatalized or so-called "soft" consonants alongside a parallel set of unpalatalized or so-called "hard" consonants. Similarly, we find that Chinese and Siamese have in common with the unrelated Annamite and certain other languages of Farther India a system of musical accent. A third very striking example is afforded by a large number of American Indian linguistic stocks reaching along the Pacific coast from southern Alaska well into California and beyond, which have in common peculiar voiceless *l*-sounds and a set of so-called "fortis" consonants with cracked acoustic effect. It is obvious that in all these cases of comparatively uniform phonetic areas, embracing at the same time diverse linguistic stocks and types of morphology, we must be dealing with some sort of phonetic influence that one language may exert upon another. It may also be shown, though perhaps less frequently, that some of the morphologic traits of one language may be adopted by a neighboring, sometimes quite unrelated, language, or that certain fundamental grammatical features are spread among several unrelated linguistic stocks of a continuous area. One example of this sort of influence will serve for many. The French express the

numbers 70, 80, and 90, respectively, by terms meaning 60-10, 4 twenties, and 4 twenties 10; these numerals, to which there is no analogy in Latin, have been plausibly explained as survivals of a vigesimal method of counting—that is, counting by twenties—the numbers above 20, a method that would seem to have been borrowed from Gallic, a Celtic language, and which still survives in Gaelic and other modern Celtic languages. This example is the more striking as the actual lexical influence which Celtic has exerted upon French is surprisingly small. So much for the influence of borrowing on the history of a language.

We may turn now to take up the matter of the varieties of human speech. One method of classifying the languages of the world has been already referred to; it may be termed the genetic method, inasmuch as it employs as its criterion of classification the demonstrable relation of certain languages as divergent forms of some older form of speech. As we have already seen, the linguistic stocks which we thus get as our largest units of speech are too numerous to serve as the simplest possible reduction of the linguistic material to be classified. One naturally turns, therefore, to a psychological classification, one in which the classificatory criterion is the fundamental morphological type to which a particular language or stock is to be assigned. Such a classification of morphological types may proceed from different points of view, varying emphasis being laid on this or that feature of morphology. It is clear at the outset that we have to distinguish between what we may call the subject matter or content of morphology and the mere form pure and simple. Any grammatical system gives formal expression to certain modes or categories of thought, but the manner of expression of these categories or the formal method employed may vary greatly both for different categories and for different languages. Not infrequently the same logical category may be expressed by different formal methods in the same language. Thus, in English the negative idea is expressed by means of three distinct formal methods, exemplified by *untruthful*, with its use of a prefix *un-*, which can not occur as a freely movable word; *hopeless*, with its use of a suffix *-less*, which again can not occur as a freely movable word; and *not good*, in which the negative idea is expressed by an element (*not*) that has enough mobility to justify its being considered an independent word. We have here, then, three formal processes illustrated to which may be assigned the terms prefixing, suffixing, and juxtaposing in definite order. While the same logical category may be grammatically expressed by different formal methods, it is even more evident that the same general formal method may be utilized for many different categories of thought. Thus, in English the words *books* and *worked* use the same method of suffixing grammatical elements, the one to express the concept of plurality, the other that of past activity. The

words *feet* and *swam*, furthermore, respectively express the same two concepts by the use of an entirely distinct formal method, that of internal vowel change.

On the whole one finds that it is possible to distinguish between two groups of grammatically expressed logical categories. One group may be characterized as derivational; it embraces a range of concepts expressed by grammatical elements that serve to limit or modify the signification of the word subjected to grammatical treatment without seriously affecting its relation to other words in the sentence. Such merely derivational elements are, in English, prefixes like *un-*, suffixes like *-less*, agentive suffixes like *-er* in *baker*, and numerous others. The second group of logical concepts and corresponding grammatical elements may be characterized as relational; they not merely serve to give the word affected a new increment of meaning, as is the case with the first group, but also assign it a definite syntactic place in the sentence, defining as they do its relation to other words of the sentence. Such a relational grammatical element, in English, is the plural *-s* suffix; a word, for instance, like *books* differs from its corresponding singular *book* not merely in the idea of plurality conveyed by the suffix *-s*, but in that it assumes a different grammatical relation to other words in the sentence—a book *is*, but books *are*. Such relational elements are, furthermore, the case and gender suffixes of nouns and adjectives in Indogermanic languages; furthermore, the personal endings and tense suffixes of verbs. On the whole it may be said that derivational elements are of relatively more concrete signification than the relational ones and tend to become more thoroughly welded into a word unit with the basic word or stem to which they are attached or which they affect. This statement, however, is only approximately of general application and is subject to numerous qualifications. The greatest degree of concreteness of meaning conveyed by derivational elements is probably attained in many, though by no means all, American Indian languages, where ideas of largely material content are apt to be expressed by grammatical means. To this tendency the name of polysynthesis has been applied. Thus in Yana, an Indian language of northern California, such ideas as up a hill, across a creek, in the fire, to the east, from the south, immediately, in vain, and a host of others are expressed by means of grammatical suffixes appended to the verb stem; so also in Nootka, an Indian language of Vancouver Island, so highly special ideas as on the head, in the hand, on the rocks, on the surface of the water, and many others are similarly expressed as suffixes. It is important to note that, although the distinction between derivational and relational grammatical elements we have made is clearly reflected in some way or other in most languages, they differ a great deal as to what particular concepts are treated as respectively

derivational or relational. Such concepts as those of sex gender, number, and tense, which in Indogermanic are expressed as relational elements, are in other linguistic stocks hardly to be separated, as regards their grammatical treatment, from concepts treated in a clearly derivational manner. On the other hand, demonstrative ideas, which in most Indogermanic languages receive no relational syntactic treatment, may, as in the Kwakiutl language of British Columbia, serve an important relational function, analogous, say, to the Indogermanic use of gender; just as in Latin, for instance, such a sentence as "I saw the big house" is expressed by "I-saw house-masculine-objective big-masculine-objective," with a necessary double reference to the concepts of case relation and gender, so in Kwakiutl the sentence "I saw the house" would have to be expressed by some such sentence as "I-saw-the-objective-near-you house-visible-near-you," with an analogous necessary double reference to the demonstrative relations involved. If, now, it has been shown that no necessary correlation exists between particular logical concepts and the formal method of their grammatical rendering, and if, furthermore, there can not even be shown to be a hard and fast line in grammatical treatment between concepts of a derivational and concepts of a more definite relational character, what becomes of the logical category *per se* as a criterion of linguistic classification on the basis of form? Evidently it fails us. Of however great psychological interest it might be to map out the distribution in various linguistic stocks of logical concepts receiving formal treatment, it is clear that no satisfactory formal classification of linguistic types would result from such a mapping.

Having thus disposed of the subject matter of linguistic morphology as a classificatory criterion, there is left to us the form pure and simple. Here we are confronted first of all by a number of formal grammatical methods or processes. These, being less numerous than the logical categories which they express themselves, and, furthermore, being on the whole more easily defined and recognized, would seem to lend themselves more easily to classificatory purposes. The simplest grammatical process is the *juxtaposing of words in a definite order*, a method made use of to perhaps the greatest extent by Chinese, to a very large extent also by English; the possibilities of the process from the point of view of grammatical effectiveness may be illustrated by comparing such an English sentence as "The man killed the bear" with "The bear killed the man," the actual words and forms being identical in the two sentences, yet definite case relations being clearly expressed in both. A somewhat similar process, yet easily enough kept apart, is *compounding*; that is, the fusion of two words or independent stems into a firm word unit; the process is particularly well developed in English, as illustrated by words like *rail-*

road and *underestimate*, and indeed is found widely spread among the most diverse linguistic stocks. In some languages, as in the Sioux and Paiute of our own country, compounding of verb stems is frequent, as illustrated by such forms as *to eat-stand*; that is, *to eat while standing*; on the other hand, in not a few linguistic stocks, as the widespread Athabascan stock of North America and in the Semitic languages, compounding as a regular process is almost or entirely lacking. Perhaps the most commonly used formal method of all is *affixing*; that is, the appending of grammatical elements to a word or to the body or stem of a word; the two most common varieties of affixing are prefixing and suffixing, examples of which have been already given from English. Probably the majority of linguistic stocks make use of both prefixes and suffixes, though they differ greatly as to the relative importance to be attached to these two classes of elements. Thus, while both in Indogermanic and in the Bantu languages of Africa prefixes and suffixes are to be found, we must note that the greater part of the grammatical machinery of Indogermanic is carried on by its suffixes, while it is the prefixes that in Bantu take the lion's share of grammatical work. There are also not a few linguistic stocks in which suffixing as a process is greatly developed, while prefixing is entirely unknown; such are Ural-Altaic, Eskimo, and the Kwakiutl and Nootka languages of British Columbia. On the other hand, languages in which prefixes are used, but no suffixes, seem to be quite rare. A third variety of affixing, known as infixing, consists in inserting a grammatical element into the very body of a stem; though not nearly so widespread as either prefixing or suffixing, it is a well-attested linguistic device in Malayan, Siouan, and elsewhere. Still another widespread grammatical process is *reduplication*; that is, the repetition of the whole or, generally, only part of the stem of a word; in Indogermanic we are familiar with this process in the formation, for instance, of the Greek perfect, while in many American Indian languages, though in far from all, the process is used to denote repeated activity. Of a more subtle character than the grammatical processes briefly reviewed thus far is *internal vowel or consonant change*. The former of these has been already exemplified by the English words *feet* and *swam* as contrasted with *foot* and *swim*; it attains perhaps its greatest degree of development in the Semitic languages. The latter, internal consonant change, is on the whole a somewhat rare phenomenon, yet finds an illustration in English in at least one group of cases. Beside such nouns as *house*, *mouse*, and *teeth*, we have derived verbs such as *to house*, *mouse around*, and *teeth*; in other words a certain class of verbs is derived from corresponding nouns by the changing of the final voiceless consonants of the latter to the corresponding voiced consonants. In several non-Indogermanic languages, as in Takelma of southwestern Oregon and in Fulbe of the Soudan, such

grammatical consonant changes play a very important part. As the last formal grammatical process of importance may be mentioned *accent*, and here we have to distinguish between stress accent and musical or pitch accent. An excellent example of the grammatical use of stress accent is afforded in English by such pairs of words as *cónflict* and *conflict*, *óbject* and *objéct*, the verb being accented on the second syllable, the noun on the first. Musical accent is a far more prevalent phonetic characteristic than is perhaps generally supposed; it is by no means confined to Chinese and neighboring languages of eastern Asia, but is found just as well in many languages of Africa and, as has been recently discovered by Mr. J. P. Harrington and the writer, in a few North American Indian languages. As a process of definite grammatical significance, however, musical accent is not so widespread. It is found, to give but one example, in the earlier stages of Indogermanic, as exemplified, among others, by classical Greek and by Lithuanian.

Having thus briefly reviewed the various grammatical processes used by different languages, we may ask ourselves whether the mapping out of the distribution of these processes would be of more service to us in our quest of the main types of language than we have found the grammatical treatment of logical concepts to be. Here a difficulty presents itself. If each linguistic stock were characterized by the use of just one or almost entirely one formal process, it would not be difficult to classify all languages rather satisfactorily on the basis of form. But there are great differences in this respect. A minority of linguistic stocks content themselves with a consistent and thoroughgoing use of one process, as does Eskimo with its suffixing of grammatical elements, but by far the larger number make use of so many that their classification becomes difficult, not to say arbitrary. Thus in Greek alone every one of the processes named above, excepting consonant change, can be exemplified. Even if we limit ourselves to a consideration of grammatical processes employed to express the relational concepts, we shall find the same difficulty, for the same language not infrequently makes use of several distinct processes for concepts of this class.

On a closer study of linguistic morphology, however, we find that it is possible to look at the matter of form in language from a different, at the same time more generalized, point of view than from that of the formal processes employed themselves. This new point of view has regard to the inner coherence of the words produced by the operation of the various grammatical processes; in other words, to the relative degree of unity which the stem or unmodified word plus its various grammatical increments or modifications possesses, emphasis being particularly laid on the degree of unity which the grammatical processes bring about between the stem and the increments which

express relational concepts. On the basis of this formal criterion we may classify languages, at least for the purposes of this paper, into the three main types of linguistic morphology generally recognized. The first type is characterized by the use of words which allow of no grammatical modification whatever; in other words, the so-called *isolating* type. In a language of this type all relational concepts are expressed by means of the one simple device of juxtaposing words in a definite order, the words themselves remaining unchangeable units that, according to their position in the sentence, receive various relational values. The classical example of such a language is Chinese, an illustration from which will serve as an example of the isolating type of sentence. $w\bar{o}o^3$ (rising from deep tone) $p\bar{u}^2$ (rising from high) $p'\bar{a}^4$ (sinking from middle) $t'\bar{a}^1$ (high) may be literally translated "I not fear he," meaning "I do not fear him;" $w\bar{o}o^3$ "I" as subject comes first; $p'\bar{a}^4$ "fear" as predicate follows it; $p\bar{u}^2$ "not," inasmuch as it limits the range of meaning given by the predicate, must precede it, hence stands between the subject and predicate; finally $t'\bar{a}^1$ "he" as object follows the predicate. If we exchange the positions of $w\bar{o}o^3$ and $t'\bar{a}^1$ we change their syntactical bearing; $w\bar{o}o^3$ "I" becomes "me" as object, while $t'\bar{a}^1$, which in our first sentence was best translated as "him" now becomes "he" as subject, and the sentence now takes on the meaning of "he does not fear me."

In the second main type of language, generally known as the *agglutinative*, the words are not generally unanalyzable entities, as in Chinese, but consist of a stem or radical portion and one or more grammatical elements which partly modify its primary signification, partly define its relation to other words in the sentence. While these grammatical elements are in no sense independent words or capable of being understood apart from their proper use as subordinate parts of a whole, they have, as a rule, their definite signification and are used with quasi-mechanical regularity whenever it is considered grammatically necessary to express the corresponding logical concept; the result is that the word, though a unit, is a clearly segmented one comparable to a mosaic. An example taken from Turkish, a typical agglutinative language, will give some idea of the spirit of the type it represents. The English sentence "They were converted into the (true) faith with heart and soul" is rendered in Turkish *džan u gönül-den iman-a gel-ir-ler*,¹ literally translated, "Heart and soul-from belief-to come-ing-plural." The case-ending *-den* "from" is here appended only to *gönül* "soul" and not to *džan* "heart," though it applies equally to both; here we see quite clearly that a case-ending is not indissolubly connected with the noun to which it is appended, but has a considerable degree of mobility and corresponding transpa-

¹ The Turkish and Chinese examples are taken from F. N. Finck's "Die Haupttypen des Sprachbaus."

rency of meaning. The verb form *gel-ir-ler*, which may be roughly translated as "they come," is also instructive from our present point of view; the ending *-ler* or *-lar* is quite mechanically used to indicate the concept of plurality, whether in noun or verb, so that a verb form "they come," really "come-plural," is to some extent parallel to a noun form like "books," really "book-plural." Here we see clearly the mechanical regularity with which a logical concept and its corresponding grammatical element are associated.

In the third, the *inflective*, type of language, while a word may be analyzed into a radical portion and a number of subordinate grammatical elements, it is to be noted that the unity formed by the two is a very firm one, moreover that there is by no means a mechanical one-to-one correspondence between concept and grammatical element. An example from Latin, a typical inflective language, will illustrate the difference between the agglutinative and inflective types. In a sentence like *videō hominēs* "I see the men," it is true that the verb form *videō* may be analyzed into a radical portion *vide-* and a personal ending *-ō*, also that the noun form *hominēs* may be analyzed into a radical portion *homin-* and an ending *-ēs* which combines the concepts of plurality with objectivity; that is, a concept of number with one of case. But, and here comes the significant point, these words, when stripped of their endings, cease to have even a semblance of meaning, in other words, the endings are not merely agglutinated on to fully formed words, but form firm word-units with the stems to which they are attached; the absolute or rather subjective form *homō*, "man," is quite distinct from the stem *homin-* which we have obtained by analysis. Moreover, it should be noted that the ending *-ō* is not mechanically associated with the concept of subjectivity of the first person singular, as is evidenced by such forms as *vidī* "I saw" and *videam* "I may see"; in the ending *-ēs* of *hominēs* the lack of the mechanical association I have spoken of is even more pronounced, for not only are there in Latin many other noun endings which perform the same function, but the ending does not even express a single concept, but, as we have seen, a combined one.

The term *polysynthetic* is often employed to designate a fourth type of language represented chiefly in aboriginal America, but, as has been shown in another connection, it refers rather to the content of a morphologic system than to its form, and hence is not strictly parallel as a classificatory term to the three we have just examined. As a matter of fact, there are *polysynthetic* languages in America which are at the same time agglutinative, others which are at the same time inflective.

It should be carefully borne in mind that the terms isolating, agglutinative, and inflective make no necessary implications as to the logical concepts the language makes use of in its grammatical system, nor is

it possible definitely to associate these three types with particular formal processes. It is clear, however, that on the whole languages which make use of word order only for grammatical purposes are isolating in type, further, that languages that make a liberal grammatical use of internal vowel or consonant change may be suspected of being inflective. It was quite customary formerly to look upon the three main types of morphology as steps in a process of historical development, the isolating type representing the most primitive form of speech at which it was possible to arrive, the agglutinative coming next in order as a type evolved from the isolating, and the inflective as the latest and so-called highest type of all. Further study, however, has shown that there is little to support this theory of evolution of types. The Chinese language, for instance, so far from being typical of a primitive stage, as used to be asserted, has been quite conclusively proven by internal and comparative evidence to be the resultant of a long process of simplification from an agglutinative type of language. English itself, in its historical affiliations an inflective language, has ceased to be a clear example of the inflective type and may perhaps be said to be an isolating language in the making. Nor should we be too hasty in attaching values to the various types and, as is too often done even to-day, look with contempt on the isolating, condescendingly tolerate the agglutinative, and vaunt the superiority of the inflective type. A well-developed agglutinative language may display a more logical system than the typically inflective language. And, as for myself, I should not find it ridiculous or even paradoxical if one asserted that the most perfect linguistic form, at least from the point of view of logic, had been attained by Chinese, for here we have a language that, with the simplest possible means at its disposal, can express the most technical or philosophical ideas with absolute lack of ambiguity and with admirable conciseness and directness.



ANCIENT GREECE AND ITS SLAVE POPULATION.¹

BY S. ZABOROWSKI,

Professor of Ethnography, School of Anthropology, Paris.

The manipulation and the preparation of ordinary articles and of food products were at first carried on in Grecian homes exclusively by members of the family, and later the service of slaves was utilized for such work. Domestic industry was more general up to our time, and it decreased and gave way only because of the enormous improvements of manufacture in shops and on a large scale, and the increase in facilities of communication and for transport.

In ancient Greece domestic industry was the common custom. The poorest did not hesitate to have at least one or two slaves for grinding their grain, for making their bread, as well as for reaping and for weaving garments.

Artisans were at first forced to practice several trades at once to gain a living. In small cities the same class of workmen made beds, doors, plows, tables, and even built houses.

The division of work depended on commerce and its demands. And during the great epoch in Greece one even saw the cooks, just as they do in our day to the detriment of the middle class, acquiring an individual reputation each for a specialty—one for the frying of fish, another for lentil bread, etc. In the potteries there were special workmen for vases; others for making only lamps, and others for statuettes. This was a step toward trade and manufactures, properly so called.

Many cities specialized in certain products, due to favorable local conditions, to the possession of trade secrets. Thus commerce demanded from Megara only "exomides" or the coarse clothes for slaves which all needed, and all the inhabitants of Megara were supported by their manufacture. Likewise, gauze robes, "chlamides," were the specialty at Miletis and perfumes and pottery at Athens. The skill of the bronze workers of Corinth was wonderful.

But it would be incorrect to assume that the citizens of these places, either as a whole or in great part, were themselves actually

¹ Translated by permission from *Revue Anthropologique*, Paris, vol. 21, 1911, pp. 245-258.

engaged in these various arts and manufactures and executed the work. In Sparta citizens were rigorously forbidden to work at trades, and this aristocratic prejudice has always existed to a greater or less degree throughout Greece. Herodotus (II, 167) expressly says:

Among the barbarians those who learn the mechanical arts and even their children are regarded as the lowest class of citizens. On the other hand, they esteem as the most noble those who engage in no trade whatever and especially those who have devoted themselves to the profession of arms. All Greeks, and particularly the Lacedemonians, have been schooled in these principles.

The factories where free men chiefly were employed were all small, with 10 workmen at the most. An inscription at Athens giving a list of workmen shows that in the fifth century, the grand century, the free workmen were still in the majority, for this list includes 24 Athenians, 40 métèques (foreigners from other Grecian cities), and only 17 slaves. The majority of these free men were for the most part foreigners, without rights of citizenship, whom misfortune had driven from their homes. In a workshop at the sanctuary of Eleusis there were 39 métèques, 36 Athenians, and 12 barbarians or wandering workmen, who came to offer their services, but not slaves. The period of the fifth century was the most auspicious and the most brilliant in ancient Greece. Agriculture was then still predominant in Attica.

But that condition was completely overturned. The philosophers themselves turned aside the Greeks from manual labor. Their teaching as well as their example tended to create an intellectual élite, an aristocracy of mind, much above the mass. But they had overreached their mark in inspiring a contempt for work. To believe one's self too much above others destroys the equilibrium.

Socrates himself did nothing. He did not even write his moral teachings. While preaching a contempt for sordid gain, he did not study the subject close enough to understand the need of being busy, everything censuring idleness.

In the professions that tend toward wealth Plato could see only selfishness, baseness of spirit, the degrading of the finer sensibilities. In such appreciation there is a moral element of a delicate and elevating nature. But Plato, like Aristotle, came to see in commerce and industry two evils of society. His moral ideal was joined with that ideal of simplicity of primitive epochs when the worst brigandage, viewed from afar, was colored with heroic virtue. "If," said he, "astronomers, very modest magistrates charged with the policing of streets and dwellings, with cleanliness and good order, should perceive anyone of their number neglecting the study of virtue to practice a trade, they should overwhelm him with reproaches and

contempt." Spartomania, a love for military training in idleness, should be vigorously condemned.

Xenophon commended those cities which forbade every citizen from practicing the mechanical profession; for, thought he, the soul is thus degraded, the body is weakened, and workmen are poorly prepared by the sedentary life for the exigencies of military struggles.

At Thebes the practice of a trade was incompatible with the exercise of a magistracy.

According to Aristotle himself, mechanical employments were unworthy of a free man. For one to work with his hands for himself, well and good, but to work for others, that was to perform the labor of a mercenary and a slave. In order to be a citizen one should be free from labors necessary for the maintenance of life. The spirit of man, in order to unfold itself, must have freedom, and freedom is leisure. Aristotle even believed that all workmen were foreigners or slaves.

Plutarch professed contempt for all manual labor. "While taking pleasure in the work," says he, "we despise the workman, though that workman be a talented artist, such as Phidias."

Aristophanes, in his turn, had only reproachful peals of laughter for those who worked with their hands in commerce or industry—for Lysicles, a sheep dealer; for Hyperboles, a maker of lamps; for the great Euripides himself, "the son of a fruit trader."

The law wisely prohibited casting a stigma on a citizen of Athens for a trade he had practiced at the Agora, but public opinion went further and they struck a man from the list of citizens simply because his mother sold ribbon at a market. A law was even proposed for reducing all artisans to servitude.

The inevitable consequence and force of such prejudices would be to bring about the gradual fall of a free workman, the despising and abandonment of mechanical arts, and placing idleness pure and simple above everything. It is truly painful to know that the ceramic workmen of Athens, who originated so much and advanced so far for all time the artistic reputation of their city, were utterly despised. They have not left a trace in history. Their studios were not numerous and their quarters became those of classes of the lower ranks. This was not perhaps what philosophers, lovers of intellectual culture, would wish in emancipation from despised material cares, those who taught nobility of life in advising estrangement from the base tasks and sordid gains. But, thinking only of exalting themselves, counting only a small élite as capable of being consecrated, like themselves, to science and virtue, they were in the eyes of all the nation devoted to a fatal ideal, already well spent, which was to live by doing nothing, from the work of the slaves.

The downfall began about their time, from the fourth century, since in their social improvidence they did not dream of assuring the duration of the flame which they brightened but for a moment.

Their principal mistake, shared by all the idle classes, hastened in turn by the gradual increase of intelligence among all those who were forced to do something, was to believe that the faculties would remain intact, and the power to think and to do would keep awake notwithstanding habitual inaction and without a constant exercise of the brain. They have believed that one could conserve the taste for beautiful things, though never realizing or even attempting great deeds.

And the power of Greece, formed by the struggles and through the expeditions of conquest and commerce pursued during the ninth and eighth centuries on all sides, even as far as the Black Sea, in France, in Africa, in Spain, with wonderful boldness, was weakened at the end of this period into an egotistic selfishness from the riches which were accumulated. Greece deteriorated, and was then debased.

In his life of idleness the Greek developed his oratorical faculties. He must speak at the tribunal, in the gymnasium, no matter how unprepared, or whether there was anyone to listen to him. Ready speech and blundering boastfulness became after awhile the characteristics of the race.¹

No one then wished to work longer. And already in the fourth century the philosopher Hippias was a subject of wonder because he made his own clothes and shoes. All, however, desired more than ever to enjoy every comfort and to sport in luxury. Then the increasing of slaves rapidly became tremendous. This was the visible reason for the decay and decline of ancient Greece. They had slaves in all conditions of life and in all degrees of the field of labor. And what slaves!

One saw in ancient Greece some things of the kind observed in central Africa in our day. Abductions of children were frequent, and public ceremonies themselves, attracting the crowds, were ordinary occasions for it. The Greek law, besides, authorized parents to abandon their children on the highway. Those who received them raised them in slavery. At Thebes the father who wished to be rid of his child for profit took it to the magistrates, who sold it at auction. At Athens the father could sell his daughter only when guilty of misconduct. Solon had slavery abolished for debts, but the custom nevertheless was generally in force. And even at Athens, at the revision of lists of citizens, whoever was fraudulently inscribed was sold. Plato, who wanted all manual work executed under constraint by the slave, was himself embarked by Denys, of Syracuse, on a Lacle-

¹ Francotte. *L'industrie dans la Grèce ancienne*. Two volumes. 8°. Brussels, 1900.

demonian vessel, transported to Ægina, perhaps his native land, and put on sale as a slave.

It mattered not who might demand a free man as a slave; such a one was without defense unless a citizen assumed for him the cost of trial. The prisoners of war made by the Greeks could be freed by exchange or ransom. And it came to pass that with progress in morals and wealth the custom was established of paying the ransoms rather than to allow citizens, parents, compatriots to fall into slavery. In 406 B. C. the Spartans and their allies, having conquered Methymna, were on the point of selling all the inhabitants; but their chief refused to reduce Greeks into slavery. A kind of patriotism between races of the same tongue and the same culture existed then. It was, however, only the end of the fifth century.

Afterwards they wished no longer to have slaves when considerations of such nature would oblige good treatment. The penal code provided strenuous ordinances as to the service of slaves to their owners. Their only recourse against the cruelty of their masters was flight, and flights of slaves, partly for that reason, were common. Some masters at first treated their slaves well, as "children" of their families; these were the ones in domestic service. They no longer had names. The killing of one of them was considered as unintentional homicide. They could own nothing, and the money they were permitted to have most often returned to the master, who thus allowed them means for ransom.

Some family relations were permitted between slaves, but they were not recognized by the law. The master who cohabited with a slave contracted no obligation whatever, the union being ignored by the law. If he had a child by a slave, it was regarded as without a father, coming from the mother only, and was the property of the master, its father in this particular case, the same as any other child born of slaves. But we find that many of these children were incorporated into the family by emancipation and adoption. We have here a very grave condition, for we know that these sexual relations of masters with their slaves was common. Philip of Macedonia gave to Philocrates numerous wives from Olynthus for the sake of debaucheries in the year 346. On account of this present, he was considered as a traitor and was obliged to exile himself.

Deprived of every right, a mere thing or beast of burden, subject to the will of the master, the slave could be forced to labor without mercy under the pretense of the mercantile plea and the need of development of industrialism. The Greeks were skillful in reducing expenditure in behalf of their slaves in extraordinary proportions. Under existing conditions slave labor returned to employers such results and profits as they could never secure from free artisans.

Citizen workmen could not resist such a condition, and besides, the allurements of gain led all Hellenic society to resort more and more to slave labor.

The municipalities themselves engaged contractors to go abroad in search of cargoes of slaves, paying all the expenses. Xenophon, seeking a way to enrich Athens without the risks of war, insisted on working the silver mines, and for that labor proposed to buy 10,000 slaves, the purchase of which he said would be quickly compensated for by the cheap cost of their labor.

An estimate has been made, and we know that Xenophon was entirely right. A free laborer for 360 days' work cost 540 drachmas (\$75). A slave whose maintenance cost 2 or 3 oboles (5 to 8 cents) per day would accomplish the same amount of labor for 180 drachmas (\$26). But there remains the purchase price of 300 drachmas. The interest of that amount at 12 per cent, the rate at that period, represented 36 drachmas (\$5) a year. The slave could no doubt work 10 years or more. By redeeming his purchase price in five years one would be guaranteed against all risks of sickness for a number of even feeble slaves. This cost for quick redemption would represent only 60 drachmas per year. And incorporating it in the annual revenue from the work of a slave, all this, interest on purchase price included, would be only 276 drachmas. Take the round sum of 300 drachmas, and we have the advantage over the cost of a free laborer of 240 drachmas (\$33.34) the first year. This shows that one would be reimbursed for the purchase price of a slave the first year within 44 francs (\$8.50) and entirely so in 15 months.

Some contractors, having need of manual labor for only a time, hired slaves at an obole (about $2\frac{1}{2}$ cents) per day, instead of engaging free men. Even if they paid the same price as for a free man there was still an advantage in employing slaves, because they could compel them to do what they wished. Therefore the purchase of slaves for hiring out was a very profitable undertaking. Everyone then wanted to have slaves. A modest artisan able to buy some tools for the use of a slave had a workshop and became a master in a modest way. The workmen at the mint in Athens were public slaves. It resulted that at Athens the class that we would call common people made their living from the work of slaves. Personal wealth, what has since been called capital, was then acquired, as I have said, through slave labor, for the first time. The idea of capital was not thought of before Aristotle. We know the condition of many individual fortunes, especially through the pleadings of lawyers. We thus learn that a certain Phainippos derived from the sale of his wine, barley, and timber the relatively large sum of 3,600 drachmas (\$500). With 1,000 slaves Niccas, working the silver

mines of Laurium, made 100 talents (\$115,000), an enormous return, a colossal fortune for that period.

Mining concessions were generally much parceled out, and there was little mining done in Greece, some silver at Siphnus; gold at Cyprus, at Thaos, on the coast of Thrace, in Asia, in Colchis, in Lydia; and copper in Euboea, in Argos, at Sicyon, and especially at Cyprus. All the miners were slaves.

In the inheritance of a certain Conon there was a factory with some slaves making ordinary textile fabrics and a shop with some druggist slaves.

The incomes of citizens were thus dependent on the work of slave weavers, cutlers, pharmacists, etc. There is mentioned a workshop with 120 slave forgemen or smiths.

The shoemakers worked by a certain Timarque yielded him each day 2 oboles (about 5 cents) per head, or 120 drachmas (\$16.50) per year. The father of Demosthenes had a fortune of 14 talents (\$16,000), which was essentially personal property, as follows: Two shops, one of 32 cutlers, yielding 30 mines, or 3,000 drachmas (\$420), the other of bed makers, yielding 22 mines, or 2,200 drachmas (\$305); quantities of raw materials, such as ivory, iron, and copper, yielding 150 mines, or 15,000 drachmas; a house, 30 mines, or 3,000 drachmas; some furniture, 100 mines, or 8,000 drachmas; a trust of a talent, yielding 700 drachmas (\$97); a maritime trust of 7,000 drachmas; a bank deposit of 2,400 drachmas, and various loans yielding 6,000 drachmas. Besides the above and exclusive of some houses and some important unsettled accounts Demosthenes also inherited from his father 15,366 francs (\$2,965) in income. This was at 18 per cent.

One is a little surprised at such amounts. And what surprises more is to see such eminent capitalists with the same versatility as those of our own day and engaged in such varied affairs. Some fortunes were composed only of credits. Whence it follows that commercial credit was extensive and that there were banks for making loans.

Maritime commercial enterprises were, in fact, undertaken on advances of funds by outfitters and silent partners, advances which, in proportion to the risks incurred, gave in every case some assurance of very great profit. The city of Athens made loans to some expeditions charged to search its corn in Egypt, in Sicily, and the Pontus, and skins, wool, and salt provisions in the Pontus, whither, on the other hand, Athens exported on one occasion as many as 3,000 amphoras of wine.

We find also that the citizens in these profitable operations played only a secondary rôle, since their ideal was to do nothing themselves. Their number at once diminished and in a manner that became important.

The cities themselves had never been very populous. Athens and Syracuse reached and no doubt exceeded 100,000 inhabitants; Corinth, 70,000; Sidon and Tyre, in the fourth century, 40,000; and city-states numbering 20,000 citizens were rare. Athens had reached 30,000 citizens at the middle of the fifth century. In 309 B. C., less than a century and a half later, there were not more than 21,000. Then the number fell to scarcely 14,000 or 15,000, or only one-half that of the prosperous period of the fifth century.

In the territory of Agrigentum, in Sicily, Diodorus states that in 406 B. C. there were only 20,000 citizens out of 200,000 inhabitants. Pray, in view of this weakness, this small contingent of real Greeks, the only legitimate descendants of the Hellenes, what was the number of slaves?

As early as the fifth century, according to the most moderate estimates, the slaves represented two-fifths of the population of all Greece (1,000,000 against 1,600,000). In the interior regions, however, where there were no manufactures, where commerce scarcely reached, and particularly in the poor agricultural regions, they did not need and they could not purchase many slaves. Omitting these somewhat isolated places without influence, the number of slaves in Greece much exceeded the free men.

At Corcyra, where there were 30,000 free men, they had 40,000 slaves. According to the census of 309 B. C. (Demetrius of Phalerum), fixing the number of citizens of Athens at 21,000, there were then about 400,000 slaves in Attica. Aristotle (384-322 B. C.) estimated that a little before that time there were 470,000 slaves in Ægina, and Timæus reckoned 460,000 in Corinth. Without doubt in these exaggerated figures should be included *métèques*, the foreigners already mentioned by Solon and by Pericles.

Among the merchants and artisans there were 42 or 50 *métèques* to 3 or 4 citizens. These figures indicate in every respect a serious condition. At the battle of Sybota, Corinth took 1,050 prisoners, among whom there were only 250 free men, almost a fourth. Here is an accurate figure, and much more indicative, that the profession of arms was most honorable in principle and was reserved for free men by reason of its very object. Other estimates have been made, but they are not as reliable as those furnished by the Greeks themselves. Their results reveal, as well during the fifth century, when civilization blazed at its height, as also during the century of Aristotle (384-322) and of Alexander the Great (356-323), a strange condition of affairs which would explain the egotism of the patriotic efforts of Demosthenes (385-322), who was himself, moreover, a very rich partisan of slaves. At this same epoch of Alexander the Great (the second half of the fourth century) the number of citizens in Attica

represented only two-fifths of its inhabitants, while in the fifth century, as we have said, they were more than three-fifths. The citizens were already overwhelmed in the midst of a mixed population, in great majority foreign-born. If any great effort for liberty had been made, it would have been of a weak and enfeebled character in that indifferent mass. But it need not have been great, for the citizens could not oppose it in person, weakened as they were through the love of idle pleasures, taught to do almost nothing by the masters of their consciences, the philosophers.

The decrees of the emancipation and burial inscriptions give a good record of the enormous proportion of foreigners among the slaves. Among these decrees there are a few Greek slaves, only 24 out of a list of 124. These, moreover, were Greeks whom, for many reasons, the masters wished to make free the first. (Guiraud, p. 104.)

On that list of 124 manumissions there were 22 Syrians, 21 Thracians, 8 Galatians, 6 Italians, 4 Armenians, 4 Sarmatians, 4 Illyrians, 3 Cappadocians, 2 Phrygians, 2 Lydians, 2 Mysians, 2 Pontians, 2 Phenicians, 2 Jews, 2 Egyptians, 2 Arabs, 1 Paphlagonian, 1 Bithryian, 1 Cyprian, and 1 Bastarnian. Just one Bastarnian! coming from eastern Carpathus. It is difficult to imagine a mixture more variegated with individuals of all Provinces.

Ethiopia, like Illyria and Italy, furnished slaves to Greece. Among these there were many Thracians, Lydians, Phrygians, Carians, Syrians, some Scythians, Getæ, and Colchians.

An Attic inscription of 415 B. C. gives us a fair idea of the minimum price at which they acquired all these barbarians, even in the fifth century. A Carian was sold for 115 drachmas (\$15); a Syrian, 301 drachmas (\$42); three Thracian women from 135 to 222 drachmas (\$18.75 to \$31). You could buy a slave, under age, for less than that, 153 or 180 drachmas (\$21 to \$29). A slave that knew a trade sold at a much higher price, an ordinary currier being valued at 10 mines or from \$135 to \$155.

All these peoples of such diverse origin became incorporated into the nation through emancipation. The masters had every interest in encouraging the slave to seek his freedom; this was a stimulant. The employer who rented a slave made himself a participant in the earnings to his own great profit. All money given to the slave produced to the master double the amount. When by labor and economy the slave saved a sum of money, the master would regard with double contentment the formation of that small saving, for it was to him, in fact, that it would some day return. After having already profited on his own account from a regular and productive employment, he would shatter to "his profit the money box of the slave in selling him his freedom." (Francotte, II, p. 74.)

We know somewhat concerning redemption prices. Out of 227 redemptions, for 162 the price ranged between 300 and 500 drachmas (\$41 to \$69); 5 reached 1,000 drachmas (\$139); 2 were 1,300; 1 was 1,800; 2 were 2,000 drachmas (\$278); 312 ransoms for women cost from 300 to 500 drachmas. These prices are much higher than the cost of original purchase.

This pecuniary profit was not the only one, for the master also imposed life service in return for freedom, the surrender of one or more of his children, or he was even required to learn a trade to carry on for his former master's account. When the master freed a man to practice a profession, the former had the advantage in not being liable for the engagements of his freedom who might himself lose in the ruin of others, without detriment to the interests of his former master. When the savings of a slave were not great enough, the master could sell him under the condition that he should be free, but would serve his new master during his life.

This was not always bad for the freedman to whom liberty was thus guaranteed. Some masters would give up their slaves to a god, in order that this god might become surety for the exercise of his freedom.

The manumissions gathered at Delphi lead to the belief that the women (473 against 277 men) benefited much oftener by the generosity of their masters. This is certain evidence, which we might pass by, that many slaves were raised to the rank of concubines or even wives. The slave women, especially, were only things in the hands of their masters.

We find some manumissions of sons and daughters of slaves, children, where their masters, in freeing them, became their legal guardian. (Guiraud, p. 108.) They show clearly by this that the children were related to them. There were some who adopted the children of their slaves. These were natural children. Regularly then, through the ordinary act of manumission, and irregularly, also, through those relations which were not acknowledged, like those between slaves and Greek women, all the surrounding barbarian nations mingled their blood with the blood of the Grecian people. There were some cases where slaves attained to the rank of citizens. A slave informer might become a citizen. And some cities, after certain depredations, were restocked with men and reestablished their finances by conferring citizenship on all the slaves on agreement to pay a certain sum. And this point of view, especially the regular incorporation of foreigners in the nation, is a condition of the slaves that I can not pass by, though it is scarcely proper to speak of it, except with discretion.

The Greeks bought slaves for domestic service (the richest had for their lesser needs, up to 50), for work in the mines, in building opera-

tions, and in workshops, where they practiced all trades, to hire out for land owners, farmers, and contractors, and they also purchased them in order to deliver them into prostitution. It is known that the State itself established houses of ill fame partly to check certain vices. Solon had charge of these institutions and they were administered at the expense of the State. All the women in these houses were alien-purchased slaves. The Grecian woman who through repeated downfalls entered those places thereby renounced every social and family tie. All these women were in fact given up to public service. They could not leave the district without permission of the archons and by giving guarantees for their return. Their houses increased to such a degree in the streets of Piree that, so to speak, they were at every step. The patrons paid only a very moderate uniform price, at the lowest, 1 obole. Debtors were there sheltered from their creditors, and a father had no right to go there to surprise his son. People of all classes visited these houses. They furnished to the State a considerable revenue for the protection afforded them. This was known to speculators, who profited thereby.

One of these public women of the lowest rank was the mistress of the King of Egypt, Ptolomy Philadelphus. Although they might be cantoned in dwellings classed as public establishments, and though it was forbidden them to pass a single night in the city proper, yet they were in contact with everyone and had a chance each day of making a profitable friendship. The class of independent prostitutes, above them, was fed from their ranks, for it was made up chiefly of those who had been emancipated. There were some Greeks among them; but those who frequented the streets of Piree were nearly all aliens. Evidently the greater number of these women remained at that level and practiced their calling to the end in these particularly degrading conditions. It is, however, certain that the prettier ones and those most favored were raised in time to the demi-monde and that the courtesans were former independent prostitutes who had become the fashion.

The temple of Corinth drew a large revenue from these courtesans, priestesses of Venus, who were established there, and these were everywhere very highly favored and mingled with all classes.

The courtesans counted in their ranks some very intelligent women, some of whom were celebrated and are so still, for they had been listening counselors, influencers of powerful statesmen. One historian, Aristophanes of Byzance, estimated that there were 135 of these courtesans whose sayings and achievements are worthy of posterity.

While Grecian wives stayed at home, absorbed in their household and motherly duties, some of these public courtesans participated in outside affairs, taking part even in religious ceremonies, were versed in literature and philosophy, and were not strangers to affairs of

State. There were some, it has been said, who, skilled in the art of pleasing, held the salon of the Greeks.

The greatest statesman of Athens, Pericles (died in 429), who belongs to the fifth century, left his legal wife for one of these famous women, Aspasia; and this woman, with whom Socrates associated, to the knowledge and in sight of all Greece, had an influence so great in the affairs of State and was so highly educated that to her was attributed the composition of many of the orations of Pericles. She was a Milesian woman, of which ancient country she had been a princess. She bore a son to Pericles. This son, of the same name as himself, received the rights of a legitimate child on the demand of his father, and, notwithstanding the prescriptions of the law, became a recognized citizen of Athens. Such examples in such high places and so well known everywhere assuredly found many imitators.

In correlation with these economic conditions and these customs, the morale of the family was lowered and its number decreased. Voluntary restriction and lack of enthusiasm prevailed. The Greeks, enriched by slave labor, purchasing men and women abroad, renounced the raising of children.

In these events, so old, and the circumstances which accompanied and followed them, one could readily find a standard for close comparison with social phenomena of our day. Useful to know, these facts are always beneficial to recall.

ORIGIN AND EVOLUTION OF THE BLOND EUROPEANS.

By DR. ADOLPHE BLOCH.

In continuation of my researches on the filiation of the human races, there is here presented a discussion of the origin and evolution of the blond Europeans, which include (1) the first blond races, known in history as Celto-Gallic-Galatians, Cimbrians, Germans, etc; (2) the blond Finns and blond Lapps; (3) the blonds sporadically met with in all parts of Europe.

THE ARYAN HYPOTHESIS.

As the first blonds are regarded by certain authors as the genuine Aryans, we have to consider the origin of the Aryans, although the term is of little importance in designating these blonds, for what we wish to know most is what tie binds the different races among themselves, and what is the physiologic process through which they are derived one from the other.

The Aryan hypothesis, according to which the first ancestors of the Indo-Aryans, Persians, Greeks, Romans, Celts, etc., came from one and the same point in central Asia, now has no adherents, but in accord with the works of Pœsche (1878), Penka (1893), Schrader (1883), Wilser (1899), Kossinna (1902), and Michelis (1903) the theory of European origin has been generally adopted. We recall that as early as 1839 and succeeding years the Belgian geologist and anthropologist, d'Omalus d'Halloy, opposed the Asiatic theory of the European blonds (*Notes à l'Académie de Belgique*) and that it was the subject of two communications to our society in 1864 and 1865. Likewise the English philologist, Latham, was opposed to the Asiatic origin of the blonds, for he placed their cradle in what is now a submerged plain in Scandinavia (*Eléments de philologie comparée*, London, 1861).

As one of the early advocates of European origin there must also be mentioned the German Cuno, who maintained that the primitive Aryans, instead of being a small clan, constituted a numerous people

¹ Translated, by permission, from *Origine et Evolution des Blonds Européens*. Par M. le Dr. Adolphe Bloch. *Bulletins et Mémoires de la Société d'Anthropologie de Paris*. 6th ser., vol. 2, Nos. 1 and 2. Paris, 1911, pp. 55-79.

spread over a vast territory, the great plain of northern Europe, extending over northern Germany and the north of France, between the Ural Mountains and the Atlantic Ocean.¹

Finally, we must not forget here to recall the name of Madame Cl. Royer, who likewise asserted, in 1872, that the blond Europeans did not come from Asia. (Congrès d'Anthropologie et d'Archéologie préhistorique de Bruxelles, 1872, and various communications to the Société d'Anthropologie.)

Most of the writers since Cuno have assigned a very limited territory for the origin of the Aryans. Thus Pœsche, who relies exclusively on the influence of environment to account for the light color of the first blond Europeans, places their cradle "in the heart of European Russia, in the marshy districts of Rokitno, washed by the Pripet, the Berezina, and the Dnieper Rivers, where nature is tinted with albinism, where the people are blond, where the animals are robed in white, where the leaves and the bark of the trees are faded, where reigns that terrible disease of the hair, Polish plica."²

But although climatic conditions may modify the organism, yet it can not be admitted that the blonds are a species of albinos, with whom Pœsche seems to compare them; on the contrary, albinism is an anomaly which is not at all due to the influence of the climate.

Schrader assumes south Russia as the cradle of the Aryans; Penka and Wilser say it was Scandinavia; Kossinna claims that it is the western inclosure of the Baltic, Scandinavia in the south, Denmark and Germany in the northeast, as far as megaliths or ceramics are found; while for Michelis it is a region inclosed between the Danube on the southwest, the Carpathian Mountains on the north, and the Dnieper on the east. But all these territories thus outlined, aside from those of Cuno and Kossinna, are much too small. For it must have required an immense territory to bring forth the numerous blond peoples which followed one upon the other in Europe, in prehistoric as well as in historic times. On the other hand, none of these investigators indicate the stem from which the blond Europeans sprung, and it is just that subject which we propose here to investigate on the exclusive basis of anthropology.

THE BLONDS IN HISTORY.

The first blonds of history are the Celts; and the first historian to use the name *Κελτος* (Keltos) was Herodotus, about 440 B. C.; though the word Celtic, *Κελτική* (Keltike), for designating the country, was already employed by Hecateus (of Milet), about 500 B. C.

¹ Cuno, *Forschungen im Gebiete der Alten Völkerkunde*. Berlin, 1871.

² Pœsche. *Die Arier, ein Beitrag zur historischen Anthropologie*, Jena, 1878. The theory of this author has been already discussed in 1884 by Ujfalvy in a communication to the society, entitled "Les opinions récemment émises en Allemagne sur le berceau des Aryans."

Herodotus does not mention the physical appearance of the Celts, but he describes a people, in the north of the Black Sea and beyond it in Scythia, who painted themselves red and green, which he calls Budini and which he distinguishes from the Scythian laborers and others. "They were," he says, "a large and numerous people." (IV, 21 and 108.) This proves that there then existed in Russia a really red or blond race. But who were these reds? It could not have been the Celts, for they dwelt farther west; nor were they the Finns; but they were an autochthonous (indigenous) race of Russia as we know from the skulls found in the same region.

The name Celt is also employed by Aristotle (384-322 B. C.), who knew that there were Celts in Spain, that Celts had captured Rome, etc., but he also makes the important statement that the ass did not exist in Scythia nor in the Celtic land because that animal could not well withstand the cold. (Hist. Anim., Book VIII, Chapter XXIII § 7).

There is no doubt that the question here concerns the primitive Celtic country, which adjoined Scythia, at the period when the Celts, possessors of amber, were a river-shore people of the Baltic.

Moreover, all the peoples of the north, says Strabo (VI, 2), were included by the ancient Greek historians under the name of Celts or Celto-Scythians. But the oldest name which the Greeks gave the Celts was that of Hyperboreans. It is thus seen that by the name Celts were meant people of the north, and consequently they could not have been an aboriginal race of Gaul, as even some modern writers still assume.

But where did the Hyperboreans live? "I have no hesitation," says Prof. Jullian, "in recognizing in the Hyperboreans of Herodotus (IV, 33) the Esths, the Aesti of Samland (Gulf of Danzig), the country of amber (Tacitus, Germania, 45), and in these last the remnants of a pre-Germanic agricultural and trading people."¹

Let us add, moreover, that though the north of Europe was inaccessible to the ancients because of the immense expanse of the Rhipaian and Hercynian Mountains, it was nevertheless explored by sea in the fourth century B. C., by Pytheas who skirted Europe from Gades to the mouth of the Elbe and perhaps even as far as the Tanais (Don). It was there that he fixed the division of the Celtic land from Scythia.

The Celts were called Galatians by the Greeks, whereas the Romans named them Gauls (Galli) upon their arrival in the valley of the Po in the sixth century B. C.

The three names, Celts, Galatians, and Gauls, are, then, synonymous, pertaining to one and the same race, whose characteristics,

¹ Jullian. *Histoire de la Gaule*. Three volumes, Paris, 1909. The primitive history of the Celts should be read in this remarkable work. See also on this subject a letter of the author to the *Revue de l'Ecole d'Anthropologie*, 1893.

repeated innumerable times by Greek and Latin authors, are high stature, white skin, blue eyes, and red or blond hair (the difference between the red or blond color of the hair is of slight importance). So also Cæsar, comparing the stature of the Gauls with that of the Romans, says that the former were larger, the latter small.²

Subsequently, history mentions other blond or russet races such as the Cimbrians, the Teutons, Germans, Goths, Franks, Burgundians, Normans, but they all were of the same stock as the Celts and came from the same regions.

But it is not only the Greek and Latin authors who mention peoples with red or blond hair in Europe, for Byzantine historians, and writers at the beginning of the Middle Ages, and even Arabian authors likewise speak of them. The latter especially, as also Byzantine writers, have described the external characteristics of the primitive Russians, whose name means *red*, as we have shown in a communication to the Congress of Prehistoric Anthropology and Archeology at Monaco in 1906.

THE PLACE OF ORIGIN OF THE BLOND EUROPEANS.

Where was the exact primitive domain of the Celts? According to a tradition current among the Gauls, and of which the Druids speak, part of that people came from distant lands and islands whence they had been driven by wars and an inundation of the ocean.

The first habitation of the Celts, and consequently of all the blonds, may be placed in north and central Germany, in Holland, in upper and lower Austria, in Bohemia, in Scandinavia, in the Danish islands and peninsulas, and in central Russia, as will be shown by an examination of prehistoric skulls.

What was the climate of all these centers? This is an important question from the viewpoint of influence of environment. We know from Aristotle that the countries of the Celts and Scythians were cold, but Tacitus (first to second century A. D.) gives still further details of the Celtic land in his description of the sea, the land, and the climate of the country of the Germans, who inhabited the same localities as their ancestors, the Celt. He says:

On the other side is the endless ocean which, as it were, forbids all navigation. Even now it is rarely visited by vessels from our parts. What mortal, even if he braved the perils of a wild, unknown sea, would leave Asia, or Africa, or Italy to go to Germany which offers only a dreary country, a rigorous climate, where every aspect of living is savage, unless it be one's fatherland. * * * The country, though frequently varying in aspect, is in general covered with gloomy forests or swamps. Winter is long with them [the Germans].

Tacitus further says:

I believe that the Germans are indigenous and have not mingled with new arrivals or immigrants from other peoples. * * * I join in the opinion of those who think

² Julius Caesar. Gallic War.

that the peoples of Germany have not at all been altered by intermarriage with other peoples, and that this nation is intact, pure, like itself alone. Hence the resemblance of individuals one to another, although great in number. All have fierce blue eyes, reddish hair, large stature, fit for the first onrush, but not for continuous labor and toil; least of all can they stand heat and thirst, but under the influence of their climate and soil they have learned well how to bear cold and hunger.¹

Julius Cæsar likewise relates that the country of the (Germans) Sueves was very cold, but that notwithstanding that they were accustomed to clothe themselves with only a short skin which left part of the body bare.²

It is also to be added that tidal waves often ravaged the land of the Celts. Thus Ephorus (363–300 B. C.) relates that the Celts, in order to inure themselves to fearlessness, regarded tranquilly the destruction of their habitations by the sea, contentedly rebuilding them again, and that inundations have always claimed more victims among them than war (IV, 44).

The Cimbrians, another blond people, were, according to Florus, driven out from their country by an overflow of the Baltic³ about 114 B. C. But Strabo, who thought only of the regular ebb and flow of the ocean, does not believe in such floods, expressly rejecting them. Their recurrence, however, has been witnessed in the Middle Ages and in modern times. Thus the inundation of 1277, which gave birth to Dollart at the mouth of the Ems, is said to have destroyed 43 parishes and to have cost 80,000 lives in Friesland; so again, the great "Mandrinkel" (drowning) of September 8, 1362, annihilated 30 parishes and carried away large portions of the islands of Sylt and Föhr (Schleswig). The great inundation of Christmas, 1717, submerged, according to the testimony of Arends and d'Eilker, 10,828 persons and 90,000 head of cattle.⁴

ORIGIN OF THE RACE.

All the blond Europeans were, then, natives of Europe itself, and did not come from Central Asia. There were, to be sure, both before and after the beginning of the Christian era, some blond groups in Asia and in what is called Ou Sun, Ting Ling, Kiankuen, but that was in the north of China, according to Chinese annals.⁵ Besides, these blonds spoke Turkish and they disappeared by being absorbed in the mass of the yellow Asiatics.

As predecessors and ancestors of the blond stock in Europe there is therefore none other to be considered than the Quaternary race of Neanderthal. It is true that the anthropological characteristics of

¹ Tacitus. Germania.

² Cæsar. Gallic War.

³ Florus. Epitome rerum romanorum.

⁴ Suess. Das Antlitz der Erde. 2 B^d. Prag, 1883-1888.

⁵ Klaproth. Tableaux historiques de l'Asie depuis la monarchie de Cyrus jusqu'à nos jours. Paris, 1826.

this Quaternary race differs from the Neolithic race which succeeded it, but the Neolithic dolichocephals of the north of Europe frequently present atavistic characteristics which recall their neanderthaloid origin, as will be seen below.

It has been observed that certain animals underwent modifications during the Quaternary epoch through the influence of temperature, showing themselves now as cold and then as warm fauna. Why should not particular modifications of the organism have taken place in the human species also under the influence of climate? Why should not one blond variety have become so by the cold, and another brown have become such by a more clement temperature? What, then, was the physiological process in virtue of which the primitive blond races acquired their characteristics?

I think that under the influence of the cold climate of the epoch the production of cutaneous and capillary pigment in the human organism was so weak that the skin bleached, and the hair and beard became lighter so as to assume the coloring of red or blond, for the different colorings of the capillary system depend on the greater or less quantity of pigment resident therein. Hence it results that the iris also is less pigmented and consequently of a bright color.

But when an anthropological characteristic becomes modified, other characteristics vary simultaneously by virtue of the phenomenon of correlative variation. Thus the skeleton underwent certain modifications as regards its height and other dimensions; but besides the influence of the climate upon the organism, account should also be taken of the manner of life of the Germans (and doubtless also of their ancestors), and the care they took to stimulate growth in the entire race.

Thus their whole life was passed in the chase and the exercises of war. They hardened themselves from infancy by work and fatigue. It was a kind of sport very conducive to bodily development.

They lived chiefly on milk, cheese, and meat, for they devoted themselves but little to agriculture, and, in fact, of vegetation they had only wild fruit to consume.

Each mother nursed her child herself, never intrusting it to a servant or nurse, and it was allowed to grow up entirely naked. The Germans paid much attention to the period of puberty of the young people, and Julius Cæsar said that it was considered a disgrace with them to have known a woman before the age of 20. They favored a retarded puberty in the conviction that this was conducive to a robust body and strong nerves. Tacitus adds that they were no more hasty in marrying off their daughters, so that the wives, being the men's equal in size, health, and vigor, transmitted their strength to their offspring. Finally, the Germans frequently took warm baths in winter and cold ones in summer, in the rivers. It seems that they

plunged their new-born infants into cold water, a custom that wrung an outcry from Galen, the celebrated Greek physician of that time. Here is what he says on the subject:

Which of us could stand the sight of a small infant, scarcely born, still all warm, carried to the river and plunged into the water as a piece of hot iron, and this, as the Germans say, in order to put its nature to the test and at the same time to strengthen its body? * * * For whether it stands the test without becoming sick, whether it shows that it can keep its inborn strength and acquire additional vigor from this contact with cold water, is something which everyone can know; but whether, on the contrary, if its natural warmth is overcome by the external cold, it must necessarily die, is something which no one knows. What man in his senses and who is not a veritable savage, a Scythian, would want to submit his infant to such a test, where failure means death, and this without deriving any great advantage from the test? ¹

Aside from the last-mentioned practice, which the Germans considered as probably efficacious, it can be seen from the preceding that they attached great importance to the physical culture of infancy and youth; but aside from their tall stature the Germans and their predecessors were also corpulent, for Galen writes on this subject:

It is said that in cold countries man becomes stout, and as examples are quoted the Celts, the Thracians, the Bythinians, the peoples of the Pontus and the Galatians. All these peoples inhabit a cold country, and are generally stout.²

(I quote this remark of Galen without insisting on it.)

It may be objected, as regards the color, that the Finns and Lapps reside in still more northern regions and yet remain brown. But to this it may be answered that there are blond or red Finns, and it can not be said that mixture is the cause of their light color. There are even entire tribes of Finns which consist of blonds only. Thus the Mordevs of European Russia are divided into two separate tribes, of which one, the Erses, includes only individuals with blond hair, gray eyes, and light color. The other tribe, the Mokshes, on the contrary, consists of two varieties of individuals, of which those that are brown with dark eyes and tawny skin are equal if not superior to those who are blond.³

Among the Finns of Asia there are blonds or reds in a large or small number, according to the locality. I should state here, anent the red or blond Finns, that I make no distinction from the point of view of anthropology between blond people and people with red hair. In fact, the blond races begin by having the hair red before it becomes blond, just as they may have eyes that are green before they are blue or gray; but before this transformation is completed in the entire race there may yet be individuals with red hair and green eyes in the midst of others who are more advanced in this evolution and who have blond hair with blue or gray eyes. This is a phenomenon

¹ Galien. (Cl.). Opera omnia. Greek and Latin edition of Kühn. Vol. 6, pp. 51-52. (Extrait des auteurs grecs concernant la géographie et l'histoire des Gaules. Paris, 1878-1892. Vol. 6, pp. 43-45.)

² Op. cit.

³ Smirnov. Les populations finnoises de la Volga et de la Kama. Trad. du russe. Paris, 1898.

which can be still observed among the Finns, who are generally rather red than blond.

The Germans described by ancient authors had red hair, while the hair of the Gauls was rather blond, and notwithstanding this the latter, as is well known, tinged their hair with a lotion of lime.

Since, then, there existed in Europe both red and blond Finns, it may be concluded that the blonds of history, the Celto-Gauls, the Cimbrians, the Germans, etc., were the descendants of these European Finns, the more so because certain philologists maintain that the Aryan languages are offshoots of a branch of the Finno-Ugrian languages. Thus Koeppe, as the result of a comparative study of these different languages, came to the conclusion that there was an original relationship between the Aryans and the Finns, and even applied to that original stock the name of Ario-Finen. He thinks that these two races lived together in the north of Europe during a very long period, and that they even emigrated together at a very distant time.¹

But as our views are based exclusively on anthropology, we must turn our attention to the skeletons which have been found in the regions occupied by the old blond European races, and which we will study in order to learn whether these skeletons, and particularly the skulls, may not give us better information on the origin of the primitive blonds.

THE SKULLS OF THE PREHISTORIC BLONDS.

When Tacitus said that the Germans were indigenous (autochthons) he was not wrong, for the skulls of the neolithic period which have been found in northern and central Germany are, in great part, dolichocephalic and present, moreover, a correspondence to those of the reihengräber (tombs in rows) of southern Germany, which are considered as having belonged to the blond Germans.

But it is not only in Germany that these neolithic dolichocephalic skulls with Germanic type have been found, but also in Holland, Denmark, Sweden, Norway, in upper and lower Austria, and as far as the kurgans (tumuli) of central Russia. We shall therefore survey all these regions in order to recover there our neolithic dolichocephals, and at the same time to ascertain the evolution which they have undergone in the transition to the brachycephalic type. By this it will be seen how necessary is the measuring of skulls and of the skeleton, in general, in an investigation of the origin of the human races.

But how is the cranial type of the blond Germans constituted? It is well known that there were brown dolichocephals in middle

¹ Koeppe. Contribution à la question du lieu d'origine et de la parenté des races européennes et finno-ougriennes. St. Petersburg, 1886. (In Russian.) Review by Steida in Arch. für Anth., vol. 20.

Europe, and it is therefore necessary to distinguish between the two types.

Here are the principal characteristics of the Germanic skull, according to Von Hölder:

Seen from above, the skull presents an elongated shape, blunted, hexagonal, sometimes oval. The coronal suture is elliptic and extends toward the back. The maximum width of the vault is more noticeable forward than with brachycephals. The occiput has a pyramidal form, straight (or narrow), blunted. Seen from behind, the upper curve has the appearance of a roof; the sides are but slightly swelled out and fall nearly straight; the base has nearly the same width as the distance between the lateral walls. The height of the skull exceeds or equals its breadth. Seen from the profile, the head is moderately prognathic, often orthognathic. The face presents a high and narrow (or straight) front and visage; the superciliary vaults are much developed, especially in men, the eye sockets (orbits) are of medium size, with nearly horizontal upper rims. The nose is straight, with a moderately curved ridge. The formation of the avolaries is straight and high. The cranial capacity is considerably larger than that of the brachycephals by reason of the much larger diameter of both width and height.¹

But besides the cranial characteristics, certain peculiarities of other parts of the skeleton should also not be neglected. Thus there are often noticed platycnemid tibiæ in the neolithic dolichocephals of Germany; then the tall stature which was already noticed by the ancient writers in the blonds of their times.

It is needless to add that the German dolichocephals do not always show a full ensemble of the characteristics just enumerated; thus there is sometimes what is called a disharmony between the cranial vault and the face in so far as the skull is dolichocephalic while the face is short and round, for there are sometimes transitoral characteristics from the dolichocephalic type to the brachycephalic type. There are even met with in the excavations complete brachycephals scattered among the dolichocephals, but they are nothing less than the result of the transformation of the latter under the influence of evolution, so that the problem of these brachycephals is thus in our opinion solved. They are all German skulls, but such as have lost their original dolichocephalic type without the intermediary of any admixture.

PREHISTORIC SKULLS OF GERMANY.

Rhenish Hessia.—In examining the finds of the latest excavations, those, for instance, which have been made near Worms (Rheingewann, in Rhenish Hessia) by Dr. Koehl, where he found skulls of the neolithic period, of five skulls which could be measured, four were dolichocephalic and one mesaticcephalic. The faces of these skulls were in a bad state of preservation, still it could be assumed as certain that these neolithics had long and narrow faces, high sockets (orbits)

¹ H. von Hölder. Untersuchungen über die Skelettfunde in den vorrömischen Hügelgräbern, Württemberg. Stuttgart, 1893. C. R. in Revue de l'École d'Anthropologie, 1895, by Hovelacque.

and projecting and narrow noses. Virchow, who had studied these skulls, thought that this neolithic race of Worms was Aryan, or at least of the stock from which the Aryans issued. Besides the skulls there was also a large number of platycnemic tibiæ, whole or broken. On six skeletons the platycnemy could be measured, and Herr Virchow carried out the measuring according to the French method.

Herr Köhl opened in the presence of Virchow some graves of the Roman period and took from them four skeletons whose skulls were diagnosed as mesaticephalic; only one was on the border line of dolichocephaly.¹ Here, then, cranial evolution was more advanced. At Rheingewann, at Flomborn, and at Rheindurkheim, in the same vicinity of Worms, there were found skulls of the end of the Bronze Age which were mesaticephalic or dolichocephalic (especially those of Flomborn), while at Adlersberg, still in the same region, the skulls of the early Bronze Age were brachycephalic; that is, evolved.

Bartels was able to make a more complete comparative study of these places, for he had at his disposal a series of 50 skulls.²

However, the evolution varied according to the locality. Thus in 15 skulls (6 of men, 9 of women) found at Alsheim (Rhenish Hessa), the middle index was 73.5, the maximum 80.3, and the minimum 69.8.³

Baden.—According to Ammon, who made a special study of the anthropology of Baden, the cephalic index of the population since early German times has been generally approaching brachycephaly. Thus in the reihengräber dolichocephalic skulls are found in the proportion of 69.2 per cent with an index of 80, while in the present inhabitants the proportion is only 15 per cent. On the other hand the brachycephals, with an index of 85 and above, constituted only 9.4 per cent among the old Germans, while among the present they are represented by 33.5 per cent.

Ammon ascribed the cause of this change of the indices to some sort of natural selection which is noticeable everywhere, in the army, among professional men, among merchants, and in the laboring world. According to this theory natural selection differentiates and separates the different classes one from another and effects subdivisions within the classes, particularly in the class of working people, whose economic and social rise, he says, is made possible only by selection, survival of the best.⁴

¹ Virchow. Eroeffnung prähistorischer und römischer Gräber in Worms. *Zeitschrift für Ethnologie*, 1897.

² Bartels. Über Schädel der Steinzeit und der frühen Bronzezeit aus der Umgegend von Worms-a-Rhein. *Zeitsch. f. Ethnologie*, 1904.

³ Virchow. Reihengräberfelde bei Alsheim. *Zeitsch. f. Ethnologie*, 1877.

⁴ Ammon. Die natürliche Auslese beim Menschen. Jena, 1898. See also *Zur Anthropologie der Badener*, by the same, Jena, 1899.

Bavaria.—Of Bavaria we may record the same phenomenon observed, namely, the transformation from dolichocephaly to brachycephaly. Thus the proportion of brachycephals in skulls of the reihengräber is 14 per cent; in those of the tenth to twelfth centuries (found at Lindau), 32 per cent; while in those of the present population of southern Bavaria it is 83 per cent.¹ It even did not require an immeasurable time to produce this enormous change, for we know how many centuries passed since the close of the tenth century during which dolichocephaly has decreased, while brachycephaly has increased.

Württemberg.—The antecedence of the dolichocephals is here noted, as in Baden, Bavaria, and Rhenish Hessia. Thus, in the flat graves (without tumulus covering) of the neolithic period, which were discovered in 1887, near the Seelberg, three skulls were found having an index of 72.4 to 77.8, exhibiting the complete German type of the Merovingian period (from end of fifth to middle of eighth century A. D.).

The Hallstatt hügelgräber (hill graves, beginning of the Iron Age), of Württemberg, have furnished 87 skulls which are formed as follows: 75 more or less elongated, with an index varying from 60 to 79.2, constituting 86.2 per cent; while the short skulls, with an index between 80.1 and 89.8, numbered only 12, or 13.8 per cent.

As regards their type, Von Hölder, who has studied them, concisely defined it as follows:

The dolichocephals and mesaticephals, which exhibit all the essential characteristics of the German type, are of the same kind as the German reihengräber of Württemberg (fourth to eighth centuries). There is no doubt, remarks M. Hervé, that Suabia, the country between the Rhine and the Danube, was, during the Hallstatt epoch, the abode of a considerable part of the great northern race whose movements 10 or 11 centuries later on was to shake the Roman Empire. The dolichocephals were, then, the ancestors of the Suevians and Marcomans described by Tacitus
* * *

It is at the utmost, if at the end of the early Iron Age the brachycephals, who now predominate in nearly all parts of the country, counted here and there a few representatives.² We might quote other proofs, derived from the excavations in Württemberg, of the antecedence of the dolichocephals.

Prussia.—In passing over into north Germany the same facts are observed. Thus from Tilsit to the other end of the country, in both eastern and western Prussia, and in Pomerania, there have been found a number of skulls of the early Iron Age—all of them dolichocephalic and always of the same type as that of the reihengräber.

¹ Ranke. Frühmittelalterliche Schädel und Gebeine aus Lindau. Sitzungsberichte der Königl. bayer Akademie der Wissenschaften. München, 1897, vol. 27.

² H. von Hölder. Le Tumulus halstattien du Württemberg, reviewed by Hervé in the Revue de l'Ecole d'Anthropologie, 1896.

But while east of the Vistula there was a series of large skulls mixed with long ones, yet west of the river, in the present Pomerania, only dolichocephalic skulls were found, from which Lissauer concluded that it was here that the German race originated.¹

These skulls recovered from the hügelgräber of the surroundings of Neustettin (Pomerania) are exactly like those of the Hügelgräber of southern Germany; that is, they are dolichocephalic; but along with the pure dolichocephalic type of the reihengräber there were also larger forms, the result of a more advanced evolution. Other older skulls (belonging to the period of transition from Bronze to Iron Age), which have been found in Pomerania at Crissau, near Danzig, in western Prussia, are likewise of the dolichocephalic type (70 to 70.2).

Finally three still older skulls (neolithic) are likewise dolichocephalic. One of these came from a tomb in the plain of Conjavia, between Thorn and Inowraslaw (western Prussia), and had a cephalic index of 66.5; it was massive, with prominent superciliary vaults nearly running into one another at the frontal joint (glabella). The two other skulls, which were found at Wiskiwten, in Samland (north of Koenigsberg), had indices of 63.1 and 68.8.²

Since Lissauer's publications in 1874 and 1878 other finds of prehistoric skulls have been made in north Germany which confirm the conclusion of this author regarding the dolichocephaly of the primitive blond Germans. Thus a neolithic skull discovered by Hollmann near Tangermünde (central Prussia, district of Stendal), and examined by Virchow in 1883, had an index of 68.5;³ other skulls of the same locality had indices of 71.5, 76, and even 77.7, which marks quite an advanced evolution for the last two, but the corresponding tibiae of the skeletons were in part slightly platycnemic like other neolithic skeletons of German origin of Rhenish Hessa.

Schumann in several communications to the Anthropological Society of Berlin in 1891 and 1894 discussed neolithic skulls from various parts of north Germany which, besides being dolichocephalic, were analogous to the skulls of the reihengräber or south Germany. Thus a skull from Glasow, near Löcknitz (Pomerania), had an index of 68.7 and very prominent superciliary vaults. Another, found at Casekow, in the region of Randow, had an index of 72.2, and a third of 67.16 from Oberfür, in the vicinity of Bublitz.⁴

Finally, four other skulls of the Roman period, discovered in Borkenhagen (region of Cöslin, in Pomerania), showed indices of 69.8, 71.3, 71.5, and 72.7, although these would be much later than

¹ Lissauer. *Crania prussica*, Zeitschr. f. Ethnol., 1874, p. 189, 225.

² Lissauer. *Loc. cit.*

³ Hollmann. *Gräberfunde bei Tangermünde*, Zeitschr. f. Ethnol., 1883 and 1884.

⁴ Schumann. *Tommersche Skeletgräber, wahrscheinlich aus der Steinzeit*. Zeitschr. f. Ethnol., 1891.

the neolithic period.¹ The evolution which in older localities had already relatively advanced was less noticeable in more recent places.

According to Lissauer the middle cephalic index of 282 present Prussian skulls is 79.15.

OLD DOLICHOCEPHALS OF GERMAN TYPE FOUND OUTSIDE OF PRESENT GERMANY.

The countries in which these skulls are met with are many and widely extended in Europe.

Holland.—In the northeast of this country there have been found in certain tombs, called *terps*, dating from the beginning of the Christian era, 39 skulls whose medium cephalic index is 74.8. There were 54 per cent dolichocephalic, 38 per cent mesaticephalic, and only 8 per cent brachycephalic.² The dolichocephalic were identical with those of the reihengräber, while the brachycephalic, as it is seen, were but slightly represented down to historic time. In contrast to this, of 80 skulls of the fourteenth and fifteenth centuries there were not a single one whose index was less than 80. At present the great mass of the people of Holland are of two brachycephalic types, one blond the other brown, the former with a middle index of 80 to 82, the latter with one of 84 to 86.³

Bohemia.—In this country, which adjoins south Germany, were found skulls which were much older than those of Holland, for they dated from the neolithic period. At that time the large majority was dolichocephalic, while at present the Czech population, as well as the Germans of Bohemia, are brachycephalic. Only their language separates them. During the Stone Age, says Niederlé,⁴ a round skull is extremely rare.

In the Hallstatt period the percentage remained in favor of dolichocephaly; it is only much later, from the eighth to the twelfth centuries, that brachycephaly begins to predominate, 40 per cent brachycephals as opposed to 20.9 per cent of dolichocephals. Finally, the skulls of the sixteenth century, examined by Matiegha, are mesaticephalic in the proportion of 25 per cent, and the dolichocephalic only 5 per cent. That scholar also stated that the proportion of brachycephals is much larger among females.⁵

The following summing up of Zuckerkandl shows the gradual supplanting of the dolichocephals by the brachycephals in Bohemia:⁶

Prehistoric time.—Long skulls, 57.1 per cent; middle, 19.1 per cent; short, 23.8 per cent.

¹ Schumann, Skeletgräber mit römischen Beigaben. Zeitsch. f. Ethnol., 1894.

² H. C. Folmer. Die ersten Bewohner der Nordseeküste, etc. Archiv für Anthropologie, 1900.

³ Bock. Ueber die Verbreitung der rothhaarigen in den Niederlanden. Zeitschrift für Morphologie, 1907.

⁴ Niederlé. Die österreichische-ungarische Monarchie in Wort und Bild. Wien, 1894.

⁵ Matiegha. Anthropologi des czechisch-slavischen Volkes. Prag., 1896.

⁶ Zuckerkandl. Congrès des sociétés anthr. allem. et viennoises, 1889. C. R. in Mittheil. der Anth. Gesellsch. in Wien, vol. 19.

Present time.—Long skulls, 0; middle, 17.5 per cent; short, 82.5 per cent.

This change is due to the transformation of the dolichocephalic type without the influence of a foreign immigration.

It should be noted that although the evolution was a gradual one, it did not require an indefinite time, for the modification took place gradually, almost from century to century, as is proved by the finds in graves which are exactly dated. Thus the graves of the tenth century furnished 58.3 per cent of long skulls, while in those of the twelfth and thirteenth centuries there are no more than 23.5 per cent. At the same time the cephalic index increases. Thus the cephalic index of 74.66 in the tenth century rises to 76.19 until the end of the eleventh century, and to 78.26 until the end of the thirteenth century; in the sixteenth century it is already 80.77, and at the present time 83.19.¹ It is also to be remembered that the oldest Quaternary race of Bohemia was likewise dolichocephalic to judge from the Brux skull which dates from the Mousterien period.

As regards the color, at present the brown type predominates in Bohemia, while in the Middle Ages it was still the blond type. Finally, the historical documents dating from the end of the first century, point to the fact on which Niederle insists, namely, that the Slavs of the East were blond and had blue eyes. As prehistory teaches us that the primitive type was dolichocephalic, so history tells us that the primitive type of the Slavs was blond. According to Weissbach the middle cephalic index of 221 modern Slav skulls is 82.90, and according to Meyer and Koperniki it is 84.4 among the Poles and Ruthenians of Galicia.

Austria.—In the western Provinces, German as well as Slavic, the primitive population was likewise dolichocephalic, for the ratio of dolichocephaly to brachycephaly was originally as 87 to 13. Subsequently the relation was reversed, as can be seen from the following table, according to Zuckerkandl:²

LOWER AUSTRIA.

	Dolichoc.	Mesatic.	Brachyc.	Hyperbrachyc.
Modern skulls.....	4.6	32.2	35.6	27.6
Ancient skulls.....	66.7	29.2	4.1	27.6

UPPER AUSTRIA.

	Dolichoc.	Mesatic.	Brachyc.	Hyperbrachyc.
Modern skulls.....	2.0	18.8	44.3	36.0
Ancient skulls.....	80.0	20.0	44.3	36.0

¹ A. Fischel. Ueber die Abstammung des Menschen und die ältesten Menschenrassen. Sitzungsberichte d. deutschen naturwissensch.-medizinischen Vereins für Böhmen. Prag., 1903. C. R. in Centraltblatt für Anthropologie, 1904.

² Zuckerkandl. *Loc. cit.*

Hungary.—At Lengyel, in south Hungary, five prehistoric skulls have been found, four of which were neolithic and one was of the Bronze Age. They were measured by Virchow. The first four, which were male, had a cephalic index of 74.3, 78.2, 68.82, and 67.5, while that of the fifth was 77.3. Virchow said that these skulls greatly resembled the neolithic skulls of northern Europe, and added that they might even be considered as of Aryan origin, or as representing one of the stocks from which the Aryans sprung.¹ It is probable, however, that these dolichocephals were merely immigrants from the north. In any case they prove the wide expansion of the prehistoric blonds in Europe.

The Isles of Britain.—In the long barrows of the Stone Age, as in the tumuli and caves of the same period, were found skulls with a middle index of 72 for 86 skulls, but not of the German type, as their dolichocephaly was more meridional. They are, therefore, of no service for our subject, the less so, as the stature of the skeletons is much shorter than that of the dolichocephals of other countries which have been connected with the blond stock.

After the dolichocephals the brachycephals came, bringing bronze with them into England. These are found in the round barrows of the southern part of the country (with middle cephalic index of 80 for 103 skulls); but they are not to be considered as the descendants of the neolithic dolichocephals, as they were immigrants. Besides, the pottery of the Bronze Age fully resembled that of Central Europe.²

The only brachycephals who might be descendants of the neolithic dolichocephals are those of the same period who are found in different parts of the British Islands, not in the long-barrows, but in the tumuli, in caves, and in other graves. These neolithic brachycephals are quite different from those of the Bronze Age.

There were, however, in Great Britain blond peoples, which Strabo has specifically described:

The Britons are much taller than the Celts (Gauls) and less blond, but of a gentler temperament. To give an idea of their stature, we have seen with our own eyes in Rome that when scarcely emerged from infancy they would surpass the tallest people in the city by half a foot. It should be added that along with this they are bow-legged and their bodies are generally ill-proportioned.³

Tacitus, who must have been well-informed about the type of the Britons through his father-in-law, the Roman general, Agricola, dwells particularly on the variety of their external characteristics (*habitus corporum varii*), for he describes the reds and blonds among the indigenes of Great Britain. He says:

The russet hair of the inhabitants of Caledonia and their large size attest German origin. * * * The Britons nearest to the Gauls resemble them, either by reason

¹ Virchow. Excursion nach Lengyel (Süd-Ungarn). Zeitschrift für Ethnologie, 1890.

² Abercromby. The oldest Bronze Age ceramic type in Britain. Journal of the Anthropological Institute of Great Britain, 1902.

³ Strabo. Geography, Chap. V. 2.

of the lasting impress of the same origin, or because in these countries, which face one another, the likeness of the climate has given the body the same form. But it is probable that the Gauls had settled in the country so near to them.¹

The Britons with brown hair are placed by Tacitus in the southwest of the Gallic country. "The tawny color, the generally curly hair of the Silures and their location opposite Spain suggest that the ancient Iberians had crossed the sea to settle in the country."²

The Spanish origin of the Silures does not seem in doubt, and as for the Caledonians (Scots) of German type, they must be, in our opinion, the descendants of the Celts who invaded the British Islands toward the seventh or eighth century B. C., or even of blonds preceding the Celts. However that may be, it may be assumed, on the authority of Tacitus, that in ancient time there existed in Great Britain both blond and brown indigenes, just as at present there are blond and brown Englishmen.

Still, according to tradition, the blonds were in majority there during the Middle Ages, not so much on account of the immigration of Anglo-Saxons, Danes, and Normans, but because the blonds were already numerous there before such immigration.

"It seems perfectly proved," says Prichard, "that the color at present predominating in the British Isles differs markedly from that of all the races which entered into the formation of the present people. We have seen that the ancient Celtic tribes belonged to a blond race, and such also were the Anglo-Saxons, the Danes, and the Normans, lastly, the Caledonians (Scots) and the Gaelic (Irish), likewise, were a people with white skin and blond hair, and yet these peculiarities by no means form a constant characteristic among the mixed descendants of these blue-eyed races."³

According to Beddoe, the people of modern England, as regards the eyes and the hair, are darker than those of Scotland.

Denmark.—The best-known Danish skulls of the Stone Age are those of the celebrated tumulus of Borreby, in the southwest of Sjælland Island, which are preserved with other skulls of the succeeding ages in the Museum of the Antiquities of the North at Copenhagen. Virchow, who had measured them, found for 25 skulls of Borreby a middle index of 79. Among them there were brachycephals as well as dolichocephals, but the latter were in the majority. Other neolithic skulls of Denmark (Islands of Moen, Falster, and Langland) were combined for measurement with those of Borreby, and yielded the somewhat lower middle index of 77 for a total of 41 skulls.

A particular characteristic of a certain number of these skulls consists in a marked jutting out of the orbital vaults, similar to that of

¹ Tacitus. *Life of Agricola*, Sect. XI.

² *Idem.* *Op. cit.*

³ Prichard. *Histoire natur. de l'homme.* French translation by Roulin, Paris, 1843.

the Neanderthal man, which Virchow compares with that of the present Australians.

It may, therefore, be concluded that these skulls are of remote antiquity, notwithstanding that some of them are brachycephalic. In any case, they are not Lapp, howsoever they may show the type called Laponoid, for the Lapps have never inhabited the Scandinavian regions below 62° north latitude.

For the Bronze Age Virchow could measure only three skulls whose middle index is 66.6. The five skulls of the Iron Age have indexes of 65.5 for the early Iron Age and 69.1 for the later one.¹

Since the publication of Virchow's measurements of the prehistoric skulls of the Museum of the Antiquities of the North, Soren Hansen has examined five other skulls of the Bronze Age, while Prof. Nielsen has studied the entire prehistoric population of Denmark at different periods.

Thus Nielsen stated that of 119 skulls of the Stone Age there were 83 dolichocephalic, that is, 70 per cent, and more than half of these 83 neolithic skulls (47 per cent) were pure dolichocephalic, with an index of 75 or less. Of the skulls of the Bronze Age only 1 was brachycephalic (81) and 3 inclined to an index of 79. Of the 35 skulls of the Iron Age, lastly, only 1 was brachycephalic (81), 2 had an index of 79, while 25 had one of 75 or less.² Besides, the skeletons found in peat and those of the Iron Age are particularly large.

From this preponderance of dolichocephaly during prehistoric times in Denmark we conclude that the population there was then blond, as in Germany and the neighboring countries; and as regards the prehistoric brachycephals of the different ages, they were related to the corresponding dolichocephals. At present, dolichocephaly seems to predominate, though mesaticephaly and brachycephaly are not wanting. By far the greater part of the present population has chestnut-colored hair, but with light eyes, while dark eyes are relatively rare. There are likewise some blond-haired. (The observations were made on 2,000 individuals of the age of 20 from the southern and eastern parts of the peninsula of Jutland.)³

Sweden.—In this country, already at the period of polished stone implements, there were three races: (1) True dolichocephals, with elliptic or slightly oval countenance, low and narrow forehead, highly developed superciliary arches and glabella, low orbits and straight nose; (2) brachycephals; (3) mesaticephals of very varied types.

¹ Virchow. Die altnordischen Schädel zu Kopenhagen. Archiv. für Anthropologie, 1870.

² Nielsen. Anthropologie de la population du Danemark, 1906 (quoted by G. Retzius in the Journal of the Anthropological Institute of Great Britain, 1909, p. 304).

³ Sören Hansen and Topinard. La couleur des cheveux et des yeux en Danemark. Revue d'Anthropologie, 1883.

Of 42 neolithic skulls coming from different parts of Sweden, 39 are dolichocephalic, 16 mesaticephalic, and only 3 brachycephalic. The periods of bronze and iron produced no important change in the proportion of these different ethnic elements which still constitute the basis of the present population.

Of 51 skulls of the Iron Age, 47 are dolichocephalic, 15 mesaticephalic, and 4 brachycephalic. It is thus very probable, says G. Retzius, that the dolichocephalic people of prehistoric times belonged to a race of great stature, with blond hair, blue eyes, and long head, which still represents 85 per cent of the present population. Thus Retzius calls Sweden the home of the blonds.

The archeologist Bunsen told Prichard in regard to this, "that he had in vain searched for the golden hair and azure eyes of the ancient Germans, and that he could never find the originals of the portraits which the ancients had depicted of his compatriots until he visited Scandinavia; there he found himself in the midst of the Germans of Tacitus."¹

As regards the brachycephals, says Retzius, only surmises can be expressed on their affinity with the Lapp or Finnish races, or with the brachycephals which are met with in the same period in the rest of Europe.²

At present there are in Sweden about 87 per cent dolichocephals and only 13 per cent brachycephals.

On our part we shall call attention to the strongly jutting out of the superciliary vaults of the glabella among the neolithic dolichocephals of Sweden, which has already been noticed in other neolithic skulls of ancient Germany. This anthropological characteristic represents an atavism suggesting, in our opinion, a relationship to the dolichocephals of the period of chipped and polished stone implements.

But as regards the neolithic brachycephalic skulls, designated by De Quatrefages and Hamy as Laponoides, which have been found in various regions of western Europe, they have, in our opinion, no connection whatever with the Lapp race; their origin should be looked for where they are found.

Norway.—Of 161 old Norwegian skulls which form part of the anatomical collection of the University of Christiania, and which have been examined by Justus Barth, there were 41.8 per cent dolichocephalic, 52.3 per cent mesaticephalic, and only 5.9 per cent brachycephalic. All these skulls represent the ancient people of southeast Norway, and their average age is about 500 years. To these are joined a number of other skulls found in tumuli of the Viking Age; that is, of the latter part of the Iron Age, and the time

¹ Prichard. *Op. cit.*, vol. 1, p. 267.

² Retzius (G.). *Crania suecica antiqua*. Stockholm, 1900. The so-called North European race of Man-kind, by the same author. *Journal of the Anthropological Institute of Great Britain and Ireland*, 1900.

immediately preceding it. There was also examined a collection of skulls from gaederen in southeast Norway (the method employed in measuring was the so-called of Frankfort).

“The Viking type, which is very marked and widely spread, is nevertheless,” says Barth, “not rightly considered as specially belonging to Norway; it is rather an archeo-Germanic type, to judge by its resemblance to the ancient form known as the type of the row-graves [reihengräber]. The Viking type is found not only among these old Norwegian skulls, but is met with also among our contemporaries, and especially in the dolicho and mesaticephalic districts. They are also found among the skulls of Jaederen, which, according to Arbo, belong to the brachycephalic type. One is constrained to assume that besides the Lapps and Finns two other ethnic elements, the decidedly dolicho-mesaticephals and the decidedly brachycephals, entered into the formation of the Norwegian race.”¹

The very small proportion of brachycephals and the predominance of mesaticephals would, in our opinion, prove that they are the product of evolution of the dolichocephals, for besides the skulls of the Viking type there are skulls which date only from about 500 years. At present, according to the investigations of Arbo and other anthropologists, the dolichocephals preponderate, especially in the eastern part of the country, but in the southeastern and along the coast a large proportion of brachycephals is met with.

Russia.—Prehistoric skulls of the kurgans (tumuli) of central Russia were described, in 1892, by Bogdanov; they are similar to those of the old German type. He says as follows:

One of the most eminent anthropologists of Germany wrote that when seeing these skulls he noticed their perfect resemblance to the skulls found in the ancient tombs of Germany (reihengräber). A distinguished anthropologist of Sweden found that they resembled the ancient Swedish skulls. In going several times through the museums of Europe I was struck by the resemblance of the skulls found in Germany and belonging to the prehistoric time of that country to our Kurganians.²

These skulls have already been discussed by us in a communication to the society in 1891 (De la transformation d'une race dolichocéphale en une race brachycéphale), and we shall not repeat it here. We shall only extract the following passage for our argument:

In the prehistoric tumuli of the government of Moscow there were 56.4 per cent of dolichocephalic, or rather subdolichocephalic skulls, and 22 per cent mesaticephalic; the brachycephalic furnished only 5.6 per cent. But dolichocephaly diminished little by little, and brachycephaly ended by getting the better of it in modern times. Thus of 120 skulls from the old cemeteries of Moscow, dating from the sixteenth to the eighteenth centuries, there were only 19.65 per cent dolichocephalic, while the brachycephalic were in the proportion of 52.99 per cent. There have also been found samples of hair in some kurgans which appear to have been dark-blond for the dolichocephals and chestnut-colored for the brachycephals.

¹ Justus Barth. *Crania antiqua in parte orientale Norwegiæ meridionalis inventa.* Christiania, 1896.

² Bogdanov. *Quelle est la race plus ancienne de la Russie centrale?* Moscou, 1892.

This would prove that the Slavs of Russia were quite dolichocephalic and blond in the beginning, but became brachycephalic and brown exclusively under the influence of evolution, not owing to mixture.

We believe, then, that we have indicated the principal regions of Europe where the neolithic dolichocephals of the German type have been found, and it will be noticed that neither Belgium nor France have been considered, because the neolithic dolichocephals of these countries are not of the German type, properly speaking, although there may have been some connection between them.

As regards the so-called Merovingian skulls which have been found in France, it is well known that they come from immigrants in historic time.

There remains Switzerland, where prehistoric dolichocephals of the German type¹ have been met with, but they are skulls of immigrants. Upon what ground is the assumption based that they are skulls of immigrants? Upon the fact that before them there were already in that country other races of an entirely different type, as has been shown by human bones found there. The skulls which were anterior to those of the German type are brachycephalic, so-called Laponoid resembling those of the race of Grenelle, which, in their turn, are again the descendants of another dolichocephalic race, representing the oldest race of Switzerland.

The Laponoid brachycephals should be distinguished from another prehistoric brachycephalic race of a finer type than that met with in Switzerland in the Bronze and Iron Ages, and which proceeded from the German dolichocephalic race, like that which has passed away in Germany and other countries mentioned in our description.

Thus the succession of the different prehistoric races in Switzerland, from our point of view, is as follows:

1. The primitive dolichocephalic race.
2. Laponoid brachycephals (not Lapps), issued from the preceding.
3. German dolichocephalic race.
4. Brachycephalic race, issued from the preceding.

At present brachycephaly predominates in Switzerland.

FREQUENCY OF BRACHYCEPHALY AMONG WOMEN IN THE COURSE OF EVOLUTION.

It has already been noted several times that in certain tombs, which contained a more or less large number of dolichocephals and only a few brachycephals, that it was the female sex which most frequently presented brachycephaly or mesaticephaly. Lissauer and

¹ His and Rutimeyer. *Crania helvetica*, Basel 1864. Stüder et Barnwarth. *Crania helvetica antiqua*. Leipzig, 1894.

Virchow, for German skulls, and Matiegha, for Bohemian, have noticed this fact without, however, attempting to explain it. Thus Lissauer, among 30 skulls of Kaldus, counted 13 dolichocephalic, 13 mesaticephalic, and 4 brachycephalic, and 3 of these last ones were of women.

Virchow, in a communication to the Anthropological Society of Berlin in 1881, on the graves of Slaboszewo, near Mazilno (Posen), presented the study of 16 skulls, 10 of men and 6 of women, whose cephalic index was 72.5 for the former and 77.8 for the latter. Of the 6 women there were 5 mesaticephalic and 1 brachycephalic, but not one dolichocephalic.

Among the skulls of other sepulchers which have been measured by different authors there is sometimes only a single brachycephalic found among a certain number of dolichocephalic ones, and it is precisely the brachycephalic one that belongs to a woman. It might be objected that it is often difficult to recognize the sex characteristics of a female skull, but in a good many sepulchers the skeletons are intact, which permits of distinguishing the sexes.

If, therefore, it be assumed that the brachycephals are immigrants, where there are dolichocephals, it must also be assumed that women only had invaded the localities where only female brachycephals are found—something unbelievable.

Furthermore, it has already often been remarked that the brachycephals were at first found everywhere in small numbers and increased only in the course of centuries. It must then be supposed that the brachycephalic men, if they had been the invaders, were scattered over a wide area of land, being, at a certain period, everywhere in the minority—something which is no less inadmissible.

To say that the brachycephalic immigration came from unknown parts is a pure hypothesis. It must then be supposed that the evolution from the dolichocephalic type to the brachycephalic was first effected in the female sex. In other words, the modification of the cephalic type seems to have made its appearance first in woman.

We could quote other proofs in support of our thesis of the mutability of anthropological characteristics, and if it is admitted that a brachycephalic race might descend, without mixture, from a dolichocephalic race, which also implies the transformation of a blond race into a brown one, the task of historians would be facilitated, and they would thus be able to establish the relationship of certain peoples that are divided not only by name and language but also by anthropological characteristics.

In this way could be explained the connection between the blond Celts and the brown ones by assuming that this people was originally blond. In the same way it could be explained why the Slavs, whom

history depicts as having once been blond, are now brown or approaching that color.

History also tells us that there have been successive invasions of blonds in Europe, such as of the Celts, the Cimbrians, the Germans, etc. Now, it may be assumed that similar invasions had also taken place in prehistoric times, and it is on that account that the exact period of the settlement of the Celts in western Europe can not be determined; but the Celts might be considered as the predecessors and conquerors of the Cimbrians, Germans, Goths, Normans, etc.

It remains to speak of the origin of the blond or red Fins, the blond Lapps, and of the blonds that are sporadically met with among brown nations.

It has already been shown that the blond Finns sprung from brown Finns, and it is thus seen that a blond race might descend from a brown one without the intermediary of any mixture, just as a brown race might descend from a blond one.

As regards the blond Lapps, their evolution is the same as that of the blond Finns; that is to say, they descended directly from the brown Lapps without crossing with a foreign race.

As to the blonds that are met with everywhere in the midst of brown races, in exclusively brown families, they are the result of a simple transient variation, so that they themselves can not procreate but browns, resembling the race from which they sprung.

In conclusion, we believe that it is demonstrated that during Neolithic times there existed in a great part of Europe—in Holland, Germany, Austria, Bohemia, Denmark, Sweden, Norway, and Russia—one and the same dolichocephalic race, being the descendant from the Quaternary dolichocephalic race and which can be considered as the stock from which sprung the blonds mentioned in history under the names of Celto-Galato-Gauls, Cimbrians, Germans, Goths, Normans, etc. All these blond races were therefore of European not Asiatic origin, and they had occupied a vast area and not a more or less limited part of Europe. Subsequently they invaded other parts of Europe and even Asiatic regions.

Later the greater part of these blond races was transformed, becoming brown and brachycephalic without the intermediary of any mixing, and this is the reason why at present exclusively blond races, as described by the ancient authors, are found no more, so that they may be called fossil races.

HISTORY OF THE FINGER-PRINT SYSTEM.

By BERTHOLD LAUFER.

[With 7 plates.]

On May 2, 1906, the *Evening Post* of New York announced in an article headed "Police Lesson from India" the first successful application in this country of the thumb-print test. A notorious criminal had robbed the wife of a prominent novelist in London of £800, had made his escape to New York, and was captured after committing a robbery in one of the large hotels in that city. The Bertillon Bureau of the Police Department took a print of one of his thumbs, which was mailed without any other particulars to the Convict Supervision Office, New Scotland Yard, London, where he was promptly identified. He was convicted and sentenced to seven years in prison. The system of finger prints is now successfully utilized by the police departments of all large cities of this country, central bureaus of identification having been established in the capitals of the States. The admissibility of finger-print evidence as valid proof of guilt in murder trials was upheld in the case of a colored man executed in Cook County, Ill., on February 16, 1912. He was convicted of murder largely on a showing by the prosecution that the imprint of a finger on the woodwork in the slain man's house corresponded with that in the records of Joliet prison, where an imprint of the accused's fingers had been taken when he was discharged from the penitentiary a short time before the murder. Likewise, in our relations with illiterate people the system has come to the fore. On the approval of the Secretary of the Interior Department, the Commissioner of Indian Affairs instructed officials throughout Oklahoma in 1912 that hereafter every Indian who can not write his name will be required to sign all checks and official papers, and indorse checks and warrants covering Indian money, by making an impression of the ball of his right thumb, such imprint to be witnessed by an employee of the Indian agency or by one of the leading men of the tribe who can write. If an Indian is not living with his tribe, his thumb-mark signature must be witnessed by the postmaster of the place where he resides. Prominent banks

of Chicago have adopted finger prints in the case of foreign-born customers who can not sign their names in English, and it is reported that the scheme has worked out to perfect satisfaction. The cashier of one of the large Chicago banks stated in an interview in the *Chicago Tribune* of May 14, 1911:

We have never had a complaint or error from this system. There are absolutely no two thumbs alike, and the thumb-print mark is an absolute identification. We have had complaints over signatures, but never over thumb prints. Men have claimed that they did not sign withdrawal slips, but no one has ever denied his thumb mark.

It is well known that the honor of having developed the system of finger prints and placing it on a scientific basis is due to Sir Francis Galton, explorer and scientist, born at Birmingham, England, February 16, 1822, and who died in London in January, 1911. The results of his studies are contained in two books, *Finger Prints* (London, 1892) and *Finger Print Directories* (London, 1895).¹ The system is based on two observations—the widely varying, individual character of the finger marks (in Galton's words: "It is probable that no two finger prints in the whole world are so alike that an expert would fail to distinguish between them") and the persistency of the form of the marks in the same individual from childhood to old age. Galton comments on the latter point as follows:

As there is no sign, except in one case, of change during any of these four intervals which together almost wholly cover the ordinary life of man (boyhood, early manhood, middle age, extreme old age), we are justified in inferring that between birth and death there is absolutely no change in, say, 699 out of 700 of the numerous characteristics of the markings of the fingers of the same person such as can be impressed by him wherever it is desirable to do so. Neither can there be any change after death up to the time when the skin perishes through decomposition: for example, the marks on the fingers of many Egyptian mummies and on the paws of stuffed monkeys still remain legible. Very good evidence and careful inquiry is thus seen to justify the popular idea of the persistence of finger markings. There appear to be no bodily characteristics other than deep scars and tattoo marks comparable in their persistence to these markings; at the same time they are out of all proportion more numerous than any other measureable features. The dimensions of the limbs and body alter in the course of growth and decay; the color, quantity, and quality of the hair, the tint and quality of the skin, the number and set of the teeth, the expression of the features, the gestures, the handwriting, even the eye color, change after many years. There seems no persistence in the visible parts of the body except in these minute and hitherto disregarded ridges.

The permanency of the finger marks certainly refers to the features of the design, especially the character of the ridges, but not to their measurements, which are subject to the same general changes associated with the growth of the body. Galton himself admits his great

¹ Of later books on the subject, E. R. Henry, *Classification and Uses of Finger Prints*, 3d edition, London, 1905, may be specially mentioned.

indebtedness to Sir William J. Herschel,¹ and from him he appears to have received the first impetus for an investigation of this subject. Galton's attention was first drawn to it in 1888 when preparing a lecture on Personal Identification for the Royal Institution, which had for its principal object an account of the anthropometric method of Bertillon. "Wishing to treat the subject generally," he says, "and having a vague knowledge of the value sometimes assigned to finger marks, I made inquiries, and was surprised to find both how much had been done, and how much there remained to do before establishing their theoretical value and practical utility."² This confession implies that Galton did not discover the idea himself, but derived it from, and relied solely on, his predecessors, chiefly Herschel, who, moreover, can not claim that the idea was wholly his own.

This method of identification had been suggested to Sir William Herschel by two contracts in Bengali, dated 1858. "It was so difficult to obtain credence to the signatures of the natives that he thought he would use the signatures of the hand itself, chiefly with the intention of frightening the man who made it from afterwards denying his formal act. However, the impression proved so good that Sir William Herschel became convinced that the same method might be further utilized. He finally introduced the use of finger prints in several departments at Hooghly (in Bengal) in 1877, after 17 years' experience of the value of the evidence they afforded. A too brief account of his work was given by him in *Nature*, volume 23, page 23 (Nov. 25, 1880). In 1877 he submitted a report in semiofficial form to the Inspector General of Gaols, asking to be allowed to extend the process; but no result followed." "If the use of finger prints ever becomes of general importance," remarks Galton, "Sir William Herschel must be regarded as the first who devised a feasible method for regular use and afterwards officially adopted it."³

It is difficult to believe that Herschel, stationed in India, should have conjured up, entirely from his own resources, a system which had been known and applied in the East ages before his time. Had he designed it in his home study in England, the matter might be looked upon in a different light. But he resided at Calcutta, where a large colony of Chinese had been settled for a long time, and if a European, living in the Orient in close official and private relations with its people, conceives an idea which seems to belong to his very surroundings, it would be proper to credit his environment with its due share in shaping that idea. The man laboring on his "invention" for years may easily forget this first impetus. It matters little

¹ Finger Prints. London, 1892, p. 4. Herschel was born in 1833 and engaged in the Civil Service of India from 1853 to 1878.

² *Ibid.*, p. 2.

³ Compare Galton, *Finger Prints*, p. 28.

also whether or not he himself is conscious of outward influences; the cool and impartial historian, in the light of observed facts, can reach no other conclusion than that Herschel must have conceived his idea from observations of similar affairs made on the spot. A similar judgment was early rendered by a writer in the *Nineteenth Century* (1894, p. 365) who championed the cause of the Chinese in the priority of the finger-print system. Herschel himself, however, was of a different opinion and indignantly rejected such a point of view.

In a letter addressed to *Nature* (vol. 51, 1894, p. 77) Herschel claimed for himself that "he chanced upon finger prints" in 1858 and followed it up afterwards, and that he placed all his materials at the disposal of Galton. While vindicating the honor of the invention for himself, he at the same time deprecated "as being to the best of his knowledge wholly unproved the assertion that the use of finger marks in this way was originally invented by the Chinese." "I have met no evidence," he continues, "which goes anywhere near substantiating this. As a matter of fact, I exhibited the system to many passengers and officers of the P. and O. steamship *Mongolia* in the Indian Ocean during her outward voyage in February, 1877, and I have the finger prints of her captain, and of all those persons, with their names. It is likely enough that the idea, which caught on rapidly among the passengers, may have found a settlement in some Chinese port by this route, and have there taken a practical form; but whether that be so or not, I must protest against the vague claim made on behalf of the Chinese until satisfactory evidence of antiquity is produced."

The notion here expressed by Herschel that his thought might have spread to some Chinese port is, to say the least, somewhat naïve, and the fact remains that the use of finger prints is well authenticated in China long before his lifetime. The gauntlet brusquely thrown down by him was soon taken up by two scholars—a Japanese, Mr. Kumagusu Minakata,¹ and the always combative Prof. G. Schlegel,² of Leiden. Both were actuated by the sincere intention of furnishing proof of the antiquity of the method of finger prints in China and Japan; but both failed in this attempt for lack of proper understanding of what the finger-print system really is. Both confused with the latter the hand stamp; that is, a slight impression taken from the palm. These are entirely different affairs, and in view of the general knowledge now existing in regard to the significance and effects of finger prints it is needless to emphasize the fact that a mere impression of the palm can never lead to the identification of an individual, which is of first importance in finger prints. The entire argument of Schlegel is restricted to two references occurring in his Dutch-Chinese

¹ The Antiquity of the "Finger-Print" Method (*Nature*, vol. 51, 1894, pp. 199-200).

² *T'oung Pao*, vol. 6, 1895, p. 148.

Dictionary, one pertaining to bills of divorce which are authenticated by a print of the hand of the husband, and the phrase *ta shou yin*, "to produce a hand seal"; that is, to make an impress with the blackened palm.¹

The Chinese origin of the finger-print system has been upheld by several writers on the subject.² The correspondent of the *Evening Post* quoted at the beginning of this paper said: "As a matter of fact, it is one of those cherished western institutions that the Chinese have calmly claimed for their own, and those who doubt this may be convinced by actual history, showing it to have been employed in the police courts of British India for a generation or so back." In 1908 Prof. Giles,³ the well-known sinologue, wrote: "It should always be remembered that the wonderful system of identification by finger prints was borrowed straight from China, where it has been in vogue for many centuries." But this "straight from China" is the very difficult point in the matter. While the chronological priority of the Chinese in the practice of finger prints may be satisfactorily established, there is no evidence to show that Herschel received a stimulus directly from China, nor that the people of India, from whom Herschel may well have borrowed the idea, were ever influenced in this direction by the Chinese. As a matter of principle it should be stated that it is most unlikely that a complex series of ideas as presented by the finger-print process was several times evolved by different nations

¹ It should not be supposed that this is a common Chinese practice. It may be a local custom of which Schlegel heard in Amoy or its vicinity, where he derived his knowledge. The Chinese marriage and divorce laws (comp. P. Hoang, *Le mariage chinois au point de vue légal*, Shanghai, 1898) make no reference to such procedure. J. Doolittle (*Social Life of the Chinese*, London, 1868, p. 75) has the following: "It is not necessary for the husband, in giving a bill of divorce to his wife, to do it in the presence of an officer of the Government as witness in order to make it legal. He does it on his own authority and in his own name. It is often written in the presence of her parents and in their house. Very few divorces occur in China." In a recent work (Dr. L. Wiegner's *Moral Tenets and Customs in China*. Texts in Chinese, translated and annotated by L. Davrout, Ilo-kien-fu, 1913, on plate opposite p. 193) is illustrated a divorce bill stamped with the hand and foot of the husband in black ink. It is remarked in the text that the impress of a finger is sometimes used as a seal, that the paper would be invalid without such a stamp, and that in case of contestation the document thus stamped proves the divorce.

² In the second chapter of his "Finger Prints," which treats of the previous use of them, Galton refers also to many impressions of fingers found on ancient pottery, as on Roman tiles. These nail marks, used ornamentally by potters, especially in prehistoric pottery, are well known to every archeologist, but they move on a line in psychological and technical regard entirely different from the finger-print system and can not by any means be connected with its history, as Galton inclines to establish. Thus also the coin of the T'ang dynasty, "bearing a nail mark of the Empress Wen-to in relief" and figured by Galton, does not belong at all to this category. The Chinese works on numismatics (e. g., *K'in-ting ts'ien lu*, ch. 11, p. 2, ch. 16, p. 14) explain this mark occurring on many issues of the T'ang and Sung dynasties—apparently the mark of a mint—as a picture of the crescent of the moon. Handcock (*Mesopotamian Archeology*, London, 1912, p. 83) has an allusion to "finger-marked bricks" of the Sargon period. This vague hint, from which no inference whatever as to the use of these marks for identification can be drawn, has led astray a well-known egyptologist into proclaiming the origin of the invention of finger prints in Babylonia, but as this statement appeared only in sensational newspaper reports, I refrain from discussing it. Finger marks may naturally arise anywhere where potters handle bricks or jars, but every expert in finger prints will agree with me that these are so superficial as to render them useless for identification. A clear and useful finger impression in clay presupposes a willful and energetic action, while the potter touches the clay but slightly. However this may be, we are not willing to admit as evidence for a finger-print system any finger marks of whatever kind occurring in pottery of any part of the world, unless strict proof can be furnished that such marks have actually served for the purpose of identification.

³ *Adversaria Sinica*, No. 6, p. 183.

independently. If there is one thing that we know surely, it is the fact of the scarcity of original ideas among mankind, which may stand in relation to reproduced ideas as 1:100. The fact remains that, however simple and self-evident the system may now look to us, the most advanced civilized nations have never hit upon it, that no trace of it can be discovered among Egyptians or Babylonians, Greeks or Romans, and that its so very recent adoption into our culture, after prolonged contact with east-Asiatic nations, is in itself suspicious of a derivation from a foreign source. The hypothesis, therefore, seems to be justified that Chinese immigrants into India may have carried the idea over, or that the long religious and commercial intercourse between the two countries may be responsible for the transmission. It is out of the question to assume the reverse course of events, for the application of finger prints in China is of great antiquity, even greater than ever suspected heretofore, while nothing of the kind can be proved for its antiquity in India.

At all events it seems certain that finger impressions were known in India prior to the time of Herschel. George A. Grierson,¹ one of the best connoisseurs of modern Hindu life, in describing the ceremonies at the birth of a child, mentions the fact that the midwife, using red lead, makes a finger print on the wall, with the intention of hastening delivery. It is hard to imagine that this magical conception of the finger print, which is an ingredient of indigenous folklore, should be credited to the discovery of Herschel. There are, further, good reasons to presume that the marks on the finger bulbs were familiar to the Indian system of palmistry. I recently had occasion to study an ancient Sanskrit treatise on painting, the *Citralakshana*,² which is preserved in a Tibetan translation embodied in the *Tanjur*. One chapter of this work is taken up with a detailed description of the physical qualities of the *Cakravartin*, the wheel-turning king, the hero and racial ideal who formed the principal object of ancient painting. The majority of the marks of beauty attributed to him are derived from the rules of physiognomy, a system reaching back to remote times; some of these marks, by way of comparison of the Sanskrit with the old Persian terms, are traceable to the Aryan period when the Iranians and Indians still formed a united stock of peoples. The interpretation of prominent physical qualities, as laid down by the physiognomists, led to artistic attempts of portrayal, and for this reason I was induced to study, in connection with the *Citralakshana*, two Indian treatises on physiognomy contained likewise in the Tibetan *Tanjur*, with the result that the terminology of physiognomy and art theory are identical, and that the rules of the painter closely follow in the trail of the physiognomist and palmist.

¹ *Bihâr Peasant Life*. Calcutta, 1885, p. 338.

² Edited and translated under the title *Dokumente der Indischen Kunst*, I, Leipzig, 1913.

It would lead too far away from our subject proper to enter into the manifold details of this quaint art, but the principal points relating to the fingers may be insisted upon. It is said in the *Sāmudravyañjanāni*, one of the works on physiognomy, that a woman, if the marks on her fingers are turned toward the right-hand side will obtain a son, but if turned toward the left, a daughter will be born.¹ The Indian painter paid minute attention to the hand, the fingers, and their lines. In the above-mentioned manual of painting, their measurements, inclusive of those of the ball of the thumb, are conscientiously given.² A peculiar term of Indian cheiromancy is *yava* (*lit.* a barley-corn), explained by Monnier Williams in his Sanskrit Dictionary as "a figure or mark on the hand resembling a barleycorn, a natural line across the thumb at the second joint compared to a grain of barley and supposed to indicate good fortune." In all probability, this term refers also to the marks on the finger tips, and there is further the Sanskrit word *angulīmudrā* (*lit.* finger seal) used in the sense of finger print and exactly corresponding to the Chinese term *chi yin* (likewise finger seal) of the same significance.³

An interesting case, though not directly bearing on our subject, may here be mentioned:

Hüan Tsang, the famous Chinese traveler to India, in the seventh century, relates a story in regard to the king of Takshaçilā in India who availed himself of his tooth impression stamped in red wax on official documents. In giving instructions to his son, the king said: "The affairs of a country are of serious importance; the feelings of men are contradictory; undertake nothing rashly, so as to endanger your authority; verify the orders sent you; my seal is the impression of my teeth; here in my mouth is my seal. There can be no mistake."⁴ Only one analogy to this curious custom is known to me. In a charter of King Athelstan of Northumberland it is said:

And for a certen truth

I bite this wax with my gang-tooth.⁵

¹ Laufer, *Dokumente*, etc., p. 159.

² *Ibid.*, pp. 163, 164.

³ At the present time India is probably the country where the most extensive use of the finger-print system is made. It has been adopted since 1899 by the Director General of the Post Offices of India. On the forms of Indian Inland Money Orders, for example, it is printed: "Signature (in ink) of payee or thumb impression if payee is illiterate." In many other departments of government it has proved an efficient method of preventing perjury and personation. No objection can be raised on the ground of religion or caste, so there is no prejudice to be overcome in obtaining the finger print. The Government has been so fully convinced of the effectiveness of the new system, and of the certainty of the results it yields, that the Indian Legislature has passed a special act amending the law of evidence to the extent of declaring relevant the testimony of those who by study have become proficient in finger-print decipherment. In all registration offices, persons who, admitting execution, present documents for registration, are required to authenticate their identity by affixing the impression of their left thumb both on the document and in a register kept for the purpose. (Compare E. R. Henry, *Classification and Uses of Finger Prints*, London, 1905, pp. 6-9.)

⁴ S. Beal, *Buddhist Records of the Western World*, Vol. I, p. 140. St. Julien, *Mémoires sur les contrées occidentales*, Vol. I, p. 156.

⁵ *Folk-lore*, vol. 15, 1904, p. 342.

While it is likely that the people of ancient India were familiar with the striæ on the finger tips, there is, however, no evidence whatever that finger impressions were employed to establish the identity of a person. No mention of finger prints is made in the ancient Indian law books. The signature of an individual was a recognized institution of law and a requirement in all contracts. The debtor was obliged to sign his name at the close of the bond, and to add: "I, the son of such and such a one, agree to the above." Then came the witnesses signing their name and that of their father, with the remark: "I, so and so, am witness thereof." The scribe finally added: "The above has been written by me, so and so, the son of so and so, at the request of both parties." An illiterate debtor or witness was allowed to have a substitute write for him. A note of hand written by the debtor himself was also valid without the signatures of witnesses, provided there was no compulsion, fraud, bribery, or enmity connected with the operation. The cleverness of forgers is pointed out, and the necessity of comparison of handwritings and conscientious examination of documents are insisted on.¹

Besides the documents pertaining to private law, there were public or royal deeds, among which those relating to foundations, grants of land to subjects as marks of royal favor, took a prominent place. They were written on copper plates or cotton cloth, and the royal seal (*mudrā*) was attached to them, a necessary act to legalize the document. The forgery of a deed was looked upon as a capital crime, in the same way as in China. The seals represented an animal like a boar or the mythical bird Garuda. It is thus shown by the legal practice in ancient India that there was no occasion in it for the use of finger prints, and it appears that the significance of the latter was recognized only in palmistry and magic.²

In recent times the finger-print system has been employed in China only in two cases, at the reception of foundlings in the founding asylums and in the signing of contracts on the part of illiterate people. In regard to the former mode we owe valuable information to F. Hirth,³ who has made a study of the regulations of Chinese benevolent institutions.⁴ The founding asylums established in all large cities receive orphan children, forsaken babies, or any others sent to them. These are placed by their relatives in a sliding drawer in the wall near the front gate and a bamboo drum is struck to notify the gatekeeper, who opens the drawer from the inside of the wall and

¹ Compare J. Jolly, *Recht und Sitte*, p. 113 (*Grundriss der indo-arischen Philologie*, Strassburg, 1896).

² Possibly, also the Malayan tribes, as shown by their notions of palmistry, may be acquainted with finger marks. W. W. Skeat (*Malay Magic*, London, 1900, p. 562) notes that a whorl of circular lines on the fingers is considered as the sign of a craftsman.

³ *T'oung Pao*, vol. 7, 1896, p. 299.

⁴ An interesting account of these is given also by W. Lockhart, *The Medical Missionary in China*, London, 1861, pp. 23-30, and recently by Yu-Yue Tsu, *The Spirit of Chinese Philanthropy* (Columbia University, 1912), who refers also to the finger marks (p. 61).

transfers the little one to the care of the matron. Every infant is subjected to a method by which its identity is permanently placed on record. Sex and age are entered on a register. If the age can not be made out—it may be inferred, for example, from the style of clothing varying from year to year—the time of the reception into the asylum according to year, month, day, and hour is noted. Then follows a description of bodily qualities, including remarks on the extremities, formation of the skull, crown of the head, birthmarks, and design on the finger tips, for later identification. Emphasis is laid on the latter, for each Chinese mother is familiar with the finger marks of her new born, and as there is a high degree of probability that a baby temporarily placed in the care of the asylum owing to distressed circumstances of the family will be claimed at a later time, this identification system is carefully kept up. The Chinese seem to be acquainted with the essential characteristics of finger marks. What in the technical language of our system is called “arches” and “whorls” is styled by them lo “snail,” and our “loops” are designated *ki* “sieve,” “winnowing-basket.”¹ The former are popularly looked upon as foreboding of luck.

Deeds of sale are sometimes signed with a finger print by the negotiating party. We reproduce (pl. 1) such a document after Th. T. Meadows² in preference to any other of recent date because this deed, executed and dated in 1839, furnishes actual evidence of the use of an individual finger impression in China before the system was developed in Europe. The transaction in question is the disposal of a plot of cultivated land for which a sum of 64 taels and 5 mace was paid. The receipt of the full value of this amount is acknowledged by the head of the family selling the land; in this case the mother née Ch'ên whose finger print is headed by the words “Impression of the finger of the mother née Ch'ên.” It is evident that Mrs. Ch'ên was unable to write and affixed her finger print in lieu of her name. Sir Francis Galton³ comments on this finger print in the words: “The impression, as it appears in the woodcut, is roundish in outline, and was therefore made by the tip and not the bulb of the finger. Its surface is somewhat mottled, but there is no trace of any ridges.”

¹ A brief nomenclature pertaining to finger prints may here be given. The numbers in parentheses refer to Giles' Chinese-English Dictionary (2d edition). *Lo wên* (No. 7291, *lit.* net-pattern), “the impress of a finger, hand, or foot, dipped in ink and appended as a signature to any kind of deed or other legal instrument.” *Chi yin* (No. 13282, *lit.* finger-seal), “seal on deeds, etc., made by dipping the finger or hand in ink and pressing it on paper.” *Hua kung* (No. 6752), “to sign one's deposition, usually by dipping the thumb in ink and making an impression of it on the paper.” *Lien ki tou* (No. 13133), “to verify the lines on a man's fingers, in connection with the impression on a deed, etc.” Further, *chi mo* (No. 8066), “finger-pattern” and *hua ya* (*lit.* to paint, i. e., to ink and press down) are expressions in the sense of our signature; *hua chi* (No. 1791), “to make a finger print, as a signature”; *chi jên* (*ibid.*), “to identify.”

² Land Tenure in China (*Transactions of the China Branch of the Royal Asiatic Society*, Hongkong, 1848, p. 12).

³ Finger Prints, London, 1892, p. 24.

In all contracts of civil law Chinese custom demands the autographic signatures of the contracting parties, the middlemen, and the witnesses.¹ Also the writer of the bond is obliged to sign his name at the end with the title *tai pi* ("writing for another"). If the seller write the contract out in person, he should sign again at the end, with the addition *tse pi* ("self-written"). As the number of those able to write is very large, and as even those who have an imperfect or no knowledge of writing are at least able to write their names, it will be seen that there is little occasion for the employment of finger prints in such contracts. Prof. Giles² states that title deeds and other legal instruments are still often found to bear, in addition to signatures, the finger prints of the parties concerned; sometimes, indeed, the imprint of the whole hand. This would indicate a survival of the originally magical and ritualistic character of the custom.

From the fact that the signature has little or hardly any legal importance, it follows that the forgery of a signature does not fall under the provisions of the Penal Code. The Code of the Manchu dynasty provided only for the forging of imperial edicts and official seals with intent to defraud, and punished these as capital crimes.³

In plates 2 and 3 a Tibetan document written in the running hand is reproduced. It is a promissory note signed by the debtor with the impressions from the balls of both his thumbs. The Tibetans have apparently derived the practice from the neighboring Chinese; there is little probability, at least, that, to speak with Herschel, "a passenger of the *Mongolia*" may have carried the suggestion to Tibet. The language of the Tibetans proves that this procedure is an old affair with them, for a seal or stamp is called *t'e-mo*, which is derived from, or identical with, the word *t'e-bo*, "thumb." Sarat Chandra Das in his Tibetan-English Dictionary justly says that the word *t'e-mo* originally means the thumb or thumb impression. We may hence infer that the thumb print was the first mode of signature of the Tibetans, in vogue prior to the introduction of metal (brass, iron, or lead) seals which were named for the thumb print, as they were identical with the latter in the principle of utilization. In the related language of the Lepcha, which has preserved a more ancient condition, we find the same expression *t'e-tsu*, "seal," and even *t'e c'ung*, "small seal," meaning at the same time "little finger."⁴

¹ Numerous examples may be seen in P. Hoang, *Notions techniques sur la propriété en Chine avec un choix d'actes et de documents officiels*, Shanghai, 1897 (*Variétés sinologiques* No. 11).

² *Adversaria Sinica*, Shanghai, 1908, p. 184.

³ G. Th. Staunton, *Ta Tsing Leu Lee, being the Fundamental Laws * * * of the Penal Code of China*, London, 1810, pp. 392, 396. E. Alabaster, *Notes and Commentaries on Chinese Criminal Law*, London, 1899, pp. 438, 439. B. H. Chamberlain (*Things Japanese*, 3d ed., 1898, p. 445) states: "It seems odd, considering the high esteem in which writing is held in Japan, that the signature should not occupy the same important place as in the West. The seal alone has legal force, the impression being made, not with sealing wax, but with vermilion ink."

⁴ Mainwaring and Grünwedel, *Dictionary of the Lepcha Language*, Berlin, 1898, p. 155.

立
水
遠
新
賣
田
契
入
黃
貴
隆
的
手
上

母
陳
氏
指
模



PORTION OF DEED OF SALE IN THE YEAR 1839 SIGNED WITH THE THUMB-PRINT OF A WOMAN.

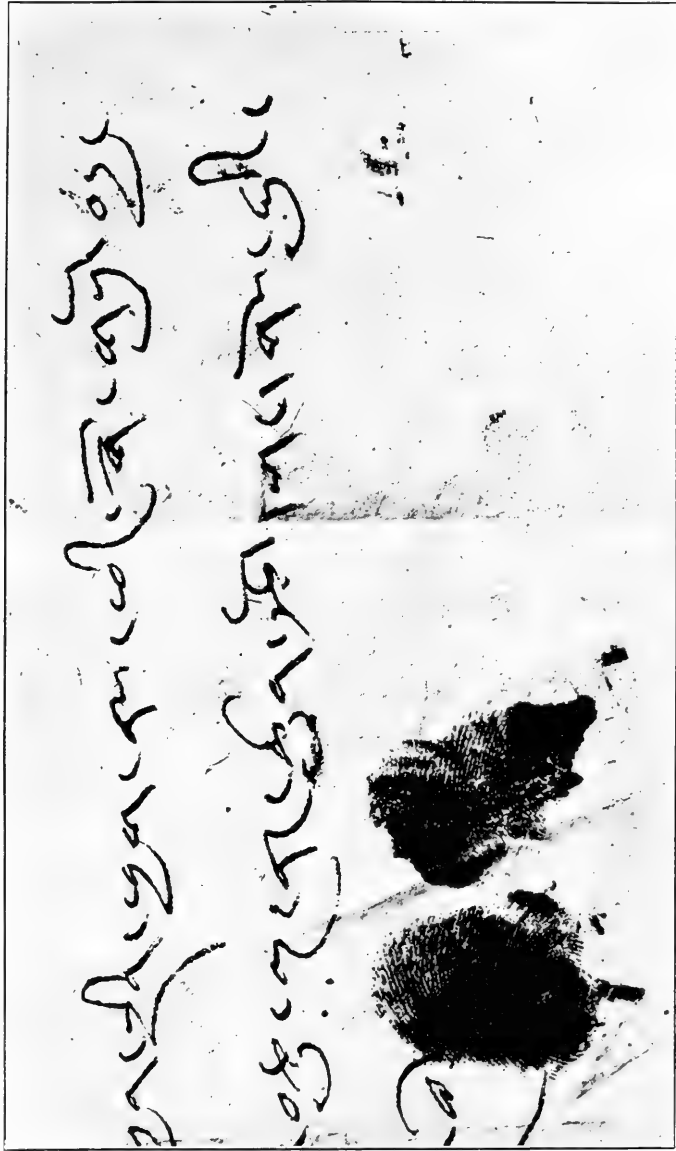

RIGHT PART OF TIBETAN PROMISSORY NOTE SIGNED BY THE DEBTOR WITH THE IMPRINT OF HIS THUMBS. (SEE PLATE 2.)

Not many literary data are available with which to trace the history of the finger-print system in China. Indeed, it is striking that we do not find in any author a clear description of it and its application. The physicians, in their exposition of the anatomy of the human body, do not allude to it, and it is certain that it was not anatomical or medical studies which called it into existence. It formed part of the domain of folklore, but not of scholarly erudition. In a society where learning was so highly esteemed and writing was almost worshiped as a fetich there was little chance for the development of a process from which only the illiterate class could derive a benefit. An ingenious system of tallies and a highly organized system of official and private seals regulated by Government statutes took the function of verification. The personal signature never had any great importance in public or private transactions, and the style of handwriting as individually differentiated in China as among us would always allow of a perfectly safe identification. We have most successfully applied the finger-print system in two phases of our social life—in banking transactions and in the detection of criminals. These two institutions move on entirely different lines of organization in China, and for this reason finger prints never were a real necessity there. The Chinese banking system does not require any signature, and could accordingly introduce no substitute for it. A bank in China issues to its depositor a pass book of miniature size consisting of a long continuous sheet of paper folded in pages and held together by two stiff blue covers. The entire book may, therefore, be unfolded at once and exhibit the credits and debits at a glance. Every deposit is entered, with the date, by a clerk of the establishment, and should the depositor wish to draw a sum, he carries or sends his book to the bank, which, on payment of the amount, charges it against him by entry in the same book. There is no check system. If the customer would make payment to a third person, the procedure is the same. The draft system, which is highly developed in China, works well without a stroke of the brush being involved on the part of the person to whose credit the draft is issued. Mr. N. orders a draft from a Peking bank, payable in his name, at a bank in Si-ngan fu. The Peking house writes the document out on a rectangular paper bill containing the same matter on the right and left sides, one column of writing running exactly down the center. The document is then evenly divided into halves, the vertical column of characters being cut through in the middle. Mr. N. will receive the right half, while the left half will be forwarded in the mail by the Peking bank to Si-ngan fu. On arrival there Mr. N. will present his part of the document, which will be carefully checked off with the other half, and if both are found out on close examination to tally, the draft will be honored, no receipt and signature on the part of Mr. N. being

required. The fact that both halves of the draft are in the hands of the Si-ngan fu banker is legal proof for the transaction having been closed. It is easy to see that this system is the natural offshoot of the ancient tallies in wood and metal. In regard to criminal persecution we must remember that crime had never assumed vast proportions in China, that detection and capture were comparatively easy, and that anything like a criminal science was not required for a patriarchal organization of government.¹ These are the reasons why the Chinese, though well acquainted with the character and significance of finger prints, did not develop them into a system; why they did not enter much into the speculations of their scholars, and why the records concerning them are brief and sparse.

The poet Su Shi (1036-1101) avails himself metaphorically of the expression "the whorls (snails) on the fingers" in the verse:

"Ngan, King of Ts'i, found on the bank of a river a fine stone veined like finger marks."²

During the Sung period (960-1278 A. D.) finger prints were taken in wax. This fact is reported by Wang Fu, the author of the *Po ku t'u lu*, the well-known catalogue of ancient bronzes first published in 1107 A. D. In chapter 6, p. 30, of this work, a bronze wine-cup of the Chou period is illustrated, on one side of which four large finger-shaped grooves appear, closely joined and looking like the fingers of a hand. The author explains the presence of these finger marks by saying that the ancients feared to drop such a vessel from their hands and therefore held it with a firm grip of their fingers in these grooves, "in order to indicate that they were careful to observe the rules of propriety." "At the present time," Wang Fu concludes, "finger marks are reproduced by means of wax, and are simply effected by pressing the fingers into wax."

Kia Kung-yen, an author of the T'ang period, who wrote about the year 650 A. D., makes a distinct allusion to finger impressions employed in his time for purposes of identification. He comments on the wooden tallies used in ancient times (before the invention of rag paper)—that is, a pair of wooden tablets on which the contract was inscribed. Each of the contracting parties received such a tablet, and notches were cut in the side of each tablet in identical places so that the two documents could be matched and easily verified.

¹ In Japan it is said the imprint of the left thumb (*bo-in* or *bo-han*) was formerly taken exclusively from criminals (H. Spörry, *Das Stempelwesen in Japan*, Zürich, 1901, p. 16; comp. *Globus*, vol. 81, 1902, p. 187). But from the way the matter is represented by this author it does not clearly follow that the desire of identification was the purpose of this method. A criminal, when placed in jail, was stripped of his clothing and money, and his thumb impression was taken, whereby he was deprived of his civil rights. During this term he was allowed to sign documents only with his thumb, also the record of his trial. A verdict, even a capital sentence, had formerly to be signed by the defendant with the thumb print. These cases indicate that the thumb print was looked upon in Japan as an inferior sort of signature; the criminal had lost his personality and name, and was therefore not allowed to use it as his signature. His thumb print, which took the place of it, was not intended to establish his identity.

² *P'ei wên yün fu*, Ch. 20 B, p. 50.

In explaining this ancient practice to his countrymen, Kia Kung-yen remarks: "The significance of these notches is the same as that of the finger prints (*hua chi*) of the present time." This comparison sufficiently shows that finger prints were utilized in the age of the T'ang dynasty (618-906), and not only this, but also that it was their purpose to establish the identity of a person. In the same manner, the author means to say, as the notches of the tallies served for the verification of a contract concluded between two persons, so the finger prints on two written contracts of the same tenor had the function of proving the identity of the contractors.¹

The existence of the finger print system in the T'ang period (618-906) is confirmed by the contemporaneous account of the Arabic merchant Soleiman who made several voyages to India and China, and left an interesting series of notes on both countries written in 851 A. D. It has been translated by M. Reinaud (*Relation des voyages faits par les Arabes et les Persans dans l'Inde et à la Chine*, Paris, 1845) where it is said (Vol. I, p. 42): "The Chinese respect justice in their transactions and in judicial proceedings. When anybody lends a sum of money to another, he writes a bill to this effect. The debtor, on his part, drafts a bill and marks it with two of his fingers united, the middle finger and the index. The two bills are joined together and folded, some characters being written on the spot separating them; then, they are unfolded and the lender receives the bill by which the borrower acknowledges his debt." This bill was legally recognized and served to the creditor in the court as an instrument proving the validity of the debt. It will be recognized that the process described by our Arabic informant in the ninth century is identical with the modern system of bank drafts, as outlined above, except that the finger prints of the debtor were affixed to the document in the T'ang period.

In regard to the prevalence of the finger-print system in China during the T'ang period, K. Minakawa has furnished a valuable piece of information. Chūryō Katsurakawa, the Japanese antiquary (1754-1808), writes on the subject as follows:

According to the "Domestic Law" (Korei), to divorce the wife the husband must give her a document stating which of the seven reasons for divorce was assigned for the action. * * * All letters must be in the husband's handwriting, but in case he does not understand how to write he should sign with a finger print. An ancient commentary on this passage is: "In case a husband can not write, let him hire another man to write the document * * * and after the husband's name sign with his own index finger." Perhaps this is the first mention in Japanese literature of the finger-print method.

¹ Compare E. Chavannes, *Les livres chinois avant l'invention du papier*, p. 56. (Reprint from *Journal asiatique*, Paris, 1905.)

This "Domestic Law" forms a part of the "Laws of Taihō," enacted in 702 A. D. With some exceptions, the main points of these laws were borrowed from the Chinese "Laws of Yung-hui" (650-655 A. D.); so it appears, in the judgment of Minakata, that the Chinese of the seventh century had already acquired the finger-print method.

It is very likely that the Chinese code of the T'ang dynasty and the abundant Chinese law literature will yield more information on this question.

Some writers have supposed on merely speculative grounds a connection between finger prints and palmistry. Galton¹ remarks on this point:

The European practitioners of palmistry and cheiromancy do not seem to have paid particular attention to the ridges with which we are concerned. A correspondent of the American journal, *Science*, volume 8, page 166, states, however, that the Chinese class the striæ at the ends of the fingers into "pots" when arranged in a coil and into "hooks." They are also regarded by the cheiromantists in Japan.

K. Minakata (l. c., p. 200) makes the following statement:

That the Chinese have paid minute attention to the finger furrows is well attested by the classified illustrations given of them in the household T'á-tsáh-tsú—the "Great Miscellany" of magic and divination—with the end of foretelling the predestined and hence unchanging fortunes; and as the art of chiromancy is alluded to in a political essay written in the third century B. C. (Han-fei-tse, XVII), we have reason to suppose that the Chinese in such early times had already conceived, if not perceived, the "forever unchanging" furrows on the finger tips.

But close research of this subject does not bear out this alleged fact. The fact is that in the Chinese system of palmistry the lines on the bulbs of the fingers are not at all considered, and that Chinese palmistry is not based on any anatomical considerations of the hand but is merely a projection of astrological notions. We have an excellent investigation of this tedious and wearisome subject by G. Dumoutier,² further by Stewart Culin,³ by H. Doré,⁴ and finally by H. A. Giles.⁵ Not one of these four authors makes any mention of the striæ on the finger tips, and I am myself unable to find anything to this effect in Chinese books on the subject. It is quite evident to me that Chinese finger prints do not trace their origin from the field of palmistry but are associated, as will be shown farther on, with another range of religious ideas. I do not doubt the antiquity of palmistry in China, though the date B. C. 3000, given in the last edition of the *Encyclopædia Britannica* on the authority of Giles, seems to be an exaggeration, but the conclusion of Minakata that for this reason the finger prints are equally old is unjust.

¹ Finger Prints, p. 26.

² Études d'ethnographie religieuse annamite in *Actes du onzième congrès des orientalistes*, Paris, 1898, pp. 313 et seq. The Annamite system there expounded is derived from the Chinese.

³ Palmistry in China and Japan (*Overland Monthly*, 1894, pp. 476-480).

⁴ Recherches sur les superstitions en Chine, Vol. II, Shanghai, 1912, pp. 223 et seq.

⁵ Phrenology, Physiognomy, and Palmistry (*Adversaria Sinica*, Shanghai, 1908, pp. 178-184).

tified. We must remember, also, that no system of palmistry has been handed down to us from ancient times; we merely know the fact that the practice itself existed at an early date. The philosopher Wang Ch'ung, who wrote in 82 or 83 A. D., states in regard to palm-isters that they examine the left palm, but neglect the right one, because the lines of the former are decisive, whereas diviners turn to the right side and neglect the left one, because the former are conclusive.¹

The view of the independence of finger prints from palmistry is by no means contradicted by the following statement of A. H. Smith:²

The Chinese, like the gypsies and many other peoples, tell fortunes by the lines upon the inside of the fingers. The circular striæ upon the finger tips are called *tou*, a peck, while those which are curved, without forming a circle are styled *ki*, being supposed to resemble a dustpan. Hence the following saying: "One peck, poor; two pecks, rich; three pecks, four pecks, open a pawnshop; five pecks, be a go-between; six pecks, be a thief; seven pecks, meet calamities; eight pecks, eat chaff; nine pecks and one dustpan, no work to do—eat till you are old."

This is neither fortune telling nor palmistry, but harmless jocular play which merely goes to prove that the striæ on the finger bulbs are noticed by the people and made the object of slight reflections. The above saying belongs to a well-known category of folklore which may be described under the title "counting out."

We alluded above to the hand stamp and its fundamental difference from finger prints in that it is unsuitable for identification. Let us now enter more particularly into this subject.

W. G. Aston³ has given three examples of the use of the hand stamp in the East. In the Chinese novel *Shui hu chuan* of the thirteenth century a writing of divorce is authenticated by the husband stamping on it the impress of his hand smeared with ink.⁴ In Japan, deeds, notes of hand, certificates, and other documents to

¹ A. Forke, *Lun-hêng*, Part II (Berlin, 1911), p. 275.—Many ideas of Chinese palmistry are directly borrowed from India. Prominent among these is the exaltation of long arms reaching down to the knees, which appears among the beauty marks of the Buddha and is in fact an ancient Aryan conception of the ruler (A. Grünwedel, *Buddhist Art in India*, p. 162; Laufer, *Dokumente*, pp. 166, 167). With the Indians as with the Persians, this is an old mark of noble birth (compare the name *Longimanus*, old Persian *Darghabâzu*, Sanskrit *Dīrghabahu*). In China we meet the notion that a man whose hand reaches below his knees will be among the bravest and worthiest of his generation, but one whose hand does not reach below his waist will ever be poor and lowly (Giles, l. c., p. 181). In regard to Liu Pei (162-223 A. D.), it is on record that his ears reached to his shoulders and his hands to his knees (Giles, *Biographical Dictionary*, p. 516).

² *Proverbs and Common Sayings from the Chinese*, Shanghai, 1902, p. 314.

³ *Folk-lore*, vol. 17, 1907, p. 113.

⁴ K. Minakata (l. c., p. 199) tries to make out finger prints occurring in this work, which seems to me an unwarranted statement. It is there plainly the question of hand impressions only. He states:

"In the novel *Shui hu chuan* examples are given of the use of finger prints, not only in divorce, but also in criminal cases. Thus the chapter narrating Lin Chung's divorce of his wife has this passage: 'Lin Chung, after his amanuensis had copied what he dictated, marked his sign character, and stamped his hand pattern.' And in another place, giving details of Wu Sung's capture of the two women, the murderers of his brother, we read: 'He called forth the two women; compelled them both to ink and stamp their fingers; then called forth the neighbors; made them write down the names and stamp (with fingers).'"

be used as proofs were formerly sealed in this way, a practice to which the word *tegata* (hand shape) still used of such papers remains to testify. Documents are in existence in which Mikados have authenticated their signatures by an impression of their hand in red ink.¹

In the religious beliefs of the Tibetans impressions from the hands and feet of saints play an extensive rôle. These notions were apparently derived with Buddhism from India. In the Himalayan region of southern Tibet the pious believers are still shown foot imprints left by the famous mystic, ascetic, and poet, Milaraspa (1038–1122), and in an attractive book containing his legends and songs many accounts of this kind are given. By "Traces of the Snowshoes" is still designated a bowlder on which he performed a dance and left the traces of his feet and staff, and the fairies attending on the solitary recluse marked the rocks with their footprints.² In the life of the Lama Byams-c'en C'os-rje (1353–1434), who visited China at the invitation of the Emperor Yung-lo (1398–1419), of the Ming dynasty, it is narrated that when he was dwelling on the sacred Mount Wu-t'ai, in Shansi Province, he showed a miracle by kneading a solid, hard blue stone like soft clay and leaving on it an impression of his hand, which astounded all inhabitants of that region.³ The fourth Dalai Lama, Yon-tan rgya-mts'o (1588–1615) produced on a stone the outlines of his foot.⁴ In Tibet I myself had occasion to see, in the possession of a layman, an impression on silk of the hand of the Pan-c'en rin-po-c'e, the hierarch residing at Tashi-lhun-po. At least it was so ascribed to him; but the hand was almost twice as large as an ordinary human hand, and the vermilion color with which it was printed from a wooden block lent it a ghastly appearance. These talismans are sold to the faithful at goodly prices and secure for them the permanent blessings of the sacred hand of the pontifex.

¹ Red ink, as in many Chinese religious ceremonies, evidently is here a metaphorical substitute for blood, and the act of the Mikado retains its purely magical character. H. Spörry (Das Stempelwesen in Japan, p. 18) remarks that the *tegata* is found on ancient documents usually in red, but also in black; it seems that they were chiefly employed on instruments of donations to temples, without having properly the sense and character of a signature. Sheets of white or red paper with the imprint of the left hand of the husband and the right hand of the wife are pasted over the doors of houses as charms against smallpox and other infectious diseases. Giles (*Adversaria Sinica*, No. 6, p. 184) narrates the following story: "A favorite concubine of the Emperor Ming Huang (713–756 A. D.) having several times dreamed that she was invited by some man to take wine with him on the sly, spoke about it to the Emperor. 'This is the work of some magician,' said his Majesty; 'next time you go, take care to leave behind you some record.' That very night she had the same dream; and accordingly she seized the opportunity of putting her hand on an ink slab and then pressing it on a screen. When she awaked, she described what had happened; and on a secret examination being made, the imprint of her hand was actually found in the Dawn-in-the-East Pavilion outside the palace. The magician, however, was nowhere to be seen." In regard to the same woman, Yang Kuei-fei, another anecdote is told to the effect that she once touched the petals of peonies with her fingers dipped into rouge, whereupon the coming year, after the flowers had been transplanted, red traces of her finger prints were visible on the opening blossoms (compare *P'ei wen yüan fu*, ch 71, p. 19).

² Laufer, *Aus den Geschichten und Liedern des Milaraspa*, pp. 2, 16 (*Denkschriften Wiener Akademie*, 1902), and *Archiv für Religionswissenschaft*, vol. 4, 1901, pp. 26, 42.

³ G. Huth, *Geschichte des Buddhismus in der Mongolei*, Vol. II, Strassburg, 1896, p. 196.

⁴ *Ibid.*, p. 245.

The use of the hand in sealing documents is by no means restricted to China and Japan. It occurred as well in western Asia. Malcolm,¹ in describing the conquests of Timur, states:

The officers of the conqueror's army were appointed to the charge of the different provinces and cities which had been subdued, and on their commissions, instead of a seal, an impression of a red hand was stamped; a Tartar usage, that marked the manner in which the territories had been taken, as well as that in which it was intended they should be governed.

The symbolism of the hand is here clearly set forth; it was a political emblem of conquest and subjugation. W. Simpson² received, at Constantinople, the information that in early times when the Sultan had to ratify a treaty a sheep was killed, whereupon he put his hand into the blood, and pressed it on the document as his "hand and seal."³

The foot impressions attributed in India by popular belief to Buddha or Vishnu are well known. They occur, likewise, on the megalithic tombs of western Europe and in petroglyphs of upper Egypt. Likewise the numerous representations of hands in the European paleolithic caves⁴ should be called to mind. Only vague guesses can be made as to their original meaning,⁵ and they may be altogether different from the hand stamps much later in point of time. But these various examples of the occurrence of hand representations in different parts of the world should admonish us to exercise precaution in framing hasty conclusions as to hand impressions leading to finger prints in China. The former occur outside of China where no finger prints are in use, and do not pretend to serve for identification, nor can they answer this purpose. They have a purely religious significance; they may symbolize political power or subjugation or become the emblem of a cult.

K. Minakata, at the suggestion of his friend Teitarō Nakamura, believed that possibly the "finger stamp" was merely a simplified form of the "hand stamp." This view, in his opinion applies equally well to the case of the Chinese, for they still use the name "hand pattern" for the finger print.⁶ This theory is untenable, if for no other reason than that the thumb print, as will be shown by actual archeological evidence, is very much older in China than the hand impression. The two Japanese, however, may have had a correct feeling in this matter which they were unable to express in words,

¹ History of Persia, Vol. I, p. 465.

² *Journal Royal Asiatic Society*, vol. 21, p. 309.

³ The design of a hand is found also on Persian engraved gems of the Sassanian period (226-641 A. D.). See E. Thomas, *Sassanian Mint Monograms and Gems* (*Journal Royal Asiatic Society*, vol. 13, 1852, Pl. 3, No. 61).

⁴ F. Regnault, *Empreintes de mains humaines dans la grotte de Gargas* (*Bulletin et Mémoires Société d'Anthropologie de Paris*, 1906, Vol. 1, pp. 331-2).

⁵ Comp. e. g. G. Wilke, *Südwesteuropäische Megalithkultur*, Würzburg, 1912, p. 148.

⁶ The latter statement is incorrect; the Chinese expression "hand pattern" only means what it implies, an impression taken from the palm, but never a finger print.

or to prove properly. If the finger print has not been evolved from the hand print, nor the latter from the former, there is a certain degree of inward relationship between the two; both are coexisting phenomena resting on a common psychological basis. In order to penetrate into the beginnings and original significance of finger prints, it is necessary to consider another subject, that of seals.

The antiquarian history of Chinese seals begins with the famous seal of the first Emperor Ts'in Shi (B. C. 246-210). This was carved from white jade obtained at Lan-t'ien in Shensi Province and is said to have contained the inscription "Having received the mandate of Heaven, I am in possession of longevity and eternal prosperity." It was, accordingly, the emblem of sovereignty conferred by Heaven on the Emperor.¹ The word *si*,² which had up to that date served for the designation of any seal, was henceforth reserved as the exclusive name of the imperial seal; in other words, a taboo was placed on it. Furthermore the character used in writing this word underwent a change: the symbol for "jade" (*yii*) entering into its composition, together with a phonetic element, was substituted for the previous symbol "earth" (*t'u*). The latter word denotes also clay, so that we are allowed to infer that prior to the time of the jade seal of Ts'in Shi seals were ordinarily made of clay.

The common name for these clay seals is *fêng ni*,³ and they were utilized especially in sealing documents which were written at that time on slips of bamboo or wood. After the age of Emperor Wu (B. C. 156-87) of the Former Han dynasty they fell into disuse, but during his reign they were still employed, as attested by the biographies of the Gens. Chang K'ien and Su Wu. A. Stein⁴ has discovered a large number of such tablets with clay seals attached to them in the ruins of Turkistan. A number of ancient clay seals having been discovered also on Chinese soil, particularly in the provinces of Shensi and Honan, they could not escape the attention of the native archeologists. One of these, Liu T'ie-yün, published at Shanghai in 1904 a small work in four volumes under the title *T'ie-yün ts'ang t'ao*, "Clay Pieces from the Collection of T'ie-yün." These volumes contain facsimiles of a number of clay seals as anciently employed for sealing official letters and packages.⁵ The subject, however, is not investigated, and no identifications of the characters of old script with their modern forms are given. Their decipherment is difficult and remains a task for the future. A few such

¹ E. Chavannes (Les mémoires historiques de Se-ma Ts'ien, vol. 2, pp. 108-110) has recorded the various destinies of this now lost seal, according to the Chinese tradition, down to the T'ang dynasty.

² Giles, Chinese-English Dictionary, Nos. 4143, 4144.

³ Literary references to them are scarce; some notes regarding them are gathered in the cyclopedia *Yen Kien lei han*, ch. 205, p. 36.

⁴ Ancient Khotan, Oxford, 1907, Vol. 1, p. 318.

⁵ Laufer, Chinese Pottery, p. 287, and Chavannes in *Journal asiatique*, vol. 17, No. 1, 1911, p. 128.

clay seals secured by me at Si-ngan fu are likely to furnish an important contribution to the early history of the finger-print system.

The seal was considered in ancient China as a magical object suitable to combat or to dispel evil spirits, and the figures of tigers, tortoises, and monsters by which the metal seals were surmounted had the function of acting as charms. We read in Pao-p'o-tse ¹ that in olden times people traveling in mountainous regions carried in their girdles a white seal 4 inches wide, covered with the design of the Yellow Spirit and 120 characters. This seal was impressed into clay at the place where they stopped for the night, each of the party made 100 steps into the four directions of the compass, with the effect that tigers and wolves did not dare approach. Jade boxes, and even the doors of the palaces, were sealed by means of clay seals to shut out the influence of devils. Numerous are the stories regarding Buddhist and Taoist priests performing miracles with the assistance of a magical seal.

On plate 4 six such clay seals from the collection of the Field Museum are illustrated. The most interesting of these is that shown in figure 2, consisting of a hard, gray baked clay, and displaying a thumb impression with the ridges in firm, clear, and perfect outlines, its greatest length and width being 2.5 cm. It is out of the question that this imprint is due to a mere accident caused by the handling of the clay piece, for in that case we should see only faint and imperfect traces of the finger marks, quite insufficient for the purpose of identification. This impression, however, is deep and sunk into the surface of the clay seal and beyond any doubt was effected with intentional energy and determination. Besides this technical proof there is the inward evidence of the presence of a seal bearing the name of the owner in an archaic form of characters on the opposite side. This seal, 1 cm. wide and 1.2 cm. long, countersunk 4 mm. below the surface, is exactly opposite the thumb mark, a fact clearly pointing to the intimate affiliation between the two. In reasoning the case out logically, there is no other significance possible than that the thumb print belongs to the owner of the seal who has his name on the obverse and his identification mark on the reverse, the latter evidently serving for the purpose of establishing the identity of the seal. This case, therefore, is somewhat analogous to the modern practice of affixing on title deeds the thumb print to the signature, the one being verified by the other. This unique specimen is the oldest document so far on record relating to the history of the finger-print system. I do not wish to enter here into a discussion of the exact period from which it comes down, whether the Chou

¹ Surname of the celebrated Taoist writer Ko Hung who died around 330 A. D., at the age of 81.

period or the Former Han dynasty is involved; this question is irrelevant; at all events it may be stated confidently that this object, like other clay seals, was made in the pre-Christian era. An examination of other pieces may reveal some of the religious ideas underlying the application of the thumb print. Many clay seals are freely fashioned by means of the finger and exhibit strange relations to these organs. The finger shape of the two seals in figures 6 and 7 on plate 4 is obvious. Our illustration shows the lower uninscribed sides, while the name is impressed by means of a wooden mold on the upper side. Examination of these two pieces brings out the fact that they were shaped from the upper portion of the small finger, and further from the back of the finger. The lower rounded portion of the object in figure 7 is evidently the nail of the small finger which was pressed against the wet clay lump; the seal has just the length of the first finger joint (2.6 cm. long), the clay mold follows the round shape of the finger, and the edges coiled up after baking. The lines of the skin, to become visible, were somewhat grossly enlarged in the impression. The clay seal in figure 6 (2.4 cm. long), I believe, was fashioned over the middle joint of the small finger of a male adult, the two joints at the upper and lower end of the seal being flattened out a little by pressure on the clay, and the lines of the epidermis being artificially inserted between them. The seal in figure 5, of red-burnt clay, with four characters on the opposite side (not illustrated), was likewise modeled from the bulb of the thumb by pressure of the left side against a lump of clay which has partially remained as a ridge adhering to the surface. The latter was smoothed by means of a flat stick so that no finger marks could survive. The groove in the lower part is accidental. Another square clay seal in our collection (No. 117032) has likewise a smoothed lower face, but a sharp mark from the thumb nail in it. These various processes suffice to show that the primary and essential point in these clay seals was a certain sympathetic relation to the fingers of the owner of the seal. Here we must call to mind that the seal in its origin was the outcome of magical ideas, and that, according to Chinese notions, it is the pledge for a person's good faith; indeed, the word *yin*, "seal," is explained by the word *sin*, "faith."¹ The man attesting a document sacrificed figuratively part of his body under his oath that the statements made by him were true, or that the promise of a certain obligation would be kept. The seal assumed the shape of a bodily member; indeed, it was immediately copied from it and imbued with the flesh and blood of the owner. It was under the sway of these notions of magic that the mysterious, unchangeable furrows on the finger bulbs came into prominence and received their importance. They not

¹ In the work *T'ie yün ts'ang P'ao*, p. 85b, above quoted, is illustrated a clay seal containing only this one character. The same book contains also a number of finger-shaped clay seals.

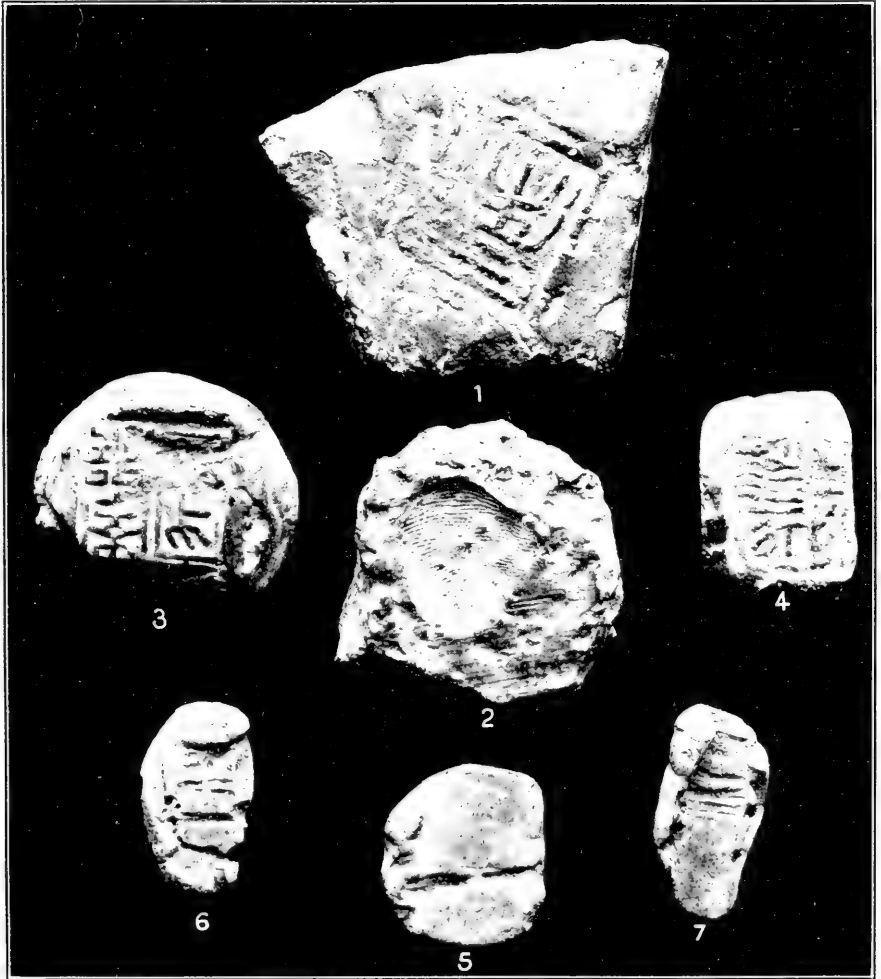

ANCIENT CHINESE CLAY SEALS. THE ONE IN FIG. 2 SHOWING THUMB-IMPRESSON ON THE REVERSE. THOSE IN FIGS. 6 AND 7 BEING MOLDED FROM THE SMALL FINGER.



INK-SKETCH BY KAO K'I-FEI, EXECUTED BY MEANS OF THE FINGER-TIPS.



INK-SKETCH BY KAO K'IP'EI, EXECUTED BY MEANS OF THE FINGER-TIPS.



INK-SKETCH BY YO YU-SUN, EXECUTED BY MEANS OF THE FINGER-TIPS.

only contributed to identify an individual unmistakably but also presented a tangible essence of the individuality and lent a spiritual or magical force to the written word.

Finally, I should like, in this connection to call attention to a peculiar method of painting practiced by the artists of China, in which the brush is altogether discarded and only the tips of the fingers are employed in applying the ink to the paper. This specialty is widely known in China under the name *chi hua*, which literally means "finger painting," and still evokes the highest admiration on the part of the Chinese public, being judged as far superior to brush painting. The first artist to have cultivated this peculiar style, according to Chinese traditions, was Chang Tsao, in the eighth or ninth century, of whom it is said that "he used a bald brush, or would smear color on the silk with his hand."¹ Under the Manchu dynasty, Kao K'i-pei, who lived at the end of the seventeenth and in the first part of the eighteenth century, was the best representative of this art. "His finger paintings were so cleverly done that they could scarcely be distinguished from work done with the brush; they were highly appreciated by his contemporaries," says Hirth. On plates 4 and 5 two ink sketches by this artist in the collection of the Field Museum are reproduced. Both are expressly stated in the accompanying legends written by the painter's own hand to have been executed with his fingers. The one representing two hawks fluttering around a tree trunk is dated 1685; the other presents the reminiscence of an instantaneous observation, a sort of flashlight picture of a huge sea fish stretching its head out of the waves for a few seconds and spurting forth a stream of water from its jaws. The large monochrome drawing shown on plate 6—cranes in a lotus pond by Yo Yu-sun—is likewise attested as being a finger sketch (*chi mo*), and the painter seems to prove that he really has his art at his fingers' ends. Hirth is inclined to regard this technique "rather a special sport than a serious branch of the art," and practiced "as a specialty or for occasional amusement." There was a time when I felt tempted to accept this view, and to look upon finger painting as an eccentric whim of the virtuosos of a decadent art who for lack of inner resources endeavored to burn incense to their personal vanity. But if Chang Tsao really was the father of this art, at a time when painting was at the culminating point of artistic development, such an argument can not be upheld. I am now rather disposed to believe that the origin of finger painting seems to be somehow linked with the practice of finger prints, and may have received its impetus from the latter. The relationship of the two terms is somewhat significant; *hua chi*, "to paint the finger," as we saw above

¹ H. A. Giles, *An Introduction to the History of Chinese Pictorial Art*, p. 61. F. Hirth, *Scraps from a Collector's Note Book*, p. 30.

in the passage quoted from Kia Kung-yen, is the phrase for "making a finger impression" in the T'ang period, and the same words reversed in their position, *chi hua*, mean "finger painting" or "painted with the finger." It seems to me that also in finger painting the idea of magic was prevalent at the outset, and that the artist, by the immediate bodily touch with the paper or silk, was enabled to instill part of his soul into his work. Eventually we might even go a step farther and make bold to say that finger painting, in general, is a most ancient and primitive method of drawing and painting, one practiced long before the invention in the third century B. C. of the writing brush of animal hair, and the older wooden stylus. The hand, with its versatile organs of fingers, was the earliest implement utilized by man, and the later artistic finger painting might well be explained as the inheritance of a primeval age revived under suggestions and impressions received from the finger-print system.

URBANISM: A HISTORIC, GEOGRAPHIC, AND ECONOMIC STUDY.¹

By PIERRE CLERGET,

Professor at the High School of Commerce, Lyon, France.

I. ANCIENT CITIES.

"We should not have the idea of ancient cities," writes Fustel of Coulanges, "that we have of those we see built in our day. A few houses are erected and that is a village; the number of houses is gradually increased and it becomes a city; and we finish it, if there be room, by surrounding it with a moat and a wall. Among the ancients a city was not formed in course of time by a slow increase in the number of inhabitants and buildings, but they constructed it at once, complete almost in a day."² The first need of the founder was to choose a site for the new city, but the choice was always left to the decision of the gods. Around the altar, which became the shrine of the city, were built the houses, "just as a dwelling is erected around the domestic fireside." The boundary, traced according to a religious rite, was inviolable. This ceremony of founding the city was not forgotten, and each year they celebrated its anniversary. Every ancient city was first of all a sanctuary.

Rome, in particular, was created in that way. One of the remarkable traits of her politics was that she attracted to herself all the cults of conquered peoples, and this was the chief way through which she succeeded in increasing her population. She brought to herself the inhabitants of conquered cities and little by little she made Romans of them, each of them being permitted to exercise his cult; this liberty was enough to retain them there.

At a time when statistics were unknown we are left, by lack of accurate figures, to rely for information upon some very uncertain and probably exaggerated estimates by ancient historians. Beloch, cited by M. de Foville, gives 800,000 inhabitants to Rome in the reign of Augustus; Young estimates Carthage under the Empire at 700,000; Schmoller gives 600,000 to 700,000 inhabitants to ancient

¹ Translated, by permission, from *Bulletin de la Société Neuchateloise de Géographie*, vol. 20, 1909-10, pp. 213-231. Neuchatel, Switzerland, 1910.

² Fustel de Coulanges: *La cité antique*, 17^{me} édit, Paris, Hachette, 1900, p. 151.

Alexandria, 600,000 to Seleucia, and 100,000 to Antioch and Pergamis.

In Greece the origin of cities was due to the same religious motive, but "the topography of the country, the characteristics of the race, the social and political status, all united in turning that country toward trades and manufactures, commerce, navigation, colonization, and everywhere gave birth to cities which, like Miletis, Chalcis, Corinth, Ægina, and later, Athens, found in the new ways, riches and fame. It produced there, in brief, from the seventh to the fourth centuries before Christ, a phenomenon comparable to what we see to-day among modern peoples."¹ In Greece it was chiefly through slavery that the cities increased in their way the number of inhabitants. It was Chios, a maritime city, that first introduced foreign slaves among them. Its example was imitated by cities which had like needs, and there was thus organized "a steady stream of immigration, which brought from all the Orient into Greece an abundance of workmen."² The population of ancient cities also included a great number of foreigners (métèques) who, having abandoned their native land with no hope of return, consecrated themselves to the trades and to commerce. At Athens, toward the end of the fifth century before Christ, the métèques and the freedmen reached the number of 100,000, as opposed to 120,000 citizens. Prosperity was then directly proportionate to the abundance of handwork, for the arm was the only force employed; but from the day when work and money failed them the cities decreased in population. Such was Greece during the second and first centuries before Christ. "Thebes," writes Strabo, "was only a market town and the other cities of Bœotia showed the same decline."

Before the Mediterranean epoch, where the principal seats of civilization were represented simultaneously or in turn by the great oligarchies, Phenician, Carthaginian, Greek, and Italian—and we might repeat for Tyre and Carthage what we have said of Grecian cities—were placed the four great civilizations of high antiquity which all flourished in navigable regions. "Hoangho and Yangtze-Kiang," writes L. Metchnikoff, "flowed through the primitive domain of Chinese civilization; Vedique, India, was likewise cut by the basins of the Indus and the Ganges; the Assyro-Babylonian monarchies spread over a vast country of which the Tigris and the Euphrates formed the two vital arteries; Egypt, finally, as Herodotus has said, was a gift, a present, a creation, of the Nile."³ From Nineveh, on the Tigris, Assyrian civilization was carried to Babylon

¹ Paul Guiraud: *Études économiques sur l'antiquité*. Paris, Hachette, 1905, p. 127.

² Paul Guiraud, *op. cit.*

³ Léon Metchnikoff, *La civilisation et les grands fleuves historiques*. Paris, Hachette, 1889.

on the Euphrates, to return to Seleucia on the Tigris. Even to-day all the rivers bring together the most intense economic life.

M. Paul Mougeolle has with reason remarked that at each successive period of the general history of the Western Empire the principal centers of civilization have extended farther and farther from the Tropics toward the polar circle.² This is shown by the following table:

FIRST PERIOD.

	North latitude.	Inhabitants.		North latitude.	Inhabitants.
Thebes.....	25 43	(2,400)	Our.....	36 64
Memphis.....	30 00	(800)	Susa.....	32 00	(71)
Meroe.....	17 00	Babylon.....	32 30	(50,000)
			Nineveh.....	36 16	(742)
Average.....	24 14	Average.....	32 57

SECOND PERIOD.

	North latitude.	Inhabitants.		North latitude.	Inhabitants.		North latitude.
Tyre.....	33 16	(57)	Carthage.....	37 36	(2,800)	Cordova.....	37 52
Athens.....	37 58	(196)	Rome.....	41 54	(1,188)	Toledo.....	39 53
Byzance.....	41 00	Florence.....	43 57		
Average.....	37 24	Average.....	41 6	Average.....	38 52

THIRD PERIOD.

	North latitude.	Inhabitants.		North latitude.	Inhabitants.		North latitude.
Paris.....	48 50	(7,802)	Vienna.....	48 13	(7,200)	Stockholm.....	59 21
London.....	51 31	(30,500)	Berlin.....	52 31	(6,300)	St. Petersburg.....	60 00
Average.....	50 10	Average.....	50 22	Average.....	59 41

In many ancient cities agriculture surpassed industrial and commercial activities. Everywhere within the ancient cities were found common pasturage lands, as at Palmyra, and it was the same in many old medieval cities in France (Douai, Amiens, Aurillac, Dole, etc.), in England, in Germany, and in Italy. Not only were the inhabitants of the cities agriculturists, possessing fields outside the cities, but urban space itself was in great part under cultivation. The ancient writings make frequent mention of wide cultivated tracts or of agricultural undertakings. These are chiefly gardens and vineyards, but mention of arable fields are not rare. Sometimes these cultivated tracts serve to separate the various quarters of the

² Paul Mougeolle: Statique des civilisations. Paris, 1883.

city and are an indirect proof of the village origin of the dwellers there.¹

Among ancient peoples war was often a chronic condition and strifes occurred even within the cities. In Rome rivalries between the several quarters led Mommsen to say that the city was an assemblage of small urban communities rather than a city aggregated in a single body. Each part of the city was fortified as much against other parts as against the common enemy. In Babylon temples and palaces each formed a fortress within the city. At Rheinfelden strifes were frequent between the city and the chateau.²

II. CITIES OF THE MIDDLE AGES.

Medieval Europe never had cities as great as those of antiquity. The population was more widely scattered and the causes of concentration which prevailed in the nineteenth century did not yet exist. Up to the year 1400, Cologne and Lubeck, in Germany, alone exceeded about 30,000 inhabitants. Burckhardt gives 90,000 citizens to Florence in 1338 and 190,000 to Venice in 1422, although M. de Foville thinks those figures are too great. Schmoller estimates 50,000 to 60,000 inhabitants in Bruges and Gand toward the end of the Middle Ages, and Antwerp, in the sixteenth century, had about 200,000 population. England for a long period had few cities. In 1377 London numbered 30,000 to 40,000, York 11,000, Bristol, 9,500, Coventry 7,000, and at the end of the seventeenth century only two provincial cities, Norwich and Bristol, approached 30,000 inhabitants, the others remaining below 10,000.

As to-day in certain new countries, such as Australia and Argentina, so the cities of antiquity were formed of "heads disproportioned to the bodies," and the rural element was not necessarily important. But this lack of equilibrium in the "social body" did not exist in the Middle Ages, the land commenced to be colonized and improved; slavery no longer existed, and serfdom attached to the land. The difficulty of communication checked the currents of immigration, formerly rendered easy by the sea. The market, during the greater part of that period, was the nucleus of the city, except when it had its origin in some towns of the Gauls, or from some Roman communities. In many cases the urban right was one of the forms of royal or seigniorial concessions for markets and it served to keep the population in a place granted. Bruges, Gand, Tournai, Valenciennes, etc., are purely economic creations from market centers.³

¹ René Maunier. *L'origine et la fonction économique des villes. Étude de morphologie sociale.* Paris, Girard et Brière, 1910, p. 73-80.

² René Maunier. *Op. cit.*, p. 123.

³ Cf. J. Flach, *Les origines de l'ancienne France*, vol. 2, p. 301-350. Georges Bourgin, *Les origines urbaines du moyen âge.* *Revue de synthèse historique*, December, 1903.

Cities were built either around some old Roman camp or at the crossing of a river, or around a church, an abbey, or fortified chateau. The plan differed according to the origin, and extension was made irregularly, following the topography, or concentrically around one or many centers.

Paris, the ancient Lutèce, began on the Ile de la Cité. Although that place, covered with a bed of muddy alluvia, was not at all suited for habitation, yet it was an island well located and specially favorable for defense, being a direct extension of a natural stretch of land. The right bank of the river being only an inhospitable marsh, Paris extended first along on the left bank and climbed up Mount St. Geneviève. But it is the river after all that continues to dominate the city, thanks to the "Corporation des Nautes." The invasion of the Barbarians reenforced its defense; the fortified city gained in importance. The Francs came, were converted, and Christianity began in earnest the transformation whence emerged the Paris of the Middle Ages and of modern times. Capital of France, she grew up with regal power.¹

Year.	Reign.	Inhabitants.
363.....	Julien.....	8,000
510.....	Clovis.....	30,000
1220.....	Philippe-Auguste.....	120,000
1328.....	Philippe VI.....	250,000
1596.....	Henry IV.....	230,000
1675.....	Louis XIV.....	540,000
1788.....	Louis XVI.....	599,000
1801.....	Consulate.....	548,000
1817.....	Louis XVIII.....	714,000
1831.....	786,000
1851.....	1,053,000
1856.....	1,174,000
1861.....	1,696,000
1866.....	1,825,000
1872.....	1,794,000
1876.....	1,989,000
1886.....	2,345,000
1906.....	2,763,000

In the Middle Ages wars were frequent, and cities sought, above everything, positions for defense; but after they had built up the heights, settlements were made in the plain when relative peace prevailed attracted by the presence of water and fields for cultivation. The city was often made up of two distinct elements: One inhabited by soldiers and agriculturists, the other by merchants. "The Flemish city," writes M. Pirenne, "was made by joining a

¹ Marcel Poëte: *L'enfance de Paris*. Paris, Colin, 1908. The population attributed to Paris at successive periods is as follows:

fortress and a market place, a castrum and a portus." This method prevailed in the most varied civilizations, in ancient cities as well as in the medieval cities of France, Germany, England, and Italy.¹ The city of Ratisbonne, for example, was formed of three parts. The first contained the palace of the King and some convents (regius pagus, or royal district); the second included the court of the clergy, two convents, and some merchants (pagus cleri, or priestly district); these two parts together comprised the old city (antiqua urbs). The third part, or new city, was inhabited by the merchants and artisans (pagus mercatorum, or mercantile district). Military needs demanded places easy for defense, some strategic points whence they could command the surrounding region; while for economic purposes there was needed easy communication, suitable for commercial activities. Now, as M. René Maunier remarks, the same regions very often have all these diverse qualities, for example, the centers and the boundaries for geographic units. An intersection of roads answers best for both needs. It was for this reason that Erfurt, a military center at the crossroads of Thuringia, very quickly became a center of commerce. Ratzel had before observed that in every geographical unit life is especially developed within these limits. Commercial business is attracted by the frontiers, and to-day industries are spread out on the city boundary; maritime ports are more and more growing to be industrial centers.

In the city of the Middle Ages industrial activity was limited to local needs; it was the system of city economy to which would later succeed national economy. Some special markets were given up each to a particular product; trades permanently occupied certain streets to which they gave their name. You still find this same custom in cities of the Orient and in Morocco. This grouping of trades is easily explained either by technical or hygienic causes still existing in some cities, such as the necessity that tanners and dyers be near some water, that ropemakers be near some walls, or by legal requirements, such as city tax and regulations imposed on the corporation, and the localization of trades, whereby the authorities maintain competition and render easier the control of merchandise.² In another case the trades have not all come at the same time, but have been successively engaged in promoting the extension of the city. Finally, the professional group is not only an economic factor, but it is often still, according to M. René Maunier, a society, a brotherhood, which constitutes in its membership a real community of life and which requires that they be near together.

In proportion as the city is developed, the trades would be multiplied and decentralized, they would follow the consumers and be dispersed with them; then, when the city ceases to be their chief market, new

¹ René Maunier, *op. cit.*, pp. 103-151.

² René Maunier, *op. cit.*, p. 217.

industries are established on the boundary and even outside the city. Berlin has, in this way, developed industrial establishments directly dependent upon that city covering a radius of 100 kilometers. There is also a financial reason for this spreading out, and that is the decrease in average location values from the center toward the boundary.

III. URBANISM IN THE NINETEENTH CENTURY.

(a) GEOGRAPHICAL SITUATION.

The formation of centers of population and of ways of communication which unite them is determined at once by conditions dependent on man, based on the degree of culture and on political considerations and by certain natural conditions, such as the richness and lay of the land as well as to other factors connected with the climate.¹ The influence of latitude is very marked. If you look at the annual average isotherms on a map, you will see that the most important city aggregations of the Northern Hemisphere are grouped chiefly between the extreme limits of 16° C. (60° F.) (St. Louis, Lisbon, Genoa, Rome, Constantinople, Shanghai, Osaka, Kioto, etc.), and 4° C. (40° F.) (Quebec, Christiania, Stockholm, St. Petersburg, etc.). The isotherm 10° C. (50° F.) represents accurately enough the central axis of this zone, within which are found Chicago, New York, London, Vienna,² etc. The Tropical Zone includes only 24 cities of more than 100,000 inhabitants, 15 of which are in Asia, 6 in America, 2 in Oceanica, and 1 in Africa.

High altitudes, like extreme temperatures, diminish populations, which disappear completely at a certain limit. In Europe the inhabited centers only exceptionally exceed an altitude of 1,500 meters (5,000 feet). But in the Tropical Zone it is natural that populations seek high altitudes so as to profit by the lowering of the temperature and to derive benefit from a temperate climate. In Abyssinia, the inhabited zone is almost entirely included between 1,800 and 2,500 meters altitude. Sana, in Arabia, is 2,150 meters high; Teheran (250,000 population) is at a height of 1,230 meters. In Tibet, Lassa is 3,560 meters high and Chigatze 3,620 meters. From Mexico to Chile, aside from some ports on the ocean, in nearly every instance you must seek above 2,000 meters for the most important cities. Mexico City at 2,300 meters numbers more than 300,000 inhabitants; Quito, with 80,000 inhabitants, is 2,850 meters high; La Paz, with 63,000 inhabitants, 2,700 meters; and Potosi, with 16,000 inhabitants, is at an elevation of 4,000 meters³ (13,000 feet).

¹ E. Cammaerts. J.-G. Kohl et la géographie des communications. Bulletin de la Société royale belge de géographie, 1904.

² L. Metchnikoff, op. cit.

³ Louis Gobet. Les grandes villes de la terre situées au-dessus de 2,000 m. Revue de Fribourg, 1903, p. 45-60. In Europe the great aggregations are all below 200 meters: Berlin, 25 m., Paris, 26 m., Vienna, 157 m., etc.

The site plays a rôle not less important than the general geographical position. You can consider this from a triple point of view: From topographical location, situation in relation to means of communication, and geological composition. The topographical point of view is sometimes of great importance, as when the city must first of all think of means of defense; it is preferable to look for heights. What is of chief importance to-day is facility for construction and for expansion; land flat and solid, and extended enough. We will return now to a study of the plan of cities. The general situation certainly precedes the local site. The locating of manufacturing establishments is dependent on the locating of means of communication. The great cities are situated on the banks of rivers, of lakes, or seas;¹ they have sprung up along railway lines; their development is dependent on the importance of the circulation; when that is turned aside the city is ruined (Le Cap). According to its geological constitution, a city exerts its influence either through the presence of fertile soil, suited to agriculture, or by the presence of mineral wealth, coal or metallic ores, which have promoted the creation of great industrial cities.

(b) HUMAN FACTORS.

Urbanism is a phenomenon of great complexity which can be simplified only at the expense of very close study. An examination of geographical conditions is necessary but will not alone suffice. Human factors play a considerable rôle not only in the past, as we have already seen, but even more in the present. Very large cities arose during the nineteenth century. In 1801 there were in Europe, according to M. Paul Meuriot,² only 21 centers with more than 100,000 inhabitants; 22, perhaps, with Constantinople.

POPULATION OF THE PRINCIPAL CITIES OF EUROPE IN 1801.

Great Britain and Ireland: London, 958,000; Dublin, 140,000; Edinburgh, 85,000; Liverpool, 82,000; Manchester, 76,000; Birmingham, 70,000; Bristol, 61,000; Leeds, 53,000.

France: Paris, 548,000; Marseille, 111,000; Lyon, 109,000; Bordeaux, 91,000; Rouen, 87,000; Nantes, 73,000; Lille, 54,000; Toulouse, 50,000.

Belgium: Brussels, 66,000; Antwerp, 62,000; Gand, 56,000; Liege, 50,000.

Holland: Amsterdam, 215,000; Rotterdam, 50,000; The Hague, 38,000.

Germany: Berlin, 172,000; Hamburg, 100,000; Dresden, Breslau, and Königsberg, 60,000; Cologne, 50,000.

Austria and Hungary: Vienna, 231,000; Prague, 70,000; Budapest, 54,000; Lemberg, 48,000.

Italy: Naples, 350,000; Rome, 170,000; Milan, 170,000; Venice, 150,000; Palermo, 120,000.

¹ Of 28 cities of over 100,000 inhabitants according to the census of 1891, 14 are ports.

² Paul Meuriot. Des agglomérations urbaines dans l'Europe contemporaine. Essai sur les causes, les conditions, les conséquences de leur développement. Paris, Berlin, 1897.

Spain: Madrid and Barcelona more than 100,000.

Portugal: Lisbon, more than 100,000.

Russia: St. Petersburg, Moscow, Varsovie, more than 100,000.

In 1850 the number of cities over 100,000 inhabitants had increased to 42 (3.8 per cent of the total population); to 70 (6.6 per cent) in 1870; to 121 (10 per cent) in 1895; to 160 at the opening of the twentieth century. In 1900, 23 cities exceeded 500,000 inhabitants, 6 numbered a million each.

NUMBER OF EUROPEAN CITIES OF MORE THAN 100,000 INHABITANTS, AND POPULATIONS OF THOSE EXCEEDING 250,000.

Great Britain (1907): 38 cities of more than 100,000, of which 14 exceeded 250,000, as follows: London, 4,758,000 (registration London) or 7,218,000 for Greater London; Glasgow, 848,000; Liverpool, 746,000; Manchester, 643,000; Birmingham, 553,000; Leeds, 470,000; Sheffield, 455,000; Bristol, 368,000; Edinburgh, 346,000; West-Ham, 308,000; Bradford, 290,000; Newcastle, 273,000; Kingston-upon-Hull, 267,000; Nottingham, 257,000.

Ireland (1901): 2 cities of more than 250,000; Dublin, 373,000; Belfast, 350,000. All the others less than 100,000.

France (1906): 15 cities more than 100,000, of which 4 exceed 250,000, as follows: Paris, 2,763,000; Marseille, 517,000; Lyon, 472,000; Bordeaux, 252,000.

Belgium (1906): 4 cities of more than 100,000, of which 2 exceed 250,000, as follows: Brussels, 623,000 (with its faubourgs); and Antwerp, 304,000.

Holland (1906): 4 cities of more than 100,000, of which 2 exceed 250,000, as follows: Amsterdam, 564,000; Rotterdam, 390,000; and The Hague, 249,000.

Germany (1905): 41 cities of more than 100,000, of which 11 exceeded or reached 250,000, as follows: Berlin, 2,040,000; Hamburg, 803,000; Munich, 539,000; Dresden, 517,000; Leipzig, 504,000; Breslau, 471,000; Cologne, 429,000; Frankfurt, 335,000; Nuremberg, 294,000; Dusseldorf, 253,000; Hanover, 250,000.

Austria-Hungary: 9 cities of more than 100,000, of which 2 exceed 250,000, as follows: Vienna, 2,000,000 (in 1907); and Budapest, 732,000 (in 1900).

Switzerland: 3 cities of more than 100,000—Zurich, Bâle, and Geneva—but none reaching 250,000.

Italy (1901): 11 cities of more than 100,000, of which 5 exceed 250,000, as follows: Naples, 564,000; Milan, 493,000; Rome, 463,000; Turin, 336,000; Palermo, 310,000.

Spain (1900): 7 cities at least 100,000, of which 2 exceed 250,000, as follows: Madrid, 540,000; and Barcelona, 533,000.

Portugal (1900): 2 cities of more than 100,000, of which 1 exceeds 250,000, namely, Lisbon, 356,000.

Greece (1906): 1 city of 170,000 (Athens). All the others less than 100,000.

Turkey in Europe (recent figures): 2 cities of more than 100,000, 1 of which exceeds 250,000, namely, Constantinople, 1,106,000.

Roumania (1899). 1 city of 270,000 (Bukarest). All the others less than 100,000.

Russia in Europe (1900-1907): 14 cities of more than 100,000, of which 7 exceed 250,000, as follows: St. Petersburg, 1,429,000 (in 1905); Moscow, 1,359,000 (in 1907); Varsovie, 756,000 (in 1901); Odessa, 450,000 (in 1900); Lodz, 352,000 (in 1900); Kiew, 319,000 (in 1902); Riga, 282,000.

Finland (1905): 1 city of 117,000 (Helsingfors).

Denmark (1906): 1 city of 514,000 (Copenhagen) with its faubourgs. All the others less than 100,000.

Sweden (1906): 2 cities of more than 100,000, of which 1 only exceeds 250,000 (Stockholm), 333,000.

Norway (1900): 1 city of 228,000 (Christiania). All the others less than 100,000.

In France, from 1846 to 1906, the population of the centers of more than 2,000 inhabitants rose from 24.4 per cent to 42.1 per cent. In England, according to J. James, in 1850 the rural balanced with the city population;¹ in 1901 the rural population represented only 23 per cent of the total. In the United States, according to the same author, the population of cities of more than 8,000 inhabitants rose from 3.35 per cent in 1790 to 29.20 per cent in 1890. From 1870 to 1895 the population of Europe had increased 20 per cent; that of cities of more than 100,000 inhabitants 52 per cent. For each 1,000 inhabitants of our continent you can reckon 15 in the large cities in 1800, 34 in 1850, 63 in 1870, and 100 in 1895. In 1800 there was one city of more than 100,000 inhabitants for each 450,000 square kilometers, in 1870 one for 134,000, in 1895 one for 75,000 (P. Meuriot).

Among the human factors of urbanism during the nineteenth century must be noted first of all the decrease in the number of wars, particularly since 1815; the abolition of serfdom which has freed man from the land; the increasing multiplication of state offices and of public functionaries, obligatory military service, and parceling of the land. Intensive culture and employment of machines have contributed to rural exodus, encouraged in another way by intense industrial development, made possible by the introduction of water power and the employment of steam. It is in England and Germany, the two most industrial countries of Europe, that the number and the population of urban communities have made the most progress in the last quarter of a century. Nearly one-fourth of the population of Germany lives in cities of more than 20,000 inhabitants. The Kingdom of Saxony and Rhenish Prussia are great centers of growth and attraction for the Empire. Manufactures concentrate the population, nevertheless the high cost of living in cities, the ease and quickness of communications, and the recent employment of water power commences to work to the contrary. Trade, like manufactures, concentrates population; the market helps to keep the workman in the city, and all commercial organizations are established in great centers. You may say that these are developed through the requirements of trades. Besides, commercial needs attract manufactures, and the latter often changes with the port or simply with the market. It is for this reason that ports become more and more industrial cities.

It is chiefly through migrations that cities are developed. According to M. Levasseur, the attractive force of human groups is in gen-

¹ J. James. The growth of great cities in area and population. American Academy of Political and Social Science, January, 1899.

eral proportionate to the mass. This explains why some cities¹ number millions.

Immigration to cities is seasonal, as in the case of house builders, though more often it is permanent, with the intention of staying for a considerable period, but retaining the hope of return to the modest provincial country. As a general rule, the attraction toward the city is inversely proportional to the distance and to the comparative ease of the home life of the emigrants. According to M. Paul Meuriot, the attractive force of Paris is exerted chiefly over a radius of about 250 kilometers. In London the proportion of inhabitants furnished by each region or county is also naturally inverse to their distance from the metropolis. The immigration to Berlin is mostly Prussian. In France the provincial centers become more and more important and divert to their profit a part of the emigration in their region, but the superior forces of administrative centralization favor and develop the exodus toward the capital.²

Emigrants tend to group themselves. These groups are chiefly by professions in the Provinces; but they are by nationalities in the great cosmopolitan cities, such as New York, where there is a Jewish quarter, an Italian quarter, a Chinese quarter. Societies for recreation or for benevolent purposes are organized among emigrants of the same section or the same nationality.

M. P. Meuriot has stated that formerly the name "city" was based less on the number of inhabitants than on the leading features and the special advantages of the communities. In France, in England, and in Germany the title "city" is chiefly reserved for those groups which have had a particular political position. On the other hand, every community called rural is not necessarily agricultural, but is supported sometimes by manufactures. Inversely, the great markets are only agricultural communities. Rural grouping is characterized chiefly by a uniformity in methods of living, while the rule of city grouping is the diversity of life.

(e) EXTERIOR CHARACTER OF CITIES.

The growth of cities has first of all caused the disappearance of the walls which formerly surrounded nearly all of them. Their rural aspect has disappeared, notwithstanding the frequent presence of vacant land within their limits. The presence of factories

¹ Proportion of native population of cities: London (1891), 68 per cent; Vienna (1890), 44.7 per cent; Berlin (1890), 41 per cent; St. Petersburg (1890), 31.7 per cent; Paris (1891), 35.4 per cent. Compare A. F. Weber. The growth of the cities in the nineteenth century. A study in statistics. London, Kuip, 1899.

² In 1901, in a population of 2,714,064, Paris had 1,394,000 provincials, and in its 20 districts or wards only one, the twentieth, showed a majority of Parisians. The native departments of the emigrants were, in order of importance: Seine-et-Oise, 99,644; Seine-et-Marne, 57,915; Nord, 51,750; Nièvre, 51,065; Jonne, Loiret, Seine-Inférieure, Aisne, Cher, Creuse, Saône-et-Loire, Cantal, Aveyron, Côtes-du-Nord, Ille-et-Villaine, etc.

has been the principal cause for the creation of outskirts and suburbs of an extensive character. Density of population is generally greater in the center than on the outskirts, but as the dwellings and the lands are more valuable there, an inverse movement has begun, encouraged, too, by hygiene, for the air is better at the boundary than at the city center.

The direction of extension depends chiefly on geographic and economic conditions, and cities spread out much more rapidly when these conditions are favorable. Bound between natural insurmountable obstacles, the sea or rivers, cities push skyward, as in New York,¹ where one sees buildings erected from 30 to 40 stories high. But if there are no constraints for looking in any other direction for space needed for their development the advance is preferably toward the west. The prevailing direction of winds from the west, driving back unhealthy odors toward the east, render westerly sections more healthy. Paris and London offer examples of this phenomenon. The public square is no longer the stage for enacting the leading scenes of public life; its rôle is to relieve monotony, to provide more air and light. The market square still exists, but it tends more and more to be replaced by closed markets. They are hardly anything else in the south of Europe, especially in Italy, where the squares still conform to the old type. According to M. C. Sitte, experience shows that the minimum dimension of a public square should be equal to the height, and its maximum should not exceed double the height of the principal edifice, but there must equally be taken into account the width of the adjoining streets.²

THE STREET.

Streets are sometimes so narrow and lateral, roads so few, that the way becomes a closed place, very agreeable to the esthetic eye. Their winding constantly shuts out the perspective, and at each instant presents a new horizon. The straight street prevails to-day, particularly in new cities, such as those in America, where the streets cross at right angles, so as to form a regular draught board. The effect produced depends on the proper proportion between the width of the street and the height of the buildings, and also on the architecture of the structures.

OPEN SPACES AND GRASS PLOTS.

Hygiene is more and more occupying the attention of municipalities of large cities. One notes that in Paris, for example, the mortality from tuberculosis diminishes in proportion to the extent

¹ Compare Pierre Clerget. *Villes et écoles américaines*. Revue de Fribourg, March-April, 1906.

² Camillo Sitte, *L'art de bâtir les villes*. Translation and adaptation by C. Martin, Geneva. Emile Magne, *L'esthétique des villes*. Paris, Mercure de France, 1908. K. Kahn, *L'esthétique de la rue*. Paris, Fasquelle, 1901.

of open spaces. The coefficient varies from 104 per 10,000 in the crowded quarters to 11 per 10,000 near the Champs Elysées. That is why the English call the parks "the lungs of London."¹ A park that is large enough is a reservoir of pure air, and the trees that encompass and protect it form a very efficient natural filter in stopping the clouds of dust from the streets and rendering healthy the ambient air. While London has 290 parks or squares, whose total area is 752 hectares (1,859 acres), and Berlin 20 parks of 554 hectares (1,368 acres), Paris has 46 parks of only 263 hectares (649 acres). This is not enough, though active steps are being wisely taken to increase the extent of the parks, and with that end in view it is proposed to reserve the space now covered by the fortifications.

The movement in favor of open spaces and for plant growth in the cities is manifest in England and the United States in very extensive work for laborers' gardens and in the creation of public gardens, a work which an association has planned to promote in France.²

URBAN CIRCULATION.

M. E. Hénard, in his *Études sur les transportations de Paris*, ingeniously distinguishes six kinds of circulation: The household circulation, the professional circulation flowing at the hours of opening and closing of offices and shops, the economic circulation, the fashionable circulation, the holiday circulation, and the popular circulation. You might also add the tourist circulation. These several kinds of circulation present as a whole a series of problems which, according to M. de Foville, constitute "the mechanics of crowds." The encumbering of certain streets goes so far as to obstruct and congest traffic. In Paris, for example, the services rendered by the general transportation companies, exclusive of carriages and long distance railways, but including suburban service

¹ Les espaces libres à Paris. Le Musée social. Mémoires et documents, July, 1908.

² G. Benoit-Levy, Les Cités-Jardins. Revue internationale de sociologie, December, 1908. Ch. Gide, Les cités-jardins. Revue économique internationale, October, 1907. H. Baudin, La Maison familiale à bon marché. Geneva, 1904. L'Association des Cités-Jardins de France has for its aim to apply to dwelling places the latest principles of hygiene; to form model industrial centers; to develop city systems of parks, gardens, and playgrounds; to encourage the creation of city gardens. Everywhere, in the factory, in the city, at the fireside, the association seeks to introduce customs of life more healthy and pleasanter. We seek to create model cities or villages in all their parts when that is possible. We seek to develop social institutions which render life more merciful and more efficacious. We seek to develop habits which shall better the physique and morals of our race. We seek to make our centers of city life more hospitable and healthier. For this purpose we have contributed to the formation of city gardens, to the promotion of social welfare in factories, to the conservation and extension of open spaces in large cities. How one dreams one minute of the effect that would result in a workshop by the addition of windows to allow the air, the light, and the sun to enter throughout the day. How one dreams of the effect it would have on the workmen to place near their work tables some seats adjusted to their shape, where they could be seated without risk of deformity. How one dreams, in another range of ideas, of the results of the conservation of a bunch of shrubbery or trees, or of a park in crowded quarters of the city. The workshop well lighted, the city with great open spaces, would be better able than the sanitariums with their expensive treatment to combat tuberculosis. The Association of City Gardens has created the social service which gratuitously makes all inquiries and gives advice to all who wish to better the conditions of life in our present cities or to build new ones.

at intervals of about 25 years, are shown by the following figures, corresponding to the number of passengers carried, expressed in millions:

	1856	1885	1904
Omnibus.....fr.....	49,590	115,635	121,553
Street railways.....do.....		15,151	378,966
Boats.....do.....		9,579	21,080
City steam railways.....do.....	2,407	13,884	172,344
Total.....do.....	51,997	154,249	693,943

Though the movement of passengers increased in such a strong proportion, this was not only because of increase in population, but also because one becomes more and more in the habit of resorting to a means of transport to save time in reaching a place. "Time is money." In 1846 a Parisian used the existing lines 44 times during the year; in 1875, 78 times; in 1904, 256 times. M. Jenkins showed the British Association that in 1867 each inhabitant of London made an average of only 23 trips on the city lines, whereas the corresponding figure was 55 in 1880, 92 in 1890, 126 in 1900, 129 in 1901. The same author has shown similar averages in New York to have been 47, 118, 182, 283, and 320 for the years 1860, 1870, 1880, 1890, and 1900. A few years ago New York had transportation facilities capable of moving only 1,200 millions of passengers, while to-day the capacity is 2,000 millions.

To remedy this condition it is proposed to construct elevated sidewalks or subways at the street crossings. Under various methods what is being sought is movement at several elevations. In London the subways have two or three tunnels superposed. The metropolitan roads of Paris and Berlin, the elevated roads of New York, and the subways of Boston are an application of this method. On the streets animal traction is being replaced more and more by electric traction for tramways and automobile traction for single vehicles. In Paris from 1897 to 1907 the number of horses decreased from 92,026 to 83,458. City railways are more and more extending their zone of radiation, and in the United States, for example, have already commenced to engage in freight service.

The very high cost of underground railroads and in a less degree of street railways have led to the employment of automobile traction for single vehicles. It was only in 1905 that the autobus appeared in the streets of London. The autobus, though less expensive to establish than street railways, easily replaceable and with route changeable at will, besides much faster than the horse omnibus, yet it is, nevertheless, not free from inconveniences. The cost of management

of autobus service is greater than for electric tramways, and there is the noise, the odor, and the danger from fire and accidents. But the autobus is a new method, therefore susceptible of technical improvements, and has been called to take a place by the side of the street railway in replacing the horse cars, a dearer and slower method.

(d) CITY VITAL STATISTICS.

As a general rule, city population grows faster than the habitable territory, resulting at once in an overcrowding, particularly in the workmen's quarters. Paris has 86,000 dwellings with an average of 30 to 32 persons per house, while in London this average is only from 6 to 7.¹ The number of dwellings tends to be exhausted, while the lodgers increase. In 1896 the density of population was 326 persons per hectare (2,471 acres) in Paris, 260 in Berlin, 140 in St. Petersburg, 136 in London, and 85 in Vienna.

Overcrowding is always a sign of poor hygienic conditions. The atmosphere is more vitiated; the townsman lives much more indoors. Likewise the city mortality is greater than mortality in the country. What chiefly affects cities is the proportion of deaths resulting from infectious disease, infant mortality, and stillbirths.

Illegitimate births and suicides are also more frequent among city dwellers; crime is greater, especially crimes against property, resulting from misery and stronger and more numerous temptations.

Through immigration, cities have a greater number of adults, hence a greater frequency of marriages and divorces. This is so in cities that are made up in great part of a foreign element. In Geneva, Bâle, and Zurich foreigners number more than a third of the total population; Paris 75 per thousand, Vienna 22 per thousand, and Berlin 11 per thousand.

Cities are, on the other hand, centers of growth for democratic and socialistic ideas; politics is more advanced. The admixture of the people is an obstacle to the survival of particular languages and dialects. By the force of things, M. P. Merriot says, cities help to unify the language, as they also contribute to alter it.

Finally, cities form important centers of consumption. Their influence is exerted over the surrounding regions that are given up to market gardening and raising of fruit, to the rearing of cattle for providing milk. Their budgets increase and in order to reduce the fiscal charges of their taxpayers, some cities have municipalized their industrial services, gas, water, electricity, railways.

¹ G. Cadoux. *La vie des grandes Capitales*. Paris, Berger-Levrault, 1908.



THE SINAI PROBLEM.¹

By Prof. Dr. E. OBERHUMMER.

[With 3 plates.]

Few unsettled questions in Biblical geography have been so variously answered and aroused such lively discussions as that of the actual site of Mount Sinai. True, tradition had seemingly long ago solved this problem to its own satisfaction, for since the days of the first Christian anchorites (350 A. D.), whose life in the rock desert of the Sinaitic peninsula George Ebers depicted in such a vivid manner in his "Homo Sum," the crystalline mountain range which fills out the southern part of the peninsula, forming a section of the Arabic-North African tableland, between the Gulfs of Suez and Akaba, has been considered as the dwelling place of the Israelites after the exodus from Egypt.

Thus the oldest cartographic representation which we have of this region, the "Tabula Peutingeriana," a road map of the Roman Empire, begins with this viewpoint. The remarkable illustration here presented (pl. 1) unmistakably delineates in outline, including the two inlets or bays at the end, the Sinaitic peninsula containing a mountain inscribed *Mons Syna*, above which appear the words "*Hic legem acceperunt in monte syna*" (here they received the law on Mount Sinai), and farther above we read "*Desertum ubi quadraginta annis erraverunt filii israel ducente Moyse*" (the desert where the children of Israel wandered 40 years, led by Moses). These words obviously do not belong to the original draft of the road map, which was based upon Agrippa's map of the Roman Empire in the time of Augustus, but are, like the words "*Mons oliveti*," near Jerusalem, a Christian addition of the fourth century.² But that the localizing of Sinai on the peninsula was then considered established is shown by the oldest pilgrim literature, such as the Pilgrim of Bordeaux (A. D. 333) and the Itinerarium of Silvia.³

¹ Translated by permission, from Die Sinaifrage. Von Prof. Dr. E. Oberhammer. Mitteilungen der K. K. Geographischen Gesellschaft in Wien, vol. 54, 1911, Wien, pp. 628-641.

² A. Elter, Itinerarstudien (Bonn, 1908), p. 10f.

³ The latter itinerary has been discovered recently in an Italian manuscript and was assigned by the first editors (Gamurrini, Mommsen) to Silvia of Aquitania (about A. D. 390). However, the last researches of R. Meister, Rheinisches Museum 64 (1909), seem to prove that the author was the Abbess Aetheria of Gaul, in the beginning of the sixth century. The best critical edition of these and the other oldest itineraries has been given by P. Geyer, Itinerara Hierosolymitana. Vienna 1898. A reprint of "S. Silviae Peregrinatio" has also been made by E. A. Bechtel, Chicago, 1902.

The second oldest cartographic representation of this region, the mosaic map of Madeba (pl. 2), dating from the sixth century and discovered in 1896, indicates Sinai as a strikingly drawn mountain but without naming it. The inscribed legends, however, leave no room for doubt; thus *ερημος συν οπου κατεπεμφθη το μαννα και η ορτυγομητρα* (the desert Sin where the manna was sent and the quail), almost word for word after the text of Silvia: "*Ostenderunt et illum locum, ubi eis pluit manna et coturnices*" (they showed also that place where the manna and quails fell for them).¹ On the left side underneath it we read, *Ραφιδιμι ενθα επεσθοντι τω Αμαληκ ο Ισραηλ επολεμησεν* (Rephidim, where Israel fought the advancing Amalek.) Below the Sinai Mountain (the map being oriented toward the east, north is on the left) on the map (pl. 2) is still seen the eastern branch of the Nile, which runs off from the main river and which is designated as the *Πηλουσιακόν στόμα* (mouth of the Pelisium), after the boundary city of Pelusion, of which the initial part, *Πηλουσ*, written vertically, is still to be seen.

It is remarkable, on the other hand, that the oldest work on Biblical geography, the Onomasticon of Eusebius (died in 340 A. D.) places Horeb in Midian.² *Χωρήβ. ὄρος τοῦ θεοῦ ἐν χώρῳ Μαδιάμ. παράκειται τῷ ὄρει Σινᾶ ὑπὲρ τὴν Ἀραβίαν ἐπὶ τῆς ἐρήμου* (Horeb, the mountain of God, is in Midian; near the mountain lies Sinai; opposite Arabia in the desert), to which St. Jerome in his Latin edition of the work remarks: "*mihī autem videtur quod duplici nomine idem mons nunc Sinai, nunc Choreb vocetur*" (it seems to me, however, that one and the same mountain is designated by the double name, being now called Sinai, now Horeb). Antonius of Placentia (570 A. D.) also distinguishes between Horeb and Sinai.³ The two different names in the Bible, which have engaged the attention even of recent investigators, are now explained by the difference in the sources of the Biblical account (Horeb in the Elohist, Sinai in the Jahvist, etc.).

After the erection of the famous monastery of St. Catherine under Justinian I (sixth century) at the latest, Jebel Musa ("Mountain of Moses"), 2,292 meters (=7,520 feet) high, which the highest peak in the south, Jebel Katerin (2,606 meters=8,712 feet) exceeds by about 300 meters (1,000 feet), was firmly established by tradition as the mountain of the giving of the law. This tradition was first questioned by the renowned traveler, Johann Ludwig Burckhardt, who traversed the Sinaitic Peninsula in 1816 and expressed the opinion that older tradition was in favor of Jebel Serbâl, which rises to an imposing

¹ Die Mosaikkarte von Madeba, herausgegeben von Guthe, I. (Leipzig, 1906), Plates V and X. A. Jacob. Das geographische Mosaik von Madeba (Leipzig, 1905), p. 44. A. Schulten, Die Mosaikkarte von Madaba (Berlin, 1900), p. 27.

² Eus. Onom., herausgegeben von E. Klostermann (Leipzig, 1904), p. 172f.

³ Geyer, *op. cit.*, p. 183.

Smithsonian Report, 1912.—Oberhummer.



THE REGION OF SINAI ACCORDING TO THE MAP OF MADEBA (6TH CENTURY).

height (2,060 meters = 6,780 feet) from the oasis of Firân,¹ near the west border of the mountain range. Eminent investigators, such as the Egyptologists Richard Lepsius² and George Ebers,³ followed him in this view and attempted to prove that the earliest Christian tradition assigned the event to Jebel Serbâl and that it was only because of the founding of the monastery by Justinian that the tradition was changed to Jebel Mûsâ. The majority of investigators held to the tradition which had prevailed through the centuries and sharply opposed the new hypothesis. Karl Ritter⁴ in his work sums up all the knowledge and investigations on this subject down to 1848; it is the most comprehensive description of the Sinaitic Peninsula and is not yet superseded by any similar work, and especially Konstantin Tischendorf.⁵ But the war cry, "Here Serbâl, here Jebel Mûsâ," is not yet silenced.

All these investigators started from the seemingly self-assumed presumption that the route of the Israelites from the "Red Sea," that is, from the north end of the Gulf of Suez, led through the mountain range to which modern geography, in agreement with tradition, gave the name of Sinai; the native population designates it simply *et-Tur* ("The mountain," compare Taurus). But opposed to this assumption there has been of late asserting itself, with constantly increasing force, the view that the stage of events described in the Book of Exodus was not at all on the Sinaitic Peninsula, but is to be sought *east* of the valley called al Araba, which connects the Akaba-brake with the Jordan depression. With this view another assumption gains in importance, namely, that the Sinai of the Bible must have been a *volcano*. In contrast to the old explanations which compared the phenomena described in the Book of Exodus, with a heavy thunderstorm, such as do indeed sometimes occur in the waterless Sinaitic Peninsula, the unmistakable similarity of those descriptions with a volcanic eruption was now pointed out. The first to present this new view was the English geographer Charles Beke, who had rendered much service in the exploration of Africa.⁶ In a special monograph⁷ and in a communication to the "Athenæum"⁸ he gave expression to the view that the occurrences related in the Bible must have been of a volcanic nature, and at the same time called attention to the volcanic regions of northwestern Arabia, especially to the

¹ Reisen in Syrien (Weimar, 1824), pp. 964f.

² Briefe aus Agypten (Berlin, 1852), pp. 340ff, 417ff.

³ Durch Gosen zum Sinai (Leipzig, 1872), p. 381f. Palästina in Wort und Bild, 1883, vol. 11.

⁴ Die Erdkunde, part 14 (1848).

⁵ Aus dem heiligen Lande (Leipzig, 1862), p. 91ff.

⁶ Compare Petermann's Mitteilungen (1875), p. 48f; F. Embacher, Lex. d. Reisen (1882), p. 30f; Allibone, Dict. of Eng. Lit., Suppl. I.

⁷ Mount Sinai a Volcano (London, 1873), 48 pp.

⁸ Athenæum, 1873, pp. 181, 214f.

Harrat en-Nar,¹ northeast of Medina (26°, 30' N., 40° E.), which was still active in historic times. Beke himself in advanced age undertook a trip to the Orient in order to solve this question. Prompted² by a remark in the work of Irby and Mangles,³ who believed they had found volcanic peaks northeast of Akaba, he turned his attention to the mountain which towers above the northern point of the Gulf of Akaba in the east and believed that he had found the true Sinai in Jebel Bâghir, 1,600 meters (5,250 feet) high, supposedly also called Jebel en-Nûr ("Mountain of Light"), five to six hours distant from Akaba.⁴ His companion, Milne, who afterwards became famous as an investigator of earthquakes, ascended the mountain and Beke had the disappointment to learn that it was not a volcano, but was of granite formation. But instead of drawing from this the conclusion that Sinai must be sought elsewhere, Beke held firmly to his localization and gave up his volcano theory. "I was thoroughly mistaken about the volcanic character of (the true) Sinai," he wrote to his friend, R. Burton,⁵ and in a similar way he expressed himself in his interesting notes which, after his death, (July 31, 1874), were published by his widow (unfortunately without a map).⁶ But his other reasons also for localizing Sinai near Akaba were already shaken by Burton.⁷ He agrees with Beke in opposing the traditional Sinai, but thinks of the Desert of Pharan, north of the Sinaitic Peninsula and refers to a paper by H. Grätz,⁸ who takes his stand for the Jebel Arajif en-Naka (30° 20' N., 34° 20' E.).

The now almost forgotten position of the English geographer and Biblical investigator Beke on this question has been dwelt upon at some length, in order to establish his priority in a problem upon which, through recent investigations, unexpected light has been shed. I pass over the recent literature on the Sinaitic Peninsula as such. It is recorded in my reports on the geography of the ancient world.⁹ By the last one, which has been recently published,¹⁰ I was induced to try a clear review of the whole story. Only the changing views

¹ See below, p. 676.

² See letter in the *Athenæum*, 1874, p. 25.

³ *Travels in Egypt* (London, 1868).

⁴ The names given by Beke seem, as Burton (see below) already has pointed out, to rest on a misunderstanding. According to A. Musil, *Arabia Petraea*, II, 1, and his "Karte von Arabia Petraea" (Vienna, 1907), the valley which from the northeast opens near Akaba is called Wadi el Jitm and the mountain north of it Jebel Harum. Beke's Jebel Bâghir (also spelled Barghir) seems to be in the Wadi of Shekh Mhammad Bâker, which is situated upon a hill to which the Wadi Radda leads from the Wadi el Jitm. Bâdeker, it is true, mentions even in the latest (7th) edition of his "Palästina und Syrien" (1910), p. 197, the Jebel Barrir or Jebel en-Nûr, 4 to 5 hours from Akaba. This notice goes back to Beke, as may be followed up through all the editions, and lacks, as there, a more accurate determination of the place.

⁵ *The Land of Midian*, I, 239.

⁶ Beke's *Discoveries of Sinai in Arabia and of Midian* (London, 1878), pp. 392, 439.

⁷ *Op. cit.* and *Journal of the Royal Geographical Society*, 49 (1879), pp. 421, 481.

⁸ *Monatsschrift für Geschichte und Wissenschaft des Judenthums*, 1878, pp. 337-360. Illustration of Jebel Arajif in Musil's *Arabia Petraea*, II, 2, p. 168.

⁹ *Geographisches Jahrbuch*, 1896, 1899, 1905.

¹⁰ *Ibid.*, 1911, pp. 352ff.

about the site of the Biblical Sinai are here to be followed up. In this undertaking it is obviously presupposed that the Biblical account has at least in the geographical sense a real background. The question of its historical credibility does not concern me. Bernhard Stade¹ thought: "What we now read about it in the Book of Exodus is really an early myth disguised as history and therefore equipped with historical and geographical details. To follow up the route taken by the Israelites is just as important as to investigate the one made by the Burgundians on their journey to King Etzel in the Nibelungen-sage." The journey of the Burgundians to King Etzel is mythical, but the description of the places along the Danube, where Vienna emerges from the obscurity of long centuries as a flourishing and festive city, is real and tangible. Here, too, a remark of Moltke² on the stage of the earliest Roman history holds good: "A narrative may be historically untrue, and yet as regards the location perfectly accurate." From the *Acta Sanctorum* hundreds of examples might be quoted.

Nearly as hopeless as Stade, who does not even put the question, "Where was Sinai located," but rather "Where does the sacred legend of the Hebrews place Sinai,"³ the famous Biblical critic Julius Wellhausen⁴ thus expresses himself: "We know not where Sinai was situated, and the Bible is hardly in agreement concerning it. To dispute about this question is characteristic of the dilettanti." At the same time Wellhausen, considering Exodus, Chapters II seq., inclines to the view that places Sinai in Midian. Other data for the various locations of Sinai are given in an excellent treatise recently published, "Where was Mount Sinai located," by K. Miketta,⁵ who himself reverts to the traditional standpoint.

The most recent phase of the Sinai question is introduced through the more and more prevailing recognition that we have in Exodus, Chapter XIX, as also in other passages, the story of a great volcanic eruption. After Beke, who first broached this hypothesis, had abandoned it, Hermann Gunkel, the Old Testament theologian and successor to Bernhard Stade at the University of Giessen, independently pointed out in numerous passages of his writings the volcanic character of the phenomena.⁶ In Exodus, Chapter XIX, we read: "A thick cloud was upon the mount; the smoke thereof ascended as the smoke of a furnace; there were thunders and lightnings, and the voice of the trumpet exceeding loud; the Lord descended upon the mountain in fire, and the whole mountain quaked greatly." In another pas-

¹ *Geschichte des Volkes Israel*, I (1887), 129, Anm 2.

² *Wanderbuch*, p. 21.

³ *Op. cit.*, pp. 132ff.

⁴ *Prolegomena zur Geschichte Israels*, 5th ed. (1899), p. 349.

⁵ *Weidenauer Studien*, III (1909), 77-123; IV (1911), 117-145.

⁶ First in *Deutsche Literatur-Zeitung*, 1903, p. 3058. Similarly *Ausgewählte Psalmen*, p. 160 (2d ed., p. 117), and in "Beiträge zur Weiterentwicklung der christlichen Religion" (München, 1905), p. 69, where also the supposed location in northwestern Arabia is referred to.

sage is read that "the mount burned with fire" (Deuteronomy, IX, 15), and that "the mountain burned with fire into the midst of heaven, with darkness, clouds, and thick darkness" (Deuteronomy, IV, 11). Furthermore, the Moses legend tells of a cloud (pillar) of smoke and fire which advanced through the land, and in which Jehovah's glorious manifestation was beheld (Exodus, XIII, 21). The poetical recensions vary the same theme in the form of prophecy; they tell of glowing coals; of the breath of Jehovah, which resembles a burning stream of sulphur, of mountains which melt like wax, etc. Taking all this together, it can not be doubted that observations of nature are here the basis of the account, and that the usual explanation of the question that it was a thunderstorm is not conclusive. Sinai must have been a volcano. Moses led his people to a volcano, and in the terrible volcanic eruption the awful and majestic manifestation of Jehovah was experienced.

Gunkel's treatise, which later on he supplemented with the view that since there were no volcanoes on the Sinaitic Peninsula the Sinai of the Bible was to be sought for in the volcanic regions of northwest Arabia, received much approval, especially from Eduard Meyer,¹ who says, "Gunkel has recognized that we have here the description of a volcanic eruption. It is true that there never was a volcano on the Sinaitic Peninsula, but that, as is well known, there were numerous volcanic regions (*Harras*) in western Arabia; the entire Hauran territory, including Trachonitis, is made up of them, and numerous extensive Harras are located in southeast Midian, on the road from Tebuk through Medina as far as Mecca. There is nothing to oppose the assumption that one or several of these volcanoes may have been still active even in historic times. One of them was the authentic Sinai." Meyer remarks that already in 1872 the thought forced itself upon him that Sinai must have been a volcano, but that he abandoned it because it did not then occur to him to seek Sinai outside of the Sinaitic Peninsula. The recognition that the Sinai of the Jahvist (the Elohist calls the mountain of God "Horeb") must have been situated in Midian, Meyer ascribes (pp. 60, 67) to Wellhausen (see above). In connection with Gunkel's explanation of Sinai as a volcano, Meyer assumes that Jehovah was originally a volcanic fire god and that he was indigenous in Midian. He says, "We have often recognized Jahve as a fire demon who in the darkness of night manifests his majesty. The awful nature of the unapproachable fire god, who causes destruction to friend and foe, is also here (I Samuel, VI, 19) clearly recognizable, for instance, in the story of the ark (p. 70f.)." In connection with this Meyer would also ascribe the origin of the story of Sodom and Gomorrah to the volcanic Harras of Arabia, "in Palestine it was then transferred by the Israelites to the Dead Sea." This view

¹ Die Israeliten und ihre Nachbarstämme (Halle, 1906), p. 69.

would obviously create a new basis for an explanation of the catastrophe of Sodom, about which there developed, from the standpoint of natural science, a controversy between M. Blanckenhorn¹ and C. Diener². But we can not here enter into that question.

The view that the Biblical Sinai was a volcano and should be looked for in Midian meanwhile also gained adherents elsewhere. Thus the well-known orientalist and Biblical scholar, Prof. Paul Haupt, of Baltimore,³ writes: "Mount Sinai can not be located on the Sinaitic Peninsula; it was a volcano in the land of Midian. Mount Sinai, the sacred mountain of Midian, must have been a volcano." He seems also to follow the view of Beke, since he repeats his mountain names, *Jebel en-Nûr* and *Jebel al-Barghir* (which have been proved to be erroneous), and looks for the volcano in the neighborhood of Akaba.⁴

In his review of E. Meyer's book, "Die Israeliten," Gunkel⁵ reiterates the question, "Should it not be possible for our geologists to discover the volcano which at that time must have been in eruption?" This problem seems now to have been solved through Prof. A. Musil and his companion, the geologist, L. Kober. At present we have only a brief preliminary notice by Musil on this subject.⁶ "Thus we left the valley of al-Jizel and arrived at the wide plain of al-Jav, where we made unexpectedly, on the 2d of July, 1910, what is in my opinion the most important discovery during this exploring tour, namely, that of the genuine Biblical Mount Sinai. All our troubles were forgotten and we should have liked much to investigate more thoroughly 'the grottoes of the Servants of Moses,' but our guide would under no condition allow us to set foot upon the sacred volcano al-Bedr, and threatened to abandon us at once if we did not continue our way eastward. We had to yield, and I hoped that Allah would enable us to attain to-morrow what was impossible to-day. Our route led through the midst of the Harra regions ar-Rha and al-Awêrez, so that we photographed pretty accurately nearly all the extinct volcanoes."

According to the map appended to this preliminary report the volcano Hala-l-Bedr is situated in latitude 27° 12' north, longitude 37° 7' east—that is, considerably farther south than Sinai was looked for even by the advocates of the Midian hypothesis. Accord-

¹ Die Entstehung und Geschichte des Toten Meeres (Leipzig, 1896), aus Zeitschrift des Deutschen Palästina-Vereins, 19, und Zeitschrift des Deutschen Palaestina Vereins, 21 (1898), pp. 65-83; Mitteilungen der K. K. Geographischen Gesellschaft, 1900, pp. 194-197.

² Mitteilungen K. K. Geographischen Gesellschaft, 1897, pp. 1-22; 1899, pp. 14-18.

³ The Burning Bush and the Origin of Judaism. Proceedings of the American Philosophical Society, 48 (1909), pp. 354ff.; Midian und Sinai, Zeitschrift der Deutschen Morgenlaendischen Gesellschaft, 63 (1909), pp. 506ff.

⁴ Op. cit., pp. 365, 368.

⁵ Deutsche Literatur-Zeitung, 1907, column 1928.

⁶ Anzeiger der Kaiserlichen Akademie der Wissenschaften, Philosophisch-Historische Klasse, 1911, No. 13, p. 154.

ing also to the brief accounts of L. Kober, the companion of Musil,¹ it is a recent volcanic territory: "The volcanoes which have been discovered in the region of Harrat-al-Awêrez belong to the most recent formations of geological importance. They form a series with a north-south course. Their basalt covers and tofs fill the shallow Wadis of the Nubian sandstones." This statement is important because it helps the assumption as to the possibility of a volcanic eruption there in historic times. As a matter of fact, such eruptions are attested, if not for this region, yet for the volcanic territory of Medina situated farther south. Seetzen called attention to this in 1810 and quoted accounts of "earth fires" in 1242 and 1252 from an Arabic work on the history and topography of Medina (probably by Samhude).² Burekhardt,³ following the same source, discusses at great length a great volcanic eruption in 1256 at Jebel Ohod, north of Medina, which was so great that the fire could be seen in Jambo and Mecca, and even in Damascus the sun and moon were obscured by the smoke. Makrizi, the Egyptian historian, also attested this eruption. K. Ritter, in his still unsurpassed "Erdkunde von Arabien," collected all the material then accessible,⁴ as he also correctly perceived the succession (or course) of the volcanic formations along the depression of the Red Sea, though he expresses himself on the subject in a now somewhat obsolete terminology:⁵ "The volcanic elevation line from Medina to Aden and Tadjurra lies in the main direction of the great earth cleft between Asia and Africa."

The region of this eruption seems to be the same as that which Yakut in his geographical lexicon, which is known as a main source of the Arabian geography, describes as Harrat-en-Nar, "the fire Harra."⁶ It is, "according to Ijad, the same which, under the second Calif Omar, was afire, or at least in volcanic eruption. An identical one is recorded from pre-Islamic times in the tale of Halid b. Sinan, who is said to have extinguished its fire. It is especially remarkable as being the only volcanic region of Arabia recorded as having eruptions in historic time" (Loth, p. 378).

Considering all this, the possibility must be admitted that in a more remote period of historic times one of the volcanoes situated farther north may also have been in eruption. More detailed data on the present condition of the volcano Hala-l-Bedr and the probability of their being confirmed in geologically recent times will be

¹ Anzeiger der K. Akademie der Wissensch., 1911, Mathematisch-naturwissenschaftliche Klasse, No. 13.

² Lived 1465-1481 in Medina. See Brockelmann, Geschichte der arabischen Literatur, II, pp. 173ff.

³ Travels in Arabia, pp. 359ff.

⁴ Die Erdkunde, XIII (1847), pp. 165ff.

⁵ Ibid., XII, p. 672.

⁶ O. Loth, die Vulkanregionen von Arabien nach Jakut, Zeitschrift der D. Morg. Ges., 22 (1868), pp. 365-382.

learned from the expected report of L. Kober, and the work on the Sinai problem in preparation by Musil will certainly also furnish new information. These publications will not be forestalled here, but there will only be stated what is already generally accessible. An elucidation of just this point seemed desirable because the full history and present status of the Sinai problem is not only unknown to wider circles, but even among those who are occupying themselves with the question there seems to be uncertainty as regards the priority of the several theories, which is not to be wondered at considering the remoteness of some of the statements.

If Musil's localization proves correct, to him will be due the credit of having found the answer to the question introduced by Beke and Gunkel concerning the transferring of the mountain of the promulgation of the law from the Sinaitic peninsula to Arabia. The importance of this discovery can hardly be overestimated. Infinite pains and acumen have been spent in ascertaining the route of the Israelites through the Sinaitic peninsula, and the literature on that subject would fill a small library. Now all this has been "spoken to the winds." The "Red Sea," after the miraculous crossing of which the desert wandering proper begins, is not longer the northern point of the Gulf of Suez, but that of the Gulf of Akaba, which the Israelites, assuming their sojourn in Egypt (which some modern Biblical criticisms declare to be unhistoric), must have reached by the shortest route north of the peninsula. The search for the stopping places on the desert route may now be started in Midian, until now a closed country. This may appear to some as inconvenient, but it is hardly more so than Dörpfeld's transferring of Ithaca to Leucas, which all of a sudden undermined all attempts to prove the stage of the *Odyssey* in all its details on a perfectly secure basis. Whether successfully, only the future will prove. In both cases there is incumbent on the defender of the new theory not only to furnish positive evidence for his view, but also to explain how the false localization and naming obtained currency. In any case we stand as regards the Sinai problem at the beginning of a complete revolution of all traditional views. A new goal, one not easily reached, is now set before the travelers in search of Biblical places.



THE MUSIC OF PRIMITIVE PEOPLES AND THE BEGINNINGS OF EUROPEAN MUSIC.¹

By WILLY PASTOR.

More than once have we heard in this hall, by means of the phonograph, an echo of the sounds which to primitive peoples are the height of all musical beauty. To us it seems a strange music. The repetition of certain very short motifs, noisily executed and profusely and weirdly accented by cries, clapping of hands, the droning, or striking of percussion instruments—all that gives expression to moods as foreign to us as though it came out of another world. Even educated musicians are perplexed by such acoustic phenomena. They can hardly perceive the difference between quite distinct motifs. At the outset, however, we can hardly distinguish between one negro and another, and it is a question of persistence if we are to understand in all their diversity the religious songs, dances, and folk-songs of the lower and lowest peoples. Of course a real understanding of sensation will never be possible. Two different worlds are reflected in the music of primitive peoples and in our own, and each must have had its own peculiar character for more than 3,000 years. Let us try, in order to form an antithesis, to translate from sound into sight. For such an experiment, the differentiation suggested by Hornbostel is very important. He proposed to separate music into horizontal and vertical music. Horizontal music is the monotony of those exotic motifs compared to which the most insignificant of our intervals can signify so much. A single one of our chords is like a precipice when we think of the monotonous music of primitive peoples. If we compare the primeval Pan's pipes and their thin tone with the great richness and plastic power of our organ, we shall then have a classic example of the difference between horizontal and vertical, or, if you prefer, between the music of two and three dimensions. The horizontal or two-dimension music has become so foreign to us that we must try to bring it back to our hearing again. In this we shall succeed quickest if we concentrate our minds on the manner of playing and the sound character of a group of instruments

¹ Translated by permission from the *Zeitschrift für Ethnologie*, Berlin, vol. 42, 1910, pp. 654-675.

which have become to us of secondary importance, but which to the primitive peoples are of infinite significance. These are the percussion instruments.

We might here extend our investigation from the circle of primitive peoples to the entire territory of living orientals. The Orient has done remarkable things in the invention of percussion instruments, and it is astonishing how capable of modulation are even the drums and kettledrums that are in use in the Orient. They can crash like a fanfare or sound as dull and hollow as a dirge. The monotonous rattling of a pair of castanets, when correctly played, can suggest whole melodies. The cymbal and also the gong originated in the Orient. There is no sharper contrast than the strong voluptuousness of the cymbal, which so well accentuates the sensuous moods (for example, the Venusberg scene in "Tannhäuser"), and the dull, hollow vibration of the gong.

But we will confine ourselves to the primitive peoples. A favorite classification recognizes two groups of percussion instruments in the meager scores of these peoples: The percussion instruments proper, and the rattles and clappers. In the first group we have three subdivisions: (1) Sticks, which are struck on the ground, or against primitive sounding boards, such as hollow trees, shields, and the like; (2) suspended sound plates to strike against; and (3) the great and most important group of the drums.

In our folk music the percussion instruments hold an important place, to give a firm structure to the music. The drums, cymbals, and kettledrums of our military and dance music compel the melodies to proceed in an orderly manner; they mark the rhythm to an extent often almost comic to persons of fine sensibilities. Thus it happens that in many books on music the percussion instruments are simply entered under the heading of "rhythmical instruments," a designation in which, for example, the department of the German Museum at Munich, which is concerned with them, acquiesces.

The effect of music characterized by the unpretentious percussion instruments is unmistakable. A strong rhythmical music helps with work and with play; if we may make use of a modern expression, it is "Schrittmacherdienste." It is used effectively in activities which require regularly recurring movements of the body, in marches, in dances, in special kinds of work, such as threshing and hammering, or, to choose a somewhat less definite example, in the old-time spinning rooms. The output of power will be regulated through the rhythm. A certain common atmosphere, a mass spirit, will be produced which will react on the individual.

This purely rhythmical value of the percussion instruments is so highly developed and dominant in the melodies of savage tribes, that we appear already to have reached the center of all archaic and

folk music. We only occasionally use hand clapping for emphasizing the rhythm, while they employ it systematically for the dance. Working songs dominate over a wide sphere of human activities. We need think only of the boat songs, in which the oars are operated precisely like a musical instrument. Bücher has collected much valuable material in his "Arbeit und Rhythmus," in regard to this.

But in such rhythmical values the significance of percussion instruments to the savages is by no means exhausted. Indeed, the deeper we search the clearer it becomes that the whole of the purely rhythmical music of this kind represents a second and later stratum which we must remove if we would reach the actual beginnings of human music.

I have shown how the orientals can get expression out of the mere noise of percussion-instrument music. So do we also, in that we constantly use our kettledrums in symphonies, for example, not only as a purely rhythmical instrument but as one capable of great expression. When we come to look closer we find that the savages also knew very well the twofold character of percussion instruments and that they were very much used. Even unmusical travelers have noticed what a variety of pitch there is in the percussion instruments of native peoples and particularly in drums. They may be gigantic instruments, whose sounding body is a single, hollowed-out tree trunk and whose sound hole is merely a narrow slit; or small portable instruments covered with skins and hides, approaching the form of our bass drums and kettledrums. A hypnotic power, such is the universal opinion, comes from such drum playing. The benumbing of the senses arises in part from the sound quality of the vibrating instruments, and in part from the peculiar method of execution. The roll of the drum which is used in our military music is not characteristic. Much more so is the monotonous succession of similar strokes, which continue unceasingly until the ear is entirely filled with the sounds and the mind becomes confused.

The enthralling effect produced by the peculiar rhythm, and the elemental character of the sound, explains the often repeated observation that in the mystic festivals of secret societies and in funeral ceremonies the drums prove to be the most important means of expression. Often have we heard of the horror caused by the giant drums of the Ashantis or on Tahiti, when they gave the sign for the beginning of human sacrifice. Some drums are such sacred instruments that their mere sound scatters the unprivileged, the women and children. Thus in Africa the drum is often a fetish to which the highest veneration is given.

There is another group of instruments which equal the most venerated drums in magical power—the whirring instruments. One of these instruments, the *Waldteufel*, we have all swung in our childhood.

In children's play, old traditions are often kept alive, and so we may well consider whether the *Waldteufel* is not likewise brought down to us from olden times, when magic was the highest world philosophy. The name, alone, appears to indicate that the sound of this simple instrument can cast a spell over an entire forest, and this demoniac power the *Waldteufel* still has to-day among some savages. In their buzzing sound they hear the voice of a supernatural being. In New Zealand whirring instruments were used until recently for weather magic and in Western New Guinea they are indispensable in the ceremony of circumcision and in the gatherings of men. "Through the whole of Australia," says Howitt, "the *Waldteufel* is one of the most sacred and most mysterious of objects which is used in relation to the sacred ceremonies. Neither women nor children—I might even say, in general, no uninitiated persons—dare see it, or they would be threatened with death. Novices are enjoined that in case they acquaint the women and children with it, death will be their lot either through violence or in consequence of magic. The reverent awe with which the initiated regard one of these instruments, when it is sent about to authenticate a message which calls them to a ceremonial gathering, is very striking."

We will introduce an illustration here which has a psychological significance. Lenz gives it in his "Sketches from West Africa" regarding the influence of tom-toms:

During the dance of the medicine men in Aschuka several young people became ill from the sound of this instrument and the whole exciting scene. They rushed suddenly out of the circle, ran around in the field on all fours like animals, and began to rave; only with difficulty could they be overpowered and taken away. But here in the village, in the horrible dances of the Oganga, there is scarcely any end to these occurrences; wherever one looked one of these unfortunates was writhing on the ground, and the old men and women had much to do in order to bring them into their huts.

We are accustomed to find rhythm somewhat of a stimulant and inspiration, and the number of work songs also goes to establish such an opinion of it. But examples like those mentioned above show us that, besides the stimulating rhythm, there is also a paralyzing soporific one. The stimulating rhythm may be derived from any regular sound, even such meaningless noises as handclapping and the stamping of feet. For the hypnotic rhythm, on the contrary, the quality of the tone and its mode of expression are of the utmost importance. The stimulating rhythm belongs with a more developed melody, which is either foreign to the hypnotic rhythm or destroys it. We have in the former an art of *tones*, in the latter the art of *tone*.

In thinking of the strong contrast between these two kinds of music, no doubt can exist that they are derived from entirely different stages of development; the question also arises as to which of the two kinds is the older—the stimulating music or that of hypnotic

rhythm—the art of tones or that of tone. The fact alone that in the art of tone the principle of the horizontal, or two-dimension, music is much more forcefully conveyed than in the art of tones, is sufficient to lead us to regard the hypnotic rhythm as older than the stimulating rhythm, and here we encounter the very important consideration that magic and witchcraft are inextricably bound up with all hypnotic art.

The belief in witchcraft is the oldest known philosophy of the world. What significance this belief possesses in connection with the primitive history of music, and indeed with all art, we shall consider at the close of the article. Here we are chiefly concerned with the fact, on which stress must be laid, that in the music of primitive peoples traces of an epoch of belief in magic are still everywhere recognized, most conspicuously in weather magic, to be mentioned later, and almost as strongly in some of the practices of the medicine men. We must consider a statement like that of Lenz on the effect of tomtoms, if we would understand the full significance of music in the early history of medical science. Musical healing is widely practiced among savages, and there is manifold evidence that it is also occasionally effective. We should not, however, compare the effect this music has on the colored races with that which it has on us. Nussbaum was not so far wrong when he warned us that in connection with certain old remedies that appear to us to-day entirely wrong, we must first of all inquire into the character of the people that occasioned such prescriptions.

The spirit of the most primitive music of savages, here under consideration, when we separate the older from the oldest, carries us back to those early epochs in the history of civilization which were dominated by belief in magic, and our first conclusion may be stated as follows: In the entirely unmelodic, purely elementary music, whose rhythm is articulate, and either not at all crude (as with the wind instruments) or entirely so (as that of drums), we recognize the first musical attempts of mankind. In this music, which in the main only confuses, the principle of the horizontal or two-dimension music is unquestionably supported.

One of the most fundamental characters of such an art, is that it does not develop melodic instruments nearly so abundantly as percussion instruments. Any vaudeville theater can teach us how clever musicians can make purely noise instruments melodic also. We know the performance in which differently toned wine glasses are manipulated like a keyboard, the performance on a bell by musical clowns, with merely a penholder to suggest melodies by short or long strokes. Tendencies to such arts we find here and there among primitive peoples, but they remain merely tendencies. Schauenburg relates how a negro of Kujar made his signal drum almost speak as

he struck it with his right hand, and variously modified the sound by all sorts of muffling manœuvres with his left. Witte has recently thoroughly investigated the "drum speech" of the Ewe tribe and reported on it in the "Anthropos" (Wien, 1910, Heft I). From his very clear statements, it presupposes a power of understanding whose development does credit to the ear of primitive peoples, but does not involve an appreciation of art. The percussion instrument most capable of producing melody is the famous marimba of the Kaffirs, a kind of xylophone made over hollow gourds as sounding boards. The metal wind instruments remained entirely undeveloped. They were only of value for signals. Moreover, most of the so-called trumpets served principally, not to produce tone, but only to increase sound; they were to be shouted into like a speaking tube. The stringed instruments stand on a somewhat higher level though we find forms similar to the harp, guitar, and zither.

Certainly all the stringed instruments are later than the percussion instruments. The fact has already been demonstrated that none of the finer melodic instruments have any religious significance. The only musical instruments which by tradition or use are exceptions are the men's flutes of the Papuans of New Guinea (whose tone was regulated by a sliding rod); the rain pipe of the Basutos, a kind of horn made out of bark by the Indians of Rio dos Uaupés, one of the tributaries of the Rio Negro (women who obtain sight of it are ruthlessly poisoned); and a shell trumpet used by the priests of the Fiji Islands in sacred processions. None of these instruments, however, in the manner in which they are used produce melody. All melodically used instruments, on the contrary, have neither a magical nor particularly a religious character. They are secular, which fact certainly indicates their late origin.

It is necessary now to establish the origin of the different instruments. The most obvious and formerly most commonly accepted view was that primitive peoples had independently contrived the whole of their orchestra, and had perfected it from rude beginnings. This supposition is, however, strongly shaken by more recent investigations. Thus, it has been shown in the case of the most interesting melodic instruments that they have not resulted through development, but are rather retrogressions from more perfect borrowed examples. The negro harp boasts its origin from the corresponding old Egyptian instrument; the pipes of the Kubus in Sumatra are the product of Javanese civilization (Hornbostel); the marimba imitates Chinese and Indian predecessors (Wallaschek); and the lute came first to Africa with the Arabian invasion (Ankermann).

It is now in the highest degree imperative to observe in what direction the retrogression moves. The workmanship becomes careless, the contours of the instruments are less sharply defined, a poorer

material is used for the strings, and, in short, indifference is shown toward all those elements which the melodic music perception at one time built up with the most painful exactness. But there is one part of the stringed instruments in which we see not a retrogression but a clear development. That is the sounding board. All well-developed music culture regards this as a mere sound strengthener. Every form of resonator represents an unlimited number of musical experiments. Only the work and the traditions of many generations could determine the form to be finally accepted, which is so important in the matter of tone color. But this form once settled upon the player need no longer trouble himself about it.

It is otherwise with primitive peoples. In handling the borrowed instruments they were convinced that the sounding board produced a sound like that of the strings. This sound they thought could be made better by a transposition of the sounding parts. Hence, they almost always reconstructed the sounding body so that it formed a drum. In playing, this drum is just as industriously used as the strings (which explains also the quite radically different way of holding the instrument), so that the melody always reverts again to pure rhythm. In a word, from a well-thought-out instrument of melody has been evolved a somewhat more complicated percussion instrument.

This also goes to show how yet undeveloped are the musical ideas of primitive peoples under the ban of an idea which always loses itself in the subtleties of the pure rudiments of sound. What the consideration of rhythmic and of instruments teaches us will be corroborated by the harmonics and melodies of primitive peoples.

Of course our chords were unknown to these peoples. Their music except in a very few particular instances, is altogether in unison. And this unison naturally does not arise from the fact that the women and children accompany the men an octave higher in the roundelays. Octaves can be made a very expressive means of harmony, as is shown in the works of Chr. Sinding and also Puccini. But among primitive peoples the octave is nothing more than a strengthened single tone.

The two following phenomena are not quite so simple a matter as the parallel octaves. The Berlin Phonogrammarchiv, which is conducted by Dr. Abraham and von Hornbostel, contains unequivocal examples of songs of primitive peoples which were sung in strict fifth intervals, and one can not disregard the fact that Leopold Mozart once heard street singers in Italy sing their little ditties in perfect fifths. Such musical talent was not a bit finer than indeed it was quite similar to—what we observe in our village musicians when they sing in fifths, though, "unfortunately," says Wallaschek very justly, "without knowing that they had done it or wishing to do it." Thus, we may conceive of the parallel fifths as well as the parallel octaves of

primitive peoples as nothing more than a more fully instrumentated unison.

But this is fully contradicted by the last and most interesting case, about which something has already been said in this article. Mr. Thurnwald, on his last expedition, recorded on a phonograph several songs of the Admiralty Islanders, concerning which, after careful analysis, von Hornbostel remarked that all the dance songs from Baluan are two-voiced, and move in seconds, and usually close with this interval. Thus, aside from occasional unisons and quite isolated cases of greater intervals, discords were exclusively used.

Not entirely isolated is this use of seconds, in the double sense of the word. It is also found in Istrian folk songs, and, further, although confined indeed to a few examples, among the Makua of East Africa and the Wolof of Senegambia. Franchinus Gafurius (*Practica Musicae*, 1496) reported that in the Ambrosian funeral litanies in Milan among other intervals are to be found also passages in seconds.

These new observations must certainly be taken into consideration, and they force us to restore again an already half-discarded hypothesis for the explanation of the above-mentioned passages in fifths in the tone art of primitive peoples. Theorists have been reminded by them of the corresponding succession of fifths in the *Organum* of the Flemish monk, Hucbald, of which we will speak again later. This comparison, as well as that of von Hornbostel with Franchinus Gafurius, is to be reflected upon. The question resolves itself into this: Can we point to that which on the one hand primitive peoples show in their parallels of fifths and seconds, and which, on the other hand, the church shows in the *Organum* of Hucbald and in the Milanese funeral litanies as a budding complexity of tones, or must we not rather conceive of it as a deterioration, as the unmeaning curtailment of a harmony of tones rich in sense, which is practiced outside the circle of influence of primitive peoples, as of the church, and by whom it was only borrowed and misused?

I will not anticipate, but I must indeed bring out here the fact that in the case of the church only the second supposition, that of a deterioration, is tenable. And it is not otherwise in the case of the primitive peoples. Their passing relation to higher musical development is shown just as plainly in their parallel of fifths and seconds as also in the quality of their finer melodic instruments. But, just as hopelessly as, with their dull music perception, the borrowed instruments of finer quality were sacrificed in a gradual deterioration, just so irretrievably were sacrificed the elements of harmony. They may have taken over the elements in their pure and noble forms, but these forms must necessarily have with them deteriorated into such musical hybrids as their parallel fifths and seconds.

We will now pass to the consideration of the intervals which are characteristic of the music of really primitive peoples. Earlier it was

the commonly accepted supposition that at first large intervals (octaves, fifths, and fourths, especially) received most attention, and that between these wide intervals smaller and smaller ones were gradually interpolated. This hypothesis is ethnologically untenable. Ethnological observation shows, on the contrary, with what caution the melodies of primitive peoples move upward and downward in the smallest intervals. If we would understand the oldest system of tones, we must hear songs like those of the Veddas in Ceylon, which are sung almost wholly in seconds. Even smaller intervals are distinguished with great certainty, though to our anharmonic ear they no longer present differences.

That there are quarter tones you become painfully aware in the execution of every singer who sings off the key, and every good violinist demonstrates it when in reaching up for C-sharp he strikes somewhat higher than he does when sliding down for D-flat, which on the piano is identical with it. The Arabians make a distinction even to-day between the anharmonic tones, so that their chromatic scale, instead of 12 tones, contains 17. Since the phonograph has afforded us exact measurement, we know that these finest differences are much more clearly distinguishable to the horizontal music perception than to our vertical music perception. It is certain that quarter tones are known among the Australians, the Maori, and the inhabitants of Nukahiwa. One feels great respect for the perception of absolute pitch among primitive peoples when one learns that in Samoa the alarm drums of each island are tuned to a different pitch, and that any of them can be identified by the neighbors of those striking the alarm. Such delicacy of ear is with us not at all a trait of every musician, and it explains to us the fact that for the development of the most varied melodies the range of a minor third was sufficient among primitive peoples. Karl Hagen describes incidentally how in an Australian battle-song the sudden transition to such a minor third gives an effect like the "overpowering expression of pain"

The Mincopie in the Andamans may, according to present information, stand as the most perfect in this primitive art of producing music. All their melodies move around one tone from which they vary, to our ear, only a half tone upward and a half tone downward. But both the minor seconds, into which the musician must condense all his ideas, appear richer in life than we would suppose. Portmann has made a more precise study of this music, and he believes that transitions even so slight as an eighth of a tone must be considered. Thus there may be melodies here which our broader art perception pays no attention to. The monotonous up-and-down movement of these songs is rhythmically accompanied by hand clappings and the striking of the pukuta, a simple slab, which lies on the ground and is played with the heel.

It seems impossible to find anything more primitive than such a tone art, which compresses a brief motif into the range of a second repeated untiringly. Yet the songs of the Andamans themselves are rather more music than rhythm, and as such they portray a higher stage of development. As the bull-roarer, the oldest and most sacred instrument, had not yet attained a firm, definite, well-bounded tone, so also the oldest, Shamanic-practiced vocal music can have known at first only indefinite melodies. Its curve shows a regularly rising and falling wave line, and not the step form of the later melody. It was a gliding of the voice, not a progression by steps. For the magician who exorcises the storm or the hunter who imitates the cry of a beast, the eighth tones of the Andaman music constitute a melody in steps.

Combining all of the foregoing, we may formulate it briefly somewhat as follows: Wherever in the music of primitive peoples large intervals are found, and a melody related to our own, we there have to do with a secondary condition, an element foreign to the oldest of human music. Older than the large intervals are the small ones, which through a well-developed feeling for rhythm were artistically ordered. Still older, however, than the feeling for distinct rhythm and for all intervals is the feeling for gliding melody and finally for the simple elements of sound.

In other words, the apparently quite simple and elementary music of primitive peoples shows, on closer inspection, a threefold stratification: (1) The music of the magician (developed in a preanimistic period); (2) music as rhythm (developed first in an already past epoch of social organization; it may remain undecided whether here we should with Wallaschek recall war songs and hunting songs, or with Bücher call to mind labor songs); and (3) music as melody (developed first in contact with peoples in a higher stage of culture).

It is necessary now to examine more closely how these strata are separated and how one followed upon the other. This is, however, impossible unless we first make it clear how the most primitive music is related to the tone art of ancient Europe, from which our music has developed.

2. PREHISTORIC EUROPEAN MUSIC.

Fontaine narrates in an occasional poem how, in walking through Copenhagen, his attention was attracted to a placard with the heading, "Luren Konzert." He asked his companions what "Luren" meant, and it was explained to him thus:

Luren, in the days of the Gotones and Getæ,
 Our Northland trumpets were called.
 They were horns seven feet long.
 Their sound was a battle call.
 The Luren, long before Gorm the Old,
 Sounded over moor and heath.

“Long before Gorm the Old”—as archeologists we know that long before the days of the Gotones and Getæ—these strange giant horns were cast. They are recognizable already in the northern Bronze Age—more exactly in the second period (according to Montelius); that is, in the fourteenth or fifteenth century B. C. They are found in southern Sweden and Norway, Denmark, Schleswig-Holstein, Mecklenburg, and Hanover—lands therefore, of the North-German-Scandinavian culture circle, toward which Germanic primitive history gravitates. With these luren the history of our familiar European music begins.

It is truly with beautiful and inspiring sounds that it thus begins. The luren can still be played upon to-day. Their sound is soft and full, having somewhat the character of our old trombones. The deep, funnel-shaped mouthpiece also corresponds to that of our trombones, while the system of its tube, which is conical throughout its length, corresponds to that of the modern French horn. Twelve tones, in three and a half octaves, can be drawn from the instrument with ease, and a clever performer can increase the number to 22. It has been attempted to make exact casts of the luren, but this has not succeeded. The inner surface of the walls, which are only 1 to 1.5 mm. thick, we are unable to make as smooth as in the original instruments, and it is exactly this smoothness which is required for the perfect purity of the tone.

But we are not the only ones to whom this technology is unknown. Even in the time of the luren people it was not understood outside of the North-German-Scandinavian culture circle. We have no such perfect musical instruments from any other region, hence we can say that a single tone from the tube of the luren, in its radiant purity, dissolves into nothingness all those fantastic pictures which represent to us the German Northland as having been the home of a half-wild, barbaric people who, in their culture, did not admit of any comparison with those of the South and East.

In 1892 some luren were brought into use at a meeting of the Antiquarian Society of Copenhagen by a number of concert players. A report on this noteworthy session may be found in the *Zeitschrift für Ethnologie* for 1892. The admiration was greatest when the musicians without difficulty played some folk songs and marches. This was possible on account of the large intervals of the luren, which are in the natural key. With such instruments at hand a return would not be made to the monotony of a rigid horizontal music. Thus the luren furnish us clear proof that already more than 3,000 years ago Europe possessed its characteristic music, and that on this music is based our present musical perception, which is so sharply differentiated from that of primitive peoples.

But there is still another conjecture of much deeper import which arises through the discovery of the luren. Angul Hammerich first pronounced the opinion in the "Memoirs of the Antiquities of the North" that the luren-folk might already have been acquainted with a well-developed two-voiced music, which corresponded to our harmony in all essential elements. It must be remarked that the luren performers were always depicted in pairs; as, for example, in the Hälle designs and the well-known tablet of the civic monument. In agreement with that, the luren themselves are almost always found in pairs. They are always similarly shaped and correspond exactly not only in size and ornamental decoration but are tuned exactly to the same pitch. The possibility arises from this that the two luren players played in unison, but it is not clear why one would wish to hear the same notes from two players. There is a strong probability that the intervals of the two luren were the same. Our folk songs progress in thirds and sixths bound together by fifths and fourths when they are sung as duets. In this form also the luren performers could play them perfectly well. It is probable at least that the luren people were already familiar with two-voiced songs, and that our two-voiced hunting signal already resounded in the German primeval forest. Such a view becomes almost a certainty when we see how the historical knowledge of the primitive history of polyphony leads us back again into the German Northland, and to the secular folk-songs found there.

To a musician there is no need of proof that a people who had luren must also have known of stringed instruments of a well-developed kind. The oldest literary testimony regarding northern stringed instruments reaches back only to Diodorus, who describes the satirical songs and the hymns of the Celts and Germans, who accompanied themselves with lyre-like instruments. Three Gallic coins of the time of Caesar acquaint us with the form of these instruments. They correspond throughout with the oldest Greek stringed instruments. From a sounding board a horn rises on the right and another on the left, and the horns are bound together by a crossbar from which the strings extend to the sounding board.

The northern origin of this instrument was, moreover, probable. Greece had not possessed instruments of this kind for a long time when that money was coined, and it is not to be supposed that the Celts and Germans busied themselves with classical antiquarian studies. There is an old traditional saying according to which the ancient Greek zither was of Thracian origin. Direct testimony of a prehistoric kind for the confirmation of this idea was desirable, and this we have now had since 1892. Near Marz in Hungary were found the well-known black urns with figured designs (illustrated by

Hörnes), and Fleischer recognized on one of them a player with a four-stringed lyre which corresponded exactly with the form on the Gallic coins.

The further developmental history of the northern lyre places us in the fortunate position of being able to make some assertion regarding the tuning of the strings. Fleischer has here already drawn the necessary conclusions. The next higher type above the Marz form we have in the celebrated Lupfenberg find dating from about the fourth to the seventh century of the Christian era and now in the Berlin Museum. The instrument is no longer three-stringed, but six-stringed. This old German instrument is itself again the unmistakable link between the Marz type and the West European chrotta, which was already mentioned by Venantius Fortunatus, and continued in existence in Ireland, Wales, and Brittany until the beginning of the nineteenth century. The thick strings of the chrotta are tuned to the fundamental tone, the fourth, and the fifth of a lower and the next higher octave. In the seven-stringed instruments the last string repeats the fundamental tone higher up. On account of the enduring persistence of folk customs there can be no doubt that the three or four strings of the oldest northern zithers were tuned in the same way. It is to be observed, further, according to Boethius, that the oldest Greek zithers were likewise tuned to the fundamental tone, fourth, fifth, and octave. They are the constant, unchanging intervals of the entire European music system.

The luren and lyres indicate such a distinct and purposeful music that one can believe that the discovery of the crudest notation must have insured for it the highest and quickest development. But it did not reach this development until very late. An entirely stagnant and musically sterile century intervenes between that first epoch of the foundation and that other one of the development. In this period the development of the vertical European music was interrupted by something which in its kind was remarkably similar to certain musical developments of the South and East, namely, the old church music.

3. THE MUSICAL SENTIMENT OF EARLY EUROPEAN CHRISTIANITY.

The words "church music" have for us to-day a very beautiful sound. We think of Palestrina or of Bach and the hundred-voiced choirs and organ music. All surge together in a mighty and majestic harmony, a wonderfully sublime music, which at the sound of the church bell dominates wide stretches of country. That so much beauty could not come to us fully complete is clear without further explanation. The foundations of the whole we owe to the church. We are reminded here of an old and quaint misconception. Gustav Freytag gives the

best expression to this when, in his "Pictures of the German Past" he muses on how solemnly the first bells must have sounded in the German primeval forest. Now these first church bells were small instruments made out of pieces of tin and iron nailed together and hung in clumsy wooden frames, and their sharp tinkling was certainly not an agreeable sound. What we call church music, however, has no other relation to the musical art of early Christianity than that which the sound of our splendid church bells has to these miserable tinklings.

We have at present the opportunity of demonstrating the effect of the old Christian church music in the numerous forms of the liturgic songs which the church has preserved with exact fidelity, at least as regards their tune. Among all these forms there is scarcely a more eloquent one than the responsive chant of the litany on a fast day. Regarding the significance and the range of the idea of the *cantus planus*, or plain song, one may dispute, but what *musica plana*—that is, even, compact music—means, everyone knows who has once felt the charm of the powerful liturgic songs. The monotony of these songs, which we, fascinated, can not discern as coming from any particular place, and of which the lively rhythm of the words does not relieve the rigidity benumbs the senses and makes them susceptible of suggestions of all kinds. It is entirely immaterial what immediate origin one may assign to the old Christian psalmody, whether to the Jewish responsive chanting, the Greek ceremonial music, or (as is made probable by the latest investigation of music) the joint spoken prayer that the priest pronounces first and the congregation repeats after him, always in the same restrained penitent tone, one may say, which characterized the litany. The essential fact is that the clear and unmistakable general character of the old Christian psalmody approaches the primitive horizontal music, and that it is entirely foreign to the characteristic European feeling.

Attempts are constantly made in certain quarters to ascribe to the oldest church music a definite sensuous beauty which it can not have had. The *cantus planus* itself must be a very late development and identical with the *cantus firmus*, a firm principal part around which a series of subordinate parts are woven. From such beginnings it is not possible to explain any litany, or indeed any later choral. It can not have been different with music than with the structural arts. We see the Christians taking over the types of classical art, but with their transference the old life was unfavorably affected. The ancients thought in marble and bronze, while Christendom, like priestly Egypt, thought in granite, and a granite saint must hold the same relation to a Greek statue as the early church music to the musical art of antiquity. A really free, lightly moving music would have been the wildest disturbance in the early Christian church.

The bishops and popes, moreover, knew how to preserve the simplicity of their granite style.

Our picture would be incomplete if we did not bring to mind what the ecclesiastical authority made out of the social position of singers and performers. We know how highly singers were appreciated in the old courts, what esteem the "Skopen" had, and the noble forms of Volker and Hiorand are familiar to us from the *Nibelungen Lied*. The church knew how to break down this universal respect. In the eyes of its authorities the singers and performers were worthless vagabonds. Though they were the pride of the hall, they were branded by the church as "the children of the devil," and as homeless "Himmelsreiche" were chased into the highways, where they might associate with other wandering people, jugglers, quacks, and jesters.

A tribe of really worthless vagabonds, it is true, associated with the minstrels. They were the musicians of the South, who left Rome and Italy because the church was uncongenial to them. One knew how to distinguish sharply between these wandering and worthless people and the respected native musicians. But as the church then also counted these northern musicians among the worthless, in so far as they clung to heathenish traditions, these distinctions were obliterated. In the "Saxonspiegel" the interpretation of the church became a law, according to which a player was as much an outlaw as a thief or an outcast. Under the Swabian and Bavarian law he was only allowed in cases of violent assault to strike the "shadow of his tormentor." Those were quite other times than the ones in which the "Lex Anglorum et Warinorum hoc est Thuringorum" punished those who injured the hand of a harper four times as severely as those who injured the hand of another freeman.

Just as little as the good heathenish practices and legends could be taken away from the people by the most heedless fanaticism, just so little could the heaviest ban of the church destroy that which the despised and condemned musicians took with them out onto the highways. In the midst of their necessities these musicians kept pure the traditions of European music and we have to thank them, before all, that finally in the unwelcomed introduction of polyphonic music Europe had again resisted the Orient as regards musical art.

4. EVOLUTION OF POLYPHONIC MUSIC.

It is the last musical phenomenon with which we are occupied here. The erroneous views which are current even in many scientific circles regarding the origin of harmony oblige us to digress a little further. According to an old assumption, the first intervals which were perceived both as connected tones and as expressively

beautiful ones were—after the octave—the fifth and the fourth. We have seen that the octaves in our music have obtained a certain value of expression. The same is the case with open fifths and fourths, which for chaotic and terrifying parts are almost a kind of musical hieroglyphics; for example, the introduction to Beethoven's ninth symphony which the open fifth dominates, and the entrance of the marble statue in Don Juan which the powerful fourth intervals of the drums characterize. The fourths and fifths have such a value of expression only in very rich and deep harmony. In themselves both intervals are just as neutral and inexpressive as the octave. It is quite intelligible that in part songs the upper or lower voices are placed in the fifth or fourth and that in the alternations both voices occasionally hit upon these intervals. Such a combined tone would naturally, however, not be perceived as expressive, but only as a more clearly accentuated unison.

Notwithstanding, only recently musical theorists have asserted with great definiteness that the polyphonic European music began with open fourths and fifths. The assertion was supported with many noteworthy citations from the "De Harmonica Institutione," dating from about 880 A. D., which is ascribed to the Flemish monk, Hucbald. The organum, or diaphony, of Hucbald introduces as a novelty the progression of the melody in open fifths and fourths, or diapentes and diatessarons. Now in our textbook of harmony the first rule is a strong prohibition of parallel fifths and fourths. The prohibition is based not on cold theory but on the distinct recognition of the fact that the sound of such parallels is extremely disagreeable. One must be very obtuse musically not to perceive this. If Hucbald enthuses over the "lovely harmony which arises from such a combination of tones," he may indeed have been a great scholar, but he was certainly an extremely bad musician, and we must ask ourselves whether the good monk did not involve his church in a fundamental misunderstanding by taking up the polyphony practiced outside the church, of which, from the schooling he had received from Boethius, he had grasped only the merest rudiments.

The newest investigations of music have fully established this view. The work "De Harmonica Institutione" appeared about 880 A. D. At least 30 years earlier Scotus Erigena published his "De Divisione Naturae." We will, following Hugo Riemann's "History of the Theory of Music," listen to a critical passage out of this old work. It says:

The song called organum consists of tones of different kinds and pitch which now sound separately from each other in wide intervals in a well-ordered relation, and now, in accordance with a certain established rule of the art applicable to the different styles of church music, come together and thus produce a naturally pleasing harmony.

From this passage two things are clear—first, that with the discovery of the so-called organum Hucbald had nothing to do, that it

was a musical form which was known long before and commonly practiced outside the church; second (and this is more important), that the earlier form was more richly developed. What Scotus Erigena described is a two-toned theme in its highest development, and hence beyond mere third and sixth progressions. Thus the fact is established that long before the church the people knew the two-part theme and that the ecclesiastical recognition of this musical form did not promote it, but on the contrary checked it. The reaction did not stop with Iluebald. Lederer remarked in his book, "On the Home and Origin of Polyphonic Music," as follows: "The church in the Middle Ages evidently assumed the most hostile attitude toward polyphony as an art foreign to its fundamental principles, and we could produce instances from Germany, France, England, and even from Iceland, in which the church authorities took action against polyphony. Pope John XXII finally, in the year 1322, in the bull 'Docta Sanctorum,' solemnly expelled it, rooted it up from the ground, and rejected it." Polyphonic music was disseminated through Europe, not through but in opposition to the church.

The question may be asked where its sources are in reality to be looked for. This has received different answers. Fétis has assigned it to the Normans, Guido Adler to the old folk songs, and Lederer to the people of Brittany, while Fleischer and Geraldus Cambrensis point to the Danes and Norwegians. Others allude to the construction of certain secular instruments that can only be played in intervals. The most important are the oldest violins, three-stringed instruments, in which for a long time the bridge was wanting, but afterwards when introduced was cut off horizontally so that the strings had to be played in unison. Two things are common to all these investigations—first, that all polyphonic music is north European, and, second, that it is of secular, or at least of heathen, origin. As archeologists we must contend against the acceptance of such an origin as inconceivable, and if we have any hypothesis to propose it is that the beginnings of polyphonic music lie very much further back, that the Luren people were long familiar with it, and that it is not absurd to hold that the two-voiced music is as old at least as the Germans.

It is rather an idle question as to which intervals were first clearly grasped as such, which, to employ a comparison of Stumpf's, first combined themselves into a firm skeleton, while the others still remained the weak parts of the musical body. It is possible that in the sound of the so naturally produced octaves, fifths, and fourths the knowledge of intervals first dawned. Not in these fixed and therefore inexpressive intervals which are common to both kinds of scales could music have become an art in the highest sense, but through the active intervals by which the major and minor scales change, especially the thirds and sixths. The sharp produces the

major scale, the flat the minor scale, and when one had first recognized these differences, namely, the wide, light scale of major third and sixth and the narrow, dark scale of the same minor intervals, the differentiation was first accomplished. The simplest experiment can convince us of this. A melody in the major or even in the minor third is exactly as dull and intolerable as a similar one in pure fifths or fourths. The varying light and shade in constant changes from the major to the minor third produce the intrinsic life. With the introduction to these contrasts music became a really plastic, three-dimensional art.

Only one question remains now to be answered. A harmonic perception that can so clearly distinguish between large and small intervals is conceivable only when the so-called principle of tonality has been long established; that is, when the ear has become accustomed to place every single tone of the melody in relation with a dominant fundamental tone from which the theme proceeds and to which it returns. There has been much controversy as to how the development of this sense of tone is to be regarded. It is agreed that the fundamental tone which we to-day employ as a measure for a long time accompanied the melody audibly. The bagpipe, with its drone, serves as the classical instrument which offers this *pons asinorum* to the unpracticed ear. Regarding the antiquity and origin of the bagpipe nothing definite can be said. It is indeed not necessary to wait for the discovery of the facts. As we know, the drums of primitive people are often pitched to quite definite tones, and if their regular rhythm accompanied the song, we have here already a kind of organ point. Incidentally it may be remarked that in the language of the orchestra the throbbing repetition of the same notes in the bass is called a drum bass.

The case of the drum organ-point of primitive people, which was universal, is very similar to that of the discovery of a steam engine. Primitive people boiled water, and with them, as elsewhere, the steam raised the lid of the kettle, but a black Papin is unthinkable. Now, turning to our own case, in the perception of the intervals which are produced by accompanying the melody with a persistent fundamental tone lies the origin of vertical hearing. These intervals could, however, only be heard by a people which through its culture had been trained to it in the necessary manner.

5. THE INCORPORATION OF THE FOREGOING MATERIALS INTO CULTURE HISTORY.

We shall confine ourselves to the most important points.

The beginnings of music lead us back to that important stage of history that is dominated by superstitious beliefs. It is concerned with the cosmology which precedes all animism. Its traces are still

to-day everywhere recognizable in the greatest profusion, an evidence of how long it must have had power over mankind. The clearest example is perhaps the so-called picture magic. The facts are well known. A man obsessed by superstition (to take a commonest example) believes in the power of affecting existence that his mere corporeal image possesses. Hence the so common fear of the photographic camera. Portions of the body, such as clippings of hair and nails, can, in magic homeopathy, produce evil effects. To this circle of conceptions belongs also black magic, which extends back into remote historical times and in which people still believe. Andree gives some very interesting examples of it in his essays on "Sympathy Magic," and "Pictures rob the Soul" ("New Ethnographical Parallels"). It is the same with amulet and talisman beliefs, and the idea of the pious Italian to insure for himself the protection of the particular saint whose image he carries in his bosom. In the luck penny which our children carry in their purses to attract other pennies the last dim trace of this superstition remains.

In its beginnings this entire magic art was not so stupid. Napoleon was accustomed to write down a name which he wished to remember and to throw away the slip of paper after he had learned the picture of the letters. Our whole mnemonic system is based on the same principle. So, likewise, did the oldest belief in picture magic have an entirely rational and purely empirical basis. The one who "hit the quarry" best in a picture had the most fundamental training in observation and thereby the best prospect to strike the prey in reality. This explains the oldest practice of this art of drawing which must once have been thoroughly systematic. We have its precious remains in the celebrated paleolithic cave and rock pictures.

Observation of the naturalistic beginnings of belief in magic on the one hand and of its later mystic developments on the other show us two strong evolutionary contrasts. From an originally rational belief a magic belief has developed later. That is the course of development as regards picture magic and it is in no wise different as regards tone magic which precedes all genuine artistic music.

The oldest sound magic was also entirely rational. The observances in the two agree. It is a kind of sound magic when advancing troops make an attack with hurrahs, and the strange war songs of various savage peoples, so often described, are also sound magic. A horde of Maoris and a troupe of Prussian soldiers act here under the same hypothesis. This magic reaches back, moreover, to the Hunting Age (if we may mention this epoch briefly here without taking up the subject of the very important results of the researches of Ed. Hahn). In this, the hunters of the Old Stone Age differed in nothing from their living representatives, when they imitate the black cock,

or whistle as bird catchers. Just as clever magic pictures of the primitive hunting art consisted of the drawings in caves and on rocks the sound magic art was represented by the celebrated animal pantomimes, in which the animal voices were reproduced with much exactness.

A word may be said regarding these pantomimes. It was formerly a favorite idea of the culture theorists, that in the animal pantomime something like a foreshadowing of a universal art work was to be seen and hence an uninteresting art performance. As a result of the observations of Lichtenstein, Catlin, and Reade that view is no longer possible. Yrjö Hirn in his book on the origin of art remarks quite correctly that "the pantomimes have in reality just as practical a purpose as the lifelike pictures of animals with which hunters in all parts of the world endeavored to attract their game within reach. In accordance with the theory of sympathetic magic it is merely a self-evident fact that the representation of a thing at any distance can influence the thing itself, and that in this way a buffalo dance, even performed in the camp, can compel the buffaloes to come within reach of the hunters.

The deceptive appearance of an absence of utility, which in this case could lead to the error of mistaking a mere example of hunting magic for a display of pure dramatic art, makes one cautious about regarding any performance of primitive men as purely esthetic.

Sound magic, however, also arrived at a mystic stage in which it no longer sought to exorcise visible beings but demons. We have learned to recognize some of the phenomena of this stage, for example, the use of "bull roarers" by weather magicians. In the same manner the Basutos employ their rain flutes in times of drought. Other primitive peoples by whipping the water imitate the sound of rain which they may thus bewitch. Very instructive as regards this psychology is an anecdote which Mason relates of the Pueblo Indians. In making a sounding vessel the women imitate with their voices the sound of a well-burned vessel in order that these good qualities may be carried over to the unfinished piece.

A noteworthy sound-magic phenomenon which is reported of the Arabs gives us a clew as to how the originally so naturalistic belief slowly changes into the animistic. To the Arabs whistling is somewhat sinful. In whistling sounds they hear the "whispering of the spirits." The sound of the wind is to them the voice of the departed. It follows, therefore, quite properly that the spirits which are, however, feared are called by whistling. When the traveler Burckhardt whistled before the Hejazis they believed that he spoke with the devil.

The sound magic finally became fully mystic and occult in the fetish drums and their curious manipulation. This mystic sound

magic is related to the natural magic of primitive times just as in Egyptian art the strongly stylistic form of the new empire is to the realistic natural form of the older. If we compare with the crudely simple rhythm of an incessantly beaten fetish drum, the dramatically presented complexity of a swiftly moving animal pantomime, the later state of musical development displayed in the drumming appears as an almost incomprehensible impoverishment. But there also Egypt is to be remembered. The rigid style of the new empire only appears cruder when we separate the works from their environment. In the cultural entity it is shown that what is historically later is also higher as regards development. The richest animal pantomimes themselves in all their complexity do not go beyond the imitation of noises, but the rudest fetish drumming itself offers, instead of noise, tone. Here music first takes its beginning as art. In the monotony of a tone-art realized by the shaman the hearing found its first methodical schooling, and so here also the later is the higher from an evolutionary standpoint in spite of all apparent degeneration.

In the magical and mystical fetish drumming we observe for the first time how that element comes forth more strongly which in the following epoch dominates the whole musical development--namely, rhythm. The next problem as regards culture history would be then to determine how from this rhythm, which is strange to us, could spring the one we know.

I believe here a significant remark of Livingstone's which is found in the books is of great importance. Livingstone said that in his caravan he had been able easily to pick out the former slaves from all the rest. The sound of the drums and of the kudu horns appeared to call up a kind of "esprit de corps" in all those who were once slaves. It is not a very pleasing idea to think of a music which passes threateningly over the heads of the natives like a whip. But the tone-art has also gone through this metamorphosis.

To repeat, there are two kinds of rhythm for us to recognize; the free and refreshing rhythm of a later time and the doleful, disquieting rhythm of an earlier day. In the doleful rhythm of the sacred percussion instruments, like the drums, there was given to the shaman a power from the influence of which only those with the strongest wills could remain sheltered. Bücher is opposed to the supposition that such a will can be practiced as a power only by a ruling cast, by a stronger stock, which dominates over the weaker and presses them into its service. It may be that more extensive data must be collected as a foundation for this assertion. The probabilities even to-day, however, point toward the truth of the two-class theory, as applying to the distant antiquity of the Old Stone Age. This is certainly true, that the development of the tonal-art, as long as music

consisted of rhythm, derived all its essential qualities, not from the conflict between shaman and layman, but that between lord and slave, between command and labor.

The history of the refrain shows us how this rude rhythm disappears more and more, and how music as melody constantly gains in extent and significance. The oldest refrain divides the work songs measure by measure with the precision of clockwork. Their rhythm is as monotonous as that of the drum, and they themselves are so completely mere sound, and not melody, that Bücher designates them as mere animal cries—the groans of labor become, as it were, tone. In the strange conflict between the little interspersed particles of melody and the recurring dull rhythm of the refrain ethnologists are able to read many things. The free style of the leader is an expression of the dominating and compelling caste, which is more mature as regards development. The rigid regularity of the refrain, however, forced upon the chorus, is the whip-rhythm of Livingstone. It is that hypnotic music which was taken from the shaman by the secular power, and by this the secular power held the masses in bondage.

We have seen how the beginnings of music as an art lay enthralled, and have sought the outlet which led from this condition of captivity to greater freedom. No savage people, so long as they remain uninfluenced, can rise above a certain grade of horizontal, two-dimension music. It is Europe, and the dominating races of the north of Europe, that have rendered this decisive service. This possibility arose from the purer, more intellectual atmosphere, which developed the gloomy death cult of earlier times into the freedom of the sun cult. From the cave cult of the south and of the less developed races has come the high cult of the north. The thought and feeling of the northern races was joined to a freer and broader cosmogony, and to this greater freedom we owe the beginnings of our European music.

EXPEDITION TO THE SOUTH POLE.¹

By ROALD AMUNDSEN.

The plan of the third *Fram* expedition was twofold: First, the attainment of the South Pole, and, second, the exploration of the north polar regions. This evening I have the honor to report to you on the accomplishment of the first part of this plan.

I can only briefly mention here the expeditions which have worked in the region which we had selected for our starting point. As we wished to reach the South Pole, our first problem was to go south as far as possible with our ship and there establish our station. Even so, the sled journeys would be long enough. I knew that the English expedition would again choose their old winter quarters in McMurdo Sound, South Victoria Land, as their starting point. From newspaper report it was known that the Japanese had selected King Edward VII Land. In order to avoid these two expeditions we had to establish our station on the Great Ice Barrier as far as possible from the starting points of the two other expeditions.

The Great Ice Barrier, also called the Ross Barrier, lies between South Victoria Land and King Edward VII Land and has an extent of about 515 miles.² The first to reach this mighty ice formation was Sir James Clark Ross in 1841. He did not dare approach the great ice wall, 100 feet high, with his two sailing ships, the *Erebus* and the *Terror*, whose progress southward was impeded by this mighty obstacle. He examined the ice wall from a distance, however, as far as possible. His observations showed that the Barrier is not a continuous, abrupt ice wall, but is interrupted by bays and small channels. On Ross's map a bay of considerable magnitude may be seen.

The next expedition was that of the *Southern Cross* in 1900. It is interesting to note that this party found the bay mentioned above at the same place where Ross had seen it in 1841, nearly 60 years before; that this expedition also was able to land a few miles to the

¹ Lecture delivered in German by Roald Amundsen before the Berlin Geographical Society on Oct. 9, 1912. Translated and reprinted from the *Zeitschr. der Gesell. für Erdkunde zu Berlin*, 1912, No. 7, pp. 481-498. Here reprinted by permission from *Bulletin of the American Geographical Society*, vol. 44, No. 11, November, 1912. New York, pp. 822-838.

² All values have been changed from the metric system to English equivalents.

east of the large bay in a small bay, named Balloon Bight, and from there to ascend the Ice Barrier, which heretofore had been considered an insurmountable obstacle to further advance toward the south.

In 1901 the *Discovery* steamed along the Barrier and confirmed in every respect what the *Southern Cross* had observed. Land was also discovered in the direction indicated by Ross, namely, King Edward VII Land. Scott, too, landed in Balloon Bight, and, like his predecessors, saw the large bay to the west.

In 1908 Shackleton arrived there on the *Nimrod*. He, too, followed along the edge of the Ice Barrier. He came to the conclusion that disturbances had taken place in the Ice Barrier. The shore line of Balloon Bight, he thought, had changed and merged with the large bay to the west. This large bay, which he thought to be of recent origin, he named Bay of Whales. He gave up his original plan of landing there, as the Ice Barrier appeared to him too dangerous for the establishment of winter quarters.

It was not difficult to determine that the bay shown on Ross's map and the so-called Bay of Whales are identical; it was only necessary to compare the two maps. Except for a few pieces that had broken off from the Barrier, the bay had remained the same for the last 70 years. It was therefore possible to assume that the bay did not owe its origin to chance and that it must be underlain by land, either in the form of sand banks or otherwise.

This bay we decided upon as our base of operations. It lies 400 miles from the English station in McMurdo Sound and 115 miles from King Edward VII Land. We could therefore assume that we should be far enough from the English sphere of interest and need not fear crossing the route of the English expedition. The reports concerning the Japanese station on King Edward VII Land were indefinite. We took it for granted, however, that a distance of 115 miles would suffice.

On August 9, 1910, we left Norway on the *Fram*, the ship that had originally been built for Nansen. We had 97 superb Eskimo dogs and provisions for two years. The first harbor we reached was Madeira. There the last preparations were made for our voyage to the Ross Barrier—truly not an insignificant distance which we had to cover, namely, 16,000 nautical miles from Norway to the Bay of Whales. We had estimated that this trip would require five months. The *Fram*, which has justly been called the stanchest polar ship in the world, on this voyage across practically all of the oceans proved herself to be extremely seaworthy. Thus we traversed without a single mishap the regions of the northeast and of the southeast trades, the stormy seas of the "roaring forties," the fogs of the fifties, the ice-filled sixties, and reached our field of work at the Ice Barrier on January 14, 1911. Everything had gone splendidly.

The ice in the Bay of Whales had just broken up, and we were able to advance considerably farther south than any of our predecessors had done. We found a quiet little nook behind a projecting ice cape; from here we could transfer our equipment to the Barrier with comparative safety. Another great advantage was that the Barrier at this place descended very gradually to the sea ice, so that we had the best possible surface for our sleds. Our first undertaking was to ascend the Barrier in order to get a general survey and to determine a suitable place for the erection of the house which we had brought with us. The supposition that this part of the Barrier rests on land seemed to be confirmed immediately by our surroundings. Instead of the smooth, flat surface which the outer wall of the Barrier presents, we here found the surface to be very uneven. We everywhere saw sharp hills and points between which there were pressure cracks and depressions filled with large masses of drift. These features were not of recent date. On the contrary, it was easy to see that they were very old and that they must have had their origin at a time which long preceded the period of Ross's visit.

Originally we had planned to establish our station several miles from the edge of the Barrier, in order not to subject ourselves to the danger of an unwelcome and involuntary sea trip, which might have occurred had the part of the Barrier on which we erected our house broken off. This precaution, however, was not necessary, as the features which we observed on our first examination of the area offered a sufficient guarantee for the stability of the Barrier at this point.

In a small valley, hardly $2\frac{1}{2}$ miles from the ship's anchorage, we therefore selected a place for our winter quarters. It was protected from the wind on all sides. On the next day we began unloading the ship. We had brought with us material for house building as well as equipment and provisions for nine men for several years. We divided into two groups—the ship's group and the land group. The first was composed of the commander of the ship, Capt. Nilsen, and the nine men who were to stay on board to take the *Fram* out of the ice and to Buenos Aires. The other group consisted of the men who were to occupy the winter quarters and march on to the south. The ship's group had to unload everything from the ship upon the ice. There the land group took charge of the cargo and brought it to the building site. At first we were rather unaccustomed to work, as we had had little exercise on the long sea voyage. But before long we were all "broken in," and then the transfer to the site of our home "Framheim" went on rapidly; the house grew daily.

When all the material had been landed our skilled carpenters, Olav Bjaaland and Jørgen Stubberud, began building the house. It was a ready-made house which we had brought with us; nothing had to

be done but to put together the various numbered parts. In order that the house might brave all storms, its bottom rested in an excavation 4 feet beneath the surface. On January 28, 14 days after our arrival, the house was completed, and all provisions had been landed. A gigantic task had been performed; everything seemed to point toward a propitious future. But no time was to be lost; we had to make use of every minute.

The land group had in the meantime been divided into two parties, one of which saw to it that the provisions and equipment still lacking were taken out of the ship. The other party was to prepare for an excursion toward the south which had in view the exploration of the immediate environs and the establishment of a depot.

On February 10 the latter group marched south. There were 4 of us with 18 dogs and 3 sleds packed with provisions. That morning of our start is still vividly in my memory. The weather was calm, the sky hardly overcast. Before us lay the large, unlimited snow plain, behind us the Bay of Whales with its projecting ice capes and at its entrance our dear ship, the *Fram*. On board the flag was hoisted; it was the last greeting from our comrades of the ship. No one knew whether and when we should see each other again. In all probability our comrades would no longer be there when we returned; a year would probably elapse before we could meet again. One more glance backward, one more parting greeting and then—forward.

Our first advance on the Barrier was full of excitement and suspense. So many questions presented themselves: What will be the nature of the region we have to cross? How will the sleds behave? Will our equipment meet the requirements of the situation? Have we the proper hauling power? If we were to accomplish our object, everything had to be of the best. Our equipment was substantially different from that of our English competitors. We placed our whole trust on Eskimo dogs and skis, while the English, as a result of their own experience, had abandoned dogs as well as skis, but, on the other hand, were well equipped with motor sleds and ponies.

We advanced rapidly on the smooth, white snow plain. On February 14 we reached 80° S. We had thus covered 99 miles. We established a depot here mainly of 1,300 pounds of provisions, which we intended to use on our main advance to the south in the spring. The return journey occupied two days; on the first we covered 40 miles and on the second 57 miles. When we reached our station the *Fram* had already left. The bay was lonely and deserted; only seals and penguins were in possession of the place.

This first excursion to the south, although brief, was of great importance to us. We now knew definitely that our equipment and our pulling power were eminently suited to the demands upon them.

In their selection no mistake had been made. It was now for us to make use of everything to the best advantage.

Our sojourn at the station was only a short one. On February 22 we were ready again to carry supplies to a more southern depot. We intended to push this depot as far south as possible. On this occasion our expedition consisted of 8 men, 7 sleds, and 42 dogs. Only the cook remained at "Framheim."

On February 27 we passed the depot which we had established at 80° S.; we found everything in the best of order. On March 4 we reached the eighty-first parallel and deposited there 1,150 pounds of provisions. Three men returned from here to the station, while the five others continued toward the south and reached the eighty-second parallel on March 8, depositing there 1,375 pounds of provisions. We then returned, and on March 22 were again at home. Before the winter began we made another excursion to the depot in 80° S., and added to our supplies there 2,400 pounds of fresh salt meat and 440 pounds of other provisions. On April 11 we returned from this excursion; this ended all of our work connected with the establishment of depots. Up to that date we had carried out 6,700 pounds of provisions and had distributed these in three repositories.

The part of the Barrier over which we had gone heretofore has an average height of 165 feet and looked like a flat plain which continued with slight undulations without any marked features that could have served for orientation. It has heretofore been the opinion that on such an endless plain no provisions can be cached without risking their loss. If we were, however, to have the slightest chance of reaching our goal we had to establish depots, and that to as great an extent as possible. This question was discussed among us, and we decided to establish signs across our route, and not along it, as has been generally done heretofore. We therefore set up a row of signs at right angles to our route—that is, in an east-west direction from our depots. Two of these signs were placed on opposite sides of each of the three depots, at a distance of 5.6 miles (9 kilometers) from them; and between the signs and the depot two flags were erected for every kilometer. In addition, all flags were marked so that we might know the direction and distance of the depot to which they referred. This provision proved entirely trustworthy; we were able to find our depots even in dense fog. Our compasses and pedometers were tested at the station; we knew that we could rely upon them.

By our excursions to the depots we had gained a great deal. We had not only carried a large amount of provisions toward the south, but we had also gained valuable experience. That was worth more and was to be of value to us on our final advance to the pole.

The lowest temperature we had observed on these depot excursions was -50° C. The fact that it was still summer when we recorded

this temperature warned us to see that our equipment was in good condition. We also realized that our heavy sleds were too unwieldy and that they could easily be made much lighter. This criticism was equally applicable to the greater part of our equipment.

Several days before the disappearance of the sun were devoted to hunting seal. The total weight of the seals killed amounted to 132,000 pounds. We therefore had ample provisions for ourselves as well as for our 115 dogs.

Our next problem was to supply a protective roof for our dogs. We had brought with us 10 large tents, in which 16 men could easily find room. They were set up on the Ice Barrier; the snow was then dug out to a depth of $6\frac{1}{2}$ feet inside the tents, so that each dog hut was nearly 20 feet high. The diameter of a dog hut on the ground was 16 feet. We made these huts spacious so that they might be as airy as possible and thus avert the frost which is so injurious to dogs. Our purpose was entirely attained, for even in the severest weather no dogs were frozen. The tents were always warm and comfortable. Twelve dogs were housed in each, and every man had to take care of his own pack.

After we had seen to the wants of the dogs we could then think of ourselves. As early as April the house was entirely covered by snow. In this newly drifted snow passageways were dug connecting directly with the dog huts. Ample room was thus at our disposal without the need on our part of furnishing building material. We had workshops, a blacksmith shop, a room for sewing, one for packing, a storage room for coal, wood, and oil, a room for regular baths, and one for steam baths. The winter might be as cold and stormy as it would, it could do us no harm.

On April 21 the sun disappeared and the longest night began which had ever been experienced by man in the Antarctic. We did not need to fear the long night for we were well equipped with provisions for years and had a comfortable, well-ventilated, well-situated and protected house. In addition, we had our splendid bathroom where we could take a bath every week. It really was a veritable sanatorium.

After these arrangements had been completed we began preparations for the main advance in the following spring. We had to improve our equipment and make it lighter. We discarded all our sleds, for they were too heavy and unwieldy for the smooth surface of the Ice Barrier. Our sleds weighed 165 pounds each. Bjaaland, our ski and sled maker, took the sleds in hand, and when spring arrived he had entirely made over our sledge equipment. These sleds weighed only one-third as much as the old ones. In the same way it was possible to reduce the weight of all other items of our equipment. Packing the provisions for the sledge journey was of the greatest

importance. Capt. Johansen attended to this work during the winter. Each of the 42,000 loaves of hard bread had to be handled separately before it could be assigned to its proper place. In this way the winter passed quickly and agreeably. All of us were occupied all the time. Our house was warm, dry, light, and airy, and we all enjoyed the best of health. We had no physician and needed none.

Meteorological observations were taken continuously. The results were surprising. We had thought that we should have disagreeable, stormy weather, but this was not the case. During the whole year of our sojourn at the station we experienced only two moderate storms. The rest of the time light breezes prevailed, mainly from an easterly direction. Atmospheric pressure was as a rule very low, but remained constant. The temperature sank considerably, and I deem it probable that the mean annual temperature which we recorded, -26° C., is the lowest mean temperature which has ever been observed. During five months of the year we recorded temperatures below -50° C. On August 23 the lowest temperature was recorded, -59° . The *aurora australis*, corresponding to the northern lights of the Arctic, was observed frequently and in all directions and forms. This phenomenon changed very rapidly, but, except in certain cases, was not very intensive.

On August 24 the sun reappeared. The winter had ended. Several days earlier we had put everything in the best of order, and when the sun rose over the Barrier we were ready to start. The dogs were in fine condition.

From now on we observed the temperature daily with great interest, for as long as the mercury remained below -50° a start was not to be thought of. In the first days of September all signs indicated that the mercury would rise. We therefore resolved to start as soon as possible. On September 8 the temperature was -30° . We started immediately, but this march was to be short. On the next day the temperature began to sink rapidly, and several days later the thermometer registered -55° C. We human beings could probably have kept on the march for some time under such a temperature, for we were protected against the cold by our clothing; but the dogs could not have long withstood this degree of cold. We were therefore glad when we reached the eightieth parallel. We deposited there our provisions and equipment in the depot which we had previously erected and returned to "Framheim."

The weather now became very changeable for a time—the transitional period from winter to summer; we never knew what weather the next day would bring. Frostbites from our last march forced us to wait until we definitely knew that spring had really come. On September 24 we saw at last positive evidence that spring had arrived; the seals began to clamber up on the ice. This sign was hailed with

rejoicing—not a whit less the seal meat which Bjaaland brought on the same day. The dogs, too, enjoyed the arrival of spring. They were ravenous for fresh seal meat. On September 29 another unrefutable sign of spring appeared in the arrival of a flock of Antarctic petrels. They flew around our house inquisitively to the joy of all, not only of ourselves, but also of the dogs. The latter were wild with joy and excitement, and ran after the birds in hopes of getting a delicate morsel. Foolish dogs! Their chase ended with a wild fight among themselves.

On October 20 the weather had at last become so stable that we could start. We had, meanwhile, changed our original plan, which was that we should all advance southward together. We realized that we could travel with perfect safety in two groups and thus accomplish much more. We arranged that three men should go to the east to explore King Edward VII Land; the remaining five men were to carry out the main plan, the advance on the South Pole.

October 20 was a beautiful day. Clear, mild weather prevailed. The temperature was 1° C. above zero. Our sleds were light, and we could advance rapidly. We did not need to hurry our dogs for they were eager enough themselves. We numbered 5 men and 52 dogs with 4 sleds. Together with the provisions which we had left in the three depots at the eightieth, the eighty-first, and the eighty-second parallels, we had sufficient sustenance for 120 days.

Two days after our departure we nearly met with a serious accident. Bjaaland's sled fell into one of the numerous crevasses. At the critical moment we were fortunately able to come to Bjaaland's aid; had we been a moment later the sled with its 13 dogs would have disappeared in the seemingly bottomless pit.

On the fourth day we reached our depot at 80° S. We remained there two days and gave our dogs as much seal meat as they would eat.

Between the eightieth and the eighty-first parallel the Barrier ice along our route was even, with the exception of a few low undulations; dangerous hidden places were not to be found. The region between the eighty-first and the eighty-second parallel was of a totally different character. During the first 19 miles we were in a veritable labyrinth of crevasses, very dangerous to cross. At many places yawning abysses were visible because large pieces of the surface had broken off; the surface therefore presented a very unsafe appearance. We crossed this region four times in all. On the three first times such a dense fog prevailed that we could only recognize objects a few feet away. Only on the fourth occasion did we have clear weather. Then we were able to see the great difficulties to which we had been exposed.

On November 5 we reached the depot at the eighty-second parallel and found everything in order. For the last time our dogs were able to have a good rest and eat their fill; and they did so thoroughly during their two days' rest.

Beginning at the eightieth parallel we constructed snow cairns which should serve as signposts on our return. In all we erected 150 such signposts, each of which required 60 snow blocks. About 9,000 snow blocks had therefore to be cut out for this purpose. These cairns did not disappoint us, for they enabled us to return by exactly the same route we had previously followed.

South of the eighty-second parallel the Barrier was, if possible, still more even than farther north; we therefore advanced quite rapidly. At every unit parallel which we crossed on our advance toward the south we established a depot. We thereby doubtlessly exposed ourselves to a certain risk, for there was no time to set up sign posts around the depots. We therefore had to rely on snow cairns. On the other hand, our sleds became lighter, so that it was never hard for the dogs to pull them.

When we reached the eighty-third parallel we saw land in a southwesterly direction. This could only be South Victoria Land, probably a continuation of the mountain range which runs in a southeasterly direction and which is shown on Shackelton's map. From now on the landscape changed more and more from day to day; one mountain after another loomed up, one always higher than the other. Their average elevation was 10,000 to 16,000 feet. Their crest line was always sharp; the peaks were like needles. I have never seen a more beautiful, wild, and imposing landscape. Here a peak would appear with somber and cold outlines, its head buried in the clouds; there one could see snow fields and glaciers thrown together in hopeless confusion. On November 11 we saw land to the south and could soon determine that a mountain range, whose position is about 86° S. and 163° W., crosses South Victoria Land in an easterly and northeasterly direction. This mountain range is materially lower than the mighty mountains of the rest of South Victoria Land. Peaks of an elevation of 1,800 to 4,000 feet were the highest. We could see this mountain chain as far as the eighty-fourth parallel, where it disappeared below the horizon.

On November 17 we reached the place where the Ice Barrier ends and the land begins. We had proceeded directly south from our winter quarters to this point. We were now in $85^{\circ} 7'$ S. and 165° W. The place where we left the Barrier for the land offered no special difficulties. A few extended undulating reaches of ice had to be crossed which were interrupted by crevasses here and there. Nothing could impede our advance. It was our plan to go due south from

"Framheim" and not to deviate from this direction unless we should be forced to by obstacles which nature might place in our path. If our plans succeeded it would be our privilege to explore completely unknown regions and thereby to accomplish valuable geographic work.

The immediate ascent due south into the mountainous region led us between the high peaks of South Victoria Land. To all intents and purposes no great difficulties awaited us here. To be sure, we should probably have found a less steep ascent if we had gone over to the newly discovered mountain range just mentioned. But as we maintained the principle that direct advance due south was the shortest way to our goal, we had to bear the consequences.

At this place we established our principal depot and left provisions for 30 days. On our four sleds we took provisions with us for 60 days. And now we began the ascent to the plateau. The first part of the way led us over snow-covered mountain slopes, which at times were quite steep, but not so much so as to prevent any of us from hauling up his own sled. Farther up, we found several glaciers which were not very broad but were very steep. Indeed, they were so steep that we had to harness 20 dogs in front of each sled. Later the glaciers became more frequent, and they lay on slopes so steep that it was very hard to ascend them on our skis. On the first night we camped at a spot which lay 2,100 feet above sea level. On the second day we continued to climb up the mountains, mainly over several small glaciers. Our next camp for the night was at an altitude of 4,100 feet above the sea.

On the third day we made the disagreeable discovery that we should have to descend 2,100 feet, as between us and the higher mountains to the south lay a great glacier which crossed our path from east to west. This could not be helped. The expedition therefore descended with the greatest possible speed and in an incredibly short time we were down on the glacier, which was named Axel Heiberg Glacier. Our camp of this night lay at about 3,100 feet above sea level. On the following day the longest ascent began; we were forced to follow Axel Heiberg Glacier. At several places ice blocks were heaped up so that its surface was hummocky and cleft by crevasses. We had therefore to make detours to avoid the wide crevasses which, below, expanded into large basins. These latter, to be sure, were filled with snow; the glacier had evidently long ago ceased to move. The greatest care was necessary in our advance, for we had no inkling as to how thick or how thin the cover of snow might be. Our camp for this night was pitched in an extremely picturesque situation at an elevation of about 5,250 feet above sea level. The glacier was here hemmed in by two mountains which were named "Fridtjof Nansen" and "Don Pedro Christophersen," both 16,000 feet high

Farther down toward the west at the end of the glacier "Ole Engelstad Mountain" rises to an elevation of about 13,000 feet. At this relatively narrow place the glacier was very hummocky and rent by many deep crevasses, so that we often feared that we could not advance farther. On the following day we reached a slightly inclined plateau which we assumed to be the same which Shackleton describes. Our dogs accomplished a feat on this day which is so remarkable that it should be mentioned here. After having already done heavy work on the preceding days, they covered 19 miles on this day and overcame a difference in altitude of 5,700 feet. On the following night we camped at a place which lay 10,800 feet above sea level. The time had now come when we were forced to kill some of our dogs. Twenty-four of our faithful comrades had to die. The place where this happened was named the "Slaughterhouse." On account of bad weather we had to stay here for four days. During this stay both we and the dogs had nothing except dog meat to eat. When we could at last start again on November 26, the meat of 10 dogs only remained. This we deposited at our camp; fresh meat would furnish a welcome change on our return. During the following days we had stormy weather and thick snow flurries, so that we could see nothing of the surrounding country. We observed, however, that we were descending rapidly. For a moment, when the weather improved for a short time, we saw high mountains directly to the east. During the heavy snow squall on November 28 we passed two peculiarly shaped mountains lying in a north-south direction; they were the only ones that we could see on our right hand. These "Helland-Hansen Mountains" were entirely covered by snow and had an altitude of 9,200 feet. Later they served as an excellent landmark for us.

On the next day the clouds parted and the sun burst forth. It seemed to us as if we had been transferred to a totally new country. In the direction of our advance rose a large glacier, and to the east of it lay a mountain range running from southeast to northwest. Toward the west impenetrable fog lay over the glacier and obscured even our immediate surroundings. A measurement by hypsometer gave 8,200 feet for the point lying at the foot of this, the "Devil's Glacier." We had therefore descended 2,600 feet since leaving the "Slaughterhouse." This was not an agreeable discovery as we no doubt would have to ascend as much again, if not more. We left provisions here for six days and continued our march.

From the camp of that night we had a superb view of the eastern mountain range. Belonging to it we saw a mountain of more wonderful form than I have ever seen before. The altitude of the mountain was 12,300 feet; its peaks roundabout were covered by a glacier. It looked as if Nature, in a fit of anger, had dropped sharp cornered

ice blocks on the mountain. This mountain was christened "Helmer-Hansen Mountain," and became our best point of reference. There we saw also the "Oscar Wisting Mountains," the "Olav Bjaaland Mountains," the "Sverre Hassel Mountains," which, dark and red, glittered in the rays of the midnight sun and reflected a white and blue light. In the distance the mountains seen before loomed up romantically; they looked very high when one saw them through the thick clouds and masses of fog which passed over them from time to time and occasionally allowed us to catch glimpses of their mighty peaks and their broken glaciers. For the first time we saw the "Thorvald Nilsen Mountain," which has a height of 16,400 feet.

It took us three days to climb the "Devil's Glacier." On the 1st of December we had left behind us this glacier with its crevasses and bottomless pits and were now at an elevation of 9,350 feet above sea level. In front of us lay an inclined block-covered ice plateau which, in the fog and snow, had the appearance of a frozen lake. Traveling over this "Devil's Ball Room," as we called the plateau, was not particularly pleasant. Southeasterly storms and snow flurries occurred daily, during which we could see absolutely nothing. The floor on which we were walking was hollow beneath us; it sounded as if we were going over empty barrels. We crossed this disagreeable and uncanny region as quickly as was compatible with the great care we had to exercise, for during the whole time we were thinking of the unwelcome possibility of sinking through.

On December 6 we reached our highest point—according to hypsometric measurement 11,024 feet above sea level. From there on the interior plateau remained entirely level and of the same elevation. In $88^{\circ} 23' S.$ we had reached the place which corresponded to Shackleton's southernmost advance. We camped in $88^{\circ} 25' S.$ and established there our last—the tenth—depot, in which we left 220 pounds of provisions. Our way now gradually led downward. The surface was in excellent condition, entirely level, without a single hill or undulation or other obstacle. Our sleds forged ahead to perfection; the weather was beautiful; we daily covered 17 miles. Nothing prevented us from increasing our daily distance. But we had time enough and ample provisions; we thought it wiser, also, to spare our dogs and not to work them harder than necessary. Without a mishap we reached the eighty-ninth parallel on December 11. It seemed as if we had come into a region where good weather constantly prevails. The surest sign of continued calm weather was the absolutely level surface. We could push a tent pole 7 feet deep into the snow without meeting with any resistance. This proved clearly enough that the snow had fallen in equable weather; calm must have prevailed or a slight breeze may have blown at the most. Had the

weather been variable—calms alternating with storms—snow strata of different density would have formed, a condition which we would immediately have noticed when driving in our tent poles.

Our dead reckoning had heretofore always given the same results as our astronomical observations. During the last eight days of our march we had continuous sunshine. Every day we stopped at noon in order to measure the meridian altitude and every evening we made an observation for azimuth. On December 13 the meridian altitude gave $89^{\circ} 37'$, dead reckoning, $89^{\circ} 38'$. In latitude $88^{\circ} 25'$ we had been able to make our last good observation of azimuth. Subsequently this method of observation became valueless. As these last observations gave practically the same result and the difference was almost a constant one, we used the observation made in $88^{\circ} 25'$ as a basis. We calculated that we should reach our goal on December 14.

December 14 dawned. It seemed to me as if we slept a shorter time, as if we ate breakfast in greater haste, and as if we started earlier on this morning than on the preceding days. As heretofore, we had clear weather, beautiful sunshine, and only a very light breeze. We advanced well. Not much was said. I think that each one of us was occupied with his own thoughts. Probably only one thought dominated us all, a thought which caused us to look eagerly toward the south and to scan the horizon of this unlimited plateau. Were we the first or ——?

The distance calculated was covered. Our goal had been reached. Quietly, in absolute silence, the mighty plateau lay stretched out before us. No man had ever yet seen it, no man had ever yet stood on it. In no direction was a sign to be seen. It was indeed a solemn moment when, each of us grasping the flagpole with one hand, we all hoisted the flag of our country on the geographical South Pole, on "King Haakon VII Plateau."

During the night, as our watches showed it to be, three of our men went around the camp in a circle 10 geographical miles (11.6 statute miles) in diameter and erected cairns, while the other two men remained in the tent and made hourly astronomical observations of the sun. These gave $89^{\circ} 55' S$. We might well have been satisfied with this result, but we had time to spare and the weather was fine. Why should we not try to make our observations at the pole itself? On December 16, therefore, we transported our tent the remaining $5\frac{3}{4}$ miles to the south and camped there. We arranged everything as comfortably as possible in order to make a round of observations during the 24 hours. The altitude was measured every hour by four men with the sextant and artificial horizon. These observations will be worked out at the University of Christiania.

This tent camp served as the center of a circle which we drew with a radius of $5\frac{1}{2}$ miles [on the circumference of which] cairns were erected. A small tent which we had brought with us in order to designate the South Pole was put up here and the Norwegian flag with the pennant of the *Fram* was hoisted above it. This Norwegian home received the name of "Polheim." According to the observed weather conditions, this tent may remain there for a long time. In it we left a letter addressed to His Majesty, King Haakon VII, in which we reported what we had done. The next person to come there will take the letter with him and see to its delivery. In addition, we left there several pieces of clothing, a sextant, an artificial horizon, and a hypsometer.

On December 17 we were ready to return. On our journey to the pole we had covered 863 miles, according to the measurements of the odometer; our mean daily marches were therefore 15 miles. When we left the pole we had 3 sleds and 17 dogs. We now experienced the great satisfaction of being able to increase our daily rations, a measure which previous expeditions had not been able to carry out, as they were all forced to reduce their rations, and that at an early date. For the dogs, too, the rations were increased, and from time to time they received one of their comrades as additional food. The fresh meat revived the dogs and undoubtedly contributed to the good results of the expedition.

One last glance, one last adieu, we sent back to "Polheim." Then we resumed our journey. We still see the flag; it still waves to us. Gradually it diminishes in size and finally entirely disappears from our sight. A last greeting to the Little Norway lying at the South Pole.

We left King Haakon VII Plateau, which lay there bathed in sunshine, as we had found it on our outward journey. The mean temperature during our sojourn there was -13° C. It seemed, however, as though the weather was much milder.

I shall not tire my esteemed auditors by a detailed description of our return, but shall limit myself to some of the interesting episodes.

The splendid weather with which we were favored on our return displayed to us the panorama of the mighty mountain range which is the continuation of the two ranges which unite in 86° S. The newly discovered range runs in a southeasterly direction and culminates in domes of an elevation of 10,000 to over 16,000 feet. In 88° S. this range disappears in the distance below the horizon. The whole complex of newly discovered mountain ranges, which may extend a distance of over 500 miles, has been named the Queen Maud Ranges.

We found all of our 10 provision depots again. The provisions, of which we finally had a superabundance, were taken with us to the eightieth parallel and cached there. From the eighty-sixth parallel on we did not need to apportion our rations; everyone could eat as much as he desired.

After an absence of 99 days we reached our winter quarters, "Framheim," on January 25. We had, therefore, covered the journey of 864 miles in 39 days, during which we did not allow ourselves any days of rest. Our mean daily march, therefore, amounted to 22.1 miles. At the end of our journey two of our sleds were in good condition and 11 dogs healthy and happy. Not once had we needed to help our dogs and to push the sleds ourselves.

Our provisions consisted of pemmican, biscuits, desiccated milk, and chocolate. We therefore did not have very much variety, but it was healthful and robust nourishment which built up the body, and it was of course just this that we needed. The best proof of this was that we felt well during the whole time and never had reason to complain of our food, a condition which has occurred so often on long sledge journeys and must be considered a sure indication of improper nourishment.

During our absence, Lieut. Prestrud with his two companions had done excellent work toward the east and in the vicinity of the Bay of Whales. They succeeded in reaching King Edward VII Land, which Scott had discovered, and in confirming what we had seen. It was found that the Alexandra Mountains are a range entirely snow covered and with an elevation of 1,230 feet. They run in a southeasterly direction as far as the eye can reach and are bounded on the north by mountains 2 000 feet high, which were named "Nutakar" by Scott.

The observations made on this expedition in the neighborhood of "Framheim" are of great interest. They resulted in determining that the Bay of Whales has a snow-covered bottom.

Simultaneously with our work on land, scientific observations were made on board the *Fram* by Capt. Nilsen and his companions which probably stamp this expedition as the most valuable of all. The *Fram* made a voyage from Buenos Aires to the coast of Africa and back, covering a distance of 8,000 nautical miles, during which a series of oceanographical observations was made at no less than 60 stations. The total length of the *Fram's* journey equaled twice the circumnavigation of the globe. The *Fram* has successfully braved dangerous voyages which made high demands upon her crew. The trip out of the ice region in the fall of 1911 was of an especially serious character. Her whole complement then comprised only 10 men. Through night and fog, through storm and hurricane, through

pack ice and between icebergs the *Fram* had to find her way. One may well say that this was an achievement that can be realized only by experienced and courageous sailors, a deed that honors the whole nation.

In conclusion, you will allow me to say that it was these same 10 men who on February 15, 1911, hoisted the flag of their country, the Norwegian flag, on a more southerly point of the earth than the crew of any other ship whose keel ever cleft the waves.¹ This is a worthy record in our record century. Farthest north, farthest south did our dear old *Fram* penetrate.

¹ The *Fram* penetrated to the head of the Bay of Whales, 78° 41' S. (New York Times, Mar. 9, 1912.)

ICEBERGS AND THEIR LOCATION IN NAVIGATION.¹

By Prof. HOWARD T. BARNES, D. Sc., F. R. S.
McGill University, Montreal, Canada.

[With 3 plates.]

ORIGIN OF THE NORTH ATLANTIC ICE.

The icebergs met with in the north Atlantic each year are almost entirely derived from western Greenland. The interior of Greenland is covered by a large ice sheet forming an enormous glacier, which gradually moves outward, meeting on its journey mountains and islands which form a fringe of varying width. This mountainous belt is penetrated by deep fiords, through which the ice passes toward the sea. As the huge ice sheets are forced into the sea they are broken off and set adrift as bergs. The "calving," as it is called, may take place in a number of ways.

Von Drygalski distinguishes three classes of bergs; those of the first class are the most massive of all, and separate with a sound like thunder from the entire thickness of the glacier front. They result from the buoyant action of the water as the glacier pushes out into the deep water. They usually regain their equilibrium after rhythmic oscillation, and float away in an upright position. Bergs of the second class are broken off under water from time to time. They rise and often turn over before they gain equilibrium, displaying in this way the beautiful blue color of the lowest layers of ice. Bergs of the third class form almost continuously, and consist of large and small fragments which separate along the crevasses and fall into the sea.

The size of the pieces of ice set adrift varies very much; but bergs 60 to 100 feet to the top of their walls, with spires and pinnacles from 200 to 250 feet high, are most often found. The length of such an average berg would be from 300 to 500 yards. The depth of these masses under water is variously given as from seven to eight times the height, but this is not always the case. It is possible to have a berg as high out of the water as it is deep below the surface, since the submergence depends entirely on mass and not on height.

¹ Lecture before the Royal Institution of Great Britain, London, Friday, May 31, 1912. Reprinted by permission, with author's appendices and additional illustrations.

It is possible to find bergs with a pinnacle rising high out of the water, but offering little weight to the mass below. The highest berg in the Arctic which has been recorded had pinnacles 1,500 feet high. Bergs are produced all the year round throughout the entire extent of the coast line of Greenland, but the huge masses which push out into the open sea arise either on the west coast between Disco Bay and Smith Sound, or on the east coast south of the parallel of 68°. Besides the icebergs formed from the Greenland glaciers, a few come around Cape Farewell from the Spitzbergen Sea, and some may be traced from Hudson Bay.

MOVEMENT OF ICE FROM THE ARCTIC REGIONS.

The Labrador current flows southward along the coasts of Baffin Land and Labrador. The average rate is from 10 to 36 miles per day, but occasionally it ceases altogether.¹ As soon as free the icebergs find their way into the Arctic current, and float gradually southward. The journey is by no means an easy one, and few bergs survive. There are many mishaps, such as grounding in the Arctic Basin with ultimate breaking up, stranding along the Labrador coast, where destruction takes place, and falling to pieces entirely in the open sea. Only a small percentage ever reach the Grand Bank and the routes of the transatlantic liners, so many delays attend their journey. It is well known that many bergs seen in any one season may have been produced several seasons before. Taking the Labrador current as 10 miles per day, a berg once formed and drifting freely would make the journey southward in from four to five months. The difference in time of two bergs reaching a low latitude may cover a period of one or two years even when these start on the same day. so devious are the paths into which chance may direct these floating masses. Undercurrents affect the largest icebergs, and frequently they are seen to move backward against the wind and surface water. Extensive field ice offers an obstruction to the movements of the bergs, hence the number met with from one season to another must depend on the mildness or severity of the previous summer in the north.

THE LABRADOR CURRENT.

No part of the oceans of the world is of so much interest to mankind as this cold Arctic current. It brings down the cold of the north to temper the heat of the Tropics, and thus tends to equalize the temperature of the world. It is the home and feeding ground of the world's greatest supply of fish food, and supports more marine life than any other part of the world. It conveys each year southward the greatest menace to the navigator in the form of huge ice-

¹ U. S. Hydrographic Report, 1909.

bergs, and it influences the entire eastern coast of Canada. In spite of all this there has been little study of this current. Why, may we ask, have the Governments of the world neglected to obtain scientific data, and why have they neglected to supply a thorough hydrographic survey of this region? I trust this state of affairs may be soon rectified.

DANGER FROM ICEBERGS.

To the navigator the presence of ice is a constant menace. Its movement, often fairly rapid by wind and current, makes its position always uncertain. A ship may see immense fields of ice, which another passing over the same locality a few days afterward may never encounter. Only those who have stood on the bridge of an Atlantic liner with the officers on a dark night in the ice track can appreciate the anxiety of those tireless men, who know that collision with even a small floating ice mass means damage to the ship. The small masses called growlers are often of great danger. They float low in the water, and leave little above to be seen by the lookout. The Arctic ice is of great solidity and is of irregular shape. It presents frequently sharp edges which can cut the plates of a ship, shear off rivets, or drive a hole through the bottom as readily as a steel knife. The game of chance is played by every big ship that speeds through the ice track at night or in a fog.

FIELD ICE AND ITS DISTRIBUTION IN THE GULF OF ST. LAWRENCE DURING THE WINTER.

Icebergs are not alone in causing an obstruction to navigation in the Labrador current. Field ice, which may extend over wide areas, presents great difficulties. This ice is salt water frozen in the bays and inlets along the shore, as especially in the Gulf of St. Lawrence. Immense fields are formed of pieces blown by the wind and massed together in an irregular way. Change of wind and tide causes the fields to float away. When several fields are blown shoreward together they grind and crush together, forming irregular ice many feet thick. Frost and spray soon cements this together into a hard mass, almost impossible to break. Floating again, these agglomerated ice masses, often many miles in extent, are carried out to sea, there to produce great danger to navigation. While the Gulf of St. Lawrence never freezes over entirely, there are to be found all winter floating areas, which take up their position with the direction of the wind. As the spring advances these fields become weaker, and finally disappear. The last to open is the Strait of Belle Isle, where toward the end of June it becomes sufficiently free for ships to navigate.

LIMITS OF REGION OF ICEBERGS.

It has been found that in April, May, and June are the greatest number of icebergs. They have been seen as far south as the thirty-ninth degree of latitude and as far east as longitude $38^{\circ} 30'$. In general, it may be stated that floating ice may be met with anywhere in the north Atlantic Ocean northward of the fortieth degree of latitude at any season of the year.

SURFACE TEMPERATURE OF THE LABRADOR CURRENT IN WINTER AND SUMMER.

During the winter months the surface temperature of the Labrador current often falls to the freezing point of salt water, about 28° F., but it is more often at 29° or 30° F. As the spring advances the line of low temperature advances farther north, until in July or August the temperature on the Grand Banks toward the Strait of Belle Isle reaches 40° or 45° F., and gradually falls northward to 29° F. in Hudson Straits. The surface temperature varies considerably, depending on the proximity of ice or land, as will be explained shortly. No measurements have been made north of the Banks in winter or spring, when the Strait of Belle Isle is icebound. Reports of the temperature of the ice track are frequently given by sea captains. Results as low as 22° F. have been shown to me, but I believe these to be impossible, and due to some error of measurement arising from the crude method now in vogue on our Atlantic liners.

INFLUENCE OF ICEBERGS ON THE TEMPERATURE OF THE SEA.

There can be no question but that icebergs have an important influence on the temperature of the sea. Composed of frozen fresh water from the north, they melt rapidly when they drift down to the warmer waters of the Banks and when they reach the Gulf Stream. On account of the small conductivity of the water, no appreciable cooling can result from this cause. If it were not for the currents in the sea and the circulation set up by the melting berg, no cooling effect would be appreciable. That there is a small cooling effect has been shown by captains and others, but this has not been made use of for telling the proximity of ice with any success. What is called salt-water ice—that is, ice formed by the freezing of salt water—contains a small trace of salt in its composition and frequently holds salt mechanically, but there is very little difference in the purity of the ice. It is well known that water in freezing expels all the impurities, hence it is erroneous to say that salt-water ice floats under the surface. What is called salt-water ice is really the same as field ice, and is exceedingly hard to break. Its structure is not uniform, and, composed often of irregular broken pieces, it has no line of cleavage.

PETTERSSON'S THEORY OF ICE MELTING.

Dr. Otto Pettersson has for some time shown experimentally that ice melting in salt water produces three currents (fig. 1). (1) When the ice melts it cools the salt water, which sinks down by convection. (2) A stream of warmer salt water moves in toward the ice, giving rise to a horizontal current. (3) The melted ice consists of fresh water, which does not mix with the salt water on account of the difference of density. This fresh water rises around the ice and spreads out over the surface. The ice becomes surrounded by a layer of fresher water, which tends to remain on the surface. As the ice

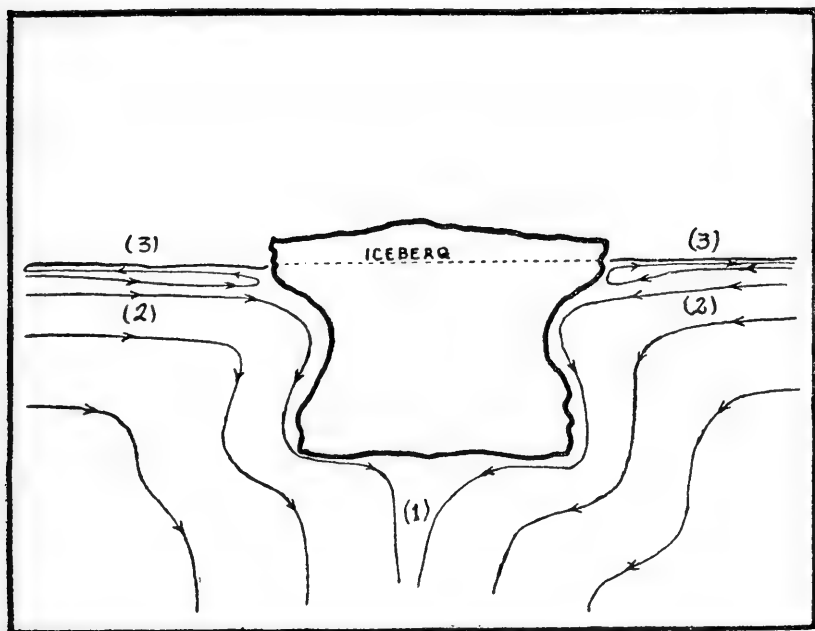

FIG. 1.—ICE MELTING IN SALT WATER.

moves the fresh water moves with it. Waves do not mix it with the salt water, but leave it practically unaffected. Pettersson believes that this circulation has an important influence on the currents in the sea. The lower density of a diluted layer prevents the normal vertical circulation in the sea, and causes characteristic temperature effects.

Icebergs which have been left high and dry on the shore by the tide show the action of the melting. Bergs which become top-heavy and turn over also bear evidence to the underwater current producing the melting. The form of the ice shows a deep furrow running all around where the melting process has proceeded, and this is often the cause of the rolling over of a berg to find equilibrium in some other

position. Icebergs are often in an exceedingly unstable state, and the slightest increase in wind or sea disturbance causes them to break up or turn over. This is one of the reasons why captains always go as far away from them as possible. (See the Appendix.)

SIGNS OF THE PROXIMITY OF ICE.

Since the earliest days efforts have been made to find some means of detecting the presence of ice. To those who have had many years' experience in navigating in the ice region the presence of ice is made known by a number of effects. Before ice can be actually seen there is a peculiar whiteness observed around the berg on a dark night, except in the case of dark bergs. This is called by mariners the ice "blink." It is caused by the reflection of the scattered rays of light from the sky from the white surface of the berg. Thus it is a contrast between the black absorbing water, which reflects none of the light, and the ice, which scatters nearly all. A dark berg is one casting a shadow toward the ship. When the light comes more strongly from any particular part of the sky the iceberg often can not be seen in certain directions, while clearly visible by the ice blink in others. This I believe to be the reason why the officers on the *Titanic* did not see the berg soon enough to stop. It is stated that on a clear day on the horizon over the ice the sky will be much paler or lighter in color, and may be distinguished from that overhead.

During foggy weather ice can sometimes be made out on account of its darker appearance. In this case it is a contrast effect again, but this time it is the shadow of the berg against the white shadowless fog particles.

Icebergs are sometimes detected by the echo from the steam whistle or foghorn. They are also frequently heard for many miles by the noise they make in breaking up and falling to pieces. The cracking of the ice or the falling of the pieces into the sea causes a noise like thunder.

The absence of swell or waves is sometimes a sign of ice or land, and the presence of flocks of birds far from land is an indication of ice. The temperature of the air usually falls as ice is approached, and mariners describe a peculiar damp cold as distinguished from the cold caused by a change of wind. I shall discuss the fall in temperature of the sea as ice is approached in what follows.

FAILURE OF PREVIOUS EFFORTS TO MAKE USE OF TEMPERATURE CHANGES IN THE SEA.

Navigators place no reliance on temperature measurements. As a matter of shipboard routine, the temperature of the water is taken; but very little, if any, attention is taken of it. The method is to dip

a canvas bucket over the side and bring up a sample of sea water. The quartermaster then inserts a good household thermometer in the water, waits for a few minutes, and then reports the reading to the bridge. The thermometer is usually graduated in 2° intervals, representing a length of stem about one-eighth of an inch. The interval of time between the dipping of the water and the report of the reading may be anything from 5 to 10 minutes. In the meantime the ship has sailed some miles beyond the point of observation. It is not surprising, in the light of my results, that no value whatever can be attached to measurements of this kind. As an example I can quote from a standard work on navigation, Capt. Lecky's *Wrinkles in Practical Navigation*, fifteenth edition:

Allied to fog is the question of danger from ice. It is a popular delusion among passengers on board ship that by taking the temperature of the sea surface at short intervals the approach to ice is unfailingly indicated. Unfortunately such is by no means the fact, and reliance thereon invites disaster. More than ordinarily cold water merely shows that the ship is in a part of the ocean where ice may possibly be encountered, and not that it is actually present.

By kind permission, and on the unexceptional authority of Capts. Ballantine, Dutton, and Smith, of the Allan Mail Steamship Line, all men of high standing in the profession and well acquainted with ice navigation, it is here stated that no appreciable difference in the temperature of the sea surface is caused by the proximity of even the largest icebergs, and when one considers what a poor conductor of heat water is, their statement can be well believed. * * *

In a letter to the author, Lord Kelvin says: "The conducting power of water is so small that there would be absolutely no cooling effect by conduction to a distance from an iceberg; but there might be a considerable effect by the cold and light fresh water running down from the iceberg, and spreading far and wide over the surface of the sea."

This seems a reasonable supposition, but it is more than likely that the film of cold fresh water would be broken up by the agitation of the wind and waves, and in any case disturbed and turned over by the plowlike action of a vessel's bow going at speed. Under these circumstances the hydrometer would be no better than the thermometer.

Again, it is well known that about the Banks the Labrador current is *sometimes* colder when no ice is to be seen than it is when the contrary is the case. In winter its surface temperature even falls to 28° F. Large icebergs have been actually passed at a distance of a quarter of a mile, and the sea-surface temperature tested carefully without finding a *single degree of difference* from what previously existed when there were none in sight.

It may be fairly assumed, therefore, that no reliance is to be placed upon the thermometer as an immediate or direct means of detecting the presence of ice, especially when it takes the form of stray bergs. In fog it will simply tell you when the ship has entered the cool current, which may, or may not, be ice bearing.

Dr. W. Bell Dawson, director of the Canadian hydrographic survey, has made a study of the temperature effect of an iceberg in the Strait of Belle Isle. In his report to the department of marine and fisheries, in 1907, he says:

Icebergs in relation to water temperature.—On August 7, 1894, an unusually large iceberg was aground in 57 fathoms off Chateau Bay. An instrumental survey made in a boat showed it to be 780 feet long, 290 feet wide, and 105 feet high. The water

temperatures on different sides were 38° , 37° , and 37° , at distances ranging from 130 to 1,320 feet from it. On that day the water temperature, on a line from Chateau Bay to Belle Isle, was $36\frac{1}{2}^{\circ}$ off the mouth of the bay, 39° in the middle, and 41° off the south end of Belle Isle. It was lowered less than 2° , therefore, in the proximity of the iceberg.

The next day, August 8, a small iceberg was aground in Chateau Bay. The water temperature in the middle of the bay was 34° and at the mouth $34\frac{1}{2}^{\circ}$. The lowest temperature close to the iceberg was $33\frac{1}{2}^{\circ}$, which shows a difference of not more than 1° due to the iceberg.

In 1906 an iceberg about 140 feet long was aground in 38 fathoms, about $1\frac{1}{2}$ miles from Station P, where it remained for several days. On June 19 it was examined in a boat. The surface temperature in the strait at the time was $35\frac{1}{2}^{\circ}$, and close around the berg it was found to be the same, except on the west side, where the water trailing from it with the flood was 35° . There was thus only one-half degree difference of temperature to be found near it.

It is clear that up to the time of the experiments with the microthermometer, in 1910, there was good evidence to show that the ordinary thermometer is useless to detect the small temperature effect of an iceberg. Hence captains are correct in their statement that the ship's thermometer is useless as a means for locating an iceberg.

THE RECORDING MICROTHERMOMETER.

The development of the recording microthermometer has been the result of nearly 20 years' experience in the study of minute temperature changes in the ice-bearing water of the St. Lawrence River. By applying very sensitive electrical-resistance thermometers, it has been possible to show that the temperature of the St. Lawrence in winter never varies more than a minute fraction of a degree from the freezing point. The small variations that have been observed and measured are the result of heat exchanges when ice is present, and they accompany the formation or the disintegration of the ice. The delicate poising of the forces of nature are here wonderfully illustrated. A few thousandths of a degree on either side of the freezing point of the river water produces immense physical effects. Thus the character of a river may be changed in a single night, or the wheels of the largest hydroelectric station completely stopped by a drop of a few thousandths of a degree in the temperature of the water. As a result of this knowledge it is now possible to apply artificial heat around the wheels and gates, and completely prevent any trouble from the sticking of the ice needles drawn in by the water.

Four years ago I undertook some experiments to study the ice-breaking operations on the St. Lawrence, and to determine the effect of open water conditions on the temperature of the river. During this time I turned my attention to a practical form of electrical-resistance thermometer, which could not only easily measure thousandths of a degree but automatically record them on a chart when working from the ice breakers going at full speed. Following out

ideas which I had developed along these lines, I devised an instrument which has proved so satisfactory and trustworthy that I have given it the name of the microthermometer.

The thermometer bulb (fig. 2) consists of concentric cylinders of copper tube about 6 inches long and 4 inches in diameter. On the surface of the inner tube the coil of resistance wire is wound. The outer tube fits closely over this and the ends are soldered together. This makes a winding which affords a large cooling surface and is exceedingly sensitive to temperature changes. The coil consists of 250 feet of large size iron wire, silk covered, and has a resistance of approximately 125 ohms at 0° C. I used iron wire for two reasons, its cheapness and its remarkable steadiness of zero for ice temperature readings. The larger size wire enabled me to apply considerable battery power without appreciable current heating. My experiments with platinum were most unsatisfactory. There

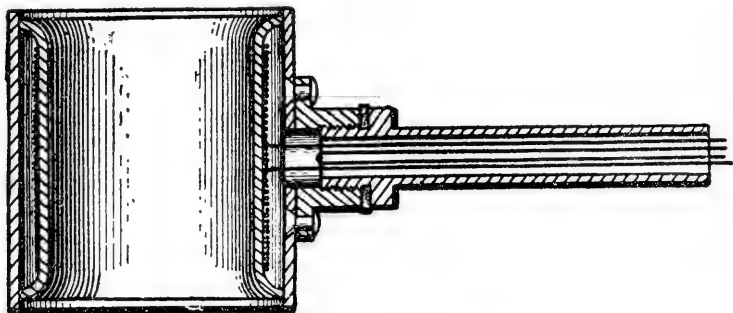

FIG. 2.—BULB OF MICRO-THERMOMETER.

was great current heating and changes of zero which as yet I have not been able to explain. The iron wire maintains an invariable zero. When iron is heated over 50° C., however, its zero does change and can only be restored by cooling to a low temperature. It appears that there must be some internal molecular change in the iron above 50° C. which has not as yet been studied.

The connecting wires from the bulb pass to a lead-covered cable of four strands, as in Callendar's compensating method, and then to the recorder, which may be a good Callendar recorder with the galvanometer removed. The galvanometer actually used consists of a jeweled-bearing D'Arsonval, of special design, of about 300 ohms resistance. The bridge wire may be interchanged so as to produce different scales. The one I have found useful is 8 inches long, and gives a range of 1° over its entire length. I have used also one giving half a degree, and the records are very nearly as perfect as with the 1° range. Other wires giving 4° and 8° intervals

are frequently useful. By my arrangement it is possible to switch from one wire to another very quickly. The 1° scale is essential in very cold water, but for warmer water the coarser scale is necessary.

The thermometer may be connected so as to read the temperature directly, in which case the resistance of the bulb is compensated by a known resistance box. In this way the value of the resistance from previous calibration gives a measure of the temperature. The thermometer bulb may also be connected differentially with a second equal bulb, and only differences in temperature recorded on the chart. This method can be applied to give the difference in temperature between the bow and the stern of a ship. Thus a ship so equipped could not possibly run into ice as long as the bow thermometer was equal to the stern thermometer.

In order to measure the temperature of the river or sea water the thermometer bulb can be trailed by guy ropes alongside, and the lead cable carried through heavy copper pipes up to the deck of the ship. From there the cable can be carried to the chart-house or other convenient location. The thermometer bulb may also be placed in a tank fed from the circulating water in the engine room. This method is desirable on a fast moving ship or in regions where much floating ice is about.

It will be seen that the microthermometer is a refined electrical-resistance thermometer.

PRACTICAL TESTS OF THE MICROTHERMOMETER.

Realizing the great menace to navigation in the presence of ice, I was anxious to find whether refined measurements of the temperature of the sea could be used to warn a ship at night or in time of fog.

As a preliminary test of the sensitiveness of the instrument, I had some experiments made in the St. Lawrence River during the time of the ice-breaking work. The C. G. S. *Lady Grey*, having cleared out the ice from the channel as far as Lake St. Peter from Quebec, was detailed to steam slowly up the river toward the unbroken ice sheet in the lake. The edge of the ice was sharp and well defined, and extended out from the shore along the banks of the river. The current of the river flowed from under the ice in a slightly diagonal direction, so that, steaming in the open water, the current flowed in such a way as to pass under the edge of the shore ice. The ship started 2 miles below the upper edge of the ice, and measurements of temperature were taken at intervals up to the ice. Figure 3 shows the character of the temperature curve obtained, and illustrates how accurately the microthermometer registers even so small a temperature change as one-tenth of a degree per mile.

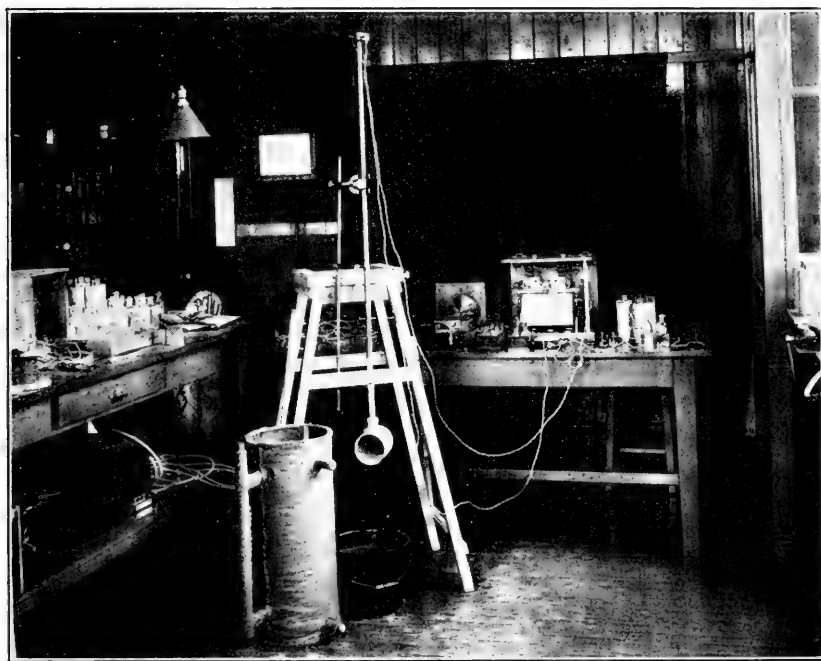

THE MICROTHERMOMETER IN THE LABORATORY READY FOR TESTING.

This instrument will automatically record the one-thousandth of a degree of temperature as easily as an ordinary thermometer records one-tenth.

to obtain measurements of the sea temperature in the vicinity of icebergs. In July, 1910, the Canadian department of marine and fisheries kindly granted me facilities for doing this on the ice-breaking steamer *Stanley*, proceeding to Hudson Bay with a survey party. My assistant, Mr. L. V. King, undertook the observations during this trip, and an account of the work was published in my report to the Government.

The thermometer was placed over the side of the ship, immersed to a depth of about 5 feet, and a record of temperature was made through the Strait of Belle Isle, along the Labrador coast, to Hudson

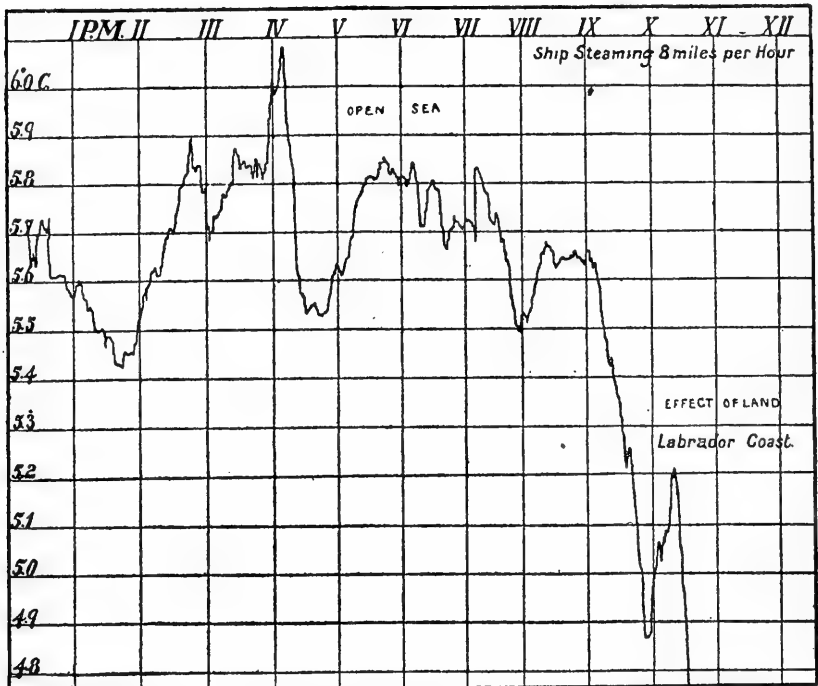

FIG. 4.—MARINE MICRO-THERMOGRAM, SHOWING EFFECT OF LAND.

Bay. The recorder was placed in Mr. King's cabin, where he could observe the effect of ice and land. Several icebergs were passed in the northern journey, at a distance of about half a mile, and these were recorded on the chart by a rapid fall of temperature of from 1° to 2° as the bergs were approached. It was found as the ship drew near a berg that a rise of temperature took place first, followed by a rapid fall. On the microthermometer the effect was clearly shown, but would have been missed entirely on an ordinary thermometer. I have called this peculiar rise and fall of temperature the "iceberg effect," and it seems to be characteristic and easily distinguished from the small oscillations of temperature found in open

sea. It was supposed that the iceberg effect was caused by the fresh water observed by Pettersson in his tank experiments diluting the sea water, and creating a blanket of lighter water in which the sun's heat is absorbed. In the open sea the warming of the sea by the sun is offset by the vertical circulation, but in the fresher and lighter water this is impossible, and the warmer water remains on the surface.

DISTURBING INFLUENCE OF LAND ON THE TEMPERATURE OF THE SEA.

One of the most interesting results of the Hudson Bay experiments was the effect of land on the temperature of the sea. The coast

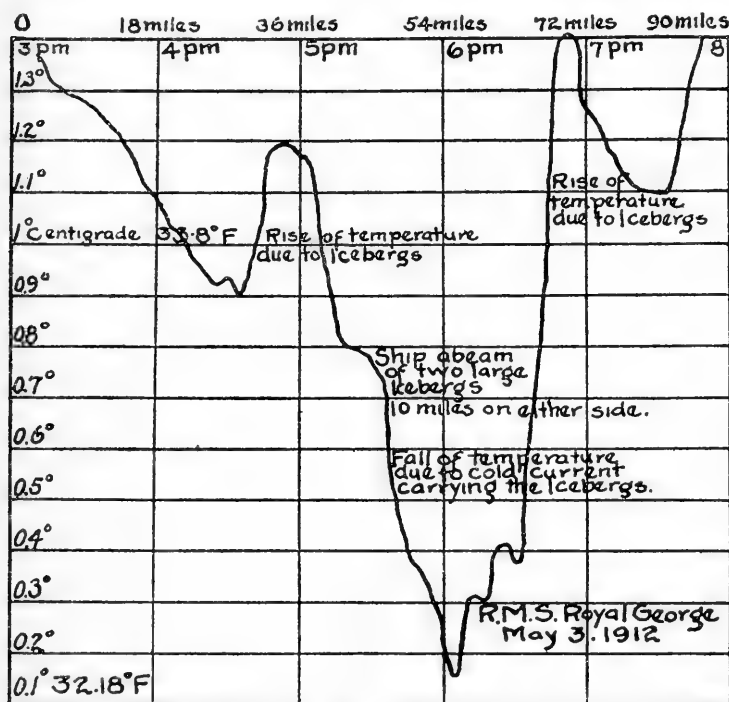

FIG. 5.—MICRO-THERMOGRAM OF THE ICEBERG EFFECT FROM RECORD MADE ON THE MICRO-THERMOMETER ON CANADIAN NORTHERN STEAMSHIP ROYAL GEORGE.

of Labrador appears to exert an influence in turning up the colder undercurrents of the Arctic stream. Thus, whenever the ship steamed in toward the coast line the temperature was found to fall 1° or 2°. The limit of the influence appears to be about 5 miles. It has been shown by Dr. Dawson that the shoals in the Bay of Fundy influence the surface temperatures, and this is in accord with the present results. Taking this into consideration, it appears that the microthermometer may be of great service in telling the presence of land and shoals from a ship at sea. Figure 4 shows the effect of the coast line of Labrador in lowering the surface temperature of the sea.

TRANSATLANTIC EXPERIMENTS.

During my trip across the Atlantic early in May of this year I

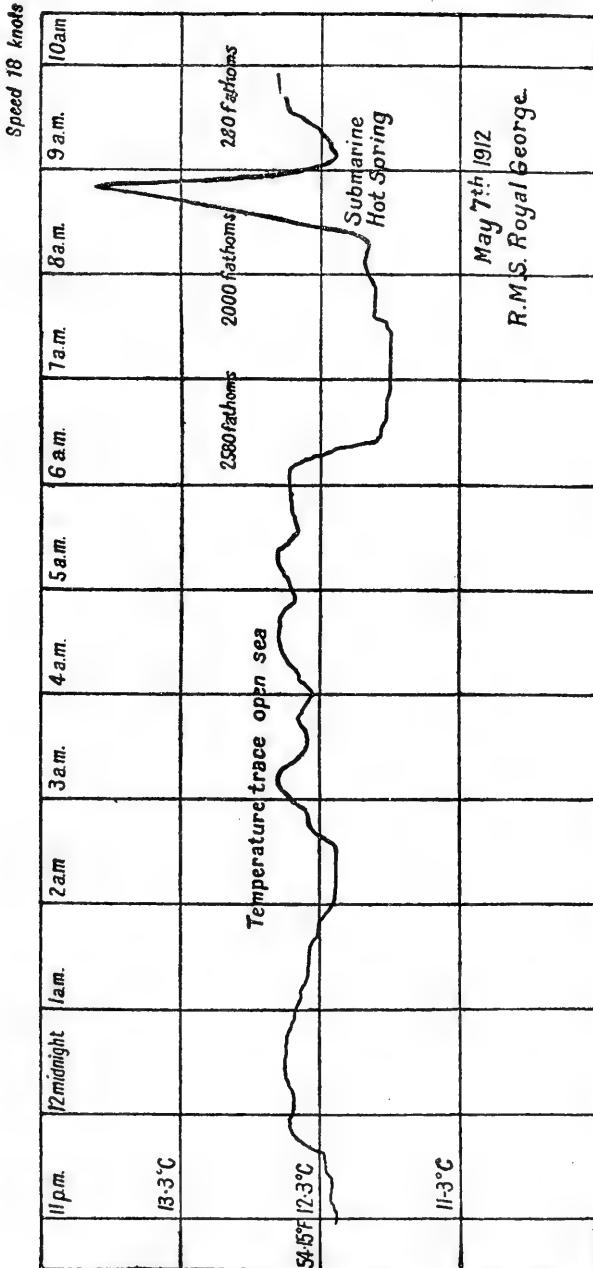

FIG. 6.—MICRO-THERMOGRAM OF THE OPEN SEA, SHOWING DISTURBANCE DUE TO SUBMARINE HOT SPRING OVER THE CONTINENTAL SHELF.

obtained a continuous record of the temperature of the sea from Halifax to Bristol. Through the kindness of the Canadian Northern

Steamship Co., I installed the microthermometer on the *Royal George*, and for 3,000 miles the instrument faithfully recorded the temperature

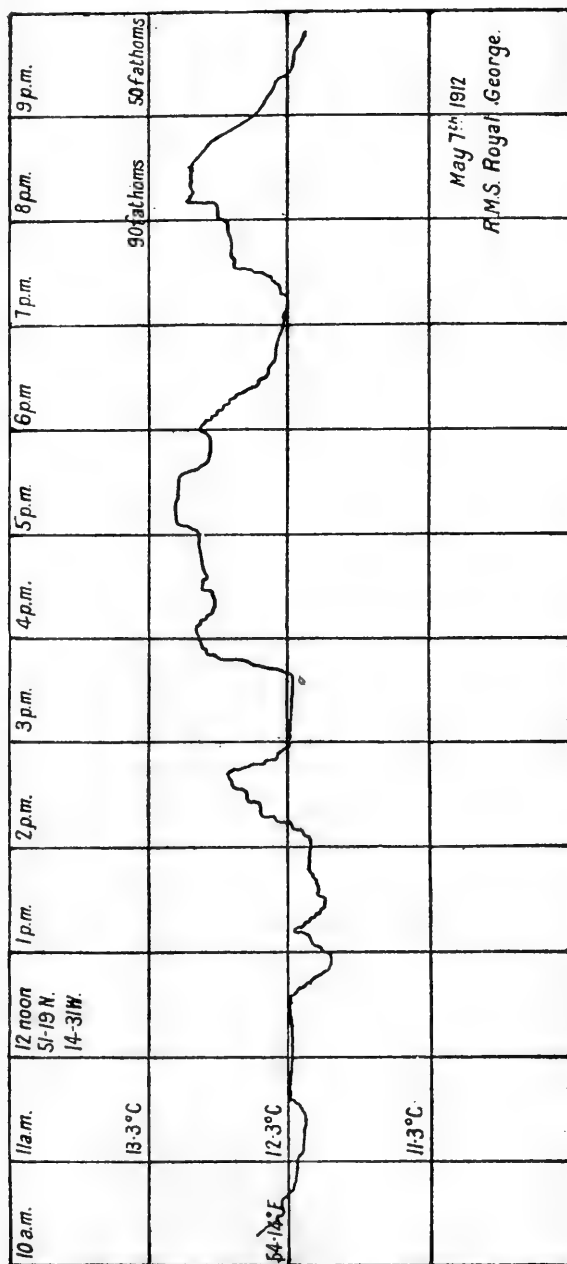

FIG. 7.—MICRO-THERMOGRAM SHOWING INCREASING TEMPERATURE VARIATION DUE TO APPROACH OF IRISH COAST.

variations in the sea. In these experiments the bulb of the thermometer was placed in sea water drawn continuously from the

circulating water of the engines at a point within a few feet of the intake mouth, situated about 16 feet below the water line. The wires passed through the engine room to Chief Engineer McQuitty's office, where the recorder was situated. The course followed was south of Cape Race to the south of Ireland.

The result of these experiments brings out several points of importance. The iceberg effect was clearly obtained when passing, early in the afternoon, into the ice track. Figure 5 shows this very well, even in water nearly at 32° F. The ship's course was altered here to avoid a large berg, and when abeam of two immense icebergs, situated approximately 10 miles on either side of the ship, the microthermometer showed its minimum reading, and as the bergs were left behind the temperature rose rapidly to a maximum, fell off again, and then rose steadily. No further ice was encountered until early the following morning, when several icebergs were passed in water measuring approximately 37° F.

The sudden change of temperature on passing out of the Arctic current into the Gulf Stream was clearly marked. Here a rise of temperature of nearly 10° was recorded in a little over half an hour. The great steadiness of the temperature of the Gulf Stream was remarkable, since for hundreds of miles the variations were not more than a quarter of a degree. The complete absence of any diurnal variation of temperature was clearly marked.

The tests have shown that large variations of sea temperature are caused only by some abnormal condition. Thus land affects it, icebergs produce characteristic disturbances, and current boundaries are clearly shown. The existence of a submarine hot spring was indicated when passing over the great wall of the continental shelf about 400 miles from the Irish coast. The bottom of the ocean rises quickly here from about 3 miles to one-third of a mile. Just over this wall the temperature rose rapidly to a sharp peak about $1\frac{1}{2}^{\circ}$ warmer than the surrounding sea, and immediately fell again. Figure 6 shows this disturbance very clearly marked. It shows the peak superimposed on the small variations characteristic of the open sea.

Nearing the Irish coast the variations of the sea temperature became more marked, and this commenced at a distance of 200 miles from the shore. Figure 7 illustrates this very well, where the variations may be seen to be much larger than in the previous plate. Figure 8 shows the effect of drawing near the Fastnet lighthouse, which was passed at a distance of about 4 miles. Here the temperature rose as in the iceberg effect, and then fell as the ship was abeam of the nearest point of land. The temperature then is seen to rise, as land was left behind, through the Irish Sea. The approach to Lundy Island caused the temperature to rise rapidly again and then

fall as the ship passed abeam of the island, about 300 yards. The effect is here more marked than in the case of the Fastnet, but it must be remembered that the ship passed much closer in the former case than in the latter. The proximity of the English coast caused a rapid fall of temperature, as shown in figure 8, when the ship was only 2 miles off the Somersetshire coast, steaming up the Bristol Channel. It is probable that the rise of temperature in both cases is due to the effect of fresh water from the land floating out over the surface of the sea and diluting it to a considerable distance.

Early in June, since giving this address, I was enabled, through the kindness of the Allan Steamship Line, to obtain measurements of the sea temperature on the northly route from Ireland across the

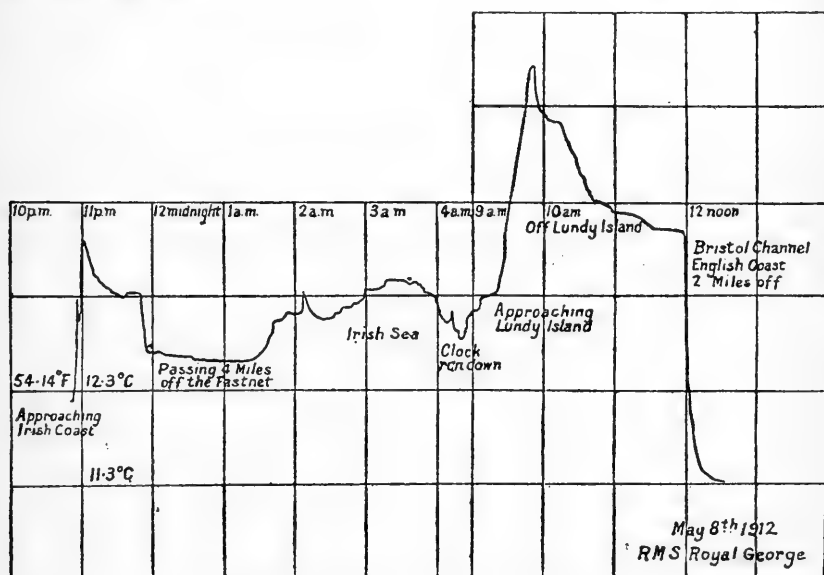

FIG. 8.—MICRO-THERMOGRAM SHOWING EFFECT OF LAND.

Atlantic to Cape Race and through the Gulf of St. Lawrence to Montreal. These charts, which I intend to publish later, completely confirmed the previous results. During fog in the ice track the iceberg effect was clearly obtained, and later a large iceberg was discovered ahead.

The icebergs all produced an effect in the instrument, even those passed at distances ranging from 8 to 12 miles. The temperature of the water through the ice track was between 40° and 41° F. Even when passing within a quarter of a mile of a berg it was only 39°, yet by the iceberg effect, i. e., the sharp rise of temperature to a maximum above the sea temperature, the influence of the berg could be clearly seen. This shows very well that the actual temperature of

the water is not a guide as to the proximity of ice, not only because this may be rising and falling, due to other causes, but because in different seasons of the year the arctic current is at different temperatures. The variation of temperature as ice is approached is, however, unmistakable, and this the microthermometer has invariably indicated. Should the ice be found in a locality where variations due to other causes are found, the iceberg effect is so characteristic and sharp that it will be superimposed on the other curve in such a way as to be unmistakable.

Nearing Cape Race the temperature fell rapidly several degrees below the surrounding sea temperature. Fresh-water rivers flowing into the St. Lawrence, where the waters were salt, produced the iceberg effect, thus indicating the probable cause of that phenomenon as being due to the water from the icebergs diluting the salt water. (See Appendix.)

THE PRACTICAL LOCATION OF ICE.

The important question arises as to how an iceberg can be definitely located by means of the microthermometer. The exact position of a berg ahead of a ship in a fog is of the greatest importance to determine. In general, it may be said that an iceberg will make itself felt in the first place by a rapid rise of temperature as it is approached. In the immediate vicinity of the berg the temperature falls quickly. The first warning will be when the temperature begins to mount up the scale above the surrounding sea temperature. In regions where icebergs are in close proximity safe navigation will be found possible, since no isothermal line can lead to an iceberg.

In conclusion, I wish to impress upon the reader the importance of the fact that the actual temperature of the water in the ice track is no guide to the proximity of even the largest iceberg. The experiences of north Atlantic sea captains alone testify to the uselessness of individual observations. It is to the small variations of temperature we must look for the infallible guide, and by means of the character of these variations we can determine the presence of ice, land, or currents.

APPENDIX 1.

LETTER FROM PROF. BARNES TO "NATURE," ON THE RISE OF TEMPERATURE ASSOCIATED WITH THE MELTING OF ICEBERGS.

[Letter to Nature, published in the issue of Dec. 12, 1913.]

During the summer of 1912 I had an opportunity of examining in detail the temperature effects of icebergs. The Canadian Government placed its steamship *Montcalm* at my disposal for the tests, and three weeks were spent through the Strait of Belle Isle. Careful records were made of the temperature effects of icebergs and land. These tests have shown conclusively that it is the *rise of temperature* which is the direct action of the melting iceberg, and that when a fall of temperature is observed near ice it is due to the action of a colder current in which the iceberg is floating, and is not due to the cooling influence of the ice. Cooler currents may exist throughout

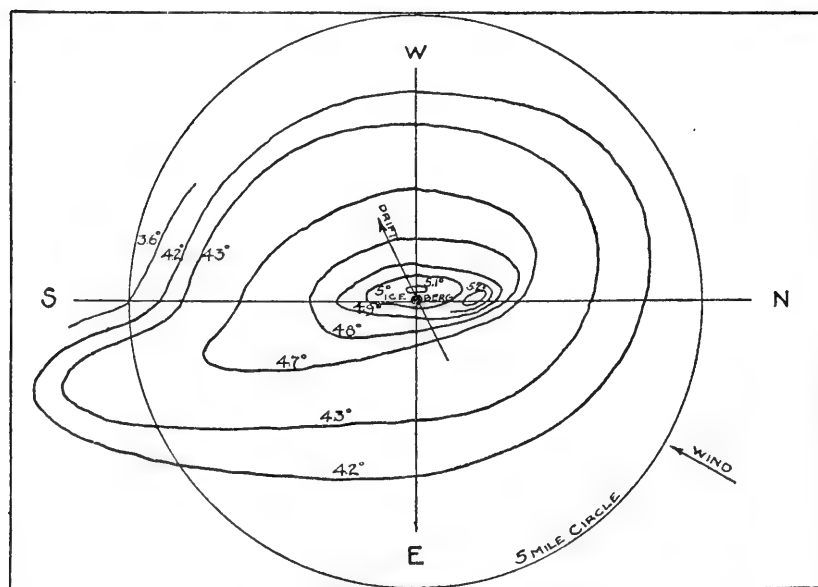

FIG. 9.—ISOTHERMAL LINES AROUND ICEBERG.

the Arctic current, whether accompanied by ice or not, but the presence of the ice causes a zone of warmer water to accumulate for a considerable distance about it.

The icebergs I studied in the Strait of Belle Isle and off the eastern end of the strait in the Labrador current showed no appreciable cooling, even within a few yards of them. The rise of temperature approaching an isolated berg was somewhat over 2° C. In figure 9 I show the isothermal lines about a typical berg off the eastern end of the Strait of Belle Isle. This diagram was obtained by arranging a number of courses for the ship from all sides up to a radius of 6 miles.

As a good illustration of how icebergs and groups of icebergs affect the water temperature I show a microthermogram in figure 10, taken from the records made passing westward through the Strait of Belle Isle. In every case the approach to ice caused a rise of temperature.

The explanation of this effect which I gave at my Friday evening discourse at the Royal Institution last May was founded on Pettersson's theory of ice melting in salt water. By this theory, which can easily be verified by a simple experiment, ice melting in salt water produces three currents: (1) A current of salt water cooled by the ice which sinks downward by gravity, (2) a current of warm salt water flowing toward the ice, and (3) a current of light fresh water from the ice rising and spreading out over the surface of the salt water.

I at first thought that it was this surface current of fresh water that influenced the microthermometer. The fringe of this lighter water would be warmer than the sea

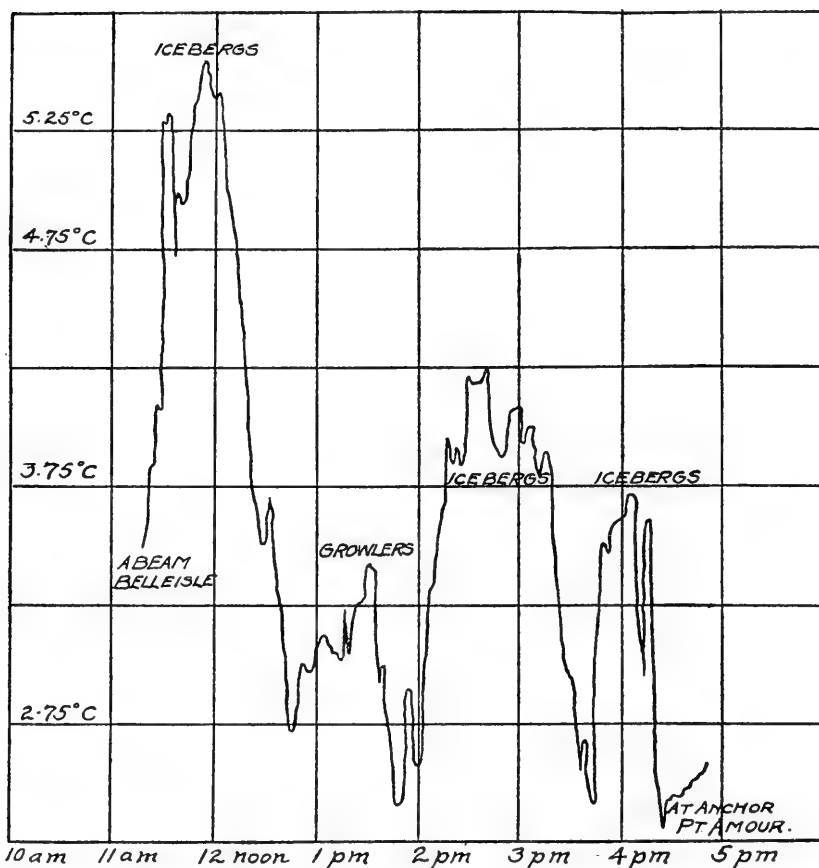

FIG. 10.—MICRO-THERMOGRAM TAKEN FROM THE STRAIT OF BELLE ISLE SHOWING EFFECT OF ICEBERG MEETING.

water on account of the action of the sun and scattered radiation, which is very strong at sea. The lighter water would retain the heat because it could not mix readily with the sea water. Near the iceberg I considered that a fall of temperature would result from the cooling influence of the surface current of fresher water.

My recent tests have shown, however, that an iceberg melts so slowly that little effect of the dilution can be detected, even right beside the berg. I took a number of samples of sea water at different distances from icebergs as well as samples taken far from ice. These samples I carefully bottled and brought home to the laboratory, where they were most accurately tested by the electric conductivity method in the physico-

chemical department by Dr. McIntosh and Mr. Otto Maass. No possible error could result in this way, and the tests being carried out at a constant temperature under the most favorable circumstances there is no reason to doubt their correctness. The comparison shows little dilution due to the icebergs, which goes to show how quickly the melted water from the berg is mixed with the sea water. Larger variations were found at different parts of the sea than were obtained in the proximity of ice.

It is evident that an iceberg in melting causes only two of the Petterson currents, i. e., a cold current which sinks downward carrying with it most of the melted ice water, and a horizontal surface current of sea water flowing in toward the ice to cause its melting. By this means we should expect the sea in the immediate proximity of icebergs to be warmer than further away, because the sea surface current is moving in toward the berg and does not share in the normal vertical circulation which tends to keep the sea surface temperature cooler.

The iceberg, in causing its own current of warmer water, provides for its own disintegration. Abundant evidence is at hand to show the melting process going on under the water line.

In my observations of icebergs I was greatly struck with the large amount of air dissolved in the ice. The white color of the berg is due to innumerable air bubbles in the ice, and not to snow on the surface. An iceberg is very deceptive in this way. While it looks quite soft, the ice is so hard as to make it difficult to chop with an ax. Ice water which I prepared for drinking on board ship with iceberg ice appeared to effervesce like soda water, merely due to the liberation of the air from the melting ice. It is possible that the sudden disappearance of bergs with a loud report is due to their explosion from accumulated air in the interior. I passed close to one berg which was casting off small pieces, apparently by the pressure of the pent-up air.

While icebergs send the temperature of the sea up, land and coast line send it down. This was observed all along the coast in the Straits of Belle Isle. This effect is due to the action of land in turning up the colder underwater by the action of tides and currents. A great deal of work remains to be done in studying the effect of land and shoals on the temperature of the sea, but observations show the effect not only here but on the Irish and English coasts.

From the point of view of the safety of our St. Lawrence route, the effect of land is most important. The iceberg causes us little worry because we have only a very short ice track, but to find means whereby the proximity of land can be determined of the greatest importance.

APPENDIX 2.

LETTER TO "NATURE" ON ICEBERG MELTING.

EDITOR NATURE: I have pleasure in sending you a photograph of the iceberg around which we obtained the isothermal lines published in the issue of Nature for Dec. 12 (pl. 2, fig. 1). I did not make an instrumental survey of this berg, but it was larger than the average of those met with in the Strait of Belle Isle. We sighted over 200 bergs during our trip and made traces of many of them. Invariably the temperature rose on the approach to a berg. Sometimes a small fall of temperature resulted abeam of the berg, but the rise of temperature was the one characteristic effect. The two other photographs illustrate the fantastic shapes seen in ice (pl. 2, fig. 1; pl. 3). I wish it were possible to furnish in some way an idea of the wonderful coloring, but I am totally unable to do so.

In the long iceberg you can see the dangerous overhanging ridge, which is caused by the underwater melting, and the lapping of the warmer water waves against the ice. This ridge is always found on bergs which have not recently turned over.

In the records which Mr. King was able to get for me in 1910, besides the rise of temperature a fall of temperature was obtained when the ship approached the various icebergs with the exception of one. These bergs were all floating in the main Arctic current off the eastern coast of Labrador. In the light of my recent work I feel sure that the drop in temperature was due to the influence of the cold current in which the

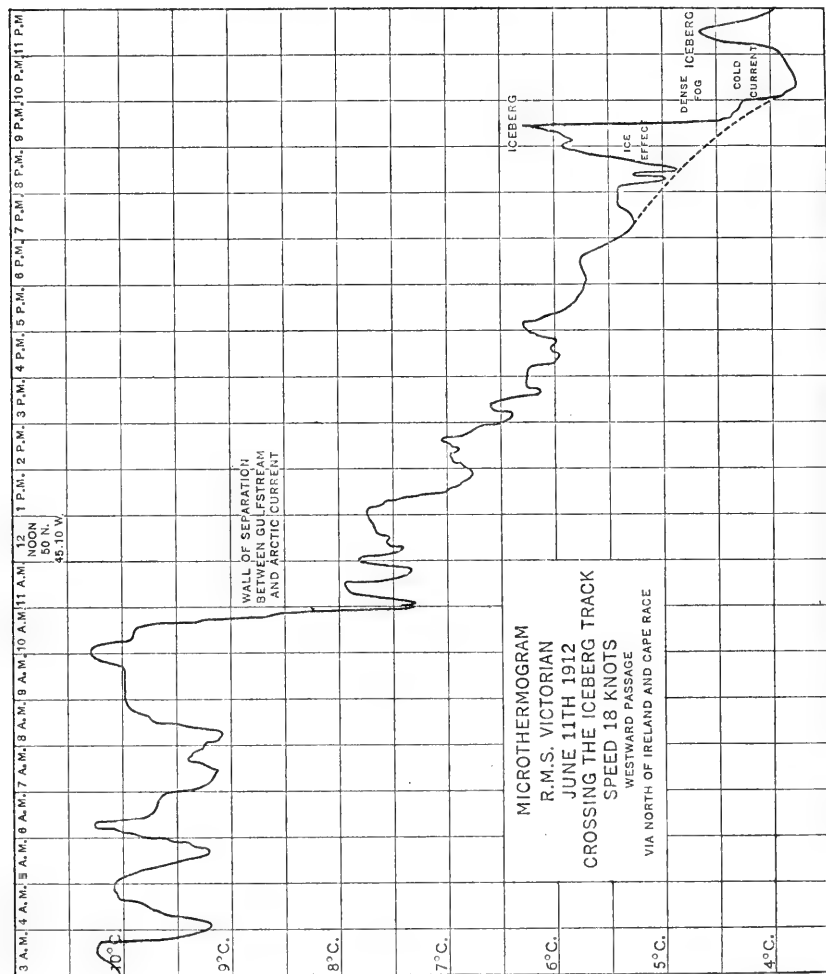

Fig. 11.—CHART ILLUSTRATING THE ICEBERG WARNING, AND THE COLD CURRENT.

iceberg was floating. These cold currents exist in the main Arctic current whether ice is present or not, but the presence of the ice is to slightly elevate the temperature. To assist in illustration of my meaning please refer to the microthermogram taken on the Allan Line R. M. S. *Victorian* last June (fig. 11). This record, which is a direct trace from the chart on the instrument, is through the ice track at a depth of 18 feet, by the Cape Race route. After passing the "Cold wall" the Arctic current drops in temperature regularly as the ship proceeds westward. The small variations up and down are partly due to icebergs passed at distances of 6 to 8 miles, and partly due to colder



ICEBERG USED TO OBTAIN THE ISOTHERMAL LINES.



ICEBERG SHOWING THE EFFECT OF WARM WATER MELTING. OBSERVE THE OVERHANGING RIDGE OF ICE.

This berg is grounded and prevented from turning over.

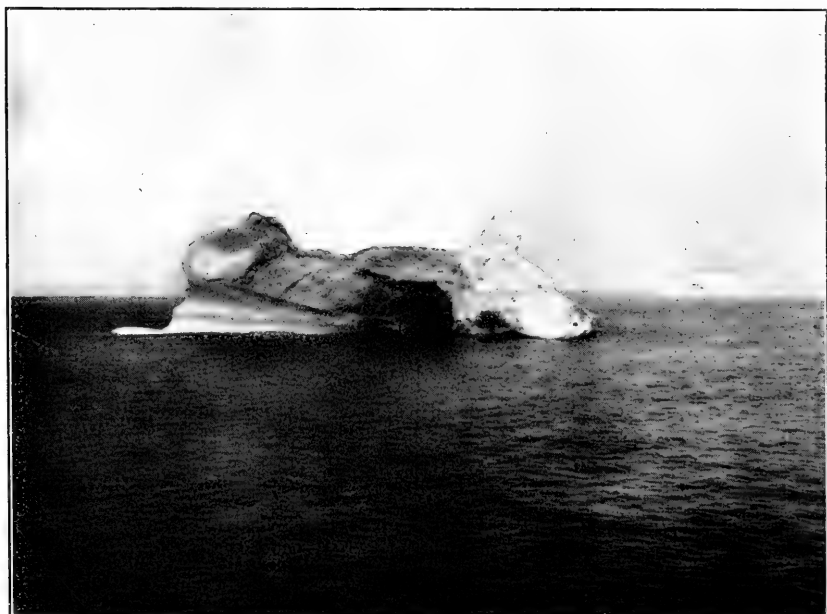

ICEBERG SHOWING THE SLEEPING WOLF.

currents. The lowest temperature recorded here was reached nearest the Newfoundland coast, but the effect of ice can be seen well marked by the sharp peak of temperature, which I have shaded. Just here we passed most of the ice close to and were obliged to proceed slowly in heavy fog at times. This colder and swifter Arctic current carried with it the greater proportion of the ice, but it is well known that this colder current exists whether accompanied by ice or not.

The great drop in temperature just before coming abeam of our largest berg was not due to the iceberg itself, but to the influence of the cold current. The effect of the ice is to hold the temperature abnormally high. The dotted line on the diagram represents how the temperature would probably have gone had no ice been present.

It would depend which way we approached this berg whether a drop in temperature would result. The temperature rises rapidly, whichever way we approach it. I have many other traces illustrating the same thing, and for this reason I was forced to abandon the idea that an iceberg sensibly cools the water in which it is floating. I was also unable to find by calculation that an iceberg could appreciably influence the sea water on account of its slow rate of melting.

It is very illusive to depend on laboratory tank experiments to illustrate sea water circulation. The conditions at sea are so very different. I was very much surprised not to find during my experiments last summer more conclusive evidence of sea-water dilution due to the melting icebergs. A large number of conductivity tests were made of sea water, and these are described in my Canadian Government report. The following may be of interest; the readings were made at 26° C.:

Table of conductivities of sea water taken in July (1912).

Close to grounded berg, Cape Bauld, Newfoundland	0. 05007
Strait of Belle Isle, eastern end.....	. 04827
10 miles east of Belle Isle.....	. 04850
Close abeam large berg.....	. 04787
1 mile north of same berg.....	. 04806
Close abeam same berg.....	. 04827
6 miles from same berg.....	. 04768
70 yards to leeward of a berg.....	. 04787
40 yards to windward of same berg.....	. 04787
100 yards to leeward of a berg.....	. 04806

The numbers may, perhaps, indicate a slight effect, but nothing like what I expected. My conductivity tests of the sea water brought back from Hudsons Strait in 1910 gave a value of 0.0480 at 25° C. Correcting for temperature this observation serves to connect the sea water entering the Strait of Belle Isle with that in Hudsons Strait. Eastward from Belle Isle Strait the conductivity rises rapidly for 180 miles, after which it becomes uniform up to 450 miles. The greatest Arctic current sweeps down close to the Labrador shore, and in through the Strait of Belle Isle where the resultant flow is westward. The following measurements of the conductivity through the ice track by the Belle Isle route were obtained last October on the *Empress of Britain*. The values were all measured at a uniform temperature of 25° C.

Abeam of Belle Isle.....	0. 04865
40 miles east of Belle Isle 04986
80 miles east of Belle Isle.....	. 05047
160 miles.....	. 05150
200 miles 05235
260 miles.....	. 05257
400 miles.....	. 05211
450 miles.....	. 05257

It is evident that the great Arctic current is of a lower order of salinity, and that its course may be traced along our eastern coast.

In the early spring when the water is cold the Newfoundland fishermen will find the cod in the vicinity of the icebergs, and will always obtain their catch there. Perhaps this is an indication of the warming influence of the bergs, for the cod will not live in very cold water.

Next summer I shall continue my observations more particularly with reference to the influence of land on the temperature of the sea. I hope before long to be able to publish here some typical microthermograms showing this effect.

H. T. BARNES.

MCGILL UNIVERSITY, *January 27, 1913.*

(From Prof. H. T. Barnes, F. R. S.)

HENRI POINCARÉ: HIS SCIENTIFIC WORK; HIS PHILOSOPHY.¹

By CHARLES NORDMANN.

With the sudden death of Henri Poincaré a great sadness came to all lovers of idealism and of science. Among all classes it was felt that a great light had been extinguished in the firmament of thought. But that feeling was nowhere so poignant or so lasting as among those who, in their silent arsenals, slowly forge their weapons for the struggle against the unknown, in the workshop of the physicist, beneath the dome of the astronomer, or in the bare room which the philosopher so richly furnishes with his meditations.

Henri Poincaré was not only the uncontested master of natural philosophy, the intellectual beacon whose penetrating rays could pierce all the regions of science. It was not for such qualities alone that we admire him, for he had also those characteristics which made us love him. That is why for a century he, more than any other philosopher, has had "that personal influence which he alone can exercise whose heart has not ceded to his brain."²

And now, when death takes from us this master whose task is done, it is the man alone for whom we mourn. In the work which he left was the best part of himself. When a man passes from us while yet young, yet full of creative activity, of mental vigor, of moral force, the weight of whose authority was constantly renewed, then our regrets are beyond bounds. In our sadness we are angry at fate, for what we lose is the unknown, the hopes without limit, the discoveries of to-morrow which those of yesterday promised.

Other nations regret the loss of Henri Poincaré no less than we. He was received with unbounded admiration in Germany where, on the invitation from their universities, he several times lectured so brilliantly on his work. Such intellectual crusades were among his greatest joys, for he felt that he was not only carrying conviction but friendship as well. Philosophers, mathematicians, astronomers, all spoke of him as the greatest authority of our time ("Die erste

¹ Translated by permission from *Revue des Deux Mondes*, Paris, Sept. 15, 1912, pp. 331-368.

² All the phrases included within quotation marks were expressed by Henri Poincaré himself unless otherwise stated.

Autorität von dieser Zeit"). And just recently one of the most eminent of American astronomers, Prof. Moulton, a member of the National Academy of Sciences of the United States, wrote of him that "although France had the honor of giving birth to this admirable man yet he may be regarded as a genius of the whole world. On his tomb should be engraved those words which the English have put on that of Newton, 'Mortals, congratulate yourselves that so great a man has lived for the honor of the human race.'"

When, contrary to all precedent, he won such honor among men of judgment the world over before the lapse of a century or two, we may be sure that the work of Poincaré was truly great and remarkable. But before glancing at that work as with the look of some beetle at a majestic oak, let us dwell for a few moments upon the thoughtful and captivating personality of this loved master.

I. THE MAN AND THE SCHOLAR.

With his ruddy face, his beard turning a little gray, and not always geometrically arranged, his shoulders bent as if under the ever present weight of his thoughts, the first impression of Henri Poincaré was one of singular spirituality and imperious gentleness. But two traits were particularly characteristic in him: His voice, deep and musical and remarkably animated when speaking of problems which greatly moved him, and his eyes, rather small, often agitated by rapid movements, under irregular eyebrows. In his eyes could be read the profound interior life which unceasingly animated his powerful brain. His glance was absent and kind, full of thought and penetration, his glasses scarcely veiling its depth and acuteness. His short sightedness, poorly corrected by his glasses, added to his absent look and made one say of him, "He is in the moon." Indeed, he was often very far away.

Legend began to form about him long before his death and attributed to him numerous traits, many of which for half a century have been attributed to Ampère, some erroneous, some indeed true.

It has been said that he was absent-minded; absorbed in thought would be more exact. Great thinkers, as well as all who are intense, are slaves of the interior tyrant which usurps their souls. When thought assumes control of a man it holds him under its claws as the vulture of Prometheus. The profound visions which possessed the soul of Poincaré left him no rest. Often he lost sight of the near at hand objects and the petty things of daily life, for his vision was closely focused on the infinite. It was when he was troubled with the immediate and ordinary things of life, and his judgment was then as sound as in regard to weightier matters, that he was ever really distracted, if we use the word in its true etymological sense.

In the discourse in which he was honored at the Académie française, M. Frédéric Masson wittily narrated several anecdotes of this absent-mindedness. Especially amusing was the carrying off one day unconsciously by Poincaré of a willow cage from the front of the shop of a basket maker. The incident was true, but upon inquiry we find that Poincaré was only 4 years old when it happened. How many men of genius, indeed, how many men of no genius, are there at whom no one has ever been astonished that at that age they did not show the prudence of Nestor in their conduct on some stroll? Nor is this at all for the purpose of weakening our skepticism at that "little science of conjecture" which we call history. Poincaré was himself amused at all such anecdotes. "They say," he conceded with a pleasant smile, "that creates a legend." Moreover, he has very well explained that "if we meet so many geometricians and naturalists who in the ordinary doings of everyday life show a conduct at times astonishing, it is because, made inattentive by their meditations to the ordinary things which surround them, they do not see what is about them; it is not because their eyes are not good that they do not see; it is because they are not seeing with them. That in no way hinders them from being capable of using keen discernment toward those objects which are of interest to them."

The psychological characteristics of Poincaré were made the object of an interesting and very full study by Dr. Toulouse,¹ of which certain conclusions should be noted. This study was made especially as an experimental test of the celebrated statement of Moreau of Tours that "genius is a nervous disease." We know how Lombroso took up and amplified that idea and that he thought that he could conclude from his researches that genius is inseparably connected with nervous troubles, especially with epilepsy. Yet, despite all those researches and from whatever side they conducted their attack, Dr. Toulouse and his collaborators were unable to find in Poincaré the least trace of neuropathy. All their measures, all their tests, showed them a man perfectly normal psycho-physiologically, possessing in every way the most harmonious and perfect equilibrium. Thus he demonstrated at its proper value one of the most brilliant, one of the most sensational errors of Prof. Lombroso.

Because, physiologically Poincaré was, despite his genius, in no way different from the average of ordinary men, I would not fail, were I a spiritualist, to use this as an argument in favor of a soul apart from the body.

The instability of attention in Poincaré was one of the characteristics which most struck Dr. Toulouse. Indeed, Poincaré had a habit

¹ A medico-psychological inquiry into intellectual superiority, vol. 2 (Enquête médico-psychologique sur la supériorité intellectuelle).

of jumping from one subject to another entirely unconnected, of jumping, if I may employ a slang phrase, "from a cock to a donkey." In keeping with this was his habit, which often astonished strangers, of rising brusquely in the middle of a conversation, walking briskly for a moment, and then reseating himself. "Those are ideas," he would say, "which come and go." Perhaps we might thus comprehend the "demon" of a Socrates or the "voice" of a Joan of Arc.

"Poincaré is not an emotional man," Dr. Toulouse also wrote; "he is neither affable nor confidential." Perhaps that might have been inferred, but Dr. Toulouse was certainly deceived. Poincaré, retired within the ivory towers of his thoughts, was insensible to all that disturbs the hearts of ordinary men. He himself used a somewhat lofty phrase full of a sad stoicism which would confirm that impression, when he said: "The sole end which is worthy of our labor is the search for truth. There is no doubt that first we must set ourselves to ease human suffering, but why? Not to suffer is a negative ideal and one which would be most certainly attained by the annihilation of the world." If in the eyes of the world he thus seemed to resist his own feelings, we ought not to believe them the less sensitive. But to goodness no less than to beauty belongs the quality of modesty. Poincaré was adverse to the familiarity of special friendships, because, with Renan, he felt that they made one unjust and were unfavorable to larger interests. Nevertheless, his kindness was perfect, even with those who importuned him for advice or praise. Within those two concentric circles, the family and the fatherland, modern society has accustomed us to limit our altruistic affections. He loved them dearly. He was too good a son of Lorraine not to feel hurt when he thought of mutilated France; in what sad and troubled accents he knew how to speak of that great grief which has left us twice inconsolable, even though our sons seem to forget. But it was especially in his family, that confidential fatherland, that he showed without constraint his charming tenderness of heart. He himself taught his four children to read, and I have known aspects of his romps with them which would recall Henry IV, but it would be imprudent to describe them here. How far removed he seems in these from that abstract mind in which they would have us see him, retired like some monstrous snail within the inaccessible convolutions of his thoughts. Moreover, he had the good fortune to live in surroundings the most favorable to creative work, in an atmosphere of silent affection and discreet quiet which the gentle hands of the women of his household knew how to create around him.

Poincaré was attracted by beauty in all its forms provided only it was noble. Music, painting, poetry, were his preferred relaxations. Even as to his science we will see that he loved it above all for the esthetic pleasure it brought to him. An anecdote is told of him by

M. Sageret which shows well the disdain with which he neglected what was not science for science, or, if I may dare to use a new phrase, Science for Art. The director of the *École supérieure des télégraphes* had asked him to discuss in a lecture a somewhat difficult problem relative to the propagation of electric currents in cables. Poincaré accepted and solved the problem "at first sight" without having had the time to discuss it. Congratulations came from the director. "Yes," replied Poincaré, "I have found the value of L , but is it measured in kilograms or kilometers?" It is useless to add that he knew very well what he was talking about.

We should also recall his brilliant school days, his wonderful faculty for assimilation; he followed all the mathematical courses of the *École polytechnique* without taking a single note, not because he remembered the demonstrations but because he could reason them out at will. We should recall that he was very skilled in reasoning, but what does that prove? The greater portion of the teachers of mathematics have left no trace of themselves in the world. For it is one thing to assimilate, another to invent, and we know of scientists of renown who have not succeeded in making themselves accepted as fellows in our colleges.

To be complete we should conclude by speaking of his career, his rise to the very highest rank, to the greatest honors given by society. But that matters little. There is no common measure between Poincaré and the many other men whose ranks and titles in this social ant hill are equal to his and of whom some one—I have forgotten who—said, "their conceit ill concealed their incompetence." Poincaré, on the contrary, never attached much weight to such honors. He was deeply and sincerely modest, hesitating always to announce definite conclusions and his intellectual attitude was constantly one of doubt. It is perhaps for that reason that among a dozen great scientists who have lived during the last century, he accomplished the miracle of never having made a single enemy, a single one hostile to him in science.

In his scientific work, Poincaré touched all the great mathematical questions. He did not merely touch them as, from the multiplicity of problems examined, one might suppose—just skimming over them. This Michelangelo of thought could not, would not, stop at the little details—for the small harvests to be reaped from the beaten paths. It was in the most obscure corners, the most inaccessible of matter, that he knew how by first onslaught, with great cuts with his chisel, to open paths full of light and unknown flowers.

Mathematician above all and before all, he could clear fields for himself in those studies which transcend reality and where the pure geometrician, lost completely among his harmonious abstractions and pure deductions, constructs at his will, immaterial, impeccable

beings of strange beauty. The pure mathematician has at his beck intimate delights of such esthetic quality that it often comes to pass that he no longer finds interest in the exterior world, lost in a kind of grand mysticism. Poincaré, however, was not of that kind, although his researches in geometry and analysis made him the greatest mathematician of our times. "Experience," he said, "is the sole source of all truth." And those words acquired a singular force coming from the mouth of the greatest theorist of our epoch. That was why among mathematical problems Poincaré attacked especially those which physics brought before him. That was why he passed so readily from pure analysis to mathematical physics and then to celestial mechanics. And, finally, that was why he came to reflect upon the very foundations of our knowledge, upon the past and the future of our world, upon the value of our thoughts as we pass to the limits of what we can know to the borders of that abyss which separates physics and metaphysics and into which abyss most of us can not glance except with dizziness. It tore from Pascal many superb sighs of grief, yet Poincaré could look at such matters as he looked at all other things, not with a useless despair, but without prejudice and foolish illusions, with simple, clear, and profound good sense; he knew how to look at them and after a glance with his eagle eye to sum up all in a word.

II. POINCARÉ, THE MATHEMATICIAN.

"My daily mathematical studies," said Poincaré—"how shall I express myself?—are esoteric and many of my hearers would revere them more from afar than close to." That is what he said one day to excuse himself for speaking on a mathematical subject. Whenever he commenced one of his profound lectures, in which he charmed his listeners, he felt the need of thus excusing himself. Thus by his modesty he knew how to make us pardon his genius. However that may be, you will permit me to appropriate that remark for the present occasion that I may not beyond measure speak of the purely mathematical researches of Poincaré. It would require a dozen years of preliminary mathematical study for the curious reader to be able to know them, and if he were familiar with the elements such as he would get in the ordinary college course he might take a glance at them.

Were I to characterize in a few words what Poincaré brought new into the divers processes of calculus and which won for him the title "Princeps Mathematicorum," which unanimous consent has given to no other man since Gauss, I would proceed thus: In algebra and in arithmetic, where he introduced the new and fertile idea of arithmetical invariants and in the general theory of functions, his dis-

coveries were numerous and would have sufficed for the glory of several mathematicians.

It was especially in the theory of differential equations that the genius of Poincaré showed itself. If he spent on them the greater part of his intellectual resources it was without doubt because most of the problems offered in the physical study of the universe led to just such equations. Newton was the first to show that the state of a moving system, or, more generally, that of the universe, depends only on its immediately preceding state, and that all the changes in nature take place in a continuous manner. True, the ancients in their adage, "Natura non fecit saltus," had an inkling of it. But Newton was the first, with the great philosophers of the seventeenth century, to free the idea from the scholastic errors which perverted it and then to assure its development. A law, then, is only the necessary relation between the present state of the world and that immediately preceding. It is a consequence of this that in place of studying directly a succession of events we may limit ourselves to considering the manner in which two successive phenomena occur; in other words, we may express our succession by a differential equation. All natural laws which have been discovered are only differential equations. Looking at it slightly differently, such equations have been possible in physics because the greater part of physical phenomena may be analyzed as the succession of a great number of elementary events, "infinitesimals," all similar.

The knowledge of this elementary fact allows us to construct the differential equation and we have then to use only a method of summation in order to deduce an observable and verifiable complex phenomenon. This mathematical operation of summation is called the "integration" of the differential equation. In the greater number of cases this integration is impossible, and perhaps all progress in physics depends on perfecting the process of integration. That was the principal work of Poincaré in mathematics. And in that line his work was amazing, especially in the development of those now famous functions, the simplest of which are known as the Fuchsian functions (named after the German mathematician Fuchs, whose work had been of aid to Poincaré). We may represent by these new transcendental functions, which are also called automorphic, curves of any degree and solve all linear differential equations with algebraic coefficients. Poincaré thus gave us, using the apt expression of his colleague, M. Humbert, of the Académie des sciences, "the keys of the algebraic world." Poincaré himself used these algebraic tools in his researches in celestial mechanics.

To tell the truth, the Newtonian idea as to the continuity of physical phenomena has of late been somewhat battered down in several

places by the new and odd theory of "quanta," to the construction of which several physical discoveries have led. This supposes a certain physical discontinuity in the atomic phenomena which produce radiation.¹ Not wishing to go too much into detail on this subject, I am going to make a somewhat bold comparison, but one which is perhaps not wholly void of meaning: The hypothesis of quanta has grown up side by side with that of continuity, just as in biology the Larmarkian and Darwinian theories of slow and imperceptible evolution have come recently face to face with those of sudden and discontinuous mutation of the Dutch naturalist, De Vries. The latter, by the new evidence which he has brought forward, has not destroyed the older theory; he has merely enlarged it, shown its limitations, and left it intact in its greater significations. Similarly, the theory of quanta, it is probable, will not prevent the greater part, if not all, of physical phenomena from being capable of representation by differential equations. The progress which the latter have brought, the physical discoveries to which they have led, notably in optics, in electricity, and in astronomy, are their guaranty. Accordingly, the new functions discovered by Poincaré will always remain one of the most brilliant contributions which he brought through pure theory to the study of external phenomena.

If we study the characteristics of the method of Poincaré and of his mathematical genius, we find especially a wonderful faculty for generalization. Instead of starting, as do most students, with a study of the minor details, he jumped to the very heart of his problem, neglecting the intermediate details, like an audacious conqueror, who, without preliminary skirmishing, makes his first onslaught upon the master difficulty, the most impregnable fortress, inventing on the spot the instruments for subduing it and then forcing its surrender without striking a blow. Then we would leave to others the investigation and organization of the new province which he had just won and pass immediately to other conquests. In that sense we may speak of him as being "more a conqueror than a colonizer."² There resulted that peculiar method of thought so noticeable in his philosophical writings, so disconcerting at times to the novice and which brought upon him the reproach of being disconnected. True, Poincaré's process of reasoning was not smooth and continuous; he proceeded by successive bounds which had more the effect of a broken line. But the profile of a diamond is likewise made of broken lines, from the very virtue of which its brilliancy results. Such a logical method is not common, but, borrowing the words of M. Painlevé,

¹ Poincaré summarized excellently in the following words shortly before his death the conclusions to which the theory of quanta led him: "A physical system can exist only in a finite number of distinct states; it leaps from one of these states to another without passing through a continuous series of intermediate states."

² Borel: *Revue du Mois*, vol. 7, p. 362.

“Should we be surprised if a lion does not run with the steps of a mouse?”

Upon the very structure of his thoughts, upon the mechanism of his marvelous cerebral workshop, Poincaré has left us strange and suggestive confidences. Since what we know of the universe comes only from its image as reflected to us through our brain, that knowledge is affected by all the properties and deformations of that inner mirror, and psychology will without doubt one day be the master science. Accordingly the psychological aspects of a brain like that of Poincaré, which he has shown us naked with such touching sincerity, are of unequalled interest. In studying the genesis of mathematical invention, “which without doubt is the purest and most exclusively rational process of our brain because it seems the least conditioned by the exterior world,” we find the most essential characteristics of the human mind which we may ever hope to get. Laplace has said, “A knowledge of the methods of a man of science are no less useful to the progress of science or toward his own glory than the discoveries themselves.”

Contrary to our expectations, conscious work, voluntary and logical, did not with Poincaré play the most important part. Nothing is more amusing in that respect than the manner in which he has told us of his discovery of the Fuchsian function. This idea which struggled vaguely in his brain one evening after he had taken, contrary to habit, a cup of coffee so that he could not sleep, took shape little by little under the strangest of circumstances. Everyone has read the pages where he has told how he saw in due proportion all the chief difficulties but did not consider them further, and then how, long afterwards, in a flash, the solutions he wished appeared to him when he was putting his foot on the step of an omnibus; at another time when crossing a street, and yet again on a geological stroll in the midst of a trifling conversation.

The “subconscious self,” or, as some have put it, “the subliminal self,” plays in mathematical invention a supreme part. There where we believe reason and will ruled alone we find something appearing analogous to the inspiration which custom attributes to poets and composers. And it is a troublesome circumstance that this subconscious self succeeds in solving problems and overcoming difficulties which the conscious self could not. Is then the subconscious not superior to the conscious self? Have we not here something within, which is greater than ourselves, a sort of divine essence superior to our will and reason which makes us capable of tasks greater than ourselves? We can understand the importance of such a question and the spiritual significance of a positive reply. The positive mind of Poincaré, however, would not admit supernatural explanations unless absolutely necessary and in a penetrating and accurate investigation

he has shown a way to escape such a conclusion. He makes us see how the automatism of the subliminal self works only upon material which the conscious self prepares for it and then explains how, among the great number of combinations which the subliminal self forms, only those come into our consciousness which are apt and elegant and consequently affect our senses and attract our attention. The simple and most harmonious construction turns out to be precisely the most useful as experience and reason repeatedly teaches. The esthetic sentiment for the harmony of form and number and geometrical elegance dominates the thought of the mathematician. His soul is first of all that of an artist and a poet.

These views, so deep and true, are somewhat at variance with the classic idea of a mathematician, respectable, exact, but rather ludicrous with his mechanical brain and an eye which the traditional glasses have rendered blind to all beauty and in whose heart nature has placed, instead of feeling, a table of seven-decimal-place logarithms.

In unveiling to us in a man of science worthy of the name, a sensitive and esthetic being, Poincaré has again yielded to his innate modesty. The limitations of our brain have made us exalt its merits in our modern society where the "cult of intelligence" rules; we have had and perhaps still have a tendency to exalt the virtues of the will at the expense of those which come from the heart. We hold as superior to all else the attributes of the thinking man and so our justice has a deep disdain for those who are irresponsible, though indeed we do not judge that they merit punishment. In thus showing us that his so logical a development for science was due largely to his subconscious and involuntary and only partly to his conscious faculties, Poincaré doubtless somewhat lowered his own glory, perhaps that of all scientists in the eyes of some; as to that I imagine that he would be easily consoled. This marvelous autopsychological study has explained one thing which seemed at first very surprising, how working only four hours, or rather consciously working only four hours a day, Poincaré was able to produce a scientific contribution perhaps greater than that ever made by any other mathematician. Uncontrolled by his will, his cerebral machine worked by itself night and day, without stopping. Perhaps otherwise he might not have died so young. That interior flame which without rest, shone so brightly, burned up too soon the lamp which held it.

III. POINCARÉ THE ASTRONOMER.

In astronomy the work of Poincaré was gigantic. That science could not have failed to attract him from the very first because of all the exterior world it offered to his power as a generalizer, disdainful of conditions, the greatest and most lasting problems. There is no

other branch of natural philosophy which provides to the meditation or to esthetic revery such grandeur. Astronomy is the mother of all the sciences and it is still today the most advanced, that in which we can best predict the future.

The study of the stability of our universe has been for two centuries the fundamental problem of celestial mechanics for the solution of which the genius of mathematicians has striven. This portion of space wherein we are placed, the solar system, is it stable? Will those planets which we have observed from time immemorial continue to describe invariably the same immense orbits with only a few periodic oscillations from their mean positions, will they continue thus indefinitely in the future? Or will this machine so harmoniously contrived, and wherein we at present see no apparent sign of possible destruction, never become unstable and disappear some day? That is the problem.

When Newton demonstrated that gravity acted not only between the sun and the planets but also between the planets themselves, it was seen that there must result irregularities in the harmony of the solar system, that the reciprocal attraction of the planets must slightly deform the perfect ellipses which the attraction of the sun alone would have made them describe. Truly these deformations are small because of the smallness of the masses of the planets compared with the central sun (Jupiter's mass is 300 times that of the earth but only one one-thousandth that of the sun). But might not these planetary perturbations, accumulating through centuries the effects already observable in the time of Newton, finally destroy the Kepler ellipses? At any rate, the simple harmony of the world of Kepler no longer is real. Newton, strongly embarrassed by the foresight of the impending catastrophe, has made, in his optics, this allusion to the planetary inequalities, "which probably," he says, "will become so great in the long course of time that finally the system will have to be put in order by its Creator."

In 1772 Laplace believed he was able to demonstrate that these fears were groundless. He showed that the secular inequalities of the planetary elements compensated themselves periodically at the end of a sufficiently long period and the terms of the first order of the perturbations would disappear in the calculations. That implies a stability of our system at least for a very long time, thousands of secular periods. Consequently, Laplace criticized the *deus ex machina* invoked by Newton and somewhat haughtily believed he could affirm, arguing from his results, that the machinery of our world had had no need of the initial fillip and that it would go ahead indefinitely without the need of outside assistance. Is it necessary to note that there must be some fault in logic on the part of one who could suppose that when the solar system had so beautifully evolved

from a nebula the process of evolution would stop and become fixed in eternal immobility or perhaps better in invariable mobility? But even great men sometimes make slips in their logic. There were never men who made none.¹

Later, two celebrated mathematicians, Lagrange and Poisson, considerably extended the system of Laplace. The indefinite stability of the planetary elements seemed assured forever. The address delivered by an astronomer, and he not one of the least, M. de Pontécoulant, before the Académie des Sciences, when the statue of Poisson was dedicated, shows well the state of belief of the world upon this matter then, and it was scarcely altered at the end of the nineteenth century.

"For his masterpiece," he said, "Poisson had the honor of solving that most important problem, the stability of the solar system, of which, after the works of Laplace and Lagrange, doubts still existed in the most judicial minds. In the future the harmony of the celestial spheres is assured. Their orbits will never depart from the almost circular form which they have to-day and their respective positions will make only slight departures from a mean position in which the succession of centuries will finally see them revolving. The physical universe was therefore built upon indestructible foundations, and God, in order to conserve the human race, will not be obliged, as Newton wrongly believed, to retouch his work."

So matters stood when Poincaré attacked the problem. Soon discoveries succeeded discoveries. The problem set is this: Being given several bodies of known masses in given places and with given velocities at some known moment, to determine what these places and velocities will be at any future time, t . For a single planet and the sun the problem is completely solved by the laws of Kepler. But when *two* planets and the sun are considered the reciprocal attraction of the planets upon each other must be considered. Then we have the celebrated problem of *three bodies*. The difficulties of this latter problem are such that it can be solved only by the method of successive approximations. In the equations which led Laplace and his successors to their conclusions as to the stability, the coordinates of the planets were developed in a series whose terms were arranged in powers of the masses. Poincaré first showed that we could not thus obtain an indefinite approximation and that the convergence of the

¹ It is related that when Laplace presented his work to Bonaparte, the latter asked whether, as with Newton, some place had been left to the Creator in the maintenance of order in the world. Laplace replied: "Citizen, premier consul, I have had no need of such an hypothesis." If that was the response really made, I do not see at all the ground for the irreverential or atheistical attitude often attributed to Laplace. There may indeed be a very deeply religious sentiment in the belief of a universe so harmoniously constituted that there would be no need of continual retouching for it to preserve its course. "Men," Poincaré has written, "demand that God continually prove his existence by miracles; but the eternal marvel is that there are not miracles continuously. It is for that very reason that the world is divine because it does work so harmoniously. If it were ruled by caprice, how could we then prove that chance did not reign supreme?"

series had been assumed without proof by those who employed them, and that it is probable that in the terms of higher order, t , the time, enters not only with the sine and cosine, which would lead to periodic compensations of the irregularities, but also outside of the trigonometric functions, so that certain of the terms, at first negligible, may possibly increase indefinitely with the time. Here with one blow he reduced to naught the conclusions of Laplace and his successors.

Poincaré found later that certain new methods would allow him to express in every case the coordinates of the planets in a purely trigonometric series, avoiding the inconveniences of the former methods, and he proved for the purpose a brilliant series of new theorems of great generality. The rigorous proof of the stability now depended only on knowing whether the new series would be convergent. This was the knot of the problem, for before Poincaré all astronomers had supposed a trigonometric series to be absolutely convergent. Poincaré showed that that opinion, despite the fact that it was classic, was erroneous, and indeed that, when we have represented the coordinates of the planets by a convergent series which is not very different from that employed by Laplace, we will not have demonstrated the stability of the solar system. Because of these great results, which are like the crowning of three centuries of incessant research, posterity will certainly place this new treatise on celestial mechanics (*Les méthodes nouvelles de la mécanique céleste*) by the side of the immortal *Principia* of Newton. All future researches on this subject must be built upon the solid foundations laid by Poincaré.

Celestial mechanics in general considers the planets only as if all their matter were concentrated in mathematical points. It leaves out of consideration the other properties of these objects, evidently generally negligible in comparison with the Newtonian attraction, but whose effects with time may become of importance relative to the stability of the systems. Attacking the question from a new side, Poincaré showed that there are three preponderant forces tending to modify the orbits: The resistance, weak though it may be, of the interplanetary medium; the tides which the planets and the sun produce upon each other; and the magnetism of the planets. The accumulated effects of these will finally precipitate the planets into the sun. That will be the end of our system of planets. Will that be the end of the human race? Certainly not, for it is very probable that other changes will have ended terrestrial life long before the day of that final catastrophe; the day? no, I should not say day, for there will no longer be day and night, for our earth will then forever present the same side toward the sun! Many reasons lead us to believe that in the future as well as in the past the duration of human life upon this globe will be infinitely small compared to the time our earth has

its being. So those who fear that their end will be hastened by that of the solar system may be reassured. The retinue of the sun once disappeared, does that mean that other analogous and distant systems, scattered here and there like a living dust, will not exist indefinitely? That is a question much discussed at present, but which we can not answer.

The problem of the shape of a star resolves itself into that of a fluid mass rotating and subject to various forces. Next to the problem of three bodies it is the most important one of celestial mechanics. Here, too, Poincaré made remarkable discoveries. They mark an epoch in the study of the subject, as Sir George Darwin remarked the day he presented to Poincaré the gold medal of the Royal Society of London. Formerly but two figures of equilibrium were known for rotating fluids, the ellipsoid of revolution and that of Jacobi with three unequal axes. Poincaré found through his calculations an infinite number of others which are stable and shaped like pears, whence the name *aploides* given to this class of bodies. The pear-shaped bodies discovered by Poincaré appear to have an important place in nature, as proved by the evidence from certain nebulae and close double stars. They enable us to get some idea of the mechanism of that bipartition, somewhat analogous to that of organic cells, which may have given birth to a great number of binary systems and which successively separated the earth from the sun and then the moon from the earth.

Finally Poincaré showed that no form of equilibrium is stable when the velocity of rotation exceeds a certain limit. He at once applied this fact to that enigmatic marvel, the ring system of Saturn. Maxwell showed that the rings could not be solid and if fluid that their density could not exceed three one-hundredths that of Saturn. Poincaré proved that if the rings are fluid they could not be stable unless their density is greater than one-sixtieth that of Saturn. He concluded that the only alternative is to suppose that they are formed of a multitude of small satellites, gravitating independently. We know how spectrum analysis subsequently proved this marvelous deduction of this mathematical genius.

A small portion only of Poincaré's scientific work is included in that just described. Even a superficial description of all would require volumes, it is so vast. Before turning to another branch of his work, that which will reveal his philosophy, I feel almost a kind of remorse as I find myself obliged, by the limitations of this tribute, to pass over in silence all those great discoveries which he has so generously, almost indifferently, if I may use that word, worked out, always with the same mastery, in such different branches of science, in optics, in thermodynamics, in electricity, or in astronomy; sometimes with daring strokes he treated of the relations between the

matter and the ether; again he compared the thousands of suns of the Milky Way to the molecules of a bubble of gas, applying to them the kinetic theory and opening in the stellar universe such astonishing aspects; then from a ray of light sent from one of the planets he teaches us to learn at the same time the motion of the sun which sends the ray, of the planet which reflects it, and of the earth which receives it. But we must stop; when we are passing through a beautiful and vast forest full of varied aspects, we must not stop only in the first pleasing shade we reach, for yet farther on there will be found others where new rhythms will arouse our emotions and enchant our eyes.

IV. POINCARÉ THE PHILOSOPHER.

From science to philosophy there is but a step to take, they so bound and penetrate each other. The Greeks had but one word to express each. Even to-day the English call the physical study of the universe natural philosophy. Poincaré could not escape that attraction which has forced all the great workers in the exact sciences from Democritus to d'Alembert, toward the end of their lives, to reflect upon the primordial mysteries of the strange universe wherein our ephemeral thoughts live and die. When, upon the front of the Parthenon some rival of Phidias had cut that exquisite equestrian frieze, he must have stepped back a moment so as to judge his work the better as a whole, and then later, forgetful of his own efforts, have become absorbed in the vast harmony of the whole great temple. And so all the great wise men worthy of the name feel toward the universe.

The philosophical ideas of Poincaré have deeply impressed all those who think. They have helped through their tendencies to give the intellectual attributes of our generation its so definite profile. By singular chance they have stirred the most adverse camps. Each one has wished to use them for their weapons; vain desires, for these ideas soar far above them, and, indeed, such ideas sometimes seem to unchain and reanimate quarrels of other ages. Whence does this man get this strange power of moving thus, despite himself, by his thoughts alone, in this abstract domain, in a realistic epoch where the conflicts of every-day life press harder than ever upon the world of ideals? This power is due to Poincaré's intellectual superiority and especially to his thorough sincerity. In what way are these new points of view which this great man has developed so suggestive, so useful, so convincing? Let us try to find out.

If we exclude the bitter, ever-present struggle for better living, which does not gain in dignity as we pass from animal to man, it seems as if all man's striving came solely because he thirsts both for truth and for justice. And we always find, save with Dr. Pangloss,

who was a mythological being dead without descendants, that in reality justice is not always the rule. The two words, truth and justice, which we are accustomed to couple, correspond in a certain way to states which the very nature of things render mutually exclusive. Some men, whom truth, the desire for knowledge above all else, attracts, follow to their last consequences the dictates of reason even though they drown in the bitterness of their dearest illusions. The others, ever protected by that magic potion called justice, and which some intuition, whence I know not, assures them must exist, deliberately turn their eyes from exterior reality which at every step spoils their dream. To them it is enough that a thing be just in order that it be the truth. Their inner ideals are a superior guide to outside reality.

The first mode serves as a mantle for diverse forms of materialisms, rationalisms, positivism, scientism; the second rules as mistress to various spiritual doctrines of which the most recent and suggestive is pragmatism in its various forms. Contrary to its various predecessors, pragmatism pretends not to ignore science. With varied shades and pretenses, often modified by circumstances, these two tendencies have separated men as far back as we go in history. Nor can it be otherwise in the future. As long as our nature is what it is are we condemned to toss between these two extremes, which are called intelligence and sentiment, reasoning and dreaming, the reality and the ideal. We may sum up all history of the torments of human thought by that name which Goethe gave to one of his most beautiful books, "Wahrheit und Dichtung" (truth and fiction).

The conflict becomes especially bitter and irritating when it no longer takes place between schools of thought but between individuals. Sometimes one sect seems to be supreme. Oftentimes both lose. The love for the ideal and the taste for the real, lost in the bitter contest, leave the soul empty and lifeless. Poincaré's philosophy shows how we may challenge both of these dogmatic extremes. Nor does he do this with arms rusted and stacked in idle repose. He has nothing in common with a vague eclecticism, which, like the costume of Harlequin, made of pieces and bits, tries in vain to conceal with words the wounds received and which no longer survives except in our college educations, those museums of antiquities. He attacks the problem at its very foundation, assigning to each step its definite limitations. He gives us reasons for doubt, but at the same time reasons for action, for loving the beautiful and the true, even though they may not be accessible. May we not love the stars even though we can not touch them?

To a superficial observer scientific truth is beyond the pale of doubt; scientific logic is infallible; if sometimes a scientist is deceived it is because he has overlooked some conditions.

Mathematical truths are derived from a few self-evident axioms by an unimpeachable chain of reasoning. They rule not only over us but over nature herself. They limit in a way even the Creator. He can choose only between a few possible solutions. We need, then, only a few trials to know what choice he made. From every experiment many consequences may follow through a series of mathematical deductions, each one leading into knowledge of some new corner of the universe.

Note the significance of these facts for the good of the people; the importance to those colleges which first discover the physical basis of some scientific truth. But note how they have misunderstood the relation of experiments and mathematics; for hundreds of years philosophers have made worlds of dreams based as little as possible upon facts.

Poincaré first undertook to show the weakness of that creed which refers all phenomena to time, number, and space, and which was left to us by the traditions of the seventeenth and eighteenth centuries. The "mathematical universe," that dream sketched by Descartes and elaborated by the great encyclopædists, expressed the very essence of everything in an absolute, definite geometrical form. According to the Cartesian conception, all the properties of matter are reducible to extension and movement; matter hid nothing further. This ambitious dream was indulged in not only by the people and the colleges, as Poincaré has stated, but even in our days by scientists of considerable repute, notably in the work of the celebrated German naturalist Haeckel, who developed such a system and with naïve arrogance believed he had solved the "riddle of the universe."

There has been quite a little doubt since Kant whether these notions of time and space upon which this metaphysical structure is based, this absolute pragmatism, if I may use that term, are not a little subjective. That at once renders the very foundations of their structure insecure. But it was Poincaré's task to show in a not easily refutable, scientific manner what was to be thought of these fundamental ideas. For that he examined in turn the various sciences based upon geometrical form; first, geometry itself, then mechanics, and finally physics.

Mathematics was first tried. Complete rationalism after having first pursued dogma and the absolute into their ancient fortress, by a strange and somewhat paradoxical turn restored them to mathematics. He believed that mathematics could not be what it seemed. There seemed to be something of fatality, necessity, which could not be got away from about it. When all our ideas melted away it alone remained solid like a rock in the ocean, under cover of the contingencies and the relative.

Now, if with Poincaré we examine the sciences of number and extension, especially the first principles, which are the most frail parts just because of their apparent and undemonstrable truths, we find this: The postulate of Euclid, upon which all geometry is based, states that "through a point we can pass but one line parallel to a given

right line." For centuries the greatest efforts have been made to demonstrate that postulate, and then during the last century the Russian Lobatschewski and the Hungarian Bolyai almost simultaneously showed that such a demonstration is impossible. Yet the Académie des Sciences each year receives a dozen or so pseudo-demonstrations of that postulate.

Lobatschewski did even better: Supposing that several parallel lines can be drawn through a point parallel to a given right line, retaining the other axioms of geometry, he proved a succession of strange theorems, between which it was impossible to find any inconsistency, and built a new geometry, no more unimpeachable logically than the ordinary Euclidean geometry. Then Riemann and yet others came who showed that we could construct as many more geometries as we wished, each perfectly logical and coherent. The theorems of these new geometries are sometimes very odd. For instance, the following one, imagined by Poincaré himself, has been demonstrated: A real right line can be perpendicular to itself.

I imagine that architects and engineers would scarcely admit such deductions, although they are in no way logically contradictory. That brings us to the kernel of our discussion. If, as results from what has preceded, the axioms of geometry are only conventions, or, as Poincaré has expressed them, "definitions in disguise," and if the Euclidean geometry is no more absolutely true than any other, why have men chosen and used it? Because it is better adapted to our needs, to our daily life, to the exterior world in which we live; because in this world its theorems reduce to the simplest possible form the relationships between things. A measurer could express just as accurately by means of a Lobatschewskian geometry the relation between the volume and the sides of a cube of wood. But it happens from the nature of a cube of wood, or rather from the way our senses comprehend it, that those relations would be more complex than with the ordinary Euclidean geometry. It is possible to imagine a world so constructed physically that men having our brains—that is, our kind of logic—would not find Euclidean geometry the simplest.

Geometry, then, is no longer the inner temple of the absolute. It is an arbitrary creation of our intellect. It can inform us only relatively to the corresponding logical developments. However, in a certain sense geometry depends also on experience, since, as we have just seen, the exterior world appears simplest in the Euclidean aspect. That does not mean that geometrical truths can be proved or invalidated by experiment. Our instruments and our senses are imperfect, whereas a geometrical theorem which is not exactly true is false. If we measure with our instruments the sum of the angles of a triangle drawn upon paper, we shall never find them exactly equal to two right angles. Sometimes we will find the sum smaller, by

perhaps a millionth, as much smaller as you please, but nevertheless smaller, which would verify a theorem of the Lobatschewskian geometry, sometimes a little greater but sufficient to conform to a Riemann geometry. Experiment, then, does not show the exclusive truth of Euclidean geometry, which, like the others, is at the bottom an edifice formed by logic. If the Euclidean method is innate to us, it is doubtless because of ancestral experiences, because the brain of man has little by little been adapted to the exterior world by natural selection and because Euclidean geometry has proved to be "the most advantageous to mankind; in other words, the most fit."

If in mathematics deduction is almost all, fact almost nothing, we find the reverse in the observational sciences. Pure deduction can teach us very little about nature except in an indirect way, and then only because our brain has little by little become harmonized to the exterior world with the fewest clashes possible. In that sense, certainly, the study of our intellect teaches us indirectly of the universe itself just as the appearance of a mortal wound indicates to the medical expert the instrument employed and the gesture of the assassin. But that evidence is not only indirect, but it is incomplete, for it tells us nothing of those external conditions not involved in the adaptation of the species. These latter are the more numerous. Accordingly, the discoveries due to the experimental sciences are unlimited, whereas those from pure deduction are doubtless limited. It is better to observe than to reason, and doubtless in that sense Poincaré is to be understood when he wrote in regard to the methods of the physical sciences: "Experience is the sole source of all truth. It alone can teach us new things. It alone can give us certainty."

But, then, should not the theorems of mathematical physics, which are but the synthesis and expression of physical experiences, furnish us with a definitive, although in a way dogmatic, image of the universe such as certain philosophies have promised? We once believed so; but having observed how precarious was the fortune of such theories and how rapidly and repeatedly the most brilliant gave way to others, some have been pleased to call science futile and only a source of error. But Poincaré has shown that physical theories deserve neither such excesses of honor nor of indignity and has brought their blind adorers as well as their systematic detractors to a more sane view.

Observation and experience furnish the physical facts to the physicist. Should he be content merely to accumulate them? No, for "he must coordinate them. Science is built with facts as houses are with stones; but an accumulation of facts is no more a science than a heap of stones a house;" and, further, a physicist must "predict" phenomena. So he generalizes what he has observed, interpolating, connecting by a line the isolated facts; then he pro-

longs that line, extending it into a region not yet observed where the coordinates of his curve indicate to him new phenomena. Then by further experiments he may test these predicted phenomena to see whether or not he has truly predicted. If truly, then his extrapolation was justified and expresses real relationships; if not, then he must try again.

Unless I have been deceived, the picture just sketched indicates just exactly the purpose of mathematical physics and the part it plays both in synthesis and in prediction. The mathematical expressions of physical theory are algebraic translations of the curves such as I have just described and which the physicist mentally draws. The better a physical theory expresses the real relationships between the phenomena, the better will it predict hidden relations verifiable by trial and the more useful it will be, the more fit, the more true.

But the truth of a theory must not be misunderstood. No theory could be more useful than Fresnel's in attributing light to movements of the ether. To-day we prefer that of Maxwell, which supposes light is due to oscillating electric currents. Does that mean that the theory of Fresnel was erroneous? No, for the object of Fresnel was not to prove the existence of the ether or whether or not it is formed of atoms, whether these atoms move this or that way; his object was to predict optical phenomena. For that the theory of Fresnel serves to-day as well as it did before Maxwell. What changes is only the picture by which we represent the objects between which the physicist has discovered and proved relationships. Various reasons make us from time to time change these pictures which otherwise are unimportant. But it is these pictures alone which change; the relationships always remain true provided they rest upon well-observed facts.

It is because of this common foundation upon truth that the most ephemeral theories do not die in every part; but like the torch which the couriers of ancient times passed on from hand to hand, each theory transmits to its successor that which is the only accessible reality, namely, the group of laws which expresses the relationships existing between things. These conclusions reached by Poincaré relative to physics hold as well for the other branches of science, chemistry, the biological sciences, even for those sciences which are yet young and classed as moral or social, since they all branch out from physics, and according to their nature, have for their final object the foundation of their more or less complex laws upon those of physics; accordingly, upon the latter will be based all of our knowledge of the world.

It is clear that the conclusions of Poincaré reduce to its proper value, which is a minimum, a certain common materialism which dreams of attaining the absolute and inclosing it in several differential equations. There is not, there can not, be a metaphysical conception of science.

Those who, in the name of Poincaré, have proclaimed anew the failure of science have not understood him. Otherwise they would have seen that he battered down only a certain interpretation of science made by men who did not know it at all. The attitude of Poincaré has nothing in common with that of the men of the rank and file whose agnosticism ill conceals their ignorance and upon whom he sometimes liked to use his indulgent irony. "It is not enough to doubt indiscriminately; we must know why we doubt."

The fragile nature of scientific theories proves nothing against science; they are only show cases, shop windows, frames wherein we arrange more or less conveniently our treasures. It is just the same as when for our world's fairs we gather together all the most marvelous products of our industries in ephemeral palaces built of mill boards but of the most brilliant designs; and then because the wind and the rain demolish these structures of boards, if we try to keep them too long, or because we demolish them ourselves to build again others yet differently to expose anew our products, who would dare to say that our human industries had failed? But that is just the way these men reason, who, may I so call them, are the perpetual assignees of the failure of science. Is it not just as a blind man would reason if it occurred to him to disparage the light of the stars?

But, side by side of these simple and ingenuous detractors, there has recently arisen a new class which criticizes and diminishes the value of science; they uphold a body of doctrine due to a very intelligent, educated, subtle set of men who belong more or less to the new school of pragmatic philosophy. They pretend to draw arguments from the ideas of Poincaré. What would he think of them?

What gives pragmatism its absorbing interest is that while not ignoring science, arguing indeed from its results, it appeals to other criteria than reason. But this is not the time to examine these doctrines. In order to know what Poincaré himself thought of them let us ask him. There at once arises an essential antinomy. The aim of pragmatism, whence its name, is action, practical service, and if science has a value it is as a means of action and because it furnishes us with practical and useful rules. To Poincaré, on the other hand, it is knowledge which is the end of action. If he was glad of industrial development, it was not only because it furnished a ready argument to the defenders of science, but also because, by freeing men more and more from material cares, it would some day give to all the leisure to work for science.

This point of view is not only full of nobleness and beauty, it is indeed richer in useful consequences than utilitarian pragmatism itself. For a century and a half the pragmatists as well as the positivists (how can we refrain from wondering at the strange bond which unites two such different schools?) looked upon the discoveries

which Galvanus and Volta made upon the frogs as perfectly idle and useless. These men of science with a wholly disinterested curiosity ardently pursued their researches. It is from these little experiments, more or less than a plaything for the idle hours, that all our electrical industries with their innumerable practical consequences have sprung.

To many pragmatists science is only a nominal thing; the scientist creates the fact through experiment; then he denatures the rough facts, transforming them into "scientific facts." Poincaré replies, showing that "all a scientist creates in the fact is the language by which he expresses it." If some day we find that the statement of a physical law is incomplete or ambiguous, we have merely to change the language by which it was expressed. Because the language by which each one expresses the deeds of daily life is not free from ambiguity, should we conclude that these happenings of daily life are only the work of grammarians?

Finally, and this is the culminating point, the pragmatists consider science an artificial creation, contingent, uncertain, and teaching us nothing of objective reality. Has not Poincaré shown, indeed, that the mathematical sciences are contingent and that physical theories express only the relations between things and not the objects themselves? But here Poincaré calls, "Halt, there!" He shows that the only objective reality is precisely these relations between things.

The first condition of the objectivity to us of exterior objects is that they are common to other thinking beings, which fact we may know by comparing their impressions with our own. Perhaps, in my opinion, Poincaré goes a little too far when he affirms that this guarantees the existence of the exterior world, that this suffices to distinguish the real from a dream. We could, indeed, imagine our whole life a dream, with beings similar to ourselves telling us of sensations analogous to our own in regard to objects, so that the fiction of our dream seemed outside of ourselves. But this is not the place to discuss the reality of the exterior world, since its existence is postulated both in the scientific and in the opposing theories. The existence of what we call the external world being placed beyond doubt both by the scientists and by the pragmatists, it results clearly from what has just been said that since it is through "discourse," language, that men exchange sensations, there is no objectivity without "discourse." Discourse which, according to certain nominalists creates nonexistent facts and is a veil before objectivity, becomes, on the contrary, its necessary condition. But, on the other hand, "the sensations of others are for us an eternally closed world." I shall never know whether the color sensation produced upon me by a bluet and by the first and third stripes of the French flag are the same as yours. All that I know is that, with you as with me, the bluet and these stripes produce a similar sensation which we call

blue, or otherwise, and that the third stripe, with you as with me, produces a different sensation from the first. Thus what is "pure quality" in sensations is nontransmissible and impenetrable. Only the relations between the sensations are transmissible, and consequently may have an objective value. And that is why science, which furnishes us with the relations existing between phenomena, tells us of all that is purely objective.

The profound and subtle criticism which Poincaré has made of scientific theories leads us in no way to agnostic conclusions. Those who have tried to use it to contest the value of science have reasoned wrongly.

[Here follows in the original French, Section V, discussing Poincaré and the moral problem, which is necessarily omitted from the present translation on account of the length of the entire paper.]

VI. CONCLUSION.

A great inventor, a great philosopher, Poincaré was also a great writer. If it were for literary merit alone he would deserve study. His language was vigorous and vivid, with a conciseness and clearness peculiarly French. He did not disdain to clothe any profound thought in the garb of a pretty phrase wherein he grouped himself with the encyclopedists who, like d'Alembert, believed a precious liquor yet finer when served in a finely cut glass.

The last century has produced experimenters of genius like Pasteur—men of astonishing intuition like Maxwell. It has not produced men who have done as much as Poincaré for the progress of the purely deductive sciences and for mathematical discipline, or who like him could "think science" and place it exactly. The picture which he has left us is at the same time sad and encouraging. Science has its limits. It can know only the relative, but in that it is supreme. As to wishing to penetrate into what is called the absolute—the "things in themselves"—these questions are not only insoluble but illusory and void of sense. Science is an asymptote to the total truth as is the hyperbola an asymptote to its directrices, and further, like the hyperbola, it extends without end.

In the somber forest of mystery, learning is like a glade. Men enlarge continuously the circle which borders the clearing. But at the same time it continuously touches the shades of the unknown at a greater number of points. No one on the borders of this glade has known how to gather newer and more magnificent flowers than has Henri Poincaré. So, as long as there are men who think that it is noble to live at the summit where harsh truth is enthroned, his Loraine name will tremble on their lips.

If I may paraphrase a famous saying, he was one of the essential elements of human thought.



INDEX.

A.

	Page.
Abbot, C. G.	xii, 12, 17, 105, 128, 138
on Astrophysical Observatory.....	82-88
(the radiation of the sun)	153
Abbott, Dr. W. L.	10, 125
Absorption of radiation by water vapor.....	86
Abyssinia.....	8, 9
Accessions to Bureau American Ethnology.....	56
Library.....	98
National Museum.....	8, 9, 10, 11, 23, 33
Zoological Park.....	71, 76, 77
Adams, W. I. (accountant and disbursing agent).....	xi, 17
Adaptation and inheritance in the light of modern experimental investigation (Kammerer).....	421
Advisory committee on printing and publication.....	109
Aerial breakers.....	266
cascades.....	261
cataracts.....	260
fountains.....	258
torrents.....	265
Aero Club of Washington.....	118
Aerodynamics.....	278
African expeditions	8, 9, 33, 121, 122, 124, 125
Agriculture, Department of.....	9, 27, 125
Secretary of (member of the Institution).....	xi, 121
Air currents, horizontal.....	267, 268
vertical.....	267
holes.....	257
Aldrich, L. B.	82, 126, 164
Algeria, Smithsonian astrophysical observations in.....	12, 86, 126, 153, 164
Alpine Club of Canada.....	11
Altai Mountains, expedition to.....	10, 125
Altamira, Rafael.....	109
Alvord, C. W.	109
American Archæology, School of.....	37, 39
American Ethnology, Bureau of.....	xii, 1, 6, 37, 114
publications of.....	14, 17, 18
American Historical Association.....	17, 18, 108
American Historical exhibits and accessions.....	33
American Indians and Siberian natives.....	11, 12
American Revolution, Daughters of the.....	17, 109
Americanists, Congress of.....	21
Amundsen, Roald (expedition to the South Pole).....	701

	Page.
Angell, James B. (Regent).....	2, 123
Ångström, Anders Knutson.....	12, 86, 87, 164
Animals, European domestic.....	483
in National Zoological Park.....	71, 77
Antarctic explorations.....	701
Antarctic Ocean, lands and life of the.....	443
Antarctic penguins.....	475
Antarctica, paleogeography of.....	443
Anthropological researches in Siberia and Mongolia.....	11
Anthropology, antiquity of man in Europe.....	12
blond Europeans.....	609
evolution of man.....	553
Hohokam, the.....	383
music of primitive peoples.....	679
prehistoric.....	22
slaves of ancient Greece.....	597
Ants and their guests (Wasmann).....	455
Applied chemistry.....	231
geology (Brooks).....	329
mechanics.....	269
Appropriations, Congressional.....	114
Archeological Congress.....	21
Armstrong, H. E. (The origin of life: a chemist's fantasy).....	527
Arrhénius, the hypothesis of.....	543
Art and industry exhibits in National Museum.....	31, 32
National Gallery of.....	34, 35
room, Smithsonian.....	94
textiles.....	35
Aryan hypothesis.....	609
Assistant Secretaries of the Institution.....	xi
Astronomy, life of worlds.....	543
spiral nebulae.....	143
the year's progress in (Puisseux).....	135
Astrophysical Observatory,.....	xii, 1, 6, 18, 28, 114, 153
expeditions of.....	12, 86, 127, 164
personnel of.....	87
publications of.....	14, 18, 108
report on.....	82-88
Astrophysics, standards of pyrheliometry.....	86
radiations of the sun.....	153
variability of the sun.....	82
Attorney General (member of the Institution).....	xi
Audubon, John James.....	106
Avery, Robert S. (bequest of).....	6, 111, 112, 118
Aviation, dangerous currents and winds in.....	257, 267.

B.

Bacon, Senator Augustus O. (Regent).....	xi, 2, 114, 115, 116, 122
Baker, A. B.....	xii, 104
Baker, Dr. Frank.....	xii, 17
report on Zoological Park.....	71-81
Baker, T. Thorne.....	105

	Page.
Balfour, Henry.....	106
Ballou, Prof. Howard M.....	53
Barnes, Prof. Howard T. (icebergs and their location in navigation).....	717
Bassler, Ray S.....	xii, 107
Bassour, Algeria, observations at.....	82-87, 126, 164
Becquerel, Jean.....	105
Beebe, C. William.....	105
Beetham, Bentley.....	106
Belck, W.....	106
Bell, Dr. Alexander Graham (Regent).....	xi, 2, 114, 115, 122, 123
Benjamin, Dr. Marcus.....	xii, 107
Bent, A. C.....	103
Berget, Alphonse (the appearance of life on worlds and the hypothesis of Arrhé- nius).....	543
Beryls in Madagascar.....	371
Beyer, David S.....	105
Biblical geography, Sinai.....	669
Biochemistry.....	493, 527
Biography of Poincaré.....	741
Biological exhibits and accessions.....	33
Biological Survey of Department of Agriculture.....	27
of the Canadian Rockies.....	11
of the Panama Canal Zone.....	9-10, 16, 121, 124
Biology of life.....	493, 527
Birds in National Zoological Park.....	73-75, 77
of the Antarctic regions.....	475
Bloch, Dr. Adolphe (origin and evolution of the blond Europeans).....	609
Blond Europeans.....	609
Boas, Dr. Franz.....	xii, 51, 52
Boerschmann, Ernst.....	107
Bolometer.....	154, 156
Borel, Émile (molecular theories and mathematics).....	167
Borneo expedition.....	10, 125
Bosler, J.....	105
Bowman, Jacob N.....	109
Boys, C. V. (experiments with soap bubbles).....	211
Brackett, Prof. Frank P.....	82, 87, 126, 164
Bradley, Linn.....	5
Brain, effect of experiences on the.....	558
Branner, J. C.....	106
Brett, Lieut. Col. L. M.....	71
Bretz, Julian P.....	109
British Columbia, fossils from.....	7
British East Africa.....	8, 9
Brooks, Alfred H. (applied geology).....	329
Brown, S. C.....	xii
Bubbles, soap.....	211
Buchanan, Florence.....	105
Buenos Aires, zoological gardens at.....	71
Burrows, Montrose T.....	105
Busck, August.....	103
Bushnell, D. I., jr.....	53

	Page.
Cambrian geology and paleontology.....	7, 16
Campbell, Prof. W. W.....	105, 137
Canadian Rockies, biological survey of.....	8, 11
Canal Zone. (<i>See</i> Panama Canal Zone.)	
Capillarity of soap bubbles.....	211
Carrel, Dr. Alexis.....	105, 413
Celestial bodies, study of.....	135, 143
Cells, life of.....	413
Celluloid, manufacture of.....	253
Chamberlin, Thomas Chowder.....	105
Chancellor of the Institution.....	xi, 1, 2, 115, 122
Chanute, Octave.....	105
Charcot expedition.....	475
Chemical industry, the latest achievements and problems of the (Duisberg)...	231
Chemistry, Congress of Applied.....	22
Chemistry of life.....	493, 527
Chemist's view of life.....	527
Chief Justice of the United States (member of the Institution and Regent)....	xi, 1, 2, 115, 122
China, finger-print system in.....	634
Choate, Charles F., jr. (Regent).....	xi, 2, 115, 116, 117
Christ, Dr. H.....	102
Cities, ancient.....	653
nineteenth century.....	659
of Middle Ages.....	656
study of.....	653
Civilization in North America.....	397
Clark, A. Howard (editor).....	xi, xii, 17, 109
report on publications.....	102
Clark, Chester M.....	105
Clarke, Prof. F. W.....	xii, 22
Clerget, Pierre (urbanism; a historic, geographic, and economic study).....	653
Climate of North America, the fluctuating (Huntington).....	383
Cole, Allan S.....	104
Colenbrander, H. T.....	109
Coloring, chemical.....	245
Commerce and Labor, Department of.....	9, 125
Secretary of (member of the Institution).....	xi, 121
Congresses and celebrations, international.....	21, 22
Contributions to knowledge.....	14, 102
Costumes, period, National Museum.....	35
Cottrell, Prof. F. G.....	3, 4, 116, 117, 118
patents.....	3, 4, 5, 116, 123
Courmont, Jules.....	106
Coville, F. V.....	xii
Crawford, J. C.....	97
Cullom, Senator Shelby M. (Regent).....	xi, 2, 115
"Culture" of living tissues.....	413
Curators of National Museum.....	xii
Currier, Rev. Charles W.....	21
Curtis, Heber D.....	105

D.

	Page.
Dall, Dr. William Healy.....	xii, 97, 103, 104
Dalzell, Representative John (Regent).....	xi, 2, 114, 115
Daughters of the American Revolution.....	17, 109
Day, Arthur L. (geophysical research).....	359
Demography, Congress of Hygiene and.....	22
Densmore, Frances.....	52
Deslandres, Dr. H.....	105
Disbursements, Congressional.....	6, 114
Smithsonian Institution.....	112
Distribution of Government publications under the Smithsonian.....	55, 58-66, 129
Dixon, Henry H.....	105
Doncaster, Leonard.....	105
Dorsey, Harry W. (chief clerk).....	xi
Dorsey, James Owen.....	54, 108
Duerden, J. E.....	105
Duisberg, Prof. Dr. Carl (the latest achievements and problems of the chemical industry).....	231
du Pont, Gen. T. Coleman.....	5
Dusseldorf mechanical congress.....	280

E.

Earth, history of the.....	359
nocturnal radiations of the.....	12
Economic geology.....	329
mineralogy.....	371
Economics, Urbanism.....	653
Editor of the Smithsonian.....	xi, xii, 17, 109
report of the.....	102-110
Electrical precipitation of dust, smoke, etc.....	3, 116, 123
El Morro, Inscription Rock.....	38
Engines, gas and petroleum.....	272
Enlart, Camille.....	109
Entomology, ants and their guests.....	455
Establishment, the Smithsonian.....	xii, 1
Ether and matter, the connection between the (Poincaré).....	199
Ethnography, Grecian slaves.....	597
Ethnology, Bureau of American.....	xii, 1, 6, 25, 33, 54, 56, 108, 114
collections.....	56
library.....	19, 97
publications.....	14, 17
report of.....	37-57
Europe, antiquity of man in.....	12
European domestic animals, the derivation of the (Keller).....	483
music.....	679
Europeans, origin and evolution of the blond (Bloch).....	609
Evans, William T.....	3, 24, 34
Evermann, Dr. B. W.....	xii
Evolution of blond Europeans.....	609
man, the (Smith).....	553
Exchanges, Bureau of International.....	xii, 1, 6, 18, 25, 112, 114
of National Zoological Park.....	71, 77
Executive committee, Board of Regents, report of.....	111

	Page.
Expedition to the South Pole (Amundsen).....	701
Expeditions, Smithsonian.....	8, 9, 10, 33, 122, 124, 125
Exploration expenses.....	112
Explorations and researches.....	6, 16

F.

Fairbanks, Hon. Charles W. (Regent).....	xi, 2
Ferris, Representative Scott (Regent).....	xi, 2, 115, 122
Fewkes, Dr. J. Walter.....	xii, 39, 40, 41, 42, 105
Films, manufacture of.....	252
Finances of Institution.....	5, 18, 111, 112
Finger-print system, history of the (Laufer).....	631
Fisher, Walter L., Secretary of the Interior.....	xi
Fisheries, Bureau of.....	23, 33, 71
Flack, Dr. Martin.....	13, 107
Flanagan, John, sculptor.....	19, 119
Fletcher, Alice C.....	21, 54, 108
Flexner, Dr. Simon.....	16, 20, 104, 122
Flint, Dr. J. M., United States Navy (retired).....	xii
Flora and fauna of the Antarctic.....	443
Ford, Guy Stanton.....	109
Foreign agencies cooperating with Exchange Bureau.....	67-68
consignments of exchanges.....	61-63
depositories of Government documents.....	64-66
Fossil plants.....	353
Fossils from British Columbia.....	7
Fowle, F. E., jr.....	xii, 86, 87, 88
Freeman, Allen W.....	106
Freer, Charles L.....	24, 34, 126
collection.....	126
Frick, Childs.....	9, 122, 125
expedition.....	9, 122, 125
Frisby, F. E.....	87
Frothingham, Prof. Arthur L.....	21
Fuller, Chief Justice.....	120

G.

Gain, L. (the penguins of the Antarctic regions).....	475
Garrison, Prof. George P.....	108
Gas and petroleum engines.....	272
Geare, Randolph I.....	xii
Gems, precious.....	371
Geographical relations of Antarctica, the paleo-.....	443
Geography, Mount Sinai.....	669
physical.....	359
South Pole.....	701
Geological and mineralogical collections.....	34
history of Great Lakes.....	292
Geological Survey, United States.....	329, 353
Geology, applied.....	329
Cambrian, and paleontology.....	7, 16
economic.....	329

	Page.
Geology and paleobotany, relations of.....	353
Geophysical research (Day).....	359
George Washington Memorial Building.....	22
Association	22, 23
Gifts to Zoological Park.....	76, 77
Gill, De Lancey.....	xii, 55
Gill, Dr. Theodore N.....	21, 96
Glacial and postglacial lakes of the Great Lakes region, the (Taylor).....	291
Goebel, Julius.....	109
Goetze, Dean Frederick A.....	5
Goldman, E. A.....	103
Goldsmith, J. S.....	xii
Gordon, Dr. G. B.....	21
Government documents, distribution of.....	55, 58, 66, 129
Grand Ile, Madagascar.....	371
Graphic arts and bookmaking, exhibits in.....	32
Graves, Henry S.....	105
Gray, Hon. George (Regent).....	xi, 2, 116, 122
Great Lakes.....	291
Greece and its slave population, ancient (Zaborowski).....	597
Griffin, Grace G.....	109
Gunnell, Leonard C. (Assistant in charge of International Catalogue of Scientific Literature).....	xii, 99-101
Gurley, Joseph G.....	xii, 54

H.

Habel, Simeon.....	5, 111
Hague, Dr. Arnold.....	22
Hale, Dr. George E.....	21, 122
Hamilton, James.....	5, 20, 111, 122
Lectures.....	16, 20, 104, 122
Harriman, Mrs. Edward H.....	124
Harriman trust fund.....	2, 124
Haupt, Dr. Paul.....	22
Hay, Dr. O. P.....	97
Heaton, Noel.....	106
Hedley, Charles (the paleogeographical relations of Antarctica).....	443
Hele-Shaw, H. S.....	107
Heller, Edmund.....	8, 33, 104, 121, 122, 125
Henderson, Hon. John B.....	115, 119, 120
Henderson, John B., jr. (Regent).....	xi, 2, 115
Henry, Joseph (Secretary).....	89, 91
Henshaw, Henry W.....	105
Hess, Frank L., and Eva.....	104
Hewett, Dr. Edgar L.....	21, 39
Hewitt, J. N. B.....	xii, 48, 57
Hill, Dr. Leonard.....	13, 107
Historical and patriotic societies, reports of.....	17, 18
Hitchcock, Frank H., Postmaster General.....	xi
Hodder, Frank Heywood.....	109
Hodge, F. W. (Ethnologist in charge of the Bureau of American Ethnology). report on Bureau of Ethnology.....	xii, 17, 21, 25, 37, 39, 56 37-57

	Page.
Hodgkins, Thomas G., bequest of.....	5, 111, 112
Fund	5, 12, 13, 82, 111, 118
Hohokam, ancient people of America.....	383
Holes in the air (Humphreys).....	257
Hollister, Ned.....	103, 126
Holmes, William H.....	xii, 21, 22, 52, 53
Hooker, President Elon Huntington	5
Hopkins, Prof. E. Washburn	22
Hough, Dr. Walter.....	xii
Hounds for lion hunting.....	8
Howard, Dr. L. O.....	xii
Howard, Hon. William M. (Regent).....	2, 115
Hrdlička, Dr. Aleš.....	xii, 11, 12, 16, 21, 22, 103
Human speech.....	573
Humphreys, Dr. W. J. (holes in the air).....	257
Huntington, Ellsworth (the fluctuating climate of North America).....	383
Hygiene and Demography, Congress of.....	22

I.

Icebergs and their location in navigation (Barnes).....	717
Indian memorial building	127, 128
Indians, American (<i>see also</i> Ethnology).	
researches among.....	37-57
and Siberian natives.....	11, 12
Infection and recovery from infection.....	20
Infinitesimal quantities of substances, measurements of (Ramsay).....	219
Inheritance, adaptation and.....	421
Inorganic chemical substances.....	238
Institution, members of the Smithsonian	xi
Institutions and individuals, consignees of exchanges	69-70
Interior, Secretary of the (member of the Institution).....	xi, 127, 128
International Archeological Congress at Rome.....	21
International Catalogue of Scientific Literature.....	xii, 1, 6, 18, 28, 114
report on.....	99-101
Commission on Zoological Nomenclature	16
Congress of Applied Chemistry, New York.....	231
congresses and celebrations.....	21, 22
Exchanges.....	xii, 1, 6, 18, 25, 114
report on.....	58-70
Seismological Association.....	101

J.

Jackson, Prof. A. V. W.....	22
James, Mrs. Julian.....	35
Jastrow, Prof. Morris, jr.....	22
Jennings, Hennen.....	5
Jewett, Prof. Charles C.....	89
Joly, J.....	106
Jordan, Edwin O.....	107

K.		Page.
Kalm, Pehr.....		106
Kammerer, Paul (adaptation and inheritance in the light of modern experimental investigation).....		421
Keller, Prof. Dr. C. (the derivation of the European domestic animals).....		483
Keyes, Charles R.....		106
Kharga Oasis, natives of the.....		16
Kirchhoff, Charles.....		5
Knowlton, Dr. F. H. (the relations of paleobotany to geology).....		353
Knox, Philander C., Secretary of State.....		xi
Koch, Robert.....		106
L.		
Labor. (<i>See</i> Commerce and Labor.)		
Laces in the National Museum.....		35
Lacroix, A. (a trip to Madagascar, the country of beryls).....		371
La Flesche, Francis.....	xii, 49, 51, 54, 56,	108
Lakes, Great, glacial and postglacial.....		291
Lake Erie.....		291
Huron.....		291
Michigan.....		291
Ontario.....		291
Superior.....		291
Lallemand, Ch.....		106
Langley, Samuel Pierpont.....	19, 102, 153, 154	
Memoir.....		14
Memorial Tablet.....	19, 119	
Monument Fund.....		118
Lauffer, Berthold (history of the finger-print system).....		631
Laurentian Lakes, great.....		291
Lawrence, Benjamin B.....		5
Leary, Ella.....		55
Lecornu, L. (review of applied mechanics).....		269
Legendre, A. F.....		107
Legendre, R.....		107
Legendre, R. (the survival of organs and the "culture" of living tissues)....		413
Leland, Waldo G.....		109
Lett, R. C. W.....		8
Library of Congress.....		19
Library of the Institution.....	19, 89-98, 112	
Libraries under the Smithsonian.....	36, 55-56, 95, 97, 98	
Life: its nature, origin, and maintenance (Schäfer).....		493
the origin of, a chemist's fantasy (Armstrong).....		527
on worlds and the hypothesis of Arrhénius, the appearance of (Berget)....		543
Lincoln Memorial models.....		24, 32
Lion hunting with hounds.....		8
Lissauer, A.....		107
Little, Arthur D.....		5
Living tissues, "culture" of (Legendre).....		413
Lodge, Senator Henry Cabot (Regent).....	xi, 2, 115, 119	
London Hospital Medical College.....		13
Lyman, Dr. Theodore.....	10, 125, 126	
Lyon, J. D.....		118

	Page.
MacCurdy, Dr. George Grant.....	21, 22
McDermott, F. Alex.....	106
Macnamara, N. C.....	106
MacVeagh, Franklin, Secretary of the Treasury.....	xi
Macie, James Lewis.....	130
Madagascar, the country of beryls, a trip to (Lacroix).....	371
Malloch, J. R.....	104
Mallock, A.....	106
Mammals, differentiation of.....	559
in National Zoological Park.....	72-73, 77
Man, evolution of.....	553
origin of.....	565
pedigree of.....	553
Manly, Charles M.....	15, 102
Mann, Representative James R. (Regent).....	2, 115
Marchand, H.....	106
Marconi, G.....	106
Market sheds.....	127
Mathematical research, modern (Miller).....	187
Mathematics and molecular theories.....	167
Matter and ether.....	199
Maxon, William R.....	97, 102, 103, 106, 108
Mayer, Alfred Goldsborough.....	105
Meadows, Thomas C.....	5
Meany, Edward S.....	109
Mearns, Dr. Edgar A.....	9, 97, 102, 122
Mechanical appliances.....	281
engineering.....	269
flight, Langley memoir on.....	14, 15
Mechanics, review of applied (Lecornu).....	269
Memorial tablet, Langley.....	19
Merriam, Dr. C. Hart.....	124
Merrill, Dr. George P.....	xii, 117
Metallurgy.....	235
Meteorological physics.....	257
Meyer, George von L., Secretary of the Navy.....	xi
Michelson, Dr. Truman.....	xii, 47, 48
Miller, Prof. G. A. (modern mathematical research).....	187
Miller, Gerrit S., jr.....	xii, 104
Millet, Francis D.....	24, 97
Millikan, R. A.....	105
Mineralogy of Madagascar.....	371
Mind, effect of experiences on the.....	553
Mines, Bureau of.....	3, 4
Miscellaneous Collections, Smithsonian.....	14, 16, 102
Molecular theories and mathematics (Borel).....	167
Molecular physics.....	167, 211, 219
Moller, Erwin.....	4
Mongolian explorations.....	11
Moon, Karl.....	51
Mooney, James.....	xii, 42, 43, 56
Morgulis, Dr. Sergius.....	13

	Page.
Mount Robson region, explorations in.....	8, 11
Mount Sinai, location of.....	669
Mount Whitney.....	82, 83, 87, 126, 158, 159
Mount Wilson.....	82-87, 126, 156, 158, 159, 164
Munroe, Prof. Charles E.....	105
Munroe, Helen.....	55
Music of primitive peoples and the beginnings of European music, the (Pastor)..	679

N.

Nagel, Charles, Secretary of Commerce and Labor.....	xi
Naples Zoological Station.....	13
Nathorst, A. G.....	106
National Gallery of Art.....	xii, 3, 24, 34, 112
National Museum.....	xii, 1, 2, 6, 7, 8, 10, 18, 19, 23-35, 114, 126, 127
publications of.....	14, 17, 18, 25
report on.....	30-36
staff of.....	xii
National Zoological Park.....	xii, 1, 18, 27, 104, 114
report on.....	71-81
Natural-history exhibits in National Museum.....	31
Natural Sciences of Philadelphia, Academy of.....	21
Navigation among icebergs.....	717
Navy, Secretary of the (member of the Institution).....	xi
Nebulae, the spiral (Puisseux).....	143
Nelson, E. W.....	102, 103
New York Zoological Park.....	71
Newell, F. H.....	105
Niederle, Lubor.....	105
Nordmann, Charles (Henri Poincaré: his scientific work; his philosophy).....	741
North America, climate of.....	383
North American aborigines, Hohokam.....	383
Nusbaum, Jesse L.....	38

O.

Oberhummer, Dr. E. (the Sinai problem).....	669
Oceanography.....	543
Olmstead, Albert T.....	109
Organic chemistry.....	242, 244
Organs, animal.....	413
Orientalists, Congress of.....	22
Origin of blond Europeans.....	609
man.....	565

P.

Packages forwarded by exchanges.....	59
Paintings, historical.....	35
Paleobotany to geology, the relations of (Knowlton).....	353
Paleogeographical relations of Antarctica, the (Hedley).....	443
Paleontology, Cambrian geology and.....	7
Paleobotany.....	353
Panama-California Exposition.....	11

	Page.
Panama Canal Zone, biological survey of.....	9-10, 16, 121, 124
Panama, Republic of.....	10
Panama Steamship & Ry. Co.....	125
Pastor, Willy (the music of primitive peoples and the beginnings of European music).....	679
Patents for electrical precipitation of dust, smoke, etc.....	3
Payne, Dr. Fernandus.....	13
Peabody, Dr. Charles.....	21, 22
Peale, Dr. A. C.....	97
Pease, T. C.....	109
Penguins of the Antarctic regions, the (Gain).....	475
Pepper, Representative Irvin S. (Regent).....	xi, 2, 115, 122
Perfumes, manufacture of.....	252
Perret, Frank A. (report on the recent eruption of the volcano Stromboli).....	285
Perry memorial models.....	24, 32
Philadelphia Academy of Natural Sciences.....	21
Phillippot, M.....	106
Physical geography.....	359
Physics, ether and matter.....	211
molecular.....	199
theories and mathematics.....	167
Physiology of life.....	493, 527
Pinchot, Mrs. J. W.....	35
Pine, John B.....	5
Pittier, Henry.....	108
Plant Industry, Bureau of.....	33
Plants, fossil.....	353
Plaskett, J. S.....	106
Poincaré, Henri: his scientific work; his philosophy (Nordmann).....	741
(the connection between the ether and matter).....	199
Pokorny, Julius.....	105
Poore, George W., bequest of.....	117, 118
Population of ancient Greece, slave.....	597
Porritt, Edward.....	109
Postmaster General (member of the Institution).....	xi
Pozzi, S.....	106
Prain, Lieut. Col. D.....	107
Precious stones, beryls.....	371
Prehistoric anthropology.....	22
President of the United States (member of the Institution).....	xi, 1
Primitive peoples, music of.....	679
Printing, allotments for.....	17, 18
Printing and publication, advisory committee on.....	17, 109
Prothero, George W.....	109
Public Printer.....	18
Publications, American Historical Association.....	108
Daughters of the American Revolution.....	109
Publications of the Institution and its branches.....	14-18,
25, 54-55, 99, 101, 102-110, 112, 118, 129	
Puiseux, P. (the spiral nebulæ).....	143
(the year's progress in astronomy).....	135
Pumpelly expedition.....	383

	Page.
Putnam, Ruth.....	109
Pyrheliometer.....	12, 86, 88, 157, 158
Pyrheliometric standards.....	86

R.

Radiation of the sun, the (Abbot).....	153
Radin, Dr. Paul.....	51
Railroads, locomotives.....	275
Rainey, Paul J.....	8, 9, 33, 121, 122, 125
Ramsay, Sir William.....	106
(measurements of infinitesimal quantities of substances).....	219
Rathbun, Mary J.....	104
Rathbun, Richard (Assistant Secretary in charge of National Museum).....	xi, xii, 2, 21
report of.....	30-36
Raven, Harry C.....	125
Ravenel, W. de C. (administrative assistant).....	xii
Red Men of the United States, Order of.....	127
Regents, Board of.....	xi, 1, 2, 3
proceedings of.....	115
report of executive committee of the.....	111
portraits of.....	130
Regents' room.....	130
Reptiles in Zoological Park.....	75, 77
Research associateship.....	124
Corporation.....	3, 4
Researches among American Indians.....	37-57
explorations and.....	6, 16
in American ethnology.....	37
Rice Institute, address at the inauguration of the.....	167
Richards, Joseph W.....	106
Richards, Theodore William.....	106
Richardson, Charles Howard, jr.....	104
Richmond, C. W.....	97
Ridgway, Robert.....	xii, 97, 107
Right-handedness.....	570
Rose, Dr. J. N.....	xii, 108
Roosevelt, Col. Theodore.....	8, 9, 121, 122, 124
Roubaud, E.....	105
Rowher, S. A.....	104
Rubber, manufacturing.....	253

S.

Safford, William Edwin.....	105
Sapir, Dr. Edward (the history and varieties of human speech).....	573
San Diego Exposition.....	11
Saville, Prof. Marshall H.....	21
Schäfer, E. A. (life: its nature, origin, and maintenance).....	493
Scientific Literature, International Catalogue of.....	xii, 1, 6, 18, 28, 99-101, 114
Scott, Lloyd N.....	5
Secretary of the Smithsonian Institution.....	xi, xii, 5, 7, 21, 102, 118, 153
report of.....	xii, 1-130
Shepherd, William R.....	109

	Page.
Sheppard, Hon. Morris.....	128
Sherman, James S., Vice President of the United States.....	xi, 1, 2, 115, 122
Shoemaker, C. W.....	xii
Siberian Expedition.....	10, 11, 125
natives and American Indians.....	11, 12
Siesmological Association, International.....	101
Silk, manufacture of.....	252
Sinai problem, the (Oberhammer).....	669
Sinaitic peninsula, the.....	669
Slaves of ancient Greece.....	597
Smillie, T. W.....	xii
Smith, Prof. G. Elliot (the evolution of man).....	553
Smithson, James.....	130, 153
bequest of.....	5, 111
Smithson relics.....	130
Smithsonian African expeditions.....	8, 9, 33, 121, 122, 124, 125
Algerian expedition.....	12, 86, 126, 153, 164
art room.....	94
establishment.....	1
funds of the.....	111
library accessions.....	19, 93, 96, 97
exchanges.....	93
history of.....	89-92
reading rooms.....	94
publications.....	14-18, 54, 99, 101, 102, 110, 112, 118, 129
research associateship.....	124
report of Secretary.....	xii, 1-130
Siberian expedition.....	10, 11, 125
table at Naples.....	13
Soap bubbles, experiments with (Boys).....	211
Solar constant, the.....	28, 82-84, 87
radiation.....	153, 154
South Pole, expedition to the (Amundsen).....	701
lands of the.....	443
Speech, origin of.....	571
the history and varieties of human (Sapir).....	573
Springer, E. L.....	55
Springer, Frank.....	23, 34
Squier, Dr. George O.....	106
Standley, Paul C.....	103, 106, 108
Stars, study of.....	135, 143
State Department.....	9, 21, 22, 285
Secretary of (member of the Institution).....	xi
Steam apparatus.....	269
Stejneger, Dr. Leonhard.....	xii, 17, 21
Stenhouse, Walter A.....	55
Stevenson, Matilda Coxo.....	xii, 44-47
Stiles, Dr. Ch. Wardell.....	16
Stillwell, Margaret Bingham.....	53
Stimson, Henry L., Secretary of War.....	xi
Stone, Charles A.....	5
Storrow, James J.....	5
Stromboli volcano.....	285

	Page.
Sun, radiation of.....	28, 82, 87, 153
Sunday opening of the National Museum.....	32, 36, 120
Superintendent of Public Documents.....	18, 129
Surgical grafting.....	413
Swanton, Dr. John R.....	xii, 43, 54, 56, 108
Swedish-American Republican League of Illinois.....	35

T.

Taft, William H., President of the United States.....	xi
Taylor, Frank B. (the glacial and postglacial lakes of the Great Lakes region).....	291
Textiles, art.....	35
Thompson, D'Arcy Wentworth.....	106
Thomson, Prof. Elihu.....	5
Tissues, life of.....	413
Tozzer, Alfred M.....	106
Transplantation of organs.....	413
Treasurer of the United States.....	113
Treasury, Secretary of the (member of the Institution).....	xi
Trees and the climate.....	405
True, Dr. Frederick W. (Assistant Secretary in charge of Library and Exchanges).....	xi, xii, 17, 21, 103
reports of.....	58-70, 89-98
Truman, Dr. J. W.....	7

U.

Urbanism: A historic, geographic, and economic study (Clerget).....	653
---	-----

V.

Vaughan, J. H.....	109
Vice President of the United States (member of the Institution and Regent).....	xi, 1, 2, 115, 122
Viereck, H. L.....	103
Visitors in the Smithsonian buildings.....	36
Visitors in Zoological Park.....	77
Volcano Stromboli, report on the recent great eruption of the (Perret).....	285

W.

Walcott, Dr. Charles D. (Secretary of the Institution). xi, xii, 5, 7, 21, 102, 103, 104, 153	report of, Secretary..... xii, 1-130
Walther, Henry.....	55
War Department.....	9, 125
War, Secretary of (member of the Institution).....	xi
Washington Academy of Sciences.....	24
Washington, George, Memorial Building.....	22
Wasmann, P. E. (the ants and their guests).....	455
West Shore Railroad bonds.....	5, 6, 111, 112
Weymouth, Frank Walter.....	104
Wheeler, Dr. A. O.....	11
Whichner, Prof. George M.....	21
White, Dr. Andrew D. (Regent).....	xi, 2, 21, 115, 122
White, David.....	xii
White, Edward Douglass, Chief Justice of the United States.....	xi, 2, 115, 122

	Page.
Wickersham, George W., Attorney General.....	xi
Williams, R. S.....	108
Willis, Bailey.....	103, 105
Wilson, James, Secretary of Agriculture.....	xi
Wind effects in the atmosphere.....	261, 263, 264, 267
Winslow, C.-E. A.....	107
Wood, R. W.....	106
Worlds, life on.....	543

Y.

Yaeger, William L.....	113
Yellowstone National Park.....	71

Z.

Zaborowski, S. (ancient Greece and its slave population).....	597
Zeleny, Dr. Charles.....	13
Zoogeographic researches.....	483
Zoological Nomenclature, Opinions of Commission on.....	16
Zoological Park, National.....	xii, 1, 6, 18, 27, 104, 114
birds.....	73-75, 77
library.....	98
list of donations.....	76
mammals.....	72-73, 77
report on.....	71-81
reptiles.....	75, 77
visitors in.....	77
Zoology, experimental.....	421
life.....	493, 527, 543





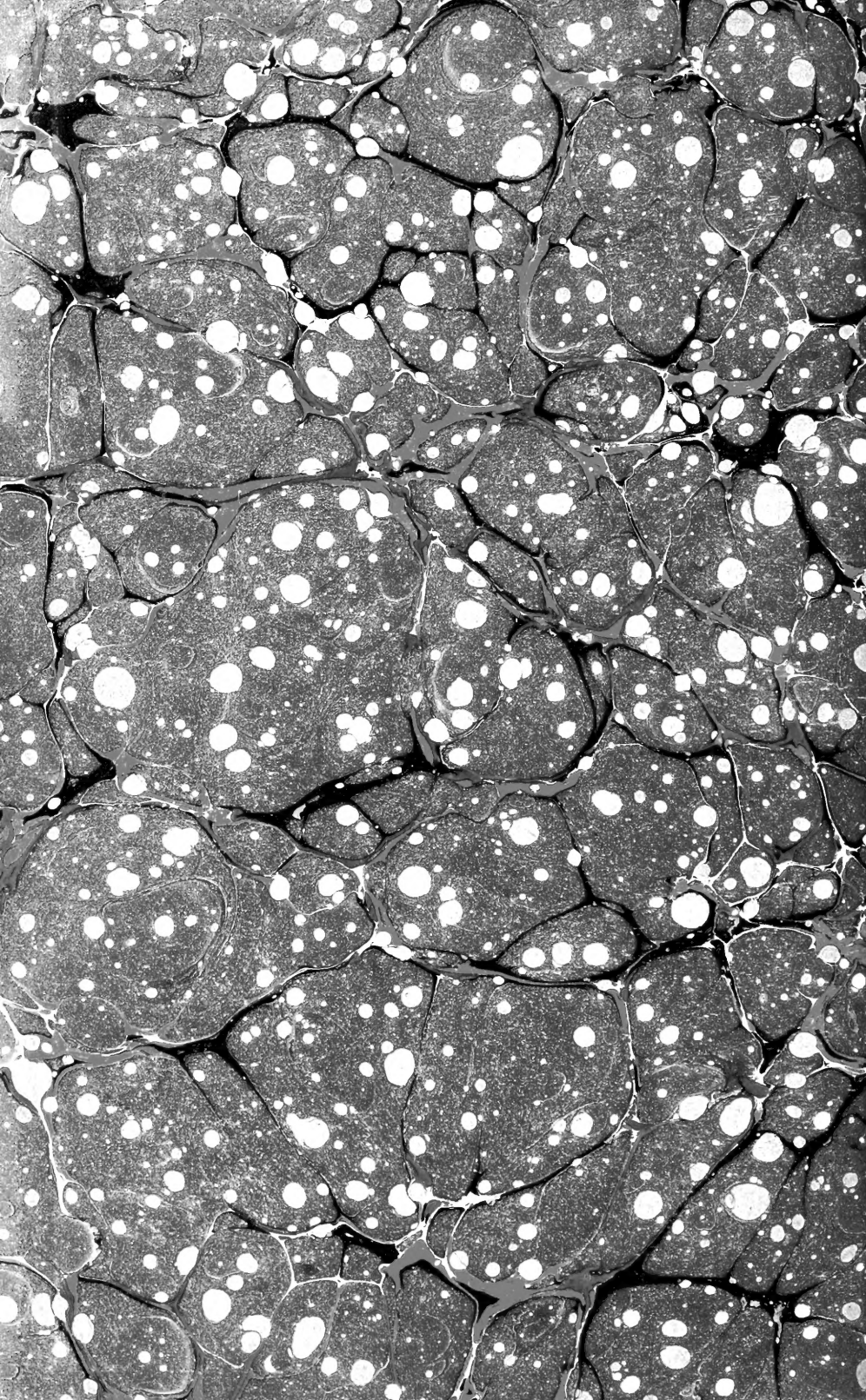

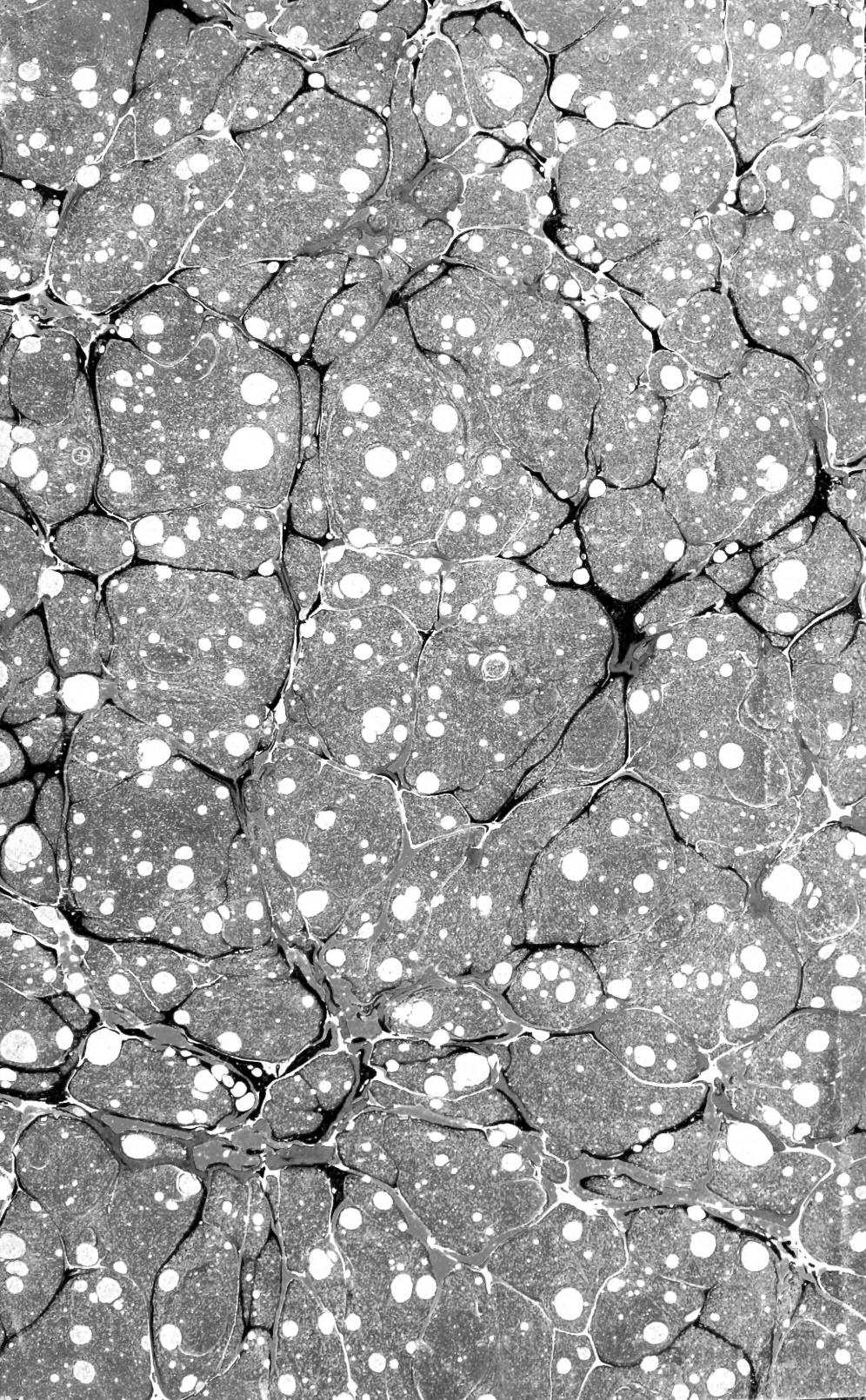

SMITHSONIAN INSTITUTION LIBRARIES



3 9088 01421 7004