



ANNUAL REPORT OF THE
BOARD OF REGENTS OF
THE SMITHSONIAN
INSTITUTION

SHOWING THE

OPERATIONS, EXPENDITURES, AND
CONDITION OF THE INSTITUTION
FOR THE YEAR ENDING JUNE 30

1920



(Publication 2622)

WASHINGTON
GOVERNMENT PRINTING OFFICE
1922

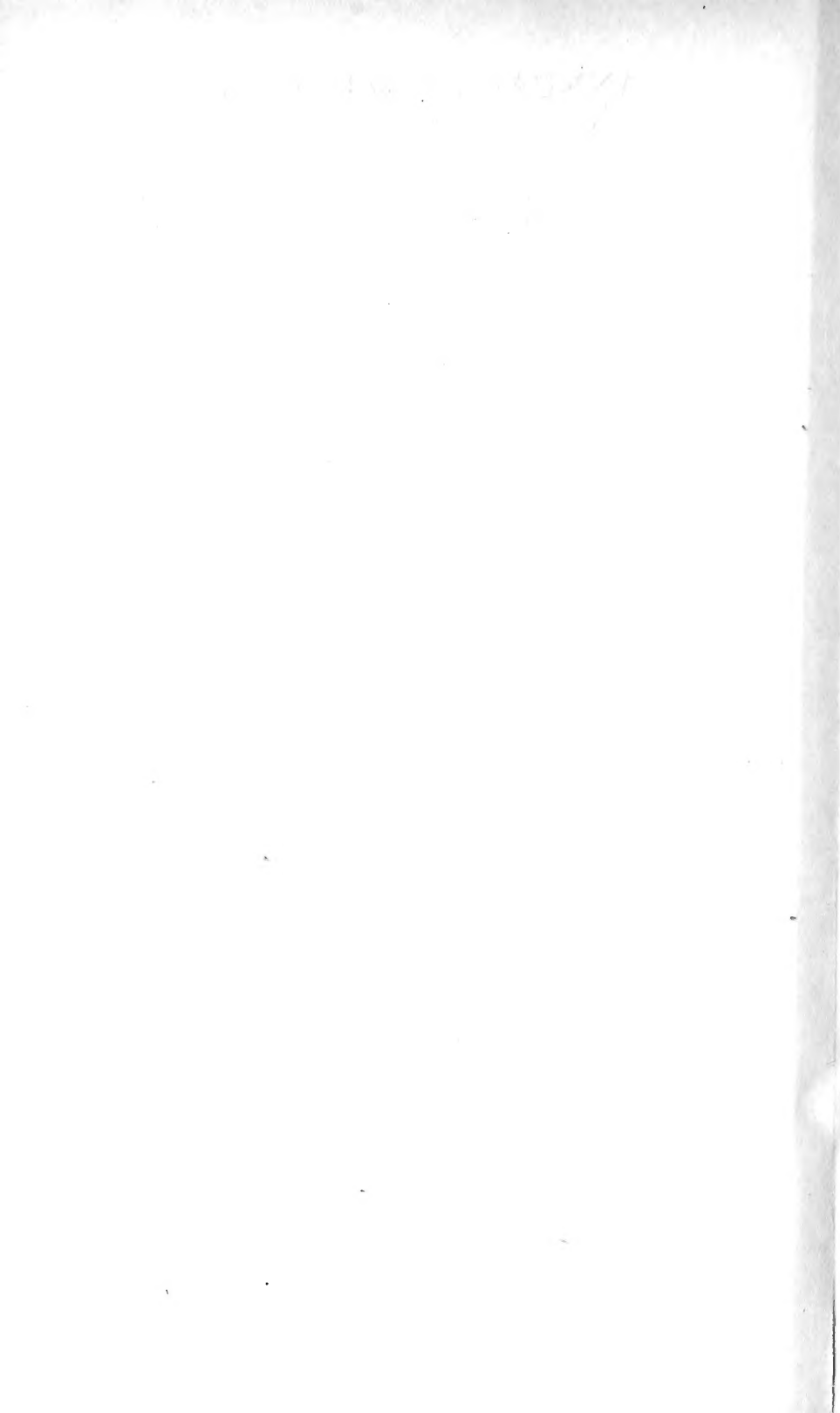

LETTER

FROM THE

SECRETARY OF THE SMITHSONIAN INSTITUTION

SUBMITTING

THE ANNUAL REPORT OF THE BOARD OF REGENTS OF THE
INSTITUTION FOR THE YEAR ENDING JUNE 30, 1920.

SMITHSONIAN INSTITUTION,
Washington, April 13, 1921.

To the Congress of the United States:

In accordance with section 5593 of the Revised Statutes of the United States, I have the honor, in behalf of the Board of Regents, to submit to Congress the annual report of the operations, expenditures, and condition of the Smithsonian Institution for the year ending June 30, 1920. I have the honor to be,

Very respectfully, your obedient servant,

CHARLES D. WALCOTT,
Secretary.

CONTENTS.

	Page.
Letter from the secretary, submitting the annual report of the Regents to Congress.....	3
Contents of the report.....	5
List of plates.....	7
General subjects of the annual report.....	9
Officials of the institution and its branches.....	11
REPORT OF THE SECRETARY.	
The Smithsonian Institution	13
The Establishment	13
The Board of Regents	14
General considerations	14
Finances	16
Researches and explorations:	
Geological explorations in the Canadian Rockies.....	19
Paleontological field work	19
The Collins-Garner French Congo Expedition.....	20
The Smithsonian African Expedition.....	20
Australian Expedition	21
Anthropological researches in the Far East.....	22
Botanical exploration in Haiti	22
Botanical expedition to British Guiana.....	23
Botanical exploration in Glacier National Park, Mont.....	24
Botanical exploration in Jamaica	25
Explorations in Santo Domingo.....	25
Lectures	26
Cinchona Botanical Station	26
Exhibition of South American historical documents.....	27
Research in tropical America	27
Publications	27
Library	29
National Museum	29
Bureau of American Ethnology	31
International Exchanges	32
National Zoological Park.....	33
Astrophysical Observatory.....	34
International Catalogue of Scientific Literature.....	35
Necrology	36
Appendix 1. Report on the United States National Museum.....	37
2. Report on the Bureau of American Ethnology.....	57
3. Report on the International Exchanges.....	73
4. Report on the National Zoological Park	85
5. Report on the Astrophysical Observatory.....	101
6. Report on the International Catalogue of Scientific Literature ..	108
7. Report on the library	112
8. Report on publications.....	117

EXECUTIVE COMMITTEE AND REGENTS.

	Page.
Report of Executive Committee.....	123
Proceedings of Board of Regents.....	127

GENERAL APPENDIX.

Studying the sun's heat on mountain peaks in desert lands, by C. G. Abbot.....	145
The habitability of Venus, Mars, and other worlds, by C. G. Abbot.....	165.
Giant suns, by H. H. Turner.....	173
A bundle of meteorological paradoxes, by W. J. Humphreys.....	183
The determination of the structure of crystals, by Ralph W. G. Wyckoff.....	199
Dr. Aston's experiments on the mass spectra of the chemical elements, with introduction by C. G. Abbot.....	223
Vitamins, by W. D. Halliburton.....	241
Soil acidity—its nature, measurement, and relation to plant distribution, by Edgar T. Wherry.....	247
The chemistry of the earth's crust, by Henry S. Washington.....	269
Major causes of land and sea oscillations, by E. O. Ulrich.....	321
The Bryozoa, or moss animals, by R. S. Bassler.....	339
The horned dinosaurs, by Charles W. Gilmore.....	381
Rhythm in nature, by F. W. Flattely.....	389
Parasitism and symbiosis in their relation to the problem of evolution, by Maurice Caullery.....	399
Local suppression of agricultural pests by birds, by W. L. McAtee.....	411
The occult senses in birds, by Herbert H. Beck.....	439
Adventures in the life of a fiddler crab, by O. W. Hyman.....	443
The senses of insects, by N. E. McIndoo.....	461
The resplendent shield-bearer and the ribbed-cocoon-maker: Two insect inhabitants of the orchard, by R. E. Snodgrass.....	485
The origin of insect societies, by Auguste Lameere.....	511
The botanical gardens of Jamaica, by William R. Maxon.....	523
Narcotic daturas of the Old and New World; an account of their remarkable properties and their uses as intoxicants and in divination, by William E. Safford.....	537
Effect of the relative length of day and night on flowering and fruiting of plants, by W. W. Garner and H. A. Allard.....	569
Fire worship of the Hopi Indians, by J. Walter Fewkes.....	589
Racial groups and figures in the Natural History Building of the United States National Museum, by Walter Hough.....	611
Notes on the dances, music, and songs of the ancient and modern Mexicans, by Auguste Genin.....	657
The Ralph Cross Johnson collection in the National Gallery at Washington, D. C., by George B. Rose.....	679

LIST OF PLATES.

	Facing page.		Facing page.
Secretary's Report :		Botanical Gardens of Jamaica	
Plate 1.....	50	(Maxon) :	
Sun's Heat (Abbot) :		Plates 1-20.....	536
Plate 1.....	148	Daturas (Safford) :	
Plate 2.....	154	Plates 1-13.....	568
Plates 3, 4.....	156	Effect of Light on Plants (Gar-	
Plate 5.....	158	ner & Allard) :	
Plates 6, 7.....	160	Plates 1-17.....	588
Venus, Mars, and Other Worlds		Fire Worship (Fewkes) :	
(Abbot) :		Plate 1.....	592
Plate 1.....	165	Plate 2.....	594
Plates 2, 3.....	168	Plates 3-6.....	596
Structure of Crystals (Wyck-		Plates 7, 8.....	598
off) :		Plates 9-11.....	604
Plates 1-4.....	200	Plates 12, 13.....	608
Plate 5.....	206	Racial Groups (Hough) :	
Plate 6.....	210	Plates 1-4.....	614
Plate 7.....	213	Plates 5-8.....	616
Mass Spectra (Aston) :		Plates 9, 10.....	618
Plate 1.....	235	Plates 11-16.....	620
Soil Acidity (Wherry) :		Plates 17-20.....	622
Plate 1.....	252	Plates 21-28.....	626
Plate 2.....	268	Plates 29-34.....	628
Bryozoa (Bassler) :		Plates 35, 36.....	630
Plates 1-4.....	380	Plates 37, 38.....	632
Horned Dinosaurs (Gilmore) :		Plates 39-42.....	634
Plates 1-8.....	388	Plates 43-48.....	636
Suppression of Pests by Birds		Plates 49-52.....	640
(McAtee) :		Plates 53-58.....	642
Plate 1.....	414	Plates 59-64.....	644
Plate 2.....	422	Plates 65-68.....	646
Plate 3.....	430	Plates 69-74.....	648
Fiddler Crab (Hyman) :		Plates 75, 76.....	650
Plates 1, 2.....	450	Plates 77-80.....	652
Plates 3, 4.....	452	Plates 81-87.....	654
Plates 5, 6.....	456	Mexican Dances (Genin) :	
Senses of Insects (McIndoo) :		Plates 1-10.....	678
Plate 1.....	466	Johnson Collection (Rose) :	
Two Orchard Insects (Snod-		Plates 1-24.....	690
grass) :			
Plates 1-3.....	510		

ANNUAL REPORT OF THE BOARD OF REGENTS OF THE SMITHSONIAN
INSTITUTION FOR THE YEAR ENDING JUNE 30, 1920.

SUBJECTS.

1. Annual report of the secretary, giving an account of the operations and condition of the Institution for the year ending June 30, 1920, with statistics of exchanges, etc.

2. Report of the executive committee of the Board of Regents, exhibiting the financial affairs of the Institution, including a statement of the Smithsonian fund, and receipts and expenditures for the year ending June 30, 1920.

3. Proceedings of the Board of Regents for the fiscal year ending June 30, 1920.

4. General appendix, comprising a selection of miscellaneous memoirs of interest to collaborators and correspondents of the Institution, teachers, and others engaged in the promotion of knowledge. These memoirs relate chiefly to the calendar year 1920.

THE SMITHSONIAN INSTITUTION.

June 30, 1920.

Presiding officer ex officio.—WOODROW WILSON, President of the United States.

Chancellor.—EDWARD DOUGLASS WHITE, Chief Justice of the United States.

Members of the Institution:

WOODROW WILSON, President of the United States.

THOMAS R. MARSHALL, Vice President of the United States.

EDWARD DOUGLASS WHITE, Chief Justice of the United States.

BAINBRIDGE COLBY, Secretary of State.

DAVID F. HOUSTON, Secretary of the Treasury.

NEWTON DIEHL BAKER, Secretary of War.

A. MITCHELL PALMER, Attorney General.

ALBERT SIDNEY BURLESON, Postmaster General.

JOSEPHUS DANIELS, Secretary of the Navy.

JOHN BARTON PAYNE, Secretary of the Interior.

EDWIN THOMAS MEREDITH, Secretary of Agriculture.

JOSHUA WILLIS ALEXANDER, Secretary of Commerce.

WILLIAM BAUCHOP WILSON, Secretary of Labor.

Regents of the Institution:

EDWARD DOUGLASS WHITE, Chief Justice of the United States, Chancellor.

THOMAS R. MARSHALL, Vice President of the United States.

HENRY CABOT LODGE, Member of the Senate.

CHARLES S. THOMAS, Member of the Senate.

MEDILL McCORMICK, Member of the Senate.

LEMUEL P. PADGETT, Member of the House of Representatives.

FRANK L. GREENE, Member of the House of Representatives.

JOHN A. ELSTON, Member of the House of Representatives.

ALEXANDER GRAHAM BELL, citizen of Washington, D. C.

GEORGE GRAY, citizen of Delaware.

CHARLES F. CHOATE, Jr., citizen of Massachusetts.

JOHN B. HENDERSON, citizen of Washington, D. C.

HENRY WHITE, citizen of Maryland.

ROBERT S. BROOKINGS, citizen of Missouri.

Executive committee.—GEORGE GRAY, ALEXANDER GRAHAM BELL, HENRY WHITE.

Secretary of the Institution.—CHARLES D. WALCOTT.

Assistant Secretary.—C. G. ABBOT.

Chief clerk.—HARRY W. DORSEY.

Accounting and disbursing agent.—W. I. ADAMS.

Editor.—W. P. TRUE.

Assistant librarian.—PAUL BROCKETT.

Property clerk.—J. H. HILL.

THE NATIONAL MUSEUM.

Keeper ex officio.—CHARLES D. WALCOTT, Secretary of the Smithsonian Institution.

Administrative assistant to the Secretary, in charge.—W. DE C. RAVENEL.

Head curators.—WILLIAM H. HOLMES, LEONHARD STEJNEGER, G. P. MERRILL.

Curators.—PAUL BARTSCH, R. S. BASSLER, T. T. BELOTE, AUSTIN H. CLARK, F. W. CLARKE, F. V. COVILLE, W. H. DALL, WALTER HOUGH, L. O. HOWARD, ALEŠ HRDLIČKA, NEIL M. JUDD, FREDERICK L. LEWTON, GERRIT S. MILLER, JR., CARL W. MITMAN, ROBERT RIDGWAY.

Associate curators.—J. M. ALDRICH, C. W. GILMORE, W. R. MAXON, CHARLES W. RICHMOND, J. N. ROSE, WALDO L. SCHMITT, DAVID WHITE.

Curator, National Gallery of Art.—W. H. HOLMES.

Chief of correspondence and documents.—H. S. BRYANT.

Disbursing agent.—W. I. ADAMS.

Superintendent of buildings and labor.—J. S. GOLDSMITH.

Editor.—MARCUS BENJAMIN.

Assistant librarian.—N. P. SCUDDER.

Photographer.—ARTHUR J. OLMSTED.

Property and shipping clerk.—W. A. KNOWLES.

Engineer.—C. R. DENMARK.

BUREAU OF AMERICAN ETHNOLOGY.

Chief.—J. WALTER FEWKES.

Ethnologists.—JOHN P. HARRINGTON, J. N. B. HEWITT, FRANCIS LA FLESCHÉ, TRUMAN MICHELSON, JAMES MOONEY, JOHN R. SWANTON.

Editor.—STANLEY SEARLES.

Librarian.—ELLA LEARY.

Illustrator.—DE LANCEY GILL.

INTERNATIONAL EXCHANGES.

Chief clerk.—C. W. SHOEMAKER.

NATIONAL ZOOLOGICAL PARK.

Superintendent.—NED HOLLISTER.

Assistant Superintendent.—A. B. BAKER.

ASTROPHYSICAL OBSERVATORY.

Director.—C. G. ABBOT.

Aid.—F. E. FOWLE, JR.

Assistant.—L. B. ALDRICH.

REGIONAL BUREAU FOR THE UNITED STATES, INTERNATIONAL CATALOGUE OF SCIENTIFIC LITERATURE.

Assistant in charge.—LEONARD C. GUNNELL.

REPORT

OF THE

SECRETARY OF THE SMITHSONIAN INSTITUTION,

CHARLES D. WALCOTT,

FOR THE YEAR ENDING JUNE 30, 1920.

To the BOARD OF REGENTS OF THE SMITHSONIAN INSTITUTION.

GENTLEMEN: I have the honor to submit herewith the annual report on the activities and condition of the Smithsonian Institution and its branches during the year ending June 30, 1920. An account of the affairs of the Institution itself, together with a summary of the work of the several branches, are given on the first 26 pages of this report, while the appendixes are devoted to more detailed accounts of the operations during the year of the National Museum, the Bureau of American Ethnology, the International Exchange Service, the National Zoological Park, the Astrophysical Observatory, the Smithsonian Library, the International Catalogue of Scientific Literature, and an account of the publications of the Institution and its branches.

THE SMITHSONIAN INSTITUTION.

THE ESTABLISHMENT.

The Smithsonian Institution was created by act of Congress in 1846, according to the terms of the will of James Smithson, of England, who in 1826 bequeathed his property to the United States of America "to found at Washington, under the name of the Smithsonian Institution, an establishment for the increase and diffusion of knowledge among men." In receiving the property and accepting the trust Congress determined that the Federal Government was without authority to administer the trust directly, and therefore constituted an "establishment," whose statutory members are "the President, the Vice President, the Chief Justice, and the heads of the executive departments."

THE BOARD OF REGENTS.

The affairs of the Institution are administered by a Board of Regents whose membership consists of "the Vice President, the Chief Justice, three Members of the Senate, and three Members of the House of Representatives, together with six other persons other than Members of Congress, two of whom shall be resident in the city of Washington and the other four shall be inhabitants of some State, but no two of them of the same State." One of the regents, usually the Chief Justice, is elected chancellor by the board, and a suitable person is chosen by them as secretary of the Institution, who is also secretary of the Board of Regents and the executive officer directly in charge of the Institution's activities.

During the year Senator Medill McCormick was appointed a regent to succeed Senator Hollis, whose term as Senator had expired. Representative John A. Elston was appointed to succeed Representative Scott Ferris. Representatives Padgett and Greene were reappointed as regents, and Charles F. Choate, jr., was reelected a citizen regent by the Congress. The roll of regents at the close of the fiscal year was as follows: Edward D. White, Chief Justice of the United States, chancellor; Thomas R. Marshall, Vice President of the United States; Henry Cabot Lodge, Member of the Senate; Charles S. Thomas, Member of the Senate; Medill McCormick, Member of the Senate; Lemuel P. Padgett, Member of the House of Representatives; Frank L. Greene, Member of the House of Representatives; John A. Elston, Member of the House of Representatives; Alexander Graham Bell, citizen of Washington, D. C.; George Gray, citizen of Delaware; Charles F. Choate, jr., citizen of Massachusetts; John B. Henderson, citizen of Washington, D. C.; Henry White, citizen of Maryland; and Robert S. Brookings, citizen of Missouri.

The board held its annual meeting on December 11, 1919. The proceedings of that meeting, as well as the annual financial report of the executive committee, have been printed as usual for the use of the regents, while such important matters acted upon as are of public interest are reviewed under appropriate heads in the present report of the secretary. A detailed statement of disbursements from the Government appropriations under the direction of the Institution for the maintenance of the National Museum, the National Zoological Park, and other branches will be submitted to Congress by the secretary in the usual manner in accordance with the law.

GENERAL CONSIDERATIONS.

The usual routine operations of the Institution in the "increase and diffusion of knowledge among men" were continued during the

year, including a mass of correspondence with individuals and scientific establishments throughout the world. It is becoming increasingly difficult for the Institution with its extremely limited funds, in the face of greatly increased costs in every phase of its activity, to carry on effective work. However, in spite of the fact that the Institution's endowed funds have never been materially increased, it has been possible in some measure to advance knowledge and publish the results of scientific work, as noted in the following report on the year's activities.

It is my sad duty to note here the death during the year of Mr. Charles L. Freer, of Detroit, an irreparable loss to the art interests of the country. As stated in previous reports, Mr. Freer presented his unrivaled collections of American and oriental art to the Smithsonian Institution in 1906, and provided \$500,000 (later increased to \$1,000,000) for the erection of a suitable building to house the collection. This building is now practically completed and nearly ready for the installation of the collections. That Mr. Freer did not live to see the fulfillment of his splendid art gift to the Nation is greatly to be regretted. An interesting article by Miss Katharine N. Rhoades on the recent additions to the Freer Collections appeared in *Art and Archeology*, October, 1919.

In addition to allotments for the maintenance of the Smithsonian solar observing station at Calama, Chile, several small grants for original research have been made from the Hodgkins fund of the Institution—one to Dr. L. G. Hoxton, professor of physics at the University of Virginia, for research on the Joule-Thomson effect in various gases; another to Mr. Alexander Wetmore, of the Biological Survey of the United States Department of Agriculture, for carrying on investigations of the body temperatures of birds; and a third to the Austrian Meteorological Association for the purpose of aiding in continuing the publication of the *Meteorologische Zeitschrift* and for the support of the meteorological observatory on the *Sonnblick*. Both of these were in danger of being discontinued on account of lack of funds, and their cessation would have been a great loss to meteorology.

Working also under a grant from the Hodgkins fund, Prof. Robert H. Goddard, of Clark College, continued his researches on a multiple-charge rocket for reaching great altitudes mentioned in last year's report. The early results of his experiments were published during the year by the Institution under the title "A Method of Reaching Extreme Altitudes," in which Prof. Goddard showed that it would be perfectly possible by means of his new type of high-efficiency rocket to send recording instruments to the hitherto unknown upper layers of the atmosphere and to provide for their safe return, thus

obtaining new data of the greatest interest and scientific value to meteorology and solar physics. Prof. Goddard also showed that it was theoretically possible to send a mass of 1 pound of flash powder outside the earth's attraction and to the dark surface of the new moon, where, on impact, the flash would be visible through telescopes on the earth. This interesting speculation aroused great popular interest throughout the country, almost to the exclusion of the immediately apparent scientific value of the experiment, namely, the exploring of the unknown upper layers of the earth's atmosphere. Prof. Goddard was working on the further development of his researches at the close of the year.

An important event in the art development of the country will be the creation of the National Gallery of Art as a separate administrative unit under the Smithsonian Institution, to take effect at the first of the coming year, instead of, as at present, a division of the National Museum, which action is made possible through a small appropriation in the sundry civil bill for 1921. Mr. W. H. Holmes, at present head curator of the department of anthropology in the Museum, will be appointed director of the National Gallery.

FINANCES.

The investments of the Institution are as follows:

Deposited in the Treasury of the United States under authority of Congress -----	\$1,000,000.00
--	----------------

CONSOLIDATED FUND.

American Telephone & Telegraph Co. 4 per cent collateral trust bonds, due July 1, 1929-----	15,680.00
Province of Manitoba 5 per cent gold debentures, due Apr. 1, 1922-----	1,935.00
West Shore Railroad Co. guaranteed 4 per cent first-mortgage bonds, due Jan. 1, 2361-----	37,275.00
Cleveland Electric Illuminating Co. first-mortgage 5 per cent gold bonds, due Apr. 1, 1939-----	9,430.00
United States first Liberty loan-----	200.00
United States second Liberty loan-----	100.00
United States third Liberty loan-----	10,150.00
United States fourth Liberty loan-----	50.00
United States Victory loan-----	4,341.64
United States war-savings stamps, series of 1918-----	100.00
Brooklyn Rapid Transit Co. 5 per cent notes, due July 1, 1918---	3,500.00
Redeemed bonds, excess cost over par-----	134.38
Total -----	82,896.02

The sum invested for each specific fund and the manner in which held is described as follows:

Fund.	United States Treasury.	Consolidated fund.	Total.
Smithson fund.....	\$727,640.00	\$1,304.00	\$728,944.00
Habel fund.....	500.00		500.00
Hamilton fund.....	2,500.00	500.00	3,000.00
Hodgkins general fund.....	116,000.00	37,275.00	153,275.00
Hodgkins specific fund.....	100,000.00		100,000.00
Rhees fund.....	590.00	117.00	707.00
Avery fund.....	14,000.00	16,898.84	30,898.84
Addison T. Reid fund.....	11,000.00	2,150.00	13,150.00
Lucy T. and George W. Poore fund.....	26,670.00	4,968.00	31,638.00
George K. Sanford fund.....	1,100.00	221.00	1,321.00
Chamberlain fund.....		10,000.00	10,000.00
Bruce Hughes fund.....		8,355.93	8,355.93
Lucy H. Baird fund.....		1,106.25	1,106.25
Total.....	1,000,000.00	82,896.02	1,082,896.02

The \$3,500 par value of the 5 per cent gold notes of the Brooklyn Rapid Transit Co. are still held in the hands of receivers, no plan of reorganization of the company having yet been decided upon.

Mr. B. H. Swales, honorary custodian, section of birds' eggs, has contributed an additional \$300 to the Institution for the purchase of specimens, making a total contribution of \$600 since January, 1919.

Several small lots of unimproved land near Lowell, Mass., have been sold, and \$440.07 was realized therefrom and invested for account of the Lucy T. and George W. Poore fund.

Dr. William L. Abbott has contributed \$4,000 during the year to the maintenance of a field party, the purpose of which is to procure archeological and natural history specimens in Australia. This sum is in addition to an unexpended balance which Doctor Abbott had previously furnished for similar work in Borneo and Celebes.

The Institution has received for specific activities valuable contributions from Mr. John A. Roebing and the Rockefeller Foundation, the amounts being \$11,000 and \$2,500, respectively.

Current funds not immediately required for expenditure are, when conditions will permit, deposited on time in local trust companies and draw 3 per cent interest per annum. The interest received in this manner during the year amounted to \$1,320.60.

The income during the year, amounting to \$171,788.35, was derived as follows: Interest on permanent investments and other sources, \$65,651.37; repayments, rentals, publications, etc., \$14,525.09; contributions from various sources for specific purposes, \$41,171.82; bills receivable, \$50,000; proceeds from sale of real estate, \$440.07.

Adding the cash available July 1, 1919, \$2,122.78, the total resources for the year amounted to \$173,911.13.

The disbursements, which are described in the annual report of the executive committee, amounted to \$160,606.79, leaving a balance on deposit with the Treasurer of the United States, in cash and in bank, amounting to \$13,304.34.

The Institution was charged by Congress with the disbursement of the following appropriations for the year ending June 30, 1920:

International Exchanges	\$45,000
American Ethnology.....	42,000
International Catalogue of Scientific Literature.....	7,500
Astrophysical Observatory.....	13,000
National Museum:	
Furniture and fixtures.....	20,000
Heating and lighting.....	69,715
Preservation of collections.....	300,000
Building repairs.....	10,000
Books.....	2,000
Postage.....	500
Heating equipment, Aircraft Building.....	14,000
National Zoological Park.....	115,000
Increase of compensation (indefinite).....	
Total.....	638,715

In addition to the above there was included under the general appropriation for printing and binding an allotment of \$76,200 to cover the cost of printing and binding the Smithsonian annual report and reports and miscellaneous printing for the Government branches of the Institution.

RESEARCHES AND EXPLORATIONS.

Every year the Institution sends out or participates in, so far as its limited means will permit, expeditions for the purpose of increasing scientific knowledge in various parts of the world which have been previously but imperfectly known to science. In former years every continent and nearly every country on the globe has been visited by Smithsonian scientific explorers, and the result has been the accumulation of a valuable mass of information on the people, fauna, flora, geology, geography, ethnology, etc., of the various regions visited. Many of the more important results of these expeditions have been published by the Institution, and thereby have the chief objects of the Smithsonian as laid down by its founder, "the increase and diffusion of knowledge among men," been carried out.

While the prevailing universal high costs have considerably reduced the effectiveness of the Institution's funds for research and exploration, nevertheless several expeditions were in the field during the past year, and the activities of some of these are here briefly described.

GEOLOGICAL EXPLORATION IN THE CANADIAN ROCKIES.

Geological field work in the Canadian Rocky Mountains was continued by your secretary during the field season of 1919, with the following objects in view: (1) The discovery of an unmetamorphosed, undisturbed section of the Upper Cambrian formations north of the Canadian Pacific Railway; and (2) the collection of fossils to determine the various formations and to correlate them with the Upper Cambrian formations elsewhere. The region selected for examination was the area about Glacier Lake, which was reached through Bow Pass, down the Mistaya Creek to the Saskatchewan River, and thence up to the headwaters of the Middle Fork.

The geological section measured is of such interest that I will describe it briefly. The rocks exposed in the highest cliffs of Mount Forbes and Mons Peak belong to the great Carboniferous system of rocks of this region. Below this series is a belt 1,000 feet or more in thickness comprising the Devonian rocks, beneath which are the strata of the Sarbach formation of the Ordovician system. Under these again are the five formations of the Upper Cambrian series, and at one place near Mount Murchison is a low ridge formed of strata of Middle Cambrian age.

Special attention was given to the glaciers of which there are many fine examples in the region. Beautiful photographs of some of these were obtained, one showing a complete glacier from its névé to its foot. A preliminary examination of the fossils in the formations studied correlates them with the Upper Cambrian formations of Wisconsin and Minnesota and the Upper Cambrian section in southern Idaho, and to a lesser extent with that of the central belt of Pennsylvania.

PALEONTOLOGICAL FIELD WORK.

Two short field trips were taken during the year by Dr. R. S. Bassler, curator of paleontology, for the purpose of securing certain specimens of fossils and rocks required for the Museum exhibition series. During the previous year some excellent exhibition specimens had been located in southeastern Indiana, but owing to the impossibility of securing help to get them to a freight station, it had been necessary to leave them. This year, conditions being the same, they were carefully wrapped in burlap and padded with a quantity of weeds and laboriously dragged along the rails to the nearest station. The same method was used in transporting to a station the specimens found this year along a creek in the same locality, where heavy spring freshets had uncovered some richly fossiliferous layers of rock. One of these specimens, a slab several feet in length and width, was crowded with impressions of the branching fossil seaweed *Burthothrephis*, and with excellent examples of the dumb-bell seaweed *Ar-*

thraria. A specimen showing an assemblage of these ancient plant remains had long been needed in the fossil-plant exhibition series in the Museum.

Later in the year, Dr. Bassler proceeded to Dayton, Ohio, to prepare for shipment to Washington the largest entire American trilobite so far discovered. The trilobite was uncovered by the pick of a workman in the excavations for the Huffman conservancy dam, 6 miles east of Dayton. Mr. Arthur E. Morgan, chief engineer of the Miami conservancy district, recognized the scientific value of the fossil animal and presented it to the Institution, where it now forms a most unique and instructive exhibit in the hall of invertebrate paleontology of the National Museum. The specimen is of special value since it has become the type of a new species, *Isotelus brachycephalus*, described by Dr. August F. Foerste, of Dayton, Ohio.

THE COLLINS-GARNER FRENCH CONGO EXPEDITION.

The "Collins-Garner expedition in the interests of the Smithsonian Institution," which had been collecting biological material in the French Congo since the summer of 1918, returned to this country early in 1919, but the collections resulting from the expedition were incorporated into the Museum series of African material during the past fiscal year. Mr. C. R. W. Aschemeier, who represented the Institution, collected and turned over to the Museum some 2,500 mammals, birds, reptiles, fishes, and invertebrates, an invaluable addition to the Museum collections.

THE SMITHSONIAN AFRICAN EXPEDITION.

Last year it was announced that an expedition to Africa had been organized to collect plants and animals needed by the Museum to supplement the magnificent collections made on that continent by Col. Theodore Roosevelt and other explorers. This expedition, under the title of the "Smithsonian African expedition, under the direction of Edmund Heller in conjunction with the Universal Film Manufacturing Co." sailed on July 16 on the steamship *City of Benares*, arriving in Cape Town August 13. Besides Mr. Heller, the Institution was represented by Mr. H. C. Raven, who has in former years made collections for the Smithsonian in Borneo, Celebes, and other regions.

In the vicinity of Cape Town, Mr. Raven was able to collect only insects and invertebrates, and from there he went to the Addo Bush, where 19 days were spent in collecting small mammals and birds. Going through Durban and Johannesburg, Mr. Raven spent two weeks collecting at Ottoshoop in the Transvaal, after which he proceeded to Victoria Falls, and from there he and Doctor Shantz, who

was representing the United States Department of Agriculture, left for the Kafue River region, where they camped for several weeks.

After spending some weeks along the Congo, they reached Lake Tanganyika, where camp was made for about a month. The next stop of any length was in Uganda, where a few days over a month was spent in collecting in the Bundogo Forest. As the whole forest was in the sleeping-sickness area, it was necessary to get a special permit from the district commissioner to enter it, and the native boys engaged by Mr. Raven had to be examined by a doctor before entering the area and again on leaving it. At the close of the year, Mr. Raven was at Masindi, in Uganda, preparing to return to the United States.

Only one shipment of material had been received by the end of the year, consisting of 239 mammals and birds from southern Africa, which, with the remainder of the specimens still to be received from Mr. Raven, will be of great value in working up the African material already in the Museum collections.

AUSTRALIAN EXPEDITION.

Through the continued generosity of Dr. W. L. Abbott, the Institution sent Mr. Charles M. Hoy to Australia for the purpose of collecting vertebrates, especially those which are in danger of extermination. As the Museum at present contains only about 200 specimens of the remarkable Australian mammal fauna, this expedition is of the utmost scientific importance, especially since in the future it will be impossible to secure an adequate representation of the fauna owing to their rapid extermination.

Mr. Hoy began work in Australia about the 1st of June, 1919, and by the close of the past fiscal year one shipment had been received at the Museum, consisting of 240 mammals and 228 birds. The following passages from reports and letters received from Mr. Hoy give an idea of the conditions under which the collecting was carried on:

Nine weeks were spent in the Wandandian region (19 miles southwest of Norwra, New South Wales), with the result of but 131 mammals and 124 birds collected. Among the mammals 10 genera and 12 species are represented in my collection.

The greatest agent working toward the extermination of the native animals is the fox; next comes the cattle and sheep men, who distribute poison by the cartload in the effort to reduce the rabbits. This has also caused or helped to cause the extermination of some of the ground-inhabiting birds. Another great agent is the bush fires which sweep over the country. These are often lit intentionally in order to clear out the undergrowth and thus increase the grass.

The extermination of the native mammals has apparently gone much further than is generally thought. Many species that were plentiful only a few years ago are now almost, if not altogether, extinct. Diseases have also played a great part in the extermination. The native bear died in thousands from a disease which produced a great bony growth on their heads. A mysterious disease

also spread through the ranks of the native cat, *Dasyurus viverrinus*; the domestic cat also played a great part in their extermination. Even adult specimens of *Dasyurus* were often dragged in by the family cat.

It is the killing and burning of the brush by the cattlemen that does the most to kill off the animals, and they are yearly reaching farther and farther away from the railroads. One thing that was very noticeable was the great abundance of the introduced rats. They seem to have driven out or killed off practically all the native rats, and I found them everywhere.

ANTHROPOLOGICAL RESEARCHES IN THE FAR EAST.

Dr. Aleš Hrdlička, curator of physical anthropology, National Museum, made an extended trip to the Far East in the interest of his researches on the origin of the American Indian and the peopling of eastern Asia. While in China he assisted with the organization of anthropological research in connection with the Peking Union Medical College in China.

During this trip, which occupied over five months, Doctor Hrdlička visited Japan, Korea, Manchuria, northern China, and the border of southern Mongolia, examining the local collections as well as the actual populations. The results of the journey have contributed very materially to the solution of the problems for which the trip was made, in addition to which it was possible to arrange for exchanges of material, and especially to organize a nucleus for anthropological investigation in China.

Doctor Hrdlička returned by way of Hawaii, where a two weeks' stop was made for the study of the natives and of Hawaiian problems in general.

While at Peking Doctor Hrdlička consulted prominent foreigners, as well as Chinese scholars, on the advisability of establishing in Peking, or of taking steps toward the establishment there of a "China Museum of Natural History," which, like the United States National Museum, would include the departments of geology, biology, and anthropology, and which would serve as a center for investigators in these lines in China and the Far East. Before his departure the opportunity was given him by representatives of several of the ministries and other officials to make the proposal more formally, with the result that a committee was to be organized for consideration of the project.

BOTANICAL EXPLORATION IN HAITI.

Through the generosity of Dr. W. L. Abbott, for many years a benefactor of the Institution, it was possible to detail Mr. Emery C. Leonard, aid in the Division of Plants, United States National Museum, as botanical collector to accompany Doctor Abbott to Haiti upon his last visit of exploration in that country, from February to

July, 1920. A collection aggregating 10,000 specimens, representing about 2,700 collection numbers, was secured by Mr. Leonard in several characteristic regions. This material will prove of exceptional value and interest from the fact that, little botanical collecting having been done in Haiti, the flora is in consequence very imperfectly known. The field work may be summarized as follows:

After completing their outfit at Port au Prince, the point of arrival, Dr. Abbott and Mr. Leonard proceeded by railroad to St. Marc, thence by native fishing schooner to Gonave Island, lying a short distance off the coast. This island, which is about 30 miles long from east to west and 10 miles broad, is entirely of coral formation, which decomposes to form a very rich reddish soil. Work was carried on principally upon the northern side. A low mountain range forms the backbone of the island, intersected by occasional sharp ravines, in which are found a very few springs. The coast is bordered by an almost unbroken fringe of mangroves, back of which is a belt of bare saline flats. Next in succession is a region of low arid foothills, from which the mountains rise rather abruptly. The hills and slopes are covered with thorny thickets, chiefly of leguminous shrubs and low trees, with cacti interspersed, but the uplands (called La Table) open in large grassy areas, with only scattered trees and shrubs, which afford rich pasture. About three weeks were spent on the north side of the island, working from Anse Galette and Etroite, and somewhat later a week on the south shore, with the small village of Pickney as base.

The second part of the exploration covered the region west and south of Lake Saumatre. Access was easily gained by railroad from Port au Prince to Etang, on the west shore of the lake. After a week's collecting in the vicinity of Etang the party traveled by boat to Fond Parisien, on the southeast shore, and, procuring donkeys, proceeded overland to Mission, in the midst of the La Salle Mountains, where an altitude of 2,000 meters was reached. From this elevation down to 900 meters the slopes were sparsely covered with pines, and, where protected from fire, with dense thickets that sheltered a luxuriant growth of ferns. About two weeks were spent in collecting in this region.

The final portion of the field work was carried on in the region of Furcy, which lies a short distance south of Port au Prince. The collections here were made mostly on the wooded ridge east of Furcy on the trail to Grande Touraine. The region is well watered and has a delightful climate, but the country about Furcy itself has been almost entirely cleared of forests.

Of the plants collected perhaps one-third are ferns, the remaining portion consisting of shrubs and herbaceous plants, among which are a considerable number of grasses and cacti. The cacti appear to be of special interest.

BOTANICAL EXPEDITION TO BRITISH GUIANA.

Through the cooperation of the United States Department of Agriculture, the Gray Herbarium of Harvard University, and the New York Botanical Garden, a trip to British Guiana was made by Dr. A. S. Hitchcock, custodian of the section of grasses, National Museum. Doctor Hitchcock reports:

I left New York October 4 and arrived at Georgetown, British Guiana, October 22, visiting on the way down the islands of St. Thomas, St. Croix, St. Kitts, Antigua, Guadeloupe, Dominica, Martinique, St. Lucia, and Barbados. On the return trip in February the islands of Trinidad and Grenada were visited. Col-

lections of grasses were made on all the islands. In British Guiana a general collection of flowering plants was made, a set going to each of the contributing institutions.

My headquarters were at Georgetown, the capital and only large city of the colony. Here there is a good botanical garden and a herbarium of British Guiana plants, known as the Jenman Herbarium. Prof. J. B. Harrison, the director of science and agriculture, is in charge of the scientific activities of the colony and rendered me very efficient aid.

The greater part of British Guiana is covered with virgin forest. The vast savannas of Venezuela extend into the southern part of the colony. The temperature is high, 75° to 85°, according to the season, and the rainfall at Georgetown is about 90 inches. The settlements are mainly along the coast, and travel in the interior is by boat along the numerous rivers. The country for some distance back of the coast is low and wet. The chief industry is the raising of sugar cane. The health of the colony is fairly good, though there is much malaria.

The botanical results were very satisfactory. About 1,200 numbers of plants were collected. Especial attention was given to the grasses, of which 171 species are now known to grow in the colony.

BOTANICAL EXPLORATION IN GLACIER NATIONAL PARK, MONT.

Mr. Paul C. Standley, assistant curator in the Division of Plants, United States National Museum, spent about 10 weeks, from July to September, 1919, in Glacier National Park, Mont., under the authority of the National Park Service, for the purpose of studying the vegetation of the region. A large series of photographs and about 4,000 specimens, representing over 900 species of plants, were obtained, which will serve as the basis of a popular illustrated account of the plants to be published by the Park Service, and a more complete technical paper on the flora, in process of publication by the National Museum. The zonal distribution of the plants, which is of extreme interest, is discussed briefly by Mr. Standley, as follows:

The Continental Divide, which traverses the park, has a marked influence upon plant distribution. On the east slope, whose drainage is partly into the Missouri River and partly into Hudson Bay, the flora is of the Rocky Mountain type, like that of Wyoming and Colorado; while on the west slope, whose streams drain into the Columbia River, the flora is more obviously related to that of the Pacific coast. The forests about Lake McDonald are very dense and are composed of unusually large trees. Although not nearly so extensive, they are much like those of the humid regions of Oregon and Washington.

In the vegetation there are represented four of the life zones recognized by biologists. The transition zone is indicated on the west slope by small areas of yellow-pine timber, and east of the park are the prairies of the Blackfoot Indian Reservation, which extend also within the park boundaries along the stream valleys. The plants here are chiefly herbs, with a few shrubs, and they belong mostly to species which have a wide distribution over the Great Plains. By far the largest portion of the park is covered with the characteristic vegetation of the Canadian zone, which is the heavily forested area. Above the Canadian zone, around timber line (6,000 to 7,500 feet), lies a narrow belt belonging to the Hudsonian zone. The trees here are mostly low and stunted,

and their branches frequently lie prostrate upon the ground. Above this belt, and occupying the highest exposed slopes, lies the Arctic-Alpine zone, whose vegetation is composed chiefly of small herbaceous plants, with a few dwarfed shrubs, mostly willows. Many of the species of this zone are widely distributed in alpine or arctic regions of North America, and some of them occur also in similar situations in Europe and Asia.

BOTANICAL EXPLORATION IN JAMAICA.

Mr. William R. Maxon, associate curator in the Division of Plants, United States National Museum, accompanied by Mr. E. P. Killip, aid, was detailed to field work in Jamaica in February last for the purpose of making botanical collections in general and of securing fern material for use in connection with a projected volume upon the ferns of Jamaica. Over two months were spent in the island, including a period of three weeks in the Blue Mountain region, with the Cinchona Botanical Station as base. Other regions covered include Mount Diablo, Montego Bay, Mill Bank, and Seamens Valley, and the southern border of the peculiar "cockpit country" above Ipswich, a wooded area of limestone "sinks." Upward of 10,000 specimens were collected, representing about 1,700 collection numbers. In addition to the series to be retained by the National Museum, nearly uniform sets of the ferns and flowering plants have been distributed to the Gray Herbarium of Harvard University, the New York Botanical Garden, the Field Museum of Natural History, and the University of Illinois, all of which contributed equally to the field expenses of the work. Sets of the woody plants and orchids have been sent also to the Arnold Arboretum of Harvard University, and to Mr. Oakes Ames, respectively, in return for similar assistance. The lower cryptogams of the collection are in process of identification and will be distributed shortly.

EXPLORATIONS IN SANTO DOMINGO.

During the first three months of the fiscal year Dr. W. L. Abbott continued his scientific investigations in Santo Domingo, stopping at Sosua, on the north side of the island, where a search was made for certain birds needed to fill gaps in the series already collected. The Samaná Peninsula was then explored, after which Dr. Abbott visited the islets of Saona and Catalina, off the southeastern corner of Santo Domingo, and concluded his investigations with a few days' work at Lake Enriquillo.

The material collected on this trip and the previous trip ending just before the beginning of the fiscal year was varied in character, embracing the several groups of vertebrates as well as mollusks, insects, and plants, with a plentiful series of archeological objects from caves in the Samaná district. Of birds alone, 278 study skins, 87

alcoholics and skeletons, and 56 eggs were collected, including birds representing four species not hitherto possessed by the Museum and three or four other species not previously known to occur on the island.

LECTURES.

Hamilton fund lecture.—The Hamilton fund was placed under the administration of the Institution by the Rev. James Hamilton in 1875, the interest to be used for "lectures on scientific or useful subjects." Under the auspices of this fund an interesting lecture was delivered on April 13 in the auditorium of the National Museum by the Rev. Charles E. Jefferson, D. D., on "The old order and the new," in which Dr. Jefferson gave his views as to the causes which led the world into its present unsettled condition and of the solution of the problems presented.

Lectures for the Y. M. C. A.—At the request of Dr. W. C. Little, field secretary of the Young Men's Christian Association, a series of lectures on scientific subjects written in a style to be instructive and entertaining to a general audience was prepared by members of the staffs of the Institution and its branches, for use in the educational extension work of the association. The scheme was to have these lectures delivered in rotation by volunteer lecturers in many different localities in the United States, thereby reaching a large number of people interested in keeping in touch with the advance of science and progress in general. The lectures prepared by members of the Smithsonian staff were as follows:

The Sun, by C. G. Abbot.

Cave Dwellings of the New and Old Worlds, by J. W. Fewkes.

The Primeval Life of North America, by R. S. Bassler.

A Visit to the Races of Man, by Walter Hough.

In the Land of the Great Natural Bridges, by Neil M. Judd.

The Progress in Land Transportation, by Carl W. Mitman.

Antiquities of the Bible, by I. M. Casanowicz.

Strange Facts in Nature, by Austin H. Clark.

Flying Animals, by Austin H. Clark.

Interesting Animals and Birds from East Africa, by Austin H. Clark.

Extinct Monsters of North America, by Charles W. Gilmore.

Mammals of Ancient North America, by James W. Gidley.

CINCHONA BOTANICAL STATION.

In my report last year it was stated that negotiations had been begun with the Government of Jamaica to renew the Smithsonian's three-year lease on the Cinchona Botanical Station which was canceled during the period of the war. This was successfully arranged in January, 1920, and the renewed lease dated from January 1.

The station is maintained by the subscription of a number of institutions in this country for the purpose of enabling accredited inves-

tigators to study the rich and interesting flora of the region. From January 1 to the close of the year the following botanists planned to avail themselves of the privileges of the station: Messrs. W. R. Maxon and E. P. Killip, of the United States National Herbarium, for work on the taxonomy of ferns and flowering plants; Mr. Frederick Boughton, of Pittsford, N. Y., for collecting fungi; Dr. J. M. Thompson, of Glasgow, for work on the ferns; and Prof. R. E. Danforth, of Rutgers College, also for work on the ferns.

EXHIBITION OF SOUTH AMERICAN HISTORICAL DOCUMENTS.

From July 28 to August 9, 1919, there was held in the Smithsonian Building an exhibition of South American historical documents brought together by Señor Don Jorge M. Corbacho, a member of the Peruvian Parliament and delegate to the Pan American Congress. The collection, containing official documents signed by the Spanish conquistadores, the viceroys at Lima and the revolutionary leaders during the wars for independence, was one of inestimable value and was shown at the Smithsonian for the first time in North America.

RESEARCH IN TROPICAL AMERICA.

In June 1920, the National Research Council, of which your secretary is a vice chairman, held a conference on the project of incorporating an institute for promoting research in tropical America, including exploration and the establishing of laboratories and research stations, and of effecting cooperation between the institutions interested in tropical research and exploration. The membership of the proposed institute was to consist of representatives (one each) from institutions interested in such research, and these institutions were invited by the Research Council to appoint representatives, but at the close of the year replies had not been received.

PUBLICATIONS.

The Institution and its branches issued during the year 95 volumes and separate pamphlets. Of these various publications there were distributed a total of 143,290 copies, which includes 157 volumes and separates of Smithsonian Contributions to Knowledge, 24,949 volumes and separates of Smithsonian Miscellaneous Collections, 16,720 volumes and separates of Smithsonian Annual Reports, 81,936 volumes and separates of the various series of the National Museum, 16,761 publications of the Bureau of American Ethnology, 1,958 special publications, 19 volumes of the Annals of the Astrophysical Observatory, 23 reports on the Harriman Alaska expedition, and 564 reports of the American Historical Association.

Through its publications the Institution carries out one of its principal objects, the "diffusion of knowledge." The Smithsonian series, except the annual report, are printed from Smithsonian funds in small editions for distribution principally to libraries and scientific and educational establishments throughout the world. The annual report, containing a general appendix consisting of a number of articles illustrating recent advances in nearly every branch of science, is printed by congressional appropriation in editions of 10,000 copies and is in great demand throughout the country. The Museum and Bureau of Ethnology publications are discussed in detail in the reports of those branches appended to this report.

Of the Smithsonian Miscellaneous Collections, 14 numbers were issued, among which may be mentioned 2 papers by your secretary on his researches in Cambrian geology and paleontology, a paper showing the relations between the variations in solar radiation and in the weather, based on the work of the Smithsonian Astrophysical Observatory on the solar constant of radiation, and a fourth revised edition of the Smithsonian Meteorological Tables, for which there is a continued demand.

Allotments for printing.—The congressional allotments for the printing of the Smithsonian report and the various publications of the branches of the Institution were practically used up at the close of the year. The allotments for the coming year ending June 30, 1921, are as follows:

For the Smithsonian Institution: For printing and binding the annual reports of the Board of Regents, with general appendices, the editions of which shall not exceed 10,000 copies.....	\$10,000.00
(<i>Provided</i> , That the unexpended balance of the appropriation of \$10,000 made for this purpose in the sundry civil act approved July 1, 1918, is hereby reappropriated and made available during the fiscal year 1921).....	5,220.99
For the annual reports of the National Museum, with general appendices, and for printing labels and blanks and for the bulletins and proceedings of the National Museum, the editions of which shall not exceed 4,000 copies, and binding in half morocco or material not more expensive, scientific books and pamphlets presented to or acquired by the National Museum library.....	37,500.00
For the annual reports and bulletins of the Bureau of American Ethnology and for miscellaneous printing and binding for the bureau.....	21,000.00
For miscellaneous printing and binding:	
International Exchanges.....	200.00
International Catalogue of Scientific Literature.....	100.00
National Zoological Park.....	200.00
Astrophysical Observatory.....	200.00
For the annual report of the American Historical Association.....	7,000.00

COMMITTEE ON PRINTING AND PUBLICATION.

The function of the Smithsonian advisory committee on printing and publication is to consider all manuscripts offered for publication

by the Institution or its branches. During the year 10 meetings were held and 93 manuscripts were passed upon. The membership of the committee is as follows: Dr. Leonhard Stejneger, head curator of biology, National Museum, chairman; Dr. George P. Merrill, head curator of geology, National Museum; Dr. J. Walter Fewkes, chief, Bureau of American Ethnology; Mr. N. Hollister, superintendent, National Zoological Park; and Mr. W. P. True, editor of the Smithsonian Institution, secretary.

LIBRARY.

The Smithsonian library received during the year 6,995 volumes and pamphlets, distributed as follows: To the Smithsonian deposit in the library of Congress, 4,019; to the Smithsonian office, Astrophysical Observatory, and National Zoological Park libraries, 428; and to the National Museum library, 2,548.

Continued use of the library's collection of works on aeronautics has been made by students of aeronautics, both of the United States and of foreign countries. Forty titles were added to the collection during the year. In the De Peyster collection, author cards have been made for the Napoleon series and for the works on British, German, and Italian history.

The work of the library has suffered from the fact that the appropriation for binding has not kept pace with the greatly increased cost. This has reduced the number of books bound during the year to 737, as compared with 1,322 in 1919 and 1,706 in 1918.

NATIONAL MUSEUM.

The congressional appropriation for the maintenance of the Museum has remained practically the same for many years, and as a result of the great increase, both in size and importance, of the collections, not only has it been impossible to undertake desirable new lines of work, but also existing work has been greatly hampered by the necessity of observing the strictest economy. The two most serious handicaps to the Museum in extending its usefulness to the people of the country are lack of space for proper exhibition of its valuable collections and an insufficient staff of expert curators. This last has in several cases necessitated grouping wholly unlike divisions under one curator, with the result that the sections in which there is no specialist in charge must remain practically at a standstill.

In June, 1920, a small congressional appropriation made possible the establishment of the National Gallery of Art as an independent bureau under the administration of the Smithsonian Institution, instead of being as previously a part of the Museum, the change to take effect on July 1, 1920. Mr. W. H. Holmes, head curator of the

department of anthropology in the Museum, will become director of the National Gallery at the beginning of the year.

The Freer Gallery of Art was brought nearly to completion during the year, and arrangements were made with the Office of Public Buildings and Grounds for the construction of driveways and the improvement of the grounds around the building. The collections have begun to come in from the executors of Mr. Freer's estate and are being stored in the building until the installation can be begun.

During the past year the Museum acquired a total of 216,871 specimens, classified as follows: Anthropology, 15,254; zoology, 101,554; botany, 35,211; geology and mineralogy, 22,400; paleontology, 40,000; division of textiles, 1,716; mineral technology, 627; mechanical technology, 97; and National Gallery of Art, 12. Four hundred and ninety-five lots of material were sent to the Museum for examination and report by members of the staff, and 4,306 duplicate specimens were distributed for educational purposes.

The great mass of material for the Museum's collection of objects relating to the World War filled the space allotted to it in the Arts and Industries Building and overflowed into the Natural History Building and the Aircraft Building. This great collection, made possible through the hearty cooperation of the War and Navy Departments, contains material relating to practically every phase of the war, both on land and sea. The Navy furnished much interesting material relating to submarine warfare and other naval activities during the war, and the War Department assembled and deposited in the Museum exhibits illustrating military operations in every branch of the service, including the Air Service, Ordnance, Chemical Warfare, Quartermaster, Engineer, Medical, and Signal Corps. A full account of this valuable and instructive collection is given in the report of the administrative assistant in charge of the Museum, in an appendix to this report.

Additions to the collections in the division of history include 226 complete uniforms of the types worn in the United States Army from 1776 to 1909; miscellaneous scientific apparatus used by Joseph Henry (1799-1878) during the latter part of his life, the gift of his daughter, Miss Caroline Henry; watches owned by Maj. Gen. George B. McClellan, United States Army; swords and other military relics of Maj. Gen. John R. Brooke, United States Army; and many other objects of historical interest and value.

In anthropology the most noteworthy accessions were some valuable ethnological material collected during the period of military occupancy of the Philippines; collections made by members of the staff of the Bureau of American Ethnology, and transferred to the Museum; and a collection of nearly a hundred objects of Christian and Buddhist religious art in wood, copper, bronze, and silver.

The department of biology showed very gratifying results both in number of specimens and in the scientific importance of the material received. Through the liberality of Mr. B. H. Swales, no less than 163 species of birds new to the Museum's collections were among the year's accessions and, with the continued assistance of Dr. W. L. Abbott, 240 mammals and 228 birds from Australia were received as a first installment of a collection being made there by Mr. Charles M. Hoy. A large number of specimens were received during the year as a result of the Collins-Garner French Congo expedition. The divisions of insects and mollusks received important additions, and the botanical material accessioned during the year included valuable collections from all over the world.

In geology there was a decided increase over the previous year, both in number of specimens and in their scientific value, including many thousands of specimens of minerals and invertebrate fossils received from the United States Geological Survey. The collection of gems was overhauled and reweighed, and a handbook and catalogue of them prepared, which was in press at the close of the year. One hundred sets of 85 specimens each of ores and minerals for distribution to schools were prepared.

The divisions of textiles and mineral technology received important additions, and the division of mechanical technology was entirely rearranged during the year in accordance with a new plan for making the exhibits more instructive to visitors.

The usual large number of meetings and lectures were held in the auditorium of the Natural History Building, including the annual meeting of the National Academy of Sciences. The total number of visitors during the year at the Natural History Building was 422,984 and at the Arts and Industries Building 250,982. The Museum library received during the year 1,932 volumes and 1,581 pamphlets, bringing the total number up to 56,617 volumes and 88,690 pamphlets. The publications of the Museum for the year were 3 volumes and 33 separate papers of the Proceedings; Bulletins 106 (text), 107, 108, and a small edition of 103; volume 21 of Contributions from the National Herbarium, and the annual report for 1919.

BUREAU OF AMERICAN ETHNOLOGY.

The purpose of the Bureau of American Ethnology is to contribute to our knowledge of racial culture and advance our appreciation of racial accomplishment with respect to the American aborigines and the natives of the Hawaiian Islands. Inasmuch as the material from which we may secure this knowledge is rapidly disappearing or being absorbed into modern life, it is urgent that the bureau carry on intensive work among the American Indians to preserve for posterity

the unwritten literature, languages, customs, and material culture of these most interesting people. The results of these researches are published by the bureau, and its policy with regard to publications is that they should be of such a nature that they may be studied with profit by all intelligent persons and not so technical as to be of value only to a few specialists.

Among researches along special lines conducted by the staff of the bureau may be mentioned the study of the various fibers and foods used by the Indians with the view of discovering a possible adaptation of some of these aboriginal resources to the use of the white man. A series of researches and publications on the habitations of the Indian has been inaugurated in order that they might be better known and an accurate knowledge of them disseminated. Researches on the music of the Indians have been carried on with gratifying results, the themes having been incorporated in certain cases by modern musicians in their compositions. In cooperation with the National Park Service the bureau is engaged in the excavation and repair for permanent preservation of prehistoric ruins and cliff dwellings of the Indians in the national parks and other Government reservations, such as the Mesa Verde in Colorado. These reclaimed Indian dwellings and other structures have proved to be of the greatest educational value and popular interest. During the past year the bureau excavated and repaired two of these prehistoric structures on the Mesa Verde, known as Square Tower House and Painted House, which have already cast considerable light on the ethnological problems of the region.

Work was continued by members of the staff during the year on various publications in varying degrees of completion from manuscript to final proof, and in addition field work was carried on among the Oneida Indians, the Seneca, the Tanoan and Kiowan, the Fox, the Pawnee, the Papago, the Apache, and other tribes. Also a number of archeological researches were conducted, especially in Texas and in the southwestern United States.

One annual report and 4 bulletins were issued during the year, while 14 publications were in press in various stages of completion. The library of the bureau, to which 820 books were added during the year, now numbers over 23,000 volumes and 14,000 pamphlets.

INTERNATIONAL EXCHANGES.

The number of packages handled during the year by the International Exchange Service was 369,372, weighing 496,378 pounds, an increase of 98,512 packages and 204,460 pounds in weight over the preceding year. This large increase is due to the fact that shipments have been resumed to several countries with which relations

were suspended during the war. Nevertheless the number of packages handled exceeded by over 27,000 the total during 1914, the last year before the World War.

Shipments are still suspended to certain countries where internal conditions are unsettled or with whom peace treaties have not yet been ratified by the United States. An exchange of publications has been inaugurated with the Czechoslovak Republic, and, as soon as conditions warrant, it is expected to take the same step with the Polish Government. The prompt dispatch of foreign exchanges was considerably hampered at times during the year by freight embargoes and marine strikes. Later, however, the official character of the exchange shipments put them among the classes of freight exempt from the embargoes.

The Exchange Service continues to be of use in securing for establishments in other countries collections of scientific or other documents in this country. As an instance of this service, considerable material bearing on American universities and on the methods of government in American municipalities was collected and forwarded to the counselor in charge of foreign relations of the municipality of Prague, at his request.

For transmission to foreign countries there were received during the year 56 full sets of United States official publications and 37 partial sets, in exchange for which this country receives the official publications of these various countries. Two new depositories to receive the official documents were added during the year, Czechoslovakia to exchange full sets and the State of Rio de Janeiro, Brazil, partial sets.

NATIONAL ZOOLOGICAL PARK.

The congressional appropriation for the maintenance of the National Zoological Park was the same for the past fiscal year as for the preceding year, and with the constantly increasing cost of practically all supplies used at the park it was impossible to spend more than a small part of the amount for repairs and improvements. Only the most urgent of the needed improvements were completed, among them a public-comfort station at the Harvard Street entrance; nine new inclosures of iron framework covered with heavy mesh wire for strictly outdoor animals, such as pumas, leopards, lynxes, and others; and some necessary minor improvements, such as new concrete steps, drainage gutters, and new fences.

Popular interest in the park continues to increase, the total number of visitors during the year being 2,229,605, the largest yearly attendance ever recorded. The educational value of the zoological collec-

tion is emphasized by the fact that 98 schools and classes, comprising about 9,000 individuals, visited the park during the year.

The number of animals in the collection at the close of the year was 1,427, representing 419 species. Of this total, 496 were mammals, 847 birds, and 84 reptiles. While this number is 124 under the record year, nevertheless the monetary and scientific value of the collection is much greater than ever before. Specially interesting among the 127 animals presented to the park during the year were a number of accessions from South America, including the rare black-headed ouakari monkey, two snowy egrets, a scarlet ibis, a specimen of the rare matamata turtle, a white-backed trumpeter, the most important addition to the bird department during the year, a Mexican kinkajou, and other rare South American species. The most interesting among the animals born in the park is a hippopotamus, which attracts much attention from visitors.

It is gratifying to be able to report that the sundry civil act for 1921 carries an appropriation of \$80,000 for the purchase of a frontage of 625 feet on Connecticut Avenue, which will enable the park to have a dignified approach at this important entrance without the danger of encroachment by private dwellings or other buildings. Among the important needs of the park the superintendent mentions, in an appendix to this report, a suitable public restaurant for the increasing number of visitors, the purchase of a narrow strip of land between the park boundary and Adams Mill Road near the southeastern entrance, outdoor inclosures for lions, tigers, and certain other animals, and increased compensation for certain of the employees, particularly keepers and policemen.

ASTROPHYSICAL OBSERVATORY.

The work of the observatory at Washington consisted largely of preparation of tables of results for publication in Volume IV of the *Annals of the Astrophysical Observatory*, and of reducing the 1919 observations made at Mount Wilson and comparing them with those obtained by the Smithsonian observers in Chile. The agreement between the two sets of results, after allowing for systematic errors, was excellent, the average deviation of the two stations for 50 values obtained on corresponding days being only 0.013 calories, or 0.65 per cent. A remarkable confirmation of the variation of solar radiation on the earth was given by photo-electric observations on the planet Saturn by Dr. Guthnick, of the Berlin-Babelsberg Observatory. Variations in brightness of that planet were shown which were found to be in almost exact correlation with variations of the solar radiation on the earth as observed at Calama, Chile. This comparison indicates that the variation of the solar radiation is due to rays from

the sun of unequal brightness, which, rotating with the sun, strike the various planets successively in the order of their longitudes, and fall one after the other upon the earth as the sun by rotation brings them into line with us.

A new instrument for measuring nocturnal radiation, devised by Messrs. Abbot and Aldrich and constructed at the observatory instrument shop, was successfully tried during the year. It is provisionally called the "honeycomb pyranometer." The instrument is almost as sensitive as a flat blackened strip and, moreover, has the valuable property of being fully absorbing, which a strip has not. It is an instrument of great promise for standard measurements of various kinds of radiation.

Through the generosity of Mr. John A. Roebling, of New Jersey, it was made possible to move the Smithsonian observing station previously located on the plain near Calama, Chile, to a near-by mountain above the interference of dust and smoke. With the remainder of Mr. Roebling's grant it is proposed to establish a new observing station on the Harqua Hala Mountain, in Arizona, one of the most cloudless regions in the world. The establishment of these two stations so widely separated from one another will make it possible to obtain nearly every day in the year check observations of the solar constant of radiation, laying a firm foundation of solar observations from which meteorologists will be able to determine whether the variations in the sun are of value, as present results indicate, in forecasting weather conditions. However, with the limited funds at his disposal, Doctor Abbot found it necessary to transfer apparatus from the Mount Wilson station to the new Harqua Hala station, and he urges in his report that Congress appropriate sufficient money to provide for independent observing equipment for both stations and for needed improvements to the Arizona station.

INTERNATIONAL CATALOGUE OF SCIENTIFIC LITERATURE.

The United States Regional Bureau of the International Catalogue of Scientific Literature is intrusted with the duty of collecting, indexing, and classifying titles of all scientific papers published in the United States to form part of the International Catalogue issued by a central bureau in London.

The enterprise was begun in 1900, and published annually 17 volumes up to 1913. Fifteen volumes for the year 1914 have been printed, and much of the material for the fifteenth issue is now in the hands of the central bureau, its publication being delayed by financial difficulties brought about by the war. A conference has been called by the Royal Society in London, September 28 next, to

consider the future of the catalogue and to discuss means for meeting this financial deficit.

The aim and purpose of the International Catalogue was to meet the demands of scientific workers for an annual authors' and subject catalogue to the current literature of science. A general revision of the classification schedules which form the key to the subject catalogues is now needed and, in view of the present apparent demand for abstract journals, it is to be hoped that when these improvements are considered arrangements may be made to cooperate with the bodies now preparing and publishing abstracts to scientific literature.

It would seem that the pressing demand for such abstract journals, now evident in the United States, should be recognized internationally. This institution would, therefore, favor any feasible plan to bring the present influential organization of the International Catalogue of Scientific Literature, already recognized and supported by practically all the countries of the world, into close cooperation with existing abstract journals and to encourage the establishment of abstract journals covering those branches of science not already represented.

NECROLOGY.

STEPHEN C. BROWN.

Stephen C. Brown, who for more than 40 years had held the position of registrar of the National Museum, died on July 11, 1919. At a meeting of his associates in the Smithsonian and Museum, held the following day, many of Mr. Brown's friends expressed the high esteem and admiration in which he had been held and their sorrow at his loss.

R. LUTHER REED.

R. Luther Reed, an employee of the Institution since 1880, died on April 26, 1920. He was foreman of the Museum carpenter shop until the Zoological Park was established, where he served until brought back to the Institution by Secretary Langley to work on his aerodromes. Mr. Langley has expressed in his publications his appreciation of Mr. Reed's skill and efficient service in that connection.

Respectfully submitted.

CHARLES D. WALCOTT, *Secretary.*

APPENDIX 1.

REPORT ON THE UNITED STATES NATIONAL MUSEUM.

SIR: I have the honor to submit the following report on the operations of the United States National Museum during the fiscal year ending June 30, 1920.

The year witnessed very little change in the organization of the United States National Museum. The congressional appropriations for the maintenance of the Museum remaining practically stationary for many years has not only prevented the Museum from engaging in new lines of work offering exceptional opportunities at this time but has allowed it to carry forward existing work only by the use of the strictest economy. The Museum has been unable to add even a few of the experts needed to assist in the classification of specimens in the recently organized department of arts and industries as well as in the long-established natural history departments, nor has it been able to make any general advancement of salaries though greatly needed. The insufficiency of funds precludes separate staff officers for the various sections or divisions of the work, these various activities having of necessity to be placed under those curators in other lines best qualified to also handle the subjects. Thus, for instance, for administrative purposes only, the division of medicine and the section of wood technology are under the general supervision of Mr. F. L. Lewton, who is the curator of textiles, and Dr. Walter Hough, curator of ethnology, has general oversight of various other collections where there is no paid staff, especially the art textiles, ceramics, musical instruments, and the period costume collections. This arrangement is far from ideal, but it holds collections together until means are available for the needed additional experts. The item for preservation of collections, from which the scientific and clerical staffs, the watch and cleaning force, freight and cartage, and preservatives are paid, was last increased 10 years ago, just as the Museum was taking possession of the Natural History Building. Since then approximately 3,000,000 specimens have been added to the Museum.

After the death of Mr. S. C. Brown the position of registrar of the Museum was abolished and a reorganization of the work made. The records relating to accessions, material for examination and report, and to distribution of specimens were transferred to the office

of correspondence and documents, where the files of the Museum are kept, and the duties of shipping clerk were combined with those of property clerk.

The collections of echinoderms were removed from the division of marine invertebrates, a separate division of echinoderms being established and Mr. Austin H. Clark promoted from assistant curator of marine invertebrates to curator of echinoderms and placed in charge. As he had devoted much time to the onychophores, they were included in the new division. At the close of the year the division of graphic arts was transferred from the department of anthropology to that of arts and industries.

The sundry civil bill for 1921 carries a small appropriation for the National Gallery of Art. For economic reasons the gallery has up to now been administered as an integral part of the Museum, the scientific and administrative staffs of which have cared for the gallery in addition to their own regular Museum duties. This appropriation will permit of the gallery being separated from the Museum on July 1, 1920, and organized as an independent bureau under the Smithsonian Institution, and to it will be transferred the fine art collections of the Museum which have heretofore been administered under the curator of the National Gallery of Art. The gallery will for the present, however, continue to be housed in the Natural History Building of the Museum.

The year has witnessed the bringing together here of large war collections, made possible by the hearty cooperation of the War and Navy Departments. Besides supplying the objects, they transported them without cost to the Museum, set them up in the Museum buildings, and in many instances detailed officers and men to assist in labeling and otherwise preparing them for exhibition.

COLLECTIONS.

The total number of specimens acquired by the Museum during the year was approximately 216,871. Received in 1,480 separate accessions, they were classified and assigned as follows: Department of anthropology, 15,254; zoology, 101,554; botany, 35,211; geology and mineralogy, estimated, 22,400; paleontology, estimated, 40,000; textiles, woods, medicines, foods, and other miscellaneous animal and vegetable products, 1,716; mineral technology, 627; mechanical technology, 97; and National Gallery of Art, 12. Loans and deposits for exhibition added 8,348 more, chiefly in the division of history, war collections.

Material to the extent of 495 lots was received for special examination and report. While this free identification of material sent in from all parts of the country requires considerable time on the part

of specialists, it is not without advantage to the Museum in furnishing occasional desirable specimens and in recording new localities.

The distribution of duplicates for educational purposes, mainly to schools and colleges, aggregated 4,306 specimens.

Material sent out to specialists for study on behalf of the Museum amounted to 13,838 specimens, mainly biological.

War collections.—Through cooperation of the Navy and the War Departments, the stream of material reaching the Museum illustrative of the World War filled the quarters assigned to the division of history in the Arts and Industries Building, overflowing into the Natural History Building and the Aircraft Building.

Prior to July, 1919, very little material had been received illustrating the work of the Navy during the World War, with the exception of some uniforms of the Marine Corps and the insignia of its various branches. At that time it was decided to assign the rotunda of the Natural History Building for this purpose, and Lieut. Commander L. P. Warren was designated on the part of the Navy Department to take charge of this work. A number of exhibits were received during the year, the most important of which are a paravane, which is a device attached to battleships for the purpose of destroying mines; an anti-aircraft gun and a Y depth charge gun for destruction of submarines; a collection of British naval airplane bombs, a large number of relics from the sunken battleship *Maine*, a 1-pound gun, a German torpedo 18 feet long, a Davis gun for airplanes, a naval range finder, and the large 6-inch naval gun which fired America's first shot in the World War. Owing to its great weight this gun was placed on the east driveway, where it makes a most impressive exhibit.

The War Department continued its generous cooperation by contributing material illustrating the military activities of the United States, the Allies, and the enemy countries in the following branches: Air Service, Ordnance, Chemical Warfare, Quartermaster, Engineer, Medical, and Signal Corps. The material was selected especially for the Museum with a view to illustrating graphically the military history of the war for the benefit of the public and for historical and scientific research.

From the Air Service came military airplanes showing types of machines used by the United States, France, and Germany, including a De Haviland-4, tractor biplane of type originally developed by England and later adopted by the United States for observation and day bombing purposes; a Le Pere tractor biplane of type developed by the United States Air Service during the war for fighting purposes; a Martin bomber, twin tractor biplane of type developed by United States Air Service for bombardment purposes; a Spad, XVI, tractor biplane of type developed and used by French for recon-

naissance purposes; another Spad, XIII, tractor biplane of type developed and used by France (this airplane, which was part of the Twenty-second Aero Squadron, Air Service, American Expeditionary Forces, has seven victories to its credit, and is of the same type as those with which the famous French flyers Fonch and Guynemer and the American flyer Rickenbacker made a great part of their records); and a Fokker, D-VII, tractor biplane developed and used by the German air service for pursuit purposes. This plane was captured at Verdun by Capt. H. McLanahan and Lieuts. E. Curtis and S. Sewall, of the First Pursuit Group, Ninety-fifth Aero Squadron, United States Army, Capt. J. Mitchell commanding.

The Ordnance Department and the Quartermaster Corps supplied ordnance equipment of the type used by the various armies for offensive and defensive purposes, small arms of type used by the United States during the war, rifles, pistols, and swords illustrating the types of weapons used during the World War by the various armies, including the rifles used by the armies of Austria, Belgium, England, France, Japan, Italy, Germany, Russia, Roumania, and Serbia. Of more than passing interest were specimens of silk cartridge cloth used by the United States Army for powder bags for loading the large guns and samples of the same material adapted for civilian use.

Of enemy material the Ordnance Department transmitted a large and interesting collection of German and Austrian equipment captured by the American Expeditionary Forces. This included field, machine, anti-aircraft, and anti-tank guns; field kitchen; various other vehicles, and miscellaneous commissary, infantry, artillery, cavalry, and signal equipment, some made of paper.

From the Chemical Warfare Service came offensive and defensive equipment used in the chemical warfare by both the armies of the allied and enemy countries, including shells, bombs, projectiles, smoke producers, masks, special clothing, and alarm; in each case also nearly complete series showing the development of such objects from their earliest form to the most recent.

The Corps of Engineers contributed a collection illustrating the important part played in modern warfare by that branch of the Army, including examples of tools and small equipment and of the large instruments peculiar to the work of the corps which so greatly aided in winning the war. Particularly interesting are a parabolic listening device; sound and flash ranging sets for locating the position of enemy batteries; examples of the high-intensity electric-arc and the open-type searchlights; models showing the use of camouflage material in trench warfare with dummy silhouettes of soldiers to draw machine-gun fire; representation of standard type trench

and shelter-cave chamber; models of bridges, pontoon boats, and wagons, and a camouflaged-gun position.

Other contributions, through the Quartermaster Corps, added uniforms and insignia fully representing the uniform and individual personal equipment worn by officers and enlisted men of the following countries and the colonial possessions of each: Belgium, France, Great Britain, Italy, Japan, Austria, Germany, and Turkey. This series forms a marvelously complete collection and will be a priceless source of information for historical purposes.

The Medical Department completed the extensive series begun last year of objects illustrating the work of that branch of the United States Army, and it was duly installed this year under the supervision of Mr. F. L. Lewton. The field equipment included first-aid kit and emergency belt worn by all enlisted men in the Medical Corps, field operating table, instruments, dressings, and other supplies, complete portable and the emergency dental outfit for carrying in hand, field kitchen, disinfector, sterilizing outfits, litters, ambulances, etc. The base hospital material for exhibition was grouped as follows: The X-ray laboratory, showing all important fixed and movable types of X-ray equipment; the hospital ward of three beds, with various equipment; general operating room of a military hospital; anæsthesia room; eye, ear, and throat clinic; fracture room; dental clinic; sterilizing room; bacteriological laboratory; serological laboratory; pathological laboratory; and chemical laboratory.

The pictorial material of the war collections was increased by a series of nearly 500 drawings and paintings by the official artists of the American Expeditionary Forces, which were installed in rooms 45, 46, and 47 of the Natural History Building. To the numismatic section of the war collections was added a collection of representative war decorations and medals of Great Britain, France, Italy, Germany, Austria, and Turkey, and a series of bronze and silver commemorative medals issued by Belgium, France, Great Britain, Greece, Holland, Italy, Montenegro, Rumania, Russia, and Serbia in commemoration of notable events during the war.

The National Society of the Colonial Dames assisted also in building up the war collections by lending a very interesting and striking series of uniforms of the types worn by American women members of war organizations.

The space assigned to the war collections was increased early in the year by two large ranges on the ground floor of the Natural History Building. In one was installed the collection of foreign uniforms, insignia, and decorations worn by the armies of the Allies and the enemy countries and the captured German military equip-

ment, for which the Museum was indebted to the Quartermaster General of the United States Army, Maj. Gen. H. L. Rogers. In the second range were placed the collections of chemical warfare and ordnance material. The west and central portion of the foyer of this building was given over to the Corps of Engineers for its exhibit; a portion of the foyer and three rooms on the east to the exhibit of the Medical Department; and the walls of three rooms on the west of the foyer to the pictorial material. In the Arts and Industries Building were placed on display captured German ordnance material, small arms of the Allies and enemy countries, American ordnance equipment, and the collection of uniforms worn by the women's organizations. Out of doors, on the west side of this building, were placed the German field guns, and the airplane exhibit is being assembled in the Aircraft Building.

The War Department rendered great assistance in putting this material on display, without which the Museum could have made little progress, the small force of the division of history being entirely inadequate to the huge task. Special credit is due to Capt. J. J. Hittinger, of the Quartermaster Corps, who continued on detail to the Museum throughout the year, giving general supervision to the assembling and installation of material; to Maj. John McLaren in connection with the ordnance section; to Capts. E. W. Jepson and J. E. Costello and Sergt. Burns A. Stubbs under Lieut. T. N. Ellman as to material from the Corps of Engineers; and to Capt. A. P. Mooradian, who planned and supervised the wiring and setting up of the equipment of the X-ray laboratory in the exhibit of the Medical Department, all of which is operative.

History.—In other lines than the war collections the Museum acquired much material of value and interest. In American history the additions included a large collection of uniforms of the types worn by the armies of 23 foreign countries prior to the World War; 226 complete uniforms of the types worn in the United States Army from 1776 to 1909; material relating to the career of Cyrus W. Field and the laying of the first Atlantic telegraph cables; miscellaneous scientific apparatus used by Joseph Henry (1799–1878) during the latter part of his life, the gift of his daughter, Miss Caroline Henry; watches owned by Maj. Gen. George B. McClellan, United States Army; swords and other military relics of Maj. Gen. John R. Brooke, United States Army; mementoes of Susan B. Anthony and objects illustrating the history of the women's suffrage movement in the United States from 1848 to 1919; and for the series of costumes of mistresses of the White House, a black velvet dress worn by Mrs. Woodrow Wilson, and a lace flounce completing the inaugural dress of Mrs. James A. Garfield. The philatelic material was increased by 5,872 specimens, of which 4,345 were transferred from the United

States Post Office Department, and of these 2,475 are examples of new issues reaching that department from the International Bureau of the Universal Postal Union.

Anthropology.—The small number of accessions received in the division of ethnology shows markedly the rapid decline of Indian material and a corresponding though less rapid disappearance of material from races less modified by contact with the white man. The receipts included western Indian baskets donated by Miss Ella F. Hubby; valuable material collected during the period of military occupation of the Philippines received as gifts from Mrs. Thomas F. Dwyer and Miss Kline, Gen. Joseph C. Breckenridge and the late Lieut. Col. Duncan Elliott, United States Army; and pottery and objects in silver, pewter, and brass bequeathed to the Museum by Miss Elizabeth S. Stevens.

The division of American archeology reports its yearly increase due largely to contributions from the Bureau of American Ethnology, including collections made in Arizona, Utah, and Colorado by Dr. Walter Hough; in Texas by Dr. J. W. Fewkes and Prof. J. E. Pearce; in Missouri by Mr. Gerard Fowke; and in Utah by the curator, Mr. Neil M. Judd. The bureau also transferred a collection of archeological specimens obtained by it as a gift from the Otto T. Mallory expedition.

The collections in Old World archeology benefited, too, by the bequest of Miss Elizabeth S. Stevens, receiving nearly a hundred objects of Christian and Buddhist religious art in wood, copper, bronze, and silver. Other additions included ancient coins from Capt. Clarence L. Wiener; casts of engraved antique gems from Dr. William H. Dall; and casts of oriental seals made in the Museum from originals owned by Mrs. Talcott Williams. The collection of Bibles was supplemented by the two copies of the New Testament in English from which Thomas Jefferson cut the English version of his *The Life and Morals of Jesus of Nazareth*, the so-called Jefferson Bible, donated by Miss Bertha Cohen and her nieces.

In physical anthropology the most important accessions were skeletal material, as follows: From New Mexico, gift of the Museum of the American Indian, Heye Foundation; from Nevada, donated by Hon. William Kent; from Tennessee and Kentucky, partly gift and partly a loan from Mr. W. E. Myer; from Missouri, collected by Mr. Gerard Fowke; and from Arizona, collected by Dr. Walter Hough, transferred to the Museum from the Bureau of American Ethnology. A Neolithic skull was received in exchange from the University of Liege, Belgium, and a plaster bust representing a form of early man by purchase. The trip of the curator, Dr. Aleš Hrdlička, to the Far East added to the collections some 2,000 portraits of peoples of that locality.

Mr. Hugo Worch contributed three pianos and a harpsichord to the series he is building up here representing the history of the pianoforte, and from Mrs. J. Ryan Devereux came a noteworthy collection of 81 musical instruments of various types.

The additions in graphic arts included a collection of several hundred specimens of wood engravings, mezzotints, aquatints, etc., donated by Mr. Earle W. Huckel; miniature mosaics from Mr. Stockton W. Jones, showing a method of making pictures not heretofore represented in the division; saphiograph reproductions from the Crane Lithograph Co.; and American-made vellum from Mr. George A. Hathaway. The section of photography was enriched by photographic apparatus used by Edward Muybridge in his study of motion in animals, presented by the Commercial Museum of Philadelphia.

In the ceramic gallery loans were credited from Miss E. B. Lowe of old English porcelain, and from Miss Eliza Ruhamah Scidmore of Japanese porcelain and bronze.

Biology.—The additions to the biological collections aggregated approximately 136,765 specimens. Not only was the year numerically a very prosperous one, but the reports of the curators show a gratifying increase in the scientific importance of the material received. This is particularly true of the division of birds, in which no less than 163 species new to the collection were among the accessions. This splendid result was to a great extent due to the liberality of Mr. B. H. Swales, of Washington, D. C., who placed a fund at the disposition of the Museum for this particular purpose. No less important was the material received through the continued generosity of Dr. W. L. Abbott. Impressed by the importance of securing for the Museum an adequate representation of the fast disappearing higher vertebrate fauna of Australia, he granted the means to send Mr. Charles M. Hoy to that Continent for the purpose of collecting especially mammals and birds. No less than 240 specimens of the former and 228 of the latter from a region hitherto very poorly represented in the national collection are contained in this first installment. Dr. Abbott's personal explorations in Haiti have also yielded very important additions. A third expedition was of particular interest as supplementing our African collections, which were hitherto confined chiefly to the eastern side of the Continent, viz, the Collins-Garner expedition to the French Congo. More than 2,350 mammals, birds, reptiles, fishes, and invertebrates were thus added, among them 2 gorillas, 2 chimpanzees, 2 buffalos, etc. The first installment from another African expedition, carried out by the Institution in conjunction with the Universal Film Co., contained 239 mammals and birds from southern Africa, still further contributing to the excellency of our series from the dark continent.

Among the large collections of insects acquired, the following are especially noteworthy: Mr. B. Preston Clark presented 5,500 lepidoptera of the Hawaiian Islands and South America. Similarly Dr. William Barnes donated 2,000 moths, including 60 types, and 150 butterflies. From Dr. W. M. Mann, through the Bureau of Entomology, the Museum received 6,000 insects of various orders, collected by him in Honduras, and similarly from Dr. E. A. Schwarz a collection made in Florida of 5,770 miscellaneous insects. Besides 6,930 specimens transferred by the Department of Agriculture, numerous accessions were received from Costa Rica, Australia, South Africa, Mexico, etc.

The mollusk collection was the recipient of two particularly valuable and important gifts, namely, the collection of Hawaiian marine shells donated by Mr. D. Thaanum and a part of the William F. Clapp collection of New England land and fresh-water mollusks, about 10,000 specimens purchased and presented by Mr. John B. Henderson. The former, consisting of about 5,000 specimens collected by Mr. Thaanum and Mr. J. B. Langford, has long been known as the best existing collection of authentically located marine Hawaiian shells. As in previous years, the Bureau of Fisheries forms one of the chief sources of our material of marine invertebrates, including specimens collected during the cruises of the *Albatross* and the *Bache* reported on by Mr. Sasaki, Dr. A. L. Treadwell, and Dr. H. B. Bigelow. Numerous other accessions from collectors and collaborators were remarkable for the great number of types of new species added during the year.

The botanical collections accessioned included highly valuable material from all over the world. Besides important North American collections, there are represented plants from Mexico and Central America, Colombia, British Guiana, Brazil, Argentina, Europe, Africa, China, Sumatra, etc. The Department of Agriculture transferred 8,190 specimens, mostly the result of field work of the Bureau of Plant Industry. The Forestry Commission of the Mexican State of Sinaloa transmitted 887 specimens from little known parts of that State. A large number of plants were obtained in exchange, the largest lot consisting of 2,398 specimens received from the New York Botanical Garden, mostly plants collected in Colombia by Rusby and Pennell. Likewise in exchange there were acquired from the Botanical Museum of the University at Copenhagen 923 specimens of Mexican and Central American plants, chiefly material collected a long time ago by Liebmann and Oersted, and therefore of unusual historical interest and value.

Geology.—The additions to the collections in the department of geology during the year were 180 lots against 135 for the year previous, with a decided increase in the number of specimens and their

scientific value. Of these accessions, 111 were gifts, 32 transfers, 25 exchanges, 2 were collections by members of the force, 1 received as a deposit, and but 9 acquired by purchase. Among those of greatest importance were gifts comprising ores of the rare metals, particularly tungsten and molybdenum, secured chiefly through Mr. Frank L. Hess, of the United States Geological Survey, an honorary custodian in the Museum. The donors included Mr. C. W. Purington, Vladivostok, Siberia; Mr. J. G. Hibbs, Denver, Colorado; the Homestake Mining Co., Lead, South Dakota; the R. & S. Molybdenum Co., Questa, New Mexico; and the Molybdenum Mines Co., Denver. Other important additions were made by Dr. J. Morgan Clements, of New York, traveling in China in the interest of the Federal Trade Commission, and Mr. M. L. Patterson, manager of the Thabawleik Mines, Mergui, Burma.

An excellent series of crystallized native copper and silver minerals from the Lake Superior region was acquired by purchase and gift, and a large slab of native copper, simulating in outline the continent of South America, was received from the Bolivian delegates to the Second Pan American Financial Conference.

The meteorite collection was enriched by examples of the following stones: Colby, Wisconsin, 3,642 grams; Bjurbole, Finland, 2,500 grams; Washington County, Kansas, 2,003 grams; Kesen, Japan, 1,397 grams; and Appley Bridge, 598 grams. In addition there was acquired 3,320 grams of an iron from Yenberrie, Australia.

Valuable collections in the form of minerals and invertebrate fossils, comprising many thousands of specimens, were received from the United States Geological Survey, as was also a large series of igneous rocks from the Yellowstone National Park, described by Dr. J. P. Iddings in volume 32 of its monographs.

Large collections from the West Indies, particularly from the Dominican Republic, have been added to the series of invertebrate fossils, which have been further augmented by some 10,000 specimens from the Upper Cambrian of Wisconsin.

To the exhibition series have been added a large and unique specimen of trilobite, the largest American form in existence, which was found during excavations in connection with the conservancy dam at Dayton, Ohio; a mounted skeleton of the large, extinct mammal, *Brontotherium hatcheri*; the sea-living lizard, *Tylosaurus proriger*; and a diminutive camel *Stenomylus hitchcocki*. The study collections in vertebrate paleontology were augmented by a considerable number of type specimens, deposited by the Maryland Geological Survey, which, though fragmentary, are of primary interest. Of equal importance are gifts of Pleistocene bones and teeth from a cave near Bulverde, Texas, donated by Dr. O. P. Hay, and similar material from Cavetown, Maryland, gift of Phillips Academy, Andover, Massachusetts.

The gem collection has been thoroughly overhauled, reweighed, and recatalogued, and a handbook and catalogue of the same prepared, the manuscript of which is now in the hands of the Government Printer.

The work of preparing 100 sets of 85 specimens each of ores and minerals for distribution to schools, mentioned in the report of last year, has been completed and the sets are now ready as occasion shall demand.

Textiles.—The collections under the supervision of the curator of textiles, which, besides textiles, embrace medicine, food, wood technology, and miscellaneous animal and vegetable products, were increased by many gifts and by transfer from other Government bureaus amounting to about 2,000 objects. The most important of these are as follows: The division of textiles received for exhibition from the Department of Ordnance, War Department, specimens of the silk cartridge cloth which was so essential in the preparation of separate loading ammunition for all the large guns taking part in the World War; also examples of this same fabric showing the results of the experiments made to demonstrate the value for civilian uses of the 11,000,000 yards sold as surplus material. There were added by gift many specimens of knitted fabrics contributed by American manufacturers, and made from artificial silk, wool, and mohair.

Medicine.—The collections in the division of medicine were enlarged by a series of pharmaceutical preparations illustrating the various forms in which medicinal substances are prepared for administration, a series of essential oils, and an addition to the materia medica collections of a large number of inorganic chemicals. The exhibits planned to illustrate the basic principles of different schools of medicine were increased by many gifts, and the one devoted to homeopathy completed. The section of pharmacy received many documents and publications bearing on the history of the United States Pharmacopoeia and the complete series of written and printed records of the last revision of this important work, amounting to many thousands of pages.

Wood technology.—The exhibition collections of the section of wood technology were much improved by a transfer from the Forest Service of 25 colored transparencies and 48 colored bromide enlargements specially prepared for the National Museum, representing typical forest scenes, methods of lumbering, and forest industries, and by the gift of exhibit material illustrating the use of wood waste and wood pulp.

Animal and vegetable products.—Many specimens of edible and inedible oils developed as a branch of the meat-packing industry, and

samples of the official tea standards used from 1915 to 1920 to control the quality of the foreign teas imported by the United States were added to the collections of animal and vegetable products.

Mineral technology.—In the division of mineral technology the principal addition was a working model of a salt works, donated by the Worcester Salt Co., being a replica of that company's operations near Warsaw, New York. A system of circulating water is caused to mine the native salt, bring it in solution to the surface, and finally to surrender it, the whole taking place before the visitor's eyes. The National Lead Co. contributed 26 large transparencies and about 600 exhibition samples needed in completing the comprehensive exhibit illustrating the lead industry undertaken several years ago and which now lacks only competent technical direction in installation. The work of the division was largely at a standstill by the transfer elsewhere in the Museum at the beginning of the year of one of the members of its scientific staff and the resignation soon afterwards of the remaining two members. Mr. Gilbert, after severing active relations, continued under appointment on an honorary basis to give advisory supervision over these collections, all of which had been developed under his direction. It is hoped another year will find this division manned and again to the front, as it was so signally during the period of the war.

Mechanical technology.—Probably the most important addition to the collections of the division of mechanical technology during the year was a 12-cylinder Liberty airplane motor, the gift of the Lincoln Motor Co., various portions of which are cut away to show the interior parts in operative relation. Another accession of note was a replica of the original typewriter, invented and patented by William Austin Burt in 1829, donated by his grandson, Mr. Hiram Austin Burt. As representative of the early beginnings of the American typewriter this forms a very important addition to the exhibit, showing the development of the typewriter. The time-keeping collections were enhanced by the gift of two watches from Mr. George W. Spier, honorary custodian of watches. In the section of marine transportation there was added a model of one of the freight ships built at Hog Island Shipyard in 1919, received from the United States Senate Committee on Commerce, through Senator Wesley L. Jones, chairman.

Early in the year plans for the future development of the division of mechanical technology were formulated, the end in view being a museum of engineering. Accordingly, the collections in care of the division were first rearranged in the halls, the basis of rearrangement being the kind of object rather than the source; thus, one hall now includes all objects relating to land and aerial trans-

portation; another hall, marine transportation; and another hall, metrology and mechanical transmission of intelligence.

NATIONAL GALLERY OF ART.

The National Gallery of Art—the department of fine arts of the Museum—continued in charge of Dr. W. H. Holmes, as curator, the collections occupying mainly the central skylighted hall on the first floor of the north wing of the Natural History Building. The additions while not numerous comprised works and objects of very considerable museum value, not, however, comparable in importance with the accessions of the year before. Of the works of painting and sculpture added, the most noteworthy, perhaps, was a statue in white marble of the Earl of Chatham (William Pitt), by Francis Derwent Wood, R. A., the gift of the Duchess of Marlborough and other American women in Great Britain.

During the year four paintings were purchased from the Henry W. Ranger fund, two of which, *Grey Day*, by W. Granville-Smith, N. A., and *Evening Tide*, California, by William Ritschel, N. A., are now on view in the gallery; the others are *The Rapids*, by W. E. Schofield, N. A., deposited in the Brooklyn Museum, and the *Orange Bowl*, by Anna Fisher, the assignment of which has not yet been announced. It is gratifying to know that by this bequest the gallery is assured of a number of worthy additions each year.

During the year the Rev. Alfred Duane Pell continued to add to his collection of art objects presented and lent to the Museum and installed in the long room at the north end of the gallery. The installation was not complete at the close of the year.

The preparation of a catalogue of the gallery bringing the record up to date was carried to practical completion. The last issue of the catalogue, prepared by Assistant Secretary Rathbun, is dated 1916, and it is regarded as important that a new edition be printed as soon as practicable.

It is a matter of particular felicitation that in June Congress granted a fund sufficient to permit the organization of the Gallery as a separate unit of the Smithsonian foundation and to provide a modest curatorial staff, thus relieving the Museum of a rapidly growing burden and at the same time affording the long-delayed opportunity of laying the foundation requisite to a reasonable and symmetric development of the Nation's Gallery of Art.

FREER COLLECTIONS.

The death of Mr. Freer this year is a great loss to the art interests of the country. In presenting his collections of American and oriental art to the Smithsonian Institution in 1906, Mr. Freer stipulated

that they should remain in his possession during his life, and at that time he provided in his will \$500,000 for the erection by the Smithsonian Institution of a suitable building for housing them, near the National Museum. He reserved the right to add to the collections, and in the intervening years he has about tripled the number of objects originally transferred by title to the Institution. Increasing the building fund to \$1,000,000 and waiving the original conditions, Mr. Freer in 1915 decided upon the early erection of the structure and the transfer of the collections to Washington. The building, now nearing completion, was accordingly begun in the autumn of 1916. That Mr. Freer was not permitted to see the consummation of his plans for the development of the art interests of the country is greatly deplored. His experience and advice would be invaluable in inaugurating this independent unit of the National Gallery of Art which he so generously provided. The building and collections represent an outlay of some six or seven million dollars and constitute one of the most important and valued donations which any individual has ever made freely and unconditionally to the Nation.

During the year the building for the Freer collections was brought nearly to completion, despite delays now characteristic of the building business. The central court was carefully laid out with walks, gardens, and fountain. Arrangements were made with the officer in charge of public buildings and grounds for laying out the driveways to the building and otherwise improving the grounds immediately surrounding it.

The Peacock room, that celebrated decoration executed by Whistler as a setting for his painting *La Princesse*, was transferred from the residence of Mr. Freer, in Detroit, and set up complete in a room specially designed for its reception at the southeastern corner of the building. By the close of the year the executors of Mr. Freer's estate had commenced to ship to Washington other portions of the Freer collections, which will be stored in the various storage quarters in the building until the structure is entirely completed and the installation of the collections can be undertaken.

THE LOEB BEQUEST.

Prof. Morris Loeb, the eminent chemist, who died on October 8, 1912, left a bequest of \$25,000 to the American Chemical Society, to be held as a special fund, the income of which should be used for the establishment or maintenance of a chemical type museum, either in connection with the Chemists' Club of New York City, or the National Museum in Washington, or the American Museum of Natural History in New York City, preference to be given in the order named. The chief object of the museum was to be the preservation



THE FREER GALLERY OF ART.

of all new substances described as the result of chemical research, either by obtaining the same by gift or purchase from the discoverer or by causing the same to be prepared in sufficient quantity according to the discoverer's published directions—all for the purpose of facilitating comparison by subsequent observers.

The Chemists' Club of New York accepted the trust, but being unable to comply with the conditions in the Loeb will, offered to give up their claim, and the Institution indicated its willingness to accept the responsibility, through the National Museum. The fund should hereafter yield an annual income of about \$1,155, though the amount for the calendar year 1920 will be slightly less.

By means of this income from the Morris Loeb fund, the Smithsonian Institution proposes to build up in the National Museum "the Loeb collection of chemical types," a permanent reference or study collection of new substances and original material resulting from chemical research. Steps will be taken to secure a competent advisory committee composed of eminent chemists of the country to advise on the policy to be pursued in dealing with investigators desiring the use of portions of type material in the Loeb collection.

The general scheme has the sanction of various governmental chemists, and the Bureau of Chemistry, Department of Agriculture, favoring the establishment of such a collection under the Museum as the proper place for a national collection, offers hearty cooperation, placing at the Museum's disposal in developing this project any of the bureau's resources in the way of personnel, equipment, and supplies.

It is hoped shortly to reorganize the division, or section, of chemical industries, in the department of arts and industries, begun in 1886. Insufficiency of funds prevents this being done at once. In the meantime the Loeb collection, as well as other chemical specimens which the agitation of this subject will doubtless bring to the Museum, will be cared for under the direction of one of the curators in arts and industries.

BUILDINGS AND EQUIPMENT.

The first deficiency act for 1920 included an item of \$5,640 for placing the Natural History Building in the same condition as it was when occupied by the Bureau of War Risk Insurance in October, 1917. This permitted the pointing up of the damaged plastered walls and the painting of walls, ceilings, and floors in the area occupied by the bureau from October, 1917, to March, 1919.

Other improvements in this building from the regular Museum appropriation included repairs of settlement cracks in Venetian floors in exhibition halls, the pointing up of cracks and painting the walls

and ceilings of these halls, painting walls and ceilings of comfort room and rooms 223 and 224 on third floor, painting floors in west north and west ranges, repointing open seams in the granite courses and ledges on exterior and court walls and the stone steps at south entrance, the painting of exterior surface of metal window frames of first and second stories, and painting gutters. The building in the west court was remodeled for use as a laboratory.

In the Arts and Industries Building the exterior woodwork of the windows was painted; a number of walls in the exhibition halls, offices, and laboratories were repainted, including the café; and an additional dark room was constructed in the photographic laboratory.

An improved system of ventilation was installed in the mascerating room in the south shed.

The deficiency act above referred to also provided the sum of \$14,000 to enable the regents of the Smithsonian to heat and fit up for the exhibition of aircraft and accessories the temporary metal structure erected in the Smithsonian Grounds by the War Department, with the understanding that the custody and control of the building be transferred to the regents of the Institution by the Secretary of War. Immediately after the building was turned over to the Institution in November, the old heating equipment was condemned and sold and arrangements made to heat and light the building from the power plant of the National Museum. Steam pipes were run from the Arts and Industries Building, and electric lights were provided for use on dark days and for police purposes at night.

To make the interior of the building suitable for exhibition purposes, a concrete floor was laid in place of the wooden floor, which had deteriorated to an extent that made its use impossible. The entire ceiling and side walls were sheathed, covered with wall board, and painted. Ventilators were installed at either end of the building, a concrete platform constructed at the east end of the building, and a glazed vestibule built at this end to be used as a public entrance. A combination storage, workroom, and office was partitioned off in the southeast corner and a new comfort room constructed. The doors on the north side were closed, two doors on the west side remodeled as emergency exits, and the exterior of the building was painted.

The additions to the furniture this year included 30 exhibition cases and bases, 229 storage cases and pieces of laboratory and office furniture, 198 standard unit drawers, 602 insect drawers, and 388 special drawers.

The power plant was closed for two months and eight days, during which time electric current for light and power was purchased from the Potomac Electric Power Co., under special contract made by the Treasury Department.

The changes and repairs to the plant consisted of the installation of the forced oil-feed system for the engines purchased the previous year; the purchase and installation of asbestos covers for the four boiler drums, together with the repairing of the covering on the pipes and smoke breeching in the engine room, and the purchase and installation of a new pump for removing water of condensation from the main exhaust pipe. For the first time since the installation of the plant, in 1909, it became necessary to replace the tubes in two of the boilers and also to have the main bearings of two engines rebabbitted. Though the entire plant has been operated under pressure, the deterioration is, in the opinion of the engineer, largely due to the inability of the Museum to secure competent and reliable men as stokers, firemen, and assistant engineers at the very small salaries paid.

MEETINGS AND CONGRESSES.

The annual meeting of the National Academy of Sciences was held again this year in the Museum, on April 26, 27, and 28, the auditorium and committee rooms being used, respectively, for the presentation of the scientific papers and the business sessions. On the first evening the William Ellery Hale lecture in the form of a discussion by Dr. Harlow Shapley, of Mount Wilson Solar Observatory, and Dr. Heber D. Curtis, of Lick Observatory, on the scale of the universe, was followed by a *conversazione* in the National Gallery of Art and the adjoining halls of the Museum.

Governmental, scientific, and educational organizations making use of the auditorium and the committee rooms included: The National Women's Trade Union League of America, for the First International Congress of Working Women; the Delaware River Shipbuilders' Council, for a conference of workers in various navy yards and shipyards of the United States in reference to the Government's shipbuilding and shipping program; the American Association of Anatomists, for its annual meeting; the American Association of Ichthyologists, for its annual meeting; Southern Sociological Congress; the American Association of Museums, for its fifteenth annual meeting; the United States Department of Agriculture, for a meeting of fertilizer manufacturers in connection with an investigation of fertilizer prices; the States Relations Service of that department, for various gatherings of its employees, including a seven-day conference of its farm-management demonstrators from all parts of the country and the annual meeting of the Potomac Garden Club organized under its auspices; the Bureau of Plant Industry, for a phytopathological seminar; and the Federal Horticultural Board, for a public hearing to consider the advisability of quarantining the States of Texas and Louisiana on account of the pink bollworm of cotton; the War Department, for the closing exer-

cises of the Army Medical School session 1919-20; for the fourth Hamilton fund lecture by the Rev. Dr. Charles E. Jefferson on "The old order and the new"; the National Research Council, for a lecture by Dr. John J. Carty on the wireless telephone, illustrated by talking motion pictures; the District of Columbia Minimum Wage Board, to bring together the women employed in hotels, restaurants, apartment houses, and hospitals of Washington, that they might select representatives to serve on the minimum-wage conference for this industry; the public schools of the District, for lantern-slide talks on trees, birds, and gardens by Mrs. Susan Sipe Alburdis before children of the public schools of south Washington; the Southern Society of Washington, for a lyceum on five Wednesday evenings during the winter and spring; the Anthropological Society of Washington, for its gatherings of the 1919-20 season; the Anthropological Society and the Washington Academy of Sciences, for a lecture by Dr. W. H. R. Rivers on ethnology, its aims and needs; the Washington Society of the Archæological Institute of America, for a lecture by Sir Bertram Windle on the megalithic monuments of Great Britain; for a special exhibition of motion pictures of national forests before delegates to the annual convention of the American Pharmaceutical Association; the Audubon Society of the District of Columbia, for its annual meeting, with lectures by Dr. Paul Bartsch on the birds of the District of Columbia, and again for an illustrated lecture by Dr. William L. Finley on wild game; the Wild Flower Preservation Society; the Consumers' League of the District of Columbia, for addresses by Hon. William B. Colver and Mrs. Florence Kelley on the cost of living from the consumer's standpoint; the committee in charge of "Be-kind-to-animals week," for an illustrated lecture by Mr. Ernest Harold Baines on the part played by animals in the war, and again for organizing a "Good-to-animals society"; the U. S. S. Jacob Jones Post No. 2 of the American Legion, to celebrate its first anniversary; the Association of Appointment Clerks; the Smithsonian Auxiliary of the District of Columbia Chapter of the American Red Cross; the Smithsonian Relief Association, for its annual meeting; for awarding the prizes for the Evening Star Army enlistment essays; the Washington Society of Engineers for a discussion of the preliminary report of the engineering council's committee on classification and compensation of Government engineers; and the Washington section of the American Society of Mechanical Engineers.

The work of the Congressional Joint Commission on Reclassification of Salaries created great activity among the civil employees of the Government in Washington, and the Museum afforded a meeting place for the scientific-technical section of the Federal Employees' Union No. 2, to complete the organization of the section, for a sym-

posium on the principles involved in fixing salaries, and for addresses by Prof. Irving Fisher on the purchasing power of salaries and by Doctors McClung and Howe on the work of the National Research Council; for the Smithsonian branch of the Federal Employees' Union No. 2, and for various other groups of civil employees for organizing, preparing data, and otherwise helping toward the classification of the Government forces in Washington, including Federal workers interested in bookkeeping, accounting, and auditing, the clerical force of the Department of Agriculture, the Federal photographers, the marine and stationary operating engineers, the subcommittee on personnel of the reclassification committee, and members of the Museum's scientific staff.

MISCELLANEOUS.

Under the auspices of the Arts Club of Washington, a special exhibition of illustrations of the famous bell towers of the world was held in rooms 46 and 47 of the Natural History Building from October 2 to 31, inclusive. The Arts Club has undertaken to enlist the cooperation of all lovers of freedom in furthering a plan to erect at the Nation's Capital a national peace tower with the largest and finest carillon that the most expert bell founders of the world can provide, as a tribute to the heroic resistance of Belgium, in recollection of our dead and those of our allies, and in enduring commemoration of the great victory won over imperialism.

An exhibition of drawings, photographs, and paintings illustrating the activities of the Air Service of the United States Army at the front and in America was opened to the public from October 4 to October 29, 1919, in the west north range, ground floor, Natural History Building. Capt. Otho Cushing was in charge of the exhibit.

The Museum library was increased by 1,932 bound volumes and 1,581 pamphlets, mainly obtained by gift and exchange, bringing the total in the library up to 56,617 volumes and 88,690 pamphlets and unbound papers. While there were no exceptional pieces contributed, there was a collection of special importance—the personal library of Dr. Charles D. Walcott. His intimate association with the paleontological collections of the Museum makes the Museum sectional libraries of vertebrate and invertebrate paleontology difficult of duplication.

The publications for the Museum for the year consisted of the Annual Report for 1919; volumes 54, 55, and 56 of the Proceedings; volume 21 of Contributions from the National Herbarium, Bulletins Nos. 106 (text), 107, and 108, a very small edition of Bulletin No. 103, and 42 separate papers. The total distribution of Museum publications aggregated 81,936 copies.

The number of visitors to the Natural History Building aggregated 321,568 for week days and 101,416 for Sundays. At the Arts and Industries Building, which is open only during the week, the total attendance was 250,982. The Smithsonian Building is ordinarily only open to visitors on week days, but an exception was made for a few Sundays in March and April, 1920, when there was on exhibition a series of exquisite water color paintings by Mrs. C. D. Walcott of wild flowers, the attendance being 84,223 on week days and 1,790 on the five Sundays.

The most pressing needs of the Museum are those for additional space for the ever-increasing collections and additional funds for their classification and maintenance. Another year has only made more acute these needs. Preliminary steps are being taken looking to securing the erection of another building to house the great historical collections of the Museum and the collections of the National Gallery of Art. It will nevertheless be some years before relief can be hoped for in this direction, even under the most favorable circumstances. The appropriations for the maintenance of the Museum for 1921 remain practically the same as those for 1920. Never were there so many openings for advancement in industrial as well as scientific lines, but under existing conditions the Museum is helpless. It is not only prevented from developing collections in the various directions now offering exceptional opportunities, but it carries forward existing work only by exercising the strictest economy.

Respectfully submitted.

W. DE C. RAVENEL,
*Administrative Assistant to the Secretary,
In charge United States National Museum.*

DR. CHARLES D. WALCOTT,
Secretary, Smithsonian Institution.

APPENDIX 2.

REPORT ON THE BUREAU OF AMERICAN ETHNOLOGY.

SIR: In response to your request I have the honor to submit the following report on the field researches, office work, and other operations of the Bureau of American Ethnology during the fiscal year ended June 30, 1920, conducted in accordance with the act of Congress approved July 19, 1919. The act referred to contains the following item:

American ethnology: For continuing ethnological researches among the American Indians and the natives of Hawaii, including the excavation and preservation of archeologic remains, under the direction of the Smithsonian Institution, including necessary employees and the purchase of necessary books and periodicals, \$42,000.

Ethnology is the study of man in groups or races and aims to contribute to our knowledge of racial culture and advance our appreciation of racial accomplishment. The researches of the Bureau of American Ethnology deal with the aborigines of the United States and the Hawaiian Islanders.

The material from which we may secure this knowledge is rapidly disappearing or being absorbed into modern life. The culture of the aboriginal inhabitants has in a great measure vanished, but modern survivals still remain, and it is one object of the bureau to record these survivals while this is possible, thus rescuing what remains as a partial record of the culture of the race. This is essential in order that our knowledge of the North American Indian may neither be distorted by prejudice nor exalted by enthusiastic glorification.

In linguistics the necessity of recording those languages that are in danger of extinction is urgent. Several of these are now spoken only by a few survivors—old men or women—and when they die this knowledge which they possess will disappear forever. Our Indians had a large literature and mythology, which, on account of their ignorance of letters they did not record. This is rapidly being lost, and it is our duty to secure the information at once before it loses its aboriginal character. The lexical and grammatical structure of the different Indian languages, their phonetic peculiarities, and their relations to each other also require intensive studies, which have been industriously pursued by the linguists of the bureau.

It is believed that the publications of the Bureau of American Ethnology should be of such a nature that they may be studied with profit by all intelligent persons and not so crowded with technicalities as to repel all readers except a few specialists. While the bureau publications should not be devoted solely to popular articles, they fail to advance and diffuse ethnological knowledge if they are so technical that they appeal only to one class of readers. The policy of the bureau is to publish a limited number of technical papers, the popular demand also being given due weight.

Important researches have been conducted by members of the staff on the material culture of the Indians, one aim being to ascertain the various fibers and foods used by them with a view to discover hitherto unused aboriginal resources that might be adopted with profit by the white man.

In order that the character of the habitations of the Indian might be better known and an accurate knowledge of them disseminated, illustrations of aboriginal buildings found in early maps and documentary records are being gathered and a series of publications on this subject has been inaugurated. These, when available, are accompanied by the original descriptions of the buildings and incidentally identifications of the sites of the larger villages so far as possible.

The bureau has continued researches on the music of the Indians with good results, as the past publications on this subject have attracted the attention of musicians who are making practical use of this knowledge in their compositions. There is a great demand for strictly Indian music.

Archeology has been one of the important lines of research by members of the bureau during the past year. Although the methods of research of this science are somewhat different from those of the ethnologist, the goal is the same.

It is urgent to gather all possible data regarding the ethnology of the Indian prior to the advent of the white man, and where written history is silent on this subject, legends, monuments, and other prehistoric remains are the only media to supply the unknown chapters of history. As the national parks, like the Mesa Verde, and national monuments, like the Chaco Canyon, containing the best examples of this evidence, have been reserved for permanent protection, the bureau is engaged in the scientific study of these remains in cooperation with the National Park Service.

The function of the Bureau of American Ethnology is both to advance knowledge of ethnology and archeology by researches and to disseminate information on all subjects concerning Indians. Much of the time of the chief and the members of the staff is occupied in replying to letters requesting this information. This in many cases

requires special knowledge of experts or extended studies in the library. The administration and routine duties of the office have also occupied much of the time of the chief.

The Great War has enlarged our view of the practical value of ethnological studies. As our country has become a world power and has entered into political and commercial relationships with many other races whose ethnology is little known, it is desirable that the ethnological researches of the bureau be enlarged in order that we may better appreciate these foreign peoples. From necessity we have limited our researches to the American Indian and the natives of Hawaii. There is, however, an urgent call for more extended studies of all peoples whose amalgamation will constitute the future American.

In addition to purely official duties, the chief has devoted considerable time to field work and the preparation of reports on archeological researches. In the course of the year two visits were made to the Mesa Verde National Park, Colorado—one in August and September, 1919; the other in June, 1920. These researches, in accordance with the above-mentioned act of Congress for the excavation and repair of archeological remains, were in continuation of the cooperative work of the Smithsonian Institution and the National Park Service of the Department of the Interior, and were made with an allotment from the latter for the excavation and repair of cliff houses and other ruins on the Mesa Verde.

In the summer and autumn of 1919 the chief excavated and repaired Square Tower House, formerly known as Peabody House, one of the most picturesque cliff dwellings of the park. The excavation of small house sites situated among the cedars on top of the mesa near the trail to Square Tower House was carried on simultaneously by Mr. Ralph Linton, under the direction of the chief.

The work at Square Tower House has enlarged our knowledge of the structure of cliff dwellings; that on small house sites contributes to theoretical discussions of their genesis and evolution. The small house sites on top of the mesa were interpreted as prototypes of kivas in the large cliff buildings and are thought to be the ancient stages in their development. The whole history of the evolution of horizontal masonry can be followed by studies of various types of buildings on the Mesa Verde.

The two unique characteristics of Square Tower House are a square tower situated in the middle of the ruin and the well-preserved roofs with beams intact on two of the ceremonial rooms, or kivas. The repair of the tower was timely, as it had been feared for many years that it would fall, since it has long been tottering. As all friends of our antiquities would regard the destruction of this as

a calamity, it was strengthened and put in a condition for permanent preservation.

The roofs of two of the eight kivas in Square Tower House were almost intact and show the best specimens of aboriginal carpentering in the park. Almost all of the original beams are still preserved, and their arrangement shows how the aboriginal builders constructed a vaulted roof. Especial care was exercised in repairing Square Tower House to protect these roofs and preserve the beams in place for examination by archeologists and visitors.

Small house sites are very numerous on top of Mesa Verde among the dense growth of cedars, and two of these situated above Square Tower House were chosen as types of the remainder for excavation. The rooms uncovered on these sites may be called Earth Lodges, and had sunken floors, with roofs now fallen in but originally constructed of logs covered with earth. One of these rooms, called Earth Lodge A, was completely excavated, and in order that the style of the most ancient habitation on the park might be seen by visitors it was protected from the elements by a shed. Another form of Earth Lodge, subterranean and probably of later construction, had stone pilasters like a cliff-house kiva for the support of a domed roof, but its walls were made of adobe plastered in the earth. It shows three periods of occupancy: (1) The original excavation, a subterranean room constructed on the lines of the unit type of kiva; (2) its secondary use as a grinding pit, by the introduction of vertical slabs of stone making three grinding mills, the metates of which were in place; and (3) a depression filled in with débris containing human skeletons and other bones. It may thus have served distinct purposes at different times.

The theoretical importance of Earth Lodge A is that it represents not only the archaic type of building on the mesa but also resembles those widely distributed habitations of nonpueblo tribes. It points to the conclusion that when the ancient colonists came to the Mesa Verde they differed only slightly from nomadic tribes and that their descendants developed the craft of stonemasons long after Earth Lodge A was inhabited.

Archeological work was renewed on the Mesa Verde in June, 1920, and the work of excavating was begun on a ruin called Painted House and a neighboring cliff dwelling. The result of this work was of great significance, for it brought to light a large cliff building that showed no evidence of having been formerly inhabited. It was not a cliff dwelling, but built for some other purpose. Its character points to the conclusion that this purpose was a temple for the celebration of fire rites, or possibly the conservation of that fire from

year to year. While there was found no evidence that anyone ever lived in it, an adjacent cliff dwelling afforded every indication that it was inhabited by at least two clans. New Fire House belongs to the same group of ceremonial buildings as Sun Temple, except that it is situated in a cliff and not on top of the mesa.

The features that have led to the identification of this ruin as one devoted to New Fire rites are the large walled fire pit full of ashes in the middle of the court and the resemblances of phallic and other pictures on the walls of the rooms to those still surviving among the Hopi in the New Fire cult.

Mr. James Mooney, ethnologist, remained in the office throughout the year, engaged chiefly in the elaboration of material relating to the Heraldry of the Kiowa and the Peyote Cult of the Southern Plains tribes.

In connection with the preparation of the Denig Assiniboin manuscript for publication, a correspondence was carried on with members of the Denig family and others for the purpose of gathering all available information concerning the history and personality of the author. A valuable complement to the Denig work is the German manuscript journal of the Swiss artist, Friedrich Kurz, who visited the upper Missouri in 1851-52, spending some months with Denig at Fort Union. A copy of the original journal, now in the museum of Bern, was made some years ago by direction of Mr. David I. Bushnell, jr., who sold it to the bureau.

The usual amount of correspondence in answer to requests for varied ethnologic information received attention. Among these may be noted requests from the War Department for Indian designs for regimental flags for two newly organized regiments.

In the latter part of October and throughout November, 1919, Dr. John R. Swanton, ethnologist, was at Anadarko, Okla., where he recorded about 270 pages of text in the Wichita language and 100 in Kichai, besides considerable vocabulary material in both. It should be remarked that the Kichai language is rapidly becoming extinct, being now spoken fluently by not over a dozen persons.

During the summer preceding this expedition he was engaged in the extraction and card-cataloguing of words from his Natchez texts, and after his return he prepared a grammatical sketch of the Natchez language, complete as far as the material on hand will permit, but withheld from publication for a final review with the help of Indian informants. This language is now spoken by only three persons.

He also completed a sketch of the Chitimacha language, the rough draft of which had already been prepared, and began the extraction and recording of words from his texts in the Koasati language.

Part of his time has been occupied in correcting the proofs of his Bulletin 73, on the Early History of the Creek Indians and Their Neighbors.

Several hundred cards have been added to his catalogue of material bearing on the economic basis of American Indian life.

Doctor Swanton completed reading the proofs of Bulletin 68, A Structural and Lexical Comparison of the Tunica, Chitimacha, and Atakapa Languages, and the bulletin was issued in December 1919.

The sketch of the Chitimacha language mentioned above, along with a similar sketch of Atakapa previously prepared, is ready for publication. Doctor Swanton has a much longer paper on the social organization and social customs of the southeastern Indians, which requires a little work for completion, but is withheld until the bulletin, which it naturally follows, is through the press.

Mr. J. N. B. Hewitt, ethnologist, took up the critical analysis and constructive rearrangement of the three differing versions of the Eulogy of the Founders of the League of the Iroquois, obtained by him, respectively, from the late Seneca Federal chief, John Arthur Gibson; the late Mr. Joshua Buck, Onondaga shaman, of Onondaga-Tutelo extraction; and chief emeritus Abram Charles, of the Cayuga tribe—all of Ontario, Canada.

This Eulogy of the Founders is a very long chant and one of marked difficulty to render accurately. In his report for last year it was stated that the long-standing disruption of the several tribes composing the league had led to the breaking up of the parts thereof and loss of traditions concerning the principles and structure of the league; hence there are differing versions of most important rituals. In the tribal organization the Federal chiefs were organized into several groups with definite political relationships, which differing relationships implied naturally corresponding differences in duties and obligations for the several persons so politically related.

But since the disruption of the political integrity of the tribes of the league and of the league itself by the events of the war of the American Revolution these relationships have become more or less confused in the minds of the people, and hence the great difficulty in determining from the informants of to-day the correct sequence of the names and the exact political relationships subsisting among the several chiefships. This accounts for the difficulties encountered in editing the three variant versions of the eulogy.

In view of works recently published on the genetic relationship of certain linguistic stocks of California and other North American linguistic stocks, and as a result of a conference of the staff of the bureau early in December on late linguistic work in California Mr. Hewitt critically examined the methods and the evidences for

relationship relating to the Yuman, the Serian, the Tequistlatecan, Waicuran, the Shahaptian, the Lutuamian, and the Waiilatpuan, claimed in recent publications by Doctor Radin and Doctor Kroeber. In no instance did he find that these authors had proved their case.

Mr. Hewitt continued the preparation for publication of the second part of Iroquoian Cosmology, Part I having already appeared in the Twenty-first Annual Report of the bureau. He spent considerable time in reading the manuscript dictionary and grammatical sketch of the Chippewa language prepared by Father Chrysostom Verwyst, in order to ascertain its value for publication and to enable him to assist the author in a revision of the work; and prepared much data for use in reply to requests by correspondents, often requiring considerable time and most exacting work.

In June, 1920, Mr. Hewitt visited the Oneida Indians, residing in the vicinity of Seymour and Oneida, Wis.

The purpose of this visit was to ascertain what information, if any, these Indians retained concerning the principles and structure of the League of the Five (later, Six) Nations, or even concerning their own social organization, or the mythic and religious beliefs of their ancestors, which has not already been recorded by him, from other sources. He found that these Indians had forgotten the great principles and the essential details of the organic structure of the league, of which the Oneida before their disruption by the events of the war of the American Revolution were so important a member, due to the adoption of lands in severalty about 1887, and the administration of their public affairs under the laws of the State of Wisconsin.

He discovered that these Oneida spoke a dialect markedly different from that of the Oneida with whom he was already acquainted and succeeded in recording a text relating to hunting wild pigeons (now practically extinct) at the time of "roosting."

From the Wisconsin Oneida Mr. Hewitt went directly to the Tonawanda Reservation to consult with Seneca chiefs, after which he proceeded to the Grand River grant of the Six Nations, near Brantford, Ontario, Canada, and there obtained an interesting text in the Onondaga language, with a free English translation. This text embodies an old Tutelo tradition of the manner in which the assistant to the chief was established, and is reminiscent of the early raids of the warriors of the Five Nations into the southern home of the ancient Tutelo.

Information relating to the internal structure of the tribal organization of the several tribes was carefully revised, especially the place of the several clans with regard to the symbolic council fire, and therefore their membership in either the male or the female side of the tribal organization. Certain sentences placed after every Federal title throughout the Eulogy of the Founders—originally 49 in num-

ber—can not be understood without this definite knowledge of internal tribal organization, as there is constant danger of confusing tribal with Federal relationships. The internal tribal organization differed among the Five Nations and the knowledge of one or two is not sufficient.

With the aid of Mr. Asa R. Hill as Mohawk interpreter and informant, the work of the textual criticism of the Mohawk text of the league material originally collected by Mr. Seth Newhouse, a Mohawk ex-federal chief, was revised. Knowing that Mr. Newhouse is a fine Mohawk speaker, Mr. Hewitt induced him to translate his material back into the language from which he had rendered it into indifferent English. This translation was not desired for publication but to obtain the correct Mohawk terminology or diction for the expression of the ideas embodied in the material.

During the year Mr. Francis La Flesche, ethnologist, devoted most of his time to the task of preparing for publication the manuscript of the first volume of his work on the Osage Tribe. In February the text of the first volume was finished and the manuscript placed in the hands of the Chief of the Bureau of American Ethnology.

The volume contains two elaborate ancient rituals, the first of which is entitled "Ga-hi'-ge O-k'oⁿ, Ritual of the Chiefs"; and the second "Ni'-ki Noⁿ-k'oⁿ, Hearing of the Sayings of the Ancient Men." These rituals are rendered in three forms: First, in a free English translation; second, the recited parts, also the words of the songs, as given by the Indians themselves in their own language into the dictaphone; third, a translation from the Osage language into English as nearly literal as can be made. Owing to the peculiar modes of expression used in the rituals by the Indians, such as metaphors, figures of speech, tropes, and archaic terms, it is impossible to give an absolutely literal translation. Furthermore, much of the language used in these rituals is in ceremonial style and not that in daily use among the people.

On the completion of the manuscript of the first volume, Mr. La Flesche took up the task of preparing for publication the manuscript of the second volume.

Mr. J. P. Harrington, ethnologist, spent the months of July, August, and September, 1919, on field duty in New Mexico in pursuance of his studies of the ethnology and linguistic relationship of the Southwest Indians. These studies resulted in a large amount of most carefully heard textual, grammatical, and lexical material from the Tano-Kiowan family of languages, the elaboration of more than 750 pages of which was completed for publication before the close of the fiscal year.

Important discoveries in connection with this work are that Zuñian is definitely added to the Tano-Kiowan-Keresan-Shoshonean stock; and that the religious-ceremonial words of Tanoan are largely borrowed from Zuñian and Keresan. This last discovery has proved one of the most interesting features of the work, for, just as it can be shown that the watermelon and muskmelon, for example, are not native to the Tanoan Indians because designated by Spanish loan-words or by mere descriptive terms, so it can be also demonstrated linguistically that the Tanoans have adopted many features of the Zuñian and Keresan religion. Even such fundamental conceptions as Wenima, the abode of the dead, and Sipapu, the entrance to the other world, have been taken over by the Tanoans, e. g., as Tewa Wayima and Sip'o phe.

At the close of September Mr. Harrington returned to Washington and was engaged during the remainder of the year in the elaboration of his material. Mr. Harrington also performed various office duties during this period.

In August, 1919, Dr. Truman Michelson, ethnologist, renewed his researches among the Fox Indians, which consisted exclusively of working out a grammatical analysis of the Indian text of his manuscript on the White Buffalo Dance, in order to make a vocabulary for the same. He returned to Washington near the middle of September, when he resumed his work on the Indian text, as well as the vocabulary. The manuscript was submitted in March, 1920.

During the winter Doctor Michelson worked on the manuscript of the White Buffalo Dance; he also spent some time on a rough translation of an autobiography of a Fox Indian woman written in the current syllabary. This translation was based on a paraphrase in English written by Horace Poweshiek. In the middle of June he left for Tama, Iowa, to restore the syllabary text phonetically, to further work out a grammatical analysis to enable him to add a suitable vocabulary, to elucidate a number of ethnological points, and to correct the translation in a number of places. By the close of the fiscal year he entirely restored the text phonetically.

In addition, Doctor Michelson has furnished data for official correspondence.

SPECIAL RESEARCHES.

In addition to the work of members of the staff mentioned in their reports above, the bureau has employed others in ethnological and archeological researches.

Mr. Neil M. Judd, curator of American archeology in the United States National Museum, was detailed in June to complete a report on his work for the bureau in previous seasons in southeastern Utah. At the time of writing no report on this work has been received.

Miss Densmore resumed work on the Pawnee songs on September 1, 1919. Transcriptions and analyses of 58 Pawnee songs have been submitted during the year. These comprise songs of the Morning Star ceremony and of the Buffalo dance, the Bear dance, and the Lance dance. In April, 1920, she visited the Pawnees a second time and was permitted to enter the lodge during the Morning Star ceremony and to see the contents of the "sacred bundle." This bundle is opened once a year. (It is said that only one other white person has been permitted to enter the ceremonial lodge.) This ceremony afforded an opportunity to hear certain interesting rituals which are sung only at this time.

Three manuscripts on Pawnee music have been submitted during the year. In addition to the ceremonial material above mentioned these papers contain songs of war and of a game, as well as miscellaneous songs and those connected with folk tales. The Pawnees were selected as representative of the Caddoan stock, according to the plan of comparing the songs of the various linguistic stocks.

About the middle of February, 1920, Miss Densmore began a study of the Papago Indians as a representative of the Piman stock. For more than a month she lived at San Xavier Mission, a Government station, among the Papago near Tucson, Arizona, and recorded more than 100 songs, 25 of which have been transcribed, analyzed, and submitted. Three subjects were studied—treatment of the sick, customs of war, and ancient stories. As examples of the psychology revealed by musical investigation it may be noted that the Papago state that all sickness has its origin in the anger of a mythical "creator," and that many of the songs used in treating the sick are said to have been received from spirits of the dead.

Miss Densmore considers the chief points of the year's investigation to be the evident contrast of songs of different linguistic stocks and the increasing evidence that rhythm in Indian song is more varied and important than melody. It is interesting to note that the songs recorded by an individual Indian doctor showed similarity in melodic material and formation, but a wide variety in rhythm. The poetry of the words of Papago songs is of an unusually high order.

In April, 1920, Miss Densmore visited the "Mohave" Apaches living at Camp MacDowell near Phoenix, Ariz., with a view to recording songs among them next season, taking the Apache as the representatives of the Athapascan stock.

In July, 1919, Miss Densmore visited the Manitou Rapids Reserve in Canada to obtain data on the customs of the Canadian Chippewas for comparison with the tribe in the States. She found an interesting contrast in bead patterns and collected considerable information on their general culture. August 14 to 30, 1919, she worked on

the botanical section of the book on Chippewa Arts and Customs, this section comprising the use of plants as food, medicine, and charms.

Mr. David I. Bushnell, jr., continued the preparation of his manuscript for the Handbook of Aboriginal Remains East of the Rocky Mountains, and in the course of his work has prepared a bulletin entitled "Native Villages and Village Sites East of the Mississippi" which has been published as Bulletin 69. He has also written Bulletin 71, on "Native Cemeteries and Forms of Burial East of the Mississippi," the final proofs of which have been sent to the printer, but the work has not yet been delivered to the bureau. The favorable reception of these bulletins, as indicated by the many applications made at the office for them, is gratifying.

Mr. Bushnell also gathered notes, maps, and photographs to be used in the preparation of two manuscripts for the bureau. One is to have the title, "Villages of the Algonquian, Siouan, and Caddoan Tribes West of the Mississippi"; the second, "Burials of the Algonquian, Siouan, and Caddoan Tribes West of the Mississippi." The former is nearing completion, and both should be finished during the next fiscal year.

The results of the archeological work in Texas under Prof. J. E. Pearce, for which a special allotment was made, are important. Reconnaissance work has been done in the eastern, middle, and western parts of the State. Indian mounds at Athens, in eastern Texas, have yielded pottery akin in form and technique to that of the Mississippi, suggesting cultural connections which have as yet not been completely traced. In western Texas the group of pictographs at Paint Rock has been given especial attention. They are little known, as they are at present seldom visited by tourists. This series of rock pictures is important enough to be protected by law. The present owner of the ranch upon which they are situated, recognizing their importance will prevent vandalism.

The work was mainly on the antiquities of central Texas, where intensive work was much to be desired. Professor Pearce, who has charge of this work, believes that the mounds in this part of the State are kitchen middens and that they were connected with the first men who came into this region. He is also of the opinion that the culture which they represent was much cruder than that of the historical Indians; that they knew nothing of polishing stone or of pottery making; and that for thousands of years they were the only occupants of the open prairies and plains of central and west Texas; and finally, that their life was little modified during the entire period of the formation of the mounds. Professor Pearce's report is so promising of results that work in Texas will be continued another year.

Although the aboriginal monuments called mounds and stone graves of the Cumberland Valley have been investigated by several well-known archeologists, it appears from the researches of Mr. W. E. Myer, of Nashville, that much remains to be discovered in this region. Under his guidance the chief visited the aboriginal mounds on the Harpeth River at Oldtown, Castalian Springs, and elsewhere. It was seen that while many of the smaller mounds have been plowed down by cultivation of the land the larger ones still bear mute evidence of the industry of the builders of these structures and the magnitude of the population.

Mr. Myer has transmitted to the bureau a manuscript on the antiquities of the Cumberland Valley, Tennessee, the results of a life-long devotion to the subject.

Mr. Otto Mallery has presented to the bureau a valuable pueblo collection from the Chama region, New Mexico, made by Mr. J. A. Jeancon, who had charge of the work, and has transmitted a report which is now being prepared for publication.

Mr. Gerard Fowke was given a small allotment for an archeological reconnoissance of the Hawaiian Islands. He began work in May and reports important results which it is too early to detail at this time.

MANUSCRIPTS.

The following manuscripts, exclusive of those submitted for publication by members of the staff of the bureau and its collaborators, were purchased:

"Wawehock Texts," by Frank S. Speck.

"History of the Jesuit Mission in Paraguay." The original manuscript, being an English translation by Dr. George Spence, from the original French manuscript of the Abbé Jo. Pedro Gay, Curé de Uruguayana. 2 vols., 4to. Circa 1880. 275 pp.

"A New Guarani Grammar," the original manuscript complete, being a translation into English by Dr. George Spence from the French manuscript of the Abbé Jo. Pedro Gay, Curé de Uruguayana. 2 vols. 4to.

"Manuel de Conversation en Français, en Portugues, en Español, en Guarany Abañeeme par le Chanoine J. P. Gay, Curé de Uruguayana," arranged in four columns.

"Nouvelle Grammaire de la Langue Guarany et Tupy, etc., par le Chanoine J. P. Gay, Curé, etc." 188 p., folio.

"Mappa geographico da republica do Paraguay pelo conego Joao Pedro Gay, pelo engenheiro Falix Alx. Grivot." 1881.

A copy of "Manuel de Conversation en Français, en Portugues, en Anglaise en Español, en Guarany Abañeeme." Arranged in five columns. No date.

In addition to those purchased Mr. Edward M. Brigham has submitted for publication a valuable manuscript with many plates on "The Antiquities of the Marajo," Brazil; and Mr. W. E. Myer, of Nashville, Tenn., a manuscript on "The Antiquities of the Cumberland Valley of Tennessee." "A Chippewa Bible History in manuscript in four volumes. 8vo. A. D. 1896-1901," was presented by Fr. Chrysostom Verwyst, O. F. M.

EDITORIAL WORK AND PUBLICATIONS.

The editing of the publications of the bureau was continued through the year by Mr. Stanley Searles, editor, assisted by Mrs. Frances S. Nichols. The status of the publications is presented in the following summary:

PUBLICATIONS ISSUED.

Thirty-third Annual Report.—Accompanying papers: (1) Uses of Plants by the Indians of the Missouri River Region (Gilmore); (2) Preliminary Account of the Antiquities of the Region between the Mancos and La Plata Rivers in southwestern Colorado (Morris); (3) Designs on Prehistoric Hopi Pottery (Fewkes); (4) The Hawaiian Romance of Laie-i-ka-wai (Beckwith). 677 pp. 95 pls.

Three separates from the *Thirty-third Annual Report*.

Bulletin 60.—Handbook of Aboriginal American Antiquities (Holmes). 380 pp.

Bulletin 68.—Structural and Lexical Comparison of the Tunica, Chitimacha, and Atakapa Languages (Swanton). 56 pp.

Bulletin 69.—Native Villages and Village Sites East of the Mississippi (Bushnell). 111 pp. 17 pls.

Bulletin 70.—Prehistoric Villages, Castles, and Towers (Fewkes). 79 pp. 33 pls.

PUBLICATIONS IN PRESS OR IN PREPARATION.

Thirty-fourth Annual Report.—Accompanying paper: Prehistoric Island Culture Areas of America (Fewkes).

Thirty-fifth Annual Report.—Accompanying paper: Ethnology of the Kwakiutl (Boas).

Thirty-sixth Annual Report.—Accompanying paper: The Osage Tribe (La Flesche).

Thirty-seventh Annual Report.—Accompanying paper: The Winnebago Tribe (Radin).

Thirty-eighth Annual Report.—An Introductory Study of the Arts, Crafts, and Customs of the Guiana Indians (Roth).

Bulletin 67.—Alesa Texts and Myths (Frachtenberg).

Bulletin 71.—Native Cemeteries and Forms of Burial East of the Mississippi (Bushnell).

Bulletin 72.—The Owl Sacred Pack of the Fox Indians (Michelson).

Bulletin 73.—Early History of the Creek Indians and their Neighbors (Swanton).

Bulletin 74.—Excavations at Santiago, Ahuitzotla, D. F., Mexico (Tozzer).

Bulletin —.—Archeological Investigations in the Ozark Region of Central Missouri (Fowke).

Bulletin —.—Northern Ute Music (Densmore).

Bulletin —.—Mandan and Hidatsa Music (Densmore).

Bulletin —.—Handbook of the Indians of California (Kroeber).

DISTRIBUTION OF PUBLICATIONS.

The distribution of publications has been continued under the immediate charge of Miss Helen Munroe, assisted by Miss Emma B. Powers. Publications were distributed as follows:

Annual reports and separates.....	3,373
Bulletins and separates.....	12,886
Contributions to North American ethnology.....	32
Miscellaneous publications.....	572
Total.....	16,863

As compared with the fiscal year 1919, there was an increase of 5,380 publications distributed. Fourteen addresses have been added to the mailing list during the year and 28 dropped, making a net decrease of 14.

ILLUSTRATIONS.

Mr. De Lancey Gill, with the assistance of Mr. Albert E. Sweeney, continued the preparation of the illustrations of the bureau. A summary of this work follows:

Photographic prints for distribution and office use.....	500
Negatives of ethnologic and archeologic subjects.....	300
Negative films developed from field exposures.....	100
Photostat prints made from books and manuscript.....	250

ILLUSTRATIONS PREPARED AND SUBMITTED FOR PUBLICATION.

Photographs retouched and otherwise.....	350
Line and color drawings.....	215
Illustration proofs edited.....	1,400
Lithographic proofs examined at Government Printing Office.....	5,200

LIBRARY.

The reference library continued in the immediate care of Miss Ella Leary, librarian, assisted by Mr. Charles B. Newman.

During the year 820 books were accessioned, of which 140 were acquired by purchase and 680 by gift and exchange. Volumes made by binding serials are included in these figures. The periodicals currently received number about 800, of which 35 were obtained by purchase, the remainder being received through exchange. The library has also received 260 pamphlets. The catalogue of the bureau

now records 23,380 volumes; there are about 14,508 pamphlets and several thousand unbound periodicals.

Successful effort has been made to complete the sets of certain publications of scientific societies and other learned institutions. For the use of the members of the staff there has been prepared and posted copies of a monthly bulletin of the principal accessions of the library; also information has been furnished and bibliographic notes compiled for the use of correspondents.

During the year the work of cataloguing has been carried on as new accessions were acquired and good progress was made in cataloguing ethnologic and related articles in the earlier serials.

Attention has been given to the preparation of volumes for binding, with the result that 502 books were sent to the bindery. The number of books borrowed from the Library of Congress for the use of the staff of the bureau in prosecuting their researches was about 400.

A pressing problem is the congestion of books on the shelves. For some time the library has been overcrowded and we are now taxed to find room for the current accessions.

The library is constantly referred to by students not connected with the bureau, as well as by various officials of the Government service.

COLLECTIONS.

The following collections acquired by members of the staff of the bureau, or by those detailed in connection with its researches, have been transferred to the United States National Museum:

Archeological objects collected in Cottonwood Canyon, Kane County, Utah, by Mr. Neil M. Judd, during the spring of 1919. Accession 63841, 257 specimens.

Archeological objects (748) and skeletal remains (24) collected for the bureau by Mr. Gerard Fowke from Miller's Cave, Missouri, during the spring of 1919. Accession 64150, 772 specimens.

Archeological collection, including human bones, from Sell's and Bell's Caves, Pulaski County, Missouri, forwarded by Mr. Gerard Fowke. Accession 64198, 83 specimens.

Archeological material from Texas, gathered from the surface by Dr. J. W. Fewkes and Prof. J. E. Pearce in the autumn of 1919. Accession 64248, 165 specimens.

Sculptured stones of Huastec culture, presented to the bureau by Mr. John M. Muir, of Tampico, Mexico. Accession 64249, 5 specimens.

Three fine hardwood bows and three ceremonial clubs from British Guiana, and a blanket of the Cowichan Indians (Salish), Northwest Coast. Accession 64327, 7 specimens.

Collection of archeological objects (262) and skeletal material (16 specimens), together with ethnologica of the Apache Indians (4 specimens), obtained in Arizona by Dr. Walter Hough during the spring of 1919. Accession 64603, 282 specimens.

Collection of archeological objects (212) and two human skulls, gathered by Dr. J. Walter Fewkes, at Square Tower House and contiguous ruins on the Mesa Verde National Park, Colo., in cooperation with the National Park Service of the Interior Department in 1919. Accession 64646, 214 specimens.

Archeological objects (446) and skeletal material (5) collected by Mr. J. A. Jeancon in an ancient ruin near Abiquiu, New Mexico, for Mr. Otto T. Mallery during the summer of 1919, and presented to the bureau by Mr. Mallery. Accession 64885, 451 specimens.

PROPERTY.

Furniture and office equipment was purchased to the amount of \$162.73.

MISCELLANEOUS.

Personnel.—The position of Honorary Philologist, held for several years by Dr. Franz Boas, has been abolished.

Clerical.—The correspondence and other clerical work of the office has been conducted by Miss May S. Clark, clerk to the chief. Mrs. Frances S. Nichols assisted the editor.

There has been no change in the scientific or clerical force.

Respectfully submitted.

J. WALTER FEWKES,

Chief, Bureau of American Ethnology.

Dr. CHARLES D. WALCOTT,

Secretary, Smithsonian Institution.

APPENDIX 3.

REPORT ON THE INTERNATIONAL EXCHANGES.

SIR: I have the honor to submit the following report on the operations of the International Exchange Service during the fiscal year ending June 30, 1920:

The congressional appropriation for the support of the service during the year was \$45,000, an increase of \$10,000 over the amount of the regular appropriation for 1919. This increase was made necessary in order to meet the cost of transportation at the prevailing high ocean freight rates on shipments of accumulated publications for certain countries. The usual allotment of \$200 for printing and binding was allowed by Congress. The repayments from departmental and other establishments aggregated \$4,992.96, making the total available resources for carrying on the system of exchanges during the fiscal year 1920 \$50,192.96.

During the year 1920 the total number of packages handled was 369,372—an increase over the number for the preceding year of 98,512. These packages weighed a total of 496,378 pounds—a gain of 204,460 pounds. These increases in the number and weight of packages handled are accounted for by the fact that during the year shipments were resumed to several countries with which exchange relations were suspended during the war, concerning which a statement will be made later in this report. It is gratifying to state that the work of the office during the past year exceeded by 27,705 packages the number handled during the fiscal year 1914, just prior to the outbreak of the World War.

The number and weight of the packages of different classes are indicated in the following table:

	Packages.		Weight.	
	Sent.	Received.	Sent.	Received.
			<i>Pounds.</i>	<i>Pounds.</i>
United States parliamentary documents sent abroad	165,291		90,725	
Publications received in return for parliamentary documents		2,598		11,431
United States departmental documents sent abroad	123,345		206,029	
Publications received in return for departmental documents		3,870		9,116
Miscellaneous scientific and literary publications sent abroad ..	56,484		125,137	
Miscellaneous scientific and literary publications received from abroad for distribution in the United States		17,784		53,940
Total	345,120	24,252	421,891	74,487
Grand total	369,372		496,378	

Packages from foreign countries frequently contain more than one publication. The returns from abroad, therefore, are larger than would be supposed from a casual glance at the figures in the table. Even allowing for this, there is still a disparity between the number of publications sent and those received through the International Exchange Service. This apparent one-sidedness, however, is largely offset by the number of publications received by governmental and other establishments in this country directly through the mails from abroad. Several years ago (1907) the Institution brought this subject to the attention of the various bureaus of the Government and offered to make a special effort to secure for them more adequate returns for the publications sent by them through the Exchange Service to foreign correspondents. While several offices took advantage of this offer, and a large number of foreign publications were received for them by the Institution, many of the bureaus stated that the quantity and value of the publications received, either through the International Exchange Service or direct by mail, were considered an equivalent for the documents sent abroad. Quotations from some of the letters are given below:

Coast and Geodetic Survey.—Not all of our publications forwarded to foreign addresses are sent in anticipation of exchanges to be received by this bureau. Many are sent to individuals from whom no return is expected. I take it that in like manner many individuals, citizens of the United States, are favored with publications of interest to them put out by foreign Governments. I think we are now receiving all of the publications of other Governments in which we are interested. Many of these reach us through the mails.

Weather Bureau.—It is believed that the bureau already receives adequate returns from its foreign correspondents, most of whom send their publications by mail direct.

Office of the Chief of Staff.—Many of the exchanges are received by the War Department from our military attachés abroad, all of whom have pouch service through the Department of State, which probably accounts largely, if not entirely, for the lesser number of packages received than sent.

Nautical Almanac Office.—The Ephemeris, being issued every year, makes the volume of our publications larger than that of most observatories, and on that account anything like an equality in the number of packages exchanged can not be expected.

Bureau of Foreign and Domestic Commerce.—The cause of the excess of packages sent by this bureau through your exchange as compared with those received for it is, as you are probably aware, that this department has no adequate appropriation for the payment of postage on packages sent abroad and is therefore obliged to avail itself of the lesser expense of sending them through your Institution, while foreign Governments in most cases pay the postage on exchanges and mail them direct to this bureau.

Surgeon General's Office, War Department.—The volumes of the Index Catalogue, the only publication of this office now sent through the Smithsonian Exchange Service, have been forwarded annually to the libraries of the most important medical and other scientific institutions in foreign countries—including the universities in France and Germany—receiving, in return, the theses and dissertations of the universities and such publications as the other insti-

tutions issue. A very large number of exchanges are also received through our agents in London, Paris, and elsewhere. The aid received from the Smithsonian Institution in forwarding and receiving these exchanges can not be overestimated, but it is believed that we are receiving a full return for the exchanges that are now being sent out.

United States Patent Office.—Your offer to endeavor to increase the foreign exchanges of this office through your Institution is appreciated, but it is reported to me by the librarian that we now receive all the publications which are considered to be of value in the work of this bureau which can be secured in that way.

Comptroller of the Currency.—The packages from this bureau sent through the Smithsonian Institution are annual reports of the comptroller, practically all of which are addressed to individuals or corporations, from whom no returns are expected.

Bureau of Navigation, Department of Commerce.—The bureau receives ample return for its publications sent abroad. Indeed, in cost and in numbers our foreign exchanges exceed considerably our publications sent abroad. I have noticed, however, that it is the practice of our foreign correspondents to send their packages, pamphlets, etc., directly to this bureau through the mails.

In my last report I stated that the service had not been put on a prewar basis so far as the forwarding of consignments abroad was concerned. Shipments are still suspended to Austria, Germany, Montenegro, Roumania, Russia, Serbia, and Turkey. The opinion was expressed in last year's report that it was not advisable to forward consignments to the above until the peace treaties with the enemy countries were finally ratified by the United States and the internal conditions in the other nations became more settled. Trade relations having been resumed with Germany, Austria, and Hungary, the Institution took steps to reopen exchange relations with them, and just before the close of the year shipments to Hungary were resumed. Montenegro and Serbia now form part of the Serb-Croat-Slovene State, and the Institution has taken up with the authorities of that State the question of the interchange of publications. Internal conditions in Roumania having improved, the Roumanian authorities have been asked if they are ready to renew the exchange of publications with the United States. Nothing can, however, be done concerning the reopening of exchange relations with either Russia or Turkey until conditions in those countries reach a more normal basis.

The Bulgarian foreign office, in reply to a letter from the Institution concerning the reestablishment of exchange relations, writes, under date of July 3, that the Bulgarian Government eagerly accepts the proposal of the Institution. Shipments to that country will, therefore, be resumed in the early part of the next fiscal year.

An exchange of publications was inaugurated during the year with the Czechoslovak Republic, and the Polish Government will be approached concerning the exchange of publications as soon as conditions in that country become more settled.

Before the war shipments of international exchanges were made to Finland through the Russian exchange commission at Petrograd. Now that Finland has become an independent State, consignments are being forwarded directly to that country.

The prompt dispatch of exchange consignments to foreign countries was greatly interfered with during the year, owing to railroad freight embargoes and marine strikes. Transportation of boxes to New York was further interrupted, owing to the severe winter. During the latter part of the year railroad freight became very much congested, especially in the vicinity of New York, which necessitated the placing of a general embargo on all freight. This required the suspension of the Institution's shipments for over a month. The official character of the work carried on by the exchange service was brought to the attention of the railroad authorities with the request that a permit be issued granting the Institution permission to forward its material to New York for transmission abroad. When the railroads began to exempt certain classes of freight from the embargo, the Institution was given authority to send its consignments.

The Institution has, in a few cases, rendered aid to various establishments in procuring publications relating to some particular subject in which especial interest was manifested. I may refer to one instance in this connection: The counselor in charge of foreign relations of the municipality of Prague wrote to the American Legation in that city that he wished to establish better cultural and intellectual relations between the University of Prague and the various American universities, and that with that end in view he was desirous of receiving catalogues giving the courses offered by those universities. The counselor also expressed a desire to receive documents concerning the functioning of the governments of American municipalities and their methods of solving economic, social, and political problems. The matter was brought to the attention of the more important American universities and of the governments of the larger cities in this country, from whom considerable material bearing on the subject was received and forwarded to Prague.

In March, 1920, a letter was received from Dr. S. G. de Vries, director of the Bureau Scientifique Central Néerlandais, Bibliothèque de l'Université, Leyden, stating that on account of the condition of his health he was unable to retain the management of the Dutch Central Scientific Bureau (the Netherlands Exchange Agency), and that Dr. H. H. R. Roelofs Heyermans, director of the Bibliothèque de l'Académie Technique, Delft, had succeeded him in the management of the Dutch bureau. Shipments for the Netherlands are therefore now forwarded to Delft. Doctor de Vries had been head of the Dutch scientific bureau for 18 years, during which time the interchange of publications between the Netherlands and the United

States was conducted in a most efficient manner, and I desire to record here the Institution's appreciation of his services in promoting the interchange of publications between the Netherlands and the United States.

The National Committee of the United States for the Restoration of the University of Louvain in Belgium, which work is being conducted under the direction of Dr. Herbert Putnam, Librarian of Congress, collected and sent to the Institution for transmission to that university up to March, 1920, over 12,000 publications. The forwarding of these publications required 102 boxes, measuring 767 cubic feet and weighing 25,423 pounds. That shipment was the largest single consignment ever forwarded through the Exchange Service to any address at one time. It was greater than the combined bulk of the shipments sent abroad during the entire year 1871. The Institution is still receiving books for the University of Louvain, and these will be forwarded at a subsequent date.

Occasionally complaints are received from foreign correspondents that transportation charges are made on packages sent to them through exchange channels. Such a complaint was recently received from an Egyptian correspondent. The subject was taken up with the Government Publications Office at Cairo—the Egyptian Exchange Agency—which replied that henceforth that office would deliver all packages under Government frank free of expense to the recipients. This action on the part of the Government Publications Office is very gratifying, as one of the principal provisions of the Brussels Exchange Convention of 1886 would be defeated if any transportation charges were exacted from consignees. While not all countries were parties to that convention, most of them adhere to its provisions. I may add in this connection that packages received from abroad for distribution through the Smithsonian Exchange Service are sent to their destinations by mail under Government frank.

During the latter part of the year a letter was received from the Victorian Exchange Agency stating that the 16 boxes (Nos. 852-863, 9739-9740, 9794-9795) sent in its care under date of December 29, 1919, were lost at sea when the steamship *Marne* was wrecked off the coast of Panama. Four of these boxes contained the regular series of United States governmental documents for deposit in the public library of Victoria and in the library of the Commonwealth Parliament. Duplicate copies of these publications were forwarded to take the place of those lost. The contents of two of the boxes were for the Commonwealth War Memorials Library, and the Library of Congress, the sender, has taken steps to duplicate the material. The remaining 10 boxes contained miscellaneous publications for various addresses in Victoria. On account of the difficulty of determining the contents of the packages contained in these latter boxes, it was deemed

best to let the matter rest until requests for the missing publications are received from the addressees.

During the year 2,359 boxes were used in forwarding exchanges to foreign agencies for distribution, being an increase of 1,556 over the number for the preceding 12 months. While this is a very large increase, the total number of boxes represents about the quantity used during a normal year.

Of the total number of boxes forwarded, 342 contained full sets of United States official documents for authorized depositories and 2,017 included departmental and other publications for depositories of partial sets and for miscellaneous correspondents.

The number of boxes sent to each foreign country is given in the following table:

Consignments of exchanges for foreign countries.

Country.	Number of boxes.	Country.	Number of boxes.
Argentina.....	50	Jamaica.....	5
Belgium.....	239	Japan.....	95
Bolivia.....	8	Korea.....	2
Brazil.....	39	Mexico.....	6
British colonies.....	9	Netherlands.....	64
British Guiana.....	2	New South Wales.....	47
Canada.....	24	New Zealand.....	48
Chile.....	27	Nicaragua.....	5
China.....	35	Norway.....	40
Colombia.....	23	Paraguay.....	1
Costa Rica.....	16	Peru.....	16
Cuba.....	6	Portugal.....	26
Denmark.....	54	Queensland.....	21
Dutch Guiana.....	2	Salvador.....	7
Ecuador.....	12	Siam.....	4
Egypt.....	12	Spain.....	44
Finland.....	10	Sweden.....	87
France.....	253	Switzerland.....	57
Great Britain and Ireland.....	451	Tasmania.....	11
Greece.....	24	South Australia.....	31
Guatemala.....	6	Trinidad.....	1
Haiti.....	8	Union of South Africa.....	39
Honduras.....	4	Uruguay.....	21
Hungary.....	75	Venezuela.....	17
India.....	59	Victoria.....	66
Italy.....	110	Western Australia.....	10

FOREIGN DEPOSITORIES OF UNITED STATES GOVERNMENTAL DOCUMENTS.

In accordance with treaty stipulations and under the authority of the congressional resolutions of March 2, 1867, and March 2, 1901, setting apart a certain number of documents for exchange with for-

eight countries, there are now received for distribution to depositories abroad 56 full sets of United States official publications and 37 partial sets, two depositories having been added during the year, as referred to below.

An arrangement for an exchange of a full set of official documents between the Governments of Czechoslovakia and the United States was entered into in the summer of 1919, but the details of transmission were not perfected until near the close of the fiscal year, and the first shipment to that country will be made during the month of July, 1920. It might be added as a matter of record that the consignment will consist of 25 boxes containing governmental documents received at the Institution since January 27, 1919, the Czechoslovak Government being requested to send to the United States copies of its own documents covering the same period. It is understood that the publications from this country will be deposited in the Ministère de l'Instruction Publique at Prague.

In August, 1919, the State of Rio de Janeiro was added to the list of those countries receiving partial sets. The documents are deposited in the Bibliotheca da Assembleia Legislativa do Estado do Rio de Janeiro in Nictheroy.

Since Alsace-Lorraine has been restored to France the Bibliothèque Universitaire et Régionale de Strasbourg has been designated as the depository of the partial set sent to that province.

The depository in Finland since that country established its independence has been changed from the Chancery of Governor to the Central Library of the State, Helsingfors.

A complete list of the depositories is given below:

DEPOSITORIES OF FULL SETS.

- ARGENTINA: Ministerio de Relaciones Exteriores, Buenos Aires.
 AUSTRALIA: Library of the Commonwealth Parliament, Melbourne.
 AUSTRIA: Statistische Zentral-Kommission, Vienna.
 BADEN: Universitäts-Bibliothek, Freiburg. (Depository of the State of Baden.)
 BAVARIA: Staats-Bibliothek, Munich.
 BELGIUM: Bibliothèque Royale, Brussels.
 BRAZIL: Bibliotheca Nacional, Rio de Janeiro.
 BUENOS AIRES: Biblioteca de la Universidad Nacional de La Plata. (Depository of the Province of Buenos Aires.)
 CANADA: Library of Parliament, Ottawa.
 CHILE: Biblioteca del Congreso Nacional, Santiago.
 CHINA: American-Chinese Publication Exchange Department, Shanghai Bureau of Foreign Affairs, Shanghai.
 COLOMBIA: Biblioteca Nacional, Bogotá.
 COSTA RICA: Oficina de Depósito y Canje Internacional de Publicaciones, San José.
 CUBA: Secretaria de Estado (Asuntos Generales y Canje Internacional), Habana.

- CZECHOSLOVAKIA: Ministère de l'Instruction Publique, Prague.
 DENMARK: Kongelige Bibliotheket, Copenhagen.
 ENGLAND: British Museum, London.
 FRANCE: Bibliothèque Nationale, Paris.
 GERMANY: Deutsche Reichstags-Bibliothek, Berlin.
 GLASGOW: City Librarian, Mitchell Library, Glasgow.
 GREECE: Bibliothèque Nationale, Athens.
 HAITI: Secrétaire d'État des Relations Extérieures, Port au Prince.
 HUNGARY: Hungarian House of Delegates, Budapest.
 INDIA: Imperial Library, Calcutta.
 IRELAND: National Library of Ireland, Dublin.
 ITALY: Biblioteca Nazionale Vittorio Emanuele, Rome.
 JAPAN: Imperial Library of Japan, Tokyo.
 LONDON: London School of Economics and Political Science. (Depository of the London County Council.)
 MANITOBA: Provincial Library, Winnipeg.
 MEXICO: Instituto Bibliográfico, Biblioteca Nacional, Mexico.
 NETHERLANDS: Bibliotheek van de Staten-Generaal, The Hague.
 NEW SOUTH WALES: Public Library of New South Wales, Sydney.
 NEW ZEALAND: General Assembly Library, Wellington.
 NORWAY: Stortingets Bibliothek, Christiania.
 ONTARIO: Legislative Library, Toronto.
 PARIS: Préfecture de la Seine.
 PERU: Biblioteca Nacional, Lima.
 PORTUGAL: Bibliotheca Nacional, Lisbon.
 PRUSSIA: Königliche Bibliothek, Berlin.
 QUEBEC: Library of the Legislature of the Province of Quebec, Quebec.
 QUEENSLAND: Parliamentary Library, Brisbane.
 RUSSIA: Public Library, Petrograd.
 SAXONY: Oeffentliche Bibliothek, Dresden.
 SERBIA: Section Administrative du Ministère des Affaires Étrangères, Belgrade.
 SOUTH AUSTRALIA: Parliamentary Library, Adelaide.
 SPAIN: Servicio del Cambio Internacional de Publicaciones, Cuerpo Facultativo de Archiveros, Bibliotecarios y Arqueólogos, Madrid.
 SWEDEN: Kungliga Bibliotheket, Stockholm.
 SWITZERLAND: Bibliothèque Fédérale Centrale, Berne.
 TASMANIA: Parliamentary Library, Hobart.
 TURKEY: Department of Public Instruction, Constantinople.
 UNION OF SOUTH AFRICA: State Library, Pretoria, Transvaal.
 URUGUAY: Oficina de Canje Internacional de Publicaciones, Montevideo.
 VENEZUELA: Biblioteca Nacional, Caracas.
 VICTORIA: Public Library of Victoria, Melbourne.
 WESTERN AUSTRALIA: Public Library of Western Australia, Perth.
 WÜRTTEMBERG: Landesbibliothek, Stuttgart.

DEPOSITORIES OF PARTIAL SETS.

- ALBERTA: Provincial Library, Edmonton.
 ALSACE-LORRAINE: Bibliothèque Universitaire et Régionale de Strasbourg, Strasbourg.
 BOLIVIA: Ministerio de Colonización y Agricultura, La Paz.
 BREMEN: Senatskommission für Reichs- und Auswärtigen Angelegenheiten.
 BRITISH COLUMBIA: Legislative Library, Victoria.
 BRITISH GUIANA: Government Secretary's Office, Georgetown, Demerara.
 BULGARIA: Minister of Foreign Affairs, Sofia.

- CEYLON:** Colonial Secretary's Office (Record Department of the Library), Colombo.
- ECUADOR:** Biblioteca Nacional, Quito.
- EGYPT:** Bibliothéque Khédiviale, Cairo.
- FINLAND:** Central Library of the State, Helsingfors.
- GUATEMALA:** Secretary of the Government, Guatemala.
- HAMBURG:** Senatskommission für die Reichs- und Auswärtigen Angelegenheiten.
- HESSE:** Landesbibliothek, Darmstadt.
- HONDURAS:** Secretary of the Government, Tegucigalpa.
- JAMAICA:** Colonial Secretary, Kingston.
- LIBERIA:** Department of State, Monrovia.
- LOUBENÇO MARQUEZ:** Government Library, Lourenço Marquez.
- LÜBECK:** President of the Senate.
- MADRAS, PROVINCE OF:** Chief Secretary to the Government of Madras, Public Department, Madras.
- MALTA:** Lieutenant Governor, Valetta.
- MONTENEGRO:** Ministère des Affaires Étrangères, Cetinje.
- NEW BRUNSWICK:** Legislative Library, Fredericton.
- NEWFOUNDLAND:** Colonial Secretary, St. John's.
- NICARAGUA:** Superintendente de Archivos Nacionales, Managua.
- NORTHWEST TERRITORIES:** Government Library, Regina.
- NOVA SCOTIA:** Provincial Secretary of Nova Scotia, Halifax.
- PANAMA:** Secretaria de Relaciones Exteriores, Panama.
- PARAGUAY:** Oficina General de Inmigracion, Asuncion.
- PRINCE EDWARD ISLAND:** Legislative Library, Charlottetown.
- ROUMANIA:** Academia Romana, Bucharest.
- SALVADOR:** Ministerio de Relaciones Exteriores, San Salvador.
- SIAM:** Department of Foreign Affairs, Bangkok.
- STRAITS SETTLEMENTS:** Colonial Secretary, Singapore.
- UNITED PROVINCES OF AGRA AND OUDH:** Under Secretary to Government, Allahabad.
- VIENNA:** Bürgermeister-Amt der Haupt- und Residenz-Stadt.

INTERPARLIAMENTARY EXCHANGE OF OFFICIAL JOURNALS.

In the early part of the fiscal year the immediate exchange of the official journal was entered into with the Government of Czechoslovakia. A complete list of the countries now taking part in this immediate exchange is given below:

Argentine Republic.	France.	Queensland.
Australia.	Great Britain.	Roumania.
Austria.	Greece.	Russia.
Baden.	Guatemala.	Serbia.
Belgium.	Honduras.	Spain.
Bolivia.	Hungary.	Switzerland.
Brazil.	Italy.	Transvaal.
Buenos Aires (Province).	Liberia.	Union of South Africa.
Canada.	New South Wales.	Uruguay.
Costa Rica.	New Zealand.	Venezuela.
Cuba.	Peru.	Western Australia.
Czechoslovakia.	Portugal.	
Denmark.	Prussia.	

It will be noted from the above that there are at present 37 countries with which this exchange is conducted. To some of the countries two copies of the Congressional Record are sent, one to the Upper and one to the Lower House of Parliament, the total number transmitted being 43.

FOREIGN EXCHANGE AGENCIES.

Since Finland became an independent State the president of the Delegation of the Scientific Societies of Finland, Helsingfors, has offered the services of that delegation as the Finnish exchange agency.

This offer has been accepted and consignments intended for that country are now forwarded in care of the delegation.

Dr. Julius Pikler, of Budapest, whose services as Smithsonian agent for Hungary were, owing to the war, discontinued June 30, 1917, until further notice, was reappointed Hungarian exchange agent, to take effect July 1, 1920.

The Bureau Scientifique Central Néerlandais—the Dutch exchange agency—formerly under the Bibliothèque de l'Université, is now under the Bibliothèque de l'Académie Technique at Delft.

A complete list of the foreign exchange agencies or bureaus is given below. Shipments to those countries marked with an asterisk were still suspended at the close of the fiscal year.

ALGERIA, *via* France.

ANGOLA, *via* Portugal.

ARGENTINA: Comisión Protectora de Bibliotecas Populares, Lavalle 1216, Buenos Aires.

AUSTRIA:* Statistische Zentral-Kommission, Vienna.

AZORES, *via* Portugal.

BELGIUM: Service Belge des Échanges Internationaux, Rue des Longs-Chariots 46, Brussels.

BOLIVIA: Oficina Nacional de Estadística, La Paz.

BRAZIL: Serviço de Permutações Internacionais, Bibliotheca Nacional, Rio de Janeiro.

BRITISH COLONIES: Crown Agents for the Colonies, London.

BRITISH GUIANA: Royal Agricultural and Commercial Society, Georgetown.

BRITISH HONDURAS: Colonial Secretary, Belize.

BULGARIA: Institutions Scientifiques de S. M. le Roi de Bulgarie, Sofia.

CANARY ISLANDS, *via* Spain.

CHILE: Servicio de Canjes Internacionales, Biblioteca Nacional, Santiago.

CHINA: American-Chinese Publication Exchange Department, Shanghai Bureau of Foreign Affairs, Shanghai.

COLOMBIA: Oficina de Canjes Internacionales y Reparto, Biblioteca Nacional, Bogotá.

COSTA RICA: Oficina de Depósito y Canje Internacional de Publicaciones, San José.

DENMARK: Kongelige Danske Videnskabernes Selskab, Copenhagen.

DUTCH GUIANA: Surinaamsche Koloniale Bibliotheek, Paramaribo.

- ECUADOR: Ministerio de Relaciones Exteriores, Quito.
- EGYPT: Government Publications Office, Printing Department, Bulaq, Cairo.
- FINLAND: Delegation of the Scientific Societies of Finland, Helsingfors.
- FRANCE: Service Français des Échanges Internationaux, 110 Rue de Grenelle, Paris.
- GERMANY:* Amerika-Institut, Berlin, N. W. 7.
- GREAT BRITAIN AND IRELAND: Messrs. William Wesley & Son, 28 Essex Street, Strand, London.
- GREECE: Bibliothèque Nationale, Athens.
- GREENLAND, *via* Denmark.
- GUADELOUPE, *via* France.
- GUATEMALA: Instituto Nacional de Varones, Guatemala.
- GUINEA, *via* Portugal.
- HAITI: Secrétaire d'État des Relations Extérieures, Port au Prince.
- HONDURAS: Biblioteca Nacional, Tegucigalpa.
- HUNGARY: Dr. Julius Pikler, Fővárosi Telekértéknnylvántartó Hivatal (City Land Valuation Office), Központi Városház, Budapest IV.
- ICELAND, *via* Denmark.
- INDIA: Superintendent of Stationery, Bombay.
- ITALY: Ufficio degli Scambi Internazionali, Biblioteca Nazionale Vittorio Emanuele, Rome.
- JAMAICA: Institute of Jamaica, Kingston.
- JAPAN: Imperial Library of Japan, Tokyo.
- JAVA, *via* Netherlands.
- KOREA: Government General, Keijo.
- LIBERIA: Bureau of Exchanges, Department of State, Monrovia.
- LOURENÇO MARQUEZ: Government Library, Lourenço, Marquez.
- LUXEMBURG, *via* Germany.
- MADAGASCAR, *via* France.
- MADEIRA, *via* Portugal.
- MONTENEGRO:* Ministère des Affaires Étrangères, Cetinje.
- MOZAMBIQUE, *via* Portugal.
- NETHERLANDS: Bureau Scientifique Central Néerlandais, Bibliothèque de l'Académie technique, Delft.
- NEW GUINEA, *via* Netherlands.
- NEW SOUTH WALES: Public Library of New South Wales, Sydney.
- NEW ZEALAND: Dominion Museum, Wellington.
- NICARAGUA: Ministerio de Relaciones Exteriores, Managua.
- NORWAY: Kongelige Norske Frederiks Universitet Bibliotheket, Christiania.
- PANAMA: Secretaría de Relaciones Exteriores, Panama.
- PARAGUAY: Servicio de Canje Internacional de Publicaciones Sección Consular y de Comercio, Ministerio de Relaciones Exteriores, Asuncion.
- PERSIA: Board of Foreign Missions of the Presbyterian Church, New York City.
- PERU: Oficina de Reparto, Depósito y Canje Internacional de Publicaciones, Ministerio de Fomento, Lima.
- PORTUGAL: Serviço de Permutações Internacionais, Bibliotheca Nacional, Lisbon.
- QUEENSLAND: Bureau of Exchanges of International Publications, Chief Secretary's Office, Brisbane.
- ROUMANIA:* Academia Romana, Bucharest.
- RUSSIA:* Commission Russe des Échanges Internationaux, Bibliothèque, Publique, Petrograd.
- SALVADOR: Ministerio de Relaciones Exteriores, San Salvador.
- SERBIA:* Section Administrative du Ministère des Affaires Etrangères, Belgrade.

SIAM: Department of Foreign Affairs, Bangkok.

SOUTH AUSTRALIA: Public Library of South Australia, Adelaide.

SPAIN: Servicio del Cambio Internacional de Publicaciones, Cuerpo Facultativo de Archiveros, Bibliotecarios y Arqueólogos, Madrid.

SUMATRA, *via* Netherlands.

SWEDEN: Kongliga Svenska Vetenskaps Akademien, Stockholm.

SWITZERLAND: Service des Échanges Internationaux, Bibliothèque Fédérale Centrale, Berne.

SYRIA: Board of Foreign Missions of the Presbyterian Church, New York.

TASMANIA: Secretary to the Premier, Hobart.

TRINIDAD: Royal Victoria Institute of Trinidad and Tobago, Port-of-Spain.

TUNIS, *via* France.

TURKEY:* American Board of Commissioners for Foreign Missions, Boston.

UNION OF SOUTH AFRICA: Government Printing Works, Pretoria, Transvaal.

URUGUAY: Oficina de Canje Internacional, Montevideo.

VENEZUELA: Biblioteca Nacional, Caracas.

VICTORIA: Public Library of Victoria, Melbourne.

WESTERN AUSTRALIA: Public Library of Western Australia, Perth.

WINDWARD AND LEEWARD ISLANDS: Imperial Department of Agriculture, Bridgetown, Barbados.

Shortly after the close of the fiscal year, at the request of the Economic Liaison Committee of the State Department, Mr. C. W. Shoemaker, chief clerk, and Mr. F. E. Gass, correspondence clerk, of the service, appeared before that committee to give information concerning the workings of the International Exchange Service.

Respectfully submitted.

C. G. ABBOT,

Assistant Secretary,

In Charge of Library and Exchanges.

Dr. CHARLES D. WALCOTT,

Secretary of the Smithsonian Institution.

APPENDIX 4.

REPORT ON THE NATIONAL ZOOLOGICAL PARK.

SIR: I have the honor to submit the following report on the operations of the National Zoological Park for the fiscal year ending June 30, 1920:

The appropriation allowed by Congress in the sundry civil act for the maintenance of the park was the same as for the preceding year, \$115,000, with the usual additional allotment of \$200 for printing and binding. With the cost of almost all of the supplies necessary for the maintenance of such an establishment increasing constantly, only a comparatively small part of this amount could be used for repairs and improvements of any kind. Such permanent improvements as were effected were made possible by the purchase of much of the necessary material during the preceding year. The grounds, roads and walks, buildings, and inclosures have, however, been kept in good condition by the regular force of employees, although many much needed repairs not actually urgent have been postponed. The number of animals in the collection shows an increase over that of last year; and the attendance reached a new mark of over 2,000,000 visitors.

ACCESSIONS.

Gifts.—Animals to the number of 127 were presented by friends of the park or were placed on indefinite deposit. It is gratifying that the park is becoming more and more appreciated as the natural depository for pet or captive wild animals no longer desired by their owners. Many important specimens, including parrots and other cage birds, reach the collection as gifts. The owners of such animals feel that their pets will not only enrich the national collections, but that they will have the most expert care and kindly treatment.

Most noteworthy among the gifts for the year are four accessions from tropical America, which included several species new to the collection. Mr. W. J. La Varre, jr., of Washington, D. C., during an extended trip up the Amazon River and some of its tributaries collected a number of desirable animals, which he presented to the park. Mr. La Varre's collection included a specimen of the rare black-headed ouakari monkey (*Cacajao melanocephalus*), a species

never before represented in the collection. This monkey is a member of the only genus of short-tailed monkeys inhabiting the New World, and is very seldom seen in captivity. The species is, unfortunately, like some others of the more delicate American monkeys, very difficult to keep, and this specimen survived only two months after its arrival in Washington. Other animals in the La Varre collection were a brown capuchin monkey, two titi or squirrel monkeys, an ocelot, two margay cats, two snowy egrets, a scarlet ibis, an orange-winged parrot, two yellow-winged paroquets, and four tui paroquets. Mr. La Varre also brought to Washington with him from Manaos, Brazil, a large specimen of the rare and curious mata-mata turtle, presented to the National Zoological Park by his friend, Mr. A. T. S. Hore, of Manaos.

A second accession from Brazil was from Mr. Edward B. Kirk, American consular agent at Manaos. This lot included three large American egrets, a white-backed trumpeter, and two brocket deer. The quarantine regulations in force at the time unfortunately prohibited the landing of the deer, and these were returned to Mr. Kirk's place in Brazil. The white-backed trumpeter (*Psophia leucoptera*) is very unusual in collections and is the most important addition to the bird department made during the fiscal year.

Dr. W. M. Mann, of the Bureau of Entomology, during a short stay in Honduras, collected a number of valuable and interesting Central American animals, which he brought to the park on his return. Included were a Mexican kinkajou, a mantled howler monkey (*Alouatta palliata*), a paca, a Honduras squirrel, two speckled agoutis, a Central American cooter, and a fine specimen of Rossignon's snapping turtle. Howler monkeys are exceptionally difficult to keep in captivity, and this specimen, a young example, did not long survive; but the remaining animals in Dr. Mann's collection are all in excellent condition.

Among the parrots received as gifts during the year were two species never before shown in the park. These were the lesser white-fronted parrot, presented by Mr. Alex Gregory, and the blue-backed parrotlet, from Mrs. Samuel Spencer, Washington, D. C.

Sixty individual donors contributed to the collection this year. The complete list is as follows:

- Mr. John L. Barr, Washington, D. C., red-winged blackbird.
- Mr. Bert Brooks, Washington, D. C., two alligators.
- Mr. John A. Buckley, Fairfax, Virginia, woodchuck.
- Mr. Granville Christman, Washington, D. C., screech owl.
- Mrs. E. L. Conn, Washington, D. C., double yellow-head parrot.
- Capt. Robert G. Cook, Washington, D. C., alligator.
- Col. J. A. Crane, Washington, D. C., cockateel.
- Mr. J. I. Cusick, Washington, D. C., two barn owls.

- Mrs. C. E. Dornheim, Washington, D. C., bald eagle.
Mr. John W. Dudley, Washington, D. C., sparrow hawk.
Mr. D. L. Du Pre, Washington, D. C., garter snake.
Mr. W. A. Eaton, Washington, D. C., alligator.
Mrs. A. F. Enquist, Washington, D. C., two canaries.
Mr. Victor J. Evans, Washington, D. C., gray coatimundi.
Mr. Raymond T. Faunce, Washington, D. C., alligator.
Mr. Enos Ferguson, Washington, D. C., six starlings.
Dr. A. K. Fisher, Washington, D. C., chuck-walla.
Mr. H. Fitzinreuter, Washington, D. C., sparrow hawk.
Mr. R. F. Funkhauser, Washington, D. C., alligator.
Mr. Julian Greene, Washington, D. C., alligator.
Mr. Alex Gregory, Washington, D. C., lesser white-fronted parrot.
Miss Harriet Hackett, Baltimore, Maryland, double yellow-head parrot.
Mrs. Edith S. Hawes, Washington, D. C., alligator.
Mr. F. K. Heindrich, Washington, D. C., two gray foxes.
Mr. A. T. S. Hore, Manaus, Brazil, matamata turtle.
Mr. C. J. Hornberger, Washington, D. C., alligator.
Mr. L. M. Humphrey, Glen Echo, Maryland, queen snake.
Mr. Perry H. Jacob, Washington, D. C., Cooper's hawk.
Mr. Hiram F. Johnson, Washington, D. C., alligator.
Mr. James S. Kerkendall, Louisville, Kentucky, ferret.
Mr. Edward B. Kirk, Manaus, Brazil, white-backed trumpeter and three American egrets.
Mr. J. A. Krentzlin, Washington, D. C., black snake.
Mr. W. J. La Varre, jr., Washington, D. C., black-headed ouakari, brown capuchin, ocelot, orange-winged parrot, scarlet ibis, two titi monkeys, two margay cats, two yellow-winged paroquets, two snowy egrets, and four tui paroquets.
Mr. T. P. Lovering, Wilmington, North Carolina, coach-whip snake.
Mr. George Mackle, Washington, D. C., woodchuck.
Miss Genevieve Magee, Washington, D. C., alligator.
Dr. W. M. Mann, Washington, D. C., Mexican kinkajou, mantled howler monkey, Central American paca, Honduras squirrel, Rossignon's snapping turtle, Central American cooter, and two speckled agoutis.
Mrs. A. D. Marks, Washington, D. C., alligator.
Mr. J. C. Meyer, Washington, D. C., five canaries.
Mrs. Joseph F. Miller, Washington, D. C., soft-shelled turtle.
Mr. W. L. Peak, Washington, D. C., barn owl.
Mrs. Winnie Harward Phillips, Washington, D. C., three chameleons, four horned toads, and five whip-tailed lizards.
Mrs. Sylvanus Billings Pond, Washington, D. C., canary.
Mr. C. D. Reeder, Lorton, Virginia, barred owl.
Mr. B. H. Roberts, Washington, D. C., woodchuck.
Mr. Henry Roberts, Washington, D. C., woodchuck.
Dr. R. W. Shufeldt, Washington, D. C., spotted turtle and two box tortoises.
Mrs. R. W. Shufeldt, Washington, D. C., painted turtle.
Mrs. Samuel Spencer, Washington, D. C., four blue-backed parrotlets.
Rear Admiral Benjamin Tappan, Altha Hall, Virginia, cardinal, red-and-blue-and-yellow macaw, and blue-and-yellow macaw.
Mr. B. M. Taylor, Houston, Tex., two ringed turtle doves.
Miss L. F. Thompson, Washington D. C., alligator.
Mr. Richard E. Tiller, Washington, D. C., wood duck.
Maj. G. O. Totten, jr., Washington, D. C., Yucatan jay, cedar waxwing, blue grosbeak, two Yucatan cardinals, two nonpareils, and three indigo buntings.

Mr. Titus Ulke, Washington, D. C., painted turtle.
Mr. Edward L. Weikert, Dickerson, Maryland, banded rattlesnake.
Mr. H. J. Wildeman, Titusville, Florida, barn owl.
Mr. Thomas Williams, Washington, D. C., barred owl.
Mr. W. N. Williams, Washington, D. C., chameleon.
Miss H. D. Wise, Washington, D. C., fish crow.

Births.—Fifty mammals were born and 72 birds were hatched in the park during the year. This record includes only such animals as are reared to a reasonable age, no account being made in these published statistics of young that live but a few days. The births include 1 hippopotamus, 1 Indian water buffalo, 1 yak, 3 llamas, 1 guanaco, 1 tahr, 2 Indian antelopes, 2 American elk, 5 European red deer, 1 barasingha deer, 1 hog deer, 4 Japanese deer, 1 fallow deer, 3 Virginia deer, 8 raccoons, 4 prairie dogs, 2 Peruvian wild guinea pigs, 3 great red kangaroos, 1 great gray kangaroo, 1 rufous-bellied wallaby, and 4 rhesus monkeys. No record was kept of the numerous domesticated guinea pigs and rabbits born during the year. The birds hatched were of the following species: Florida cormorant, black-crowned night heron, Canada goose, mallard, black duck, wood duck, redhead, peafowl, and bob-white quail.

The hippopotamus was born on May 31; it is a thrifty male, and is the second young from this same pair of animals. The nesting of the redhead duck is the first record of the breeding of this species in the park.

Exchanges.—In exchange for surplus animals born in the park there were received during the year 7 mammals, 133 birds, and 5 reptiles. The mammals included a zebu and a Burmese stag from the gardens of the Zoological Society of Philadelphia, and 2 black spider monkeys, 1 chacma baboon, 1 Canadian porcupine, and a snow leopard from miscellaneous sources. Of particular interest among the birds are many of the characteristic species of Europe: Wood pigeon, blackbird, robin redbreast, bullfinch, hawfinch, yellowhammer, goldfinch, siskin, greenfinch, brambling, and jackdaw. Neotropical birds received in exchange include the black-necked screamer, upland goose, roseate spoonbill, white ibis, seedeater, yellow-backed cacique, Yucatan jay, blue tanager, red-crowned parrot, and Mexican green macaw. Species new to the collection from Asia are the Baikal teal and the silver-eared hill-tit. One of the most valuable birds received in exchange is a fine example of the single-wattled cassowary, which is apparently referable to a little-known species, *Casuarus philipi*, of New Guinea. Five specimens of a large South American lizard, *Tupinambis teguixin*, were also added to the collection.

Purchases.—The lack of sufficient funds for the purchase of animals made it impossible to add to the collection many desirable species offered for sale from time to time. Four young harbor seals,

a Brazilian ocelot, and a collared peccary from Texas were the only mammals bought during the year. A few waterfowl were purchased for the North American lake, including 2 blue geese, 4 Hutchins's geese, 1 canvasback duck, 3 lesser scaups, 2 gadwalls, and 4 male shoveller ducks. A few native birds of prey and a single pine snake were also purchased.

Transfers.—The Biological Survey of the Department of Agriculture contributed to the collection some important animals taken for various purposes by its field agents. The most valuable of these is a lot of 6 little brown cranes (*Grus canadensis*), a species not hitherto exhibited in Washington. Other animals transferred from the Biological Survey were 9 western box-turtles from the Chiracahua Mountains, Ariz.; 2 great horned owls from Long Island, N. Y.; and a collection of small mammals, including species of *Peromyscus*, *Microtus*, and *Perognathus*. In cooperation with the State Live-stock Board of Utah, the survey also contributed, through Mr. George E. Holman, 2 young gray wolves from Grand County, Utah.

Captured in the park.—Two Virginia opossums and 30 small birds, captured in the park, were added to the collection. Among the more interesting birds so taken are examples of the European starling and Baltimore oriole.

Deposited.—The most interesting specimens received on deposit during the year are a fine male Brazilian brocket from Mrs. Lindon W. Bates, New York City; and an American marten from Mr. Ernest Thompson Seton, Greenwich, Conn. Eighteen alligators were carried over winter for the Pan American Union.

REMOVALS.

The surplus animals sent away in exchange during the year numbered 54, of which 29 were mammals and 25 birds. The exchange value was \$3,017.50, as compared with \$3,240.70 worth of animals exchanged in 1919. Most of the surplus animals were born in the park, and the shipments included 6 bison, 3 barasingha deer, 3 red deer, 5 Japanese deer, 1 hog deer, 4 llamas, 2 guanacos, 2 gray wolves, 3 red kangaroos, 4 peafowl, 3 golden pheasants, 10 Canada geese, 1 Mandarin duck, 1 bald eagle, and 6 black-crowned night-herons. A number of animals on deposit were returned to owners.

The death rate during the year, while slightly above that of 1919, was nevertheless very low, and was approximately equal to that of 1918. The specimen of the rare brown hyena (*Hyæna brunnea*) deposited in the park by Mr. E. S. Joseph in September, 1917, died of acute pneumonia on November 14, 1919. The male Philippine deer (*Rusa philippinus*) presented to the park October 17, 1904, by Admiral Robley D. Evans, died of senile cachexia October 22, 1919.

This animal was at least 4 years of age when it arrived at the park and was therefore fully 19 years old at the time of its death. The Grevy's zebra stallion, presented by Emperor Menelik, of Abyssinia, to President Roosevelt, which reached the park November 24, 1904, died, after over 15 years of life in Washington, on December 4, 1919. A pair of Japanese monkeys, received August 4, 1904, fully adult at the time, died during the year, the female on December 7, 1919, and the male on January 21, 1920. Autopsies in both cases showed splenic tumor as the immediate cause of death. A California lynx died from pyemia on September 23, 1919, almost 14 years after the date of its arrival, October 19, 1905. A female coyote, received April 26, 1906, was mercifully killed on June 10, 1920, as it was virtually helpless with disabilities of old age. An aged female Florida otter, received July 20, 1907, died on March 20, 1920, almost 13 years after its arrival in the park. Among birds long in the collection, a demoiselle crane, received July 2, 1903, was accidentally killed October 18, 1920; a crowned crane, received on May 25, 1905, died from enteritis December 26, 1919; and a red-and-blue macaw, received January 26, 1907, died on September 8, 1919.

Other serious losses during the year include a wombat, from pneumonia, August 5, 1919; the waterbuck, killed as unfit for exhibition, on November 5, 1919, after nearly 10 years of life in the antelope house; a hornbill, from enteritis, August 19, 1919; and our last specimen of the blue-headed quail dove, January 16, 1920.

Post-mortem examinations were made by the pathological division of the Bureau of Animal Industry and, in two cases, by the Army Medical Museum. The following list shows the results of autopsies, the cases being arranged by groups:

CAUSES OF DEATH.

MAMMALS.

Marsupialia: Pneumonia, 1; tuberculosis, 1; pyemia, 1; peritonitis, 1; multiple tumors in lungs, 1.

Carnivora: Pneumonia, 2; gastroenteritis, 6; pyemia, 1; metritis, 1.

Rodentia: Tuberculosis, 1; enteritis, 1; hepatitis and nephritis, 1.

Primates: Pneumonia and gastroenteritis, 1; enteritis, 1; gastroenteritis, 1; colitis, 1; dysentery, 1; tumor of spleen, 2.

Artiodactyla: Tuberculosis, 2; colitis, 1; fermentation colic, 1; senile cachexia, 1.

Perissodactyla: Acute gastroenteritis, 1.

BIRDS.

Ciconiiformes: Septicemia, 1; impaction of proventriculus, 1; accident, 2.

Anseriformes: Tuberculosis, 4; enteritis, 5; impaction of proventriculus, 1; anemia, 2; septicemia, 4; pericarditis, 1; no cause found, 2.

Falconiformes: Tuberculosis, 1.

Galliformes: Inflammation of rectum and cloaca, 1; anemia, 1; pyemia, 1; necrosis of ceca, 1; sarcoma, 1; accident, 1; no cause found, 2.

Gruiformes: Tuberculosis, 1; enteritis, 1; no cause found, 1.

Charadriiformes: Catarrhal enteritis, 1.

Psittaciformes: Tuberculosis, 1; enteritis, 3; gastritis, 1.

Coraciiformes: Enteritis, 1; no cause found, 1.

Passeriformes: Tuberculosis, 1; catarrhal enteritis, 1; no cause found, 4.

REPTILES.

Serpentes: Enteritis, 1.

Thirty-nine specimens, including 15 mammals, 21 birds, and 3 reptiles, of special scientific importance were transferred after death to the United States National Museum for permanent preservation. Two monkeys, especially desired for study, were sent immediately after death to the Army Medical Museum. Skins of birds to the number of 25 were added to the collection of "dealers' cage birds" kept for reference in the office of the superintendent, National Zoological Park.

ANIMALS IN THE COLLECTION JUNE 30, 1920.

MAMMALS.

MARSUPIALIA.	
Virginia opossum (<i>Didelphis virginiana</i>)	3
Tasmanian devil (<i>Sarcophilus harrisi</i>)	2
Australian opossum (<i>Trichosurus vulpecula</i>)	3
Dusky phalanger (<i>Trichosurus fuliginosus</i>)	2
Brush-tailed rock wallaby (<i>Petrogale penicillata</i>)	3
Black-tailed wallaby (<i>Macropus birlardieri</i>)	5
Parma wallaby (<i>Macropus parma</i>)	1
Black-tailed wallaby (<i>Macropus bicolor</i>)	1
Great gray kangaroo (<i>Macropus giganteus</i>)	4
Black-faced kangaroo (<i>Macropus melanops</i>)	2
Wallaroo (<i>Macropus robustus</i>)	1
Red kangaroo (<i>Macropus rufus</i>)	8

CARNIVORA.

Kadiak bear (<i>Ursus middendorffi</i>)	1
Alaska Peninsula bear (<i>Ursus gyas</i>)	2
Yakutat bear (<i>Ursus dalli</i>)	1
Kidder's bear (<i>Ursus kidderi</i>)	2
European bear (<i>Ursus arctos</i>)	4
Grizzly bear (<i>Ursus horribilis</i>)	2
Apache grizzly (<i>Ursus apache</i>)	1
Himalayan bear (<i>Ursus thibetanus</i>)	1
Black bear (<i>Ursus americanus</i>)	3
Kenai black bear (<i>Ursus americanus perniger</i>)	1
Cinnamon bear (<i>Ursus americanus cinnamomum</i>)	2

CARNIVORA—continued.

Florida bear (<i>Ursus floridanus</i>)	2
Glacier bear (<i>Ursus emmonsii</i>)	1
Sun bear (<i>Helarctos malayanus</i>)	1
Sloth bear (<i>Melursus ursinus</i>)	1
Polar bear (<i>Thalarctos maritimus</i>)	2
Dingo (<i>Canis dingo</i>)	1
Eskimo dog (<i>Canis familiaris</i>)	2
Gray wolf (<i>Canis nubilus</i>)	10
Southern wolf (<i>Canis floridanus</i>)	1
Woodhouse's wolf (<i>Canis frustror</i>)	2
Coyote (<i>Canis latrans</i>)	2
Red fox (<i>Vulpes fulva</i>)	5
Gray fox (<i>Urocyon cinereoargenteus</i>)	6
Cacomistle (<i>Bassariscus astutus</i>)	2
Raccoon (<i>Procyon lotor</i>)	15
Gray coatimundi (<i>Nasua narica</i>)	2
Kinkajou (<i>Potos flavus</i>)	2
Mexican kinkajou (<i>Potos flavus aztecus</i>)	1
Marten (<i>Martes americana</i>)	1
Ferret (<i>Mustela furo</i>)	1
Tayra (<i>Tayra barbara</i>)	1
Skunk (<i>Mephitis mephitis</i>)	1
American badger (<i>Taxidea taxus</i>)	2
European badger (<i>Meles meles</i>)	1
Florida otter (<i>Lutra canadensis vaga</i>)	2
African civet (<i>Viverra civetta</i>)	1
Genet (<i>Genetta genetta</i>)	1
Spotted hyena (<i>Crocuta crocuta</i>)	1
Striped hyena (<i>Hyaena hyaena</i>)	2
African cheetah (<i>Acinonyx jubatus</i>)	2
Lion (<i>Felis leo</i>)	4
Bengal tiger (<i>Felis tigris</i>)	1
Manchurian tiger (<i>Felis tigris longipilis</i>)	2
Leopard (<i>Felis pardus</i>)	1

ANIMALS IN THE COLLECTION JUNE 30, 1920—Continued.

MAMMALS—continued.

CARNIVORA—continued.

East African leopard (<i>Felis pardus suahelica</i>)	1
Jaguar (<i>Felis onca</i>)	1
Brazilian ocelot (<i>Felis pardalis brasiliensis</i>)	1
Margay cat (<i>Felis tigrina</i>)	1
Snow leopard (<i>Felis uncia</i>)	1
Mexican puma (<i>Felis azteca</i>)	2
Mountain lion (<i>Felis hipposlestes</i>)	2
Canada lynx (<i>Lynx canadensis</i>)	2
Northern wild cat (<i>Lynx uinta</i>)	3
Bay lynx (<i>Lynx rufus</i>)	2

PINNIPEDIA.

California sea lion (<i>Zalophus californianus</i>)	2
Harbor seal (<i>Phoca vitulina</i>)	1

RODENTIA.

Woodchuck (<i>Marmota monax</i>)	5
Dusky marmot (<i>Marmota flaviventris obscura</i>)	1
Prairie dog (<i>Cynomys ludovicianus</i>)	8
Honduras squirrel (<i>Sciurus boothiae</i>)	1
Fox squirrel (<i>Sciurus niger</i>)	1
Albino squirrel (<i>Sciurus carolinensis</i>)	2
Dusky pocket mouse (<i>Perognathus flavescens penniger</i>)	3
American beaver (<i>Castor canadensis</i>)	1
White-footed mouse (<i>Peromyscus leucopus noveboracensis</i>)	2
Montana white-footed mouse (<i>Peromyscus leucopus aridulus</i>)	2
Nebraska white-footed mouse (<i>Peromyscus maniculatus osgoodi</i>)	2
Canadian porcupine (<i>Erethizon dorsatum</i>)	1
Yellow-haired porcupine (<i>Erethizon epixanthum</i>)	1
Coypu (<i>Myocastor coypus</i>)	6
Paca (<i>Cuniculus paca</i>)	3
Central American paca (<i>Cuniculus paca virgatus</i>)	1
Mexican agouti (<i>Dasyprocta mexicana</i>)	1
Speckled agouti (<i>Dasyprocta punctata</i>)	2
Azara's agouti (<i>Dasyprocta azarae</i>)	2
Crested agouti (<i>Dasyprocta cristata</i>)	2
Peruvian guinea pig (<i>Cavia tschudii pallidior</i>)	5
Guinea pig (<i>Cavia porcellus</i>)	23
Capybara (<i>Hydrochoerus hydrochaeris</i>)	1

LAGOMORPHA.

Domestic rabbit (<i>Oryctolagus cuniculus</i>)	18
--	----

PRIMATES.

Black spider monkey (<i>Ateles ater</i>)	2
Gray spider monkey (<i>Ateles Geoffroyi</i>)	2
White-throated capuchin (<i>Cebus capucinus</i>)	2
Brown capuchin (<i>Cebus fatuellus</i>)	1
Margarita capuchin (<i>Cebus margaritae</i>)	1
Titi monkey (<i>Saimiri sciureus</i>)	2
Chacma (<i>Papio porcarius</i>)	2
Hamadryas baboon (<i>Papio hamadryas</i>)	1
Mandrill (<i>Papio sphinx</i>)	1
Drill (<i>Papio leucophæus</i>)	1
Moor macaque (<i>Cynopithecus maurus</i>)	1
Brown macaque (<i>Macaca speciosa</i>)	2
Burmese macaque (<i>Macaca andamanensis</i>)	1
Rhesus monkey (<i>Macaca rhesus</i>)	32
Bonnet monkey (<i>Macaca sinica</i>)	1
Javan macaque (<i>Macaca mordax</i>)	1
Philippine macaque (<i>Macaca syrichta</i>)	1
Sooty mangabey (<i>Cercocebus fuliginosus</i>)	2
Green guenon (<i>Lasiopyga callitrichus</i>)	1
Vervet guenon (<i>Lasiopyga pygerythra</i>)	2
Mona (<i>Lasiopyga mona</i>)	3
Roloway guenon (<i>Lasiopyga roloway</i>)	1
Patas monkey (<i>Erythrocebus patas</i>)	1
Chimpanzee (<i>Pan troglodytes</i>)	1

ARTIODACTYLA.	
Wild boar (<i>Sus scrofa</i>)	1
Wart hog (<i>Phacochoerus aethiopicus</i>)	2
Collared peccary (<i>Pecari angulatus</i>)	1
Hippopotamus (<i>Hippopotamus amphibius</i>)	3
Bactrian camel (<i>Camelus bactrianus</i>)	2
Arabian camel (<i>Camelus dromedarius</i>)	2
Guanaco (<i>Lama huanachus</i>)	3
Llama (<i>Lama glama</i>)	9
Alpaca (<i>Lama pacos</i>)	1
Vicuña (<i>Lama vicugna</i>)	1
Fallow deer (<i>Dama dama</i>)	4
Axis deer (<i>Axis axis</i>)	4
Hog deer (<i>Hylaphus porcinus</i>)	5
Sambar (<i>Rusa unicorn</i>)	2
Barasingha (<i>Rucervus duvaucelii</i>)	7
Burmese deer (<i>Rucervus eldi</i>)	1
Japanese deer (<i>Sika nippon</i>)	11
Red deer (<i>Cervus elaphus</i>)	20
Kashmir deer (<i>Cervus hanglu</i>)	4
Bedford deer (<i>Cervus xanthopygus</i>)	6
American elk (<i>Cervus canadensis</i>)	8
Virginia deer (<i>Odocoileus virginianus</i>)	10

ANIMALS IN THE COLLECTION JUNE 30, 1920—Continued.

MAMMALS—continued.

ARTIODACTYLA—continued.

Mule deer (<i>Odocoileus hemionus</i>)	2
Black-tailed deer (<i>Odocoileus columbianus</i>)	3
Brazilian brocket (<i>Mazama simplicicornis</i>)	1
Prong-horned antelope (<i>Antilocapra americana</i>)	1
Blesbok (<i>Damaliscus albifrons</i>)	1
White-tailed gnu (<i>Connochates gnou</i>)	1
Indian antelope (<i>Antilope cervicapra</i>)	8
Nilgai (<i>Boselaphus tragocamelus</i>)	2
East African eland (<i>Taurotragus oryx livingstonii</i>)	3
Angora goat (<i>Capra hircus</i>)	1
Tahr (<i>Hemitragus jemlahicus</i>)	3
Aoudad (<i>Ammotragus lervia</i>)	1
Rocky Mountain sheep (<i>Ovis canadensis</i>)	5
Arizona mountain sheep (<i>Ovis canadensis gaillardii</i>)	1
Barbados sheep (<i>Ovis aries</i>)	5

RATITÆ.

South African ostrich (<i>Struthio australis</i>)	4
Somaliand ostrich (<i>Struthio molybophanes</i>)	1
Rhea (<i>Rhea americana</i>)	2
Slater's cassowary (<i>Casuarus philipi</i>)	1
Emu (<i>Dromiceius novahollandia</i>)	2

CICONIIFORMES.

American white pelican (<i>Pelecanus erythrorhynchos</i>)	9
European white pelican (<i>Pelecanus onocrotalus</i>)	2
Roseate pelican (<i>Pelecanus roseus</i>)	2
Australian pelican (<i>Pelecanus conspicillatus</i>)	2
Brown pelican (<i>Pelecanus occidentalis</i>)	2
Florida cormorant (<i>Phalacrocorax auritus floridanus</i>)	20
Great white heron (<i>Ardea occidentalis</i>)	1
Great blue heron (<i>Ardea herodias</i>)	1
Goliath heron (<i>Ardea goliath</i>)	1
American egret (<i>Casmerodius egretta</i>)	3
Snowy egret (<i>Egretta candidissima</i>)	3
Black-crowned night heron (<i>Nycticorax nycticorax nevius</i>)	30
Boatbill (<i>Cochlearius cochlearius</i>)	2
White stork (<i>Ciconia ciconia</i>)	2
Black stork (<i>Ciconia nigra</i>)	1
Straw-necked ibis (<i>Carphibis spino-collis</i>)	1

ARTIODACTYLA—continued.

Zebu (<i>Bos indicus</i>)	2
Yak (<i>Poëphagus grunniens</i>)	5
American bison (<i>Bison bison</i>)	16
Indian buffalo (<i>Bubalus bubalis</i>)	3

PERISSODACTYLA.

Brazilian tapir (<i>Tapirus terrestris</i>)	2
Mongolian horse (<i>Equus przewalskii</i>)	1
Grant's zebra (<i>Equus burchellii granti</i>)	1
Grevy's zebra (<i>Equus grevyi</i>)	1
Zebra-horse hybrid (<i>Equus grevyi-caballus</i>)	1
Zebra-ass hybrid (<i>Equus grevyi-asinus</i>)	1

PROBOSCIDEA.

Abyssinian elephant (<i>Loxodonta africana oxyotis</i>)	1
Sumatran elephant (<i>Elephas sumatranus</i>)	2

BIRDS.

CICONIIFORMES—continued.

Sacred ibis (<i>Threskiornis aethiopicus</i>)	3
White ibis (<i>Guara alba</i>)	12
Scarlet ibis (<i>Guara rubra</i>)	2
Roseate spoonbill (<i>Ajaia ajaja</i>)	5
European flamingo (<i>Phenicopterus roscus</i>)	1

ANSERIFORMES.

Mallard (<i>Anas platyrhynchos</i>)	19
East Indian black duck (<i>Anas platyrhynchos var.</i>)	3
Black duck (<i>Anas rubripes</i>)	24
Gadwall (<i>Chauliastmus streperus</i>)	2
European widgeon (<i>Mareca penelope</i>)	8
Baldpate (<i>Mareca americana</i>)	7
Green-winged teal (<i>Nettion carolinense</i>)	7
European teal (<i>Nettion crecca</i>)	10
Baikal teal (<i>Nettion formosum</i>)	1
Blue-winged teal (<i>Querquedula discors</i>)	6
Garganey (<i>Querquedula querquedula</i>)	1
Cinnamon teal (<i>Querquedula cyanoptera</i>)	1
Ruddy sheldrake (<i>Casarca ferruginea</i>)	1
Shoveller (<i>Spatula clypeata</i>)	4
Pintail (<i>Dafla acuta</i>)	8
Wood duck (<i>Aix sponsa</i>)	15
Mandarin duck (<i>Dendronessa galericulata</i>)	19
Canvasback (<i>Marila valisineria</i>)	2
Redhead (<i>Marila americana</i>)	8
Ring-necked duck (<i>Marila collaris</i>)	1
Lesser scaup duck (<i>Marila affinis</i>)	8

ANIMALS IN THE COLLECTION JUNE 30, 1920—Continued.

BIRDS—continued.

ANSERIFORMES—continued.

Rosy-billed pochard (<i>Metopiana pepo-</i> <i>saca</i>) -----	1
Snow goose (<i>Chen hyperboreus</i>)-----	2
Greater snow goose (<i>Chen hyperboreus</i> <i>nivalis</i>) -----	2
Blue goose (<i>Chen caerulescens</i>)-----	7
White-fronted goose (<i>Anser albifrons</i>)--	3
American white-fronted goose (<i>Anser</i> <i>albifrons gambeli</i>)-----	3
Bar-headed goose (<i>Eulabcia indica</i>)--	1
Canada goose (<i>Branta canadensis</i>)---	19
Hutchins's goose (<i>Branta canadensis</i> <i>hutchinsii</i>) -----	9
Cackling goose (<i>Branta canadensis</i> <i>minima</i>) -----	2
Brant (<i>Branta bernicla glaucogastra</i>)--	7
Barnacle goose (<i>Branta leucopsis</i>)----	3
Spur-winged goose (<i>Plectropterus gam-</i> <i>bensis</i>) -----	2
Black-bellied tree duck (<i>Dendrocygna</i> <i>autumnalis</i>) -----	6
White-faced tree duck (<i>Dendrocygna</i> <i>viduata</i>) -----	3
Coscoroba swan (<i>Coscoroba coscoroba</i>)--	1
Mute swan (<i>Cygnus gibbus</i>)-----	4
Whistling swan (<i>Olor columbianus</i>)--	1
Trumpeter swan (<i>Olor buccinator</i>)---	1
Black swan (<i>Chenopsis atrata</i>)-----	3

FALCONIFORMES.

South American condor (<i>Vultur</i> <i>gryphus</i>) -----	1
California condor (<i>Gymnogyps cali-</i> <i>fornianus</i>) -----	3
Turkey vulture (<i>Cathartes aura</i>)-----	4
Black vulture (<i>Coragyps urubu</i>)-----	2
King vulture (<i>Sarcoramphus papa</i>)---	2
Secretary bird (<i>Sagittarius serpen-</i> <i>torius</i>) -----	1
Griffon vulture (<i>Gyps fulvus</i>)-----	1
Cinereous vulture (<i>Aegypius mona-</i> <i>chus</i>) -----	2
Caracara (<i>Polyborus cheriway</i>)-----	2
Cooper's hawk (<i>Accipiter cooperi</i>)---	1
Wedge-tailed eagle (<i>Uroaëtus audax</i>)--	2
Golden eagle (<i>Aquila chrysaëtos</i>)---	3
Bald eagle (<i>Haliaëtus leucocephalus</i>)--	13
Alaskan bald eagle (<i>Haliaëtus leucoce-</i> <i>phalus alascanus</i>) -----	1
Red-tailed hawk (<i>Buteo borealis</i>)----	5
Sparrow hawk (<i>Falco sparverius</i>)----	2

GALLIFORMES.

Razor-billed curassow (<i>Mitu mitu</i>)----	2
Mexican curassow (<i>Crax globicera</i>)--	2
Chicken-guinea hybrid (<i>Gallus</i> × <i>Nu-</i> <i>mida</i>) -----	1
Wild turkey (<i>Melcagris gallopavo sil-</i> <i>vestris</i>) -----	1

GALLIFORMES—continued.

Penfowl (<i>Pavo cristatus</i>)-----	34
Peacock pheasant (<i>Polyplectron bicat-</i> <i>caratum</i>) -----	1
Silver pheasant (<i>Gennaëus nycteme-</i> <i>rus</i>) -----	1
Ring-necked pheasant (<i>Phasianus tor-</i> <i>quatus</i>) -----	1
Bobwhite (<i>Colinus virginianus</i>)-----	1
Scaled quail (<i>Callipepla squamata</i>)---	4
Gambel's quail (<i>Lophortyx gambelii</i>)--	2
Valley quail (<i>Lophortyx californica</i> <i>vallicola</i>) -----	6

GRUIFORMES.

American coot (<i>Fulica americana</i>)---	3
South Island weka rail (<i>Ocydromus</i> <i>australis</i>) -----	3
Short-winged weka (<i>Ocydromus</i> <i>brachypterus</i>) -----	2
Earl's weka (<i>Ocydromus earli</i>)-----	1
Whooping crane (<i>Grus americana</i>)---	1
Sandhill crane (<i>Grus mexicana</i>)-----	3
Little brown crane (<i>Grus canad-</i> <i>ensis</i>) -----	6
White-necked crane (<i>Grus leucauchen</i>)--	1
Indian white crane (<i>Grus leucogera-</i> <i>nus</i>) -----	1
Lilford's crane (<i>Grus lilfordi</i>)-----	2
Australian crane (<i>Grus rubicunda</i>)---	1
Demoiselle crane (<i>Anthropoides virgo</i>)--	5
Crowned crane (<i>Balearica pavonina</i>)---	1
White-backed trumpeter (<i>Psophia leu-</i> <i>coptera</i>) -----	1
Cariama (<i>Cariama cristata</i>)-----	1

CHARADRIIFORMES.

Great black-backed gull (<i>Larus mari-</i> <i>nus</i>) -----	1
Herring gull (<i>Larus argentatus</i>)-----	1
Laughing gull (<i>Larus atricilla</i>)-----	2
Australian crested pigeon (<i>Ocyphaps</i> <i>lophotes</i>) -----	1
Bronze-wing pigeon (<i>Phaps chalcop-</i> <i>tera</i>) -----	1
Wonga-wonga pigeon (<i>Leucosarcia</i> <i>picata</i>)-----	8
Wood pigeon (<i>Columba palumbus</i>)---	7
Mourning dove (<i>Zenaidura macroura</i>)--	1
Zebra dove (<i>Geopelia striata</i>)-----	9
Bar-shouldered dove (<i>Geopelia humer-</i> <i>alis</i>) -----	2
Inca dove (<i>Scardafella inca</i>)-----	3
Ringed turtledove (<i>Streptopelia ri-</i> <i>soria</i>) -----	14

PSITTACIFORMES.

Kea (<i>Nestor notabilis</i>)-----	5
Roseate cockatoo (<i>Kakatoe roseica-</i> <i>pilla</i>) -----	10

ANIMALS IN THE COLLECTION JUNE 30, 1920—Continued.

BIRDS—continued.

PSITTACIFORMES—continued.

Bare-eyed cockatoo (<i>Kakatoe gymnopus</i>)-----	3
Leadbeater's cockatoo (<i>Kakatoe leadbeateri</i>)-----	1
White cockatoo (<i>Kakatoe alba</i>)-----	2
Sulphur-crested cockatoo (<i>Kakatoe galerita</i>)-----	2
Great red-crested cockatoo (<i>Kakatoe moluccensis</i>)-----	1
Mexican green macaw (<i>Ara mexicana</i>)--	2
Blue-and-yellow macaw (<i>Ara ararauna</i>)	2
Red-and-blue-and-yellow macaw (<i>Ara macao</i>)-----	8
Red-and-blue macaw (<i>Ara chloroptera</i>)-----	1
Thick-billed parrot (<i>Rhynchopsitta pachyrhyncha</i>)-----	2
Haitian parakeet (<i>Aratinga chloroptera</i>)-----	1
Yellow-winged parakeet (<i>Tirica virescens</i>)-----	2
Tui parakeet (<i>Brotogeris sthoma</i>)-----	4
Blue-backed parrotlet (<i>Psittacula vivida</i>)-----	1
Yellow-naped parrot (<i>Amazona auro-pallata</i>)-----	2
Yellow-cheeked parrot (<i>Amazona autumnalis</i>)-----	1
Orange-winged parrot (<i>Amazona amazonica</i>)-----	1
Red-crowned parrot (<i>Amazona viridigenalis</i>)-----	6
Double yellow-head parrot (<i>Amazona oratrix</i>)-----	10
Yellow-headed parrot (<i>Amazona ochrocephala</i>)-----	1
Yellow-shouldered parrot (<i>Amazona barbadensis</i>)-----	1
Festive parrot (<i>Amazona festiva</i>)-----	1
White-fronted parrot (<i>Amazona albifrons</i>)-----	1
Lesser white-fronted parrot (<i>Amazona albifrons nana</i>)-----	1
Santo Domingo parrot (<i>Amazona ventralis</i>)-----	2
Cuban parrot (<i>Amazona leucocephala</i>)--	1
Gray parrot (<i>Psittacus erithacus</i>)-----	1
Lesser vasa parrot (<i>Coracopsis nigra</i>)--	1
Black-tailed parakeet (<i>Polytelis melanura</i>)-----	1
Ring-necked parakeet (<i>Conurus torquatus</i>)-----	5
Grass parakeet (<i>Melopsittacus undulatus</i>)-----	2

CORACIFORMES.

Giant kingfisher (<i>Dacelo gigas</i>)-----	2
Short-keeled toucan (<i>Ramphastos piscivorus brevicarinatus</i>)-----	1
Barred owl (<i>Strix varia</i>)-----	9

CORACIFORMES—continued.

Screech owl (<i>Otus asio</i>)-----	4
Great horned owl (<i>Bubo virginianus</i>)--	7
Western horned owl (<i>Bubo virginianus pallascens</i>)-----	1
American barn owl (<i>Tyto perata praticola</i>)-----	6

PASSERIFORMES.

Silver-eared hill-tit (<i>Mesia argentauris</i>)-----	3
Red-billed hill-tit (<i>Liothrix luteus</i>)---	10
Black-gorgeted laughing-thrush (<i>Garrulus pectoralis</i>)-----	3
White-eared bulbul (<i>Otocompsa leucotis</i>)-----	3
European robin (<i>Erithacus rubecula</i>)--	1
Hermit thrush (<i>Hylocichla guttata palatalis</i>)-----	1
European blackbird (<i>Turdus merula</i>)--	3
Robin (<i>Planesticus migratorius</i>)-----	1
Western mockingbird (<i>Mimus polyglottos leucopterus</i>)-----	1
Cedar waxwing (<i>Bombycilla cedrorum</i>)-----	1
European raven (<i>Corvus corax</i>)-----	1
Australian crow (<i>Corvus coronoides</i>)--	1
Fish crow (<i>Corvus ossifragus</i>)-----	1
Jackdaw (<i>Corvus monedula</i>)-----	6
Yucatan jay (<i>Cissilopha yucatanica</i>)--	5
Blue jay (<i>Cyanocitta cristata</i>)-----	3
Green jay (<i>Xanthoura luxuosa</i>)-----	1
Australian gray jumper (<i>Struthidea cinerea</i>)-----	1
Starling (<i>Sturnus vulgaris</i>)-----	10
Crimson tanager (<i>Ramphocelus dimidiatus</i>)-----	2
Blue tanager (<i>Thraupis cana</i>)-----	3
Napoleon weaver (<i>Pyromelana afro</i>)--	1
Madagascar weaver (<i>Foudia madagascariensis</i>)-----	4
Strawberry finch (<i>Amandava amandava</i>)-----	5
Nutmeg finch (<i>Munia punctulata</i>)---	9
White-headed nun (<i>Munia maja</i>)-----	8
Java finch (<i>Munia oryzivora</i>)-----	8
White Java finch (<i>Munia oryzivora</i>)--	1
Black-faced Gouldian finch (<i>Poephila gouldiae</i>)-----	3
Zebra finch (<i>Taeniopygia castanotis</i>)--	4
Cut-throat finch (<i>Amadina fasciata</i>)--	7
Vera Cruz red-wing (<i>Agelaius phoeniceus richmondi</i>)-----	2
Baltimore oriole (<i>Icterus galbula</i>)-----	2
Purple grackle (<i>Quiscalus quiscula</i>)--	7
Black-tailed hawfinch (<i>Eophona melanura</i>)-----	1
Bullfinch (<i>Pyrrhula pyrrhula</i>)-----	2
Greenfinch (<i>Chloris chloris</i>)-----	3
Yellowhammer (<i>Emberiza citrinella</i>)--	5

ANIMALS IN THE COLLECTION JUNE 30, 1920—Continued.

BIRDS—continued.

PASSERIFORMES—continued.

European goldfinch (<i>Carduelis carduelis</i>)-----	1
Chaffinch (<i>Fringilla cœlebs</i>)-----	1
Bramblefinch (<i>Fringilla montifringilla</i>)-----	6
European siskin (<i>Spinus spinus</i>)-----	3
Mexican goldfinch (<i>Astragalinus psaltria mexicanus</i>)-----	1
House finch (<i>Carpodacus mexicanus frontalis</i>)-----	4
Purple finch (<i>Carpodacus purpureus</i>)-----	3
Canary (<i>Serinus canarius</i>)-----	9
Green singing finch (<i>Serinus icterus</i>)-----	1
Slate-colored junco (<i>Junco hyemalis</i>)-----	3
Tree sparrow (<i>Spizella monticola</i>)-----	1
White-throated sparrow (<i>Zonotrichia albicollis</i>)-----	4

PASSERIFORMES—continued.

Song sparrow (<i>Melospiza melodia</i>)-----	1
San Diego song sparrow (<i>Melospiza melodia cooperi</i>)-----	5
Fox sparrow (<i>Passerella iliaca</i>)-----	3
Towhee (<i>Pipilo erythrophthalmus</i>)-----	1
California towhee (<i>Pipilo crissalis</i>)-----	5
Saffron finch (<i>Sicalis flavicola</i>)-----	3
Seed-eater (<i>Sporophila gutturalis</i>)-----	2
Nonparcail (<i>Passerina ciris</i>)-----	1
Indigo bunting (<i>Passerina cyanea</i>)-----	3
Blue grosbeak (<i>Guiraca cœrulea</i>)-----	1
Red-crested cardinal (<i>Paroaria cucullata</i>)-----	1
Cardinal (<i>Cardinalis cardinalis</i>)-----	2
Yucatan cardinal (<i>Cardinalis cardinalis yucatanicus</i>)-----	1

REPTILES.

Alligator (<i>Alligator mississippiensis</i>)--	30	Spotted turtle (<i>Clemmys guttata</i>)-----	1
Teguexin (<i>Tupinambis teguixin</i>)-----	5	Box-tortoise (<i>Terrapene carolina</i>)-----	2
Gila monster (<i>Heloderma suspectum</i>)-----	6	Western box-tortoise (<i>Terrapene ornata</i>)-----	4
Horned toad (<i>Phrynosoma cornutum</i>)-----	3	Painted turtle (<i>Chrysemys picta</i>)-----	1
Rock python (<i>Python molurus</i>)-----	3	Cooter (<i>Pseudemys scripta</i>)-----	1
Anaconda (<i>Eunectes murinus</i>)-----	2	Florida cooter (<i>Pseudemys floridana</i>)-----	1
Boa constrictor (<i>Constrictor constrictor</i>)-----	4	Central American cooter (<i>Pseudemys ornata</i>)-----	1
Blacksnake (<i>Coluber constrictor</i>)-----	1	Gopher tortoise (<i>Gopherus polyphemus</i>)-----	2
Chicken snake (<i>Elaphe quadrivittata</i>)-----	1	Duncan Island tortoise (<i>Testudo ephippium</i>)-----	1
Water snake (<i>Natrix sipedon</i>)-----	4	Albemarle Island tortoise (<i>Testudo vicina</i>)-----	1
Queen snake (<i>Natrix septemvittata</i>)-----	1	Matamata turtle (<i>Chelys fimbriata</i>)-----	1
Garter snake (<i>Thamnophis sirtalis</i>)-----	2	Soft-shelled turtle (<i>Amyda ferow</i>)-----	1
Moccasin (<i>Agkistrodon piscivorus</i>)-----	1		
Ground rattler (<i>Sistrurus miliarius</i>)-----	1		
Snapping turtle (<i>Chelydra serpentina</i>)-----	2		
Rossignol's snapping turtle (<i>Chelydra rossignonii</i>)-----	1		

STATEMENT OF THE COLLECTION.

ACCESSIONS DURING THE YEAR.

	Mammals.	Birds.	Reptiles.	Total.
Presented.....	21	65	41	127
Born and hatched in National Zoological Park.....	50	72	122
Received in exchange.....	7	133	5	145
Purchased.....	6	33	1	40
Transferred from other Government departments.....	11	8	9	28
Captured in National Zoological Park.....	2	30	32
Deposited.....	5	1	18	24
Total.....	102	342	74	518

SUMMARY.

Animals on hand July 1, 1919.....	1,336
Accessions during the year.....	518
Total animals handled.....	1,854
Deduct loss (by exchange, death, and return of animals on deposit).....	427
Animals on hand June 30, 1920.....	1,427

Class.	Species.	Individuals.
Mammals.....	166	496
Birds.....	225	847
Reptiles.....	28	84
Total, June 30, 1920.....	419	1,427

It will be interesting at this time to submit figures showing the comparative size of the collection at the close of each fiscal year since the foundation of the park. The years and numbers of animals are as follows:

1892.....	448	1907.....	1,193
1893.....	504	1908.....	1,402
1894.....	510	1909.....	1,416
1895.....	520	1910.....	1,424
1896.....	553	1911.....	1,414
1897.....	567	1912.....	1,551
1898.....	549	1913.....	1,468
1899.....	675	1914.....	1,362
1900.....	839	1915.....	1,397
1901.....	878	1916.....	1,383
1902.....	883	1917.....	1,223
1903.....	1,000	1918.....	1,247
1904.....	1,111	1919.....	1,336
1905.....	1,307	1920.....	1,427
1906.....	1,272		

The number of animals is now 124 under that of the record year (1912), but is greater than has been maintained since 1913. The monetary and scientific value of the collection is, however, very much greater than ever before.

VISITORS.

The attendance for the fiscal year, as determined by count and estimate, was 2,229,605, a daily average of 6,108. This is the first time that the official records have gone above 2,000,000. The greatest number of visitors in any one month was 402,403, in April, 1920, an average per day of 13,413. The largest single day's attendance in the history of the park occurred in this month, on Sunday, the 11th, when 95,000 people were admitted to the gates. The other

three Sundays in April show attendance records of 25,000, 87,000, and 55,000.

The attendance by months was as follows: In 1919: July, 125,700; August, 230,255; September, 268,941; October, 205,398; November, 204,944; December, 74,161. In 1920: January, 55,547; February, 27,099; March, 203,803; April, 402,403; May, 265,604; June 165,750.

Ninety-six schools and classes visited the park during the year, with a total of 8,959 individuals. As usual, these came largely from the District of Columbia, Maryland, and Virginia; but several were from States as distant as Pennsylvania and Massachusetts.

IMPROVEMENTS.

The most needed improvement completed during the year is the public-comfort station at the Harvard Street entrance. This building is set into the steep hillside just inside the gate, and is so nearly hidden by the natural growth of trees, especially by the low-sweeping branches of some fine beeches, that comparatively little planting was necessary to improve the ground around it.

The row of old wooden cages, along the hill just north of the bird house, the first cages used in the park, some of which were originally brought from the Smithsonian grounds when the park was first occupied, were replaced by nine new inclosures for strictly outdoor animals, especially for the medium-sized carnivores not requiring artificial heat. The new cages are made of iron framework, covered with heavy mesh wire, with cement floors, and comfortable, sanitary retiring rooms in the rear. The largest of these new cages, 20 by 20 by 12 feet in size, is now occupied by the Mexican pumas. The other eight, from 10 by 16 by 9 feet to 14 by 16 by 10 feet in size, are used for the snow leopard, lynxes, certain of the *Canidæ*, and a large chacma baboon. The type of construction adopted for these cages has proved exceedingly satisfactory, and the airy, cleanly quarters are much admired by the visitors.

The quarters occupied by the chimpanzee in summer having proved unsatisfactory since this animal became mature, it was decided to prepare outdoor cages for his use adjoining his winter home in the lion house. The hyena cage next to his indoor quarters was therefore remodeled and connected with his main apartment, and two spacious outdoor yards prepared for his use. He now has two comfortable indoor rooms and two outdoor yards, which makes the problem of his care much more simple, as it is not necessary with the new arrangement for his keepers to work while he is in the same room or outdoor cage.

Among minor improvements completed during the year are wide concrete steps connecting the walk in front of the bears with the walk on the lower level along the sea-lion and beaver pools; new

drainage gutters at antelope house; new fence along hilltop below children's playground and sand boxes near the Adams Mill entrance; and repairs to road between Klingle entrance and the upper ford. The reconstruction of the old outdoor chimpanzee cage into quarters suitable for a grizzly bear and the re-covering of the large outdoor cage for the California condors were both well under way, and would have been completed before the close of the fiscal year but for the fact that the cement and wire needed in the work could not, at that time, be obtained in Washington.

Alteration of the western boundary.—This item has been considered in the annual report for many years, and it is therefore especially gratifying now to be able to report actual progress on the purchase of the land necessary to protect the western entrance. The sundry civil act for 1921, approved during the past year, carries an appropriation of \$80,000 for the purchase of all the land between the western boundary of the park and the unnamed street connecting Cathedral Avenue with Klingle Road, excepting one small lot at the southern end, together with 300 feet each side of Jewett Street fronting on Connecticut Avenue. All of Jewett Street, which now connects the park with Connecticut Avenue, and the included portion of the unnamed street running parallel with Connecticut Avenue are to become a part of the National Zoological Park, and a 50-foot roadway at each end of the area to be purchased will be taken over by the District of Columbia to connect the unnamed street with Connecticut Avenue. The area appropriated for includes 209,050.5 square feet, and the park will now be bounded at this point by public highways instead of privately owned property. The frontage on Connecticut Avenue, including the former Jewett Street, will be 625 feet—ample for all purposes.

IMPORTANT NEEDS.

Restaurant.—As mentioned in the last annual report one of the most urgent needs of the park is a suitable public restaurant. The present refreshment stand, entirely inadequate and in a bad state of repair, is unsuited to the present-day crowds of visitors. It is believed that an up-to-date building on the present site, 50 by 100 feet in size, and of two floors, one opening onto the lower slope to the west, would meet the requirements and would pay the Government a fair income in rent. Preliminary plans for such a building have been made by the office of the municipal architect; the present estimated cost of construction is \$65,400.

Alteration of the southeastern boundary.—The District government has now opened Adams Mill Road from the southeastern entrance of the National Zoological Park to Harvard Street and a narrow strip

of land, between the park and this new roadway, between Clydesdale Place and Ontario Road, still in private ownership, should become Government property. This narrow strip of land is of very little use, except possibly for garages, and its close proximity to the entrance to the park makes its public ownership of great importance. The amount required for its purchase is comparatively small and its acquisition by the park or by the District of Columbia should not long be delayed. The cost should not exceed \$4,000.

Outdoor quarters for mammals.—Provision should be made for the exhibition of lions, Siberian tigers, and other mammals now occupying quarters in certain buildings, in outdoor inclosures with warm but unheated shelters. The animals themselves would be greatly improved by such conditions and the space they now occupy in buildings would become available for animals actually requiring heated quarters in winter. It is proposed that, when funds may be obtained for the purpose, large inclosures of this type be constructed on the space between the lion house and the monkey house now utilized as a paddock for ostriches.

The most urgent need of the park at the present time is increased compensation for certain of the employees, particularly the keepers and policemen. While the rate of pay for these and other employees has been slightly increased during the past four years, the increase has in no measure kept pace with the cost of living, and it is becoming more difficult all the time to retain valuable and trained men in the service.

Respectfully submitted.

N. HOLLISTER, *Superintendent.*

Dr. CHARLES D. WALCOTT,

Secretary, Smithsonian Institution, Washington, D. C.

APPENDIX 5.

REPORT ON THE ASTROPHYSICAL OBSERVATORY.

SIR: The Astrophysical Observatory was conducted under the following passage of the sundry civil act approved July 19, 1919:

Astrophysical Observatory: For maintenance of Astrophysical Observatory, under the direction of the Smithsonian Institution, including assistants, purchase of necessary books and periodicals, apparatus, making necessary observations in high altitudes, repairs and alterations of buildings, and miscellaneous expenses, \$13,000.

The observatory occupies a number of frame structures within an inclosure of about 16,000 square feet south of the Smithsonian administration building at Washington, and also a cement observing station and frame cottage for observers on a plot of 10,000 square feet leased from the Carnegie Solar Observatory, on Mount Wilson, Calif.

The present value of the buildings and equipment is estimated at \$50,000. This estimate contemplates the cost required to replace the outfit for the purpose of the investigation.

WORK OF THE YEAR.

At Washington.—Much labor was expended on the preparation of tables of results for publication in Volume IV of the Annals of the Observatory.

Under Mr. Fowle's direction, the Mount Wilson observations of 1919 were reduced and compared with those obtained by Smithsonian observers in Chile. An experiment had been made in using rolled stellite instead of cast stellite to prepare new spectroscope mirrors for the South American work. As these mirrors were not quite finished when Director Abbot went south to observe the eclipse of May 28 (as related in last year's report) he took with him the Mount Wilson spectroscope mirrors, intending that the new ones should replace them on Mount Wilson. Unfortunately, they proved unsuitable owing to a gradual alteration of figure after completion, but were nevertheless used on Mount Wilson by Mr. Aldrich for the experiments of 1919.

The matter is mentioned here because the defective mirrors introduced stray light in the spectrum, which led to a systematic error of 2

per cent (in defect) in the Mount Wilson solar constant values of 1919. Considerable additional labor was required in the reductions on this account. Furthermore, the sky was unusually hazy and streaky on Mount Wilson in 1919, which also added to the labor and anxiety of determining the best values from the observations.

Agreement of Mount Wilson and Chilean work.—However, the results when finally worked out proved to agree excellently, except for the systematic error above mentioned, with the results obtained in Chile. Both stations showed simultaneous and nearly equal fluctuations of solar radiation through a range of about 5 per cent. After allowing for the aforesaid 2 per cent systematic error of Mount Wilson, the average deviation of the two stations was but 0.013 calorie, or 0.65 per cent from all the values, about 50 in number, obtained on corresponding days. Omitting five values very discordant, when the Mount Wilson sky was very hazy and streaky, the average deviation of the remaining days was about 0.008 calorie, or 0.4 per cent.

Solar variation confirmed by observations of Saturn.—From correspondence with Dr. Guthnick, of the Berlin-Babelsberg Observatory, a most interesting confirmation of the solar variability has appeared. Variations of brightness of the planet Saturn from January to May, 1920, were shown by Dr. Guthnick's photo-electric observations which could not be accounted for after allowance for all known sources of variability. These outstanding variations were found to be in almost exact correlation with fluctuations of the solar radiation as observed at Calama, Chile. One per cent increase in solar radiation was found to accompany 1 per cent increase of Saturn's brightness.

These results, however, were only derived in connection with one of two possible interpretations of the nature of solar variation. The sun might vary in such a manner that its changes would be observed simultaneously in all directions and so would occur on identical days on all the planets. This hypothesis *does not fit* the available observations of the sun and Saturn. On the other hand, the solar radiation may be unequal in different directions. Such inequalities are, in fact, indicated by the ragged raylike structure of the solar corona. On this hypothesis a change of solar radiation would occur as ray after ray strikes the earth in the course of the sun's rotation upon its axis. These same unequally intense rays would reach the planet Saturn either before or after they reached the earth, according to the relative heliocentric longitudes of the earth and Saturn. The sun rotates about 14° a day, so that the angular difference in position of the two planets is to be divided by 14° to indicate the number of days allowance to be made between the dates of corresponding solar and Saturnian measurements.

Proceeding on this second hypothesis, extraordinarily close correspondence between the variations of the sun and Saturn was found.

Further work of the kind is to be done at Saturn's next opposition. It will be noted that this second hypothesis of the nature of the solar variation relieves us of the great difficulty of understanding how so immense a body as the sun could vary in radiation so rapidly as our observations indicate. We have now only to suppose that there are inequalities of radiation in different directions which may be due to the absorption or scattering of the rays in the coronal regions near the sun. These inequalities may persist with little alteration for weeks. We, however, note them as variations of solar radiation as they sweep by us in the course of the sun's rotation on its axis.

The honeycomb pyranometer.—Mr. Aldrich constructed two copies of a new instrument devised by Abbot and Aldrich for measuring "nocturnal radiation." We call it provisionally the "honeycomb pyranometer." In this instrument a long thin ribbon of "therlo" resistance metal about one-half inch wide and one one-thousandth of an inch thick is bent in such a way as to make up into 200 cells of triangular cross section all included in a total cross-sectional area of about 1 inch square. The corners of the cells are electrically insulated with baked shellac so that a current of electricity can be caused to flow from end to end of the ribbon and thus all around each cell. Radiation which enters the front of the cells from any source, if not absorbed there is reflected to and fro within the cells till it reaches their rear ends. There its remnant emerges upon a silvered mirror inclined at a small angle so as to throw back the rays to make a second course to and fro toward the front. Thus by repeated absorptions the rays are at length almost wholly converted into heat. The device is, in short, a "black body." But unlike other "black-body" receivers, its central cells are protected from losses of heat to the sides by reason of the nearly equally warmed cells surrounding them. Thus the instrument is almost as sensitive as a flat blackened strip, but possesses the valuable property of being fully absorbing, which a strip does not. The temperature difference between the central cells and the case of the instrument is indicated by thermoelectric elements. By passing a proper electric current through the "therlo" ribbon the same temperature difference can be produced as by radiation. The known energy of the electric current becomes the desired measure of the energy of radiation, as in Ångström's pyrheliometer. Also the constant of the apparatus is calculable from the known dimensions of it. It is possible, too, to observe the solar radiation with this instrument, and so to calibrate it. Measurements of this kind check very closely with the computed values.

Messrs. Aldrich and Abbot made a series of measurements with the honeycomb pyranometer on various sources of radiation, including comparisons with the ordinary pyranometer on incandescent

lamps of different kinds, and also observations on large hollow radiators at different constant temperatures. Values of the constant of the fourth power law of radiation differing by only 1 per cent from the best accepted value were readily obtained in this latter work. On the whole the "honeycomb pyranometer" is an instrument of great promise for standard measurements.

. *Experiments on the constant "sigma."*—In collaboration with Dr. C. E. Mendenhall, a new attempt was begun to devise means to measure the constant of radiation with greater certainty. Apparatus was devised and constructed in the Observatory shop for this purpose. There was not time to try it before the departure of Messrs. Abbot and Aldrich into the field, so that the apparatus was loaned to Dr. Mendenhall for trial at the University of Wisconsin.

Field work at Mount Wilson.—Mr. Aldrich continued observing on Mount Wilson until October, 1919. As said above, the year was unfavorable both by reason of a defect in equipment and by reason of much haze, cirrus cloud, and streakiness of sky. Also on many days a curious wandering of the galvanometer needle occurred. This phenomenon has been noted at Mount Wilson occasionally in former years, but was unusually pronounced in 1919. By anticipation, it may be remarked that it occurred also very markedly in late July and in August, 1920. The march of the galvanometer spot in these wanderings is relatively slow. A centimeter or two back and forth upon the scale in one to two minutes is the usual magnitude. It occurs with the galvanometer unconnected to the bolometer. Reastaticising of the needle system till it turned in the earth's field at the same rate as the supporting quartz fiber failed to cure the trouble. The Mount Wilson expedition was renewed in June, 1920, by Messrs. Abbot and Aldrich.

Proposed station in Arizona.—The prevailing cirrus cloudiness and haziness at Mount Wilson in all recent years, greatly exceeding that which obtained from 1905 to 1910, when the station was new, has been very discouraging. Furthermore, the station is quite unsuitable for "solar-constant" work in winter and spring months owing to cloudiness. It is urgently desirable to observe the solar radiation daily, as far as possible, in the United States, in order to check the results which are being obtained by Smithsonian observers in Chile.

Accordingly it seemed best to set up a station in the most cloudless region of the United States, where the work could go on during the entire year. Chief Marvin, of the Weather Bureau, obligingly caused investigations to be made of various proposed sites in California, Nevada, and Arizona. The one of highest promise appeared to be on the Harqua Hala Mountain (elevation about 5,800 feet) near Wenden, Ariz. Congress was urged to appropriate \$25,000 for the

establishment of a first-rate "solar-constant" observing station at the best site, but the appropriation failed.

At this juncture Messrs. Abbot and Marvin held a long discussion by correspondence and verbally as to the reality of the supposed solar variability, and its availability as a forecasting element, in view of the use being made of the Smithsonian solar observations in Chile by the Argentine and Brazilian weather bureaus. The discussion brought out very clearly the urgency of obtaining corroborative observations of the solar radiation daily in the United States.

Fortunately the proposed new station obtained private financial support in the lack of congressional action. Mr. John A. Roebing, of Bernardsville, N. J., at Dr. Abbot's solicitation, made a grant of \$11,000 for promoting measurements of solar radiation. Mr. Roebing made the condition that so much of this sum as necessary should be devoted to removing the Smithsonian station from the plain near Calama, Chile, to a mountain site above the reach of dust and smoke. Any balance remaining after this improvement of the Chilean station could be used for the removal of the Mount Wilson equipment to the Harqua Hala Mountain in Arizona, or for such other purpose as Dr. Abbot might prefer for the advance of the study of solar radiation.

At a cost of between \$4,000 and \$5,000 the Calama station was removed to a mountain about 10 miles south of Calama, where skies of extraordinary purity have been experienced. The removal was completed and first observations made at the mountain shortly after the close of the fiscal year.

Dr. Abbot visited Wenden, Ariz., and the Harqua Hala Mountain in the last week of June, 1920. Contracts were made for the erection on the summit of a stone and adobe building of two stories, a lower, partly underground, for observing, and an upper for quarters of observers. This is to be ready for occupancy by September 15, 1920, when it is proposed to remove the "solar-constant" observing equipment from Mount Wilson to Harqua Hala.

The purpose of these improvements is to enable us to obtain nearly every day in the year first-rate check observations of the "solar constant" of radiation at two stations remote from one another in the two hemispheres. Only thus is it possible to lay a firm foundation of solar observations extending over a considerable interval of time, which will enable meteorologists to determine if the sun's variations are really of value as a weather-forecasting element. In view of the results published by Mr. H. H. Clayton, of the Argentine weather service, there is sufficient evidence that this may be the case to warrant the expense and discomfort attending the continuous occupation of two desert mountain observatories like Harqua Hala and the Chilean station.

Great appreciation is due Mr. John A. Roebling for his generous aid in stepping into the breach at this time when it proved impossible to obtain public support for the urgent need. Only the most primitive equipment has, it is true, been possible on the Harqua Hala Mountain with the means available. Unfortunately, too, it means a considerable restriction of other interesting investigations under way or proposed, owing to the partial dismantling of the Mount Wilson station. This is greatly to be regretted. It is recommended that Congress be urged to appropriate the money needed to complete the independent equipment of Harqua Hala, so as to permit needed apparatus to return to Mount Wilson. The Harqua Hala station should also be relieved of its limitations of water, of accessibility, and of communication, and the buildings made more commodious. Otherwise it will be only at such personal sacrifice of comfort as few can be found willing to make that its work can go on.

PERSONNEL.

Miss Inez Ensign resigned as computer on September 22, 1919. Miss F. A. Graves returned as computer from leave for overseas work in France on September 4, 1919. Miss Gladys Thurlby, computer, married, on May 8, 1920, Mr. Albion M. Bond, but remained in the service of the Observatory.

SUMMARY.

The year has been marked by the practical completion for publication of Volume IV of the Annals, but no appropriation is yet available for its publication. Close agreement in solar variation was found for 1918 and 1919 between results of Mount Wilson, Calif., and Calama, Chile, 4,000 miles apart. A further remarkable confirmation of the solar variation comes from a comparison of Smithsonian observations in Chile with photo-electric observation of the brightness of Saturn by Dr. Guthnick, of the Berlin-Babelsberg Observatory. This comparison indicates that the nature of the rapid solar variation consists in the rotation with the sun of rays of unequal brightness which strike the different planets successively in the order of their longitudes and fall one after the other upon the earth as the sun by rotation brings them into line with us. A new nocturnal radiation instrument, provisionally called the "honeycomb pyranometer" on account of its cellular structure, and which employs the well-known hollow-chamber principle of the "absolutely black" body, but without loss of sensitiveness, has been successfully constructed and tried. By the generosity of Mr. John A. Roebling, of New Jersey, it has been possible to remove the Chile station to a

mountain above the dust and smoke of its former plateau location, and also to erect a building on the Harqua Hala Mountain, in Arizona, to which the Mount Wilson solar-constant work will be removed in September, 1920.

Respectfully submitted.

C. G. ABBOT, *Director.*

Dr. C. D. WALCOTT,
Secretary, Smithsonian Institution.

APPENDIX 6.

REPORT ON THE INTERNATIONAL CATALOGUE OF SCIENTIFIC LITERATURE.

SIR: I have the honor to submit the following report on the operations of the United States Bureau of the International Catalogue of Scientific Literature for the fiscal year ending June 30, 1920.

At the beginning of the war six volumes of the eleventh issue were still to be published, and only one volume of the twelfth issue had appeared.

In spite of the evident financial difficulty ahead of the Catalogue, the Royal Society decided that publication should be continued through the fourteenth issue, covering the year 1914. The deficit has since been met by generous contributions from the Royal Society, the Carnegie Corporation of New York, and other sources. All of the volumes of the thirteenth and fourteenth issues have now been published excepting those for Geology and Physiology of the fourteenth issue, which are both in advanced stages of preparation. Much of the material for the fifteenth and later issues is now in the hands of the Central Bureau awaiting only authority for its publication.

On account of the general upheaval felt among all international organizations as soon as war began, it became impossible for the International Catalogue to continue its work in the satisfactory manner which up to that time had characterized the enterprise. A brief review of the history and aims of the international organization may be repeated in order that the future aims and plans may be better understood.

When the publication was begun in 1901 it was for the purpose of satisfying a recognized demand for a complete authors' and subject index of all current scientific literature. This demand was to be met by publishing in annual volumes, one for each recognized branch of pure science, a complete authors' and subject index to its current literature. Each branch of science was to be covered by volumes containing complete citations of the author, title, and source of every original paper, comprising first an authors' index and second a classified sub-

ject index so arranged by means of classification schedules that the literature on any subject in any of the sciences might be readily found. The schedules were issued prior to the publication of the first volumes of the Catalogue and were prepared in every case by specialists who were careful to take into consideration the needs of scientists as well as of librarians and students. Provision was made to include new subjects and introduce new methods of reference as the demand arose, in recognition of the fact that practically all of the sciences are in a constant state of transition and that a plan satisfactory at one time would probably be inadequate to meet the needs of a later period.

Omitting the greater part of the intervening history of the work, it may be said that in 1910, at a conference held in London to discuss the affairs of the Catalogue, it was recognized that although changes had been made in many of the schedules, a general revision was necessary and a committee was appointed to superintend this revision. Authority was given to this committee by a resolution which reads as follows:

That a committee be appointed to revise the schedules and to make such other alterations as may be necessary in the form of issue of the Catalogue. That it may be an instruction to the committee that, so far as possible, the subject index be confined to abbreviated titles and authors' names and numbers to serve as references to the authors' index.

It will thus be seen that plans were in preparation to greatly increase the usefulness of the Catalogue, but before they were put into effect the war came and all progress was necessarily checked, and although the war is now over, financial conditions still prevent the introduction of new and improved methods. In spite of the fact that the publication of the Catalogue was begun under financial difficulties, as no working capital was available, by 1914, when the war began, the receipts and expenditures practically balanced.

The delay in the publication of the annual volumes is recognized as the most serious defect in the enterprise, but with this remedied, as it would have been but for the war, and with the schedule revision in effect as provided for in the resolution above quoted, it is undoubtedly true that the International Catalogue would now meet all practical requirements of an annual authors' and subject catalogue to the literature of pure science.

A résumé of the condition of the work at present can not better be given than by quoting a statement made by Prof. Henry E. Armstrong, who as dean of the enterprise and chairman of its executive committee, is of all persons connected with the Catalogue the one best fitted to report on its affairs.

The progress made in the publication of the International Catalogue since its foundation in 1900 is nothing short of remarkable. Two hundred and forty-

two volumes have been published, indexing the scientific literature of the period 1901-1914. An extraordinarily broad, sound foundation has been laid and much helpful experience gained. The difficulties that were expected to arise have either been nonexistent or were easily overcome. To have established so complete an organization on a thoroughly successful working basis is in itself a feat of no mean order and most creditable to all concerned, not only to the staff of the Central Bureau but also to the various regional bureaus.

The real difficulty by which the work has always been hampered is want of a working capital; this has affected both the Central and the regional bureaus. Had funds been always available, publication would have been far more rapid and the work might have been more fully developed. Almost every criticism that has been leveled at the Catalogue involves its extension, and therefore additional expenditure.

The International Catalogue was established primarily to meet the demands of scientific workers by furnishing an annual authors' and subject catalogue and index to the literature of each of the recognized branches of science; but as it is now evident that a general revision of the methods of production will be necessary, as soon as international affairs become stabilized, it would appear advisable when this revision becomes operative to establish some form of cooperation with the many existing abstract journals and, so far as possible, to encourage and aid the establishment of abstract journals in sciences not already represented. This need for abstract journals is now pressing for recognition, especially in the United States, and the preparation and publication of abstracts is so akin to that of scientific yearbooks that economy of effort in the production of both branches of bibliography evidently demands a very close cooperation. These abstract journals, organized and directed by workers in the several sciences represented, would, when published, form the basis of the annual volumes of an authors' and subject index similar to the present International Catalogue of Scientific Literature, preferably by the reorganization of that international project which already receives official recognition and support from practically all of the countries of the world, acting through some 30 regional bureaus.

By some simply organized method of cooperation between the abstract journals and the Catalogue, both branches would mutually aid one another to a very great extent and would in practice act as one organization. The abstracts and citations published in the abstract journals would form the basis of the Catalogue, thereby greatly simplifying the work of the regional bureaus, which in turn would aid the abstract journals in many ways and relieve them of the necessity of publishing annual indexes, at present quite an expensive and laborious undertaking. The abstract journals and annual indexes would together furnish to scientific investigators, librarians, and others interested in scientific subjects all that they severally require.

Owing to the financial difficulty which has involved the International Catalogue since war began, the Royal Society, which since the beginning of the undertaking has been the financial sponsor of the Catalogue, has issued invitations to scientific academies and institutions to send delegates to a special conference to open on September 28, 1920, in London to discuss the future of the International Catalogue. As the need for a catalogue of scientific literature is universally acknowledged, and as the present organization of the International Catalogue up to the time of the beginning of the war was meeting this demand in a more satisfactory manner than ever before, and as the present organization has behind it the official support of all of the principal countries of the world, it appears obvious that every effort should be made to continue and improve the work rather than abandon it simply on account of temporary financial troubles and later have to reestablish the organization to cover the same ground. Many projects are now being promoted to publish abstracts, indexes, and catalogues of scientific publications, but the question of finance seems to be a common paramount difficulty, and it will certainly require less money to assure the success of the present organization than it would to organize and finance a new project.

Very respectfully, yours,

LEONARD C. GUNNELL,
Assistant in Charge.

Dr. CHARLES D. WALCOTT,
Secretary, Smithsonian Institution.

APPENDIX 7.

REPORT ON THE LIBRARY.

SIR: I have the honor to submit the following report on the activities of the library of the Smithsonian Institution during the fiscal year ended June 30, 1920:

The receipts of publications compare most favorably with those of preceding years. Packages withheld from the mails during the war have begun to come in, and war regulations limiting exchanges have been largely removed. Although many societies were forced to limit distribution or to suspend publication during the war, it is expected that the receipts will continue to increase when shipments through the international exchanges may again be made between the United States and the Central Powers. The receipts for the year ended were 23,810 packages, 22,495 of which were received by mail and 1,315 through the international exchanges. Eight hundred and eighty volumes were completed and 14,273 entries were made.

The library has suffered, however, from a lack of cataloguers to carry on the work. The question of salaries for cataloguers in the library is a serious one, as those doing similar work elsewhere are receiving at least 33 per cent more. One desk has been vacant for practically the entire year, and as the staff already was very small this has been a serious handicap.

SMITHSONIAN MAIN LIBRARY.

Publications for the Main Library, after entry on the records, are forwarded to the Library of Congress for deposit in the Smithsonian Division. The accession numbers for the year extended from 532,003 to 534,618, the accessions including 3,634 volumes, 186 parts, 157 pamphlets, and 42 charts.

The cataloguing covered 2,332 volumes and 32 charts; 848 volumes were recatalogued; 2,280 cards were typewritten and 618 cards from the Library of Congress, for publications deposited there by the Institution, were filed in the catalogue; 3,756 public documents were

presented to the Library of Congress in accordance with the established practice.

Dissertations were received from the Universities of Toulouse, Paris, Utrecht, Lund, Ghent, Helsingfors, Bonn, Basel, Lausanne, Zurich, and Geneva.

The securing of publications in exchange for the completion of sets has been continued, with the following results:

Number of want cards received from Library of Congress:

From Smithsonian Division.....	176
From Periodical Division.....	79
From Order Division.....	30
Total.....	285

Number of publications secured for Library of Congress:

	Vols.	Parts.
For Smithsonian Division.....	313	316
For Periodical Division.....	11	66
For Order Division.....	13	36
Total.....	337	418

Number of sets completed, 73.

With exchanges to the Central Powers still suspended, shipments delayed, and many societies suspending publication, the time for securing missing parts has been far from favorable. It is worthy of note, however, that in spite of the unfavorable conditions a larger proportion of the wants have been secured in exchange than in years previous, as may be seen by the following table:

Years.	Want cards received.	Sets completed.	Per cent.
1915-16.....	387	82	21.0
1917-18.....	996	186	18.6
1919-20.....	514	134	26.0

Requests sent out for missing parts, it will be seen, are more effective by 5 per cent than those sent out before the war. It is hoped that when shipments to the Central Powers through the International Exchange Service are resumed and overseas shipments can be delivered more promptly that still better results can be secured.

SMITHSONIAN OFFICE LIBRARY.

The accessions for the office library amounted to 300 volumes and 7 pamphlets, not including the set of publications of the Carnegie Institution of Washington, numbering more than 300 volumes, which has been placed on deposit by Secretary Walcott. In order to provide adequate shelving space for these volumes it was necessary to

rearrange the books already in the reference room, and as a result practically all of the shelving space is now occupied. The circulation of books in the reference room was 218 volumes.

Aeronautical collection.—The aeronautical collection, as in the past, has been consulted by students of aeronautics of foreign countries as well as those of the United States. Additional cases in the hall of the Smithsonian Institution have been set aside for the accommodation of this collection, so that it is now more accessible to the public. Forty new titles were added during the year.

De Peyster collection.—Author cards for the Napoleon series, numbering more than 1,200 volumes, have been made, and the books have been arranged in regular order in the cases in the hall of the Smithsonian Institution. Author cards have been made also for the series in British, German, and Italian history.

Reading room.—The number of magazines loaned during the year from the reading room was 2,907, a decrease of 233, as compared with the preceding year. The service has suffered from the fact that no binding could be done, owing to the exhaustion of the funds available for this purpose.

Employees' library.—The increased use of the employees' library is noteworthy. Six hundred and forty-one volumes were loaned, as compared with 332 last year.

MUSEUM LIBRARY.

There have been no additions to the Museum library of exceptional importance. Valuable material has been contributed, however, by Dr. Charles D. Walcott, Mr. W. R. Maxon, Maj. Gen. John R. Brooke, Dr. A. J. Boving, Dr. F. H. Knowlton, Dr. J. M. Aldrich, Dr. W. H. Holmes, Dr. Mary J. Rathbun, Dr. W. H. Dall, Dr. O. P. Hay, Mr. William Schaus, Dr. C. W. Richmond, Mr. Austin H. Clark, Dr. Walter Hough, Mr. A. N. Caudell, and the Knab estate.

Accessions.—Two thousand five hundred and forty-eight accessions were received during the year, including 1,932 completed volumes and 1,581 pamphlets. The number of books in the library is now 145,307; including 56,617 volumes and 88,690 parts of volumes and pamphlets.

Periodicals.—Thirteen thousand four hundred and thirty-two periodicals were entered during the year; 2,619 section cards for periodicals and 858 section cards for volumes were made. The number of new cards for periodicals was 351.

Cataloguing.—The number of catalogue cards added was 2,748; 744 books and 1,529 pamphlets were catalogued.

Loans.—The number of books loaned out was 9,802. Of these, 2,145 books, including 1,951 from the Library of Congress, were borrowed from other libraries. Fully as many volumes were consulted, but were not taken out.

Binding.—Owing to the increasing cost of binding, the library's funds allotted for that purpose were exhausted in January, 1920. As will be seen by the figures below, the library's allotment for binding has not kept pace with the increases in cost. As a consequence the number of books sent to the Government bindery has been steadily decreasing. Following are the number sent during the past three fiscal years:

1918	-----	1,706
1919	-----	1,322
1920	-----	737

With a constantly increasing supply of volumes and many publications received during the present and past fiscal years still unbound, the library is greatly handicapped and is unable to render the service that it should.

Technological series.—Additions to the technological library during the year, exclusive of duplicates, number 200 bound volumes, 2,983 pamphlets, and 2,576 periodicals; 2,245 cards have been added to the scientific depository catalogue. A special effort has been made to complete the files of publications, especially United States Government documents. The books and periodicals loaned during the year were 200.

Sectional libraries.—Following is a complete list of sectional libraries:

Administration.
 Administrative assistant's office.
 Anthropology.
 Biology.
 Birds.
 Botany.
 Comparative anatomy.
 Editor's office.
 Ethnology.
 Invertebrate paleontology.
 Mammals.

Marine invertebrates.
 Materia medica.
 Mechanical technology.
 Mesozoic fossils.
 Minerals.
 Physical anthropology.
 Prehistoric archeology.
 Property clerk.
 Registrar's office.
 Reptiles and batrachians.
 Superintendent's office.

BUREAU OF AMERICAN ETHNOLOGY LIBRARY.

A report of the operations of the library of the Bureau of American Ethnology will be found in the report of that bureau. This library is administered under the direct care of the chief of the bureau.

ASTROPHYSICAL OBSERVATORY LIBRARY.

Further additions to the library of the Astrophysical Observatory number 87 volumes, 10 parts of volumes, and 16 pamphlets.

NATIONAL ZOOLOGICAL PARK LIBRARY.

To the National Zoological Park library there were added six volumes and two pamphlets.

SUMMARY OF ACCESSIONS.

The accessions during the year, with the exception of those in the library of the Bureau of American Ethnology, may be summarized as follows:

To the Smithsonian deposit in the Library of Congress, including parts to complete sets.....	4, 019
To the Smithsonian office, Astrophysical Observatory, and National Zoological Park libraries.....	428
To the United States National Museum library.....	2, 548
Total.....	6, 995

Respectfully submitted.

PAUL BROCKETT,
Assistant Librarian.

Dr. CHARLES D. WALCOTT,
Secretary, Smithsonian Institution.

APPENDIX 8.

REPORT ON THE PUBLICATIONS.

SIR: I have the honor to submit the following report on the publications of the Smithsonian Institution and its branches during the year ending June 30, 1920:

The Institution proper published during the year 14 papers in the series of Miscellaneous Collections, 1 annual report and pamphlet copies of 20 articles in the appendix to the report, and 1 special publication. The Bureau of Ethnology published 1 annual report and 3 separate papers from the same report, and 4 bulletins. The United States National Museum issued 1 annual report, 3 volumes of the proceedings, 33 separate papers forming parts of these and other volumes, 5 bulletins, and 9 separate parts of bulletins.

The total number of copies of publications distributed by the Institution and its branches was 143,290, which includes 157 volumes and separates of the Smithsonian Contributions to Knowledge, 24,949 volumes and separates of the Smithsonian Miscellaneous Collections, 16,720 volumes and separates of the Smithsonian annual reports, 81,936 volumes and separates of National Museum publications, 16,761 publications of the Bureau of American Ethnology, 1,958 special publications, 19 volumes of the Annals of the Astrophysical Observatory, 23 reports on the Harriman Alaska Expedition, and 564 reports of the American Historical Association.

SMITHSONIAN MISCELLANEOUS COLLECTIONS.

Of the Miscellaneous Collections, volume 67, 2 papers were issued; volume 69, 2 papers; volume 70, 3 papers; volume 71, 5 papers; volume 72, 2 papers; in all, 14 papers, as follows:

VOLUME 67.

No. 5. Cambrian Geology and Paleontology. IV, No. 5. Middle Cambrian Algae. By Charles D. Walcott. December 26, 1919. Pp. 217-260, pls. 43-59. (Publ. 2542.)

No. 6. Cambrian Geology and Paleontology. IV, No. 6. Middle Cambrian Spongiae. By Charles D. Walcott. April 21, 1920. Pp. 261-364, pls. 60-90. (Publ. 2580.)

VOLUME 69.

No. 1. Smithsonian Meteorological Tables. August 19, 1919. 261 pp. (Publ. 2493.)

No. 5. Mammals of Panama. By Edward A. Goldman. April 22, 1920. 309 pp., 39 pls. (Publ. 2498.)

VOLUME 70.

No. 2. Explorations and field-work of the Smithsonian Institution in 1918. July 15, 1919. 122 pp., 127 figs. (Publ. 2535.)

No. 3. Archeological investigations at Paragonah, Utah. By Neil M. Judd. July 15, 1919. 22 pp., 15 pls. (Publ. 2536.)

No. 4. Temperature variations in the North Atlantic Ocean and in the atmosphere. Introductory studies on the cause of climatological variations. By Björn Helland-Hansen and Fridtjof Nansen. Hodgkins Fund. April 17, 1920. 408 pp., 48 pls. (Publ. 2537.)

VOLUME 71.

No. 2. A method of reaching extreme altitudes. By Robert H. Goddard. December 30, 1919. 69 pp., 10 pls. (Publ. 2540.)

No. 3. Variation in solar radiation and the weather. By H. Helm Clayton (introductory note by C. G. Abbot). January 15, 1920. 53 pp., 5 pls. (Publ. 2544.)

No. 4. The brightness of the sky. By A. F. Moore and L. H. Abbot. Hodgkins Fund. February 4, 1920. 36 pp. (Publ. 2545.)

No. 5. Observations of the total solar eclipse of May 29, 1919. By C. G. Abbot and A. F. Moore. January 31, 1920. 12 pp., 1 pl. (Publ. 2578.)

No. 6. New species of piper from Panama. By Casimir de Candolle. February 12, 1920. 17 pp. (Publ. 2579.)

VOLUME 72.

No. 1. Explorations and field-work of the Smithsonian Institution in 1919. May 8, 1920. 80 pp., 77 figs. (Publ. 2581.)

No. 2. Two new East African primates. By N. Hollister. January 22, 1920. 2 pp. (Publ. 2582.)

SMITHSONIAN ANNUAL REPORTS.

REPORT FOR 1917.

The complete volume of the Annual Report of the Board of Regents for 1917, together with pamphlet copies of the papers in the general appendix, was received from the Public Printer during the year.

Annual Report of the Board of Regents of the Smithsonian Institution, showing operations, expenditures, and condition of the Institution for the year ending June 30, 1917. xii+674 pp., 241 pls. (Publ. 2502.)

The appendix contained the following papers:

Projectiles containing explosives, by Commandant A. R. 16 pp. (Publ. 2503.)

Gold and silver deposits in North and South America, by Waldemar Lindgren. 27 pp. (Publ. 2504.)

The composition and structure of meteorites compared with that of terrestrial rocks, by George P. Merrill. 14 pp., 9 pls. (Publ. 2505.)

Corals and the formation of coral reefs, by Thomas Wayland Vaughan. 88 pp., 37 pls. (Publ. 2506.)

The correlation of the quaternary deposits of the British Isles with those of the continent of Europe, by Charles E. P. Brooks. 99 pp. (Publ. 2507.)

Natural history of Paradise Key and the near-by everglades of Florida, by W. E. Safford. 58 pp., 64 pls. (Publ. 2508.)

Notes on the early history of the pecan in America, by Rodney H. True. 14 pp. (Publ. 2509.)

Floral aspects of the Hawaiian Islands, by A. S. Hitchcock. 14 pp., 25 pls. (Publ. 2510.)

The social, educational, and scientific value of botanic gardens, by John Merle Coulter. 6 pp. (Publ. 2511.)

Bird rookeries of the Tortugas, by Paul Bartsch. 32 pp., 38 pls. (Publ. 2512.)

Catalepsy in Phasmidae, by P. Schmidt. 5 pp. (Publ. 2513.)

An economic consideration of orthoptera directly affecting man, by A. N. Caudell. 8 pp. (Publ. 2514.)

An outline of the relations of animals to their inland environments, by Charles C. Adams. 28 pp. (Publ. 2515.)

The National Zoological Park—A popular account of its collections, by N. Hollister. 51 pp., 46 pls. (Publ. 2516.)

The sea as a conservator of wastes and a reservoir of food, by H. F. Moore. 14 pp., 8 pls. (Publ. 2517.)

Ojibway habitations and other structures, by David I. Bushnell, jr. 9 pp., 6 pls. (Publ. 2518.)

National work at the British Museum—Museums and advancement of learning, by F. A. Bather. 15 pp. (Publ. 2519.)

Leonard Fuchs, physician and botanist, 1501–1566, by Felix Neumann. 13 pp., 7 pls. (Publ. 2520.)

In memoriam—Edgar Alexander Mearns, 1856–1916, by Charles W. Richmond. 14 pp., 1 pl. (Publ. 2521.)

William Bullock Clark. 4 pp. (Publ. 2522.)

REPORT FOR 1918.

The general appendix to the report for 1918, which was still in press at the close of the year, contains the following papers:

1. The discovery of helium, and what came of it, by C. G. Abbot.
2. An account of the rise of navigation, by R. H. Curtiss.
3. The tornadoes of the United States, by Robert DeC. Ward.
4. Wind power, by James Carlill.
5. A tribute. Samuel Pierpont Langley: Pioneer in practical aviation, by Henry Leffmann.
6. Modern physics, by R. A. Millikan.
7. The experiments of Dr. P. W. Bridgman on the properties of matter when under high pressure. Introductory note by C. G. Abbot.
8. The problem of radioactive lead, by Theodore W. Richards.
9. Sphagnum moss; war substitute for cotton in absorbent surgical dressings, by George E. Nichols.
10. History of military medicine and its contributions to science, by Col. W. P. Chamberlain.

11. Some problems of international readjustment of mineral supplies as indicated in recent foreign literature, by Eleanora F. Bliss.
12. Reptile reconstructions in the United States National Museum, by Charles W. Gilmore.
13. A Pleistocene cave deposit of western Maryland, by J. W. Gidley.
14. Paleobotany: A sketch of the origin and evolution of floras, by Edward W. Berry.
15. The direct action of environment and evolution, by Prince Kropotkin.
16. The law of irreversible evolution, by Branislav Petronievics.
17. The fundamental factor of insect evolution, by S. S. Chetverikov.
18. The psychic life of insects, by E. L. Bouvier.
19. Sexual selection and bird song, by Chauncey J. Hawkins.
20. Marine camoufleurs and their camouflage: The present and prospective significance of facts regarding coloration of tropical fishes, by W. H. Longley.
21. Foot-plow agriculture in Peru, by O. F. Cook.
22. Sun worship of the Hopi Indians, by J. Walter Fewkes.
23. The League of the Iroquois and its constitution: A constitutional league of peace in the Stone Age of America, by J. N. B. Hewitt.
24. The problem of degeneracy, by H. F. Tredgold.
25. History in tools, by W. M. Flinders Petrie.
26. The background of Totemism, by E. Washburn Hopkins.
27. A great naturalist: Sir Joseph Hooker, by Sir E. Ray Lankester.

REPORT FOR 1919.

The report of the executive committee and proceedings of the Board of Regents of the Institution and report of the Secretary, both forming part of the annual report of the Board of Regents to Congress, were issued in pamphlet form in November, 1919.

Report of the executive committee and proceedings of the Board of Regents of the Smithsonian Institution for the year ending June 30, 1919. 18 pp. (Publ. 2548.)

Report of the Secretary of the Smithsonian Institution for the year ending June 30, 1919. 106 pp. (Publ. 2547.)

The general appendix to this report was in preparation but did not go to the printer until shortly after the close of the year.

SPECIAL PUBLICATIONS.

The following special publication was issued:

Publications of the Smithsonian Institution issued between October 16, 1918 and July 16, 1919. August 12, 1919. 1 p. (Publ. 2541.)

PUBLICATIONS OF THE UNITED STATES NATIONAL MUSEUM.

The publications of the National Museum are: (*a*) The annual report to Congress; (*b*) the proceedings of the United States National Museum; and (*c*) the Bulletin of the United States National Museum, which includes the Contributions from the United States National Herbarium. The editorship of these publications is vested in Dr. Marcus Benjamin.

During the year ending June 30, 1920, the Museum published 1 annual report, 3 volumes of the proceedings, 33 separate papers forming parts of these and other volumes, 5 bulletins, and 9 separate parts of bulletins.

The issues of the proceedings were as follows: Volumes 54, 55, and 56.

The issues of the bulletins were as follows:

Bulletin 103. Contributions to the geology and paleontology of the Canal Zone, Panama, and geographically related areas in Central America and the West Indies. Prepared under the direction of Thomas Wayland Vaughan.

Bulletin 106 (text). North American early Tertiary Bryozoa, by Ferdinand Canu and Ray S. Bassler.

Bulletin 107. Life histories of North American diving birds. Order Pygopodes. By Arthur Cleveland Bent.

Bulletin 108. A revision of the nearctic termites, by Nathan Banks, with notes on biology and geographic distribution, by Thomas E. Snyder.

Contributions from the United States National Herbarium, volume 21. Flora of the District of Columbia and vicinity, by A. S. Hitchcock and Paul C. Standley.

Of the separate papers of bulletins, the following were issued:

Bulletin 100. Contributions to the biology of the Philippine Archipelago and adjacent regions. Volume 1, part 6: The relationships of the genera *Calcarina*, *Tinoporus*, and *Baculogypsina* as indicated by recent Philippine material, by Joseph A. Cushman. Volume 2, part 3: *Pyrosoma*—A taxonomic study based upon the collections of the United States Bureau of Fisheries and the United States National Museum, by Maynard M. Metcalf and Hoyt S. Hopkins.

Bulletin 103. Contributions to the geology and paleontology of the Canal Zone, Panama, and geologically related areas in Central America and the West Indies. Pages 189-524: Fossil corals from Central America, Cuba, and Porto Rica, with an account of the American Tertiary, Pleistocene, and recent coral reefs, by Thomas Wayland Vaughan.

Of the remaining separates, 4 formed parts of volume 20 and 2 of volume 22, contributions from the United States National Herbarium, while 1 was from volume 55, 16 from volume 56, and 16 from volume 57 of the proceedings.

PUBLICATIONS OF THE BUREAU OF AMERICAN ETHNOLOGY.

The publications of the bureau are described in detail in Appendix 2 of this report. The editorial work of the bureau is under the direction of Mr. Stanley Searles, editor.

During the past year four bulletins, the Thirty-third Annual Report, and three separates from this report were published, as follows:

Bulletin 60. Handbook of Aboriginal American Antiquities. By W. H. Holmes. 380 pp.

Bulletin 68. Structural and Lexical Comparison of the Tunica, Chitimacha, and Atakapa Languages. By John R. Swanton.

Bulletin 69. Native Villages and Village Sites East of the Mississippi. By David I. Bushnell, jr. 111 pp., 17 pls.

Bulletin 70. Prehistoric Villages, Castles, and Towers. By J. Walter Fewkes. 79 pp., 33 pls.

Thirty-third Annual Report—Accompanying Papers: (1) Uses of plants by the Indians of the Missouri River region (Gilmore); (2) Preliminary account of the antiquities of the region between the Mancos and La Plata Rivers in southwestern Colorado (Morris); (3) Designs on prehistoric Hopi pottery (Fewkes); (4) The Hawaiian romance of Laie-ika-wai (Beekwith). 677 pp. 95 pls.

Three separates from the Thirty-third Annual Report.

There were in press at the close of the year five annual reports and nine bulletins. The bulletins were as follows:

Bulletin 67. Alsea Texts and Myths (Frachtenberg).

Bulletin 71. Native Cemeteries and Forms of Burial East of the Mississippi (Bushnell).

Bulletin 72. The Owl Sacred Pack of the Fox Indians (Michelson).

Bulletin 73. Early History of the Creek Indians and their Neighbors (Swanton).

Bulletin 74. Excavations at Santiago, Ahuizotla, D. F. Mexico (Tozzer).

Bulletin —. Northern Ute Music (Densmore).

Bulletin —. Mandan and Hidatsa Music (Densmore).

Bulletin —. Handbook of the Indians of California (Kroeber).

Bulletin —. Archeological Investigations in the Ozark Region of Central Missouri (Fowke).

REPORT OF THE AMERICAN HISTORICAL ASSOCIATION.

The annual reports of the American Historical Association are transmitted by the association to the Secretary of the Smithsonian Institution, and are communicated to Congress under the provisions of the act of incorporation of the association.

Volume 2 of the report for 1916 was published during the year, and the reports for 1917 and 1918 were in press at the end of the year.

REPORT OF THE NATIONAL SOCIETY OF THE DAUGHTERS OF THE AMERICAN REVOLUTION.

The manuscript of the Twenty-second Annual Report of the National Society of the Daughters of the American Revolution was transmitted to Congress according to law in June, 1920.

THE SMITHSONIAN ADVISORY COMMITTEE ON PRINTING AND PUBLICATION.

The Smithsonian advisory committee on printing and publication passes upon all manuscripts offered for publication by the Institution or its branches and considers all forms of routine, blanks, and such other matters as pertain to printing and publication. Ten meetings were held during the year and 93 manuscripts were acted upon.

Respectfully submitted.

W. P. TRUE, *Editor.*

DR. CHARLES D. WALCOTT,

Secretary of the Smithsonian Institution.

REPORT OF THE EXECUTIVE COMMITTEE OF THE BOARD OF REGENTS OF THE SMITHSONIAN INSTITUTION FOR THE YEAR ENDING JUNE 30, 1920.

To the Board of Regents of the Smithsonian Institution:

Your executive committee respectfully submits the following report in relation to the funds, receipts, and disbursements of the institution and a statement of the appropriations by Congress for the National Museum, the international exchanges, the Bureau of American Ethnology, the National Zoological Park, the Astrophysical Observatory, the International Catalogue of Scientific Literature, etc., for the year ending June 30, 1920, together with balances of previous appropriations:

SMITHSONIAN INSTITUTION.

Condition of the fund July 1, 1920.

The sum of \$1,000,000 deposited in the Treasury of the United States under act of Congress is a permanent fund, having been accumulated by the deposit of bequests from time to time. Subsequent bequests and the income therefrom are invested in approved securities. The several specific funds so invested are now constituted as follows and classed as the consolidated fund:

Hodgkins general fund.....	\$37,275.00
Rhees fund	117.00
Avery fund	16,898.84
Addison T. Reid fund.....	2,150.00
Lucy T. and George W. Poore fund.....	4,968.00
George K. Sanford fund.....	221.00
Smithson fund	1,304.00
Chamberlain fund	10,000.00
Bruce Hughes fund.....	8,355.93
Hamilton fund	500.00
Lucy H. Baird fund.....	1,106.25
Total consolidated fund.....	82,896.02

Several lots of unimproved land near the city of Lowell, Mass., forming a part of the legacy known as the Lucy T. and George W. Poore fund, were sold during the year and the sum of \$440.07 was realized and invested.

Statement of receipts and disbursements from July 1, 1919, to June 30, 1920.

RECEIPTS.

Cash on deposit and in safe July 1, 1919.....		\$2, 122. 78
Interest on fund in United States Treasury_ \$60, 000. 00		
Other interest	5, 651. 37	
	<u>\$65, 651. 37</u>	
Repayments, rentals, publications, etc.....	14, 525. 09	
Contributions for specific purposes.....	41, 171. 82	
Bills receivable	50, 000. 00	
Proceeds from sale of real estate.....	440. 07	
		<u>171, 788. 35</u>
		<u>173, 911. 13</u>

DISBURSEMENTS.

Buildings, care and repairs.....		9, 613. 05
Furniture and fixtures.....		1, 599. 44
General expenses:		
Salaries	21, 124. 74	
Meetings	124. 00	
Stationery.....	648. 09	
Postage, telegraph, and telephone.....	736. 34	
Freight	72. 82	
Incidentals, fuel, and lights.....	885. 93	
Garage	1, 079. 29	
		<u>24, 671. 21</u>
Library		2, 888. 03
Publications and their distribution:		
Miscellaneous collections.....	9, 277. 00	
Reports	151. 19	
Special publications.....	10. 50	
Publication supplies	217. 39	
Salaries.....	7, 246. 82	
Harriman publications	38. 82	
		<u>16, 942. 32</u>
Explorations and researches.....		5, 784. 95
Hodgkins specific fund, researches, and publications.....		10, 044. 32
International exchanges		1, 900. 37
Consolidated fund (invested).....		6, 995. 39
Bills receivable, time certificates.....		40, 000. 00
Interest accrued, consolidated fund.....		78. 99
Advances for field expenses, etc.....		40, 088. 72
		<u>160, 606. 79</u>
Deposited with Treasurer of the United States and in bank	13, 104. 34	
Cash on hand.....	200. 00	
		<u>13, 304. 34</u>
		<u>173, 911. 13</u>

The itemized report of the auditor confirms the foregoing statement of receipts and expenditures, and is approved. A summary of the report follows:

CAPITAL AUDIT Co.,
PUBLIC ACCOUNTANTS & AUDITORS,
Washington, D. C.

Executive Committee, Board of Regents, Smithsonian Institution.

SIR: We have examined the accounts and vouchers of the Smithsonian Institution for the fiscal year ended June 30, 1920, and certify the following to be a correct statement:

Total receipts.....	\$171, 788. 35
Total disbursements.....	160, 606. 79
Excess of receipts over disbursements.....	11, 181. 56
Amount from July 1, 1919.....	2, 122. 78
Balance on hand June 30, 1920.....	13, 304. 34
Balance as shown by Treasurer's statement as of June 30, 1920.....	14, 696. 41
Less outstanding checks.....	5, 139. 16
Balance.....	9, 557. 25
Balance, American National Bank.....	3, 547. 09
Cash on hand.....	200. 00
Balance June 30, 1920.....	13, 304. 34

The vouchers representing payments from the Smithsonian income during the year, each of which bears the approval of the secretary or, in his absence, of the acting secretary, and a certificate that the materials and services charged were applied to the purposes of the institution, have been examined in connection with the books of the institution and agree with them.

CAPITAL AUDIT Co.,
By WILLIAM L. YAEGER, *President.*

All payments are made by check signed by the secretary of the institution, on the Treasurer of the United States, and all revenues are deposited to the credit of the same account, except in some instances small deposits are now made in bank for convenience of collection and later are withdrawn in round amounts and redeposited in the Treasury.

The practice of investing temporarily idle funds in time deposits has proven highly satisfactory. During the year the interest derived from this source has amounted to \$1,320.60.

Your committee also presents the following summary of appropriations for the fiscal year 1920 intrusted by Congress to the care of the Smithsonian Institution, balances of previous appropriations at the beginning of the fiscal year, and amounts unexpended on June 30, 1920:

	Available after July 1, 1919.	Balance June 30, 1920.
International Exchanges, 1918.....	\$893.24	¹ \$4.38
International Exchanges, 1919.....	3,794.55	11.99
International Exchanges, 1920.....	45,000.00	9,883.06
American Ethnology, 1918.....	430.21	¹ 353.56
American Ethnology, 1919.....	5,885.29	722.75
American Ethnology, 1920.....	42,000.00	6,495.68
International Catalogue, 1918.....	585.10	¹ 220.43
International Catalogue, 1919.....	1,186.75	910.34
International Catalogue, 1920.....	7,500.00	1,365.70
Astrophysical Observatory, 1918.....	230.67	¹ 168.67
Astrophysical Observatory, 1919.....	2,663.21	94.61
Astrophysical Observatory, 1920.....	13,000.00	770.34
Observations, Eclipse of Sun, 1918.....	1,455.33	¹ 191.20
National Museum:		
Furniture and fixtures, 1918.....	48.14	¹ 48.14
Furniture and fixtures, 1919.....	910.99	188.98
Furniture and fixtures, 1920.....	20,000.00	2,022.26
Heating and lighting, 1918.....	372.78	¹ 110.13
Heating and lighting, 1919.....	6,245.76	291.11
Heating and lighting, 1920.....	55,000.00	20,426.49
Preservation of collections, 1918.....	4,943.88	¹ 4,358.03
Preservation of collections, 1919.....	33,383.19	24,998.73
Preservation of collections, 1920.....	300,000.00	7,792.65
Books, 1918.....	292.80	¹ 137.47
Books, 1919.....	1,356.36	440.95
Books, 1920.....	2,000.00	1,442.15
Postage, 1920.....	500.00	
Building repairs, 1918.....	46.37	¹ 34.37
Building repairs, 1919.....	3,530.81	18.20
Building repairs, 1920.....	10,000.00	427.15
Heating and equipping aircraft building, 1920.....	14,000.00	1,190.13
National Zoological Park, 1918.....	2.53	¹ 2.53
National Zoological Park, 1919.....	10,534.95	6.13
National Zoological Park, 1920.....	115,000.00	7,868.67
Increase of compensation, 1920 (indefinite).....		

¹ Carried to credit of surplus fund.

Statement of estimated income from the Smithsonian fund and from other sources accrued and prospective, to be available during the fiscal year ending June 30, 1921.

Cash balance, June 30, 1920.....	\$13,304.34
Interest on fund deposited in United States Treasury due July 1, 1920, and Jan. 1, 1921.....	\$60,000.00
Bills receivable.....	20,000.00
Interest from miscellaneous sources.....	6,036.00
Exchange repayments, sale of publications, refund of advances, etc.....	10,861.35
Deposits for specific purposes.....	12,000.00
	<u>108,897.35</u>

Total available for year ending June 30, 1921..... 122,201.69

Respectfully submitted.

GEO. GRAY,
HENRY WHITE,
Executive Committee.

PROCEEDINGS OF THE BOARD OF REGENTS OF THE SMITHSONIAN INSTITUTION FOR THE FISCAL YEAR ENDING JUNE 30, 1920.

ANNUAL MEETING DECEMBER 11, 1919.

The board met at the institution at 10 o'clock a. m.

Present: The Hon. Edward D. White, Chief Justice of the United States, chancellor, in the chair; The Hon. Thomas R. Marshall, Vice President of the United States; Senator Henry Cabot Lodge; Representative Lemuel P. Padgett; Representative Frank L. Greene; The Hon. George Gray; Dr. Alexander Graham Bell; Mr. Charles F. Choate, jr.; Mr. John B. Henderson; and the secretary, Mr. Charles D. Walcott.

APPOINTMENT OF REGENTS.

The secretary announced the appointment, by joint resolution of Congress, approved by the President January 7, 1919, of Mr. Robert S. Brookings, of Missouri, as a citizen regent to fill the vacancy caused by the death of the Hon. Charles Warren Fairbanks.

Also that the Hon. George Gray, of Delaware, had been reappointed by joint resolution approved by the President February 26, 1919.

Also that Senator Medill McCormick had been appointed by the Vice President on December 2, 1919, to succeed Senator Hollis, whose term as Senator had expired.

CHAIRMANSHIP OF EXECUTIVE COMMITTEE.

On motion, it was

Resolved: That the Hon. George Gray be reelected a member of the executive committee, and that he be continued in the position of chairman of the committee.

RESOLUTION RELATIVE TO INCOME AND EXPENDITURE.

Judge Gray, chairman of the executive committee, submitted the following resolution, which was adopted:

Resolved: That the income of the institution for the fiscal year ending June 30, 1921, be appropriated for the service of the institution, to be expended by the secretary with the advice of the executive committee, with full discretion on the part of the secretary as to items.

ANNUAL REPORT OF THE EXECUTIVE COMMITTEE.

Judge Gray presented the Annual Report of the Executive Committee showing the financial condition of the institution for the fiscal year ending June 30, 1919, which was adopted.

ANNUAL REPORT OF THE PERMANENT COMMITTEE.

Judge Gray presented the annual report of the permanent committee as follows:

DECEMBER 11, 1919.

To the Board of Regents of the Smithsonian Institution.

GENTLEMEN: Your permanent committee submits herewith its report for the past year on the matters under its supervision:

Hodgkins fund.—At the last annual meeting of the board, held December 12, 1918, your committee reported that \$15,000 had been allotted from the Hodgkins fund to Dr. Charles G. Abbot, director of the Astrophysical Observatory, for the purpose of carrying on researches in solar radiation at a station to be established in the Argentine Republic. It was explained that war conditions prevented this, and that instead, work had been done in North Carolina and at a station established at Calama, Chile. The latter work is now under way, and additional allotments amounting to \$8,200 have been made.

Under the allotment of \$5,000 previously reported, Dr. R. H. Goddard, of Clark College, Worcester, Mass., has continued his work in developing certain devices to be used in connection with the study of the temperature of the higher atmospheric strata.

Avery bequest.—One lot only, No. 140 East Capitol Street, remains to be disposed of to close up the Avery estate, which now totals \$28,874.74.

The Poore bequest.—Since the last report several of the lots belonging to this property, situated in Lowell, Mass., have been sold. With these additions and the earnings of the fund to date the bequest now amounts to \$29,730.10.

The Bruce Hughes bequest to be used for the founding of the Hughes Alcove, now totals \$9,797.12.

Freer Art Gallery fund.—The condition of the fund is as follows:

Receipts-----	\$1,349,251.48
Expenditures-----	1,091,467.69
Balance-----	257,783.79
	<hr/>
	1,349,251.48

Consolidated fund.—The consolidated fund of the institution, which consists of investments in excess of the permanent fund of \$1,000,000 deposited in the United States Treasury, now totals \$71,554.38.

On motion, the report of the permanent committee was accepted.

REPORT OF THE COMMITTEE ON THE USE OF THE MUSEUM BUILDINGS.

In the absence of Mr. Henry White, chairman, the following report was presented by Senator Lodge:

DECEMBER 11, 1919.

To the Board of Regents of the Smithsonian Institution.

GENTLEMEN: In the absence of the chairman, Mr. Henry White, I submit the following report:

At the last annual meeting of the board, your committee reported upon the occupancy of the Natural History Building of the National Museum by the Bureau of War Risk Insurance, showing that 138,600 square feet of its first and second floors had been allotted to the purposes of the bureau, accommodating over 5,000 of its employees. To provide this space, the building had been closed to the public in compliance with the request of the President.

It was the understanding that the bureau would remove to its own quarters at Vermont Avenue and H Street upon the completion of the building then in course of construction, and return to the National Museum the space it had occupied there in the same condition in which it had been turned over to the bureau. The bureau vacated the museum in the latter part of March, but for lack of funds was unable to fulfill its obligations as to repairs; and it was not until April 22 that the Museum, out of its limited funds, could prepare the building so as to be reopened.

Your committee is pleased to report, however, that the deficiency act of November 4, 1919, carries an item of \$5,640 which the Bureau of War Risk Insurance is authorized to pay to the National Museum on account of the repairs and other expenses incident to the bureau's occupancy.

Respectfully submitted.

(Signed) H. C. LODGE,
Member of Committee.

On motion, the report was accepted.

ANNUAL REPORT OF THE SECRETARY.

The secretary submitted his annual report for the fiscal year ending June 30, 1919, which was accepted.

THE SECRETARY'S SUPPLEMENTAL STATEMENT.

Needs of National Museum.—The pressing needs of the National Museum are additional space for the accommodation of its collections and the increase in its scientific and technical staff, the space congestion especially rapidly becoming more pronounced and embarrassing. It is evident that if the museum is to keep reasonable pace with the development of the country, these needs must be met.

The Natural History Building was designed exclusively and is needed entirely for the natural history collections. It has been necessary, however, to make provision in this building for the National Gallery of Art, one large hall in the first story being devoted to that purpose. Further crowding has resulted from the utilization of the west and northwest ranges and the foyer with adjoining rooms in the ground story and the rotunda in the first story in the assembling of the war collections.

In the Arts and Industries Building conditions are even more serious. By 1917 the building was overcrowded owing to the development of the various divisions in arts and industries, particularly textiles and mineral technology. The great increase in the collections for the Division of History is due largely to the acquisition

of the material for the War Museum, which has necessarily increased the crowded condition of all of the halls.

The museum quarters in the Smithsonian Building are also congested. The laboratory space of the division of plants, the National Herbarium, has become so inadequate that it will be necessary to ask for the erection of a new gallery. This, however, would only provide for its normal growth for possibly five years.

In 1917 the Congressional Public Buildings Commission was informed that the museum would require two new buildings to properly accommodate its collections, and that the prompt erection of one for immediate needs was urgently necessary. Conditions have materially changed since then, making additional housing still more imperative. The close of the war, the attendant revival of the industries and the arts, and particularly the development of the war collections, have all brought to the museum greatly increased collections of vital interest and value.

	Square feet exhibition.
The National Gallery of Art now needs.....	90,000
To care for its reasonable growth for next 10 years not less than.....	150,000
The historical collections now need.....	100,000
To care for their reasonable growth for next 10 years not less than....	200,000

The National Gallery of Art received in 1919 one collection valued at \$400,000. With the present inadequate facilities, gifts and loans are being rejected because we have absolutely no space for exhibiting these objects, nor can we properly care for such gifts in storage. This condition of affairs is so thoroughly understood throughout the country that those who would present their art treasures to the National Gallery of Art are forced to place them in civic and private institutions.

The following floor space is now occupied by the museum in the three buildings:

	Square feet.
Natural History Building.....	468,118
Arts and Industries Building.....	143,488
Smithsonian Building (portion used by the museum).....	34,236
Total.....	645,842

The war collection.—During the period which has elapsed since July 1, 1919, the collection of material designed to illustrate the history of the recent war and known as the Museum War Collection has received many very large and notable additions. Of particular interest are the following: A 37-millimeter infantry field gun, a 75-millimeter American made French gun representing the type of ordnance most used by the Allies during the war, three types of trench mortars, namely, a 3-inch, 6-inch, and 9.45-inch, with mounts and accessories. There have also been added to the ordnance ma-

terial many types of shells, a number of which are sectionalized showing the methods of manufacture and the character of the interior of these important implements of war. The Museum has just put on exhibition a rare German message shell, deposited by Maj. Gen. H. L. Rogers, Quartermaster General of the Army. As far as known, this shell is one of only two in America, the other being in the possession of the Chief of Ordnance. The message shell was used, toward the end of the war only, to send a message from one body of German troops to another where all lines of communication had been destroyed.

On the end of the shell was a colored fuse, red or yellow, depending on the importance of the message. The fuse was ignited, the time being set for the proper distance, and at the desired point in the flight of the shell the end of the shell was thrown out, releasing an inner container and an immense cloud of black smoke covering an area of 300 yards. This smoke cloud both indicated the location and afforded a screen under which the German was enabled to leave his trench and pick up the container with message. A sample of the paper, on which the message was written with two carbon copies, is shown with the shell.

The shell was presented to Gen. Rogers by Lieut. John J. Raezer, Quartermaster Corps, who found it with salvaged property. This shell is shown in the Museum in connection with a large number of other interesting German relics of the war. Of special interest in this connection is a collection of materials used in trench warfare, including offensive and defensive grenades, gas grenades, signal flares, and other objects of the same character.

The Engineer Department has added a complete set of paraphernalia used by that department during the war. This collection includes giant search lights, motor trucks, complete sets of engineer tools, and examples of delicate instruments used by this branch of the Army.

In addition to the material of this character illustrating the activities of our own Army the Museum has received from France, through the assistance of Gen. Rogers, a large collection of material illustrating the work of the allied armies and also of those of the enemy countries. This collection includes uniforms and personal equipment of the officers and enlisted men, chemical warfare material, ordnance material, aviation material, Signal Corps material, engineer material, medical material, and various other paraphernalia used by the Belgian, British, French, Italian, and also the German, Austrian, and Turkish armies.

The artistic and sentimental side of the great conflict which the war collection illustrates will also be well represented in this collection. In this connection the Museum has received, through the

courtesy of the General Staff of the United States Army, all of the paintings and drawings made by the official artists of the American Expeditionary Forces in France, and showing in a graphic and striking manner the activities of the United States Army from the entrance of America into the war until the signing of the armistice, November 11, 1918. Besides these pictures, a large and most important collection of paintings executed by various artists on behalf of Liberty loan work and formerly exhibited in New York City, has been added to the collection.

The Museum has already received as complete a collection of Liberty loan posters as it is possible to make at this time.

The numismatic features of the collection have also received many interesting additions, including about 200 medals, issued in the allied and neutral countries during the progress of the war to commemorate notable events, and especially to perpetuate allegorical designs in connection with the various stages of the conflict.

The war collection as a whole has grown so rapidly and has attracted so much material of historical and intrinsic value to the Museum that its continued development is assured.

The great problem remaining is to supply adequate facilities for the installation of this priceless aggregation of material, which should be installed as a unit in suitable cases amid appropriate surroundings in a new building erected exclusively for the purpose.

RESEARCH WORK OF THE ASTROPHYSICAL OBSERVATORY.

Astrophysical Observatory.—The work of the Astrophysical Observatory is closely related to meteorology. The researches carried on there relate to the quantity of heat received by the earth from the sun, the effect of the atmosphere to diminish and alter the quality of the solar radiation, and, on the other hand, the determination of the outgoing radiation of the earth and the effect of the atmosphere to hinder it and to alter its composition.

The work of the observatory from 1905 to 1912 established the standard scale of solar radiation measurements, determined the intensity of the sun's radiation as it is outside the atmosphere, and measured the transparency of the atmosphere for solar rays under a great variety of circumstances—at sea level and at various altitudes up to that of Mount Whitney, the highest mountain in the United States. These researches also showed that the sun is probably a variable star, having a variation both of long period associated with the variation of other solar phenomena like sun spots and also a variation in short periods of a few days or weeks. The magnitude of these fluctuations in the solar heat appeared to amount to several per cent and could reasonably be expected to affect the temperature and rainfall of the earth.

Since 1912 the Astrophysical Observatory has confirmed the variability of the sun by several independent methods and has perfected and improved the means of determining it in several ways. A notable improvement was made this year at the time when Dr. Charles G. Abbot, the director, was visiting the Smithsonian Observatory at Calama, Chile, which is maintained under the Hodgkins fund. He found that by taking into account the brightness of the sky around the sun the transparency of the atmosphere for solar rays could be inferred so accurately by means of measurements extending over about only 10 minutes that the determination of the solar heat could be made as accurately as by the older fundamental process of Langley, which requires several hours of observing. The computations by the new method are also much abbreviated, so that now it is possible to determine the intensity of the solar radiation for the given day within 2 or 3 hours instead of by methods which, as heretofore, required the equivalent of 15 hours of work for one observer. The new method of observing is being steadily applied at the Smithsonian Observatory at Calama, Chile, and the foundation for its application at Mount Wilson, in California, has been laid.

Studies are being made by officials of Argentina and Brazil on the dependence of the temperature and rainfall of those countries on the variations of the sun as reported to them by the observing station at Calama. The Smithsonian Institution has now in press a report by Mr. H. H. Clayton, principal forecaster of the meteorological service of Argentina, in which he gives investigations tending to show that all the outstanding departures from normal which constitute the weather as contrasted with the climate of a place depend on variations of the sun. Without as yet fully accepting this startling conclusion at least the importance of the observations of the solar variability are greatly enhanced by these studies of Mr. Clayton. Accordingly investigations are being made to determine the best site for a proposed observatory for measuring solar variation in the most cloudless region of the United States. This appears to be a little north of Yuma, Calif. Plans are also being considered for establishing such an observatory in Egypt, which is the most cloudless region of the world. As in every research, the drawback is the lack of funds. It is greatly to be hoped that in some way means may be found for establishing two or three of the special observatories required for measuring the variation of the sun in the most cloudless region of the earth. It is only in this way that a satisfactory basis can be laid for further progress in world-wide weather forecasting depending upon these measurements.

In regard to the dependence of the weather on the terrestrial radiation outward to space and the effect of the atmosphere upon that, re-

searches are also in progress at the observatory. Although this field is more difficult even than that of the dependence of the earth's temperature on the incoming solar radiation, yet good hope of progress is entertained.

The director is largely occupied with the preparation of Volume IV of the Annals of the Observatory, which will include the results obtained from 1912 to 1919 in the studies of solar and terrestrial radiation.

EXPEDITIONS.

The Collins-Garner Congo expedition returned to this country in May, after having spent more than two years in the collecting of natural-history material in French Congo. Mr. C. R. W. Aschmeier, who represented the Smithsonian Institution, brought back with him a valuable addition to the museum collections, consisting of about 2,500 birds and mammals.

Borneo-Celebes-Australian expeditions.—The collection of natural history and archeological specimens in Borneo and Celebes was commenced under the direction of Mr. Harry C. Raven in 1912 and was concluded in 1918, resulting in the addition of many thousands of specimens to the museum collections. The expedition was financed by Dr. W. L. Abbott, of Philadelphia, who contributed a total of \$21,000 for this purpose. He has quite recently made an additional contribution of \$4,000 for the purpose of outfitting and maintaining an expedition to Australia under the direction of Mr. Charles M. Hoy, who is already in the field, and who reports excellent progress in the collection of the fast-disappearing Australian mammals and birds.

African expedition.—During the early summer an expedition to Africa was arranged by the Smithsonian Institution and the directors of the Universal Film Manufacturing Co. to make general explorations and collections of natural-history material and to take motion pictures. The expedition was to start from South Africa and work northward through the entire length of the Continent. The Institution had not the means to pay the expenses of its representatives, but a few friends of the Institution raised the necessary funds. Mr. Edmund Heller, who accompanied Col. Roosevelt to Africa, and Mr. H. C. Raven, who spent six years in Borneo and Celebes collecting for the Smithsonian, were selected as the Institution's representatives.

Word was recently received of a railroad accident in which two members of the expedition lost their lives; but fortunately neither Mr. Heller nor Mr. Raven was in the accident.

Saskatchewan expedition.—The secretary gave a brief description of his work in the Saskatchewan region of the Canadian Rocky

Mountains during the past summer, where he discovered a section 6,700 feet in thickness of rocks that had never been studied. Much new material was secured for the collections.

BUREAU OF AMERICAN ETHNOLOGY.

The researches of the Bureau of American Ethnology during the past year have been directed to a study of the Indian languages, especially of those that are rapidly becoming extinct; and a determination of native American food resources, textiles, and other materials which were used by the Indians, some of which, like the potato and Indian corn, were long ago adopted by the white man. The bureau also studied the prehistoric records of the Indians, and a concrete example is illustrated by results of archeological investigations pursued at the Mesa Verde National Park in conjunction with the Department of the Interior, where in continuation of the work of previous years, there has been excavated and repaired a large ruin known as Square Tower House. The age of this ruin can not be determined, but it was deserted before the beginning of the fifteenth century A. D.

NATIONAL ZOOLOGICAL PARK.

Attendance.—Although the attendance for the last fiscal year reached nearly 2,000,000, there is every indication that this year's record will exceed all previous years, as over 900,000 persons have visited the park since July 1.

Recent accessions.—Among the most important accessions recently received may be mentioned a Brazilian brocket, one of the smallest of South American deer, presented by Mrs. Lindon W. Bates; a white-backed trumpeter, the first of its kind to be exhibited at the park, brought by the American consular agent at Manaus, Brazil, Mr. Edward B. Kirk; a number of new varieties of ducks, and a very rare species of cassowary. Many European birds have also been received. Births since July 1 include a llama, tahr, elk, yak, Indian antelope, and two great red kangaroos.

Baby elephants.—During the year an opportunity presented itself to secure two young Sumatran elephants, which were in quarantine in New York. They were held at \$2,500 each, and, as no Government funds were available, Mrs. Charles D. Walcott undertook to secure \$5,000 by private gifts. Sixty-nine subscriptions, amounting to \$5,025 were obtained, and the elephants are now on exhibition at the park.

NEW BUSINESS.

Charles Lang Freer.—The secretary announced the death, in New York City on September 25, 1919, of Charles Lang Freer, aged 63

years, and said that the history of Mr. Freer's great gift of art objects to the Smithsonian Institution was so well known that he would give here only a brief outline of it.

The Freer collections.—Mr. Freer assembled his collections with a definite purpose, and he has made the American people the possessors of a unique series of the finest existing examples of oriental art. The collections comprise superb specimens of Egyptian, Mesopotamian, Persian, and far-eastern pottery, ancient Egyptian colored glass, Persian and Hindu miniature painting, and the paintings, bronzes, and sculpture of China and Japan.

Mr. Freer felt that American artists had interpreted the spirit of oriental art, which led him to add some masterpieces of T. W. Dewing (26 oils; 11 pastels; 3 silver points); Abbott H. Thayer (12 oils; 1 water color); Dwight W. Tryon (34 oils; 36 pastels; 2 water colors); and last and most important, a great collection of etchings, sketches, paintings, etc., by Whistler. The number of these is as follows: 63 oil paintings; 44 water colors; 37 pastels; 113 drawings and sketches; 3 wood engravings after designs by Whistler; 396 etchings and dry points, of many of which there are from two to five impressions, making a total number of pieces 625; 166 lithographs (194 impressions); 38 original copper plates. Also, the complete wood work, including all the decorations, of the Peacock Room, the famous creation of Whistler.

The Peacock Room has recently been brought from Detroit and is now ready for installation in the Freer Gallery of Art.

The collections also include paintings by the American artists, Winslow Homer, Childe Hassam, J. Gari Melchers, John S. Sargent, Joseph L. Smith, J. H. Twachtman, Willard L. Metcalf, George de Forest Brush, and J. Francis Murphy; and bronze sculptures by Augustus Saint-Gaudens.

At the time of the making of the offer by Mr. Freer to present his collection to the Smithsonian Institution in 1904, it consisted of over 2,250 objects. In succeeding years this number has been more than doubled by additions of objects from both the Orient and the Occident, the total number of objects in 1918 being 6,274. By reason of later unrecorded additions the present total will not be known until the collections are brought on from Detroit and installed in the gallery, which will be ready to receive them in the spring of 1920.

Mr. Freer was not a mere collector, as his methods were selective after full study rather than accumulative. He visited the East many times, and being in full sympathy with oriental peoples he imbibed a profound understanding of their artistic sentiments and aspirations. He was the only great collector in our country who sought and seized opportunities in China, and his collection will give

students an opportunity to study the choicest specimens of ancient Chinese and Japanese painting for the first time in this country. The collection takes the lead in Chinese art in America and will form the basis for important research work. The late Prof. Fenollosa, in an article on the Freer collection, published in 1907, said that Mr. Freer was then probably the greatest living expert in artistic pottery, and that in Chinese and Japanese painting he was probably the most inwardly appreciative of their artistic and educational value.

Freer Building.—Steady progress has been made on the building, and it is hoped that the gallery will be ready for the collections in March, 1920. The secretary added that the formal opening was expected to take place by the date of the next annual meeting of the board, in December, 1920.

A statement of the condition of the fund provided by Mr. Freer for the erection of the building to house his collections had been given in the report of the permanent committee.

The Freer will.—Briefly, the Freer will provides as follows:

The executors are to provide and pay for casing, packing, and transportation to Washington of all collections, cases, racks, and furniture; also for taking down the woodwork and decorations of the Peacock Room, and for casing, transporting, and reerecting them in the Freer Building in Washington.

The executors are to continue to employ Katherine N. Rhoades in an advisory position until the collections have been deposited in the Freer Building in Washington.

The income of \$200,000 is to be used solely by the Regents for the pay of a curator.

The income of \$200,000 is to be used by the Regents for the creation of ornamental gardens in and about the Freer Building, and for the purchase of American statuary for the building; concerning this, Mr. Charles A. Platt is to be consulted.

The income of \$50,000 is to be used solely for the care and maintenance of gardens and statuary of the building and grounds.

The income of \$50,000 is to be used in perpetuity for adding to the knowledge and appreciation of oriental art, primarily by research and publication.

The codicil to the will states, after providing for meeting certain exigencies, should they arise, that such income from the residual estate as the Regents may determine is to be used for the study of the civilization of the Far East, the remainder of the income to be used for the purchase of examples of oriental, Egyptian, and near eastern fine arts, and the purchase of works of painting, sculpture, and pottery of American origin, the same to be deposited in the United States National Gallery of Art.

Senator Lodge then offered the following resolutions, which were adopted:

Whereas the Board of Regents of the Smithsonian Institution has learned of the death, on September 25, 1919, of Charles Lang Freer, of Detroit, Mich.:

Resolved, That the board desires to place upon record an expression of its sorrow at the passing away of this distinguished patron of the arts, whose generous gifts of paintings, sculptures, and bronzes to this institution for the benefit of the Nation, and of funds for the erection of a suitable building for their study and exhibition have earned the gratitude of the world and a conspicuous position in the history of the country's great benefactors.

Resolved, That a copy of this resolution be transmitted by the secretary to the family of Mr. Freer.

The secretary went on to say that very naturally many matters of importance would be coming up in connection with the Freer Gallery and the collections which it would be impossible for the board to consider as a body, and he desired to suggest that authority to act for the board be delegated either to the permanent committee or to a committee to be appointed by the board.

On motion, the following resolution was adopted:

Resolved, That the Board of Regents of the Smithsonian Institution hereby authorizes and directs its permanent committee to represent the board in all matters pertaining to the receipt and installation of all gifts from the late Charles Lang Freer and in carrying out the provisions of his will, dated May 13, 1918, and of the codicil thereto, dated May 4, 1919, so far as they relate to the Smithsonian Institution.

THE NATIONAL ART COMMITTEE.

The National Art Committee was formed about a year ago, of which Mr. Henry White, of this Board of Regents, is honorary chairman, and Mr. Herbert Pratt, of New York, secretary and treasurer.

The purpose of the committee is to secure portraits of the military, civil, and religious leaders in the Great War, which are to be exhibited in various cities of the United States, and later placed in the care of the Smithsonian Institution at Washington.

The committee took up its work vigorously, sending several of the foremost American artists abroad to execute the various commissions allotted to each, and a recent report received at the institution indicates that the following portraits have been completed:

Miss Cecelia Beaux: Cardinal Mercier, Admiral Beatty, and Premier Clemenceau.

Douglas Volk: Lloyd George and the King of the Belgians.

Edmund C. Tarbell: Gen. Le Man and Marshal Foch.

Charles Hopkinson: Premier Bratiano, Premier Pachitch, and Saionji.

John C. Johansen: Field Marshal Haig, Marshal Joffre, Gen. Diaz, and Premier Orlando.

Irving Wiles: Admiral Sims.

FINANCIAL STATUS OF THE INSTITUTION.

The secretary gave a statement of the extent of the Smithsonian fund, showing that it was far too small for present needs. He suggested that the Regents bear this in mind, and if opportunity offered while in conversation or correspondence with persons desirous of making some disposition of their fortunes for the betterment of mankind to speak of the institution and its work, in the hope of inducing such persons to make the institution their beneficiary.

NATIONAL ACADEMY BUILDING.

The secretary spoke of the proposed new building for the National Academy of Sciences, the funds for which had been provided by the Carnegie Foundation on condition that the academy acquire a lot upon which to erect the building, which has been done.

It was suggested that probably the Carnegie Foundation might be of aid in carrying out some of the projects of the institution, now held in abeyance owing to lack of means.

Dr. Bell asked the opportunity to express his high appreciation of the importance of the work of Dr. Charles G. Abbot, assistant secretary of the institution and director of the Astrophysical Observatory, whose researches in solar radiation were of great value.

ADJOURNMENT.

There being no further business to come before the board, on motion the meeting adjourned. The Regents then viewed a number of exhibits illustrating certain phases of the institution's work.



GENERAL APPENDIX
TO THE
SMITHSONIAN REPORT FOR 1920

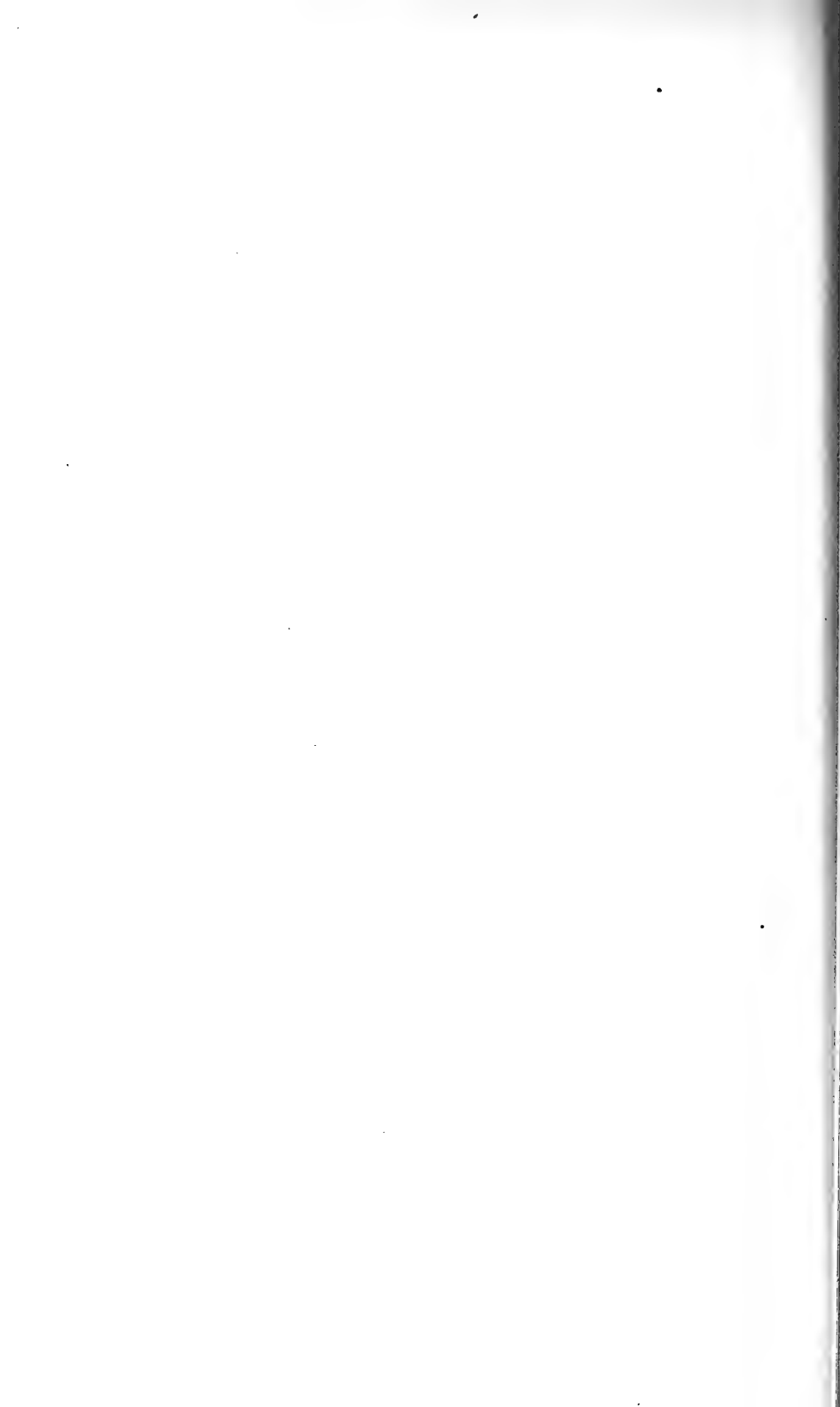

ADVERTISEMENT.

The object of the GENERAL APPENDIX to the Annual Report of the Smithsonian Institution is to furnish brief accounts of scientific discovery in particular directions; reports of investigations made by collaborators of the Institution; and memoirs of a general character or on special topics that are of interest or value to the numerous correspondents of the Institution.

It has been a prominent object of the Board of Regents of the Smithsonian Institution, from a very early date, to enrich the annual report required of them by law with memoirs illustrating the more remarkable and important developments in physical and biological discovery, as well as showing the general character of the operations of the Institution; and this purpose has, during the greater part of its history, been carried out largely by the publication of such papers as would possess an interest to all attracted by scientific progress.

In 1880 the Secretary, induced in part by the discontinuance of an annual summary of progress which for 30 years previous had been issued by well-known private publishing firms, had prepared by competent collaborators a series of abstracts, showing concisely the prominent features of recent scientific progress in astronomy, geology, meteorology, physics, chemistry, mineralogy, botany, zoology, and anthropology. This latter plan was continued, though not altogether satisfactorily, down to and including the year 1888.

In the report for 1889 a return was made to the earlier method of presenting a miscellaneous selection of papers (some of them original) embracing a considerable range of scientific investigation and discussion. This method has been continued in the present report for 1920.

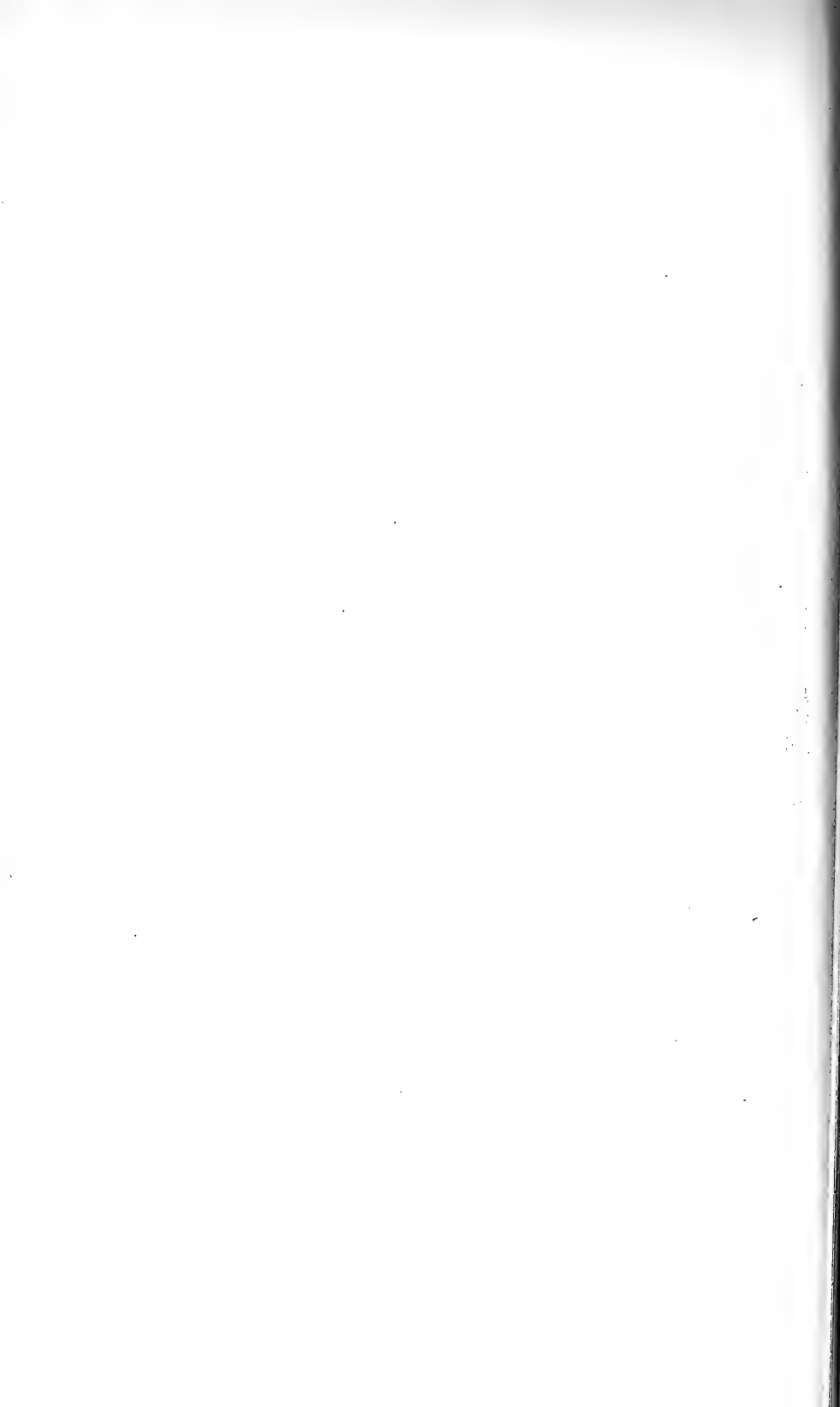

STUDYING THE SUN'S HEAT ON MOUNTAIN PEAKS IN DESERT LANDS.

By C. G. ABBOT.

[With 7 plates.]

As a little boy it used to please me greatly to see the potatoes in the cellar toward spring begin to stretch out long sprouts which had to be rubbed off from time to time. Sometimes one of the potatoes would fall through some crack where it became inaccessible, and its sprouts would grow and grow, sometimes a yard or more, till they came to a little streak of light, always white until the light was reached, but then tending toward green. Again it was a pleasure at the time, and is now a greater pleasure, to look back upon the march of the seasons with the northward and southward excursions of the sun, which changed the New England landscape by a gradual progress from the glories of winter to the beauties and fruitfulness of spring and autumn.

In a world where the very life of all the plant kingdom depends upon sunlight, and where the existence of the temperature fit for all life of the animal kingdom depends upon the sun's rays, it may seem an extraordinary statement that until the beginning of the twentieth century no exact measurements of the intensity of the solar radiation on which all things depend had ever been obtained. Sometimes one hears the inquiry as to whether the sun's beams are gradually losing their strength and the sun declining toward the condition of a cold body devoid of life-giving energy. It is impossible to answer this question other than to refer to the fact that the crops which were raised in Egypt and Syria in the most ancient recorded times were substantially identical with those that are raised there now, so at least the decline of the sun's radiation has been very little in the last 6,000 years. The ancients, although having much astronomical knowledge, never measured, so far as we know, the intensity of the sun's radiation, so that there are no accurate measurements to fall back upon in order to answer this question.

It was not until the time of Sir John Herschel and Pouillet, in the decade 1830-1840, that attempts were made to get accurate measurements of the heat of the sun. And it was not until the decade 1900-1910 that the methods and apparatus for this purpose attained such perfection that results accurate to the order of 1 per cent were obtained. Inquirers who may live 1,000 years hence can, we hope, refer to the measurements of the Smithsonian Institution begun in 1902 in order to settle the question whether the sun's heat has gradually declined in the millennium intervening.

If we could set up a tube reaching to the outer limit of the atmosphere and large enough to see through it the whole of the disk of the sun, and exhaust the air from it entirely, then the measurements of the sun's intensity of radiation would be very simple. But situated as we are underneath an ocean of air charged with dust, clouds, water vapor, carbon dioxide, and even, we may say, of the molecules themselves, such solar researches are very difficult. In order to minimize these difficulties as far as possible, such studies are best conducted in the most dry and cloudless regions at high-altitude stations.

In the course of the work carried on by the Smithsonian Institution measurements have been made at Washington, sea level; Bassour, Algeria, 3,600 feet; Hump Mountain, North Carolina, 4,800 feet; Mount Harqua Hala, Arizona, 5,600 feet; Mount Wilson, California, 5,800 feet; Calama, Chile, 7,500 feet; Montezuma, Chile, 9,500 feet; Mount Whitney, California, 14,500 feet; and finally from a free balloon which was sent up from Omaha, Nebraska, carrying automatic recording instruments, to an altitude of about 15 miles. The accuracy of these measurements has depended on the able cooperation of my colleagues, Messrs. F. E. Fowle, L. B. Aldrich, A. F. Moore, L. H. Abbot, and others, observers; Mr. A. Kramer instrument maker; and Miss F. A. Graves and others, computers. They have been made, some in summer, some in winter, some in clear skies, and others in skies made hazy by the dust from the gigantic eruption of Mount Katmai, Alaska, in 1912, but their results are in substantial agreement and give the mean value of the intensity of solar radiation to a probable accuracy of 1 per cent. I say the mean value because the investigations have shown that the sun's output of radiation is not constant, but varies from year to year and even from day to day within the year.

The solar variations of long interval seem to be associated with the general activity of the sun, so that higher values of the sun's emission are found when sun spots, prominences, faculae, and other solar phenomena are more than usually marked. At such times, strangely enough, the temperature at most weather stations on the earth averages below the normal. This paradox of increased solar heat and decreased terrestrial temperature may perhaps be explainable on the basis that increased cloudiness occurs at times of sun-spot activity.

It has long been known that the aurora borealis, or northern lights, have been particularly active at times of sun-spot maximum, and as these lights are electrical disturbances in our atmosphere, it has come to be believed that the sun furnishes not only light rays but also bombards us with electric ions. Electric ions are known from laboratory experiments to promote the formation of clouds. Hence, it is quite possible that the electric bombardment of the earth by the sun, being more vigorous at times of sun-spot maximum, tends to promote cloudiness; which in turn indirectly, by reflecting away solar radiation, actually diminishes the amount available to warm the earth, although the direct tendency of increased solar activity is to increase the earth's supply of radiation.

The short irregular fluctuations in the sun's radiation amount sometimes to 3 or even 5 or 7 per cent within a few days. Although they seem to be slightly associated with the rotation period of the sun, as if rays at different strength were sent out by the sun in different directions which, after a full rotation of the sun accomplished in 26 or 27 days, come round again in the direction of the earth, yet in general these fluctuations are nonperiodic and accordingly not predictable. Lately their cause has received a very unlooked-for but probable explanation by comparison of the solar observations of the Smithsonian Institution at Calama, Chile, with photometric observations of Doctor Guthnick of the Observatory of Berlin, Germany. Employing a photo-electric cell, Doctor Guthnick compared the brightness of the planet Saturn with the star Regulus during January, February, March, April, and May, 1920. Shining by reflected sunlight, Saturn must vary if the sun varies. Doctor Guthnick, however, on comparing his results with those reported from the Smithsonian Institution on the brightness of the sun, could see no correspondence between the small solar and planetary fluctuations which occurred. In his comparison, however, he assumed that whatever changes might occur in the sun would make themselves felt in all directions simultaneously. This is not necessarily so, for if the sun should be surrounded by an obscuring atmosphere thicker in some directions than others, rays of different intensity would go out to different quarters; so that the earth, being in a certain direction from the sun, might receive rays of a different strength from those which were emitted in the direction of the planet Saturn. As the sun rotates upon its axis once in about 27 days (the actual time differs for different parts of the sun), the ray which reached the earth would sweep around perhaps in one, two, or three days to or from the position of Saturn at the time of Guthnick's measurements, so that one would expect Saturn's reponse to the change noted in the solar radiation perhaps two or three days later, or two or three days earlier, exactly according to the relative positions of the two planets.

Starting from this hypothesis, the two kinds of observations were found to have come into complete accord, so that 1 per cent change in the sun corresponded with 1 per cent change in the brightness of Saturn, just as it ought to do. We may then look upon the sun's variation as of twofold origin. First, the long-period changes, associated with sun-spot activity, depend upon increased general temperature of the sun's surface, due to the increased circulation of the hot, dense gases of which the sun is composed. On the other hand, the short-period, irregular fluctuations are to be regarded as due to the inequality of the sun's radiation in different directions, perhaps caused by the presence of an obscuring atmosphere of different thicknesses from place to place.

MOUNT WHITNEY.

It is now almost 40 years since the late Doctor S. P. Langley, third Secretary of the Smithsonian Institution, made his picturesque and famous expedition to Mount Whitney, California, to observe the radiation of the sun. The expedition was made possible by the generous aid of the late William Thaw, of Pittsburgh. It went forward in a special car, carrying the observers and the whole equipment. Mount Whitney, 14,500 feet elevation, is by a few feet the highest mountain in the United States, exclusive of Alaska. In 1881 the region about it was but little settled and Indians were frequently met with. Accordingly, a detail of soldiers accompanied the expedition through the desert from the stopping place of the car to the little town of Lone Pine, where the experiments were begun.

Doctor Langley has often told me of the tremendous heat encountered in the small tent where the spectrobolometer was set up at Lone Pine. The indications of the bolometer, that electrical thermometer capable of detecting temperature changes of the millionth of a degree, are recorded by a sensitive galvanometer. In the very unfavorable conditions of the little tent Doctor Langley told me that the spot of light from the galvanometer mirror used to rush off the scale a meter long in a single minute of time, so that the observer there read and called out the position of the spot on the scale as fast as he could do so without knowing what sun rays, or if any, were being observed by the bolometer. All of these thousands of readings were graphically plotted and reduced with almost infinite labor to obtain the results of the solar observations.

A little later the whole apparatus was moved nearly up to the top of Mount Whitney, where, on the shore of a beautiful mountain lake, at more than 12,000 feet elevation, the work was repeated. A few partial observations were made by the expedition on the very summit of Mount Whitney, but conditions there were found to be



SHELTER FOR OBSERVERS ON MOUNT WHITNEY.



too trying to warrant the labor of carrying the heavy apparatus up the last 2,000 feet over rugged rocks and precipices.

In these experiments a new region of the spectrum was found lying beyond that which was previously recognized by Doctor Langley in his work at Allegheny, and I have heard him describe the thrill of discovery as he roughly mapped out this new region lying far down beyond the visible end of the red.

Almost 30 years later, at the recommendation of Director Campbell, of Lick Observatory, and the writer, the Smithsonian Institution erected on the summit of Mount Whitney a stone and steel building of three rooms, so as to enable observers who, for any reason, require the high altitude for their work to carry it on under conditions of comparative comfort.

The first to occupy the new observing station was Director Campbell's expedition of 1909¹ to determine the quantity of water existing in the atmosphere of the planet Mars. At the same time the writer observed there, with special spectrobolometric apparatus, to determine whether measurements of the sun's heat outside the atmosphere, which had been carried on at Washington and Mount Wilson, would have yielded different results had they been made at a station very much higher in altitude.

The following selection from a letter of the writer shows how little the second "solar constant" expedition to Mount Whitney was able to compete in impressiveness with the famous one of Doctor Langley:

MOUNT WILSON, CALIF., *September 14, 1909.*

DEAR SIR: I left Pasadena about 9.30 p. m. August 19, and took the 11.30 p. m. train at Los Angeles for Mojave. I slept occasionally but with great fear lest I should be carried by Mojave, and at length reached there a little late, at 4.30 a. m. The train for Little Lake, mostly a freight train, left at 7 a. m., and, after stopping all along the way to shift and unload freight cars, reached Little Lake, 3½ hours late, at 6 p. m. I got supper there and started by auto stage at 6.15 p. m. Having three boxes of delicate apparatus, one of which I felt it necessary to carry in my arms, the ride of 50 miles from Little Lake to Lone Pine was not altogether pleasant. Two automobiles started together, but the one I was in stopped near Olancho, and nearly two hours of work failed to start it, so that all the passengers crowded into the other. We reached Lone Pine at 11.30 p. m. At 8.30 a. m. August 21, with Mr. William Skinner, of Lone Pine, as guide, and with a driver and animals to carry my baggage, I started for Mount Whitney. We camped at about 4 p. m. with Mr. Robinson and his packers at Big Meadow; elevation about 10,500 feet. I found that nearly all the material for the house had gone up to the top, and my boxes were at Robinson's camp. Mr. Skinner and I left camp at 6 a. m. and arrived on the summit of Mount Whitney about 11 a. m. August 22. We found Mr. Marsh with four workmen. The walls of the building were done except gables and partitions, and the frame of the roof was up. The masons were laying the

¹A Shelter for Observers on Mount Whitney, by C. G. Abbot, *Smithsonian Misc. Coll.* (Quarterly Issue), vol. 52, pt. 4, pp. 499-506. 1910.

walls of the little stone hut for my work, and they finished it, including the roof, that day. Several 6 by 6 tents had been loaned by Professor Campbell, and in these we cooked, ate, and slept. Ham, bacon, Mulligan stew, and flap-jacks were the staple foods.

I had set up my apparatus mainly by Thursday night, August 26. Friday it snowed a little, but the house was finished Friday afternoon, August 27.

Mr. Campbell, with Messrs. Albrecht, McAdie, Doctor Miller, Hoover, and Skinner, came about noon on Saturday, August 28. They arrived in a thunder-storm of sleet. Lightning struck near by just as they reached the door. It became partially clear on the following Wednesday, and Campbell secured good observations on Wednesday and Thursday nights. My own preparations were set back by the storm, so that I only got ready Thursday afternoon, September 2. Friday morning was beautiful, and I think my observations of that forenoon were satisfactory. I took two bolographs also about 2 and 5 p. m. of Friday afternoon between clouds. On Saturday it snowed 4 inches. Mr. Campbell and party went down. They almost lost one mule among the rocks (had to leave the mule behind after two hours' work, but it went down the trail the following Wednesday), and three others slid off of the ice on the east side of the range and rolled a hundred feet or so. The Smithsonian has been so fortunate as not to have had any of the animals in its employ injured during the whole operations. After waiting several days without much improvement in the weather Mr. Marsh and I left on Wednesday, September 8. I hope it will be possible for me to complete my work up there next July or early August, when the weather will probably be better.

In August, 1910, the writer again ascended Mount Whitney with Mr. Marsh, and in the course of 10 beautiful days there again set up the spectrobolometer and obtained excellent "solar constant" observations.

Simultaneous measurements made in 1909 and 1910 at Mount Wilson and Mount Whitney agreed within about 1 per cent and within the error of the determinations. Similar agreement had been obtained before that between simultaneous measurements at Washington and Mount Wilson, so that there appears to be no effect on the "solar constant" results depending upon differences of altitude, at any rate up to 14,500 feet.

MOUNT WILSON.

With the establishment of the Carnegie Institution in 1902, many plans for work in all branches of science were submitted, among them one by Doctor Langley, then Secretary of the Smithsonian Institution, on the measurement of solar radiation. He entertained the hope, which has since come very close to fruition, that a knowledge of the sun's radiation, the losses which it experiences in passing through our atmosphere, its possible variability from time to time, would be such a boon to meteorological science as to be a basis for forecasts of long range such as might even parallel those of Joseph, who forecast the seven lean years and the seven years of plenty.

The outcome of his recommendations did not lead to the establishment of this kind of work by the Carnegie Institution itself, but did lead to the most cordial cooperation on the part of their new Mount Wilson Solar Observatory through its director, Dr. George E. Hale, with Doctor Langley in the furtherance of his favorite investigation. On Doctor Hale's invitation, an expedition from the Smithsonian Institution was prepared and went forward in charge of the writer in 1905 to Mount Wilson, California, where temporary buildings were erected and occupied each year except 1907 from 1905 to 1910, when a more suitable observatory was constructed of cement blocks. In 1913 a tower telescope was added to the equipment of the Smithsonian observatory on Mount Wilson, so that the whole now appears as in the illustration, plate 4. Just above the observing station is a cottage occupied as quarters for the observers. The situation is remarkable for its boldness, standing on the edge of an almost precipitous ravine which falls away almost immediately nearly a thousand feet. It overlooks the valley cities of Pasadena and Los Angeles and the ocean on the one side, while to the east lie the Sierra Madre Ranges with the 10,000-foot mountains San Antonio, San Bernardino, San Gorgonio, and San Jacinto plainly visible on clear days.

A little nearer the summit of the mountain lies the wonderful Mount Wilson Solar Observatory of the Carnegie Institution where apparatus of the greatest ingenuity, power, and extreme size has been accumulated year by year, culminating in 1919 in the completion of the 100-inch reflector with its dome 100 feet in diameter. As one contemplates this collection of splendid astronomical instruments and compares them with the little telescope with which Argelander made his famous "Durchmusterung" of the northern heavens, it seems as if some of the dinosaurs had come to life and were disporting among the little lizards which snap up the flies in the sun on Mount Wilson.

From 1905 until 1920, with the single exception of the year 1907, measurements of the solar radiation were made on Mount Wilson during the summer and autumn months by the Smithsonian observers. This body of observations, published in the *Annals of the Smithsonian Astrophysical Observatory*, Volumes II, III, and forthcoming Volume IV, is the basis of our knowledge of the radiation of the sun, its variability and its relation to our atmosphere and to terrestrial temperatures.

A hint of the existence of variations in the sun's radiation had been obtained in 1903 at Washington. Errors associated with the work in such a cloudy and smoky atmosphere as that of this eastern city are so large that the result could not be at all certain. Beginning with the observations on Mount Wilson in 1905, every year has added something to the certainty of the variation of the sun as well as to the accuracy of the methods of observation and the number of special

pieces of apparatus developed for use in the investigation. Early in the work it was recognized that a standard instrument for precision measurements of the sun's heat was required. By 1910 there was developed the standard water-flow pyrhelimeter. This instrument is a hollow chamber of a test-tube like form having hollow walls in which circulates in a spiral channel a current of water. The sun's rays enter this chamber through a vestibule of constant temperature. Just before reaching the chamber they pass through a circular aperture of known area and shine upon the blackened wall at the chamber's extreme rear. Any remnant not fully absorbed by the blackened wall is reflected to and thrown upon other parts of the chamber wall until fully absorbed. In the flowing water current, just at the mouth of the chamber, are found the arms of a platinum electrical thermometer, by means of which the rise of temperature of the water due to the heat absorbed from the sun-rays within the chamber is measured. The water which has flowed through the apparatus is collected and weighed from time to time so as to determine the rate of flow. Thus the intensity of the sun's heat is measured in terms of the rise of temperature of a known weight of water caused by the absorption of solar rays over a known area in a given time. In order to get a check upon the accuracy of the measurement, known quantities of electricity are caused to flow over coils within the chamber and the heat thus developed is measured, as if it were solar heat, by the flowing water.

Comparisons of this instrument with other special devices for measuring solar heat have been made from time to time for the past 10 years. No change in the scale of measurement has been detected within this interval. Thus we may regard the whole body of Mount Wilson data as an homogeneous system of measurements of that fundamental quantity, the intensity of the solar radiation available to warm the earth.

Over 30 copies of the secondary so-called "silver-disk pyrhelimeter," figure 1, also devised for the investigation, have been prepared and standardized at the Smithsonian Institution and supplied at cost to observers over all the earth. Thus the Smithsonian standard scale of radiation measurements has become widely diffused.

RESULTS ACCOMPLISHED UP TO 1910.

The chief results accomplished in the research up to 1910 had been as follows:

1. The processes for determining the intensity of the sun's radiation outside the earth's atmosphere had been perfected and the whole investigation reduced to a well-organized routine.

2. A standard scale of radiation measurements had been established by the invention and construction of the standard water-flow pyrhelimeter. The silver-disk secondary pyrhelimeter had been perfected and had proved fully satisfactory for the daily observations.

3. Several simultaneous determinations of the solar constant of radiation had been made at Washington, Mount Wilson, and Mount Whitney. No difference in the result, depending upon the elevation of the station, had been revealed, and the mean value for the solar

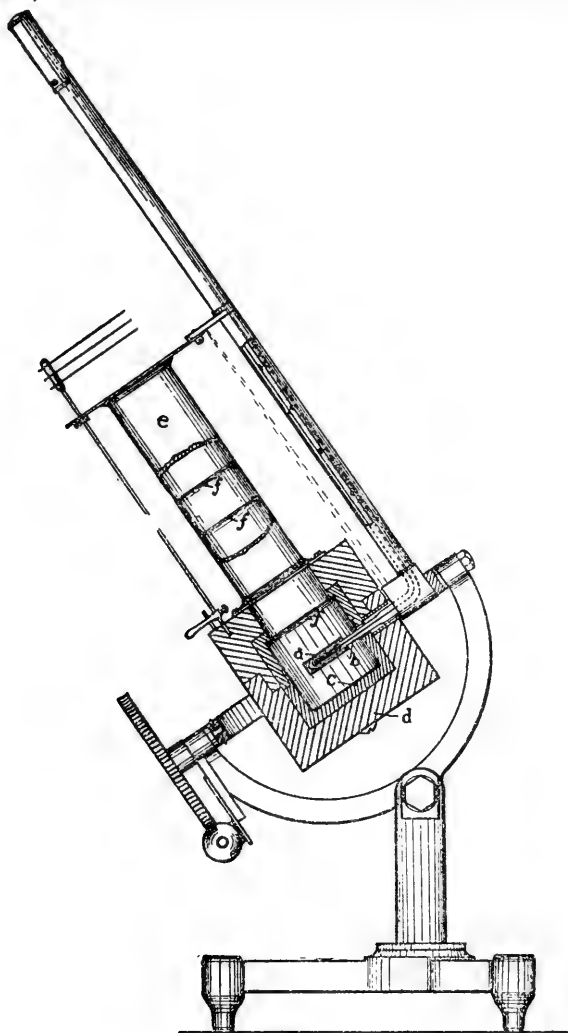

FIG. 1.—Abbot silver disk pyrheliometer.

constant of radiation of about 1.95 calories per square centimeter per minute had been obtained. This in itself was a great step forward, for now a reference point had been established which in future times would be available to determine the question of possible secular variation in the radiant energy of the sun.

4. The results had strongly indicated the short period variability of the solar radiation. This discovery, if confirmed, bade fair to have important consequences for meteorology.

5. The distribution of energy in the solar spectrum had been closely determined, and thereby our knowledge of the sun's temperature and nature had been materially increased.

6. Various by-products of the investigation, such as relating to the transparency of the atmosphere under different circumstances of humidity and haziness and for different altitudes from sea level up to the level of Mount Whitney, the study of the dependence of the temperature of the earth on radiation, the temperature of sun spots as compared with other parts of the sun's disk, and many other matters, had been investigated.

BASSOUR, ALGERIA.

By far the most interesting of these results of the investigation was the supposed short-period variability of the sun. Although the values of the "solar constant" did not appear to depend upon the altitude of the observer above sea level, yet the apparent variations of the sun were so little greater than the probable errors of the observations that it seemed essential to strengthen the discovery of the solar variability by some other independent check. The most obvious procedure was to equip another observing station in a favorable region far removed from Mount Wilson, and to carry on for a considerable period of time duplicate measurements of the "solar constant" at the two stations.

Preparations were made to go to Mexico for this purpose, but the breaking out of revolution there made it undesirable to set up the station in Mexico. Accordingly, the expedition was diverted to Algeria, in North Africa, a country under the stable government of the French, where good conditions with regard to cloudlessness might be expected. The expedition went forward in 1911, employing the same apparatus that had been used on Mount Whitney, although with decided improvements in many respects. The expedition was in charge of the writer, who was accompanied by Mrs. Abbot and assisted by Professor Brackett, of Pomona College, California. After discussion with the United States vice consul at Algiers, the director of the observatory there, and others, a site was selected at a little hamlet called Bassour, about 50 miles south of Algiers.

With the exception of a few French neighbors, the people in the vicinity were all Arabs, and there was a great deal of interest in observing their customs and methods of working, which are nearly identical with those of the times of Abraham. The most important Arab in the neighborhood was a caid, who took a great interest in our work and assisted it by keeping his curious neighbors from interrupting it.

As a boy I had sometimes wondered at the story in the Book of Ruth, which says that Boaz slept upon his threshing floor. On our farm in New Hampshire we sometimes threshed small lots of grain

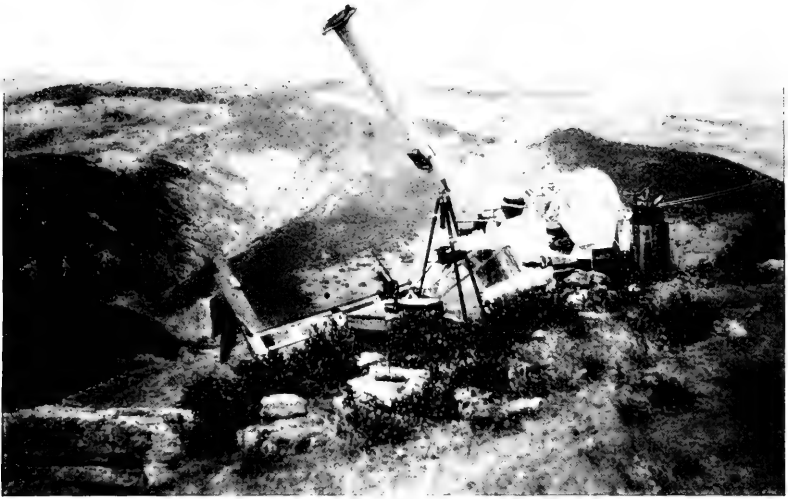

1. MR. ANGSTRÖM AND THE SOLAR-CONSTANT APPARATUS AT BASSOUR, ALGERIA.

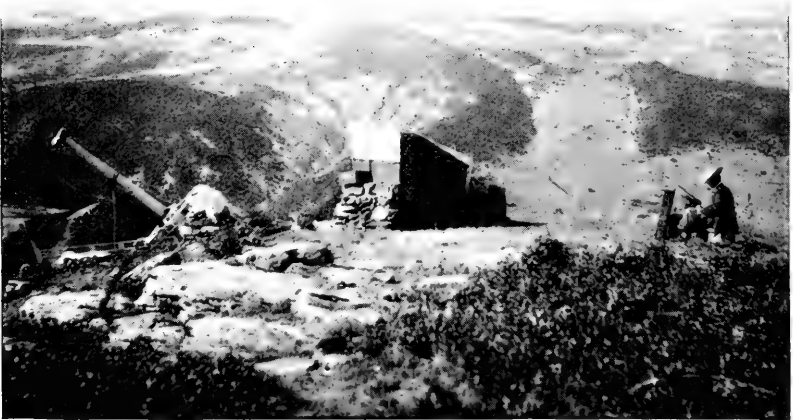

2. OBSERVING STATION AT BASSOUR, ALGERIA.



or beans upon the floor of the great barn, and I had imagined Boaz as going out to sleep upon his barn floor and wondered why he preferred doing so to sleeping in the house. Our experience in Algeria solved this mystery, for it appeared that the threshing floor was a hard level place upon the ground where Boaz slept under the light of the stars. The reason why he did so was doubtless the same that induced our French neighbor to take his double-barreled shotgun and his dog and go out and sleep on his grain pile, with the dog tied to his ankle—to prevent his neighbors from stealing the grain. Many other sights and customs reminded one continually of passages in the Bible, among them especially the driving of the oxen round and round upon the wheat to tread out the grain. As they took a mouthful now and then, one remembered that it says in the law: "Thou shalt not muzzle the ox when he treadeth out the corn."

Unfortunately the year 1911 proved to be a little unfavorable to the comparison of results between Algeria and California, owing to the unusual prevalence of cirrus clouds at both stations. Although the results appeared to support the view of the sun's variability, they

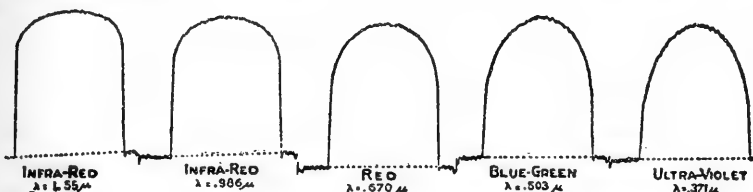

FIG. 2.—Brightness distribution along sun's diameter for different colors.

were not wholly conclusive and the expedition to Algeria was renewed in June, 1912.

We were still pursued by unfortunate circumstances as far as investigating the variability of the sun was concerned, for the great volcanic eruption of Mount Katmai, in Alaska, which took place about June 6, filled the atmosphere of the whole northern hemisphere with volcanic dust, which spread to Algeria and California within less than three weeks after the eruption, and, growing more and more abundant, so much obscured the sun's rays that a falling off of 20 per cent of their intensity at midday was found not unusually the case in July and August, 1912. Notwithstanding these untoward circumstances, the results of 1912 taken in combination with those of 1911, strongly confirmed the reality of the variation of the sun—so much so that thereafter we had no doubt of the reality of this discovery.

SOME DEVELOPMENTS OF THE RESEARCH IN THE INTERVAL BETWEEN THE ALGERIAN AND SOUTH AMERICAN EXPEDITIONS.

The matter received a further confirmation, however, in 1913, by the introduction on Mount Wilson of the tower telescope and the investigation of the distribution of radiation over the sun's disk.

As shown by the illustration, figure 2, the sun is not equally bright along its diameter, but falls off rapidly toward the edges of the disk. This contrast in brightness between the center and edge of the solar disk is much greater for violet and ultra-violet rays than it is for red and infra-red ones, but what is particularly interesting, the contrast of brightness which had been determined in Washington in 1907 was found to be less when it was redetermined at Mount Wilson in 1913. Not only was this result found, which confirmed the existence of the variability of the sun in the term of years, but the experiments at Mount Wilson show that the contrast of brightness varied from day to day in association with the variations of the "solar constant." This result, taken in connection with the experiments in California and Algeria in 1911 and 1912, fully confirmed the existence of the short-period variations of the sun.

VISIT TO AUSTRALIA.

In most countries the seat of government is fixed at some prominent city, but the United States and Australia are alike in that a special place was selected to build the capital. In the United States, although the streets were well laid out, no particular care appears to have been taken in regulating the character of buildings in Washington, so that, apart from the great public spaces and some fine buildings for Government purposes, the city presents the ordinary up and down happy-go-lucky appearance of almost all of the American cities. In Australia, however, a competition was established to plan a model city for the new capital at Canberra. Amongst the institutions embraced in the plan of public buildings was to be an observatory. In 1914 the British Association for the Advancement of Science met in Australia. In connection with it, various scientists were invited by the Australian Government, and amongst them the writer was asked to attend and to take the opportunity to present to the Government and to Australians and others interested the story of the solar researches which have been mentioned above, in order that if possible plans might be made for the inclusion of the "solar constant" work in the program of the proposed new Government observatory at the capital city of Canberra.

Accordingly, the writer sailed to Australia in 1914, but as he arrived at Sidney came the news of the outbreak of the great European war. Accompanied by the astronomer royal of England, Sir Oliver Lodge, the former premier of Australia, and other men of great weight, the writer waited upon the premier at Melbourne and presented the case of the "solar constant" work as had been expected. But it was felt that owing to the unexpected participation of Australia in a great war the time was unpropitious for promoting any new projects, although much interest was taken in the work de-



1. OBSERVATORY AND COOKHOUSE, HUMP MOUNTAIN, N. C.



2. A. F. MOORE REDUCING OBSERVATIONS WITH SLIDE-RULE MACHINE.



OBSERVING STATION OF ASTROPHYSICAL OBSERVATORY ON MOUNT WILSON WITH
NEW TOWER TELESCOPE.

Photograph by Abbot.

scribed, not only in Australia but also in New Zealand. Later on, within the last year or two, further inquiries have come from Australia in regard to the work and it may be possible that even yet this kind of observing may be undertaken there.

The writer felt that the regular observation of the solar radiation at several first-class cloudless stations remote from one another in different quarters of the world ought to be undertaken, now that the variation of the sun in short irregular periods had been established. This conviction was much strengthened by the painstaking work of Mr. H. Helm Clayton, chief forecaster of the Argentine Weather Service, who about 1914 began to discuss all the measurements made at Mount Wilson with a view to determine if the apparent changes in the sun appeared to be correlated with the climatic conditions of Argentina and other parts of the world. His computations from the first seemed to point to interesting correlations, so that the desirability of making a better groundwork of "solar constant" observations for the use of meteorologists was strongly indicated.

SOUTH AMERICAN EXPEDITION.

In 1917, Secretary Walcott, of the Smithsonian Institution, decided to employ a part of the income of the Hodgkins fund, which had been bequeathed to the Smithsonian Institution for the advancement of knowledge of atmospheric air, to promote these "solar constant" studies. The entrance of the United States into the war prevented the sending of an expedition immediately to South America as had been expected, and it was temporarily located at Hump Mountain in North Carolina. Here under the charge of Mr. A. F. Moore, assisted by Mr. L. H. Abbot, the measurements were made from June, 1917, to March, 1918. On one occasion observations were carried through successfully with an average air temperature of -5° F. Mr. Abbot froze fingers and feet in making the pyr heliometric observations on this occasion. The results of this day of work did not, however, differ from those obtained under more comfortable auspices, but still further widened the variety of circumstances which seem to have no influence on the accuracy of the results.

In March, 1918, the expedition was removed to Calama, Chile, on the farther edge of the Atacama nitrate desert. Here it was hoped to obtain cloudlessness equal to any which could be found in the whole world. The rainfall in that region is almost nil. Calama, a city of several thousand inhabitants, is situated on the bank of the River Loa, about 10 miles from Chuquicamata where the Guggenheim Co. has a great copper mine, and where is collected a colony of several hundred Americans engaged in the mining operations, in addition to the 10,000 or more Chileans and Bolivians employed there. The officials of the

mining company were very kind and helpful to the Smithsonian expedition under the charge of Mr. Moore, assisted by Mr. Abbot, and placed at their disposal a building at Chorillos, near Calama, along with furniture and other equipment which materially aided in the establishment of the station.

Observations were begun at Calama on July 27, 1918, and continued there for exactly two years. The station proved to be not quite so favorable as had been hoped, owing to the dust and smoke coming from the city and from the mine which occasionally interfered with the purity of the atmosphere. Nevertheless remarkably accordant and satisfactory results were obtained there.

In May, 1919, the writer, with Mrs. Abbot, visited the observers at Calama, and with Mr. Moore went on to La Paz, Bolivia, where they observed the total eclipse of the sun of May 28, 1919, under extraordinary conditions. The sun rose partly eclipsed over a range of snow-covered mountains over 20,000 feet high and was observed under beautifully favorable conditions from the temporary station at an altitude of nearly 13,000 feet, at El Alto, so-called, on the rim of the tremendous canyon above the city of La Paz. Excellent photographs were secured, and also measurements with the pyranometer of the brightness of the sky before and during the eclipse.

On the return to Calama, Mr. Moore and the writer visited the Argentine Weather Bureau station at La Quiaca, Argentina, where they met Mr. Wiggin, chief of the Argentine Weather Service, and Mr. Clayton, chief forecaster, and discussed with them the application of solar radiation measurements to forecasting of weather. Great progress had been made by Mr. Clayton and his colleagues in the computation of the correlations between variations of the sun and variations of temperature, rainfall, etc. So much so, that Mr. Clayton and his chief had become fully convinced of the value of solar variation work as a forecasting element. Already in December, 1919, the Argentine Weather Service had arranged with Mr. Moore, director of the Smithsonian observatory at Calama, for a daily telegraphic report of the "solar constant" value obtained at Calama. In order to furnish this daily report, Messrs. Moore and Abbot had been obliged to work with the greatest rapidity, accuracy, and devotion in the computations. Observations for determining the "solar constant" required several hours of observing, the development and washing of a photographic plate, the reading of six bolographic curves at nearly 40 different places corresponding to 40 different wave lengths of radiation, and a great mass of computations such as formerly used to require nearly three days altogether. Owing, however, to the introduction of a special slide-rule graphical reduction machine, the work had been greatly shortened, and further improvement was made by the use of the theodolite to determine the



1. CARNEGIE SOLAR OBSERVATORY, MOUNT WILSON, CALIF. 160-FOOT TOWER AND 60-INCH DOME.



2. SOLAR OBSERVING STATION AT CALAMA, CHILE.



altitude of the sun, and thereby the mass of air traversed by its beam, instead of to determine this by time observations as had always been the case at Mount Wilson. Nevertheless, the work of determining the "solar constant" on the same day as the observation was extremely arduous and tedious to the two observers. Their enthusiasm was naturally extremely aroused by the favorable reports which were found in the conference of Messrs. Moore and Abbot with Messrs. Wiggin and Clayton in Argentina.

On their return to Calama the writer and Mr. Moore discussed the possibility of determining the "solar constant" by a short method, and after a considerable computation and trial such a method was obtained. It depends upon the fact that the transparency of the sky is closely related to its brightness. It is easy to see that when the sky is hazy the transparency will be diminished and the brightness near the sun greatly increased. The amount of haze depends upon the humidity in the air and also upon the amount of dry dust which has been carried up by the wind, or by volcanic eruptions, or otherwise. It was possible to effect a combination of the measurements of the brightness around the sun by the pyranometer, and the humidity of the air determined by Fowle's spectroscopic method by a single bolograph, so as to obtain a function which could give the coefficient of transparency with a high degree of accuracy. This short method was thereupon introduced at Calama and proved in extensive practice to be highly satisfactory. It is possible thus to obtain the "solar constant" several times in each day, where one observation before had been all that was usual. This new method is continually checked against the older and fundamental one, and up to the present time has shown very satisfactory and complete agreement, except that the new method with its several observations is regarded to be the more accurate of the two.

TRANSFER OF MOUNT WILSON AND CALAMA STATIONS TO BETTER SITES.

Early in the year 1920 the writer had an extended conference verbally and by correspondence with Professor Marvin, Chief of the United States Weather Bureau, as to the applicability of solar radiation measurements for forecasting purposes in general, and in the United States in particular. Mr. Marvin felt that the experimental basis so far available from the results at Mount Wilson and at Calama was not adequate to warrant much investigation of this question. Feeling strongly the justice of this view, the writer urged upon Congress at the hearing of the Smithsonian Institution before the Appropriations Committee in February, 1920, that a suitable appropriation should be made to erect on an isolated mountain in the most cloudless region of the United States a special observing

station for this work. In the then straitened condition of the Government finances the appropriation was not made. Feeling, however, the urgency of the matter, the writer arranged to lay it before Mr. John A. Roebling, of Bernardsville, New Jersey, who had already shown a great deal of interest in the work carried on by the Institution in South America. Mr. Roebling expressed the warmest appreciation of the work and suggested that there would be few found who would take so much interest as he in it, and be willing to support improvements in a foreign country, but that many would be glad to associate themselves with the proposed observing station in Arizona or southern California. However, as attempts had already been made to secure support for that new station, and as the immediate establishment of it was urgent, Mr. Roebling at length proposed to give a certain sum of money on condition that the station in Calama should be removed to a mountain site above the turbidity of the atmosphere caused by the smoke and dust of the mines of Chuquicamata and the town of Calama. Any balance remaining from the gift might then be used for the establishment of a station in Arizona or in the most favored locality, or for any other purposes which might relate to the investigation at hand. He proposed to give \$8,000 toward these objects, but later generously increased this amount to \$11,000. Mr. Moore was immediately telegraphed to in regard to the removal of the station from Calama to a mountain site. Aided by his colleagues, but with his extraordinary devotion, enthusiasm, and energy, Mr. Moore was able to select a most favorable site about 10 miles farther south than the one hitherto occupied, to award contracts for the construction of the observing station and observers' quarters, and to remove the outfit, with a loss of less than 10 observing days, from Calama to the new mountain station called Montezuma, where observations were resumed on August 5, 1920.

The whole cost of this transfer of the observing station, under Mr. Moore's economical management, amounted to but little more than \$4,000. In his subsequent reports Mr. Moore has dwelt with the utmost enthusiasm on the improvement due to the removal to Montezuma. He considers this to be, in regard to the purity of the atmosphere, the freedom from clouds, the absence of winds, the accessibility to the town, and in other respects probably the most favorable station which could be found in the whole world.

Measurements are going on daily at Montezuma, sometimes by the new short method but often by the longer fundamental method as well, and it is expected to continue the work there for a period of years. Mr. Moore having been in South America for two and a half years, has now returned to the United States and will continue



1. OBSERVATORY ON MOUNT HARQUA HALA, ARIZ.



2. COELOSTAT AND PYRHELIOMETER, MOUNT HARQUA HALA.



1. MONTEZUMA SOLAR OBSERVING STATION, CHILE. COELOSTAT AND PYRHELIOMETRIC APPARATUS.



2. MONTEZUMA SOLAR OBSERVING STATION. THE PEAK ON WHICH THE OBSERVATORY IS LOCATED.

the observations in the new station in Arizona. He is succeeded as director in South America by Mr. L. H. Abbot.

ARIZONA STATION.

The remainder of Mr. Roebing's gift was available to transfer the solar radiation outfit hitherto at Mount Wilson to a new locality chosen with regard to its cloudlessness on Mount Harqua Hala, Arizona. The choice of the station resulted from an investigation undertaken by the Weather Bureau through its local chief of operations at Phoenix, Arizona, Mr. Fletcher. This officer made an investigation of many proposed sites in California, Nevada, and Arizona, and at length the choice narrowed down to the vicinity of Bagdad and Cima, towns in California, and to the vicinity of Wenden, Arizona. Special cloud observations were undertaken by observers in these localities, which after six months of observing indicated a preference for the region of Wenden, Arizona. Accordingly, the writer, on the way to Mount Wilson, in June, 1920, let contracts in Wenden for the construction of a building on Mount Harqua Hala, situated about 12 miles to the east of Wenden at an altitude of 5,600 feet. The building, with walls a foot thick of adobe, and having the lower story, partly underground, reserved for the apparatus while the upper was designed for observers' quarters and the computing room, was completed by the end of August and occupied late in September.

The "solar constant" apparatus, which had been employed on Mount Wilson from 1905 to 1920, was then removed and set up for use on Mount Harqua Hala. The first observations were made on October 2, and it is proposed to continue them for several years on every favorable occasion.

The weather on Mount Harqua Hala has hitherto proved more favorable than was expected, so that in the first 65 days of occupation more than 70 per cent proved favorable for observing. Little difference in the transparency between morning and afternoon has been noted, which is a great improvement over the condition upon Mount Wilson, where the change of the wind from land to ocean breezes brings up a mass of haze from the humidity, dust and smoke of the cities of Pasadena and Los Angeles.

The conditions of living on a desert mountain remote from any town are, to be sure, rather remarkable. Mount Harqua Hala has no trees, but only shrubs and plants. There is no water at the top except what falls in the slight rainfall of from 5 to 10 inches which prevails there, mostly in the months of January and July. Communication with the town of Wenden is made by using the Morse code with a strong light at night or with sunlight by day, and

orders for supplies and carrying of mail are given in this manner; also telegraphic messages may be communicated by this heliographic method. The merchant in Wenden, who receives the message, carries out the supplies and mail to the foot of the trail, 11 miles, by auto. A neighbor, Mr. Ellison, a mining prospector living about 1 mile beyond the observing station on Mount Harqua Hala, has three burros which browse about upon the mountain when not in use. On suitable notice, Mr. Ellison, after several hours' search, will bring in his burros and make the trip of 5 miles to the foot of the trail to bring up the supplies and mail. This is done about once in 10 days, so that a single round of communication by letter may be delayed for nearly three weeks en route.

The water for the establishment is also brought by Mr. Ellison with his burros from his camp a mile distant. It is brought about once in four days, and naturally a great economy in the use of it prevails. Hitherto the observations which have been under the writer's charge, assisted by Mr. F. A. Greeley, have been carried on with a water supply of about 30 gallons a week. This serves for drinking purposes, washing the dishes, the washing of clothes, baths, and washing of photographic plates.

The two observers, besides carrying on the observations and a large portion of the reductions from them, do their own household work, such as the cooking, preparation of meals, washing of dishes, and the washing of clothes. The life is very healthful in that clear, pure air and has many points of pleasure, such as the glorious sunrises and sunsets which are often observed. It is beautiful also to watch the stars from this mountain, which is the highest one for many miles around. For recreation the observers are accustomed to throw the horseshoe, play the graphophone, read books, and to play games, but nearly all of the time from sunrise to bedtime is devoted entirely to the work.

PRESENT STATUS OF THE INVESTIGATION.

Thus, thanks to Mr. Roebing's generosity, we have now two first-rate solar-radiation observing stations, about 4,000 miles apart, which by rigid economy it is hoped to be able to keep in operation continuously for some years to come. In this way a strong basis of solar observations will, it is hoped, be maintained which may be compared hereafter with weather conditions in all parts of the world and serve to establish whether or not measurements of solar variability are essential elements for weather forecasting. Meanwhile, the Government weather services of Argentina and Brazil have become so fully impressed with the value of these data that they employ our telegraphic daily reports from Chile regularly in their official fore-

casts. Our own weather bureau is investigating the relations of the more complicated weather conditions of the United States to the radiation of the sun, and with results which tend to raise the hope that here also the solar-radiation values will be of interest and importance in weather forecasting. Thus the outlook indicates that Doctor Langley's prophetic hope may be to a considerable extent fulfilled, and that knowledge of the sun may help to foretell the climatic conditions of the world.

If it should prove, from the results now being obtained in the New World, that this element is a valuable one for forecasting, it must follow that additional solar-radiation stations will be established in the most cloudless regions of the Old World to join in securing strong daily values of the intensity of the solar beam. Such stations might properly be located in Egypt, South Africa, Australia, or India, or all of these regions. Not less than four solar-radiation stations, all operating under a common procedure and homogeneous in all respects, would be necessary for the satisfactory observation of the sun on every day of the year.

The cost of such observatories is not large. Two are already established. Four others could be established and continued by an annual outlay of \$50,000. The cost of the war for a single hour of time, if it could have been diverted to this fundamental research, would have carried it on forever.



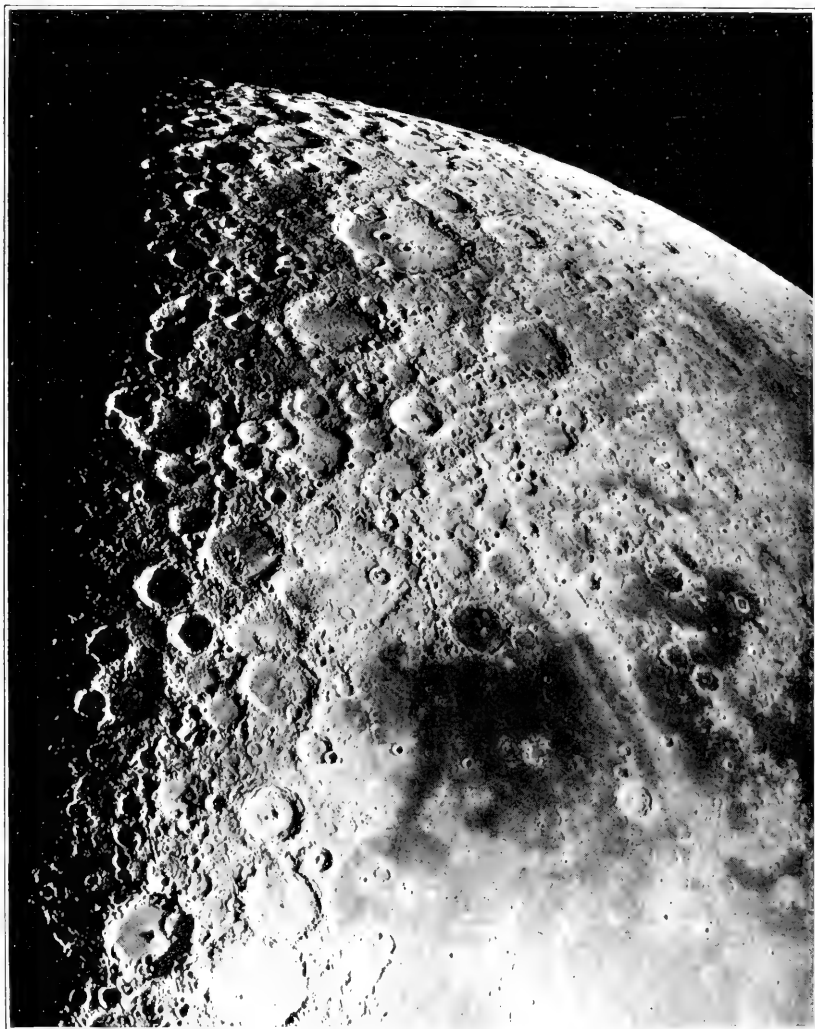

SOUTHERN PORTION OF THE MOON AT LAST QUARTER.

Photograph made at the Mount Wilson Solar Observatory with the Hooker Telescope.

THE HABITABILITY OF VENUS, MARS, AND OTHER WORLDS.

By C. G. ABBOT.

[With 3 plates.]

In considering the probability of the existence of intelligent life on other heavenly bodies than the earth, it will be convenient to take up these heavenly bodies in several groups, dealing first with those in which conditions are so very different from ours that the existence of life seems impossible.

THE MOON, THE SUN, AND THE OUTER PLANETS.

The moon is our nearest neighbor and coplanet with ourselves. Astronomers usually call the earth the planet and the moon merely a satellite. Except for unequal size one is as much a planet and as much a satellite as the other. They revolve together around the sun, and rotate together about their common center of gravity. But as the earth is of 4 times as great diameter as the moon, and is 81 times as massive, it is the controlling member of the partnership, and swings the moon as the big boy at school does the little one in the game of "crack the whip."

At 240,000 miles distance the moon is beautifully seen and studied by the aid of a telescope. It is a waterless, airless, mountainous desert. There is no probability whatever that intelligent beings can be there.

What of our great benefactor, the sun? No living thing, scarcely even the hardest chemical compound, can exist there because of the intense heat. On earth the hottest thing is the electric arc, which not only melts but turns into gas every substance. The spectroscope and the heat-measuring appliances show that the solar temperature is nearly twice as great as that of the arc. Hydrogen would not burn in pure oxygen on the sun, but water, if it could ever reach there as steam, would be instantly separated into these component gases.

Circling the sun, beyond the orbit of the earth, lie five great planets: Mars, Jupiter, Saturn, Uranus, and Neptune. Within the earth's orbit there are two: Venus and Mercury.

The planets naturally divide into two equal groups whose members differ significantly in density. The four inner planets, Mercury, Venus, Earth, and Mars are not very unlike in this respect. Of the four outer planets, Jupiter, the most dense, is only 1.3 times as heavy as an equal volume of water. We have hardly any earth, stones, or metals so light as this. It is most probable that these four planets are mainly gaseous. For this reason alone it would be unreasonable to think of them as proper abodes of intelligent life, but we have also to consider the temperature conditions which probably prevail in the outer planets.

The following table gives the principal data on which temperature estimates (given in the last column) have been based with regard to the moon and to all the planets. The estimated temperature of the sun depends upon the distribution of its radiant energy in the spectrum; that of the earth is well known from numerous thermometric measurements. The temperature of the sunlit surface of the full moon, which has been investigated by Langley, Very, and others, appears to be probably between freezing and boiling points of water. The dark side appears to be exceedingly cold. The estimates here given of the temperatures of the other planets are based upon the approximately known temperatures of the earth and moon with consideration of the relative reflecting powers and solar distances of the planets as compared with those of the earth and moon. The values given, although rough, are yet sufficiently indicative of the conditions in the other planets.

	Diameter.	Density, water=1.	Mass, earth=1.	Gravity, earth=1.	Solar distance (million miles).	Day.	Year.	Reflect- ing power.	Probable tempera- ture.
	<i>Miles.</i>					<i>Hours.</i>	<i>Days.</i>	<i>Per cent.</i>	<i>° F.</i>
Sun.....	865,000	1.4	332,800.	27.6	600. ±	+12,000
Mercury.....	3,030	4.4?	.045	.2 ?	36.0	(?)	88	7	+ 450
Venus.....	7,700	4.9	.816	.8	67.2	(?)	225	59	+ 68
Earth.....	7,918	5.5	1.000	1.0	92.9	24.0	365	44	+ 59
Moon.....	2,163	3.4	.012	.16	92.9	656.0	365	7	+ 50
Mars.....	4,230	3.9	.107	.4	141.5	24.6	687	15	- 60
Jupiter.....	86,500	1.3	317.0	2.6	483.3	9.8	4,332	56	- 270
Saturn.....	70,000	.7	94.8	1.2	886.0	10.3	10,759	63	- 330
Uranus.....	31,500	1.2	14.6	.9	1,781.9	(?)	30,687	63	- 380
Neptune.....	34,800	1.1	17.0	.9	2,791.6	(?)	60,181	73	- 400

From this we see that if the sun is the sole source of heat and light, the supposed inhabitants of Neptune, Uranus, Saturn, and Jupiter would probably be much more unfavorably situated than the Eskimo in their climatic conditions. The mass and volume of the planets is not such as to warrant us in the belief that they can still have, at their immense ages, sources of heat within themselves which can supplement to a useful degree the sun as the supporter of life, unless possibly such might be the case with Jupiter. On the whole,

the probabilities of intelligent life on the four outer planets can not be regarded as considerable.

WORLDS AMONG THE STARS.

As is well known, the stars are but suns and the sun our nearest star. Hence the tremendous temperature which prevails in the sun and prevents us from supposing for a moment that the sun is capable of being an abode for intelligent life, must be regarded as an equally effectual bar against the existence of life upon the other stars. But, just as the sun has a train of planets and satellites which revolve about it, one might assume that the other stars should be similarly attended. To be sure no such planetary trains have been reported by telescopic or spectroscopic observers, but that would not be expected. The distances of the stars are so immense and the disparity of brightness between a body, like the sun, and a body shining by reflected sunlight, like one of the planets, is so enormous that it is not to be supposed that a single one of these supposed starry worlds would be visible even if they existed in almost countless numbers. In illustration of the enormous difference in light-giving powers, it may be remarked that at equal distances the sun would be roughly 1,500,000,000 times as bright as the earth.

The spectroscope, as readers well know, is sometimes capable of indicating the presence of bodies that are invisible to the telescope. Thus there are large numbers of binary and multiple stars in which the components of the system are so close together that the telescope can not see them separately but which, on account of their rotation about a common center, give slight displacements of the spectrum lines owing to motions in their orbits toward and from us in line of sight. It is not even necessary that the component bodies should both be light giving. It has been actually observed in the case of binary stars whose orbits lie in such a plane that the two bodies alternately eclipse one another, that one may be light giving and the other quite dark, yet in the revolution of the light-giving component around the center its spectrum lines are shifted, and of course a variation in its light is caused when it is partly eclipsed by its companion. Without even partially eclipsing the companion, one of these dark bodies may yet, by its gravitational attraction, cause such a rapid motion in the bright star as to indicate its presence by the shifting of spectrum lines. This, however, can only be detected when the dark companion is large enough to produce an orbit of some considerable dimensions.

In the case of our planetary system, the attractions of any and all of the planets are not sufficient to displace the sun appreciably to such spectroscopic observations. Such would probably be the case with

other stars. It seems certain that an immense number of dark planetary bodies may exist as companions to the stars without our being able to detect their existence by the powerful spectroscopic and telescopic means at our command. Indeed we can not conceive that any increases of our observational apparatus will ever enable us to decide whether or not such bodies exist. The probability is that they do so, and in such immense numbers that among them there may well be many suitable for abodes of intelligent life. This subject, of course, opens the door wide for speculation, but this field lies so far from the realms of certainty that it is not my purpose to enter upon it here.

ARE MERCURY, VENUS, AND MARS HABITABLE?

To us the question has narrowed itself to this: Are Mercury, Venus, and Mars fit for habitation? The answer requires us to consider for a moment the most important requisites of life. Animals live on plants. Plants require warmth, light, water, carbon compounds, and certain inorganic salts. But are we justified in supposing that in a climate where water would be changed to ice or steam, life would be impossible? It is difficult to conceive that water in the rigid form of ice could serve a living being as a prime part of his make-up. Where would be the flexibility of motion required to circulate the food and carry on the functions of the body? It may, indeed, be urged that other liquids might take the place of water. But the properties of water are unique. An almost universal solvent, its solutions possess electrical and chemical properties so far more wonderful than any others that comparison is impossible.

Aside from water, one must insist on the element carbon as indispensable to life. The spectroscope teaches us that all the heavenly bodies are of the same chemical elements. Our earth has samples of all of the star-building materials and we know well their combinations. Among all these elements there is none that has the versatility of carbon. Its compounds are innumerable and of the most bewildering complexity. It only can be the basis of life, which seems to require the most complex of the mysterious intricacies of carbon chain building for its simplest creatures. These complex life substances, however, are broken down by temperatures like that of steam, and are mostly rigid at temperatures like that of ice. Within this temperature range, from freezing to boiling, we must believe lies all the theater of animal and vegetable life.

Light, too, is necessary, but its requirements are more elastic. Plants grow and animals thrive where the light is a thousandfold less than daylight, and the full sun is far from being too strong for most of them. All three of our planets would satisfy the require-



PHOTOGRAPHS OF THE PLANET MARS TAKEN AT THE MOUNT WILSON SOLAR OBSERVATORY.

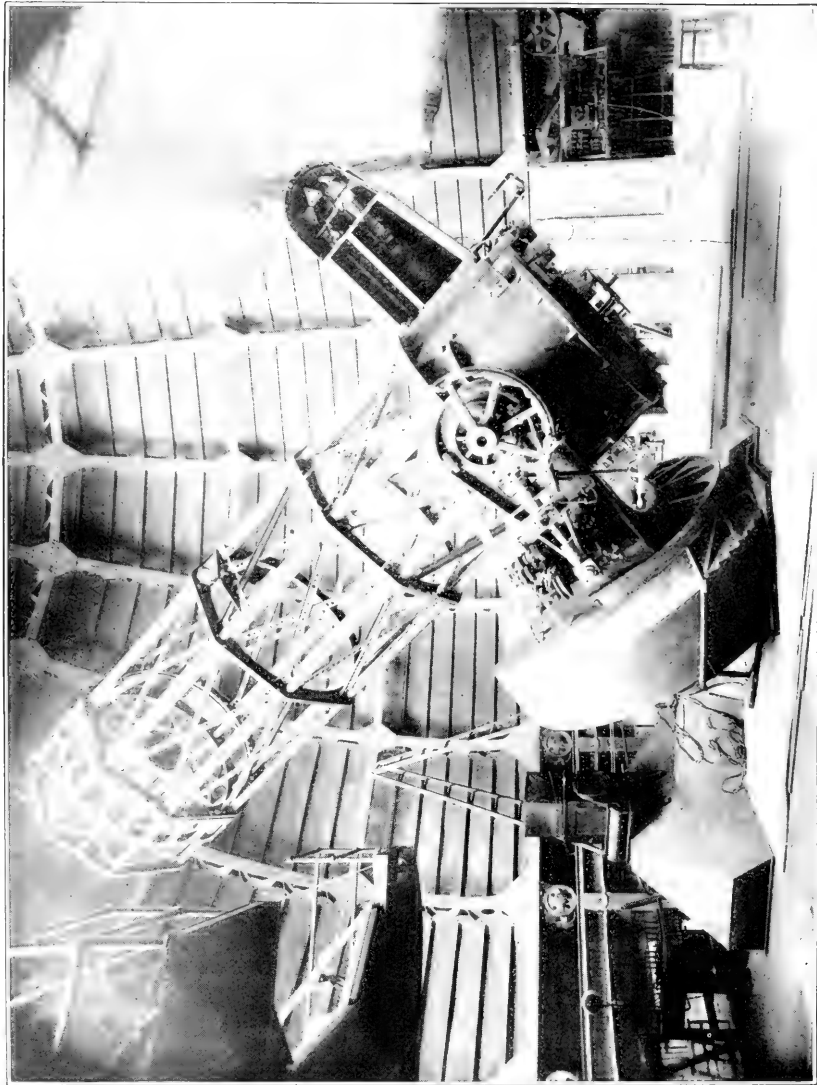

SIXTY-INCH REFLECTING TELESCOPE WITH CASSEGRAIN SPECTROGRAPH IN THE MOUNT WILSON SOLAR OBSERVATORY.

ments as to light. We must test their qualifications as to temperature and moisture. In so doing we ought not to lose sight of the influence of moisture on temperature. The water vapor and clouds in the earth's atmosphere seem to be responsible for maintaining our average temperature fully 50° F. above what it would be if, notwithstanding their absence, the sun shone no more intensely on the earth than now. Besides this, the range of temperature between day and night, shade and sunlight, would be enormously increased if the moist atmospheric blanket were removed, as all who live in deserts know.

Referring to the table given above, we see that, considering the distances and reflecting powers of the planets, the sunlight available on Mercury, Venus, and Mars is, respectively, of 12, 1.1, and 0.6 times the intensity of that which is available to us upon the earth. As shown by the reflecting power, Mercury, like the moon, is an airless, waterless waste, and being, besides, baked by a twelvefold torrid heat, there can be no thought of life upon Mercury.

Many popular writers have claimed great things for Mars as the abode of life. I can not accept this view. Director Campbell, of Lick Observatory, in two widely different and extremely beautiful and thorough researches, satisfied astronomers that the water vapor in the Martian atmosphere is less than one-fifth of the trifling quantity which prevails over Mount Hamilton in the coldest clear nights of winter. Thus, without the earth's moist atmospheric blanket, and with only 0.6 the solar heat, the average Martian temperature should be 60° below zero Fahrenheit. Telescopic observations reveal no clouds on Mars. Its most talked-of features are dimly visible markings called fancifully by some "canals," but by observers like Barnard, Hale, and others, studying under ideal conditions, regarded merely as irregularities in the planet's contour and soil composition, which at the immense distance are on the limit of telescopic vision and take on one shape or another according to the observer's interpretation.

In the Publications of the Astronomical Society of the Pacific, April, 1918, Doctor Campbell has confronted in parallel columns the descriptions, sketches, and conclusions of the two most prominent observers of Martian "canals." There is apparent such widely contradictory testimony as would be expected of two persons who should try to describe the landscape of the moon without ever having used a telescope. In view of the immense distance, and the equal inadequacy of the telescope for Mars and the naked eye for the moon, it is probable that both of these Martian accounts are as remote as theirs would be from the truth. All observers, of course, are agreed as to the existence of markings and shadings of color on Mars, but to

suppose that we see there the engineering works of intelligent beings is merely fanciful. As for the polar caps which form and melt with the Martian seasons, the best opinion is in doubt whether these may be thin deposits of hoar frost from the traces of water vapor in the atmosphere, or frozen carbonic acid gas, which, in view of the low temperature of Mars, is perhaps as probable.

Mercury being surely uninhabitable, and Mars most certainly inhospitable, there remains only Venus among the planets as a probable abode for intelligent life. Here we must be struck by the favorable prospect. A twin planet to the earth in size and mass, its high reflecting power seems to show that Venus is largely covered by clouds indicative of abundant moisture; probably at almost identical temperatures to ours, our sister planet appears lacking in no essential to habitability.

Some writers have said that owing to the supposed period of rotation of Venus on its own axis being equal to its period of revolution around the sun, just as occurs in the case of the moon with respect to the earth, Venus must always present the same side toward the sun, and that therefore the one-half would be in extremest cold and the other in a most blistering heat. Dr. A. Graham Bell has pointed out to me in conversation, however, that this view of things is most improbable. The reflecting power of Venus has been carefully determined and, as given above, lies in the neighborhood of 60 per cent. So high a reflecting power demands apparently the existence of clouds, and these clouds can hardly be of any other substance than water. If it were a fact that the rotation period of Venus is equal to its period of revolution around the sun, all of the water would be distilled from the hot side to the cold side and these clouds would disappear. These evidences alone seem to me to be sufficient to overcome the observational evidence which indicates the equality of periods of rotation and revolution. That is dependent on spectroscopic observations to some extent, and these are not competent to indicate more than that the period of revolution is large as compared with our day. They are not accurate enough to show that the period is 225 days, equal to the year of Venus, but it may be anything above 10 of our days, as far as the present spectroscopic observations would be accurate enough to indicate. As for the reported observation of markings upon the planet which were said to rotate in 225 days, this observation can only be regarded with the greatest doubtfulness.

It is only because the clouds have always prevented a telescopic view of its surface that Venus excites no popular interest like that aroused by Mars. If it should be reserved for the early future to exchange intelligence with our nearest planetary neighbor after the

moon, the popular apathy would naturally be changed to the most lively interest.¹

It will be recalled that a good deal of discussion has appeared in the press as to the possibility of communicating with other planets by wireless telegraphy and even accompanied by the suggestion that we are already receiving wireless signals from intelligent beings outside of the earth which may in time be interpretable. The best information seems to be that the wireless indications referred to are merely disturbances introduced by solar or terrestrial causes as yet imperfectly understood and not the work of intelligent beings trying to communicate with us. At the same time, computations have been published which seem to make it within the limits of possibility that wireless communications might be exchanged with the nearer planets, if it were worth while to do so, although at immense cost.

Proposals have also been made from time to time of communicating by searchlights or mirrors in the ordinary methods of heliographing. To me, these latter proposals seem altogether too sanguine. Certainly for a planet like Venus which is almost wholly covered by fogs the chance of a beam of sunlight or a searchlight beam penetrating to the surface where it could be observed by the supposed inhabitants, notwithstanding the glare of their own atmosphere and the glare of the whole relatively immense surface of the earth as compared to the surface of the reflectors or searchlights employed, is quite beyond probability. If it were a case of communicating with the moon, there would be little doubt but that it could be accomplished. If it were Mars or one of the still more distant planets that was being considered, there seems to be not the slightest probability of success by the use of lights. So far as we know, then, any communications which can be made with other intelligent beings, if there are any, must be by means of wireless telegraphy or some as yet undiscovered means of communication.

If we could talk freely with intelligences existing on another world, having a history, social customs and laws, and religious faiths developed absolutely independently from those of this world our conversation would be not only of surpassing interest to science and the humanities, but what a guide it might prove to statesmen and sociologists!

¹As this paper is in press private advices come that St. John's spectroscopic studies of Venus throw doubt on the existence of water vapor there. If this is confirmed the habitability of Venus would seem highly improbable. It is difficult, however, to understand the high reflecting power of the planet if clouds are absent, and we must await further information.

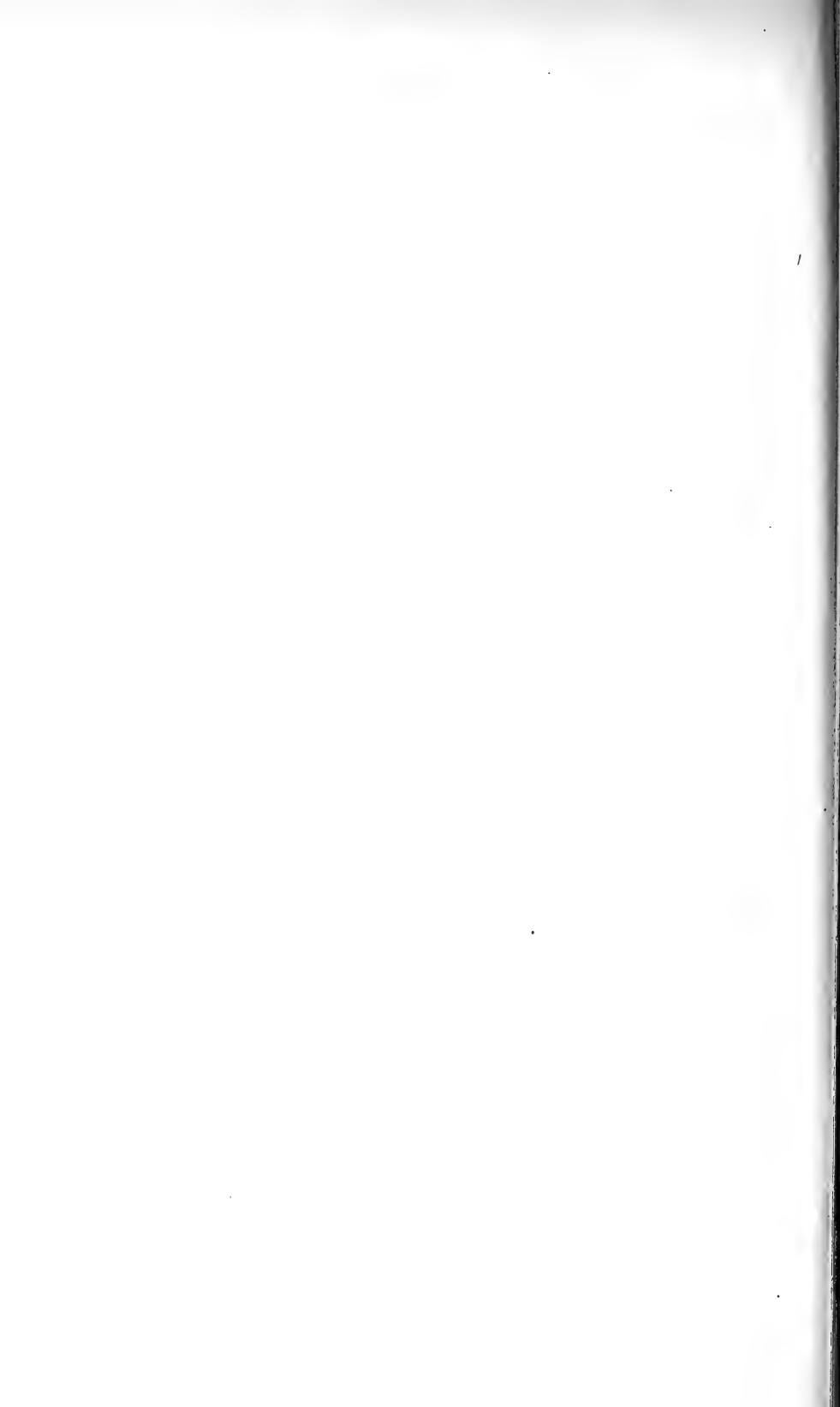

GIANT SUNS.¹

By PROF. H. H. TURNER, D. SC., D. C. L., F. R. S., F. R. A. S.

We have all been fascinated by giants, from the times we read of Jack the Giant Killer in our childhood to those more recent when we read of the exploits of Lieutenant Warneford and his successors in their fights with the giant Zeppelins.

I make no apology for shortening my title a little from what astronomers might expect. I might have chosen "Giant and Dwarf Stars," but stars are suns, as we shall see presently, and though I shall include "dwarf" suns, the real dwarfs of science are the tiny atoms at the other end of the scale of investigation—or rather, the electrons into which they have been broken up.

How shall we gauge the size of a star to see whether it is a giant? We must know two things: First of all, the apparent size of its disk, and secondly, its distance. In the old days it was thought that the size of the sun could be estimated from one of these only—from the size of the disk. Lucretius,² following Epicurus, believed that the sun was a small body. He arrived at this conclusion by neglecting entirely the consideration of the distance and judging by the appearance to our senses.

Now, without attempting to decide whether the sun is the size of a soup-plate, or of a threepenny-bit, or what is the size that it seems to be, we may remark that it seems to be about the same size as the moon, and that by Lucretius' principle the sun and moon ought to be of the same actual size. However, we now know that the sun is 400 times bigger than the moon, because its distance is 400 times greater. We have measured the distance of the sun and found it to be nearly 100,000,000 miles, and we have measured that of the moon and found it to be nearly one-fourth million; and since the disks appear of about

¹ Reprinted by permission from Proceedings of the Weekly Evening Meeting of the Royal Institution of Great Britain, Jan. 31, 1919.

² "Nec nimio solis major rota nec minor ardor
Esse potest, nostris quam sensibus esse videtur."

Lucret., De Nat. Rer., v. 564-5.

the same angular size (viz, about one one-hundredth part of the distance in each case), we know that the sun must be about 1,000,000 miles in diameter and the moon only about 2,500 miles, using round numbers throughout for simplicity.

Thus the sun is a veritable giant compared with the moon, in spite of the similar apparent size of the disks; but this we discover only when we have measured the distances.

The sun and moon present to us large disks which we can study in detail, and the study of the disk of the sun by means of the spectroheliograph has had new triumphs which, owing to the war, have not yet been seen in this room, so that I may be pardoned for exhibiting one.

But when we come to the stars there is no disk. If one seems to see disks for these objects, the appearance comes through the imperfections of the telescope. Hence it would seem to be superfluous to inquire about their distance. When Mark Twain had been roughly handled at Niagara Falls, and the doctor reported that only 16 of his wounds were mortal, he said "he did not care about the others." In the same way we might argue that since the stars have no appreciable disks we need not care about their distances.

That, however, was not the attitude of men of science. They went to work to measure their distances, and though the difficulties were heart breaking they were attacked and overcome. Here is a table showing a sensible fraction of the life work of an eminent Scotsman, Sir David Gill, observing at the Cape of Good Hope. It includes the famous α Centauri, the first star to have its distance measured at all, which again was by a Scotsman, Henderson, also observing at the Cape of Good Hope.

Gill's parallaxes of bright stars.

Star.	Parallax.	Distance in light-years.	Star.	Parallax.	Distance in light-years.
	"			"	
Sirius.....	0.37	9	β Centauri.....	0.03	100
Canopus.....	.00	(?)	α Crucis.....	.05	64
Rigel.....	.00	(?)	Spica.....	.00	(?)
α Centauri.....	.75	4	α Pisc. Austr.....	.13	25
α Eridani.....	.04	80	β Crucis.....	.00	(?)

Sir David Gill was accustomed to describe the difficulties of determining that distance by saying that it was like trying to measure the size of a 3-penny bit 2 miles off; and we remember his delight when his chairman, on one occasion asked, "Who but a Scotsman would care about a 3-penny bit 2 miles away?"

But you will see that this star is the nearest and therefore easiest of all; while some even of these brightest stars gave no result even

to a patient Scotsman. Those that are measurable show that they are so far off that light takes years to come to us from them—from some four years; from others hundreds of years; from those with no measurable result, thousands of years at least.

Thus we began to obtain a little knowledge of the distance of the stars. The method used for these measurements was the usual method of parallax, which we may illustrate by two searchlights trained on the same Zeppelin. Knowing their distance apart and the angles at which they are sending their beams of light, those working the apparatus can draw the triangle to scale and thus tell the height of the Zeppelin.

Now, replace the two searchlights by two telescopes—one on one side of the earth's orbit round the sun, and the other on the other side; they can not be there simultaneously, but the star will wait six months for us to move round or even longer. The angle at the Zeppelin becomes, however, woefully small as we suppose it to mount to the stars. It is twice the angle which seems to separate earth and sun as seen from the Zeppelin, and it is this angle which is represented by the diameter of "a 3-penny bit 2 miles away." From the distance of the nearest star the sun and earth might appear as a close double star, of which there are many examples in the heavens, though our little earth would probably be too faint to be seen, even from the nearest star spectator.

There would be no such difficulty in seeing the sun, but since his diameter is only one one-hundredth part of the distance between earth and sun, which has itself shrunk to almost imperceptible dimensions, it is easy to realize that the disk of the sun would have disappeared completely, as does any disk of the stars to us, even with our largest telescopes.

Since we have imagined ourselves to mount far upward to α Centauri, whence the sun and earth would represent a close double star, let us retain the conception a moment longer in order to note a useful fact. Watching long enough we should see the pair moving across the heavens, while at the same time the earth would revolve round its mighty companion. The sun would proceed therefore very much more steadily than the earth. The sun's path is nearly straight, while the earth takes a wavy path, or more correctly a corkscrew path. If the masses of the two bodies were more nearly equal, the two paths would be more nearly alike, and both wavy.

By observing such movements (for we can observe the movements of stars) we infer whether one component of a double star is more massive than the other or whether they are nearly equal; and it is found that there is never any very great disparity in mass between the components. Their masses are closely similar, like those of peb-

bles on a beach. But this tells us nothing about the sizes of the minute disks. Have I gone too far perhaps in saying there is no disk visible in any star? Nebulæ do show disks, and though they are nebulae and not stars they may become stars. The new secrets wrested from the stars have chiefly come, not from the increase in size of telescopes, but from the new appliances attached to them, such as the photographic plate, the spectroscope, and by this time many others. The lines in the spectra of stars tell us what the stars are made of, how they may be classified accordingly, how fast they are moving, how bright they really are (this is an amazing recent discovery), and by inference how far away, and may yet have other surprises in store. For the moment we are chiefly concerned with the classification. The Harvard system gives us a number of classes denoted by the capital letters O B A F G K M R N. The fact that the order is not quite the same as that of the alphabet represents a revision of early ideas, chiefly due to the gradual accumulation of intermediate types, which make a nearly continuous series.

Now a series of stars in order is probably a representation of growth; just as the growth of trees may be illustrated by selecting various stages from the same wood, an illustration originally given by Sir W. Herschel. But we have seen a tree grow, and we know independently that it grows up from the acorn through the sapling to the giant oak; while we have not had time to see a star grow and were thus in ignorance whether the changes are from B toward M or from M toward B, though by this time we have an immense number classified. The classification has been largely the work of an American lady, Miss Cannon. I am told that there is a man who can deftly straighten rifle barrels—he gives a glance along the barrel, a tap with a hammer, and lo! it is straight. His value is recognized at some £15 a week. Miss Cannon has the same deftness with spectra—but I fear that (to judge from the report of the Board of Visitors of Harvard Observatory) her great skill is not so appropriately rewarded.

Now, it is obviously important to find out, if we can, which is the direction of a star's growth, and we seemed to have an important clue when the spectral classification was connected with the temperature of a star, or rather its surface temperature, which is all we can get at. The outside is the coolest, just as the edges of a plate of porridge are the coolest, as most of us have learned by early and rather painful experience. And yet the outside of a star is hot enough. The temperature is again estimated from the spectrum, though this time not from the lines but from the relative intensities of its parts, and the O B A end is undoubtedly hotter than the other. We may give as illustrations $15,000^{\circ}$ for B, $5,000^{\circ}$ for G, and

2,500° for M. Does this settle the matter? We know that there is a general tendency for all bodies to cool which points to the direction O B—M N as the order of events; but it was also known that under the stress of gravitation a star might rise in temperature, in which case the growth might be the other way. Still the former alternative commended itself more generally; and when Prof. W. W. Campbell found that the velocities of stars (also determined with the spectroscope) were smaller for type B than for type M, the facts were interpreted to mean that a star moved more quickly with advancing age (because M stars were older than B). The idea that the life of a star was spent in passage down the series O B—M was indeed pretty firmly established at the time when the revolution came.

The revolution began with the advent of a young American research student, Mr. H. N. Russell, to Cambridge in 1904-6. It is to the credit of Mr. A. R. Hinks that he made so much of this brilliant young student, setting him on the way to determine the distances of a number of stars by photography with the instruments which he (Mr. Hinks) has spent much time and labor in perfecting. This was the first element in his success. The next was that on his return to America he got from the Harvard Observatory—that storehouse of astronomical facts—the spectral types of his stars; and combining these with the measures of distance (which told him the intrinsic brightness or luminosities of the stars) he found that stars of the same spectral type M fell into two distinct groups separated by an interval. There were very bright stars, now called giants, and there were very faint ones, now called dwarfs, but none of intermediate stature.

The same was true in minor degree for stars of other types, but as the B end of the series was approached the gap gradually disappeared much in the way that the gap between the legs of a stepladder gradually lessens as we approach the top. Indeed Russell's diagram of his results is very like a stepladder, the top representing the B stars followed by A, F, G, K, M, in descending order, and the gap between the two legs of the ladder representing the difference in luminosity, as the intrinsic brightness of a star has come to be called. Russell brought this diagram with him when he came to attend the meeting of the Solar Union at Bonn in 1913. It is sad to remember the occasion, for the most friendly relations seemed to have been permanently established between the various nations assembled. We remember with especial regret the trip on a great steamer on the Rhine which ended the meeting, and, alas! was the end also of our hopes of a permanent friendliness, for before the year had passed the great war had shattered them all. It was on

his return from Germany through England that Russell showed us his stepladder diagram at the Royal Astronomical Society, and expounded his views on the evolution of a star, which were that its life began at the foot of the upright leg, the ascent of which signified that the star was growing continually hotter and changing its spectral type meantime from M upward toward B, that at B the increase of temperature was arrested and after a time cooling began, carrying the star down the inclined leg of the ladder through changes in the reverse order. The only weak spot in the evidence arose from the small number of observations. To determine the actual or intrinsic brightness of a star we must know its distance, and there are not many stars of which the distance can be easily measured, and though Russell had himself increased the number, the total was still not large. To get further evidence he had recourse to indirect estimates of distance, especially those of clusters of stars. We have lately become more and more aware of the association of stars in clusters represented by their common movement, somewhat in the way that the movements of a flock of birds migrating from one place to another are associated. If we may accept this evidence, and if we can determine the distance of any one star in the cluster, the distances of the others can be inferred. In Russell's skilful hands this evidence was collated and found to strengthen his conclusions.

Let us pause here for a moment to reflect on the inherent probability of the suggestion. Is it not after all much more likely that a star first rises in temperature and then falls rather than that it should be permanently either rising or falling? Now that the idea has been put forward, and that there seems to be not only good evidence of this change in the sky, but, as we shall presently see, also good theoretical reason for it, we wonder why the idea was not the most natural one to adopt from the first. But curiously enough it was not the one adopted by astronomers, with the notable exception of Sir Norman Lockyer, who made the same suggestion as Russell's (though on different grounds) many years before. May I give a crude illustration from our ordinary life of the mistake that was made by many of us? It is as though we had taken the amount of hair as an indication of the age of a man. In very early life the amount of hair is small, it increases with age up to a certain point, but then it begins to decrease until a very old man often has as little hair as a new-born baby. We could give Shakespeare's seven ages of man according to the amount of hair in the same diagrammatic form as Russell's stepladder, beginning with the baby at the foot of the upright leg, ascending to the man in the middle life with maximum hair (corresponding to the maximum temperature), and placing the greater ages down the inclined leg till we arrive

again at a bald pate. Shakespeare reminds us with his phrase about the voice "turning again toward a childish treble" that not only the hair but the voice goes through changes which show a reversal after middle life. We were practically confusing the baby stars with the old-man stars until Russell called our attention to the fact; and now it seems quite easy to make the distinction. But there was some hesitation before the new views were accepted at all, chiefly on account of the lack of sufficient measures of distance, which left room for doubt. Recently the evidence has been reinforced in a remarkable way by a totally new and unexpected method for inferring the distances of stars, due to Mr. W. S. Adams, of the Mount Wilson Observatory in California. His discovery is that if we have two stars, one of which is very bright intrinsically and the other faint, but both of the same spectral type, we can find two lines of the spectra which have different relative intensities: let us call them A and B. In the bright star A is more intense than B, in the faint star B will be more intense than A. Now observe that this difference will persist however far we may remove the stars from us. By altering the distances we may make the brighter star *appear* the fainter, but we can pierce its disguise by noting simply that the line A in the spectra is the more intense, so that if the star *appears* faint we see at once that this must be due to its greater distance. In fact we can infer the distance from the relative intensities of the lines A and B, so that Adams has really given us a new method of inferring distances. The new method has the further advantage of requiring far less labor than the old method of parallax; in fact, when once the spectrum has been photographed the further labor required is quite small, so that by this time Adams has been able to give us the luminosity of hundreds of new stars, and by this overwhelming evidence confirms Russell's results derived from merely a few. In reply to a request he has sent me specially for this lecture the following table of results, and I am sure you will appreciate his kindness.

[In the lecture the results were represented diagrammatically; here Adams's actual figures are reproduced on the next page. To see the "stepladder" hold the table sideways, so that the column of absolute magnitudes is at the bottom. The upright leg is then represented by the two rules across the page. It will be seen that the majority of intrinsically luminous stars are contained between these lines. The sloping leg is easily seen from the lie of the figures. That there are very few faint stars of class M does not mean that there are few in the heavens, but that they are the most difficult to observe from their faintness.]

W. S. Adams's results up to Nov. 8, 1918.

Abs. Mag.	Mc to Md.	K ₁ to K ₉ .	G ₉ to K ₃ .	F ₉ to G ₈ .	A ₇ to F ₈ .
- 2.8	1	1
- 2.3	1	2
- 1.8	1	2	3
- 1.3	1	4	1	3	2
- 0.8	15	34	12	7	5
- 0.3	11	36	33	33	7
+ 0.2	35	11	70	44	3
+ 0.7	13	72	34	12
+ 1.2	6	22	21	13
+ 1.7	1	12	8	5
+ 2.2	7	2	13
+ 2.7	3	5	15
+ 3.2	4	2	17
+ 3.7	1	7	20
+ 4.2	3	11	35
+ 4.7	3	28	22
+ 5.2	1	4	21	18
+ 5.7	0	8	26
+ 6.2	3	38	32
+ 6.7	11	15	4
+ 7.2	13	10
+ 7.7	5	3
+ 8.2	8
+ 8.7	13
+ 9.2	4
+ 9.7	3	2
+10.2	4
+10.7	3
+11.2	3
+11.7
+12.2
+12.7
+13.2	1
Total.	99	145	321	290	193

In addition to this confirmation by new observations we have had an independent confirmation by the brilliant theoretical work of Professor Eddington, who has attacked the problem of the life of a star mathematically. He supposed a mass of gas first of all to be simply under the action of its own gravity. It will consequently contract, and owing to the contraction will rise in temperature; but Professor Eddington soon found that this simple hypothesis would not answer—it led him to impossible results. Clearly something else besides gravity must be at work, and he was driven to the further hypothesis that the *radiation-pressure* inside the star played an important part in its history. Radiation-pressure (or if we like to call it so, light-pressure) is what makes the tail of a comet. As a comet approaches the sun it begins to feel the effects of the fierce light, which is known to be able to drive away very small particles from the head of the comet, much as we can blow away chaff from wheat. In consequence of this action the small dust-like particles which may exist in the head are believed to be driven outward to form the tail. But this force is not merely in existence on the outside of the sun; it permeates its whole body. A particle inside the sun is of course receiving radiation-pressure from all its surroundings, but the pressure will naturally be greater on the hotter

side, i. e., on the side of the sun's center. Working out the problem afresh with the addition of this new factor Professor Eddington has obtained results which agree satisfactorily with the observed effects, and indeed the closeness of the agreement is startling. He is able to utilize the fact noticed earlier in the lecture, that the masses of the stars are not very different, so that it is easy to take three representative cases—let us say one in which the mass is equal to that of our sun, one in which it is five times greater, and one in which it is five times less—and by following these three cases in detail he can show the distinctive features of different stars. Briefly, the step-ladder is highest for the star of greatest mass, which may get hotter and hotter until it reaches type O; a star of intermediate mass like our sun is arrested at a lower height and may not reach higher than type F, or at best A, before it begins to fall down the inclined leg, while a star of small mass may reach no higher than type K at any time. The golfers in the audience may be reminded of their handicaps. Those who are destined to be scratch players (probably, however, not because of their great mass) improve very rapidly until they reach the highest pitch of excellence, and it may even be only in old age that they begin to travel downward; but then there are others of long handicap who, although they may improve a little at first, never get beyond the fatal 18 at their best and on whom declining years soon begin to leave their mark.

One of the most remarkable suggestions of Professor Eddington's work gives a reason for the close resemblance in mass of the stars. There is a certain mass for which the radiation-pressure pressing outward nearly balances the force of gravitation pulling inward, and it is clear that for stars as large or larger than this a break-up sooner or later is to be expected. This assigns very obviously the upper limit to the masses—we can easily see why there are no stars larger than a certain limit. But how about the lower limit? Are there no stars very much smaller than this? Certainly there are. We are living on one of them. Our earth is smaller by some thousands of times; but then it is not a star in the full sense, for it is not shining with its own light. If it did ever so shine the light must have been feeble at best and have only lasted for a very short time. There may, in fact, be many small stars, but we do not see them, and accordingly have not reckoned them in saying that the masses of the stars are closely similar.³

I can not give you a better idea of the value of Prof. Eddington's work than by quoting a few words from a letter written to me by

³ On reading this again I realize that it does not do full justice to Eddington's suggestion for the lower limit. He shows a definite difficulty in the formation of small stars.

Mr. Russell, again specially in response to a request mentioning this lecture:

What appeals to me as the big thing is Eddington's work on radiative equilibrium (MN 77, p. 16 and p. 596). The importance of this can hardly be exaggerated; it is not too much to say that it is the first rational theory of stellar constitution.

Eddington has in fact given us a rough attempt at tracing the history of a star of given mass. By way of illustration let us consider our own sun. He is now a "dwarf star," on the descending leg of the ladder, of spectral type G, and with a surface temperature of about $5,000^{\circ}$ C., and an absolute magnitude 5.1. Looking back into the past he was at one time much hotter and of type F, and probably never rose much higher than this on the ladder. Before that his history lay on the ascending leg, and there was a time when his spectral type was just as at present, but his absolute magnitude was near zero, five magnitudes greater than at present. This means that the total light was 100 times greater than now, and since the surface was in a similar radiative state, it must have been 100 times more extensive. The diameter of the sun was therefore 10 times the present diameter—10,000,000 miles instead of 1,000,000. Where our little earth may have been at that time we can scarcely conjecture, but supposing for a moment that we had been able to regard the sun in our present conditions, he would have taken nearly an hour to rise instead of a few minutes; and when risen, his disk would be 10 times as great in all directions—a "giant" sun indeed! And yet this magnification of 10 to 1 is only modest compared with the extreme possibilities.

We set out by the recollection of Jack the Giant Killer, but our road has led us rather to think perhaps of Jack and the Beanstalk. We have climbed up to giant land, the land of the giant suns, not by a beanstalk, but by means of the trembling rays of light, a ladder which does not grow upward from our earth, but is let down to it by the giants themselves. "Fee fo fum!" said the giant, "I smell the blood of an Englishman." In our analogy the giants have been invaded, not by an Englishman, but chiefly by an American; but at any rate we have the satisfaction of reflecting that his work began in Cambridge when he was a student, and that at the end of it there has emanated from Cambridge this brilliant confirmation by Prof. Eddington of which the discoverer has himself expressed such generous appreciation.

A BUNDLE OF METEOROLOGICAL PARADOXES.¹

By W. J. HUMPHREYS.

The scientific paradox is only an exception to some familiar but too inclusive generalization. It, therefore, has both the appeal of the riddle and the charm of surprise—the surprise, the instant the truth is seen, of a sudden and unexpected discovery—and thus affords the same sort of intellectual delight that I once knew a student of geometry to experience. The proposition, one of Euclid's best, was the Pythagorean, often carelessly called the *pons asinorum*. The boy in question was of that sturdy type that always insists on being "shown," and not understanding this proposition, flatly refused to accept it. A little coaching at the blackboard, however, soon got him past his initial troubles and so fixed his attention that as the truth flashed upon him with the final "therefore," he blurted out, in the ecstatic surprise of an Archimedes, and with the same oblivion to his surroundings:

"Well, I'll be damned if it ain't so."

Whether the following paradoxes do or do not evoke such joyous acclamations as the one just quoted, they, nevertheless, deserve to be concisely stated and fully explained for they express important facts of nature, unknown to, or, at most, but vaguely realized by the average person.

AIR PUSHED NORTH BLOWS EAST.

This paradoxical behavior of the air is restricted, it should be said, to the Northern Hemisphere; but it seems just as contrarious on the other side of the Equator, for there, pushed north it blows west, pushed south it blows east.

The push that causes the winds to blow is due to the existence of unequal amounts of air above a given level over adjacent regions—more at the place from which the air is pushed than at the place toward which it is pushed—and this in turn, usually, is due to the temperature differences, level for level, between the atmosphere at

¹ Address of the retiring president of the Philosophical Society of Washington, delivered Jan. 31, 1920. Reprinted by permission from the Journal of the Washington Academy of Sciences, vol. 10, No. 6, Mar. 19, 1920.

the two places. Obviously there tends to be, and, initially, actually is, a horizontal flow of the air (that is, a wind) at each level, in the direction of the most rapid horizontal decrease of pressure at that level. Such winds, however, frequently last so long (hours at least) that their directions are profoundly altered by a certain obscure factor, namely, the rotation of the earth—the secret of the above paradox—which is overlooked by almost everyone, and overlooked simply because its effect on the shooting of a marble, the pitching of a ball, and all the thousand other similar phenomena with which we are intimately familiar, is always negligible.

It is easy to demonstrate, as may be found in many books and articles, that an object moving in any horizontal direction tends so strongly to turn to the right north of the Equator, and to the left

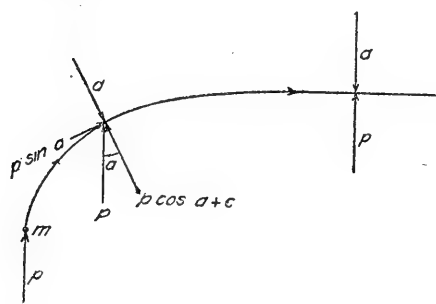

FIG. 1.—Diagram showing deflection of particle of air toward the east.

south of it, as to exert a force, against a restraint preventing such deflection, given by the equation,

$$f = 2 m \omega v \sin \varphi,$$

in which m is the mass of the object, v its speed, φ its latitude, and ω the angular velocity of the earth's rotation.

Consider, then, the effect of applying a horizontal push of constant magnitude and constant geographic direction to a mass of air, m , and assume this air to be free from friction, as it very nearly is when appreciably above the surface. Let m , figure 1, be this mass of air, initially at rest with reference to the surface of the earth; let it be in the Northern Hemisphere, and let p be the push of constant magnitude and constant direction, north. Immediately the mass moves it begins to deflect from the north toward the east, and, owing to the curvature of its path, introduces a small centrifugal force. A little later p may be resolved, as shown, into two components, one normal and the other tangential to the path of travel. The first, like the deflective force and the centrifugal force, has no effect on the speed, being at right angles to the direction of motion, while the second steadily increases the speed, which, in turn, increases the deflective force and the deviation toward the east. In the end, therefore, the component of p , along the path, reduces to zero, and the direction of travel becomes exactly east. Hence winds that are continuous for even a few hours always blow more or less closely along isobars; that is, at right angles to, and not in the direction of the sustaining force—around centers of pressure minima and maxima and not directly toward or from them.

south of it, as to exert a force, against a restraint preventing such deflection, given by the equation,

$$f = 2 m \omega v \sin \varphi,$$

in which m is the mass of the object, v its speed, φ its latitude, and ω the angular velocity of the earth's rotation.

Consider, then, the effect of applying a horizontal push of constant magnitude and constant

No matter, therefore, how paradoxical it may be, air pushed north does blow east (in the Northern Hemisphere), pushed east blows south, pushed south blows west, pushed west blows north; while in the Southern Hemisphere it blows exactly contrariwise.

RAIN DRIES THE AIR.

As everyone knows there is continuous and often rapid evaporation from practically all parts of the earth's surface. Nevertheless the atmosphere as a whole never becomes even approximately saturated. Water, as just stated, is always evaporating into the air and thus constantly tending to saturate it; but, on the other hand, the air is forever being dried by the precipitation out of it of rain, snow, and other forms of condensation. Whatever the temperature and relative humidity of a given mass of air at any place along its convectional route, the total of water vapor it then contains obviously is less, in general, than when it left the surface of the earth by the amount of precipitation in the meantime abandoned by it. That is, on the average, air descends to the earth drier than it was when it ascended, and drier solely because of, and in proportion to, the amount of precipitation that fell out of it during its convectional journey. In short, as the paradox puts it, rain does dry the air—does prevent it from becoming and remaining everywhere reekingly and intolerably humid, as it otherwise would be.

MORE AIR GOES UP THAN EVER COMES DOWN.

This is, perhaps, about as incredible a paradox as can be found, for it seems flatly to contravene the well-known dictum that whatever goes up must come down. And, indeed, to make the explanation of it entirely clear and definite, it will be necessary to consider it independently under two heads: *a*, when the air is measured in terms of volume, and, *b*, when it is measured in terms of mass.

Measured in terms of volume.—As everyone knows, the vertical circulation of the atmosphere is only a gravitational phenomenon consisting of the sinking of relatively cold, and, therefore, also relatively dense air, and its consequent lifting or forcing up of adjacent air that happens to be comparatively warm and light. In short, contracted air descends and expanded air ascends (is buoyed up by the descending denser air). Hence, mass for mass, the *volume* of the ascending air is always larger than that of the descending air. The ratio between the actual ascending and descending volumes, however, or masses, may be anything, as illustrated by chimney circulation, in which the ascent is restricted to a comparatively small volume and mass moving rapidly, while the descent extends to a relatively large volume and mass settling slowly. On the average, though, con-

sidering both velocity of vertical movement and volume occupied, or velocity times volume, the atmosphere as a whole is always ascending, a fact not only interesting itself, but also of some importance to both the aeronaut and the aviator.

Measured in terms of mass.—Whatever the volume relations between ascending and descending air may be, it would seem that at least the mass that goes up and the mass that eventually returns must certainly be the same. But, on the contrary, they indeed are far from it, for one of the important constituents of the atmosphere, water vapor, often amounting, in places, to 1 per cent, and occasionally to more than 2 per cent of the whole, invariably ascends as a gas, as a distinct part and parcel of the air; but descends, in great measure, not as a gas at all, not as any part whatever of the

air, but as a liquid in the form of rain, or a solid, such as snow and hail.

Paradoxical, therefore, as it may be, a greater mass of *air* actually does go up—more by at least 20,000,000 tons per second, the measure of worldwide precipitation—than ever comes down.

TO COOL AIR, HEAT IT.

The air referred to in this seemingly absurd statement is not that topsy-turvy kind Alice might have found in Wonderland, but just

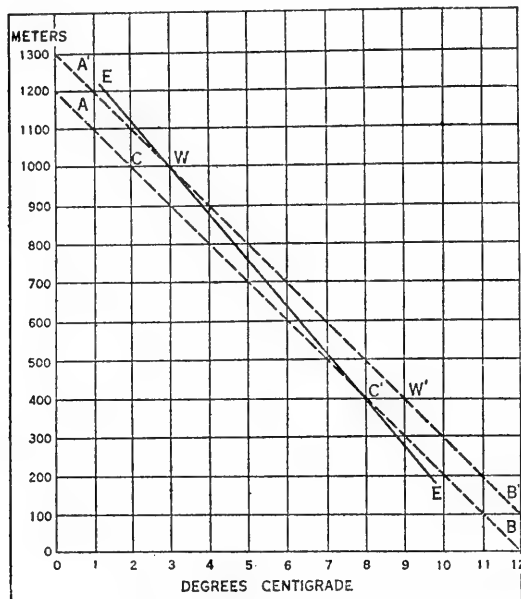

FIG. 2.—Vertical temperature gradients of free air.

that ordinary kind in which we have always lived; and the phenomenon itself, however contrary to experience it may seem, one of great importance and almost continuous occurrence.

This paradoxical result is easy to explain with a diagram. To this end let AB and A'B', figure 2, be two adiabatic gradients of the free air; that is, let each indicate a temperature change of 1° C. for every 100 meters change in elevation—the relation between the temperature and elevation of a rising or falling mass of air that during its travel neither gains heat from, nor loses it to, any outside object, such as the surrounding atmosphere. Let EE be any actual temperature gradient (nearly always less than the adiabatic), in this

case 1° C. per 120 meters change of elevation. If, then, under these conditions, a mass of air having the temperature and elevation indicated by C' , say, of the figure, be heated 1° C., or shifted in the figure to W' , it will correspondingly expand and consequently be forced up by the surrounding denser air—will ascend, as we say. As it rises, it will cool, by expansion, along the adiabatic gradient $A'B'$, and, therefore, will come into equilibrium with the surrounding atmosphere where this gradient intersects the actual gradient EE , or at the level and temperature indicated by W . Clearly, then, under the assumed conditions, such as are very common in nature, a mass of air heated 1° C. rises 600 meters, and in so doing cools 6° C., or to a temperature 5° C. lower than it had before it was heated. Of course, the warm air does not rise strictly adiabatically, though probably very nearly so; but in so far as it actually does *lose* heat it comes to equilibrium at a correspondingly *lower* level and *warmer* temperature.

It is precisely this paradoxical process of cooling by heating, the heating being mainly at the surface, however, that leads to the formation of cumulus clouds and generates the familiar "heat" thunderstorm. In fact, it is quite possible to produce a cumulus cloud, and even a local shower, through the action of a large surface fire. It should be noted in this connection that though combustion adds much water vapor to the air, five-ninths the weight of the fuel consumed even in the case of absolutely dry cellulose, nevertheless, the cumulus cloud over the fire is due essentially to the expansional or dynamical cooling of the ascending air.

TO WARM AIR, COOL IT.

This paradox is the converse of the one just discussed, and is readily explained in much the same way. Referring again to figure 2, let a mass of free air having the altitude and temperature indicated by W in the figure, be cooled 1° C., or its position shifted to C . It will at once become denser than it was, follow the adiabatic gradient AB as it falls to lower levels, and, therefore, come to rest at the level and temperature indicated by C' , or at the intersection of the adiabatic gradient followed and the existing gradient. That is, as a result of the initial cooling of 1° C., the given mass of air will fall 600 meters and become 5° C. warmer than it was before it was first cooled. In so far, however, as the falling air *gains* heat from the surrounding warmer atmosphere, it will come to rest at a correspondingly *greater* elevation and *lower* temperature.

This paradoxical phenomenon of warming by cooling is very frequently and very prettily illustrated by the evening disappearance of small detached clouds, such as alto-cumuli, fracto-stratus, etc. As

soon as the sun has set, these clouds and the air masses they fill cool more rapidly than does the clear atmosphere. They, therefore, fall to lower levels, warm up to higher temperatures than they originally had, and evaporate.

It will be interesting, in this connection, to note the logical effect of a certain ingenious, often proposed, and at least once experimentally tried, method of artificially inducing rainfall, namely, the liberal sprinkling of a cloud mass with liquid air. The result is, of course, an initial cooling of the cloud, followed, as above explained, by a much greater warming. Instead of rain being induced by this process, as its many inventors would confidently expect, the chilled cloud is certain to grow warmer and diminish in size, and, if considerably chilled may grow so much warmer as to disappear entirely. Indeed, this particular liquid air scheme is not a rain-making process at all, but, on the contrary, a rain deterrent.

NOT AIR THAT IS HEATED, BUT AIR THAT IS NOT HEATED, IS THEREBY
WARMED.

This particular paradox may suggest the superiority of "absent treatment"; nevertheless, it is perfectly sound. Heated air, as we know, is driven up by the surrounding denser air, and dynamically cooled, but the air that drives it does so by dropping to a lower level, where it is more or less compressed and correspondingly warmed. In other words, while the particular air that was heated rises and gets colder than it was initially, other air that was not heated at all falls lower and thus gets warmer. It is not the air that is heated but air that is not heated that gets warmer.

NOT AIR THAT IS CHILLED, BUT AIR THAT IS NOT CHILLED IS THEREBY
COOLED.

The explanation of this paradox is very similar to that of the one just given, and is equally simple. As the chilled air descends, certain other air is thereby raised and dynamically cooled. That is, while the particular air that was cooled descends and thus gets warmer than it was originally, other air that was not chilled at all is forced up, expands, and gets colder. It is not the air that is chilled (unless it happens to be on or near the surface where it can not fall to a lower level) but air that is not chilled that gets colder.

MIXING BRINGS THE AIR TO A NON-UNIFORM TEMPERATURE.

To the laboratorian familiar with beakers and calorimeters; to the housewife skilled in the art of the cups and kettles; and to all the rest of us, nothing is more certain—nothing more in accord with daily

experience—than that vigorous stirring establishes a uniform temperature throughout the agitated medium. And indeed this conclusion is quite correct in respect to the particular things we are likely to have in mind, but it does not apply to the open atmosphere. In fact, if the temperature of the atmosphere were uniform through any considerable altitude, a complete stirring of it would immediately destroy this uniformity.

Let, then, the atmosphere, whatever its initial temperature distribution, be thoroughly mixed without the addition or subtraction of heat. This will bring it into such state (that of neutral equilibrium) that any portion of it on being adiabatically moved to a different place will, on arriving at that place, have the same temperature as the then adjacent air at the same level. That is, it will have the same *potential* temperature throughout, or same actual temperature when subjected to the same pressure. The truth of the above statement is obvious from the fact that any temperature difference that might be developed by a transfer of the kind mentioned clearly could be reduced by further mixing.

But as a mass of this air is carried to higher levels it continuously expands against the diminishing pressure—diminished by the weight of the air passed through—thereby does work at the expense of its own heat energy and correspondingly cools to lower temperatures. The ratio of this cooling to increase of altitude evidently depends upon the nature of the gas and the change of pressure. In the case of our own atmosphere it is approximately 1° C. per 100 meters.

Although, therefore, stirring does bring an incompressible liquid to a uniform actual temperature, it brings the atmosphere only to a uniform potential temperature, or an actual temperature that is very non-uniform.

THE NEARER THE SUN THE COLDER THE AIR.

The familiar fact that with increase of elevation and consequent approach (during the daytime) to the sun, the air nevertheless gets rapidly colder, at least through the first 10 kilometers, is very puzzling to the average person if he tries to explain it. Nor, indeed, is the explanation of this phenomenon quite so simple and obvious as we sometimes are asked to believe. Essentially, however, this temperature distribution depends on the following facts:

1. The atmosphere, as we know from observation, is so diathermanous that half, roughly, of the effective radiation received from the sun—that is, half of the portion absorbed and not lost by reflection—goes directly to heating the surface of the earth. Consequently, it is this surface, where the energy absorption is concentrated, and not the atmosphere, through which absorption is diffused, that is most

strongly heated by insolation. The heated surface in turn warms the air above it, partly by contact, and partly by the long wave-length radiation it emits, and of which the atmosphere is far more absorptive than it is of the comparatively short wave-length solar radiation.

2. Furthermore, and this is an equally vital part of the explanation, the lower atmosphere (below about 10 kilometers), under all ordinary conditions emits more radiant energy than it absorbs—the difference being supplied by conduction. It is these two phenomena, (*a*) the surface heating (warming below), and (*b*) the net loss of heat by radiation (cooling above), that together establish and maintain the vertical convections of the atmosphere under which, since the descending portions grow warmer through compression, and the ascending colder through expansion, the whole of the convective region is made to decrease in temperature with increase of elevation.

But since the coefficient of absorption of the air, as of other objects, changes but little if at all with the temperature, while its emissive power decreases rapidly as it grows colder, and since the intensity of the incident terrestrial (including atmospheric) radiation remains roughly constant up to an altitude of many kilometers, beyond the first 4 or 5, it follows that the upper limit of the convective region is not, as formerly supposed, the outermost extent of the atmosphere, but at that elevation (10 to 12 kilometers above sea level) at which the temperature is so low (-55° C. roughly) that the loss of heat by radiation is no longer in excess of, but now equal to, its gain by absorption. Beyond this level temperature does not decrease, or does so but slightly, with increase of elevation; nor would it so decrease (at least at anything like the present rate) beyond any level above the thin conducting surface layer, at which absorption and radiation became equal.

In short, then, the air grows colder with elevation—the nearer the sun the colder the air—because (1) owing to its transparency to solar radiation it is heated mainly at the surface of the earth, and (2) because, at ordinary temperatures, it emits more radiation than it absorbs. These together so affect the density of the atmosphere as to induce vertical convections, and thereby to establish and maintain, throughout the region in which they are active, a rapid decrease of temperature with increase of elevation.

THE COLDEST AIR COVERS THE WARMEST EARTH.

This paradoxical statement refers to the air of the stratosphere, with respect to which it is a well-known truth whatever the explanation may be.

It has doubtless been known since the dawn of intelligence that the top of a mountain is colder than the adjacent valleys, and that

the highest among neighboring mountains has the coldest top. And for much more than a century, actually since November 30, 1784, it has been known, from observations by balloonists, that the temperature of the free air also decreases with elevation, at least up to such altitudes as were attained by manned balloons. About the close of the last century, however, it became evident, through records obtained with sounding balloons, that in middle latitudes the temperature of the atmosphere continuously decreases, on the average, with increase of altitude up to only 10 or 12 kilometers above sea level, and then becomes substantially constant. Numerous subsequent records obtained at many places have shown the additional surprising fact that this isothermal region, or stratosphere, as it is generally called, begins at a higher level, and is colder, over equatorial regions than over any other part of the world. Indeed, it seems to be 10° to 15° C. colder over the equator, where its average temperature is roughly -70° C., than, for instance, over the Polar Circles.

The temperature of the stratosphere appears to be determined chiefly by the intensity of the outgoing radiation from the earth and the intervening water vapor, and hence it seems to follow that this radiation must be less intense over regions near the Equator than over those of the middle and higher latitudes; a conclusion that merely shifts the burden of explanation from one paradox to another.

Obviously, the earth as a whole must emit, on the average, the same amount of radiant energy that it absorbs, but the spectral distributions of the two certainly differ. In equatorial regions the upward movement of the atmosphere is so general and so strong that high haze, cirrus, and other types of clouds are exceedingly common, and the atmosphere necessarily humid, and, therefore, highly absorptive of earth radiation, to great altitudes, especially as anticyclones with their extensive regions of descending air are there unknown. Clearly, then, a large part of the radiation through the stratosphere of this region must come from the clouds and from water vapor that are very high and correspondingly cold, and therefore its intensity, it would seem, must be correspondingly feeble. The pent up heat below can find an outlet through horizontal circulation and radiation from lower and warmer levels in higher latitudes.

This, perhaps, is at least the partial explanation of why the minimum temperature of the stratosphere occurs over the tropical regions—why the coldest air covers the warmest earth.

AS THE DAYS GROW LONGER THE COLD GROWS STRONGER.

This old proverb paradox expresses the well-known fact that our lowest temperatures do not occur at the time of the shortest days, or when the heat supply from the sun is least, but some time afterwards,

when the days have grown longer and the supply of solar heat has increased. That is, over a considerable period the air grows colder as the sun grows warmer. In the far interior of continents, especially if arid, this lag may not be more than a couple of weeks, but on many islands and along several coasts whose winds are prevailing on-shore, it is from one to two months.

To understand this phenomenon consider an object (representing the earth) suspended within a thermally opaque shell (assumed the source of incoming radiation) whose temperature is everywhere the same. For simplicity let the inclosed object be a "black body," that is, a full radiator and a perfect absorber. Let the absolute temperature of the shell be T and that of the inclosed object $T \pm t$. Under these conditions the rate of heat absorption by the suspended body is AKT^4 , where A is its "equivalent" area and K the "black body" coefficient, while the rate of its emission is $AK(T \pm t)^4$. If, now, t is small in comparison with T , the rate of net gain or loss of heat by the inclosed object is $4AKT^3t$, approximately, and the ratio of its rate of temperature increase or decrease to the temperature difference, t , a constant inversely proportional to its heat capacity, assuming high conductivity. The limiting temperature T would, therefore, never be fully attained, but forever approached asymptotically. Clearly, then, if the temperature of the shell were T and that of the inclosed object $T + t$, the latter would continue to grow colder through any finite time unless, and until some time after, the temperature of the shell were raised above the then temperature of the inclosed object.

The reasoning in this special case applies also to the normal daily temperature of the atmosphere (substantially that of the surface of the earth), provided, as will be assumed for the moment, that there is neither circulation nor any thermal effects due to water transformations—freezing, thawing, etc. It applies because the normal daily loss of heat through radiation to space by any given region is as though it were a full radiator at a certain temperature, and its normal daily gain of heat from the outside as though it were completely canopied by another full radiator also at a certain (generally different) temperature.

During the autumn, therefore, while there is still stored in the earth much of its summer gain of heat, and while the daily supply of energy from the sun is growing less and less per unit area, the average 24-hour temperature of the surface, and of the surface air, must be appreciably higher than that of equilibrium with the simultaneous incoming radiation—higher because of the additional supply of heat by conduction from its reservoir beneath the surface—and as the summer storage of heat in the earth is very large and also near the surface (but little penetrating beyond a depth of 5 or 6 meters)

it is obvious, from the preliminary explanation above, that the minimum temperature can not occur until some time after winter solstice, or when the days have again grown longer, and that the delay must depend on latitude, nature of surface, and a number of other factors.

The date of this minimum temperature is still further delayed, in many places, by the trend of warm ocean currents and the warmer surface drifts toward the higher latitudes, and by on-shore winds. It is also affected, though probably but slightly, by the thermal effects of freezing, thawing, evaporation, and condensation.

The storage of heat in the earth while the days are long, its gradual delivery back to the surface while the daily supply from the sun is comparatively small, and the poleward drift of warm water at all seasons, together produce, as explained, the paradoxical result so admirably expressed by the proverb:

As the days grow longer
The cold grows stronger.

AS THE NIGHTS GROW LONGER THE HEAT GROWS STRONGER.

It will be recognized at once that this paradox is only the counterpart of the one just discussed, and that it must also have substantially the same explanation.

As the days continue to grow longer after the time of minimum temperature, it is clear that from then on for several months the earth's gain of heat must be at a faster rate than its loss—that, in terms of the above explanatory hypothesis, the effective temperature of the shell is T and that of the inclosed object $T - t$. Under these conditions the earth, because of its large but finite heat capacity, must continue to slowly grow warmer until the incoming radiation has become less; that is, until the nights have grown perceptibly longer.

This lag, the lag of maximum temperature after the summer solstice, is also, like the lag of minimum temperature after the winter solstice, a function of location; generally least in the interior of continents and greatest on islands and near coasts whose prevailing winds are on-shore.

AS THE SUN DESCENDS THE TEMPERATURE ASCENDS.

By this paradoxical expression it is only meant to state tersely the well-known fact that the warmest time of the day is not when the sun is on the meridian, or when insolation is greatest, but sometime in the afternoon when the sun has descended considerably from its maximum elevation. As everyone knows, night cooling reaches its great-

est effect, on the average, just after daybreak. Hence, as the sun ascends the temperatures of the warming surface of the earth and of the lower air lag behind equilibrium with the incoming radiation, and continue to do so until the intensity of the insolation has passed well beyond its maximum. That is, the temperature continues to rise for some time, generally two to four hours, after the sun has crossed the meridian—as the sun begins to descend from its highest point the temperature continues to ascend.

THE ABSOLUTE MAXIMUM DIURNAL INSOLATION (HEAT SUPPLY) IS AT
THE SOUTH POLE.

If I is the solar constant, or quantity of solar energy per minute per unit area, normal to the insolation at the limit of the atmosphere, then the total amount Q of solar energy per any consecutive 24 hours per unit area of a horizontal surface, also at the limit of the atmosphere, is given by the equation

$$Q = \frac{1440}{\pi} I (\sin \phi \sin \delta H + \cos \phi \cos \delta \sin H)$$

in which ϕ is the latitude of the place in question, δ the declination of the sun at the time, and H the hour angle, in radians, between noon and sunrise or sunset.

A great deal of interesting information is contained in this equation. The most interesting, perhaps, is the fact that if the value of Q for the Equator at the time of the vernal equinox be represented by 1,000, then that of the North Pole at summer solstice is 1,202, and that of the South Pole at the corresponding solstice 1,284; each being greater than the value of Q at that time for any other place in either Hemisphere. The advantage in favor of the South Pole is owing to the fact that the earth is then near perihelion and therefore closer to the sun.

Not only does the absolute maximum diurnal insolation at the limit of the atmosphere occur at the South Pole, but, owing to the great elevation of the South Polar region, the dryness of its atmosphere, and its comparative freedom from dust, so also does the corresponding maximum at the surface of the earth.

The days, however, of abundant insolation at the Poles are comparatively few, nor is this insolation very effective in raising the temperature, owing to the high reflecting power and great heat of fusion of the always-prevalent ice and snow. And so it happens that although for a time every year each Pole receives more diurnal insolation than does any other place on the earth, it is always cold; and the South Pole, though having the greater maximum diurnal insolation, is the colder of the two, owing to its elevation and greater distance from open water.

THE HOTTER THE SUN, THE COLDER THE EARTH.

It is not yet universally conceded that this paradox, "the hotter the sun, the colder the earth," really is true, but the evidence in favor of it is already very strong. It is known, for instance, that several extensive studies of the temperature records of the earth have all shown that on the average it is a little colder during the years of sun-spot maxima than during the years of sun-spot minima. Furthermore, numerous careful measurements of the solar radiation made during the past dozen years or more seem to compel the assumption, at least tentatively, that the effective temperature of the sun is greater during spot maxima than during spot minima. If, then, both these conclusions are true—if the temperature of the earth is lowest during spot maxima and the solar constant highest—it follows that the above paradox is also true.

But by what possible process can the earth get colder when the sun grows warmer? It has been suggested that the increase of the solar constant causes a corresponding increase in the atmospheric circulation, and therefore a decrease in the surface temperature, owing to the greater flow of cold air from the higher toward the lower latitudes. But the very great mixing of the convective portion of the atmosphere, and the consequent prevention of the formation of over- and under-flowing strata, seem to render this suggested explanation untenable.

The key to this paradox may perhaps be found in the greater extent and density of the solar corona at the times of spot maxima than at the times of spot minima. The corona—since in large measure it is only so much dust about the sun—obviously must interfere with the passage of radiation through it, and to a far greater extent with the ultra-violet radiation than with the visible and infra-red. Hence, during spot maxima, or when the solar atmosphere is dustiest, the solar energy must, it would seem, be poorest in ultra-violet radiation.

Now when cold dry oxygen, such as exists in the upper atmosphere, is acted upon by certain regions, at least, of the ultra-violet spectrum, some of it is converted into ozone, a substance known to be in the upper atmosphere to a far greater extent than in the lower. Hence when sun spots are most numerous the upper air should contain a minimum amount of ozone. But ozone is intensely absorptive of earth radiation and that, too, in the spectral region of its greatest intensity, and where water vapor is least absorptive and carbon dioxide not at all. That is, at the time of spot maxima when the solar constant is (apparently) greatest, the earth's blanket of ozone is (presumably) least. Even, therefore, if the earth should be receiving an increased amount of heat at this time it might, nevertheless, grow slightly colder because of the coincident depletion of the heat-conserving blanket of ozone.

A greater general prevalence of cirrus and cirrus haze during spot maxima than during spot minima (indicated by certain observations) would also account for this paradox; because such clouds, owing to the size of their particles, shut out the short wave-length solar radiation more effectively than they shut in the long wave-length earth radiation. And perhaps these clouds really are generally most prevalent during spot maxima, and, therefore, at least a contributing factor to the cause of the corresponding temperature minima. At any rate the auroras are then most frequent, and they obviously generate nitrous oxide and other hygroscopic compounds which, because of their density, slowly fall to the cirrus level where they may produce cloud particles in an atmosphere whose humidity is much below that which otherwise would be essential to cloud formation.

The maximum, then, of the cirrus screen and the minimum of the ozone blanket, coincident with the highest temperature of the sun, may very well account for the above paradox—the hotter the sun the colder the earth.

THE COOLER THE SUN THE WARMER THE EARTH.

This paradox is practically included in the one just discussed. It means that at times of sun-spot minima, when the solar constant seems to be least, the average temperature of the earth is highest.

At the times of spot minima the solar atmosphere is clearest; the extreme ultra-violet radiation presumably, therefore, at a maximum; the upper atmosphere richest in ozone, and the earth most conservative of its heat, and, because of the minimum (if that be the case) of cirrus, also most receptive of solar radiation—so receptive and so conservative, perhaps, as to gain slightly in temperature despite the decrease in the heat supply.

THE SUN RISES BEFORE IT IS UP.

This paradox about the sun rising before it is up is equally true of the moon and the stars, and is also one of the best known and easiest explained of all meteorological paradoxes.

Everyone is familiar with the fact that as light passes slantingly from one medium to another, as from air to glass, for instance, it does not continue on in the same straight line, but abruptly changes direction at the interface according to well-known laws. And the same thing is true of the rays of light that pass from space into and through the atmosphere of the earth, except that, in this case, as the density of the atmosphere gradually increases from zero at its outer boundary to a maximum at the surface of the earth, so too the change in direction of the entering light is equally gradual. The total

change of direction by the time the surface of the earth is reached depends upon the wave length, or color, of the light; the slope at which it enters, or zenith distance of the luminous object; the temperature and barometric pressure at the place of observation; the humidity; and several other minor factors. On the average, however, light from a star for instance, that appears to be 90° from the zenith, and, therefore, on the horizon—just rising, say—has been bent out of its original course by about $34.5'$. That is, it comes into view (rises) while actually more than half a degree below the horizon. And as the angular diameter of the sun and the moon are each less than this horizon refraction, it follows that when the sky is sufficiently clear the whole of either luminary may be seen before even its topmost portion is up; that is, before it is geometrically above the horizon, or actually within 90° or less of the zenith.

THE SUN SETS AFTER IT IS DOWN.

Since the virtual wave length of a given radiation of celestial origin and, therefore, the value of its astronomical refraction is modified by the rotation of the earth, as are also certain scintillation phenomena, it follows that the above paradox is not identical with the one just explained. Nevertheless, as the spectra of the stars and other celestial objects all overreach the visible portion at each end it follows that the Doppler effect produces no appreciable alteration in the ensemble of the light from any one—merely a minute shift of its entire spectrum that can be detected only in the positions of definite lines.

. But even this displacement of the spectral lines, due to the rotation of the earth, is far too small, roughly one three-hundredth the distance between the sodium D's, to affect detectably astronomical refraction. Hence as the sun, the moon, and the stars all rise before they are up, so too they must all set only after they have gone down.



THE DETERMINATION OF THE STRUCTURE OF CRYSTALS.¹

By RALPH W. G. WYCKOFF, PH. D.,
Geophysical Laboratory, Carnegie Institution of Washington.

[With 7 plates.]

OUTLINE.

INTRODUCTION.

AN OUTLINE OF THE DEVELOPMENT OF THE MEANS EMPLOYED IN STUDYING THE STRUCTURES OF CRYSTALS:

- The experiment of Laue.
- The "reflection" of X rays.
- Powder reflections.
- The structure of sodium chloride.
- The wave lengths of X rays.
- The general method of studying the structures of crystals.

A BRIEF DISCUSSION OF THE METHODS OF OBTAINING DIFFRACTION EFFECTS FROM CRYSTALS:

- The spectrometer method.
- Spectrometer data.
- The "laws" of reflection.
- The method of powders.
- The method of Laue photographs.
- Résumé.

A DISCUSSION OF SOME OF THE STRUCTURES THUS FAR STUDIED AND SOME OF THE INFORMATION WHICH THEY SEEM TO YIELD CONCERNING THE NATURE OF CRYSTALLINE SOLIDS:

- Metals.
- Compounds of the type AB.
- Other simple compounds.
- Information to be derived from the structure of the atom.

INTRODUCTION.

The following discussion aims to give a brief survey of the field of the determination of the structures of crystals as it exists at the present time. The most essential events in the development of this

¹ Reprinted by permission from the Journal of the Franklin Institute, February, 1921.

work are mentioned, the existing means of experimentation are outlined, and some of its present limitations are discussed, together with some of the kinds of problems to which a knowledge of the arrangement of the atoms in crystals has contributed and may be expected to contribute.

AN OUTLINE OF THE DEVELOPMENT OF THE MEANS EMPLOYED IN STUDYING
THE STRUCTURES OF CRYSTALS.

The experiment of Laue.—For some time it has been evident that the distance apart of the atoms in a solid body is of the order of 10^{-8} centimeters.² In the days before the nature of X rays was known, attempts were made to see if they could be diffracted by passage through very narrow slits; the results of these experiments showed

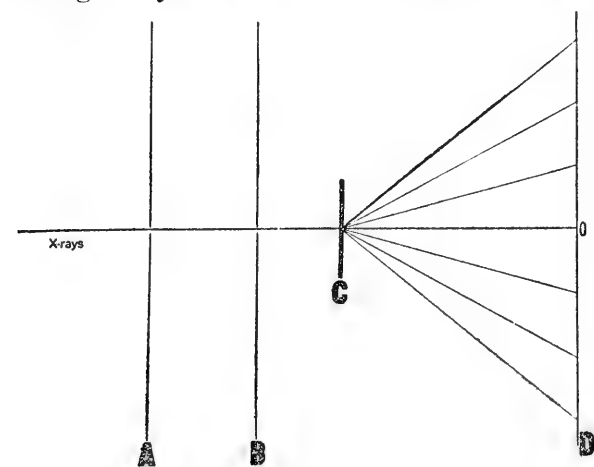

FIG. 1.

that if X rays really were wave motions of a nature similar to ordinary light, their wave lengths could not by much exceed 10^{-9} centimeters.³

Starting from this information Laue concluded that if X rays are wave motions of this type they should be dif-

fracted on passing through an orderly arrangement of atoms such as is furnished by a crystal; and, as a matter of fact, when a narrow pencil of X rays was passed through a thin section of a crystal, a number of diffracted images of the pinhole defining the beam were obtained, arranged in a symmetrical fashion about an undiffracted image.⁴ The arrangement required for carrying out this experiment is shown in figure 1. A beam of X rays after passing through two pinholes in the lead screens *A* and *B* proceeds through the thin section of a crystal at *C* and registers itself as the undeviated and diffracted images upon a photographic plate placed at *D*. The kind of diffraction patterns

² An indication of the dimensions of the "spheres of influence" of atoms has been obtained in many ways, as from the thickness of soap-bubble films, from calculations based on the kinetic theory of gases, and more especially from the work of Perrin on the Brownian movement and from counts of α particles.

³ B. Walter u. R. Pohl, *Ann. d. Phys.*, 25, 715, 1908; 29, 331, 1908. R. Sommerfeld, *ibid.*, 38, 473, 1912. P. P. Koch, *ibid.*, 38, 507, 1912.

⁴ M. Laue, W. Friedrich, u. P. Knipping, *Ann. d. Phys.*, 41, 971, 1913.

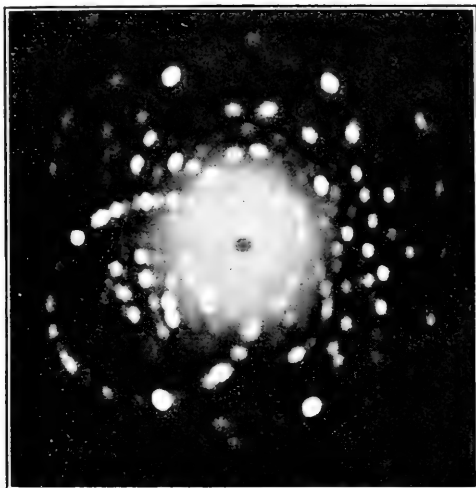

FIG. 2.—Cyanite. Triclinic. X rays normal to the (100) face.

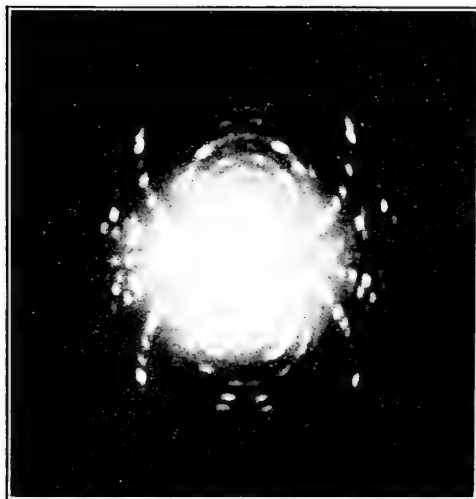

FIG. 3.—Scolecite. Monoclinic. X rays normal to the (100) face.

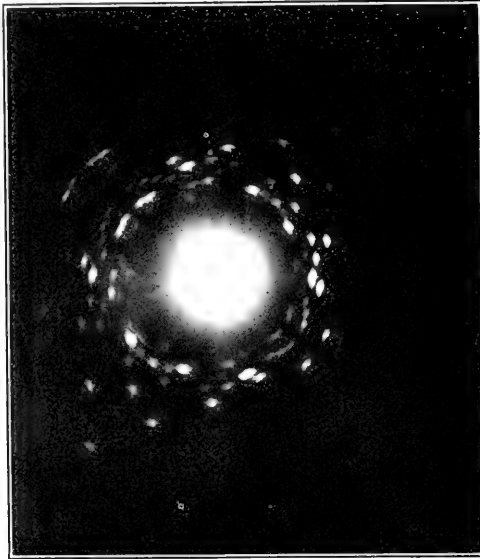

FIG. 4.—Potassium sulphate. Orthorhombic. X rays normal to the (001) face.

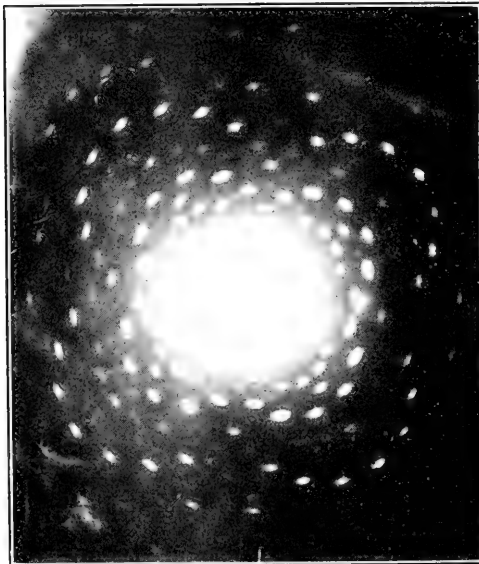

FIG. 5.—Rutile. Tetragonal. X rays normal to the (001) face.

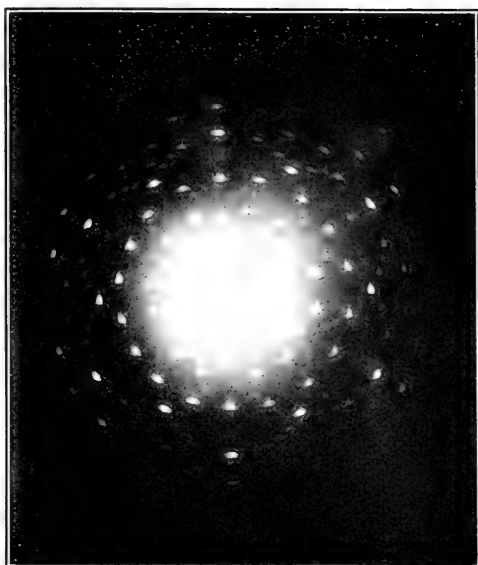

FIG. 6.—Carborundum twinned to give an hexagonal pattern. X rays normal to the (0001) face.

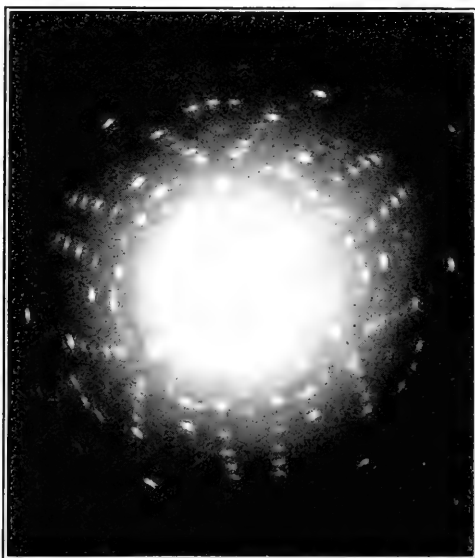

FIG. 7.—Calcite. Rhombohedral. X rays normal to the base (111).

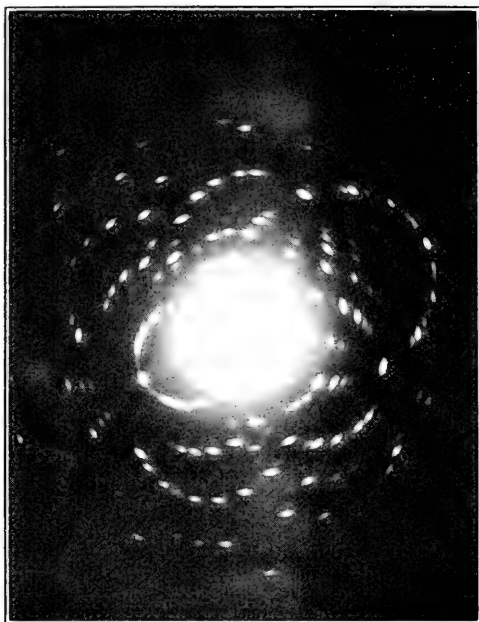

FIG. 8.—Calcite. Rhombohedral. X rays normal to the cleavage (100) face.

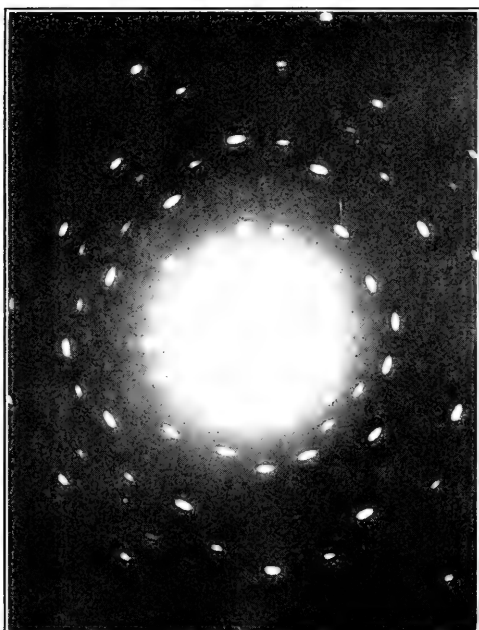

FIG. 9.—Magnesium oxide. Cubic. X rays normal to the cube (100) face.

that are thus obtained is shown in figures 2 to 9.⁵ Their symmetry is seen to be directly related to the symmetry of the diffracting crystal; for instance, the cubic crystal of magnesium oxide gives a four-fold pattern (fig. 9) when the X rays pass along a tetragonal axis, a trigonal crystal such as calcite furnishes a pattern (fig. 7) that shows

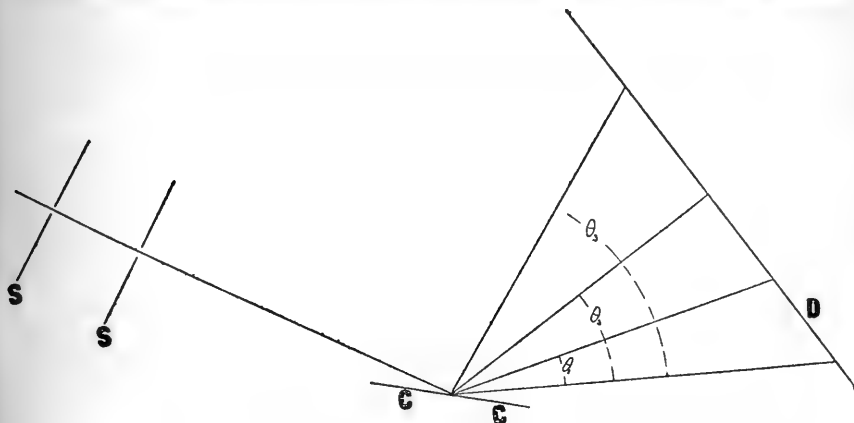

FIG. 10.

a threefold symmetry when the X rays are traveling parallel to the principal axis.

The "Reflection" of X rays.—In Laue's experiment the crystal may be thought of as behaving toward X rays as if it were a three-dimensional diffraction grating. The mathematical treatment of such a grating⁶

presents very considerable difficulties. Fortunately, however, W. L. Bragg has pointed out that these diffractions of X rays by the atoms of crystals can just as satisfactorily, and vastly

more simply, be treated as reflections from planes of atoms within the crystal.⁷

This point of view suggests that X rays ought to be "reflected" from the faces of crystals. If a parallel beam of X rays of a single

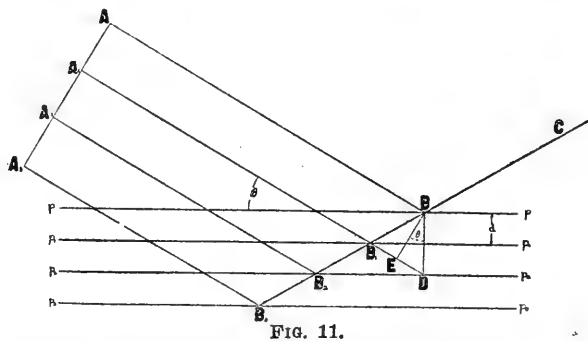

FIG. 11.

⁵ Figs. 2 and 3 are obtained from photographs by F. Rinne, Ber. Verh. K. Sächs. Ges. Wiss., 67, 303, 1913. The others have been prepared by the writer.

⁶ M. Laue, W. Friedrich, u. P. Knipping, op. cit.

⁷ W. L. Bragg, Proc. Camb. Phil. Soc., 27, 43, 1913.

wave length strikes the face of a crystal mounted at C (fig. 10), it is found that X rays are reflected at certain definite angles.⁸ The mechanism of this "reflection" has an optical analogue; if a beam of light falls upon a stack of thin plates of transparent material such as glass, this light is found to be reflected strongly only at definite angles, the values of which will depend partly upon the wave length of the incident light and the distance apart of the reflecting surfaces. These plates of glass may be taken as corresponding to the planes of atoms in the crystal.

The factors governing the reflection of X rays can be shown with the aid of figure 11.⁹ The reflecting planes of atoms parallel to a crystal face are represented by $p, p_1 \dots p_n$; the beam of X rays $A, A_1, \dots A_n$ strikes the face of the crystal at the angle θ ; the distance between the planes of atoms is d . The following conditions will govern the reflection of the X rays along the direction BC . Draw BE perpendicular to A_1B_1 and BD perpendicular to the planes $p, p_1, \dots p_n$. The difference in path between the ray ABC and A_1B_1C is

$$BB_1 - B_1E.$$

When this difference is exactly equal to a whole number of wave lengths of the X rays, the beam which is reflected from the plane p_1 will arrive at C exactly in phase with that reflected by the plane p ; otherwise it will suffer practically complete neutralization by reason of the various sorts of phase relationships which exist between the reflections from the different planes of atoms. Consequently, in order that there may be a reflection of the X rays along the direction BC , it is necessary that

$$BB_1 - B_1E = n\lambda,$$

where λ equals the wave length of the X rays and n (called the "order" of reflection) gives the number of whole wave-lengths difference in path of the reflected X rays. In the triangle BB_1D the side $BB_1 =$ the side B_1D so that $BB_1 - B_1E = ED$. Therefore,

$$ED = n\lambda.$$

Now the angle $DBE =$ the angle $ABp = \theta$; and $BD = 2d$. From this

$$ED = 2d \sin \theta = n\lambda. \quad (1)$$

This is the fundamental equation underlying all reflections of X rays.

⁸ See W. H. and W. L. Bragg, X rays and Crystal Structure, London, 1918.

⁹ W. H. and W. L. Bragg, op. cit., chap. ii.

Powder reflections.—It has just been seen that diffraction, or “reflection,” effects with X rays result either from passing them through a thin section of a crystal (the Laue experiment) or by “reflecting” them from the face of a crystal. In both of these cases a single crystal of considerable size and perfection is required. There is one other way in which definite diffraction can be obtained: by “reflecting” the X rays from a haphazard arrangement of crystals such as is furnished by a fine powder.¹⁰ In such a completely chaotic grouping of crystalline particles some of them will be in a position to reflect X rays from each important crystal plane. Thus interference effects from all of the possible planes in the crystal will be produced at the same time. This third method of obtaining diffraction effects makes available for study the large group of substances which can not be obtained as crystals of appreciable size.

The structure of sodium chloride.—The reflection of X rays by crystals gives a means of obtaining information about the arrangement of the atoms in the crystal. If the structure of a crystal is known, then the wave length of X rays can be determined. From equation (1) it is seen that if X rays of the same wave length are employed, the relative distance apart of like planes of atoms in different directions can be derived from a measurement of the angles of reflection. From such measurements it appears that the spacings of like planes normal to the cube; dodecahedral and octahedral, (100), (110), and (111), planes of sodium chloride stand in the ratio of

$$1 : \frac{1}{\sqrt{2}} : \frac{2}{\sqrt{3}}$$

W. H. and W. L. Bragg pointed out¹¹ that these observations can be accounted for if the atoms of sodium chloride have the positions shown in figure 22. (See p. 217.)

The wave lengths of X rays.—A knowledge of the arrangement of the atoms in any crystal makes possible a determination of the absolute length of X rays. The necessary procedure is somewhat as follows: A crystal may be imagined as made up of a vast number of units of structure, all alike in size and shape and similarly oriented; for instance a cubic crystal will be divisible into cubes, a hexagonal crystal into either hexagonal prisms or rhombohedrons, and so on. Figure 22 shows such a unit for the structure assumed for sodium chloride. That four chemical molecules are associated with this cube will be clear from the following considerations. The eight sodium atoms at the corners of the unit are each shared by eight cubes; all of them thus place within the unit the equivalent of the mass of a single

¹⁰ P. Debye u. P. Scherrer, Phys. Z., 17, 277, 1916. A. W. Hull, Phys. Rev., 10, 661, 1917.

¹¹ W. H. and W. L. Bragg, op. cit., chap. vii.

sodium atom. The atoms N and P are each shared by two cubes; both together then supply another sodium atom within our cube. The two remaining sodium atoms are furnished by L and M and by Q and R . In a similar fashion it can be shown that four chlorine atoms are associated with this unit.

The volume of the cube can be written:

$$V = \frac{mM}{\rho}$$

where

V = the volume,

m , the number of molecules of sodium chloride within the unit, = 4,

ρ , the density of sodium chloride, = 2.17.

M , the mass of a single molecule of sodium chloride, equals the molecular weight multiplied by the weight of an atom whose atomic weight is unity, roughly equal to the weight of a single atom of hydrogen, = $58.5 \times 1.64 \times 10^{-24}$ grams.

From these, d , the length of a side of the cube, $\sqrt[3]{V} = 5.60 \times 10^{-8}$ centimeters. If the reflection is taken from the face $CDHG$, then the distance d between like cube planes is the distance between the plane $CDHG$ and the plane $BAEF$. The reflection from planes of such a spacing would be of the first order. But it will be seen that the plane $QLRM$ has exactly the same composition as these other two planes and is spaced midway between them. The waves reflected from it will then be exactly out of phase with those from the other planes and, having the same amplitude, will blot them out completely. The first reflection to be found from the cube face of this arrangement of atoms is thus of the second order. If X rays from a tube having a palladium target are used, the angle of this reflection is found to be 5.9° . In equation (1) we now have—

$$\begin{aligned} n &= 2, \\ d &= 5.60 \times 10^{-8} \text{ cm.}, \\ \theta &= 5.90^\circ. \end{aligned}$$

Consequently λ is equal to 0.576×10^{-8} centimeters.¹²

The obvious objection to this determination lies in the fact that though this particular structure for sodium chloride agrees with the experimental data just mentioned, there may be, for aught it tells, a myriad of other structures which are in equally good agreement. The large amount of data, however, agreeing with this structure and the value of the wave length of X rays derived from it that has since been obtained from different sources make their truth seem highly probable.

Using this same method of procedure, W. H. and W. L. Bragg and others have found structures which will account for the positions of

¹² W. H. and W. L. Bragg, op. cit., chap. vii.

the reflections from the most important faces of a number of crystals, such as sodium and potassium chlorides, iron pyrites, the diamond, carborundum, and various members of the calcite group of minerals.¹³ Probably in no case can the structures which are *thus* obtained be said with absolute surety to correspond with the arrangements of the atoms within these crystals.

The general method of studying the structure of crystals.—It consequently becomes necessary, if we are to make any definite and certain progress toward unraveling the structures of crystalline compounds, that a method be developed which will make it possible to determine *uniquely* such structures, or at least that will indicate the degree of probability with which a particular structure has been determined. Fortunately the basis for such a method was already prepared, for the geometrical theory of space groups developed many years ago by Federov, Schönflies, and Barlow can be made to give *all* of the possible ways of arranging points in space so that the grouping which results will exhibit crystallographic symmetry.¹⁴ Since a crystal is an orderly arrangement of atoms in space, it must correspond with one of these space groups. Consequently, when the space groups are given a suitable analytical representation, a means quite independent of any X-ray experiments is provided for writing down *all* of the possible positions which the atoms of *any* compound can occupy. After this has been done the particular data which will serve to distinguish between these various possible arrangements can be selected and those methods of experimentation employed which will yield most readily the needed facts. Such a method has the advantage of being equally applicable to complicated and to very simple structures. The point of view involving such a use of the theory of space groups was used first by Nishikawa in studying spinel.¹⁵ The geometry of the method arising from it, which has been in the course of development for several years,¹⁶ may now be said to be nearly completely developed.

THE METHODS OF OBTAINING DIFFRACTION EFFECTS FROM CRYSTALS.

The spectrometer method.—Three ways of obtaining definite X-ray diffractions have been mentioned: (1) By reflecting X rays from

¹³ W. H. and W. L. Bragg, op. cit., chaps. vii and viii. C. L. Burdick and E. A. Owen, J. Am. Chem. Soc., 40, 1749, 1918; C. L. Burdick and J. H. Ellis, *ibid.*, 39, 2518, 1917; R. G. Dickinson, *ibid.*, 42, 85 (1920), and others.

¹⁴ E. Federov, Z. Kryst., 24, 209, 1895. A Schönflies, "Krystallsysteme u. Krystallstruktur" (1891). W. Barlow, Z. Kryst., 23, 1, 1894.

¹⁵ S. Nishikawa, Proc. Tokyo Math. Phys. Soc., 8, 199, 1915.

¹⁶ This development has been going on independently in Germany and in this country. For instance, see P. Niggli; Geometrische Krystallographie des Discontinuums (1919); Ralph W. G. Wyckoff, J. Am. Chem. Soc., 42, 1100, 1920; Am. J. Sci., 50, 317, 1920; *ibid.*, 1, 127, 1921.

individual faces of a crystal; (2) by reflecting them from a crystalline powder so that all of the possible crystal planes have an equal chance to reflect; (3) by passing X rays through a thin section of a crystal. We shall now discuss very briefly the way in which these three kinds of experiments are carried out and point out the kinds of data that can be obtained from each.

The first of these diffraction methods may be called the spectrometer method. X rays, preferably of a single wave length, are passed through two narrow slits of an X-ray spectrometer in order to render them parallel; this beam, after reflection from the face of a crystal mounted upon the spectrometer table, passes into an ionization chamber, where its intensity is measured by the magnitude of the ionization which it produces in the gas of this chamber. Such an X-ray spectrometer is shown in figure 12. The X rays passing from an X-ray tube through the slits S and S_1 , strike the face of the crystal mounted at C . When the ionization chamber D and the crystal C stand at the proper angles, the reflected beam of X rays enters the chamber D through a mica window by way of the slit S_2 . This chamber is filled with some gas, usually sulphur dioxide or, better, methyl bromide, which ionizes strongly under the action of X rays.

The case of the ionization chamber is charged to a potential of about 200 volts, while the inside insulated electrode, which is connected only with the gold leaf of a sensitive electroscope E , is, at the moment of beginning the experiment, at the potential of the ground. As X rays enter the chamber and ionize the gas within it, the potential of the gold leaf will change. The rate of this change is measured by the drift of the gold leaf and taken as an indication of the intensity of the reflected X rays. By properly adjusting the positions of the crystal and of the ionization chamber the relative intensities of reflection from a single face can be obtained for the various orders. This information is usually sought for several faces of a crystal.

In place of an ionization chamber and electroscope for measuring the diffracted X rays a photographic plate can be used. If the X rays are of a single wave length an image of the slit will appear at the position conditioned by equation (1). If the X rays in the original beam are of more than one wave length, as is usually the case, then for a perfectly constructed crystal—meaning thereby one in which the atoms are arranged with perfect regularity throughout the entire mass—and for perfectly parallel X rays, only the image corresponding to one wave-length will appear upon the photographic plate for a particular orientation of the crystal. If the beam of X rays is slightly divergent after passing through the slit of the spectrometer, it can be shown from geometrical considerations that the X rays of somewhat different wave lengths which can thus be reflected will focus upon a surface which is as far from the crystal as the crystal is

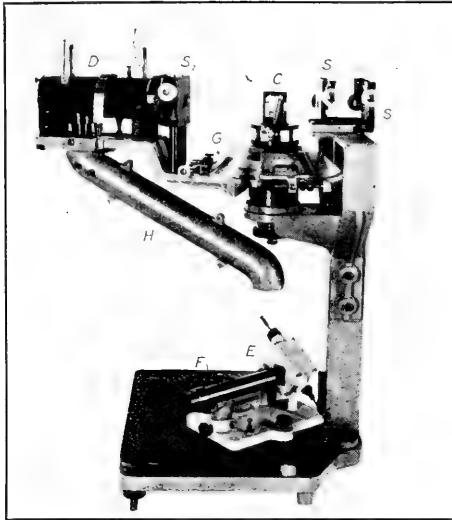

FIG. 12.—An X-ray spectrometer. *G* is a divided circle upon which the positions of the crystal and ionization chamber may be read; *F* is a microscope and scale for following the gold leaf of the electroscope (*E*); *H* is an earthed shield for the wire connecting the chamber and the electroscope.

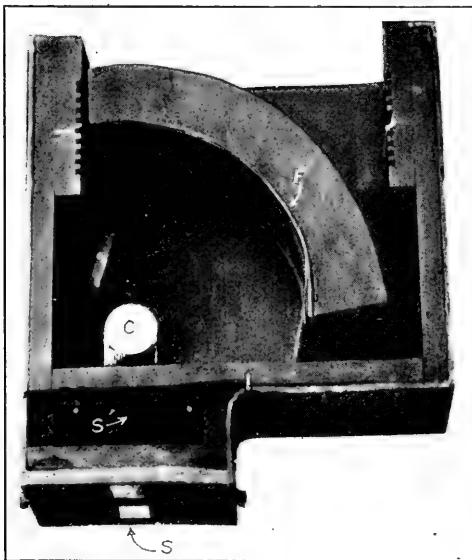

FIG. 13.—The front slit (*s*) is variable. The second one (*s'*) is fixed at a considerable width so that the beam of X rays striking the crystal mounted on the rotating table (*C*) is somewhat divergent. The photographic film is curved to the arc of a circle along *F*.



distant from the slit. This fact is of utmost importance in designing an X-ray spectrograph. If a photographic film is curved to the arc of a circle of a radius equal to the distance from the crystal to the slit, and whose center is at the crystal face, then a focused image of a small range of wave lengths will appear upon the film. Furthermore, if the crystal is but rotated continuously back and forth, all of the different wave lengths in the original beam will be reflected at some angle of the rotating crystal. A photographic image of the entire X-ray spectrum can thus be obtained. Figure 13 shows a spectrograph designed for obtaining such reflections. Figure 15 (pl. 6) gives the X-ray spectrum of tungsten obtained in the manner just outlined.

Spectrometer data.—The principal use of the photographic X-ray spectrometer (spectrograph) in studying the structure of crystals lies in determining the absolute distances apart of like planes in some one direction in the crystal. This information, furnishing a knowledge of the number of molecules to be associated with the unit of structure, is the first piece of experimental data that is required in studying the structure of a crystal. It can be obtained much more readily by photographic means than by searching about looking for a reflection, as must be done if the spectrometer itself is employed to give the same information.

The following is an outline of the nature of the data which the spectrometer and the spectrograph can be expected to yield. It has just been stated that the number of chemical molecules associated with the unit of structure can be deduced from a knowledge of the position of the reflection from a single face of a crystal. The procedure required to give this information is quite the same as that already used in getting the wave lengths of X rays. Equation (1),

$n\lambda = 2d \sin \theta$ can be written: $d = \frac{n\lambda}{2 \sin \theta}$. It has been indicated that

$$V = \frac{mM}{\rho} \quad (2)$$

$$V = c(d_{100})^3 \quad (3)$$

where d_{100} is the spacing in the direction of the side of the unit prism and c is a constant whose value is determined by the symmetry of the crystal (and is obviously equal to unity in the case of a cubic crystal).

By combining (2) and (3): $m = \frac{c(d_{100})^3 \rho}{M}$; substituting the value of d obtained by equation (1), there results:

$$\frac{m}{n^3} = \frac{c\lambda^3 \rho}{8 \sin^3 \theta M}$$

Besides telling the absolute distances apart of the planes of atoms in the crystal, spectrometer measurements give some indication of

the composition of these planes. Imagine that the atoms of a certain crystal are so arranged that in a direction normal to some face they lie in planes spaced as in figure 14. The distance apart of like planes of these atoms is d ; but midway between the planes made up of atoms of A are planes of atoms of B . The waves reflected from the A planes and from the B planes will interfere to an extent which depends upon the relative reflecting powers of these atoms. If, for example, the reflecting power of atom A were just equal to that of atom B , it is then quite clear that the first order reflection from one kind of plane, being of exactly opposite phase to that from the other, would just nullify the reflection from this other plane so that the distance apart of like planes would seem to be half of what it really is. If the reflecting powers of the two atoms were not equal, then there would still appear a first order reflection, but one weakened

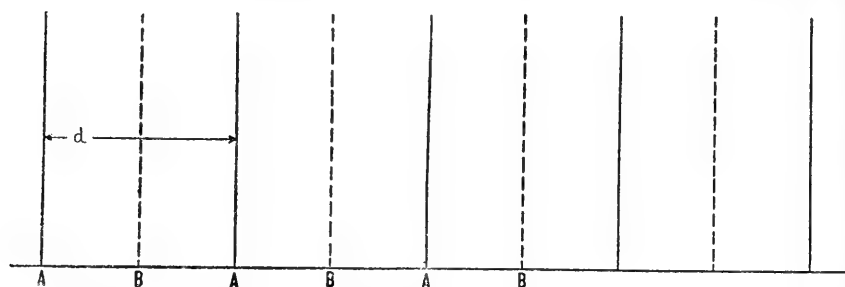

FIG. 14.

to an extent dependent upon the difference in the scattering powers of the two kinds of atoms.

The "laws" of reflection.—The use of this kind of information in deciding the arrangement of atoms in a compound necessitates that the relative reflecting powers for X rays of the different atoms be known. Previous studies of their scattering powers made it appear that atoms scatter and reflect X rays in an amount very roughly proportional to their atomic weights, or, more correctly, perhaps, their atomic numbers. The reflections from various crystals seem to have confirmed this rough proportionality; but whether the "reflecting" power is strictly proportional to the number of electrons in the atoms, and if not, what may be the exact nature of the function expressing their scattering powers, is at present unknown.

It has been stated that the use of the spectrometer makes possible the estimation of the relative intensities of the reflections from various crystal faces in the different orders. We have already seen how the intensity of reflection can be taken as an indication of the composition of the reflecting planes. But in order to do this it is obviously necessary to know the normal distribution of intensity in the

different orders, or, what amounts to the same thing, to know how the intensity of reflection depends upon the spacing between like planes of atoms in a crystal. The form of this function is not known now with any degree of certainty.

Until a knowledge of these two factors governing the amount of reflection of X rays—the effect of atomic number and the effect of spacing—is available it is useless to attack by the means we have been discussing any but the simplest of crystals. Even with these it is never certain that the structure selected as agreeing with the experimental data is actually the correct one. It may be urged that if a lack of knowledge of these two “laws” of reflection is the only thing that delays the determination of the structures of many and complicated crystals, then we should immediately proceed to discover the forms of these two expressions. The reason for not carrying out this apparently simple program is not hard to find. The commonly employed spectrometer method of studying the structure of crystals involves the simultaneous use of these “unknowns”; only in relatively few instances has it been possible to get at the arrangement of the atoms in a compound without assuming values for both of these expressions. Since it is only by working with crystals whose structures are known with certainty that progress can be made toward a satisfactory solution of these two problems, and since a use of the answers to these same problems are usually involved in getting the structures themselves, advancement has not been made.

These two “laws” which we have been discussing are of very considerable importance quite aside from their use in the determination of the structure of crystals. Such meager information as is at present available seems to show conclusively that the forms they will take can only be accounted for by taking into consideration the intimate structure of the atoms themselves.

The diffraction or reflection of X rays by an atom may be roughly pictured as follows: When a beam of X rays of definite wave length strikes an atom the rays may be supposed to accelerate the electrons contained within this atom. X rays which are emitted by such electrons are the diffracted (scattered or reflected) radiation. If all of the electrons in an atom were concentrated very close to the center the amount of scattered X rays should be quite closely proportional to the number of electrons in the atom. Such a proportionality is in reality only very roughly fulfilled; in fact, some of the evidence seems to point to quite marked variations from it. This lack of proportionality is most simply and easily explained by supposing that the atom, meaning thereby the volume occupied by the electrons surrounding the atomic nucleus, is relatively large. The X rays scattered by electrons on one side of the atom will interfere, sometimes

destructively and sometimes constructively—depending upon the absolute magnitude of the atom itself and upon the wave length of the X rays—with those rays scattered by electrons on the opposite side of the atom. This idea of atoms of appreciable size almost certainly must be called into play in order to account for the peculiar way in which the intensity of reflection varies with the angle of reflection.

This field of studying the intimate structure of the atom is quite untouched at the present time. The results which are to be obtained from it are, as we have seen, of more or less doubtful value until the determination of the structure of crystals has been put upon a very certain basis. When this has been done—that is, when we have succeeded in determining *uniquely* the structures of a few crystals—these methods of X ray experimentation quite properly can be expected to yield very useful information.

The method of powders.—The *second* method of obtaining diffraction effects from crystals (the method of powders) is in a sense a generalization of the one just discussed. If a parallel beam of monochromatic X rays is caused to fall upon a fine crystalline powder put in place of the crystal at *C* of figure 10 (p. 201), a number of images of the slit produced by different planes of atoms of the crystal will be obtained upon the photographic plate at *D*. For instance, if the powder is that of a cubic crystal, some of the particles of this powder will have the orientation necessary for reflection from, let us say, the cube face, others for reflection from the octahedral face, and still others from the dodecahedral face, and so on; consequently images from each of these planes will appear upon the film. The kind of photograph that is obtained in this way is shown in figures 16 to 19.¹⁷

The information supplied by a powder photograph is about the same as that obtained by spectrometer measurements, except that now a single experiment furnishes a large number of reflections which in the other case would have to be made upon each face separately. This is obviously a great advantage. The procedure at the same time has several serious disadvantages, however: (1) It is greatly to be doubted if the photometered intensities of reflection, such as are to be obtained from these photographs, are at the present time as accurate as are the results derived from the use of the ionization chamber; (2) the amount of material which is reflecting X rays in the formation of any one of these images is extremely small, so that relatively very long exposures are required; (3) partly because of this small amount of diffracted energy, the images are of considerable width, so that planes having about the same relative spacings—

¹⁷ Figs. 16 and 17 are given by A. W. Hull, *op. cit.*; figs. 18 and 19 by H. Bohlin, *Ann. d. Phys.*, 51, 421, 1920.



FIG. 15.—The X-ray spectrum of tungsten using sodium chloride (cube face) as a grating.

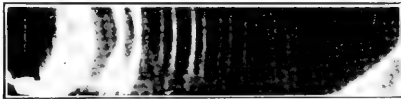

FIG. 16.—The powder spectrogram from powdered silicon.

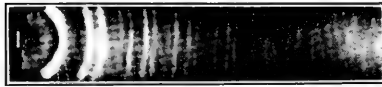

FIG. 17.—The powder spectrogram from diamond.



FIG. 18.—The powder spectrogram from nickel.

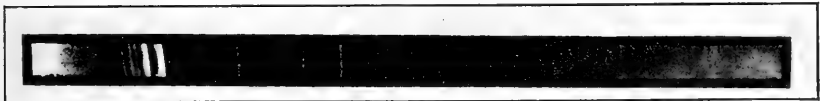

FIG. 19.—The powder spectrogram from magnesium.



which are at present the most useful in studying the structure of crystals—will give effects which overlap one another; (4) used by itself this method fails to identify the reflection of any plane with a particular image. While this last objection is not serious when we are dealing with very simple compounds, it is exceedingly important for all of the more complicated cases.

The great use of this method lies in its opening up for study a vast number of chemical compounds which do not crystallize well. At present it is not known whether the atoms of many kinds of substances are arranged in an orderly fashion or not. For instance, are the individual particles of a colloidal substance in reality extraordinarily minute crystals or are they more properly to be looked upon as more or less haphazard agglomerations of atoms? Or are many of the naturally occurring minerals, such as chalcedony or the opal, perfectly disordered groupings of atoms, or are they built up of the minutest crystals which stand in disordered relations to one another? This method of obtaining diffraction effects may be expected to answer such questions as these. This field is, however, thus far practically unexplored.¹⁸ Further, are liquid crystals crystalline in the sense that they are made up of a regular arrangement of atoms in space? We have here a method of attack for deciding it. If the atoms within the *molecules* of complicated organic compounds stand in a definite orientation to one another, then such compounds should give diffraction effects *even in the liquid state*. Debye and Scherrer¹⁹ believe that they have obtained diffractions from *liquid benzene* which prove the existence of the benzene ring; in fact, it is said to be 6.02×10^{-8} centimeters on an edge and 1.19×10^{-8} centimeters thick. This same method finds its use even in the field of chemical analysis.²⁰ Suppose that we have a substance which on solution gives a test for, let us say, sodium and potassium, chlorine and iodine. Is it a mixture of sodium chloride and potassium iodide, or is it a mixture of sodium iodide and potassium chloride, or are all four present together? The method we have been discussing will decide it, for each of the substances is characterized by its own distance between atoms, and once the pattern of images which each of these substances furnishes is known it is only necessary to search for these same patterns in the photograph obtained from the mixture to be analyzed.

The method of Laue photographs.—The *third* method of obtaining diffraction effects from crystals is the original method of Laue. In this instance X rays are passed through thin sections of individual crystals in a direction normal or nearly normal to some im-

¹⁸ See, however, S. Kyropoulos, *Zeit. anorg. Chem.*, 99, 197, 1917.

¹⁹ P. Debye u. P. Scherrer, *Nach. Kgl. Ges. Göttingen*, Dec. 17, 1915.

²⁰ A. W. Hull, *J. Am. Chem. Soc.*, 41, 1168, 1919.

portant crystal face. In this way reflections from a relatively enormous number of different crystal planes are obtained at one time. Some Laue photographs have been prepared which show nearly a thousand reflections; it is very common that the number should lie around three to four hundred. Of course several of these spots may belong to the same crystal form, but in spite of this fact the number of different kinds of planes that give reflections in a single photograph is very large.

In contrast with the method of powders the principal use of the *transmission method* lies in its application to the determination of the structures of crystals. A study of the Laue photographs from a crystal, when combined with a spectrometer determination of the number of molecules associated with the unit of structure, supplies more data for distinguishing between the various possible arrangements of its atoms than does any other single method. Transmission photographs are of particular use at the present time because the relatively large amount of data which they furnish makes it possible to dispense to a large extent with the assumptions concerning the reflecting powers of the atoms and the effect of spacing upon the intensity of reflection. As already pointed out, unless some entirely new procedure is devised it is only by taking advantage of the relatively few and scattering instances where structures can be investigated without the help of both of these two "laws" that direct progress can be made. It remains to be seen whether the Laue photographs will continue to give the most usable information after the forms of these two "laws" have been determined.

Whereas the other two methods employ X rays of a single wave length the Laue photographs are obtained by the diffraction of that part of the radiation from an X-ray tube, which, by reason of its analogy to white light, is called the "white radiation." Figure 15 shows the spectrum of tungsten. Spectrometer measurements make use of the line radiation, the characteristic radiation; the Laue photographs are produced by the continuous portion of much shorter wave lengths. This is alike an advantage and a disadvantage—a disadvantage because we must devise methods of studying the Laue photographs which will permit the determination of the wave length; an advantage (1) because the wide range of wave lengths that are available permit reflections from a large number of planes for a definite setting of the crystal, and (2) because the shortness of the wave lengths makes it possible for planes with very small spacings—and complicated indices—to give reflections that can be readily studied.

Figure 9 (pl. 4) shows the Laue photograph that is obtained by passing X rays through a thin section of magnesium oxide cut, or

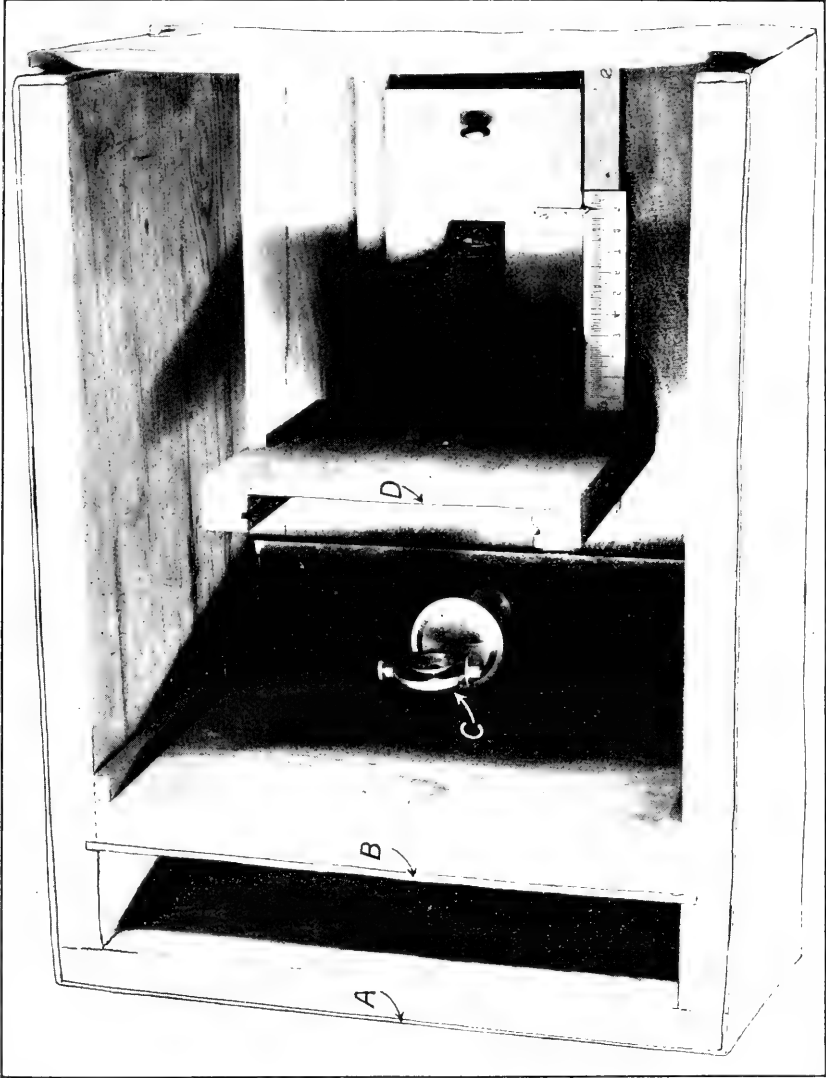

Fig. 20.—A form of the apparatus required for the preparation of Laue photographs. *A* and *B* are pinhole lead slits; the crystal holder *C* permits setting the section of the crystal at any desired orientation; *D* is a movable plate holder. Other and more complicated forms have been used; this one is desirable chiefly because of its simplicity.

cleaved, parallel to the cube, (100), face.²¹ In figure 1 (p. 200) the pinhole beam of X rays strikes this thin section of the crystal mounted at *C*; most of it passes directly through the crystal and forms an undiffracted image of the pinholes at *O*; the rest of the rays are "reflected" by the various planes of atoms in the crystal and produce a group of images, each one corresponding to a crystal plane, arranged about this central spot. (Fig. 20.)

The relative positions of the reflections from the different planes are conditioned only by the kind of symmetry which the crystal exhibits; the absolute positions of these spots upon the plate depend on the distance from the crystal section to the photographic plate. The patterns from different cubic crystals, or from two other crystals which have the same axial ratios and belong to the same system of crystal symmetry, differ from each other then simply in the relative intensities of the reflections from the various planes; this, of course, depends upon the arrangement of the atoms within the crystal and upon their relative "reflecting" powers. Consider the reflection from the plane containing the line *CP* and parallel to the *Y* axis of a cubic crystal. (Fig. 21.)

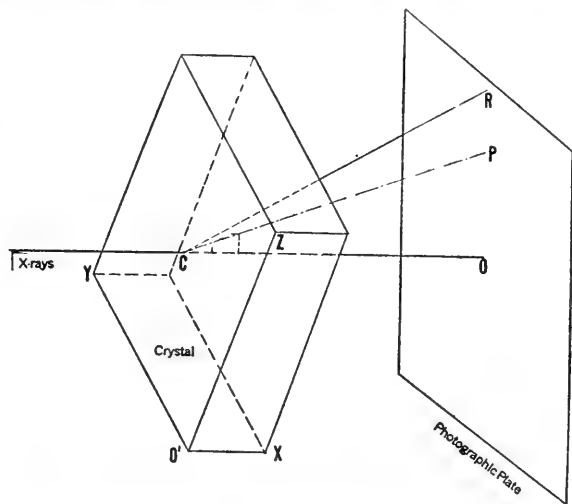

FIG. 21.

The intercepts of this plane upon the *Z* and *X* axes are in the proportion of 1:2; the *Y* intercept is infinity. Since the ratio of the intercepts of the plane are thus $2:\infty:1$, its indices must by definition be 102 ($\frac{1}{2}, 0, 1$). If the angle between this plane and the incident rays is 0, the reflection will be along *CR*, where the angle $RCO=2\theta$. In a similar fashion the position of the reflection from any plane can be determined from the characteristics of symmetry of the diffracting crystal. Conversely, it is possible to get such characteristics as the axial ratio of a crystal from a study of the Laue photographs.

This purely geometrical problem of identifying the reflections that are obtained upon the photographic plate with those planes that may be thought of as producing them can be easily solved with the aid of

²¹ Ralph W. G. Wyckoff, *Am. J. Sci.*, 1, 138, 1921.

methods of projection familiar to the crystallographer. Likewise the distance between like planes in terms of the indices of these planes for each of the units of structure which underlie crystals can be obtained from geometrical considerations alone. Furthermore the distance from the crystal to the photographic plate and the distance of a reflection from the central spot give the angle of its reflection. Then with the aid of expression (1) it is possible to get a value for $n\lambda$, the product of the order of the reflection into the wave length of the reflected X rays, after one of the absolute dimensions in the crystal has been obtained from an X-ray spectrum measurement. By tilting the crystal so that the X rays do not pass through it along some important axis, different planes of the same form are inclined at different angles to the incident beam and consequently must reflect X rays of different wave lengths. By plotting the intensity of the reflection from planes belonging to the same form against the wave lengths of the X rays they are reflecting, points of a curve will be obtained which represents the effect of the X rays upon the plate. The curves thus arising, one for each different kind of reflecting plane, can be compared in the same wave length. The data so obtained²² are serviceable in distinguishing between the possible arrangements of atoms for the crystal under investigation.

Résumé.—A brief outline has now been given of the essential features of the three ways, as they exist at the present time, of attacking the problem of the structure of crystals. It may be well to collect the outstanding features of these methods to show how they are related to one another and to indicate again the present status of the work in this field.

The start toward determining the arrangement of the atoms in crystals was made by looking around in each case for a structure which would explain the relative distances apart of planes of atoms in directions normal to a few crystal faces. Several chemically and crystallographically simple compounds—the alkali halides, zinc blende, the diamond, flourspar—were thus studied. Assuming, then, that the structures thus obtained actually represent the arrangement of atoms within these crystals, the wave length of X rays was deduced with the aid of expression (1) from a knowledge of the density of the crystals and the number of molecules in the gram molecule. Further, taking this as the proper value for the wave length of X rays, we have proceeded to use it to determine the amount of mass to be associated with the unit of structure of every crystal which has subsequently been studied. The objection to this

²² S. Nishikawa, op. cit. Ralph W. G. Wyckoff, J. Am. Chem. Soc., 42, 1100, 1920; Phys. Rev., 16, 149, 1920; Am. J. Sci., 50, 317, 1920.

procedure is, as we have already pointed out, that those original structures, upon the correctness of which the value for the wave length of X rays has been based, have never themselves been shown to be the *only* structures which are in agreement with the experimental data. The strong indication of correctness given to this value of the wave length by the fact that it fits in so satisfactorily with the large amount of data that has since accumulated makes this objection now a more or less formal one.

The determinations thus far made of the structure of crystals have been carried out by two distinct methods of procedure—or perhaps it would be better to say from two different points of view. Most of them have followed closely the early determinations in searching around for some grouping of atoms which would account for a certain limited amount of experimental data. The structures thus obtained have been considered to represent the actual arrangement of the atoms within the crystal. In many cases they are the simplest arrangements which could be found and as such have a certain, but very doubtful, degree of probability. Without exception, probably, they are not, however, the only ones which could be fitted into the existing data.

Only a few crystals have as yet been studied, starting from the point of view suggested by the theory of space groups. Following such a method of procedure we would most ideally make use of all three ways of getting diffraction effects—the spectrometer, the method of powders, and the transmission (Laue) photographs. The first step would get a reflection spectrum from some important crystal face. This measurement will decide the number of chemical molecules (or usually the numbers, since more than one is possible because of the uncertainty as to the order of the reflection) that can be associated with the unit underlying the crystal. With this as a basis and using the results of the theory of space groups, *all* of the ways in which the atoms of the compound could possibly be arranged can be written down. It is then a comparatively simple matter to decide exactly what data are required to distinguish between these various possibilities and to get them by whichever of the three methods of obtaining diffraction effects will supply them most readily. Even if it is impossible, with the present limited amount of information about the mechanism of the reflection of X rays, to eliminate all but one of these groupings, still we always have exact knowledge as to the status of the determination. The element of guessing is thus quite definitely eliminated.

A DISCUSSION OF SOME OF THE STRUCTURES THUS FAR STUDIED.²³

By making the seemingly plausible assumption that chemically simple compounds have their atoms in some sort of a simple arrangement in space, it is possible, as we have seen, to determine the crystal structures of quite a large number of compounds. It is perhaps worth while to consider to what results the structures obtained with the aid of this assumption will lead. A knowledge of the arrangement of the atoms in a crystal is essential to the adequate treatment of a large field of problems. The crystallographer who is concerned with finding some explanation for cleavage, or for a kind of twinning, will find an acquaintance with the crystal structure indispensable; the manner of the arrangement of the atoms in a compound forms a rational basis upon which to build a discussion of the relative occurrences of crystal faces.²⁴ Furthermore, the physicist who is interested in the structure of the atom must produce a model which will account for the structures of crystals. Yet again the chemist may look to these same structures for information as to the nature of the forces which are binding atoms together, for evidence of the existence or nonexistence of the chemical molecule, and for some light upon the nature of what we have been accustomed to call the valencies of the atom.²⁵ Quite recently attempts have been made to build upon these determinations of the structure of crystals a quantitative measure of such physical properties of the solid as its compressibility, as well as to try to explain, upon the basis of a definite model of the atom, some of the simpler structures.²⁶ The problems of the chemist, while by no means necessarily the ones whose ultimate solution will be most easily obtained, are, nevertheless, the ones to which the sort of information furnished by a knowledge of the structure of crystals is most readily applicable. The data as yet at hand are so meager—and the determinations themselves are, as already emphasized, of sufficient uncertainty—that the conclusions at which we arrive must be only provisional.

Metals.—The structures of a relatively large number of metals have been studied. Most of them appear to have the arrangements that would result from the close packing of bodies spherical or nearly spherical in shape. There are two forms of this close packing of spheres: (1) The closest packing, which has hexagonal sym-

²³ Not all of the crystals that have been studied will be discussed. Some, like fluorspar, CaF_2 , can not as yet be satisfactorily considered; many other determinations seem to be of more or less doubtful value.

²⁴ Ralph W. G. Wyckoff, *Am. J. Sci.*, 50, 317, 1920. P. Niggli discusses from this point of view the development of faces by crystals. *Zeit. anorg. Chem.*, 110, 55, 1920.

²⁵ For instance, see I. Langmuir, *J. Am. Chem. Soc.*, 38, 2221, 1916; Ralph W. G. Wyckoff, *J. Wash. Acad. Sci.*, 9, 565, 1919.

²⁶ M. Born and A. Landé, *Verh. deut. Phys. Ges.*, 20, 210, 1918; and several other papers by the same authors.

metry, and (2) the more important cubic face-centered arrangement, which is nearly as close a grouping. (Fig. 22.) Aluminum,²⁷ silver, thorium, lead, copper, calcium, indium, palladium, and iridium are among the elements which have been shown to have this cubic close-packed grouping. Zinc,²⁸ cadmium, ruthenium, and magnesium, on the other hand, approach to the hexagonal closest packing. Several elements, however, such as iron,²⁹ chromium, titanium, sodium, tantalum, and tungsten, crystallize in the less dense body-centered grouping. (Fig. 23.) Nickel³⁰ appears to be sometimes body-centered and sometimes face-centered. In attempting to deduce from these

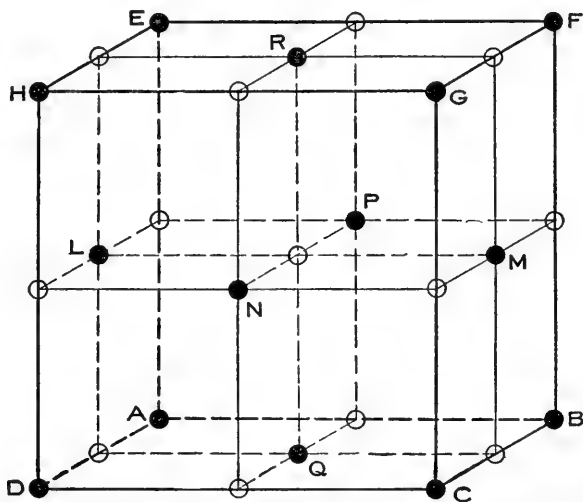

Fig. 22.—The sodium chloride arrangement. The black circles represent the positions of the atoms of one kind; the white circles those of the second kind of atoms. The alkali halides and the oxides of the divalent metals seem to have this atomic arrangement. Either the black atoms or the white ones have the grouping of the closest cubic packing of spheres.

simplest of compounds, are of all simple compounds perhaps the most dangerous as bases for further deductions.

Compounds of the type AB.—Several compounds of the type AB , where A is a metal atom and B is an electronegative atom, have been studied. All of the alkali halides have the "sodium chloride arrangement" (fig. 22) wherein each atom has six atoms of the opposite kind equally near to it. The divalent metal oxides, magnesium

²⁷ A. W. Hull, Phys. Rev., 10, 661, 1917; Science, 52, 227, 1920. P. Scherrer, Phys. Z., 19, 23, 1918. H. Bohlin, Ann. d. Phys., 61, 421, 1920. W. L. Bragg, Phil. Mag. (6), 28, 355, 1914. L. Vegard, Phil. Mag. (6), 31, 83, 1916.

²⁸ A. W. Hull, op. cit.

²⁹ A. W. Hull, op. cit. P. Debye, Phys. Z., 18, 483, 1917.

³⁰ A. W. Hull, Phys. Rev., 10, 661, 1917. H. Bohlin, op. cit.

and calcium, cadmium and nickel oxides,³¹ all have this same struc-

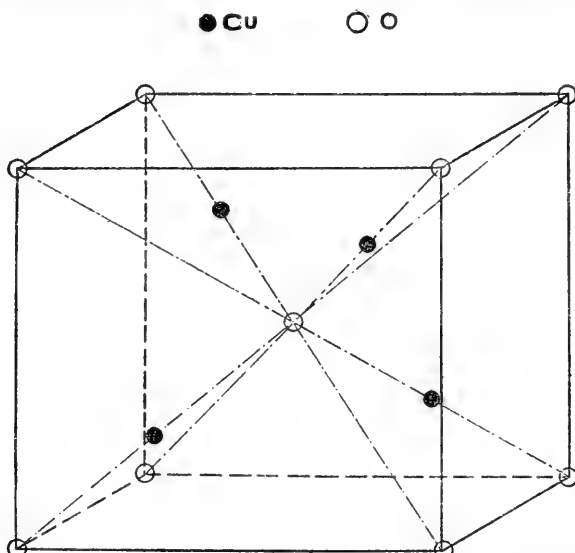

FIG. 23.—The cuprous oxide arrangement. Each monovalent copper atom is surrounded by two equally distant oxygen atoms and each divalent oxygen atom by four copper atoms. The white atoms alone have the body-centered grouping.

ture. Galena (lead sulphide) exhibits the same grouping. Zinc blende (zinc sulphide), on the other hand, has a different structure. (Fig. 24.) In this case each zinc atom is surrounded by four equally distant sulphur atoms, while each sulphur atom has about it four zinc atoms. Zinc oxide exhibits a still different grouping of atoms, but again each zinc atom is surrounded by four oxygen

atoms, while each oxygen atom has about it four zinc atoms. Cadmium sulphide and wurzite (hexagonal zinc sulphide) have the same atomic arrangement as zinc oxide.³²

The immediate conclusion to be drawn from these structures is that there is no unique connection between the arrangement of the atoms composing them and their chemical valencies. A qualitative explanation of the structures of these compounds is nevertheless possible. From other evidence it has

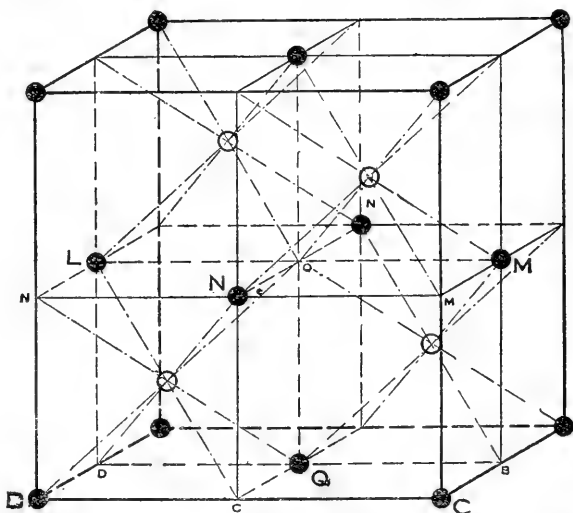

FIG. 24.—The zinc sulphide arrangement. In this arrangement each white atom is distant from four black atoms and each black atom from four white ones.

³¹ W. P. Davey and E. O. Hoffman, *Phys. Rev.*, 15, 333, 1920.

³² W. L. Bragg, *Phil. Mag.* (6), 39, 647, 1920.

seemed probable that the atoms in crystals of potassium chloride and related compounds are electrically charged. Upon this basis, then, the alkali halides appear as aggregates of equal numbers of positively and negatively charged atoms. When the atoms are doubly charged, as is presumably the case with magnesium or calcium oxide, for instance, the distance between the atoms is much less than between those of the alkali halides. Calcium carbonate and the divalent carbonates isomorphous with it (MnCO_3 , FeCO_3 , etc.) have the same structures if the carbonate groups are substituted for the electronegative atom.³³ The large CO_3 group may be thought of as squeezing out the sides of the cube till it has the form of an obtuse rhombohedron. Similarly caesium dichloriodide (CsICl_2) has the same arrangement as

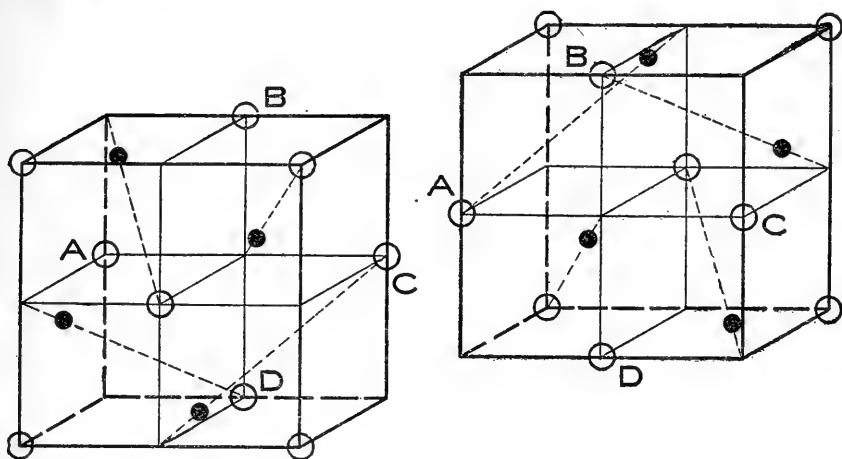

FIG. 25.—The pyrite arrangement. The black sulphur atoms are so spaced along the diagonals of these little cubes that each iron atom has six and each sulphur atom four equally near atoms.

caesium chloride if the group of atoms ICl_2 is substituted for chlorine. In this instance the ICl_2 atoms are all strung along the body diagonal so that it may be imagined as distorted from a cube to an acute rhombohedron.³⁴

Other simple compounds.—A number of other simple compounds have been studied with a considerable degree of care. If carbon atoms are placed at the positions occupied by both zinc and sulphur atoms in zinc blende, we obtain the arrangement of the atoms in the diamond.³⁵ (Fig. 24.) In pyrites each sulphur atom is surrounded by four equally distant atoms and each iron atom by six atoms.³⁶ (Fig. 25.) In cuprous oxide each copper atom is equally near to two

³³ W. L. Bragg, Proc. Roy. Soc. A 89, 468, 1914. W. H. Bragg, Phil. Trans., A 215, 253, 1915. Ralph W. G. Wyckoff, Am. J. Sci., 50, 317, 1920.

³⁴ Ralph W. G. Wyckoff, J. Am. Chem. Soc., 42, 1100, 1920.

³⁵ W. L. Bragg, Proc. Roy. Soc., A 89, 277, 1913. W. H. and W. L. Bragg, *ibid.*, 468.

³⁶ W. L. Bragg, *op. cit.* P. P. Ewald u. W. Friedrich, Ann. d. Phys. 44, 1183, 1914.

oxygen atoms, while each oxygen atom has about it four copper atoms.³⁷ Magnetite, as a typical spinel, has been studied with great care, and in spite of its rather complicated chemical composition its structure is in all probability that given in figure 26.³⁸ In this case each divalent metal is surrounded by four and each trivalent metal by six equally distant atoms. In each of these cases it is to be noted that the number of the nearest atoms to any atom is always either equal to its chemical valence or is twice that number. The constant recurrence of this relation suggests that it may be other than purely an affair of chance. Furthermore, a consideration of the sorts of chemical bonding which are conceivable on the basis of our present

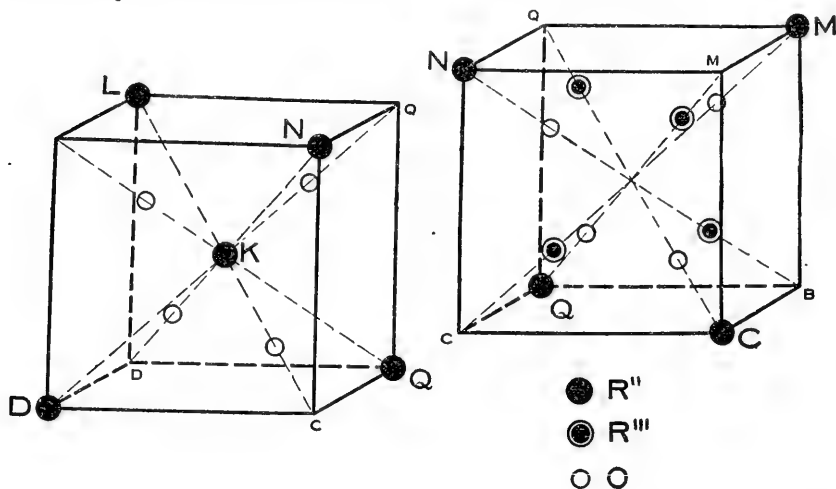

FIG. 26.—The spinel arrangement. The divalent metal atoms of a spinel occupy *all* of the positions of Fig. 24. The arrangement of the other atoms is here shown for the two typical divisions of this unit. Each divalent metal atom (R'') is equally distant from four atoms each trivalent metal atom (R''') from *six* atoms; and each divalent oxygen atom (O) from *four* atoms.

knowledge of the structure of the atom points to the possible existence of just such a relation as this.

*Information to be derived from the structure of the atom.*³⁹—A neutral atom appears to be made up of a minute positively charged nucleus surrounded by enough electrons to neutralize the nuclear charge. The chemical inertness of certain of the elements—the rare gases of the atmosphere—and the fact that atoms having one, two, three, and in some cases four more electrons than a rare gas exhibit a marked tendency to lose just enough electrons in becoming positively charged to revert to the configuration of the inert gas, seem to

³⁷ W. H. and W. L. Bragg, *X-rays and Crystal Structure*, p. 155.

³⁸ S. Nishikawa, *op. cit.* W. H. Bragg, *Phil. Mag.* (6), 30, 305, 1915.

³⁹ J. J. Thomson, *Phil. Mag.* (6), 27, 757, 1914. G. N. Lewis, *J. Am. Chem. Soc.*, 38, 762, 1916. Ralph W. G. Wyckoff, *J. Wash. Acad. Sci.*, 9, 565, 1919.

point to the existence of certain especially stable configurations of electrons in atoms. For instance, sodium with one more and magnesium with two more electrons than neon readily lose one and two electrons, respectively, in becoming positive sodium and magnesium ions. Furthermore, as the electronegative elements are approached a strong tendency becomes evident to add on enough electrons beyond the number required for atomic neutrality to complete the next stable arrangement. If one of the atoms of a compound is highly electropositive and another strongly electronegative, the latter may be able to extract as a result of this tendency electrons from the positive atom; the compound in the solid state thus becomes, as we have supposed to be the case with the alkali halides, an aggregate of an equal number of positive and negative "ions." Such a union has been called a *polar bonding*. If, however, the combining atoms are both either strongly electronegative or are to be found among the elements of an amphoteric and less pronounced electrical character, then each atom will strive, without complete success, to abstract electrons from the other in order to complete its especially stable group. The electrons thus held in common by two atoms form a second sort of bonding—the *valency bonding*. Since a complete valence unit (in the old chemical sense) consists both of the tendency of one atom to acquire an electron from another and the tendency of some other atom to take one of this same atom's electrons, the number of electrons in combination with any particular atom may be twice as great as its chemical valence. Such valency bondings must be supposed to be operative between the atoms in those compounds of the sort discussed which are not of the sodium chloride type. This explanation accords well with the natures of such compounds as the diamond and carborundum, and accounts in a satisfactory manner for the unions between the chlorine atoms in chlorine gas or for the bonding between carbon and oxygen in the carbonate group. It is surprising, however, to find some metals, as zinc and copper (in zinc sulphide and cuprite), appear to exhibit the same sort of union in some of their compounds. It should be pointed out that the only metals for which this rule fits, iron, zinc, and the like, are without exception atoms in the center of a long period of the periodic table. About the arrangement of the outside electrons of these atoms nothing is known at present. Of course, it may be argued that we are dealing with only chance agreements with a rule, but it must be remembered that such structures as zinc sulphide depart so far from being closely packed arrangements of atoms that some sort of directional character to the forces of combination between their atoms seems necessary in order to account for their existence as stable groupings.

In spite of the obvious uncertainties that pervade all these discussions, there seems to be considerable evidence, from a consideration of the crystal structures of such compounds as have been more or less carefully studied, for the existence of two distinct types of solid compounds: (1) *Polar compounds*, wherein the bonding between the atoms, or at least between certain groups of atoms, is polar; and (2) *valency compounds*, the atoms of which are bound to other atoms by holding electrons in common. A consideration of organic compounds, none of which have thus far been successfully studied using the X rays, forces us to a third kind of compound; (3) the *molecule-forming compounds*, built of groups of atoms (the chemical molecules) held together presumably by relatively weak stray fields of force. It will be noticed that in solids of the first two types no molecules in the chemical sense of the word exist; each crystal or piece is a single chemical individual.

•

DOCTOR ASTON'S EXPERIMENTS ON THE MASS SPECTRA OF THE CHEMICAL ELEMENTS.

With introduction by C. G. ABBOT.

[With 1 plate.]

In his paper, "The problem of radioactive lead,"¹ Dr. T. W. Richards showed that there exist well-marked differences between the atomic weights of lead from different sources. To every chemical and optical test other than the atomic weights and closely related properties the samples are indistinguishable, and, when mixed, inseparable. The recent beautiful experiments of Dr. F. W. Aston, of the University of Cambridge, throw a clear light on this matter and show that many others of the chemical elements contain components of different atomic weights. These are identical in all chemical and optical properties, so that the several varieties are indistinguishable and inseparable by ordinary means.

In order to clearly grasp the profound significance of these results and to appreciate the ingenuity which has brought them to light it will be well to review a variety of phenomena before giving Doctor Aston's observations in his own words.

It is but a few years since a chemical element was defined as a substance which can not be decomposed into unlike components, and an atom as the smallest particle of such a substance. While the atoms could neither be seen nor isolated, their relative weights in different elements were known by noting the proportions in which the elements combine. Thus Morley, in his classical investigation,² determined the relative atomic weights of oxygen and hydrogen at 16.000 and 1.0076.

So many of the atomic weights are exact whole numbers that a suspicion was entertained by many chemists of the nineteenth century that all atomic weights would be integers if correct determinations of them could be obtained. Doctor Richard's classical work made this

¹ Smithsonian Report for 1918, pp. 205-219 (separate publication No. 2557).

² Smithsonian Contributions to Knowledge, Vol. XXIX.

hypothesis untenable. Chlorine, for instance, has the atomic weight 35.46 and can not be forced to take an integral value.

Readers of the Smithsonian Reports of 1918, 1915, and 1914 may recall in the articles of Millikan, Rutherford, and Eve references to the inspiring discovery of the so-called "atomic numbers" by Moseley, whose brief life of brilliant promise was lost in the ill-fated British expedition to the Dardanelles. Moseley found that the X-ray spectra of the elements had a regular periodicity expressible by the integral numbers progressing by unit steps from element to element nearly in the order of their increasing atomic weights. Certain gaps in the Moseley atomic numbers indicate the existence of a few elements hitherto undiscovered. Thus the irritating deviations from integers of the atomic weight values gave place to a beautiful roundness in the Moseley system of X-ray spectrum atomic numbers.

By this time it had become impossible to define an element as a substance incapable of disintegration, for not long after the discovery of radium several "elements," including uranium, radium, and others, were found to be continuously disintegrating with the evolution of heat. One product of this degradation was found to be helium and another the metal lead. Thus does nature solve the alchemist's problem of accomplishing a transmutation of the elements. But her methods are not in man's control either to accelerate, retard, or modify the final products.

We must follow still another thread of investigation before we are ready to take up Doctor Aston's experiments. Prior to Röntgen's discovery of the X rays in 1895, as described by him in the Smithsonian Report for 1897, a deal of investigation had gone on in relation to the phenomena of the electric discharge in vacuum tubes. It will be convenient to recall the terms used by physicists for the essential parts of the apparatus used in this work. Of the two metallic conductors inserted through the glass in a vacuum discharge tube, the negative is called the "cathode," the positive the "anode." When under the force of the electric field streams of positively charged particles move through the highly rarefied gas toward the cathode, they, upon striking it, cause it to emit at right angles to its surface the so-called "cathode rays." If the cathode is perforated, part of the stream may pass through the holes, producing luminosity behind the cathode, and forming the so-called "canal-strahlen" or "positive rays."

It now appears that the cathode rays are negatively charged bodies called ions or electrons, having masses less than a thousandth part of that of an atom of hydrogen, but the positive rays are composed of positively charged particles ranging from about the mass of the hydrogen atom, as a minimum, to much larger

values. Since both the cathode rays and the positive rays are streams of separated electric charges, they may be deflected by subjecting them to the influence either of an electric field or a magnetic field. In an uniform magnetic field, at right angles to their path, the cathode rays move on the arc of a circle so that the plane defined by the original ray and the magnetically deviated one is at right angles to the lines of magnetic force. A somewhat similar deviation may be brought about by an electrostatic field produced by two metal plates parallel to the magnetic field and to the original cathode ray, one plate above the other beneath the beam, and maintained at a suitable difference of electrical potential.

To deflect equally the positive rays requires very much stronger magnetic or electric fields than suffice for cathode rays. For the masses of the electrified particles in the positive rays are thousands of times greater than the masses of the negative ions which compose the cathode rays.

As the result of investigations of the last 25 years of vacuum-tube phenomena, radioactive substances, and in other related branches of inquiry (see the papers of Millikan, Rutherford, and Eve above cited), a rapidly penetrating and clarifying view of the structure of the atom and its relations to electrical and chemical phenomena has come about. Progress is so rapid that what was written 10 or even 5 years ago no longer quite fits all of the observations, and what I am about to write will doubtless not long be a fully representative statement. Even now Doctor Langmuir's views are not harmonized to it. At the present, however, to meet the requirements of the physicists' observations one may view an atom as having a central nucleus whose mass comprises almost the whole mass of the atom, but whose volume is perhaps as small, compared to the whole volume of the atom, as that of the sun is to the solar system. Outside the nucleus, in one or several orbits comparable to the orbits of the planets, revolve the negative electrons or ions. The number of outside ions which an atom holds is equal to the Moseley atomic number. Some negative ions may also be agglomerated in the nucleus. But the main mass of the nucleus is composed of the so-called positive particles. Of these the hydrogen atom has one, and heavier atoms a plurality. This agglomeration which we call the nucleus has a positive charge equal to the sum of the negative charges of the outlying ions. When under the influence of an electric field one of the outlying ions may be knocked off and proceeds toward the anode, while the remainder of the atom proceeds toward the cathode. A molecule comprising two or more atoms, such as hydrochloric acid (HCl) or carbonic acid (CO₂), is a still

further complicated system with several nuclei and many outlying orbits. According to Aston's work, as we shall see, such a system also may lose a single negative ion, and the remainder take part in a positive ray by virtue of its resulting excess of one positive unit of electricity.

The chemical and optical properties of atoms are thus supposed to be governed by the number and arrangement of their outlying ions, but their gravitational properties inhere almost wholly in their nuclei. In atoms of a considerable number of outer ions, nuclei may be built up in different ways of different numbers of positive particles, and yet present the necessary number of free positive charges to neutralize the equal groups of outer ions. Thus there may be atoms of identical chemical and optical properties but different atomic weights. Such atoms are called "isotopes."

In this view it is evident that the isotopes are to be separated only by methods which react differently depending on the masses of the nuclei. One such is the method of diffusion. Naturally if some molecules of a gas are heavier than others they will tend to diffuse through a narrow orifice at different rates. By collecting the slower moving fractions several thousand times, the heavier molecules can be partially separated from the lighter ones. In this way a partial separation of the gas neon into two fractions, differing somewhat in their atomic weight, was accomplished in 1913 in Sir J. J. Thomson's laboratory. Doctor Aston has, however, perfected a method of separating isotopes based on the deflections of the positive rays in the electric and magnetic fields, which has led to the most beautiful results.

To understand his method, it should be recalled that there are three quantities involved besides the strength of the electric and magnetic fields. These are the mass (m), the electric charge (e), and the velocity (v) of each positive particle taking part in the positive ray which is being experimented upon. In general the values of the electric charge (e) are equal. That is, each particle carries one electronic unit excess of positive charge equal but opposite in sign to the negative charge which is carried by the ion which is knocked off by the electric field in the vacuum tube. I say "in general" but two or three electronic units of excess positive charge are possible. The electric charges being, then, generally equal, Doctor Aston's problem was to eliminate the variable velocity from the observation by combined influences of electric and magnetic fields, so as to be free to observe differences of mass of the several atoms composing a single gas. We will now let Doctor Aston's own words tell his story.

THEORY OF THE MASS SPECTROGRAPH.³

Positive rays obtained from an ordinary discharge bulb vary both in mass and velocity. An electric field will spread them into an "electric spectrum" with deflections proportional to $\frac{e}{mv^2}$; a magnetic field will spread them into a "magnetic spectrum" with deflections proportional to $\frac{e}{mv}$. * * *

The concentration of the stream of positive rays down the axis of the discharge bulb is very marked, but there is good evidence for assuming that the intense part of the stream occupies a fairly considerable solid angle. This suggests the possibility of an increase of

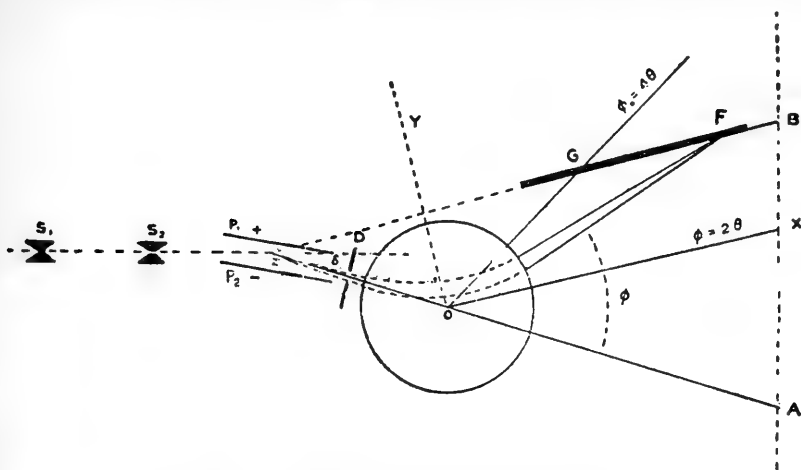

FIG. 1.—Theory of the mass-spectrocope.

intensity by means of a device which should select the rays aimed at a particular spot on the plate whatever direction they come from. * * *

Clearly the simplest way of increasing the intensity of the spot without increasing its dimensions, at any rate in one direction, is to use two parallel straight slits. * * *

POSSIBILITIES OF FOCUSING POSITIVE RAYS.

The very great accuracy attained in the spectrometry of light depends largely on the fact that a considerable solid angle of divergent rays from a point source can be brought to a point image by means of a lens. It is of importance to inquire if any such convergence can be applied to rays of charged particles by any electric or magnetic device. * * *

³ Extracted from "A positive ray spectrograph," Philosophical Magazine and Journal of Science, December, 1919, pp. 707-714.

This is done in the present apparatus as diagrammatically indicated in figure 1. The rays after arriving at the cathode face pass through two very narrow parallel slits of special construction S_1S_2 , and the resulting thin ribbon is spread out into an electric spectrum by means of the parallel plates P_1, P_2 . After emerging from the electric field the rays may be taken, to a first order of approximation, as radiating from a virtual source Z halfway through the field on the line S_1S_2 . A group of these rays is now selected by means of the stop or diaphragm D , and allowed to pass between the parallel poles of a magnet. For simplicity the poles are taken as circular, the field between them uniform and of such sign as to bend the rays in the opposite direction to the foregoing electric field.

If θ and ϕ be the angles ⁴ (taken algebraically) through which the selected beam of rays is bent by passing through fields of strength X and H , then

$$\theta v^2 = lX \frac{e}{m}(1), \text{ and } \phi v = LH \frac{e}{m}(2),$$

where l, L are the lengths of the paths of the rays in the fields. Equation (1) is only true for small angles, but exact enough for practice. It follows that over the small range of θ selected by the diaphragm θv^2 and ϕv are constant for all rays of given e/m , therefore

$$\frac{\delta\theta}{\theta} + \frac{2\delta v}{v} = 0, \text{ and } \frac{\delta\phi}{\phi} + \frac{\delta v}{v} = 0,$$

so that

$$\frac{\delta\theta}{\theta} = \frac{2\delta\phi}{\phi}.$$

when the velocity varies in a group of rays of given e/m .

In order to illustrate in the simplest possible way how this relation may be used to obtain focusing, let us suppose the angles (exaggerated in the diagram) small and the magnetic field acting as if concentrated at the center O of the pole pieces. If the length $ZO = b$, the group selected will be spread out to a breadth $b\delta\theta$ at O , and at a farther distance r the breadth will be

$$b\delta\theta + r(\delta\theta + \delta\phi) \text{ or } \delta\theta \left[b + r \left(1 + \frac{\phi}{2\theta} \right) \right] \quad (3)$$

Now as the electric and magnetic deflections are in opposite directions, θ is a negative angle. Say $\theta = -\theta'$. Then if $\phi > 2\theta'$, the quantity (3) will vanish at a value of r given by

$$r(\phi - 2\theta') = b \cdot 2\theta',$$

which equation appears correct within practical limits for large circular pole pieces.

⁴ In the figure these angles are greatly exaggerated for clearness.

Referred to axes OX, OY, the focus is at $r \cos (\phi - 2\theta')$, $r \sin (\phi - 2\theta')$, or $r, b.2\theta'$; so that to a first-order approximation, whatever the fields, so long as the position of the diaphragm is fixed, the foci will all lie on the straight line ZF drawn through Z parallel to OX. For purposes of construction G the image of Z in OY is a convenient reference point, ϕ being here equal to 4θ . It is clear that a photographic plate, indicated by the thick line, will be in fair focus for values of e/m over a range large enough for accurate comparison of masses.

The arrangement, which has a distinct resemblance to the ordinary quartz spectrograph, gives very complete control. The field between the plates can be adjusted to allow the brightest part of the electric spectrum to be used which, as has been shown, is in general the same for all normal rays under steady discharge, and the values of e/m can be compared very accurately from the positions of their lines relative to those of standard elements which can be brought to any desired position on the plate by varying the magnetic field strength.

CONSTRUCTION OF THE MASS SPECTROGRAPH.

THE SLITS.

The very fine slits used in this apparatus were made with comparative ease, as follows: A cylinder of pure aluminium about 10 millimeters long by 5 millimeters wide is carefully bored with a hole 1 millimeter diameter. The resulting thick-walled tube is then cleaned and crushed with a hammer on an anvil until the circular hole becomes a slit about 3 millimeters wide. Continuation of this treatment would result in a slit as fine as required, giving the maximum resistance to the passage of gas, but its great depth would make the lining up of a pair a matter of extreme difficulty. The crushed tube is therefore now placed between two V-shaped pieces of steel and further crushed between the points of the V's at about its middle point until the required fineness is attained. Practice shows that the best way of doing this is to crush until the walls just touch, and then to open the slit to the required width by judicious tapping at right angles to that previously employed. With a little care it is possible to make slits with beautifully parallel sides to almost any degree of fineness, 0.01 millimeter being easily attainable. At this stage the irregularly shaped piece of aluminium is not suited to accurate gas-tight fitting; it is therefore filled with hard paraffin to protect it from small particles of metal, etc., which, if entering, can not be dislodged owing to its shape, and turned up taper to fit the standard mountings. These in the present apparatus are taper holes in the back of the cathode and in a corresponding brass plug at the ends of a wide tube

10 centimeters long. When turned, the paraffin is easily removed by heat and solvents.

THE DISCHARGE TUBE.⁵

Figure 2 is a rough diagram of the present arrangement. The discharge tube B is an ordinary X-ray bulb 20 centimeters in diameter. The anode A is of aluminium wire 3 millimeters thick surrounded concentrically by an insulated aluminium tube 7 millimeters wide to protect the glass walls, as in the Lodge valve.

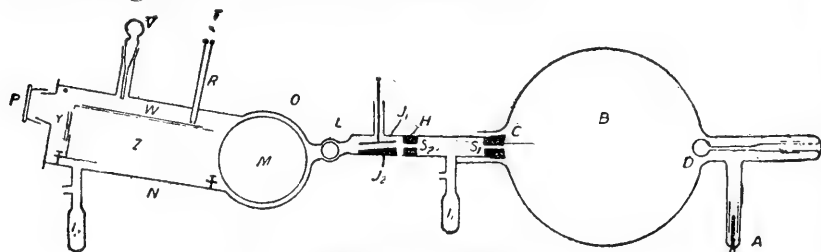

FIG. 2.—Diagram of the mass-spectroscope.

The aluminium cathode C, 2.5 centimeters wide, is concave, about 8 centimeters radius of curvature, and is placed just in the neck of the bulb, this shape and position having been adopted after a short preliminary research. In order to protect the opposite end of the bulb, which would be immediately melted by the very concentrated beam of cathode rays, a silica bulb D, about 12 millimeters diameter, is mounted as indicated. The use of silica as an anticathode was sug-

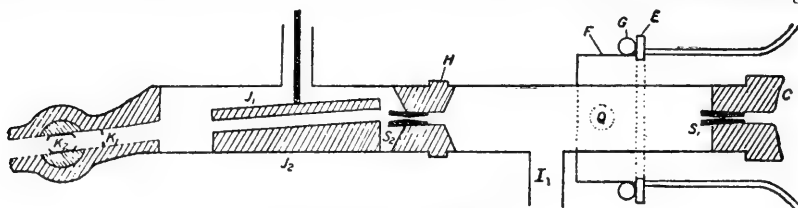

FIG. 3.—The discharge tube.

gested by Professor Lindemann, and has the great advantage of cutting down the production of undesirable X rays to a minimum.

The discharge is maintained by means of a large induction coil actuated by a mercury coal-gas break; about 100 to 150 watts are passed through the primary, and the bulb is arranged to take from 0.5 to 1 milliamperes at potentials ranging from 20,000 to 50,000 volts. Owing to the particular shape and position of the electrodes, especially those of the anode, the bulb acts perfectly as its own rectifier.

⁵ Extracted from "The mass spectra of chemical elements," *Philosophical Magazine and Journal of Science*, May, 1920, pp. 611-625.

The method of mounting the cathode will be readily seen from figure 3, which shows part of the apparatus in greater detail. The neck of the bulb is ground off short and cemented with wax to the flat brass collar E, which forms the mouth of an annular space between a wide outer tube F and the inner tube carrying the cathode. The concentric position of the neck is assured by three small ears of brass, not shown. The wax joint is kept cool by circulating water through the copper pipe shown in section at G.

The gas to be analyzed is admitted from the customary fine leak into the annular space and so to the discharge tube by means of the side tube attached to F, shown in dotted section at Q. Exhaustion is performed by a Gaede mercury pump through a similar tube on the opposite side. The reason for this arrangement is that the space behind the cathode is the only part of the discharge bulb in which the gas is not raised to an extremely high potential. If the inlet or outlet is anywhere in front of the cathode, failing special guards, the discharge is certain to strike to the pump or the gas reservoir. Such special guards have been made in the past by means of dummy cathodes in the bore of the tubes, but, notwithstanding the fact that the gas can only reach the bulb by diffusion, the present arrangement is far more satisfactory and has the additional advantage of enabling the bulb to be dismantled by breaking one joint only.

THE SLIT SYSTEM.

The center of the cathode is pierced with a 3-millimeter hole, the back of which is coned out to fit one of the standard slits, S_1 . The back of the cathode is turned a gas-tight fit in the brass tube 2 centimeters diameter carrying it, the other end of which bears the brass plug H, which is also coned and fitted with the second slit, S_2 . The two slits, which are 0.05 millimeter wide by 2 millimeters long, can be accurately adjusted parallel by means of their diffraction patterns. The space between the slits, which are about 10 centimeters apart, is kept exhausted to the highest degree by the charcoal tube I_1 . By this arrangement it will be seen that not only is loss of rays by collision and neutralization reduced to a minimum, but any serious leak of gas from the bulb to the camera is eliminated altogether.

THE ELECTRIC FIELD.

The spreading of the heterogeneous ribbon of rays formed by the slits into an electric spectrum takes place between two parallel flat brass surfaces, J_1 J_2 , 5 centimeters long, held 2.8 millimeters apart by glass distance pieces, the whole system being wedged immovably in the brass containing tube in the position shown. The lower sur-

face is cut from a solid cylinder fitting the tube and connected to it and earth. The upper surface is a thick brass plate, which can be raised to the desired potential by means of a set of small storage cells. In order to have the plates as near together as possible, they are sloped at 1 in 20—i. e., half the angle of slope of the mean ray of the part of the spectrum which is to be selected by the diaphragms. Of these there are two: One, K_1 , an oblong aperture in a clean brass plate, is fixed just in front of the second movable one, K_2 , which is mounted in the bore of a carefully ground stopcock L. The function of the first diaphragm is to prevent any possibility of charged rays striking the greasy surface of the plug of the stopcock when the latter is in any working position. The variable diaphragm is in effect two square apertures sliding past each other as the plug of the stopcock is turned, the fact that they are not in the same plane being irrelevant. When the stopcock is fully open as sketched in figure 3, the angle of rays passing is a maximum and may be stopped down to any desired extent by rotation of the plug, becoming zero before any greasy surface is exposed to the rays. Incidentally the stopcock serves another and very convenient use, which is to cut off the camera from the discharge tube, so that the latter need not be filled with air each time the former is opened to change the plate.

THE MAGNETIC FIELD.

After leaving the diaphragms the rays pass between the pole pieces M of a large DuBois magnet of 2,500 turns. The faces of these are circular, 8 centimeters diameter, and held 3 millimeters apart by brass distance pieces. The cylindrical pole pieces themselves are soldered into a brass tube O, which forms part of the camera N. When the latter is built into position the pole pieces are drawn by screwed bolts into the arms of the magnet, and so form a structure of great weight and rigidity and provide an admirable foundation for the whole apparatus. Current for the magnet is provided by a special set of large accumulators. The hydrogen lines are brought onto the plate at about 0.2 ampere, and an increase to 5 amperes, which gives practical saturation, only just brings the singly charged mercury lines into view. The discharge is protected from the strong field of the magnet by the usual soft iron plates, not shown.

THE CAMERA.

The main body of the camera N is made of stout brass tube 6.4 centimeters diameter, shaped to fit onto the transverse tube O containing the pole pieces. The construction of the plate holder is indicated by the side view in figure 2 and an end-on view in figure 4.

The rays, after being magnetically deflected, pass between two vertical brass plates, Z Z, about 3 millimeters apart, and finally reach the photographic plate through a narrow slot 2 millimeters wide, 11.8 centimeters long, cut in the horizontal metal plate, X X. The three brass plates forming a T-shaped girder are adjusted and locked in position by a set of three leveling screws at each end; the right-hand upper one is omitted in figure 4. The plates, Z Z, serve to protect the rays completely from any stray electric field, even that caused by the photographic plate itself becoming charged, until within a few millimeters of their point of impact.

The photographic plate W, which is a 2-centimeter strip cut lengthwise from a 5 by 4 plate, is supported at its ends on two narrow transverse rails which raise it just clear of the plate, X X. Normally it lies to the right of the slot as indicated, and to make an exposure it is moved parallel to itself over the slot by means of a sort of double lazy tongs carrying wire claws, which bracket the ends of the plate as shown. This mechanism, which is not shown in detail, is operated by means of a torque rod V working through a ground glass joint. Y is a small willemite screen.

The adjustment of the plate holder so that the sensitized surface should be at the best focal plane was done by taking a series of exposures of the bright hydrogen lines with different magnetic fields, on a large plate placed in the empty camera at a small inclination to the vertical. On developing this the actual track of the rays could be seen and the locus of points of maximum concentration determined. The final adjustment was made by trial and error and was exceedingly tedious, as air had to be admitted and a new plate inserted after each tentative small alteration of the leveling screws.

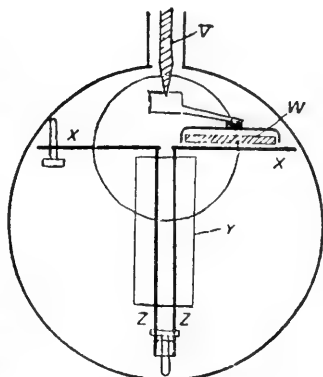

FIG. 4.—The camera.

EXPERIMENTAL PROCEDURE.

The plate having been dried in a high vacuum over night, the whole apparatus is exhausted as completely as possible by the pump, with the stopcock L open. I_1 and I_2 are then cut off from the pump by stopcocks and immersed in liquid air for an hour or so. The electric field, which may range from 200 to 500 volts, is then applied and a small current passed through the magnet sufficient to bring the bright hydrogen molecule spot onto the willemite screen Y, where

it can be inspected through the plate-glass back of the cap P. In the meantime the leak, pump, and coil have all been started to get the bulb into the desired state.

As soon as this is obtained and has become steady, J_1 is earthed to prevent any rays reaching the camera when the plate is moved over the slot to its first position, which is judged by inspection through P with a nonactinic lamp. The magnet current having been set to the particular value desired and the diaphragm adjusted, the coil is momentarily interrupted while J_1 is raised to the desired potential, after which the exposure starts. During this, preferably both at the beginning and the end, light from a lamp T is admitted for a few seconds down the tube R (fig. 2), the ends of which are pierced with two tiny circular holes. The lower hole is very close to the plate, so that a circular dot or register spot is formed from which the measurements of the lines may be made.

The exposures may range from 20 seconds in the case of hydrogen lines to 30 minutes or more, 15 minutes being usually enough. As soon as it is complete the above procedure is repeated, and the plate moved into the second position. In this way as many as six spectra can be taken on one plate, after which L is shut, I_2 warmed up, and air admitted to the camera. The cap P, which is on a ground joint, can now be removed and the exposed plate seized and taken out with a special pair of forceps. A fresh plate is now immediately put in, P replaced, and the camera again exhausted, in which state it is left till the next operation. * * * The accuracy claimed for the instrument is about one part in a thousand.

ORDER OF RESULTS AND NOMENCLATURE.

The various elements studied will be considered as far as possible in the order in which the experiments were performed. This order is of considerable importance, as in most cases it was impossible to eliminate any element used before the following one was introduced. Evacuation and washing have little effect, as the gases appear to get embedded in the surface of the discharge bulb and are only released very gradually by subsequent discharge.

The problem of nomenclature became serious when the very complex nature of the heavy elements was apparent. After several possible systems had been discussed it was decided, for the present, to adopt the rather clumsy but definite and elastic one of using the chemical symbol of the mixed element with an index corresponding to its mass—e. g., Ne^{22} , Kr^{84} . This system is made reasonable by the fact that the masses of constituents of mixed elements have all so far proved whole numbers on the scale used.

In cases of particles carrying more than one charge it will be convenient to borrow the nomenclature of optics and refer to the lines

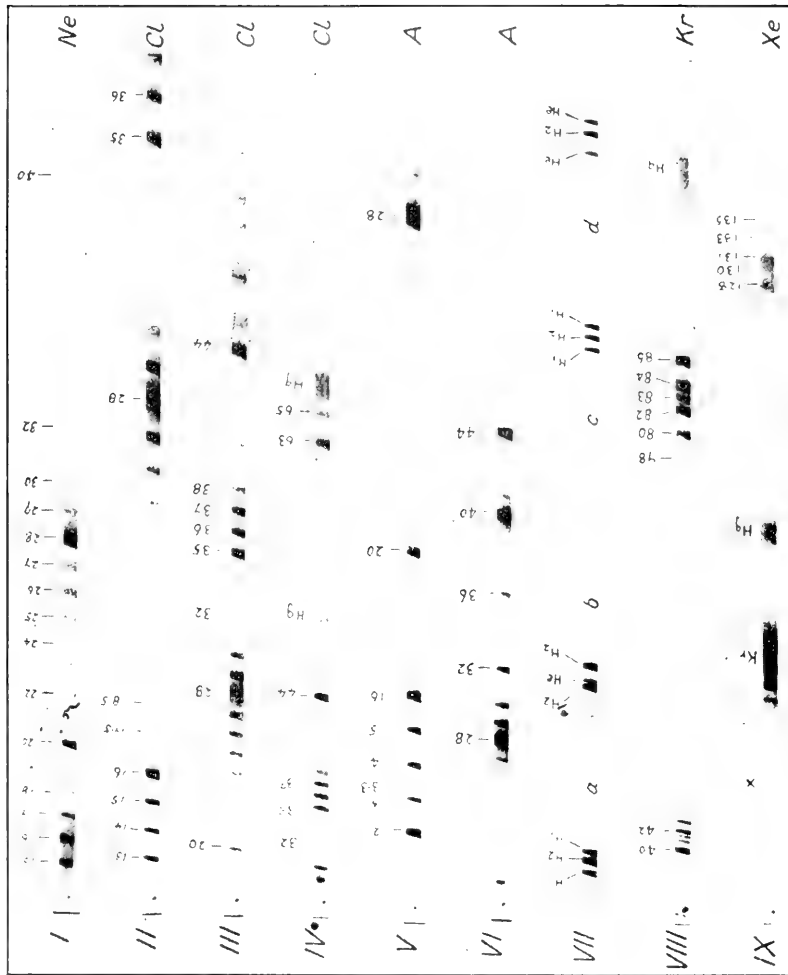

MASS SPECTRA OF VARIOUS CHEMICAL ELEMENTS.

given by singly, doubly, and multiply charged particles, respectively, as lines of the first, second, and higher orders. Thus the molecule of oxygen gives a first order line at 32, and its atom first and second order lines at 16 and 8.

The empirical rule that molecules only give first-order lines (J. J. Thomson, *Rays of Positive Electricity*, p. 54) is very useful in helping to differentiate between elementary atoms and compound molecules of the same mass. Some very recent results give indications that in certain exceptional cases it may break down, so that inferences made from it must not be taken as being absolutely conclusive.

OXYGEN (AT. WT. 16.00) AND CARBON (AT. WT. 12.00).

On a mass spectrum all measurements are relative, and so any known element could be taken as a standard. Oxygen is naturally selected. Its molecule, singly-charged atom, and doubly-charged atom give reference lines at 32, 16, and 8, respectively. The extremely exact integral relation between the atomic weights of oxygen and carbon is itself strong evidence that both are "pure" elements, and so far no evidence appears to have arisen to throw any doubt on this point. Direct comparison of the C line (12) and the CO line (28) with the above standards shows that the expected whole number relation and additive law hold to the limit of accuracy, i. e., one part in a thousand; and this provides standards C^{++} (6), C (12), CO (28), and CO_2 (44). In a similar manner, hydrocarbons give the C_1 and C_2 groups already mentioned (*Phil. Mag.*, April, 1920, pp. 452, 453) so that a fairly complete scale of reference is immediately available.

NEON (AT. WT. 20.20).

The results obtained with this gas have already been fully dealt with (*Phil. Mag.*, April, 1920, p. 449). It has been shown to consist of two isotopes of masses 20 and 22, respectively, with the faint possibility of a third of mass 21. Spectrum I on plate 1 shows the singly charged lines of neon, to the left of the C_2 group. It is reproduced here to show the condition of the discharge tube immediately before compounds of chlorine were introduced.

CHLORINE (AT. WT. 35.46).

Spectra, indicating that this element was a mixture of isotopes, were first obtained by the use of hydrochloric acid gas, but as this was objectionable, on account of its action on mercury, phosgene ($COCl_2$) was substituted. Spectra II, III, and IV are reproduced from one of the plates taken with this gas. It will be seen that

chlorine is characterized by the appearance of four very definite lines in the previously unoccupied space to the right of O_2 (32): Measurement shows these lines to correspond exactly to masses 35, 36, 37, and 38. *There is no indication whatever of a line at a point corresponding with the accepted atomic weight of 35.46.* On Spectrum II, taken with a small magnetic field, faint lines will be seen at 17.5 and 18.5. These only appeared when chlorine was introduced, and are certainly second-order lines corresponding to 35 and 37. These figures seem to leave no possible escape from the conclusion that chlorine is a mixture of isotopes and that two of these have masses 35 and 37. It might be argued that 36 and 38 are also elementary lines, and at present there is no evidence to deny this, but it is much more probable that they are the hydrochloric acids HCl^{35} and HCl^{37} . The line 18 is no indication of an element 36, as it is doubtless due to OH_2 . Corroborative evidence that Cl^{35} and Cl^{37} are the main, if not the only, constituents is given by the strong lines 63 and 65 (Spectrum IV), probably due to $COCl^{35}$ and $COCl^{37}$. If chemical atomic weight is regarded as a statistical average, any lines due to Cl^{35} or its compounds should be considerably stronger than the corresponding one due to Cl^{37} . This is actually found to be the case. In all spectra taken with chlorine present a faint line is distinguishable, corresponding to 39. It is just possible that this is a third isotope.

The unquestionable accuracy of its combining weight on the one hand, and the striking whole-number masses given on its mass spectra by its individual particles on the other, leave little doubt that chlorine is a mixed element; but much critical work will be necessary before its constituents and their relative proportions are decided with certainty.

ARGON (AT. WT. 39.88 RAMSAY, 39.91 LEDUC).

At the close of the experiments with phosgene the discharge tube broke down and had to be cleaned and partially rebuilt, so that by the time it had reached suitable working conditions again, all traces of chlorine had disappeared. The tube was run with a mixture of CO_2 and CH_4 , and then about 20 per cent of argon added. The main constituent of the element was at once evident from a very strong line at 40 (Spectrum VI), reproduced in the second and third orders at 20 and 13.33 (Spectrum V). The third-order line is exceedingly well placed for measurement, and from it the mass of the singly charged atom is found to be $40.00 \pm .02$. At first this was thought to be the only constituent, but later a faint companion was seen at 36, which further spectra showed to bear a very definite intensity relation to the 40 line. No evidence drawn from multiple charges is

available in this case, owing to the probable presence of OH_2 and C; but the above intensity relation and the absence of the line from spectra, taken just before argon was introduced, make it extremely likely that it is a true isotope. The presence of about 3 per cent would account for the fractional atomic weight determined from the density.

NITROGEN (AT. WT. 14.01).

This element shows no abnormal characteristics; its atom can not be distinguished, on the present apparatus, from CH_2 , nor its molecule from CO. Its second-order line, on careful measurement, appears to be exactly 7, so it is evidently a pure element, as its chemical combining weight would lead one to expect.

HYDROGEN (AT. WT. 1.008) AND HELIUM (AT. WT. 3.99).

The determination of masses so far removed as these from the reference lines offers peculiar difficulties, but as the lines were expected to approximate to the terms of the geometrical progression 1, 2, 4, 8, etc., the higher terms of which are known, a special method was adopted by which a two to one relation could be tested with some exactness. Two sets of accumulators were selected, each giving very nearly the same potential of about 250 volts. The potentials were then made exactly equal by means of a subsidiary cell and a current-divider, the equality being tested to well within 1 in 1,000 by means of a null instrument. If exposures are made with such potentials applied to the electric plates first in parallel and then in series, the magnetic field being kept constant, all masses having an exact 2 to 1 relation will be brought into coincidence on the plate. (Phil. Mag., April, 1920, p. 453.) Such coincidences can not be detected on the same spectrum photographically; but if we first add and then subtract a small potential from one of the large potentials, two lines will be obtained which closely bracket the third. To take an actual instance—with a constant current in the magnet of 0.2 ampere, three exposures were made with a gas containing hydrogen and helium at potentials of 250, 500+12, and 500-12 volts, respectively. The hydrogen molecule line was found symmetrically bracketed by a pair of atomic lines (Spectrum VII *a* and *c*), showing that the mass of the molecule is exactly double the mass of the atom within experimental error. When after a suitable increase of the magnetic field the same procedure was applied to the helium line and that of the hydrogen molecule, the bracket was no longer symmetrical (Spectrum VII, *b*), nor was it when the hydrogen molecule was bracketed by two helium lines (*d*). Both results show in an unmistakable manner that the mass of He is less than twice that of H_2 .

In the same way He was compared with O^{++} , and H_3 , obtained from KOH by Sir J. J. Thomson's bombardment method, with C^{++} .

The method has some definite advantages and some disadvantages. It is not proposed to discuss these in detail at present. The values obtained by its use can be checked in the ordinary way by comparing He with C^{++} and H_3 with He, these pairs being close enough together for the purpose. The following table gives the range of values obtained from the most reliable plates:

Line.	Method.	Mass assumed.	Mass deduced.
He.....	{Bracket.....	$O^{++}=8$	3.994-3.996
	{Direct.....	$C^{++}=6$	4.005-4.010
H_3	{Bracket.....	$C^{++}=6$	3.025-3.027
	{Direct.....	He =4.....	3.021-3.030
H_2	Bracket.....	He =4.....	2.012-2.018

From these figures it is safe to conclude that hydrogen is a "pure" element and that its atomic weight, determined with such consistency and accuracy by chemical methods (1.008), is the true mass of its atom.

The above results incidentally appear to settle the nature of the molecule H_3 beyond doubt.

KRYPTON (AT. WT. 82.92) AND XENON (AT. WT. 130.2).

The results with these elements were particularly interesting. The only source available, for which the author is indebted to Sir J. J. Thomson, was the remains of two small samples of gas from evaporated liquid air kindly supplied by Sir James Dewar some years ago for examination by the "parabola" method. Both samples contained nitrogen, oxygen, argon, and krypton, but xenon was only detected in one and its percentage in that must have been quite minute. Krypton is characterized by a remarkable group of five strong lines at 80, 82, 83, 84, 86, and a faint sixth at 78. This group or cluster of isotopes is beautifully reproduced with the same relative values of intensity in the second, and fainter still in the third order. These multiply-charged clusters give most reliable values of mass, as the second order can be compared with A (40) and the third with CO or N_2 (28) with the highest accuracy. It will be noted that one member of each group is obliterated by the reference line, but not the same one. The singly and doubly charged krypton clusters can be seen to the right and left of Spectrum VIII. It will be noticed that krypton is the first element examined which shows unmistakable isotopes differing by one unit only.

On the krypton plates taken with the greatest magnetic field faint but unmistakable indications of lines in the region of 130 could just

be detected. The richest sample was therefore fractionated over liquid air, and the last fraction, a few cubic millimeters, was just sufficient to produce the xenon lines in an unmistakable manner. These can be seen on Spectrum IX, but are somewhat fuzzy owing to the wide diaphragm used to get maximum intensity. They are apparently five in number and appear to follow the integer rule. Until pure xenon is available no final figures can be given, but the values may be taken provisionally as 128, 130, 131, 133, and 135.

MERCURY (AT. WT. 200.6).

Owing to the presence of mercury vapor (which is generally beneficial to the smooth running of the discharge) the multiply-charged particles of this element appear on nearly all the plates taken. They appear as a series of blurred clusters of decreasing intensity around points corresponding to 200, 100, 66.6, 50 * * * etc., some of which are indicated in the spectra reproduced. It may be stated provisionally that they indicate a strong component 202, a weak one 204, and a strong band from 197 to 200 containing three or four more unresolvable at present.

Table of results obtained to December, 1920.

Element.	Symbol.	Atomic number.	Atomic weight.	Minimum number of isotopes.	Masses of isotopes in order of their intensity.
Hydrogen.....	H.....	1	1.008	1	1.008.
Helium.....	He.....	2	3.990	1	4.
Boron.....	B.....	5	10.900	2	11, 10.
Carbon.....	C.....	6	12.000	1	12.
Nitrogen.....	N.....	7	14.010	1	14.
Oxygen.....	O.....	8	16.000	1	16.
Fluorine.....	F.....	9	19.000	1	19.
Neon.....	Ne.....	10	20.200	2	20, 22 (21).
Silicon.....	Si.....	14	28.300	2	28, 29 (30).
Phosphorus.....	P.....	15	31.040	1	31.
Sulphur.....	S.....	16	32.060	1	32.
Chlorine.....	Cl.....	17	35.460	2	35, 37 (39).
Argon.....	A.....	18	39.880	2	40, 36.
Arsenic.....	As.....	33	74.960	1	75.
Bromine.....	Br.....	35	79.920	2	79, 81.
Krypton.....	Kr.....	36	82.920	6	84, 86, 82, 83, 80, 78.
Iodine.....	I.....	53	126.920	1	127.
Xenon.....	X.....	54	130.320	5, (7)	129, 132, 131, 134, 136 (128, 130z).
Mercury.....	Hg.....	80	200.600	(6)	(197-200), 202, 204.

(Numbers in parentheses are provisional only.)

THE WHOLE-NUMBER RULE.

The most important generalization yielded by these experiments is the remarkable fact that (with the exception of H_1 , H_2 , and H_3) all masses, atomic or molecular, element or compound, so far measured, are whole numbers within the accuracy of experiment. It is naturally premature to state that this relation is true for all elements,

but the number and variety of those already exhibiting it makes the probability of this extremely high.

On the other hand, it must not be supposed that this would imply that the whole-number rule holds with mathematical exactness, but only that the approximation is of a higher order than that exhibited by the ordinary chemical combining weights and is quite close enough to allow of a theory of atomic structure far simpler than those put forward in the past; for such theories were forced to attempt the explanation of fractions which now appear to be merely fortuitous statistical effects, due to the relative quantities of the isotopic constituents.

Thus, one may now suppose that an elementary atom of mass m may be changed to one of mass $m+1$ by the addition of a positive particle and an electron. If both enter the nucleus, an isotope results, for the nuclear charge is unaltered. If the positive particle only enters the nucleus, an element of next higher atomic number is formed. In cases where both forms of addition give a stable configuration the two elements will be isobares.

The electromagnetic theory of mass asserts that mass is not generally additive, but only becomes so when the charges are relatively distant from each other. This is certainly the case when the molecules H_2 and H_3 are formed from H_1 , so that their masses will be two and three times the mass of H_1 with great exactness. (It must be remembered here that the masses given by these experiments are those of positively charged particles, H_1 being presumably a single particle of positive electricity itself, and that the mass of an electron on the scale used is 0.00054, and too small to affect the results.)

In the case of helium, the standard oxygen, and all other elements, this is no longer the case; for the nuclei of these are composed of particles and electrons packed exceedingly close together. The mass of these structures will not be exactly the sum of the masses of their constituents, but probably less, so that the unit of mass on the scale chosen will be less than that of a single hydrogen atom.

VITAMINS.¹

By W. D. HALLIBURTON,
London, Kings College, Physiological Laboratory.

The word "vitamin" is not as old as the present century, and though it is not altogether a satisfactory term, it has obtained a permanent footing in scientific and medical literature. The expression "accessory food factor," which has been suggested as a substitute, is certainly more cumbersome. But, after all, it is a matter of small moment what word is used; the important point is what it connotes.

It is a matter of everyday physiological knowledge that our bodies are built out of proteins, fats, carbohydrates, salts, and water, and these substances must be present in the food in certain proportions and in sufficient quantities to repair the body waste and furnish the energy necessary for its activities. But recent research has shown that these substances alone are incapable of maintaining life. Something else is required, the chemical nature of which is at present unknown, and it is to these unknown but indispensable accessory substances that the term "vitamins" has been applied.

Prof. F. G. Hopkins, of Cambridge, a pioneer in this branch of research, has suggested a useful simile to help us to understand the problem. He compares the building of the body to the building of a house. The essential bricks or blocks of stone of which the walls of the house are composed would be of comparatively little use unless cement were also supplied to unite these components together, and it is the cementing material which he compares to the vitamins. It would be dangerous to press such an analogy too far, for the exact rôle of the vitamins is still hidden from us. But the simile is a useful one to indicate one way at least in which they can render the important building stones of real service, and it is accurate in a quantitative sense. The cement in the walls of a house makes up but a small proportion of the structure. It is exactly the same in the case

¹ Reprinted by permission from "Scientia," vol. XXVII. 1920.

of the vitamins. They bear but a small proportion to the total food supply. When they are withheld from the food, as when chemically pure proteins, fats, carbohydrates, salts, and water are administered, health deteriorates, and in young animals growth ceases, and if the diet is continued death is the inevitable result. Health can be at once reestablished if the diet is amplified by adding to it a natural food, such as a small amount of milk, for foods as they occur in nature contain the accessory factors necessary for growth and maintenance. This consideration is of practical importance to the public generally; so many are the treated, "purified," and sophisticated foods at present on the market that it is most important to the dietitian to remember that these are but poor substitutes for the foods which are made in nature's laboratory.

Although biochemists have not yet got so far as to be able to state what is the chemical structure of these vitamins, research has at any rate progressed far enough to make it certain that they are numerous, and it is around three that research has mainly centered. They are products of the plant world, and it is on plants that all animals ultimately live. Animals have greater synthetic powers than were formerly believed to be the case, but so far as is at present known they are not able to synthesize or manufacture vitamins.

The vitamins can be separated by their varying solubilities in water and other agents, and can be distinguished by their varying powers of resistance to heat and other drastic agencies, and further they are differently distributed in various parts of the vegetable world. Their absence prevents healthy growth and leads to death, but the symptoms manifested are different in the three cases. The diseases due to their absence are very conveniently grouped together as "deficiency diseases." Among such diseases are beriberi, and coming nearer home, scurvy and rickets.

The first of these vitamins is contained in the embryo or germ of cereal seeds. When milling is carried to a high degree this portion of the grain is removed—hence, polished rice, and superfine white wheat flour, though they may appeal to the æsthetic sense, are of inferior value as foods. It is now firmly established that beriberi, the disease of the rice-eating nations, is due to the use of polished rice, and can be prevented or cured by adding the polishings to the diet. Polished rice produces the disease not because it contains a poison, but because it lacks the vitamin. Using the noncommittal nomenclature introduced by American physiologists, it is now usual to speak of this vitamin, on account of its solubility in water, as "Water Soluble B."

The second is contained in the majority of animal fats (commercial lard is an exception), and is particularly abundant in milk fats and in certain fish oils, such as cod-liver oil. It is specially important as a

growth factor, and therefore indispensable in early life. It is absent in most vegetable fats. Here we have one indication of the value of milk for the young, an explanation of the potency of cod-liver oil in curing malnutrition, and a warning of the danger of vegetable margarines if employed as the only source of fat in the food of the growing section of the population or of expectant mothers. It is usual to call this vitamin "Fat Soluble A." There is accumulating evidence to show that its absence or deficiency is an etiological factor in rickets. Like its water-soluble companion, it is ultimately a vegetable product, being contained in high concentration in the green portions of plants. It is because the cow lives on grass that her milk contains the vitamin. In expectant mothers, either milk itself or green vegetables should form important constituents of their diet, but in the feeding of infants green vegetables are for other reasons not suitable, so that in times of stress and shortage children must be provided with milk even if everyone else has to be content with little or none. In the adult the need for "Fat Soluble A" is not so great as in the child, but it has been established that small quantities are necessary, especially in periods where excessive work leads to a greater demand for nutritive principles, for instance, in our fighting forces on active service.

The third vitamin is also soluble in water, and as Doctor Drummond suggests it may be called "Water Soluble C." This is the anti-scorbutic principle, and is found in the juices of fruits (the orange and lemon are here preeminent) and in most edible vegetables. Among a seagoing people like the English, scurvy was but too familiar in the past, and in the sixteenth and seventeenth centuries it was a dread and terrible scourge. The remedy, fresh meat and vegetables, was well known, but no means existed then for providing ships with these desirable commodities on their slow and protracted voyages. Scurvy also was common among the civilian population, owing no doubt to the scanty allowance of meat and especially of green vegetables available for the poorer classes. Thanks to the increased rapidity of transport and the improved facilities for the provision of fresh vegetables and fruit, adult scurvy has become much less familiar in our days, except in cases of long-continued absence from centers of civilization, such as arise in polar expeditions or under the strenuous conditions of modern warfare. In more recent times the failure of the potato crop in Ireland in 1847 was followed by outbursts of scurvy, as was also the case in Norway in 1904, and the recent failure of the fruit crop in 1917 was marked by outbreaks in Glasgow, Manchester, and Newcastle. In time of war scurvy frequently occurs, and numerous instances of this have occurred during the past four years, for example at Kut during the siege. In fact, a considerable proportion of the population are never far removed

from the safety line, and this is especially the case with artificially fed children, and scurvy, incipient or declared, is an ever-present danger, especially in the first years of life. This vitamin is characterized by its extreme lability, being destroyed by moderately high temperatures in the presence of oxygen, treatment with alkali, by desiccation, canning processes, and the like. The effect of cooking on the antiscorbutic vitamin seriously diminishes the amount present. But the discovery has been made, and proved invaluable during the last war, that canned cereals recover their antiscorbutic potency by being allowed to germinate. The high value of various citrus fruits has long been appreciated, and for the last century and a quarter reliance has been placed in the Navy and mercantile marine on lime juice as a preventive. Here the researches of Miss Chick and her colleagues on the experimental, and Mrs. Henderson Smith on the historical, side have revealed a very curious state of affairs. Modern lime juice is made from the West Indian lime, whereas the lime juice of the past was made either from the lemon or the sweet lime of Mediterranean countries. This juice was highly potent, and it was by its use that the Navy was freed from the terrible scourge which had previously devastated it. Curiously enough, although the sour lime of the West Indies is such a near relation botanically of the lemon, its value as an antiscorbutic is almost negligible. Prominent among the antiscorbutics upon which reliance was placed by old-time seamen were beer and infusion of malt, as will be familiar to the reader of Captain Cook's Voyages, but an investigation of modern beers and of the malt from which they are prepared has shown that they are deficient in the antiscorbutic factor. The difference between the old and modern beer is no doubt due to the high temperature employed in various steps of the manufacture of the latter.

It will thus be seen that the subject of vitamins is of the highest importance, but we must remember that it is at present in its infancy. It is, perhaps, not going too far to state that the conception bids fair to have as far-reaching results as those which have followed the study of internal secretions and hormones.

To label a disease by a specific name—beriberi, rickets, etc.—and to fathom its cause and lead up to a rational and successful treatment of the same is no mean accomplishment, but there are many ailments to which it is impossible to give a name, so vague and puzzling are the symptoms they exhibit. It is probable that many so-called minor conditions of malnutrition may be due to lack of vitamins or to a deficiency in their supply.

Although at present three vitamins have been brought into the light of investigation, who can say that the list is complete? It is more than probable that obscure and apparently trivial complaints

may in the future be found to be deficiency diseases. An obvious state of malnutrition in an infant may pass away, and yet it may leave its mark behind it and cause far-reaching results later in life. Take, for example, that curse of modern days, dental caries. Already, as Mrs. Mellanby has shown, there are signs that this is just such a condition, and that its cause is probably a deficiency (earlier in life) of a proper vitamin supply. Happily, many workers are taking up the subject and exploring the numerous by-paths that the main idea has opened up.

Important work of this nature is that by Lieut. Col. R. McCarrison, and his paper has appeared in last year's January number of the *Indian Journal of Medical Research*. The disease in particular which he dealt with is beriberi, a complaint which can be produced easily in birds by withholding water-soluble B, or, in other words, by feeding upon highly milled cereal grains. So far, the nervous symptoms of this disease, spoken of as "neuritic," have attracted most attention, but McCarrison has shown that the condition is more than a functional and degenerative condition of the nervous system; that it is one in which practically every organ and tissue of the body is involved. The organs of digestion and assimilation are particularly affected, and thus many of the symptoms are due to the chronic inanition so produced. The lowered vitality then renders the body an easy prey to infectious and parasitic agents, and thus other symptoms become explicable. Among the many remarkable results chronicled is that while the adrenals hypertrophy, there are other organs which atrophy, and in order of severity these are the thymus, testes, spleen, ovary, pancreas, heart, liver, kidneys, stomach, thyroid, and the brain least. It therefore appears that the organs which atrophy provide a reserve of vitamins for use in periods of stress, but that the reserve is soon exhausted.

One disease, namely, pellagra, I have not mentioned, and it is of particular interest to Italians. Conflicting views are at present held as to its causation, many regarding it as an infectious ailment, whereas others look upon it as a deficiency disease. It is the condition which follows the effects of maize feeding. The maize protein, as is well known, is an imperfect one, and lacks many of the important amino-acids which are needed for tissue building. It may be that the deficiency is in the protein. Still it is quite possible that here also we may have to deal with the lack of a specific vitamin. This view at any rate has been taken by Rondoni, who has published a recent paper in the *British Medical Journal*, 1919, I, page 542, in which he compares his experimental results on guinea pigs with those of McCarrison on birds. Here also there is an enlargement of the adrenals and an atrophy of certain other organs. Rondoni points

out that these results of his were published some years ago in an Italian journal, but have been overlooked by those in this country. One can only hope that in the future, in view of the friendship between the countries now cemented on the recent battlefields, that such accidents will not occur again.

The foregoing article has dealt only with the outline and with the more recent work upon a subject of large and increasing importance. The field is a fruitful one, and one can only trust that with fresh spade work by other workers our knowledge in this direction may be amplified and thus rendered of even greater benefit to mankind.

SOIL ACIDITY—ITS NATURE, MEASUREMENT, AND RELATION TO PLANT DISTRIBUTION.¹

By EDGAR T. WHERRY,
United States Bureau of Chemistry.

[With 2 plates.]

INTRODUCTION.

The studies described in the essays of which abstracts are here brought together belong in a border-line class between well-defined sciences; they represent the application of certain principles and methods of chemistry, of physics, and of geology, to the solution of problems in botany, in plant ecology, and incidentally in horticulture. It has been the aim of the writer to sum up in relatively simple language the principles of physical chemistry which bear on soil acidity; to develop a method for measuring soil acidity in the field; and to apply this method to the study of the distribution and the cultivation of native plants.

SOIL ACIDITY.²

According to the almost universally accepted electrolytic-dissociation or ionization theory, many chemical compounds, under certain conditions, exhibit dissociation into electrically charged portions, known as *ions*. These may consist of single atoms or of groups of atoms. Only ionization connected with the dissolving of substances in water need concern us here. Compounds differ widely in the extent to which they are dissociated or ionized in dilute aqueous solution. Among inorganic compounds—acids, bases, and salts—many are almost completely, others only partially, ionized. Of organic compounds a few, especially acids, are markedly, a considerable number slightly, and many not appreciably ionized.

Water itself dissociates into *hydrogen-ion*, made up of positively charged hydrogen atoms, and accordingly symbolized by H^+ ; and *hydroxyl-ion*, made up of negatively charged hydroxyl (hydrogen

¹ The field work on which these essays are based has been carried on largely at the writer's own expense, during vacation periods, but funds for certain of the trips were obtained from the Bureau of Plant Industry, through Mr. Frederick V. Coville, botanist of the Department of Agriculture. It is a pleasure to acknowledge herewith the aid received in the preparation of these papers from Mr. Coville, Dr. E. Q. Adams of the Bureau of Chemistry, and other colleagues.

² Abstracted from an essay entitled "Soil acidity and a field method for its measurement." *Ecology*, 1, 160-173, 1920.

plus oxygen) groups, symbolized by $(OH)^-$. Acids yield hydrogen-ion and another ion consisting of the balance of their constituents; thus from nitric acid, HNO_3 , arise H^+ and $(NO_3)^-$, the latter being termed nitrate-ion. Alkalies yield hydroxyl-ion and another consisting of the remainder of the compounds; in potassium hydroxide, KOH , the ions are $(OH)^-$ and potassium-ion, K^+ .

The amount of hydrogen-ion present in a solution, expressed as gram equivalents per liter, is often referred to as the *hydrogen-ion concentration*.

The water existing in soils, as a film around the solid soil particles, does not differ essentially from free water in the above respects. Substances can dissolve in it, undergo ionization, and give rise to a definite hydrogen-ion concentration of the soil. This is what is meant by the term "soil acidity."

Observation has shown that the properties of substances which lead to their classification as acids are directly connected with the presence of hydrogen-ion in their solutions. The characteristic sour taste—from which the term acid was of course originally derived—is in considerable part the taste of hydrogen-ion.³ Reddening of blue litmus, the most widely known test for acidity, is produced by hydrogen-ion. And it is hydrogen-ion which takes part in most of the chemical changes into which acids enter.

The inhibiting effect of acids on the growth of many bacteria, and the favorable effect they show toward the growth of some molds and fungi, are hydrogen-ion phenomena. There is every reason to suppose that the action of acids on higher organisms, such as the flowering plants, is identical in origin. It is evident from these considerations that the hydrogen-ion concentration is a highly important feature of the solution of any acid substance.

The difference between hydrogen-ion concentration and quantity of acid in the case of two typical acids is here tabulated. The numerical values given are only approximate.

TABLE 1.—Difference between hydrogen-ion concentration and quantity of acid in normal solutions of two acids.

	Acid.	
	Hydrochloric.	Formic.
Formula.....	HCl.	$H(CHO_2)$.
Molecular weight=equivalent weight=grams per liter in normal (molar) solution.....	36.5	46.0
Quantity of acidic hydrogen, grams per liter.....	1	1
Physicochemical class.....	Strong.	Weak.
Per cent to which ionized.....	75	1
Corresponding hydrogen-ion concentration, grams per liter.....	0.75	0.01
Specific acidity ^a	7,500,000	100,000

^a This method of stating acidity has been explained in: The statement of acidity and alkalinity, with special reference to soils, Journ. Wash. Acad. Sci., 9, 305-309, 1919.

³ Harvey, R. B., Journ. Amer. Chem. Soc., 42, 712, 1920.

Table 1 shows that although a normal (molar) solution of both acids contains the same quantity of acidic hydrogen, the strong acid yields seventy-five times as much hydrogen-ion as does the moderately weak one, and may be expected to have seventy-five times as much effect in the directions listed in the preceding paragraph.

The situation is analogous to that of two men, both possessing \$100, but one having \$25 in a savings bank and \$75 in his pocket, the other having \$99 and \$1 in these respective places. The first man can purchase seventy-five times the amount of any commodity that the second can, even though the total quantity of money they own is the same. Purchasing power, in this illustration, corresponds exactly to hydrogen-ion concentration; for the amount of hydrogen which is ionized, not the total amount, determines most of the things an acid can do.

Several different methods of stating acidity are in use, and in Table 2 the way two values selected at random appear under all of them is brought out; and the reader may judge whether the one chosen for use in the present paper (the last one tabulated, specific acidity) is not the best from the point of view of clearness and convenience. The hydrogen-ion concentrations of the two solutions, in gram equivalents per liter, are 0.0004 and 0.0000002, respectively, the former representing two thousand times as much hydrogen-ion as the latter.

TABLE 2.—Comparison of methods of stating acidity (hydrogen-ion).

	Solution 1.	Solution 2.
Starting at normality:		
Concentration—		
Actual number.....	0.0004	0.0000002
Power of 10 with a coefficient.....	0.4×10^{-3}	0.2×10^{-6}
Power of 10.....	$10^{-3.4}$	$10^{-6.7}$
Potential due to H^+ (P_H).....	3.4	6.7
Starting at neutrality:		
Chemical potential, X_H	3.6	0.3
Concentration—		
Power of 10.....	$10^{3.6}$	$10^{0.3}$
Actual number (specific acidity).....	4,000	2

The method illustrated in the last line of Table 2 obviously shows with a minimum of calculation on the part of the reader that one of the solutions is two thousand times as acid as the other; and it gives directly the information that the hydrogen-ion concentration is in the one case four thousand times, in the other case twice, that of pure water.

As the P_H method is rather widely used in the statement of hydrogen-ion concentration, however, it seems desirable that another table be given showing the relations between P_H values and specific acidities (and alkalinities) over the range covered by dilute aqueous solutions.

TABLE 3.—*Specific acidity and alkalinity equivalents of P_H values.*

P _H	X _H	Specific acidity.	P _H	X _H	Specific alkalinity.
6.0	1.0	10 (10.00)	7.0	0.0	1 (1.00)
6.1	0.9	8 (7.94)	7.1	-0.1	1.3 (1.26)
6.2	0.8	6 (6.31)	7.2	-0.2	1.5 (1.58)
6.3	0.7	5 (5.01)	7.3	-0.3	2 (2.00)
6.4	0.6	4 (3.98)	7.4	-0.4	2.5 (2.51)
6.5	0.5	3 (3.16)	7.5	-0.5	3 (3.16)
6.6	0.4	2.5 (2.51)	7.6	-0.6	4 (3.98)
6.7	0.3	2 (2.00)	7.7	-0.7	5 (5.01)
6.8	0.2	1.5 (1.58)	7.8	-0.8	6 (6.31)
6.9	0.1	1.3 (1.26)	7.9	-0.9	8 (7.94)
7.0	0.0	1 (1.00)	8.0	-1.0	10 (10.00)

(For each lower P_H unit, multiply the specific acidity by 10)

(For each higher P_H unit, multiply the specific alkalinity by 10)

The substances which may yield hydrogen-ion to the soil solution are listed in the following table:

TABLE 4.—*Soil constituents yielding hydrogen-ion.*1. *Directly (when treated with water alone):*A. *Inorganic.*

- (a) Strong, highly ionized acids, like hydrochloric, sulphuric, etc.
- (b) Weak, slightly ionized acids, especially carbonic.
- (c) Acid salts, like potassium acid sulphate, which may be moderately or slightly ionized (as acids).
- (d) Salts of weak bases with strong acids, like aluminium chloride, ammonium sulphate, etc., which are slightly hydrolyzed, and therefore yield a small amount of hydrogen-ion.

B. *Organic.*

- (a) Strong, highly ionized acids, like oxalic.
- (b) Weak, slightly ionized acids, like acetic.
- (c) Acid salts, like potassium acid oxalate, which may be moderately or slightly ionized (as acids).
- (d) Salts of weak bases with strong acids, like aluminium citrate, ammonium oxalate, etc., which are hydrolyzed, as in A (d).
- (e) Amino acids, like aspartic (aminosuccinic) acid, which are internal salts in the sense that the acidity is neutralized by the amino group, and which may be moderately or slightly ionized.
- (f) Humic acids, which, if they exist at all, are slightly ionized.

2. *Indirectly (when treated with solutions of salts):*A. *Inorganic, especially colloidal clay.*B. *Organic, especially colloidal humus.*

From the above tabulation it is evident that soil acidity is likely to be a rather complex phenomenon, and it is certainly misleading for an investigator to look to any single substance or type of substances as the source of the hydrogen-ion producing it in all cases. It seems probable, however, that comparatively few of these possible sources of hydrogen-ion, and accordingly of acidity, coexist in appreciable amounts in any one soil.

It is desirable to tabulate next the methods which have been suggested for measuring soil acidity, in more or less chronological sequence, bringing together related ones.

TABLE 5.—*Methods of measuring acidity present and producible in soils.*

1. A salt solution is added to the soil; for this purpose there have been used sodium chloride, potassium chloride and nitrate, calcium chloride, nitrate and acetate, zinc sulphide plus calcium chloride, etc. The quantity of acid in the resulting solution, which represents that originally present in the soil plus a much greater amount produced indirectly by the processes outlined on a previous page, is then determined by titration or other means.
2. No salt solution but some pure water is added to the soil.
 - A. The mixture is titrated with lime water, using either an indicator or observation of the freezing point to determine the end point. This gives the amount of lime needed to neutralize the acid originally present in the soil plus that produced indirectly by the action of lime (which is likely to differ from that produced by a neutral salt solution), as well as the amount of lime required to satisfy the adsorptive power of the soil colloids for calcium-ion under the given conditions.
 - B. The mixture is filtered and the filtrate titrated with standard alkali. This gives the quantity of acid present in the soil.
 - C. The hydrogen-ion concentration or specific acidity is determined:
 - (a) By catalysis of an ester.
 - (b) By measurement of the potential due to hydrogen-ion with the potentiometer.
 - (c) By observation of color changes of indicators whose relations to hydrogen-ion concentration are known.

The methods listed under 1 in Table 5 are *not* methods of determining the acidity originally present in a soil. The results they yield are composite, representing both acid originally present and a usually greater quantity produced by the treatment. That the results obtained would differ widely with the salt used and with the conditions of the experiment would naturally be expected, and has been demonstrated by actual trial. Even when soils are neutral or alkaline at the start they may develop a considerable acidity when treated with a salt solution; and any method which indicates an alkaline soil to be acid is certainly valueless for the determination of the effect of acidity on plant growth.

By way of analogy, suppose a man has one pocket full of coins, and another full of slugs. In so far as his ability to purchase commodities is concerned the contents of the former pocket is alone of significance. Even though the slugs can, by appropriate procedure, be converted into coins, they have only potential and no direct purchasing power. Determination of the total number of metal objects, or of the total weight of metal, which the man carries, can, of course, be carried out with as high a degree of precision as desired; but what bearing will this data have on his actual wealth?

Since the methods in this group yield composite, variable, and contradictory results, and furnish no information as to the soil acidity nor as to the lime requirement, it can only be concluded that they

are valueless in connection with any study of soils in relation to plant growth.

Of the methods listed under 2 A, in Table 5, the lime-water (Veitch) method gives directly the amount of lime needed to bring the soil to the degree of acidity or alkalinity shown by the indicator used. If phenolphthalein is selected, the result is the amount of lime which will give the soil a specific alkalinity of 30. If, however, litmus or brom-thymol blue were to be used, the amount of lime required to render the soil neutral would be obtained. This method, then, though obviously not permitting the determination of soil acidity, is a real *lime-requirement method*.

The method given under 2 B, in Table 5, permits the determination of the *quantity* of acid present in a given soil in the simplest possible way. An indicator, whose color changes occur at the neutral point, should, however, be used. Neither methyl orange nor phenolphthalein, however useful they may be for obtaining comparative results in ordinary titrations, shows when a solution has been actually neutralized. When an acid solution is being titrated, the former changes its color long before the neutral point has been reached and the latter does not begin to change until well past neutrality.

For reasons already explained in detail, the quantity of acid present in a soil is far less significant than the hydrogen-ion concentration or specific acidity, when effect upon the growth of plants is under consideration. The methods under 2 C, Table 5, are, therefore, the only ones which should be used in studying this subject. Method *a* is difficult to apply and to interpret. Method *b* is justly resorted to for testing soils where the necessary apparatus is available.

The indicator method *c*,⁴ while less accurate than the potentiometer method, is, however, so simple to apply that it can be recommended for use in all ordinary studies of soil acidity in relation to plant growth.

A FIELD METHOD FOR MEASURING SOIL ACIDITY.⁵

Under the most favorable conditions it is possible by the indicator method to measure acidity and alkalinity with much greater precision than is necessary in the field. By treating the indicators with buffer solutions of known ionic concentration, many hues intermediate between those in the accompanying color chart⁶ can be distinguished.

⁴ Clark and Lubs, Jour. Bacteriology, 2, 1, 1917. Gillespie, Jour. Wash. Acad. Sci., 6, 7, 1916.

⁵ First published in Jour. Wash. Acad. Sci., 10, 217-223, 1920; reprinted with minor modifications in Ecology, 1, 170-173, 1920; here copied from the latter, with footnotes added on pp. 252-254.

⁶ The color chart previously published (Ecology, vol. 1, facing p. 172, 1920) was copied from layers of indicator solutions, brought to the different degrees of acidity and alkalinity, 1 cm. thick. The present one, which is intended primarily for use with a porcelain plate containing depressions 2 or 3 mm. deep, in which the colors are viewed, shows the colors decidedly paler. The colors of the solutions as shown in such a plate have been kindly copied, in oil paints, by Mr. J. Marion Shull, of the Bureau of Plant Industry, and are here reproduced from his chart by lithography.

CHART SHOWING COLORS OF INDICATORS USED FOR DETERMINING SOIL REACTIONS.

Descriptive terms	superacid	mediacid	subacid	minimacid	minimalk.	subalk.	medialk.	superalk.							
	3.5	4.0	4.5	5.0	5.5	6.0	6.5	7.0	7.5	8.0	8.5	9.0	9.5	10.0	10.5
PH Values															
Specific reactions	← Acid							Neutral							Alkaline →
	3000+	1000	300+	100	30+	10	3+	1	3+	10	30+	100	300+	1000	3000+

Bromphenol blue

Methyl red

Bromcresol purple

Bromthymol blue

Phenol red

Cresolphthalein

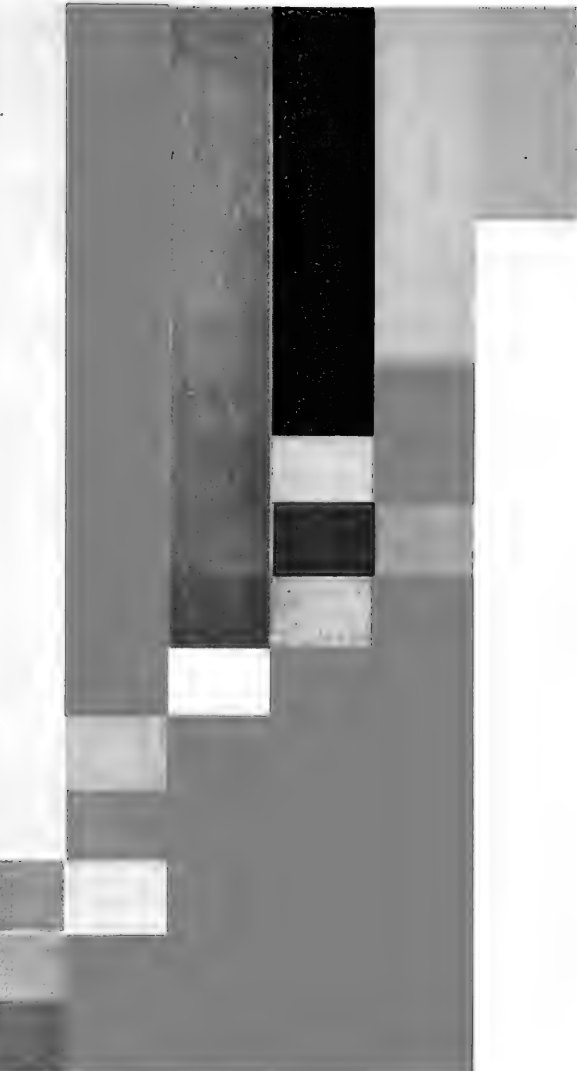

DIRECTIONS: To determine the specific acidity or alkalinity of a soil extract with the aid of this table, add first a drop of bromthymol blue. If the liquid is colored green, the reaction is neutral; if yellow, it is acid; if blue, alkaline. If acid, repeat with successive indicators lying above bromthymol blue; if alkaline with those lying below. Continue until either an intermediate color of one of these indicators, or opposing extremes of two overlapping ones, are obtained. The specific acidity or alkalinity can then be found at the head of the corresponding column.



On comparing the colors thus produced with those developed by mixing clarified soil extracts with the same indicators, specific acidities differing by a factor of $\sqrt[5]{10}$ or 1.59 ($P_H=0.2$) can be recognized. In the field, where it is inconvenient to carry buffer solutions to prepare standards for comparison, and where the turbidity of soil extracts is difficult to remove, it is impracticable to work closer than values differing by a factor of $\sqrt{10}$ or 3.16 ($P_H=0.5$) which is rounded off for simplicity to 3+. This degree of precision is, however, entirely adequate for the purpose in view, for it has been repeatedly found that from one to another plant of the same species, or indeed, from one to another root on the same individual, separate observations of reaction may differ by a factor of 10 or more.

The following outfit is used:⁷ First, a rectangular box about 3.5 by 5 by 9 centimeters in dimensions. In the box, six vials for the indicators, 1.5 by 5.5 centimeters, capacity 8 cubic centimeters, each provided with a cork or rubber stopper, into which is inserted a glass rod flush with the top of the stopper, and extending nearly to the bottom of the vial; to prevent undue compression upon inserting the stoppers, a groove may be cut in the side of each, so as to reach nearly to the lip of the vial. Then, three or four vials, in which to extract the soils, about 2 by 5 centimeters, made of heavy glass, to prevent undue breakage; a container for water, which may conveniently be a screw-capped jar holding 200 cubic centimeters or more, or an aluminum canteen; and a pipette, most simply constructed of two pieces of glass tubing a few centimeters in length, connected by a rubber tube.

The six indicators which have proved most satisfactory in work with soils are: Bromphenol blue, bromcresol purple, bromthymol blue, phenol red, methyl red, and *o*-cresolphthalein or phenolphthalein. The first three are used, as recommended by Clark and Lubs, in about 1 per cent solution in water, titrated with dilute sodium hydroxide to their intermediate colors; and the phenol red in a 0.5 per cent solution similarly titrated. The methyl red and phenolphthalein are used as 0.25 per cent solutions in 50 per cent alcohol. It should be noted here that litmus paper, which is often recommended for testing soil reaction, is much less sensitive than the above indicators, and may give misleading results.⁸

A simplification of the procedure previously recommended has been adopted; modifications may still be desirable in special cases. But before giving the directions, a word should be added concern-

⁷ Sets of indicators similar to that here described are for sale by the La Motte Chemical Products Co., 13 West Saratoga Street, Baltimore, Md.

⁸ Gillespie and Wise, Jour. Amer. Chem. Soc., 40, 796, 1918.

ing the water used for mixing with the soil. If calcium bicarbonate is present in this water, the soil acidity will be diminished, while if neutral salts, such as sodium chloride, and especially calcium sulphate, are present in any considerable amount, the acidity will be appreciably increased. The former effect is a direct neutralization; but the latter is due to the fact that the clay and the humus in the soil adsorb the basic elements from neutral salts and set the acid free. In the laboratory distilled water can be used, and to attain the greatest precision air freed from carbon dioxide can be blown through it until it reacts quite neutral; when one is traveling, distilled water can usually be purchased from a drug store and will give satisfactory results without special purification. In the wilds the best that can be done is to obtain spring or well water rising through rocks as free as possible from soluble constituents—such rocks as sandstone, shale, or schist. In calcareous regions it may be necessary to test waters from one source after another until a sample is found which reacts neutral—is colored green by a drop of bromthymol blue indicator—and to arrange the trip so that the water supply can from time to time be replenished from this source. With these points in mind, the following approximate directions have been drawn up:

A sample of soil a gram or two in weight is shaken from living roots into an empty vial, and 5 cubic centimeters of the most nearly neutral and salt-free water available is added, the vial being shaken well to insure complete mixing. After the soil and water are thoroughly mixed, the solid matter may be compacted with a glass rod or a stick, and the vial then supported at an angle of 45° and allowed to stand until the bulk of the suspended matter has settled. The more or less clear liquid is then decanted or pipetted off into another vial,⁹ a drop or two of bromthymol blue or one of the other indicators, the color changes of which occur near the neutral portion of the table, are added, and the color assumed is noted. If either of the extreme colors is shown, the process is repeated with the indicator¹⁰ whose color changes come next in the corresponding direc-

⁹ Instead of a vial a "porcelain plate with cavities, for color reactions," sold by dealers in chemical apparatus or in artists' supplies, may be used. The color changes can be seen very clearly in such a plate, but great care must be taken that too much indicator solution is not added. It is well to place a tiny drop of the indicator in one of the cavities, and then to add successive portions of the soil extract until the color can be barely seen.

¹⁰ In some soils, because of the colloid-matter acting differently on different indicators, the reactions indicated may not agree; for instance, bromcresol purple may show a color corresponding to specific acidity 10, and methyl red specific acidity 100; in this case the mean of the two values, 30+, is used. It should also be noted that the color changes are much more gradual than it was practicable to show on the chart, so that intermediate hues between those shown are often obtained, leading to reaction values between those tabulated.

tion; and this is continued until either an intermediate color of one indicator, or opposing extremes of two overlapping ones, are obtained, whereupon the specific acidity or alkalinity can be read off from the chart.

The more turbid the liquid the more indicator must be added, and the less certain are the results obtained. The turbidity can, of course, be removed by the addition of coagulating agents or by filtration through paper; but it is essential to make certain that these do not in themselves show an acid or an alkaline reaction. The most satisfactory results of all can be obtained by running a quantity of the extract through a paper filter until two successive portions yield the same value when tested with indicators. But such procedures are more suited to laboratory than to field studies, and after a little experience one can tell the indicator color change with certainty, even in the presence of considerable brown mud.

To illustrate the procedure followed in actual practice, two typical cases encountered by the writer may be cited here.

1. A black soil in pockets in limestone rock, supporting spleenwort ferns, was treated as above, and on testing the soil extract with bromthymol blue indicator, a strong blue color was obtained; reference to the chart showed that the reaction must be alkaline, and the value of specific alkalinity 3 or more ($P_H=7.5$). The process was repeated with the indicator, the color changes of which lay next toward the alkaline side of the table, namely, phenol red. With this indicator a clear red color was obtained, showing the reaction to be actually specific alkalinity 10 ($P_H=8.0$).

2. Soil from a dry blueberry thicket was tested, and, since upland peat is usually distinctly acid, the first indicator tried was bromcresol purple, the color changes of which occur just to the acid side of the neutral point; with this indicator a yellow color was obtained, indicating a specific acidity of at least 30. The soil was accordingly tried again with methyl red, which lies next toward the acid side, and this gave a violet-red color, corresponding to a specific acidity of 300 or more. It was accordingly necessary to try an indicator working at still higher acidities, namely, bromphenol blue; and this yielded a violet color, indicating 300 or less. The last two indicators agreed, then, in fixing the reaction of this soil as: specific acidity 300 ($P_H=4.5$).

In spite of certain limitations, this method is capable of giving definite information as to soil reaction in many cases. And the results obtained by the writer on a number of species of native plants have been of such significance that the method is published for the benefit of students of plant distribution and others interested in soil acidity and alkalinity.

THE RELATION OF SOIL ACIDITY TO PLANT DISTRIBUTION.

INTRODUCTORY NOTE.¹¹

As a result of many hundreds of determinations of soil acidity and alkalinity made by the above-described method upon plants growing under the widest range of physical and climatic conditions, the writer has found abundant evidence that the acidity of the soil is closely connected with the distribution of native plants. It is not intended to imply that the reaction is the only factor of importance in determining the place of growth, nor that the acid or alkali necessarily acts directly on the plant. Some plants may require for themselves or for symbiotic organisms a soil of a definite acidity (or alkalinity); but others may be favorably affected by some physical or chemical property of the soil which accompanies the development of that acidity; and still others may be driven into soils of a certain degree of acidity by more vigorous species which monopolize neighboring soils of greater or less acidities. The measurement of the actual soil acidities and alkalinities connected with certain species of plants, which is all that is attempted in the present series of studies, is but one step in the working out of the problem of why a given plant grows in a certain place. It is hoped that the results presented will indicate, however, the considerable, if not fundamental, importance of this heretofore often neglected step.

STUDIES ON FERNS.

*Rock ferns.*¹²—Judging from the literature, the ferns which grow on rocks would appear to be, on the whole, markedly sensitive to the chemical features of their soils. Their distribution is, of course, controlled to some extent by physical factors, such as climate, porosity of soil, availability of moisture, etc.; yet in many instances a given species has been observed to grow in soils of widely varying physical character, but consistently associated with a particular type of rock, and accordingly more or less uniform in chemical composition. Again, soils of like physical properties but dissimilar chemical nature often occur in such proximity that spores of the various ferns can not fail to have fallen into both kinds, yet flourishing plants have developed in but one of them.

It is commonly recognized that certain species of rock ferns grow by preference upon limestone and similar rocks, and are accordingly to be classed as calcareous soil plants. Other species, however, appear to avoid calcareous rocks quite definitely, and are presumably

¹¹ Reprinted with minor changes from introduction to an article in *Ecology*, 1, 42, 1920.

¹² Abstracted from "The soil reactions of certain rock ferns," *Amer. Fern Journ.*, 10, 15-22 and 46-52, 1920. Slight changes have been made in the table as the result of further work since the original paper was prepared.

to be classed as acid-soil plants. In the course of geological field trips and vacation outings for several years past the writer has been collecting information upon these relationships. The first plan tried was to carry samples from the field to the laboratory and there determine the percentage of calcium oxide (lime) present, both the total amount and the soluble portion; and a brief account of some results thus obtained has been published.¹³ Subsequently it proved possible to work out the above-described method for measuring, in the field, the soil reaction (acidity or alkalinity), which is much simpler as well as more instructive than the determination of lime.

The writer's field work on rock ferns has extended from Vermont and New Hampshire on the north to West Virginia and Virginia on the south, and all of the common species, as well as a few of the rarer ones, occurring within these limits have been studied. The results obtained are presented in Table I. The correctness of previous classifications has been confirmed in most cases, but considerable new data have been obtained on many species. As pointed out in the above-cited paper on rock ferns, it is the soil rather than the rock which affects the growth of plants; acid humus sometimes coats limestone ledges to such a thickness that species not normally favoring calcareous soils flourish there; and on the other hand, while the soils over sandstone, schist, granite, etc., are usually more or less acid in reaction, alkaline (calcareous) soils may accumulate on these rocks through the decomposition of vegetable débris, and typical calcareous soil species thrive there. Accordingly, actual tests have been made of the soils at the roots of the plants investigated. It is probable that further work will result in extending somewhat the ranges of reaction here recorded, although it seems unlikely that the classification of many of the species will be changed. It is hoped, in particular, that species which the writer has been unable to study fully will be worked up by others.

Method of recording data.—For recording data on individual species the following plan has been proposed:¹⁴ Arrange numbers representing specific acidities in a horizontal line, decreasing from left to right. At the left of this line place a column of numbers, increasing upward, to show how many observations have been made. Then place X's above each acidity opposite the number representing how many times such a degree of acidity has been observed at the roots of flourishing plants. A curve may be regarded as drawn through the X's thus placed, and from its shape the behavior of a plant with respect to soil acidity may be seen at a

¹³ Amer. Fern Journ., 7, 110-112, 1917.

¹⁴ Proc. Acad. Nat. Sci., Philadelphia, 1920, p. 96 et seq.

glance. Three illustrations from the paper cited may be reproduced here.

5+	x
4
3
2	x
1	x
	300+	100	30+	10	3+	1

This represents *Clethra alnifolia*, the "optimum acidity" for which is plainly shown to be specific acidity 300+, and the "range" rather limited, at most from acidity 300+ to 30+.

5+	x
4
3	x
2
1	x	x	x
	300+	100	30+	10	3+	1

This represents *Pyrola americana*, the optimum acidity for which is shown to be specific acidity 30+ and the range rather wide, from specific acidity 300+ down to 3+.

5+	x
4
3	x
2	x	x
1	x	x
	300+	100	30+	10	3+	1

This represents *Rhododendron maximum*, for which the range is from the greatest acidity met with in normal soils down to the neutral point; and the optimum is apparently at specific acidity 30+.

For comparison of a large number of species, it is simpler to indicate the frequency of observations of each degree of acidity by the use of different type, lower case x signifying rarely observed, capital X frequently observed, and bold face X the optimum or most frequently observed value. The three illustrations just given would appear under this plan as follows:

	300+	100	30+	10	3+	1
<i>Clethra alnifolia</i>	X	X	x
<i>Pyrola americana</i>	x	x	X	X	x
<i>Rhododendron maximum</i>	X	X	X	X	x	x

The latter plan is used throughout the present article.

Explanation of Table 6.—In the table as originally published the plants were arranged in the order adapted to bring out their botanical relationship. Here they are divided into three groups on that basis, but in each group (or subgroup in the case of No. 3) the species are listed in the order of diminishing alkalinity and increasing acidity of their soils.

TABLE 6.—Soil reactions of rock ferns.

Name.	No. of tests.	Soil reactions.										Class.	Range.	
		Mediacid.		Subacid.		Circumneutral.				Subalkaline.				
		300 +	100	30 +	10	Minimacid.		Minimalk.						
						3 +	1	3 +	10	30 +				
GROUP 1. <i>Sori marginal.</i>														
<i>Cryptogramma Stelleri</i>	15					x	X	X	X				C	N
<i>Pellaea glabella</i>	5						X	X	X				C	S
<i>atropurpurea</i>	30		x	X	X	X	X	X	X				C	S
<i>Cheilanthes lanosa</i>	15	x	X	X	X	X	X	X	X				A	S
<i>tomentosa</i>	(2)			(x)		(x)							A	S
GROUP 2. <i>Sori elongate.</i>														
<i>Asplenium Ruta-muraria</i>	15					x	X	X	X	X			C	N
<i>resiliens</i>	15					(x)	X	X	X	X			C	S
<i>viride</i>	(2)						(X)						C	S
<i>Phyllitis Scolopendrium</i>	(2)						X						C	S
<i>Camptosorus rhizophyllus</i>	50			x	X	X	X	X	X	X			C	S
<i>Asplenium Trichomanes</i>	30			x	X	X	X	X	X	X			C	S
<i>ebenoides</i>	15(1)			x	X	x	X	x	x	x			C	S
<i>platyneuron</i>	50	X	X	X	X	X	X	X	X	x			I	S
<i>Bradleyi</i>	5(3)	X	X	X	x								A	S
<i>montanum</i>	20	X	X	X	x								A	S
<i>pinnatifidum</i>	20	X	X	X									A	S
<i>gravesii</i>	10	X	X										A	S
GROUP 3. <i>Sori various.</i>														
<i>Woodsia glabella</i>	15					x	X	X	X	X			C	N
<i>alpina</i>	5					X	x						C	N
<i>Ilvensis</i>	25		x	X	X	x							A	N
<i>Dryopteris fragrans</i>	(2)				(X)								A	N
<i>Woodsia obtusa</i>	30		x	X	X	X	X	X	X	X			C	N
<i>Cystopteris bulbifera</i>	30		x	X	X	X	X	X	X	X			C	N
<i>fragilis</i>	30		x	X	X	X	X	X	X	x			C	N
<i>Polypodium vulgare</i>	50		x	X	X	X	X	X	X	x			C	S
<i>polypodioides</i>	15	X	X	X	X	x	x						A	S

NOTE TO TABLE 6.—A Swedish ecologist, O. Arrhenius, has recently published the results of observations on the soil acidity of plant associations in the vicinity of Stockholm (Oecologische Studien in den Stockholmer Schaeren. Stockholm, 1920. (In German.)) Four of the above-listed species occurred there, and his data, translated into terms of specific acidity, are as follows:

Asplenium Ruta-muraria, spec. ac. 10 to 3+; *Asplenium Trichomanes*, spec. ac. 5; *Woodsia Ilvensis*, spec. ac. 10 to 3+; and *Polypodium vulgare*, spec. ac. 13. The first of these results represents a slight extension of range, but the others fall within the ranges here recorded. The essential agreement of measurements made quite independently and in such widely separated regions furnishes a striking confirmation of the definiteness of the soil preferences of these species.

The names used are those accepted by most present-day writers. The number of tests made on each species is recorded, and, as about three tests have customarily been made at each locality, the number of localities represented is approximately one-third of the number of tests. Tests made on soil adhering to the roots of herbarium specimens, which seemed desirable in a few instances to supplement field data, are distinguished by parentheses.

The majority of the species tabulated clearly favor reactions lying toward one side of the table or the other, and it is convenient to have

some way of classifying them on this basis. Those the dominant reactions of which lie toward the left-hand side may be termed "acid-soil plants." It should be noted that the degree of acidity represented by habitats supporting these ferns is for the most part less than that of the sphagnum bogs and sandy barrens where so-called "oxylophytes" grow, so the latter term is not desirable for application here. This class is designated by an A, for acid, in the next to the last column of the table.

The complementary term "alkaline soil plants" is unsuitable for those showing dominant reactions toward the right-hand side of the table, since the degree of alkalinity represented is at most but slight, and moreover no species of this class has been found which will not grow also in neutral and even slightly acid soils. The evidence indicates that the important factor in the case of plants avoiding the most acid soils is the relative abundance of calcium compounds, and accordingly "calcareous soil plants" will be used. The terms "calciophile" (lime lover) and "calcicole" (lime grower) are often applied to this class of plants. Since plants may grow in calcareous habitats for various other reasons than "love of lime" the latter term is the preferable one; but neither is really necessary. This class is marked in the table by a C, for calcareous. I, for indifferent, is used in one instance.

It is evident from the table that no sharp line can be drawn between the two classes, as marked overlapping occurs in the central columns, especially in those of specific acidity 30, 10, and 3. Laboratory tests for calcium compounds have shown these to be present in practically all the soils concerned, their amount and especially their solubility diminishing markedly as the reactions approach mediacidity. By no means all species showing calcium compounds in their soils are calcareous soil plants; for when the specific acidity exceeds about 30 the physiological effect of the acid appears to predominate over that of the calcium; and although when the specific acidity is 10 or below, the effect of the calcium is dominant, some acid soil plants can still thrive even at the neutral point. In soils termed minimacid, plants of both classes may flourish side by side; but if enough occurrences of each species can be studied, the dominant reaction is always found to lie definitely toward one side or the other, and the plant can be assigned to the corresponding class.

In the final column of the table letters are used—N for northern and S for southern—to bring out the relation between the range of each species and its soil reaction. The calcareous soil species prove to be dominantly northern in their distribution, the acid soil ones dominantly southern. This is evidently connected with their evo-

lutionary history and with the fact that the climatic conditions of the more northern regions, as well as the glacial action which has affected them, are adapted to the accumulation of calcareous soils, whereas in more southern regions there is, on the whole, a tendency for soils to develop acidity.

Soil reaction and plant relationship.—In several cases listed in the above table related plants show marked differences in their soil preferences. Thus *Pellaea glabella* is much less tolerant of acid condition than is *P. atropurpurea*; *Asplenium ruta-muraria* and *A. montanum* lie at the opposite extremities of the group in this respect; *Camptosorus rhizophyllus* and *Asplenium pinnatifidum* are also widely separated; the three small *Woodsias* form a subgroup, in which *W. alpina* is intermediate both in morphologic characters and soil reaction; and finally the two species of *Cystopteris* differ distinctly, and the two *Polypodiums* markedly, in their soil preferences.

On the other hand, the two ferns listed, which the evidence indicates to be recent hybrids, namely, *Asplenium ebenoides* and *A. gravesii*¹⁵ do not differ essentially in soil requirements from their parents. It is accordingly reasonable to conclude that the greater the divergence in soil reaction of related species the longer time has been required for their development since their original separation.

*Ferns of woods and swamps.*¹⁶—The ferns to which this essay is devoted are, on the whole, less sensitive to soil acidity and alkalinity than those which grow on rocks, to which attention was directed above. It seems worth while, however, to place on record what data have been obtained on testing the soils surrounding their roots, by the indicator method. The following designations are used in the class column of Table 10:

AA, intensely acid; appearing to thrive only in mediacid soils.

A, acid; growing well in soils of practically all degrees of acidity.

I, indifferent (relatively); appearing to thrive in both acid and alkaline soils as long as neither reaction is extreme.

C, calcareous or circumneutral; growing best in neutral or nearly neutral soils, though extending throughout what is termed the circumneutral range (specific acidity 10 to specific alkalinity 10). No instance has been observed of a species which will not grow in neutral or slightly acid soils if it thrives and is ordinarily found in actually alkaline ones.

¹⁵ Added to the list since the paper was originally published; compare Am. Fern Journ., 10, 119-121, 1920.

¹⁶ Abstracted from paper in Amer. Fern Journ., 11, 5-16, 1921.

TABLE 7.—Soil reactions of ferns of woods and swamps.

Name.	No. of tests.	Reactions.										Class.	Range.		
		Mediacid.	Subacid.	Circumneutral.					Subalkaline.						
				Minimacid.		Minimalk.									
				300+	100	30+	10	3+		1	3+			10	30+
Schizaea pusilla.....	10	X												AA	S
Lygodium palmatum.....	10	X	x											AA	S
Osmunda regalis var. spectabilis.....	30	X	X	X	x	x								A	A
cinnamomea.....	30	X	X	X	x	x								A	A
Claytoniana.....	20	x	X	X	X	X	X	x						I	C
Pteretis nodulosa.....	20				x	x					x	x		I	C
Onoclea sensibilis.....	30	x	X	X	X	X	X	X	X	x	x	x		I	I
Dennstedtia punctilobula.....	30	x	X	X	X	X	X	X	X	x	x			I	I
Woodwardia areolata.....	20	X	x											AA	S
Virginica.....	20	X	X	X	X	x								AA	S
Pteridium latiusculum.....	30	x	X	X	X	x								A	A
Adiantum pedatum.....	30			x	X	X	X	X	X	x	x			A	C
Polystichum acrostichoides.....	30	x	X	X	X	X	X	X	X	x	x			I	C
Braunii.....	10			x	X	X	X	X	X	x	x			I	C
Athyrium angustifolium.....	10			x	X	X	X	X	X	x	x			C	I
acrostichoides.....	10			x	X	X	X	X	X	x	x			I	I
asplenoides.....	30	x	x	X	X	X	X	X	X	x	x			I	I
angustum.....	10	x	x	X	X	X	X	X	X					I	I
Dryopteris = Aspidium = Thelypteris (includes Phegopteris).															
Dryopteris Thelypteris.....	30	x	X	X	X	X	X	X	X	x				I	
simulata.....	10	X	X	X	X	X	X	X	X					AA	
novoboracensis.....	30	x	X	X	X	X	X	X	x	x				I	A
Linneana.....	20		x	X	X	X	X	X	x	x				I	I
Phegopteris.....	20	x	x	X	X	X	X	X	X	x	x			I	N
hexagonoptera.....	30		x	X	X	X	X	X	X	x	x			I	I
marginalis.....	30		x	X	X	X	X	X	X	x	x	x		I	C
Goldiana.....	10				x	X	X	X	x	x				C	
var. celsa.....	10	X												AA	S
Filix-mas.....	(2)						X	X	X					C	I
cristata.....	20	x	X	X	X	X	X	X	X	x				I	I
var. Clintoniana.....	(3)				X	X	X	X	X					I	I
spinulosa.....	20	X	X	X	X	X	X	X	X	x	x			I	I
var. intermedia.....	20	X	X	X	X	X	X	X	X	x	x			I	A
var. americana.....	3				X	X	X	X	X					I	A
X Boottii.....	20	X	X	X	X	X	X	X	x	x	x			I	C
marg. X crist.....	10			x	X	X	X	X	x	x				I	C

Note to Table 7.—None of these species appears to have been studied by Arrhenius, in Sweden, but it is interesting to note that *Pteridium aquilinum*, the European relative of our *P. latiusculum*, was found by him to have a similar range in specific acidity, from 30+ to 3+.

Soil reaction and geographic range.—From the foregoing tabulation it will be seen that the ferns of woods and swamps are, on the whole, less particular than the rock ferns as to their soil reactions; in but a single case, *Dryopteris Goldiana* and its variety *celsa*, are closely related plants sharply contrasted in optimum reaction. It is, however, noteworthy that the peculiar relation found to exist among rock ferns—the favoring of acid soils by southern species and of circumneutral soils by northern ones—is likewise well marked in the present series of plants. As the same sort of relation appears to hold also with other plants than the ferns, in particular with the native orchids, it is sufficiently definite to justify inquiry into its probable origin.

Circumneutral reactions are shown by soils which either contain considerable amounts of undecomposed carbonate minerals, are bathed by alkaline spring waters, or are so situated as to favor the accumulation of leaf mold. An acid reaction, on the other hand, tends to develop in soils which either lack carbonate minerals, are exposed to the action of rain water so that basic constituents become leached out, or are so located that peat can accumulate.

In northern latitudes, or at high elevations, rocks disintegrate more rapidly than they decompose, and so, if the rocks at any locality thus situated contain suitable minerals in the first place, circumneutral soils may develop. Glacial deposits are especially likely to contain undecomposed carbonate minerals, which the ice has ground from rock ledges; and actual tests of the soils derived from such deposits in Pennsylvania, New Jersey, and the New England States, have shown that even after exposure to the weather for many thousands of years, since the last ice sheet retreated, sufficient quantities of undecomposed minerals are still present in many places to keep the reaction circumneutral.

The territory left bare by the retreat of the great ice sheet must at first have presented an almost unbroken expanse of circumneutral soils, and the vegetation which first occupied it accordingly comprised only plants which thrive best in such soils. Although acid soils have developed subsequently in many places, and permitted invasion by plants adapted to growth under acid conditions, a considerable number of the original occupants still persist, and are to-day classed as "northern" species.

In more southern regions, on the other hand, decomposition usually outstrips disintegration, so that soils containing undecomposed carbonate minerals are relatively rare. Except where limestone outcrops or where leaf mold accumulates, therefore, the dominant soil reactions are inclined to be acid, and the plants, established there since long before the glacial period, have become adapted to growth in such soils. The favoring of circumneutral soils by northern species, and of acid soils by southern ones, is thus connected with the geological history of the respective regions.

STUDIES ON ORCHIDS.

The results which have been obtained in the study of the native orchids are here summed up in a table similar to those used for ferns, the data from three previous publications being combined.¹⁷ The species are arranged for convenience in several more or less natural groups, and are listed in each group in the order of increasing acidity of their soils.

¹⁷ The reactions of the soils supporting the growth of certain native orchids, *Journ. Wash. Acad. Sci.*, 8, 591, 1918; Table IV in *Soil tests of Ericaceae, etc., Rhodora*, 22, 47, 1920; Table 3 in *Observations on the soil acidity of Ericaceae, etc., Proc. Acad. Nat. Sci., Philadelphia*, 1920, 110. A few subsequent additions have also been made.

TABLE 8.—*Soil reactions of orchids*—Continued.

Name (Gray nomenclature).	Number of tests.	Mediacid.		Subacid.		Minimacid.		Minimalkaline.	Class.	Range.	
		300+	100	30+	10	3+	1				Circumneutral.
								3+			10
LISTERA GROUP.											
(Twayblade orchids.)											
<i>Listera convallarioides</i>	10				x	X	x			C	N
<i>cordata</i>	10	x	x	X	x	X	x			A	N
<i>australis</i>	(1)	X				x				AA	S
<i>smallii</i>	(1)	X								AA	S
LIPARIS GROUP.											
(Blade-lip orchids.)											
<i>Microstylis monophyllos</i>	5					x	X	x		C	N
<i>Liparis liliifolia</i>	25		x	X	X	X	x			I	N
<i>Loeselii</i>	10	x	x	X	X	X	x			I	N
<i>Microstylis unifolia</i>	20	X	X	X	x					A	
APECTRUM GROUP.											
(Chain-bulb orchids.)											
<i>Calypso bulbosa</i>	5				x	X	x			C	N
<i>Apectrum hyemale</i>	25		x	X	X	X	x			I	N
<i>Tipularia discolor</i>	25	x	X	X	X	x				A	S
CORALORRHIZA GROUP.											
(Coral-root orchids.)											
<i>Corallorrhiza trifida</i>	5				x	X	x			C	N
<i>Wisteriana</i>	5			x	X	x				I	S
<i>odontorrhiza</i>	25		x	X	X	x				I	S
<i>maculata</i>	5		x	X	x					A	

As with the ferns, the favoring of the more alkaline soils by the more northern species and of the more acid soils by southern ones is more or less distinctly brought out by this tabulation. There are, it is true, a number of species of northern range with preference for acid soils, but on the other hand all of those favoring circumneutral soils are northern; and without exception the southern species grow best in acid or extremely acid soils. The explanation is no doubt the same as in the case of the ferns, namely, that many species now called northern are those which occupied the circumneutral soils left by the retreat of the great glacier in the northern part of the continent. Other northern species may represent later arrivals, acid soils having developed meanwhile; but southern regions have never offered sufficient areas of circumneutral soil for species to become adapted to such soils there.

STUDIES ON ERICACEAE.¹³

Practically all of the members of the Ericaceae are acid-soil species, so no comparison between their "class" and their geographic range can be made. Nevertheless it is of interest to tabulate the reactions which they have been observed to favor and to bring out the differences in the range of soil acidity shown by the various species.

TABLE 9.—Soil reactions of Ericaceae.

Name (Gray nomenclature).	Number of tests.	Specific acidities.					
		300+	100	30+	10	3+	1
CLETHRA GROUP.							
<i>Clethra alnifolia</i>	25	X	x	x	(x)		
PYROLA GROUP.							
<i>Pyrola asarifolia</i>	5						X
<i>elliptica</i>	20		x	X	X	x	
<i>chlorantha paucifolia</i>	15			X	X	x	
<i>Chimaphila maculata</i>	25	x	x	X	X	x	
<i>umbellata</i>	25	x	x	X	X	x	
<i>Moneses uniflora</i>	10	x	x	X	x	x	
<i>Pyrola rotundifolia americana</i>	25	x	x	X	X	x	
<i>secunda</i>	20		x	X	x		
<i>secunda obtusata</i>	10	x	x	X	x	x	
<i>chlorantha convoluta</i>	3	X	x				
<i>asarifolia incarnata</i>	3	X					
MONOTROPA GROUP.							
<i>Monotropa uniflora</i>	10		x	X	x		
(<i>Hypopitys</i>) <i>americana</i>	3			X			
<i>lanuginosa</i>	10			X			
<i>insignata</i>	5	X					
<i>Monotropis odorata</i>	(2)	X	x				
RHODODENDRON GROUP.							
<i>Rhododendron maximum</i>	50	X	X	X	X	x	x
(<i>Azalea</i>) <i>nudiflora</i>	50	x	X	X	X	x	
<i>canescens</i>	5	x	x	X			
<i>arborescens</i>	10		x	X			
<i>calendulacea</i>	10	X	X	X			
<i>Kalmia latifolia</i>	50	X	X	X	X		
(<i>Rhodora</i>) <i>canadense</i>	5	x	X	x	(x)		
<i>Menziesia pilosa</i>	10	X	X	X			
<i>Kalmia angustifolia</i>	25	X	X	X	x		
<i>polifolia</i>	10	X	x		(x)		
<i>Ledum groenlandicum</i>	15	X	X	x	(x)		
(<i>Azalea</i>) <i>viscosa</i>	25	X	x	x	x		
<i>Rhododendron lapponicum</i>	5	X	x				(?)
<i>Loiseleuria procumbens</i>	5	X	x				
<i>Phyllococe coerulea</i>	5	X	x				
<i>Leophyllum buxifolium</i>	10	X	x				
ANDROMEDA GROUP.							
<i>Leucothoe racemosa</i>	25	X	X	X	x	x	
<i>Lyonia ligustrina</i>	25	X	X	X	x		
<i>Epigaea repens</i>	50	X	X	X	X		

¹³ The combined data from: Soil tests of Ericaceae and other reaction-sensitive families in northern Vermont and New Hampshire, *Rhodora*, 22, 33-49, 1920; and Observations on the soil acidity of Ericaceae and associated plants in the Middle Atlantic States, *Proc. Acad. Nat. Sci.*, Philadelphia, 1920, 84-111. In the present compilation a few additions have been made, as the result of further tests, chiefly in the State of Virginia. The names in parentheses are subgeneric in Gray's Manual. The acidities in parentheses represent tests in nurseries or on herbarium specimens.

TABLE 9.—Soil reactions of *Ericaceae*—Continued.

Name (Gray nomenclature).	Num-ber of tests.	Specific acidities.					
		300+	100	30+	10	3+	1
ANDROMEDA GROUP—continued.							
<i>Oxydendrum arboreum</i>	10	X	X	X			
<i>Gaultheria procumbens</i>	50	X	X	X	x		
<i>Chamaedaphne calyculata</i>	25	X	X	x	x		
<i>Lyonia mariana</i>	20	X	x	x			
<i>Andromeda floribunda</i>	5	X	x		(x)		
<i>glaucophylla</i>	5	X	x		(x)		
<i>Cassiope hypnoides</i>	5	X	x				
<i>Leucothoe axillaris</i>	5	X					
<i>Lyonia ligustrina foliosiflora</i>	5	X					
<i>nitida</i>	5	X					
ARCTOSTAPHYLOS GROUP.							
<i>Arctostaphylos Uva-ursi</i>	10	x	x	x	X	x	x
<i>alpina</i>	5	X	x				(?)
VACCINIUM GROUP.							
<i>Gaylussacia baccata</i>	25	x	X	X	X	x	x
<i>Vaccinium vacillans</i>	50	X	X	X	X	x	x
<i>stamineum</i>	25	x	x	X	X	x	x
<i>corymbosum</i>	50	X	X	X	X	x	
<i>atrococcum</i>	20	x	X	X	X	x	
<i>pennsylvanicum</i>	15	X	X	X	x		
<i>canadense</i>	15	X	X	X	x		
<i>caespitosum</i>	5	X	X	x			(?)
<i>erythrocarpum</i>	10	X	X	x			
<i>Chiogenes hispidula</i>	15	X	X	x			
<i>Gaylussacia brachycera</i>	15	X	X	x			
<i>frondosa</i>	15	X	X	x			
<i>Vaccinium macrocarpon</i>	20	X	X	x			
<i>pennsylvanicum angustifolium</i>	5	X	x				
<i>Vitis-Idaea minus</i>	5	X	x		(x)		
<i>uliginosum</i>	5	X	x				
<i>Oxycoccus</i>	5	X					
<i>Oxycoccus intermedia</i>	5	X					
<i>arboresum</i>	5	X					
<i>virgatum tenellum</i>	5	X					
<i>Gaylussacia dumosa</i>	10	X					
DIAPENSIA GROUP.							
<i>Galax aphylla</i>	10	X	x	x			
<i>Pyxidantha barbulata</i>	10	X	x	x			
<i>Diapensia lapponica</i>	5	X	x				
EMPETRUM GROUP.							
<i>Corema conradii</i>	10	X	x				
<i>Empetrum nigrum</i>	5	X	x				
"nigrum andinum"= <i>atropurpureum</i>	5	X	x				

Note to Table 9.—Several of these *Ericaceae* were studied by Arrhenius in Sweden, giving the following data: *Pyrola secunda*, sp. ac. 100 to 10; *Arctostaphylos* species, sp. ac. 300+ to 1; *Vaccinium Vitis-Idaea* (typical, varietally distinct from American plant), sp. ac. 1000 to 3+; and *Empetrum nigrum*, sp. ac. 100 to 5.

CONCLUSION.

In addition to the studies of plant groups above described, special problems of plant distribution have been investigated from the point of view of soil acidity. It has been found¹⁹ that the vegetation areas of southern New Jersey differ distinctly in the acidity (as well as the salt content) of their soils, and this may well account for the

¹⁹ Correlation between vegetation and soil acidity in southern New Jersey, Proc. Acad. Nat. Sci. Philadelphia, 1920, 113-119.

peculiarities of the flora of the Pine-Barren area. The presence of plants, often found in peat bogs, around the borders of salt marshes can likewise be explained on the basis of soil acidity.²⁰

The application of these methods to the study of the soil for the cultivation of native plants has only just begun, but it has proved easy to grow a number of species ordinarily regarded as impossible to cultivate by seeing to it that the soil possessed a reaction approaching that which had been found to be optimum for the plants in nature (as shown in the tables above). By way of illustration of what can be done along this line, two photographs of *Shortia galacifolia* in the writer's garden are here reproduced on plate 2. The upper picture shows how this plant behaved the first year after receipt from a nursery, in which it had been grown in soil of a low degree of acidity (specific acidity 3). The plant was placed in soil of specific acidity 100, and the lower picture shows what happened the next year. Its optimum acidity is evidently nearer the second than the first specific acidity.

²⁰ Plant distribution around salt marshes in relation to soil acidity, *Ecology*, 1, 42, 1920.



1. *SHORTIA GALACIFOLIA* GROWING IN NEUTRAL SOIL IN GARDEN OF THE WRITER, WASHINGTON, D. C.



2. THE SAME PLANT AS FIGURE 1, AFTER GROWING FOR ONE YEAR IN SUBACID SOIL. THE FIVE-FOLD INCREASE IN SIZE SHOWS CLEARLY THE PREFERENCE OF THIS PLANT FOR ACID SOILS.



THE CHEMISTRY OF THE EARTH'S CRUST.¹

By HENRY S. WASHINGTON, PH. D.,
Petrologist, Geophysical Laboratory, Carnegie Institution of Washington.

INTRODUCTION.

The term "Crust of the earth" is a heritage from the days when the interior of the earth was generally conceived to be a "sea of molten rock," at an enormously high temperature, covered by a relatively thin, solid crust of cooled matter. Various cogent reasons, into the consideration of which we can not enter here, have led to the abandonment of this concept, and we now have reason to hold the following tenets as to the conditions that obtain in the earth's interior:

1. The interior is essentially—or, at least, behaves essentially like—a rigid solid, though possibly a certain amount of viscosity may be granted.

2. It is hot, but of an unknown temperature, and probably increases in temperature toward the center, with a gradient that is unknown beyond very moderate depths, and that is probably very different in different places.

3. It is of a density greater than that of the "crust," inasmuch as the mean density of the earth as a whole is about 5.55, while that of the crust is about 2.77, as will be shown later.

4. The earth, as a whole, acts in many respects as a magnet, and as the rocks of the crust in general are not notably magnetic, this may be attributed to the characters or composition of the interior materials.

5. From the study of the propagation of earthquakes we are led to believe that there is a change in the physical properties at about 0.5 of the radius in depth, the matter below this not transmitting transverse vibrations. Studies on the compressibility of rocks by Adams and Williamson, in the Geophysical Laboratory, indicate that the high density of the interior can not be explained by compres-

¹ Reprinted by permission from the Journal of the Franklin Institute, December, 1920, based on a paper presented at a meeting of the section of physics and chemistry held Thursday, Mar. 4, 1920.

sibility, so that we have reason to think that there is also, toward the center, a change in actual substance.

6. It has been often suggested, and is more or less commonly believed, from consideration of the density and magnetic character of the earth and from the composition of many meteorites, that part, at least, of the interior is composed essentially of iron, or of nickel-iron alloy similar to those which constitute the iron meteorites.

Leaving the interior of the earth for the present we may concentrate our attention on the outer shell—the so-called “crust”—which is the only portion that is directly open to our study, and which has been compared, with some justice, to a covering of slag or scoria over the interior. In dealing with this we shall consider only its chemical characters, with, toward the end of the paper, some relations between these and the densities of rocks.

The thickness of this crust is, of course, unknown, probably not uniform, and presumably indeterminate. Following Dr. F. W. Clarke, we may assume, for purposes of computation, an approximate thickness of 10 miles (16 kilometers), this being about the (minimum) aggregate thickness of all known rocks and deposits of the various geological ages that have become exposed to our observation and study through movements in the crust. Incidentally, it about equals the sum of the highest land elevation and the greatest oceanic depth, though no causal nexus is apparent.

This solid crust is made up almost wholly of igneous rock—that is, rock that has solidified from a hot, liquid (“molten”) condition, either as “plutonic” rocks, at different depths beneath the surface, or in the form of lava flows at the surface. Assuming a thickness of 10 miles, Doctor Clarke² has estimated the rock composition of the crust to be about as follows:

	Per cent.
Igneous rocks	95.0
Shales	4.0
Sandstones	0.75
Limestones	0.25
	100.00

Such masses as coal beds or salt and ore deposits are of negligible magnitude in studying the chemistry of the crust as a whole, as it is purposed to do here, though their presence is of some significance. The amount of the coating of soil is absolutely negligible from this point of view.

When we take into consideration the oceans and the atmosphere, Clarke estimates the lithosphere at 93 per cent, the hydrosphere at

² Clarke, F. W., The data of geochemistry, U. S. Geol. Survey, Bull. No. 695, p. 33, 1920. The proportion of igneous rock would be still greater with greater assumed thickness of crust.

7 per cent, and the atmosphere at 0.03 per cent, of the complex crust. In the following pages, however, the hydrosphere and the atmosphere and the sedimentary rocks will not be taken into account, and we shall consider the "crust" as made up wholly of igneous rocks. This is the more justifiable for our present purposes, because the material of the sedimentary rocks has been derived entirely, either directly or indirectly, from preexisting igneous rocks, while the metamorphic rocks (gneisses, schists, etc.) have been formed from either igneous or sedimentary rocks.

When we consider, then, only the igneous rocks of the earth as a whole, we know that they are not all alike, but show wide differences in their characters, chemical and physical. There are here two main questions regarding them to be considered.

The first is: What is the average chemical composition of the igneous rocks of the crust? The answer to this is of considerable importance for the investigation of the constitution of the earth, and is also of interest in the study of the rocks themselves—the science of petrology.

The second question is: Do the igneous rocks, taken as a whole, show sensible uniformity as to general characters, or do they differ noticeably in different portions of the earth's surface? That is, is the earth's crust sensibly alike or unlike?

Attempts to answer these questions, with some consequences that seem to follow from their consideration, will form the chief topics of this paper.

GENERAL CHARACTERS OF IGNEOUS ROCKS.

For present purposes we can not go deeply into the characters of igneous rocks, nor discuss them all—a subject that has produced a very voluminous literature. It is needful here to present only some of the salient and pertinent facts.

Igneous rocks, as has been said, are those that have solidified from a state of fusion, or rather liquidity, as the term "fusion" implies a previous solid condition. The liquid matter, that eventually solidifies as a rock, is called technically the "magma," a term that is in frequent use in petrology.

The magma comes up from below; from what depth we do not know, though there is some reason for thinking that the places of origin are not very deep. Nor do we know whether it arises from the melting of portions of the earth that are actually solid but potentially liquid on relief of pressure, or whether it is, in general, derived from "reservoirs" of liquid magma.

The igneous magma may be compared, as it usually is, to a complex solution of salts in water. This idea, which was first suggested by Bunsen in 1861, is of great importance, and has been very fruitful in our study of the origin, formation, and characters of igneous rocks.

Among other things, it may be mentioned here that the magma contains various gases in solution, much as air is present in solution in spring water, or, rather more appropriately, as carbon dioxide is present in the waters of many mineral springs, so that it escapes on relief of pressure.

Of these gases by far the most important, and generally the most abundant, is water vapor. This forms the major part of the clouds that are given off during volcanic eruptions, and, with other gases, produces the spongelike structure of pumice and the cavities of vesicular lavas through expansion, caused by relief of pressure on reaching the surface. In some glassy lavas water is present to the extent of several per cent, the magma having solidified so rapidly as not to permit of its escape, and inclusions of visible water and liquid carbon dioxide are present in the crystals of many granites and other rocks. The presence of water in volcanic magmas has been doubted by Brun and others following him, but its existence in lavas, especially those of Kilauea, has been shown conclusively by the researches of Day and Shepherd,³ is shown by practically every rock analysis, and in other ways, so that the existence of water in magmas may be regarded as one of the established truths of the chemistry of igneous rocks.

Besides water, other gases are often present in volcanic exhalations, such as carbon dioxide, carbon monoxide, hydrogen chloride, sulphur trioxide and dioxide, hydrogen sulphide, hydrogen fluoride, ammonia, methane and possibly other hydrocarbons, sulphur vapor, hydrogen, nitrogen, oxygen, argon, helium, and other rare gases. The study of these and the bearing of their interreactions on the maintenance, and possibly the partial production, of volcanic heat, is an interesting subject.

The presence of these gases in the magma lowers its solidification point, so that a lava, on coming to the surface, may be, and usually is, liquid at a temperature considerably below the fusing point of the solid rock formed from it, during which solidification much, if not most, of the dissolved gas is lost. Either because of this, or because of the lessened viscosity, or in some other way that is not yet well understood, the gases contained in the magma seem to promote the crystallization of minerals, so that they are often

³Day and Shepherd, Bull. Geol. Soc. Amer., xxiv, 573, 1913.

referred to as "mineralizers." These gases also play an important part in the formation of many ore bodies.

The magma on solidification generally forms a mixture of minerals, substances of definite chemical composition, and physical characters, just as a solution of salts in water (such as sea water), forms a mixture of crystals of salts and ice on freezing. The exception to this is when the cooling of the magma takes place too rapidly for complete or (as with the obsidians) any crystallization, in which case the rock is composed partly or wholly of glass. Such glassy rocks are found only as surface flows.

MINERAL CONSTITUENTS OF ROCKS.

It is a very important and striking fact that, although about 1,000 different minerals are known, yet the number of the different kinds that compose by far the great majority of igneous rocks—certainly over 99 per cent by weight of these—is very small. Indeed, the really important and essential igneous rock-forming minerals number only about a dozen.

These essential minerals are quartz, silicon dioxide; the feldspars, silicates of alumina and potash, soda, or lime, including the potassic orthoclase, the sodic albite, and the calcic anorthite, with isomorphous mixtures of these; the pyroxenes, metasilicates of calcium, magnesium, and iron, with aluminum or sodium in some cases; the amphiboles, in chemical composition much like the pyroxenes, but differing in crystal form and otherwise; the micas, aluminosilicates, for the most part the potassic muscovite or the potassium-iron-magnesium biotite, both containing hydroxyl; the olivines, orthosilicates of iron and magnesium; nephelite, an orthosilicate of sodium and aluminum; leucite, a metasilicate of potassium and aluminum; magnetite, ferrous-ferric oxide, often containing titanium; and apatite, a phosphate of calcium, containing a little fluorine or chlorine. Magnetite and apatite are present in almost all rocks, but seldom in more than almost negligible amounts.

Other minerals are not infrequently met with in certain types of igneous rocks, such as the silicates sodalite, hauyne, melilite, zircon, and garnet, and the oxides tridymite (a second form of silica), ilmenite, chromite, spinel, corundum, and rutile. But, considering igneous rocks from the standpoint of a study of the whole crust of the earth, these are practically negligible. Igneous rocks, then, in general, and looked at in the broadest way, are constituted almost wholly of a very few silicates of aluminum, iron, calcium, magnesium, sodium, potassium, and hydroxyl, with or without quartz (that is, excess of silica), with small amounts of a phosphate and of iron

oxide, and with or without traces of other constituents. It is also to be noted that some of the essential minerals enumerated above (the pyroxenes, amphiboles, micas, olivines, and the magnetites), contain small amounts of manganese and titanium. From such a general survey of the rock-forming minerals, then, we obtain the broad lines of the chemical composition of the earth's crust as a whole.

Another important fact concerning the igneous rock minerals is that, with two exceptions, any one of them may occur in rocks with any one or more of the others. The only exceptions to this are that neither nephelite nor leucite is known to occur along with quartz, and a partial exception is that olivine seldom occurs with quartz, and never in any large amount. Discussion of this and other relations between the various minerals would lead to a consideration of matters outside of our present scope, and would take us too far afield.

Each rock mineral may be present in very widely varying proportions—from practical totality to complete absence. We know igneous rocks that are composed entirely of quartz (arizonite), feldspar (anorthosite), pyroxene (websterite), amphibole (hornblendite), or olivine (dunite), and almost entirely of nephelite (congressite), leucite (italite), or magnetite (some iron ores). Of the essential rock minerals only the micas and apatite do not form the whole, or almost the whole, of any igneous rock.

From totality of any one mineral we find rocks that are composed of two minerals, more that are composed of three, and still more that are composed of more than three, and with the widest possible variations in the proportions of almost all, with the exceptions noted above as to the non-coexistence of quartz with nephelite and leucite, and its rarity with olivine.

CHEMICAL CONSTITUENTS OF IGNEOUS ROCKS.

From what has been said it would appear that the various oxides (in terms of which the chemical composition of rocks is usually formulated) may be present in widely different amounts, and, within limits, this is found to be true. All of the constituent oxides have very considerable quantitative ranges, but these differ much with the different oxides. Their possible or recorded maxima are also very different, though in every case the minimum is reached with complete absence. These ranges and maxima will be stated later, after a brief discussion of the oxides that go to make up the igneous rocks.

Though, as we have seen, most igneous rocks are composed of but few essential minerals, and consequently of but few so-called "major" oxides, yet when we come to study them in detail we find that a very considerable number of different chemical constituents may be present

in the different rocks. Altogether, about 23 are to be found, and are more or less commonly determined and recorded among the better-class rock analyses. Indeed, as has been said by Dr. W. F. Hillebrand, the foremost analyst of rocks, "a sufficiently careful examination of these [igneous] rocks would show them to contain all, or nearly all, the known elements, not necessarily all in a given rock, but more than anyone has yet found." Proper study, therefore, of the chemistry of igneous rocks, and their chemical analysis, if this be complete as to the determination of all the constituents probably present, is evidently a somewhat complicated matter, and one not without difficulties of various kinds.

From the many chemical analyses of rocks that have been made since this was first attempted very early in the nineteenth century (the total number of published rock analyses is now about 12,000), we have a good idea of what chemical constituents make up rocks, their relative abundance, and their various ranges in percentage.

By far the most important and generally the most abundant are what are called the "major" constituents. These are nine in number and, stated as oxides, are: Silica (SiO_2), alumina (Al_2O_3), ferric oxide (Fe_2O_3), ferrous oxide (FeO), magnesia (MgO), lime (CaO), soda (Na_2O), potash (K_2O), and water (H_2O).⁴ Together these nine oxides make up about 98 per cent of igneous rocks, and all of them are present in greater or less amount in practically every rock, so that the amount of each must be determined in every chemical analysis of a rock that makes the slightest pretense to good quality.

As the most abundant and essential rock minerals are either silica or silicates, and as all igneous rocks, with the exception of some rare and small iron ore bodies of magmatic origin, are consequently silicate rocks, silica shows easily the highest maximum and the widest range, both in extremes and in the usual run of occurrence. A few igneous rocks are known that are composed almost entirely of quartz,⁵ and the highest silica percentages recorded for igneous rocks are 98.77 and 97.65, in rocks from the Transvaal, while one from Cumberland (England), the border facies of a granitic mass, shows 96.16, one from Massachusetts shows 93.38, and one from Arizona 92.59. In general, however, the percentage of silica ranges from about 75 to about 34, and it drops to zero only in some "magmatic" iron-ore bodies. In almost all rocks it is the most abundant constituent.

Alumina, which is almost invariably the next most abundant constituent, reaches a maximum of about 60 per cent in some corundum-bearing syenites from Canada and the Urals, and has a general

⁴ This order is not quite that of relative abundance, but that which is commonly used in the statement of rock analyses.

⁵ Quartz veins are not considered here, as they are usually of nonigneous origin, at least in the commonly accepted sense.

range from about 20 to about 10. It is wholly absent only in the "magmatic" ores and in some rocks that are composed entirely, or almost so, of olivine. The two oxides of iron reach, of course, their maxima in such rocks as the iron ores already spoken of;⁶ the highest figures recorded for Fe_2O_3 being 88.41 (Sweden) and 62.39 (Ontario), while for FeO they are 34.58 (Sweden) and 32.92 (Minnesota). Their general range is from nearly 15 for each (FeO generally higher than Fe_2O_3) and but little more than that for both together in any one rock to less than one-half of 1 per cent. Iron is seldom entirely absent.

Magnesia reaches its maximum in the almost purely olivine rocks (dunites) of North Carolina, 48.58, and of New Zealand, 47.38, but its general range is from about 25 to much less than 1 per cent. Lime is highest (22.52) in some pyroxenites of the Urals and almost as high (about 20) in the anorthosites of Canada and elsewhere, but it ranges in general from about 15 to nearly zero.

Of the two alkalis, soda reaches a maximum of 19.48 in a rare rock from Canada, and of 18.67 in another from Turkestan; but its general range is from about 15 per cent down to nearly zero. It is hardly ever entirely absent. Potash shows a somewhat smaller range than soda, its maximum being 17.94 in a recently discovered lava from Italy, the next highest figure being 11.91, from Wyoming; but in general it seldom gets above 10 per cent, ranging from that down to zero. Its amount is generally less than that of soda.

As regards water, the last of the major constituents, a few volcanic glasses are known which, although perfectly fresh and undecomposed, contain up to 8 or 10 per cent, and there are some fresh crystalline rocks that contain from 3 to 5 per cent. Generally, however, if a rock contains more than about 2 per cent of H_2O this can usually be attributed to alteration, though few rocks are quite free from this constituent.

After the major come the "minor" constituents, which are almost always present in very small amounts, seldom over 2 per cent for any one, or rarely up to 5 per cent for all of them, in any one rock. Of these minor constituents three are of special importance, partly because of their almost constant presence and partly because they are generally present in largest amount. These three are titanium dioxide, phosphorus pentoxide, and manganous oxide, and all three should be determined in a good rock analysis.

Titanium dioxide (TiO_2) reaches a maximum in some very rare rocks from Virginia (69.67 and 65.90) and Quebec (53.35), but as a general thing its percentage is seldom over 5, and is mostly from about

⁶ It is a question whether all of these ore bodies are to be considered as really igneous rocks, though some undoubtedly are.

2 to nearly zero. Of the many rocks of all kinds that I have analyzed, there has not been a single one that did not contain titanium, in some cases in very small, but always in easily determinable, quantity. This is also the experience of Doctor Hillebrand,⁷ and probably of every other experienced analyst of rocks.

The maximum for phosphorus pentoxide (P_2O_5) is but a little above 16 per cent in some highly unusual rocks from Sweden and Virginia, that are composed largely of apatite, with titaniferous magnetite or rutile. In few rocks, however, is it above 3 per cent, and its general range is from about 1 per cent to zero. It does not seem to be present so constantly as titanium (or manganese), as one occasionally meets with a rock that shows no trace of it, though this may be because of the more delicate tests for the other two.

Manganese, as manganous oxide (MnO), is present in practically every rock that has been analyzed, but its maximum is much lower than those of titanium and phosphorus oxides. Some, if not most, of the high figures reported for it are almost certainly due to analytical errors, and the highest recorded figures that are trustworthy are 1.90 and 1.46 in two rocks from Bahia, Brazil. Its general range is from 0.3 per cent to nearly zero.

The other minor constituents that are readily determinable, and many of which are indeed determined in good analyses, are quite varied. The list is as follows: Carbon dioxide (CO_2), zirconia (ZrO_2), chromium sesquioxide (Cr_2O_3), vanadium sesquioxide (V_2O_3), the "rare earths" ($(Ce, Y)_2O_3$), nickel oxide (NiO), strontia (SrO), baria (BaO), lithia (Li_2O), sulphur as both sulphide (S) and sulphur trioxide (SO_3), chlorine (Cl), and fluorine (F). To these might be added boron, cobalt, copper, glucinum, lead, molybdenum, nitrogen, and zinc, which, however, are present almost always in such extremely small amounts, or the analytical difficulties are so great for the separation of the small quantities in which they occur, that their determination is rarely attempted.

The maxima and ranges of some of these may be briefly stated. Carbon dioxide may be present, as a component of a few minerals (as in primary calcite and cancrinite), in some unaltered rocks; but its presence is generally due to alteration. In one calcite trachyte from Spain its amount is 7.69 per cent, and in cancrinite rocks it may reach about 1.70, the carbonate minerals in these being apparently primary. But it is generally considered as a measure of the alteration of the rock by weathering.

Zirconia is much less abundant than the closely related titania and, though it reaches a maximum of nearly 5 per cent in some Greenland rocks, in general it seldom is over 1 per cent, is usually much

⁷ Hillebrand, W. F., U. S. Geol. Survey Bull. No. 700, p. 25, 1919.

less, and is quite absent from most rocks. It forms, by the way, one of the most striking illustrations of the correlation of the occurrence of different elements in different kinds of rocks, as will be brought out later.

Baria and strontia are very commonly present, though they are seldom determined in analyses made outside of the United States, Canada, and Australia. In almost every case the amount of baria is much greater than that of strontia, this being an exception to a general rule as to the occurrence of related elements, to be mentioned later. They both reach their maxima in certain exceptional, highly potassic rocks of Wyoming, of about 1 per cent for baria and 0.3 for strontia; though usually baria is present up to but a few tenths of one per cent, and strontia in hundredths.

Sulphur, as sulphides, is present up to about 9 per cent in a peculiar, pyrrhotite-bearing rock from Maine, and probably in similar amounts in some sulphide ore bodies of magmatic origin in Norway, which have not been fully investigated. But, as a rule, its amount is seldom over 1 or 2 per cent, and is usually in tenths of a per cent. The highest figures for sulphur trioxide are about 2.5 per cent in rocks from Apulia and Kamerun, and somewhat lower on Tahiti, but these are exceptional, and it is usually present only in tenths or hundredths of a per cent. Much the same can be said of chlorine, the highest figures for which are those of a rock from Turkestan (about 7), one from Quebec (4.47), and one from French Guinea (2.80). It is present in many rocks, especially lavas, but only in a few tenths or hundredths of a per cent.

Chromium sesquioxide is known to be present up to about 4 per cent in some ores from Greece, which are probably of magmatic origin, and is reported as between 2 and 3 per cent in some undoubtedly igneous rocks from Baden. But these are highly exceptional, and about 0.5 may be taken as its usual maximum. It is generally entirely absent. Vanadium sesquioxide is always present in much less quantity and is usually quite absent. The oxides of the rare earth metals, chiefly ceria and yttria, reach a maximum of 1.79 in a rare type of rock from Madras, 0.6 in one from Sweden, and 0.4 in one from the islet of Rockall, but the usual maximum is only one or two tenths of 1 per cent. They are less often determined than they should be. Nickel oxide is present in some rocks up to about 0.2 per cent. The maximum amount of each of the other minor constituents may be placed at not over 0.5 per cent, and they are almost always found only as one or two tenths, or still more often as hundredths, of a per cent, or are absent. Indeed, for most of the minor constituents the quantities usually yielded by analysis are so small as to be significant only as to their actual presence or absence.

A few words may be said of boron, glucinum (beryllium), and scandium, as these enter into a later phase of the subject. The analytical difficulties involved in their determination, for the extremely small amounts that are present, are so great that the percentage of these is seldom recorded for any rock. Yet they are all known to be rather widely distributed among the igneous rocks, boron in tourmaline, glucinum in beryl, and both in some other rarer minerals, while the widespread occurrence of scandium among igneous rocks, though in very small amounts, has been shown spectroscopically.⁸

THE AVERAGE IGNEOUS ROCK.

We come now to the consideration of the average chemical composition of the earth's crust—that is, of all igneous rocks. Apparently Dr. F. W. Clarke was the first to undertake this estimation,⁹ basing his conclusions largely on the numerous analyses that had been made by the chemists of the United States Geological Survey. Since then he and others, Harker, Mennell, Knopf, Mead, and the writer, have published other estimates, which, it may be said here, do not differ greatly the one from the other. The latest discussion of this subject is to be found in the last edition of Clarke's *Data of Geochemistry*,¹⁰ where numerous references to the literature are given.

The true estimation of the average chemical composition of the igneous rocks is by no means such a simple matter as it may appear to be at first thought, and, before we deal with it, it will be as well to state very briefly some of the disturbing factors that are involved. The matter will be treated in greater detail in a forthcoming paper by Dr. Clarke and the writer.

In the first place, we know but little of the exact chemical characters of the igneous rocks of many districts of the earth. This is true of the great continents of Asia and South America, as well as of Africa and Australia, in all of which we have for the most part a knowledge only of the rocks more or less near the coasts and know only in a general and very imperfect way the rocks that constitute the vast expanses of the interior portions. The same ignorance, either total or partial, holds true for many countries, such as China, Arabia, and even Brazil, India, Egypt, and Spain, in which the number of analyses is quite disproportionate to the number and masses of igneous rocks that are known to occur. A most striking example is furnished by the West Indies, where, of the igneous rocks of the otherwise well-known and readily accessible larger islands

⁸ Eberhard, C., Sitzb. kg. preuss. Akad. Wiss., 1908, p. 851.

⁹ Clarke, F. W., Bull. Phil. Soc. Wash., xi, p. 131, 1889; also U. S. Geol. Survey, Bull. 78, p. 34, 1891.

¹⁰ Clarke, F. W., U. S. Geol. Survey, Bull. 695, pp. 24 ff., 1920.

of Cuba, Jamaica, Porto Rico, and Haiti, we do not possess a single analysis.

Most of the countries of Europe are well represented, but for the most part with not very complete analyses. North America is well known, especially as to the rocks of the United States and southern Canada. The analyses of both these countries are of exceptionally high general quality. Parts of Australia, especially New South Wales, Victoria, and Queensland, with New Zealand, are well represented, as is also British Guiana, and it should be said that the analyses of Australia and British Guiana rocks are almost the only ones that, as a whole, are comparable as to accuracy and completeness with those of the United States, which holds a preeminent position through the labors of the chemists of the United States Geological Survey.

A second disturbing factor, and one that has been often advanced against the validity and representativeness of the estimates of the average composition of rocks, is that the true relative amounts of various rocks are not properly represented because of the selection of material for analysis. It has frequently happened that the petrographer has had analyzed rather the rare or most interesting rock types than those which, though much more abundant in the region described, are of more usual character. While this is often to be expected and, from a special point of view, is almost justifiable, yet it certainly may involve a serious disturbance in the estimation of the composition of the crust as a whole. This is so, because the most interesting types, often ipso facto, are much less abundant than the common ones, so that, as regards the relative masses of the various kinds of rocks in any given region, they are disproportionately represented. It is needless here to give examples, of which there are very many; it would lead us too far into the technicalities of petrography.

Although this objection is serious, and is entitled to consideration, yet it would seem, on detailed examination, not to be of the overwhelming character that is often attributed to it. For one thing, the satellitic rocks of the dikes and other small bodies (which are most prone to furnish "interesting" types), tend to be complementary to each other, through processes of differentiation, and so, as Dr. Clarke, says, "they tend to compensation, and so to approximate to the true mean." Also, as in a number of examples from many localities that could be cited, only the main body or the most prominent types have been analyzed, chiefly because of the labor or expense of making chemical analyses of rocks. Again, as I have pointed out elsewhere, the more "basic" rocks—that is, those that are lowest in silica and highest in iron oxides, magnesia, and lime—are most liable to alteration, so that many of their analyses would be ex-

cluded from the data selected for our purpose, for which only analyses of fresh and unaltered rocks are considered.

These, and other considerations that might be mentioned, tend to minimize the rather prevalent idea that the averages, such as have been calculated in former years by Dr. Clarke and me, are not strictly representative, in that the well-known apparent preponderance of granitic rocks is not sufficiently emphasized. Attempts have been made by some to correct such errors by weighting the average analyses of the various rock types by their areal values.¹¹ Such a procedure, however, is open to two objections: As much weight is thus allowed for lava flows, of manifestly small vertical extension, as for massive intrusive bodies presumably of much greater depth; and, as Clarke points out, "the surface exposure of a rock is no certain measure of its real volume and mass, for it may be merely the peak or crest of a large formation."

But the serious objection to any such attempts at correcting what may be, and often admittedly are, defects in our data, is that they introduce unduly the personal equation, and thus may, or are likely to, introduce other errors of unknown and indeterminate magnitude. As has been shown very briefly above, we are as yet in great ignorance as to the igneous rocks of a large portion of the earth's surface and crust, and it would seem to be the philosophical attitude to admit this and, as Dr. Clarke¹² says, "do the best we can with the available data." They are admittedly not ideal, but an attempt to better them, at this stage of our knowledge, is more likely than not to make a "bad matter worse." Let us be philosophical Italians for a moment, and say with them, "C'ì vuol pazienza."

Apart from such fundamental considerations of the character of our basal data as have been all too briefly touched on above, we meet with others when we come to consider the analyses themselves. No analyses are ideally perfect, either as to accuracy or completeness, but, while it is obviously the desirable procedure to exclude from our data rock analyses that may not be up to the ideal mark that we may set, yet, by so doing, we shall inevitably reduce the number of our data so as probably to more than offset their excellence in quality. We should have and use, of course, only analyses that are perfectly accurate and complete as to the determination of all the constituents that may be present. But, "humanum est errare," and so we must here also "do the best we can with the available data," excluding, of course, from consideration analyses that are manifestly bad. Con-

¹¹ Daly, R. A., *Igneous Rocks and Their Origin*, New York, 1914, pp. 19-46, 168-170; and Knopf, A., *Jour. Geol.*, xxii, p. 772, 1914.

¹² Clarke, F. W., *Proc. Amer. Phil. Soc.*, II, p. 215, 1912.

sideration of this topic would lead us too far astray but it will be found discussed elsewhere.¹³

It may also be mentioned here that, as some of the minor constituents are, in the course of analysis, precipitated and weighed with others, and are later determined separately and subtracted from the previous total figure, if these are not determined the figure for the main constituent will be too high. This is notably the case with alumina, with which are precipitated and weighed the oxides of titanium, phosphorus, rare earth metals, zirconium, chromium, and vanadium, with often some manganese. If the analysis is not complete as regards these constituents, therefore, the figure for alumina will be too high.

As has been said above, the average composition of the igneous rocks has been estimated by several petrologists—Clarke, Harker, Loewinson-Lessing, Daly, Knopf, Mead, and myself. Clarke based his earlier estimates very largely on the analyses of rocks from the United States, as did Knopf, while Harker's average was of rocks from Great Britain alone. In his latest estimates Clarke included rocks from all over the globe, as did I in my own computation. This also was the basis of Daly's and Mead's computations, though in both their estimates, which were founded largely on personal selection of what constituted "types" of various rocks, the personal equation enters somewhat unduly. As we shall see later, continental averages, or others selected from regional data, differ too much to be representative of the average composition of the whole "crust."

The basis for the present, and latest, estimate was the collection of rock analyses that has recently been published.¹⁴ This includes practically all the analyses of igneous rocks, from all over the earth, that have been published between 1883 and 1913, inclusive. These amount to 8,602 analyses, of which 5,159 of fresh rocks were considered to be "superior"—that is, satisfactory as to accuracy and completeness. Only these 5,159 analyses were used. The computations of the various averages, for the whole earth, the continents, and various districts of the earth's surface, were made by Dr. F. W. Clarke during the summer of 1919. To him I am greatly indebted for his very painstaking and laborious undertaking, and would express my great appreciation of his kindness in permitting the present publication of some of his results. It must be said that there are presented here only a few of these, and that all the data in detail, with certain considerations of them, are to be published by us jointly in the near future, as a Professional Paper of the United States Geological Survey.

¹³ Washington, H. S., U. S. Geol. Survey, Prof. Paper No. 99, pp. 10-26, 1917.

¹⁴ Washington, H. S., U. S. Geol. Survey, Prof. Paper No. 99, 1917.

TABLE I.—Average composition of the earth's crust.

	1	2	3	4
Silicon dioxide (SiO ₂)	59.09	58.59	57.78	59.83
Aluminum sesquioxide (Al ₂ O ₃)	15.35	15.04	15.67	15.02
Ferric oxide (Fe ₂ O ₃)	3.08	3.94	3.31	2.62
Ferrous oxide (FeO)	3.80	3.48	3.84	3.43
Magnesium oxide (MgO)	3.49	4.49	3.81	3.74
Calcium oxide (CaO)	5.08	5.29	5.18	4.83
Sodium oxide (Na ₂ O)	3.84	3.20	3.88	3.37
Potassium oxide (K ₂ O)	3.13	2.90	3.13	3.05
Water (H ₂ O)	1.14	1.96	1.76	1.90
Titanium dioxide (TiO ₂)	1.05	.55	1.03	.79
Phosphorus pentoxide (P ₂ O ₅)	.30	.22	.37	.29
Manganous oxide (MnO)	.125	.10	.22	.10
Carbon dioxide (CO ₂)	.102	.37		.49
Zirconium dioxide (ZrO ₂)	.039			.023
Sulphur (S)	.053	.034		.10
Chlorine (Cl)	.056	.012		.063
Fluorine (F)	.078			.10
Chromium sesquioxide (Cr ₂ O ₃)	.056	.021		.048
Vanadium sesquioxide (V ₂ O ₅)	.032			.026
Nickelous oxide (NiO)	.025			.026
Barium oxide (BaO)	.055	.033		.10
Strontium oxide (SrO)	.022	.009		.043
Lithium oxide (Li ₂ O)	.007	.011		.011
	100.000	100.250	100.00	100.000

1. Latest estimate, Clarke and Washington, 1920.

2. F. W. Clarke (first estimate). Bull. Phil. Soc., Wash., xi, p. 135, 1889.

3. Washington, U. S. Geol. Survey, Prof. Paper No. 99, p. 103, 1903.

4. Clarke, U. S. Geol. Survey Bull., No. 695, p. 23, 1920.

In Table I there is given the most recent calculation of the average igneous rock, together with three of the most important of the earlier estimates. As regards No. 1, it is to be noted that the figures for the main constituents, from silica to water, inclusive, were arrived at by dividing the sums total of the various determinations by the whole number of analyses, as all of these constituents were determined in all the analyses used. For the minor constituents, from titanium dioxide to lithium oxide, inclusive, the figures given are the means of the sums total of the various constituents divided by the whole number of analyses and also by the number of determinations. The former would presumably give a minimum and too low an average and the latter would probably be too high, while the mean would be probably rather nearer the true figure. This matter has been discussed by Clarke and by me elsewhere, and will be enlarged on further in our joint publication. The figures given here should be considered as provisional, as adequate discussion of their relative merits is not called for here. The figure for fluorine is almost certainly too high, as are probably those for chromium, barium, and one or two other oxides, while possibly that for carbon dioxide is a trifle too low.

From No. 1 it will be seen (and the same is approximately true of all the others) that the first nine oxides (from silica to water, inclusive) constitute 98 per cent of the whole, and that these, with the oxides of titanium, phosphorus, and manganese, make up to-

gether 99.475 per cent of the crust, leaving only a trifle more than one-half of 1 per cent for all the other oxides.

Thus we see that in round numbers silica is the most abundant, and constitutes about six-tenths (nearly two-thirds) of the crust; alumina is next—a very poor second—slightly more than one-seventh; then the two iron oxides, together about one-twelfth; lime, about one-twentieth; soda, about one twenty-fifth; magnesia, about one-thirtieth; potash, about one thirty-third; water and titanium dioxide, each about one one-hundredth; phosphorus pentoxide, about one three-hundredth, and manganous oxide about one eight-hundredth, while carbon dioxide is about one one-thousandth. Each of the others is notably less than one one-thousandth. It will be observed that in the list, which includes all the constituents that may be commonly determined in really good and complete analyses of igneous rocks, neither copper, lead, tin, zinc, mercury, silver, gold, platinum, arsenic, antimony, nor several other of the elements commonly used in daily life are represented. The only common metals shown are iron, aluminum, manganese, and nickel. This is a rather important point that will be adverted to later.

In order to form an idea of the actual rock that a magma of this average composition would form under normal conditions we must calculate, from the data given by the analysis, the presumable actual mineral composition, or the "mode," as it is technically called. There are two general and important conditions controlling the products of solidification that may be considered. The magma may have solidified, at considerable depth, slowly and under great pressure; or it may have solidified, as a lava flow, on the surface; that is, rapidly and under low pressure. The former would furnish what is called a plutonic rock (as a granite or a gabbro), and the latter an effusive one (as a rhyolite or a basalt); and the different conditions of solidification would bring about certain changes in the mineral composition of the resulting rock.

Such a calculation leads to the following results, which are to be considered as only approximately correct, as variations in the mode, of slight extent but in different directions, may be brought about by slight variations in the conditions of solidification. As a plutonic rock the magma would form a so-called granodiorite; that is, a rather coarse-grained, holocrystalline rock, much like many granites (and which would be commonly called a rather dark granite), composed of feldspar, quartz, hornblende, or biotite, and very small amounts of magnetite and apatite. If it solidified under surface conditions, the magma would form that most common kind of lava, an andesite, rather fine-grained, light gray or pinkish, and showing small crystals ("phenocrysts") of feldspar and either hornblende or pyroxene, with perhaps a little biotite, in a dense "groundmass." Under the

microscope the groundmass would show feldspars, pyroxene (or hornblende), and possibly a little quartz, with small grains of magnetite and apatite, and with or without glass, according to the rapidity of cooling.

Stated in quantitative terms of "modal" or actual minerals, the rocks would have probably the following approximate compositions:

	Grano- diorite.	Ande- site.
Quartz.....	11	10
Andesine (Na-Ca feldspar).....	47	47
Orthoclase (K feldspar).....	16	18
Hornblende and biotite.....	20	} 19
Pyroxene.....		
Magnetite.....	5	5
Apatite.....	1	1

It will be seen that, in either case, the average rock would be composed entirely of the most common minerals, as is to be expected, with the exceptions of olivine, nephelite, and leucite, which are much less often met with and which, furthermore, are not found in rocks with an excess of silica, as is true of the average rock. Inasmuch as the average rock would have been formed at some depth beneath the surface, the average crust may be considered to be a granodiorite, with the general characters and mineralogical composition described briefly above. The fact, however, must not be lost sight of that locally the crustal rock may vary within very wide limits, as will be pointed out later. We are dealing here only with the average of the crust as a whole.

We may examine the chemical composition of the earth's crust in greater detail and, as has been done by Clarke in the papers cited above, reduce the figures of the analysis to the form of the component elements. The results are given in the annexed Table II, there being here presented, not only the elementary constituents of the average rock given in Table I, but in addition data showing the relative abundance of some other of the more important elements that are not usually, or indeed are never, determined in the analyses of rocks. The data for these are taken from estimates by Vogt, De Launay, and Kemp, with additional data by Clarke and Steiger for a few, and some additions and changes in relative position based on my own studies. An "x" means a digit in the respective decimal place or places. The elements are presented in their order of relative abundance. This estimate is to be regarded as provisional.

This average, it must be repeated, does not include the sedimentary rocks or constituents of the hydrosphere or of the atmosphere. Clarke has included these in several of his estimates, and his latest shows that the percentage, on this basis, of oxygen is 50.02, of silicon 25.80,

of aluminum 7.30, and of the other most abundant elements in similarly slightly less amounts than in Table II. When thus reckoned chlorine and carbon fall in between titanium and phosphorus, with percentages, respectively, of 0.29 and 0.18, while nitrogen appears between chromium and zirconium with a percentage of 0.03.

Leaving these refinements out of consideration here, there are some striking features presented in the table to which attention may be called. The first is the appearance among the abundant elements of some that are usually counted as rare. Among these are especially

TABLE II.—*The chief elements in the earth's crust in order of abundance.*

1. Oxygen.....	46.43	24. Copper.....	0.002
2. Silicon.....	27.77	25. Cerium, etc.....	.001
3. Aluminum.....	8.14	26. Glucinum.....	.00xx
4. Iron.....	5.12	27. Cobalt.....	.00xx
5. Calcium.....	3.63	28. Boron.....	.000x
6. Sodium.....	2.85	29. Zinc.....	.000x
7. Potassium.....	2.60	30. Lead.....	.000xx
8. Magnesium.....	2.09	31. Arsenic.....	.000xx
9. Titanium.....	.629	32. Cadmium.....	.0000xx
10. Phosphorus.....	.130	33. Tin.....	.0000xx
11. Hydrogen.....	.127	34. Mercury.....	.0000xx
12. Manganese.....	.096	35. Antimony.....	.0000xx
13. Fluorine.....	.077	36. Molybdenum.....	.0000xx
14. Chlorine.....	.055	37. Silver.....	.00000xx
15. Sulphur.....	.052	38. Tungsten.....	.00000xx
16. Barium.....	.048	39. Bismuth.....	.00000xx
17. Chromium.....	.037	40. Selenium.....	.000000xx
18. Zirconium.....	.028	41. Gold.....	.000000xx
19. Carbon.....	.027	42. Bromine.....	.000000xx
20. Vanadium.....	.021	43. Tellurium.....	.0000000xx
21. Nickel.....	.019	44. Platinum.....	.0000000xx
22. Strontium.....	.018		
23. Lithium.....	.003		
			100.000

titanium, barium, chromium, zirconium, vanadium, nickel, strontium, and lithium, with copper, cerium, glucinum, cobalt, and boron among those to which no definite figures can be assigned as yet. Titanium occupies the ninth place among the elements (tenth among the oxides), although it is usually considered a "rare" element, and its name and existence are possibly unknown to many persons. The establishment of this fact, probably a very important one in our study of the constitution of the earth, is due primarily to the chemists of the United States Geological Survey, who, under the leadership of Dr. W. F. Hillebrand beginning in the early eighties of the last century, first began to determine the "rarer" elements in their analyses of the rocks of this country. Similarly, they found that some others of the sup-

posedly rare elements are widely distributed, notably barium, strontium, chromium, vanadium, nickel, and even molybdenum.¹⁵

In Table II it is also noteworthy that, of the metals in daily and common use, only aluminum, iron, manganese, chromium, vanadium, and nickel appear among those elements that are present in the rocks of the crust in sufficient amount to be commonly determinable by the usual processes of analysis. Such common and "every-day" metals as copper, zinc, lead, tin, mercury, silver, gold, platinum, antimony, arsenic, and bismuth—metals that are of the utmost importance to our civilization and our daily needs—all these are to be found in igneous rocks, if at all, only in scarcely detectable amounts. Though they are ultimately derived from the igneous rocks, they are made available for our use only by processes of concentration into so-called ore bodies.

To give some concrete and striking figures, it may be pointed out that the eight most abundant elements of the earth's crust (oxygen, silicon, aluminum, iron, calcium, sodium, potassium, and magnesium)—the only ones whose amounts are over 1 per cent—constitute together 98.63 per cent of the crust. These, with titanium, phosphorus, hydrogen, and manganese—12 in all—make up 99.612 per cent; thus leaving but about 0.39 per cent for all the other elements, among them some that are quite indispensable for our existing civilization.

A cursory examination shows that the most abundant elements in the earth's crust are, on the whole, those of low atomic weight, as has been often pointed out, while the rarer ones are, in general, those of higher atomic weight. It has also been pointed out by Clarke¹⁶ that, considering the several elements of any group in the periodic table (for which see p. 289), while the first member is comparatively rare, the second is the most abundant (the oxygen group being the only exception), and the members become increasingly rare with increasing atomic weight. This is well seen, for example, in group 1 (lithium, sodium, potassium, rubidium, and cesium); in group 2 (glucinum, magnesium, calcium, strontium, and barium), though here we have inversions of the rule in the relative abundance of magnesium and calcium, and of strontium and barium. It is also seen in the third group (boron, aluminum, scandium, gallium, etc.); in the fourth group (carbon, silicon, titanium, zirconium, and cerium); in the fifth (nitrogen, phosphorus, arsenic, and antimony); in the sixth (oxygen, sulphur, selenium, and tellurium), here again there being an inversion as regards the first and second; and in the seventh (fluorine, chlorine,

¹⁵ Cf. Hillebrand, *Jour. Amer. Chem. Soc.*, xvi, pp. 81-93, 1894; *Amer. Jour. Sci.*, vi, p. 209, 1898; *U. S. Geol. Survey, Bull.* 700, p. 24, 1919.

¹⁶ Clarke, F. W., *Data of Geochemistry*, *U. S. Geol. Survey, Bull.* 695, p. 39, 1920.

bromine, and iodine). It is also seen in group 8, in the case of iron, nickel, and cobalt, according to their atomic weights, though the atomic numbers of nickel and cobalt are reversed in order. As Clarke says: "We are dealing with an evident tendency of which the meaning is yet to be discovered. That the abundance and associations of the elements are connected with their position in the periodic system seems, however, to be clear. The coincidences are many, the exceptions are comparatively few."

The relation of the abundance of the elements to the periodic law has also been discussed recently by Harkins,¹⁷ who holds that the abundance of the elements is "related to the atomic number and not to the periodic system," that the abundant elements are those of low atomic weight with an atomic number less than 29, and that the elements with even-numbered atomic numbers surpass in abundance the odd-numbered. It would take us too far from our proper subject to discuss this very interesting topic here, but we may examine briefly a hitherto unrecognized phase of the relation of the occurrence of the elements to their position in the periodic table, shown by the study of minerals and of igneous rocks, and taking into consideration the chemical relations of the various elements.

THE PETROGENIC AND METALLOGENIC ELEMENTS.

In Table III is presented the periodic classification of the elements, as usually given.¹⁸ The atomic weights are stated in round numbers, most of the elements of the "rare earths" are omitted, as their relative positions are still in dispute, as are also the radio-active elements, except radium.

Here, as has been commonly recognized, the most abundant elements in the earth's crust, being of generally low atomic weight (or atomic number), occupy the upper part of the scheme, forming the series 1 to 4 of groups 1 to 8. These, with some others in series 6 and 8 to be mentioned presently, may be called the "rock elements," as they are the essential elements, in greater or less amount, of the igneous rocks of the earth's crust, of which they constitute at least 99.9 per cent by weight.

In the lower part of the scheme are elements of higher atomic weight which, with others, in series 5 and 7, to be mentioned later, are but seldom, if ever, found in determinable quantities in igneous rocks, but which occur chiefly as ores, or as native metals. These may therefore be called the "ore elements." There would seem to

¹⁷ Harkins, W. D., Jour. Amer. Chem. Soc., xxxix, p. 856, 1917.

¹⁸ This table is based on that given by Clarke, U. S. Geol. Survey, Bull. 695, p. 37.

TABLE III.—Periodic classification of the elements.

	Group 0.	Group 1.	Group 2.	Group 3.	Group 4.	Group 5.	Group 6.	Group 7.	Group 8.
1		H 1							
2	He 4	Li 7	Be 9.1	B 11	C 12	N 14	O 16	F 19	
3	Ne 20	Na 23	Mg 24.4	Al 27.0	Si 28.3	P 31	S 32	Cl 35.5	Fe 55.9 Co 59 Ni 58.7
4	A 39.9	K 39.1	Ca 40.1	Sc 45	Ti 48.1	V 51	Cr 52.1	Mn 55	
5		Cu 63.6	Zn 65.4	Ga 70	Ge 72.5	As 75	Se 79.2	Br 79.9	
6	Kr 82.9	Rb 85.5	Sr 87.6	Yt 88.7	Zr 90.6	Cb 93.5	Mo 96	—	Ru 101.7 Rh 103 Pd 106.5
7		Ag 107.9	Cd 112.4	In 115	Sn 118.7	Sb 120.2	Te 127.5		
8	Xe 130.2	Cs 132.9	Ba 137.4	La 138.9	Ce 140.3				
9				Rare earth metals.					
10						Ta 181	W 184		Os 191 Ir 193.1 Pt 195.2
11		Au 197.2	Hg 200.6	Tl 204	Pb 207.1	Bi 209			
12	Nt 222		Ra. 226	Th 232.5			U 238.2		

be a very definite and distinctive difference between these two groups as regards their general chemical relations—a difference that has apparently not heretofore been observed.

Intermediate between the upper and lower part of the scheme is a zone, series 5 to 8, including elements that our study of minerals and rocks shows to belong partly to the rock elements, and partly to the ore elements. It is found that their relations to the one or the other are clearly distinguished by tracing a meander that separates them into alternate or interlocking vertical columns, the spaces thus made opening above into the division of the rock elements and below into that of the ore elements. Thus, as we shall see, Rb and Cs, Sr and Ba, Yt and La, Zr and Ce, Cb?, and Mo are to be considered as rock elements; while Cu and Ag, Zn and Cd, Ga and In, Ge and Sn, As and Sb, S, Se, and Te, and Br and I, are ore elements. These differences are indicated by some of their general chemical relations and by the facts of their occurrence as minerals—that is, as components of the earth's crust.

Flanking the main part of the table is group 0, the column of the inert gases, from helium to niton. At the bottom are the radioactive elements, chiefly radium, thorium, and uranium, with others (some more or less hypothetical) that have been recently discovered. On the right is the column of group 8, that of the triads. Of these, iron, cobalt, and nickel are to be considered as rock elements, and the two triads of the platinum metals as ore elements.

It may be as well to suggest here, and to use henceforward, two terms as a matter of convenience. We may call the "rock elements" *petrogenic* and the "ore elements" *metallogenic*. These terms are not only short and self-explanatory but, having an adjectival form, are convenient for use. The distinctive chemical differences between the petrogenic and the metallogenic groups of elements, as regards their *occurrence in the earth's crust*, will be now set forth; and, it may be said, these differences seem to divide them into two "natural" groups, which may be of significance in a study of the constitution of the earth. In the present paper it is best not to go very deeply into technical mineralogical details, and only the main facts will be stated, leaving the details for presentation elsewhere.

The petrogenic elements occur normally in nature as primary minerals, forming oxides, silicates, fluorides, and chlorides; but never, or only exceptionally, as sulphides, selenides, tellurides, arsenides, antimonides, bromides, or iodides. With the exceptions of iron and nickel they are never found in the form of native metals. The metallogenic elements, on the other hand, normally (as primary minerals) form sulphides, selenides, tellurides, arsenides, antimonides, bro-

mides, or iodides, but only seldom and exceptionally do these occur as (primary) silicates, oxides, fluorides, or chlorides. They are frequently met with as the "native" elements. There are, it is true, some exceptions to these statements (as with iron, which forms three common sulphides, and with tin which occurs mostly as the oxide); but taken broadly, and as applying to the two several groups as a whole, the distinction seems to be valid.

The oxides of many of the electropositive petrogenic elements are known to occur as minerals; those, that is, that are stable and are not readily soluble. They include periclase (MgO), corundum (Al_2O_3), quartz and tridymite (SiO_2), rutile (TiO_2), ilmenite ($(Fe, Ti)_2O_3$), chromite ($FeO.Cr_2O_3$), pyrolusite (MnO_2) and other oxides of manganese, hematite (Fe_2O_3) and magnetite (Fe_3O_4). All of the electropositive petrogenic elements form silicates, and, indeed, they form the overwhelming majority, certainly 99.9 per cent by weight of all known silicates. Besides the simple silicates are borosilicates, fluosilicates, titanosilicates, and zirconosilicates, all of them salts of petrogenic elements. A few sulphosilicates are known, but they are very rare, and there are no known arseno-, antimonio-, seleno-, or tellurosilicates.

Fluorides and chlorides of sodium, potassium, ammonium, magnesium, calcium, aluminum, cerium, iron, and manganese are known as minerals, and some of them are very common, as $NaCl$, KCl , and CaF_2 . On the other hand, neither bromides nor iodides of these elements occur as minerals, though there is an excessively rare calcium iodate. Fluorine replaces hydroxyl in several silicates, as in topaz and chondrodite, and it is also present in small amounts in hornblendes and micas, while chlorine is present in small amount in some silicate minerals, as those of the sodalite and scapolite groups. Until we reach vanadium, with atomic weight 51 and atomic number 25, no sulphides occur as minerals, except calcium sulphide, which occurs as a rare mineral (oldhamite) but only in a few meteorites. A very rare vanadium sulphide, found only in one locality, an extremely rare chromium-iron sulphide, occurring only in a few meteorites, and a rare terrestrial manganese sulphide are known. No arsenides, selenides, or tellurides of these elements, or of those preceding them in atomic number, are known. With the iron group, we find sulphides very common, the sulphides of iron, pyrite, marcasite, and pyrrhotite, being common minerals, and sulphides of nickel and of iron and nickel, as well as their arsenides, are widespread ore minerals. Sulphides and arsenides of cobalt are also fairly common. The sulphide of molybdenum is the only usual mineral of this element, though a few other minerals containing it (as secondary molybdates) occur. Selenides, tellurides, and antimonides

of iron are apparently unknown in nature, though of nickel there are some very rare minerals of this character. It will be seen that such compounds (sulphides, arsenides, etc.) of the petrogenic elements are all of those of rather high atomic weight and in the groups of highest valence, especially common in the triad group iron-cobalt-nickel.

Turning to the metallogenic elements, we find that many of them exist in nature uncombined, notably copper, silver, gold, mercury, arsenic, antimony, bismuth, sulphur, selenium, tellurium, and the metals of the platinum group. Native zinc, lead, tin, and tantalum are also reported, but in some cases doubtfully.

As minerals the oxides of these elements either do not exist (as of gold and the platinum metals), are of extreme rarity, or are certainly or almost certainly of secondary origin, as those of copper, mercury, zinc, arsenic, and antimony. Tin oxide, the common ore of this metal (cassiterite), is an apparent exception, but it would seem to be possible that, in some cases at least, it is of secondary origin, a sulphide being the primary compound.

Primary silicates of the metallogenic metals are very rare. There are none of gold, silver, mercury, thallium, tantalum, tungsten, or the platinum metals. Silicates of copper and zinc are quite common, but are in all cases almost undoubtedly of secondary origin. There are, however, silicates (possibly primary) of tin, lead, and bismuth, but they are mineral rarities, and many mineralogical museums and collections have no specimens of them.

No fluorides of any of the metallogenic elements are known as minerals, but insoluble chlorides and oxychlorides of copper, silver, mercury, and lead are known, though rare. On the other hand, as native bromides and iodides we know only those of copper, silver, mercury, and lead—all metallogenic elements.

The typical, and by far the most abundant, native compounds of all these metallogenic elements then are the sulphides, arsenides, antimonides, selenides, and tellurides, with the complex sulphosalts. These form the main, and in some cases the only, sources of most of the metals. Indeed, of gold, mercury (except the common sulphide, the secondary oxide, a chloride, and two doubtful iodides), and thallium (except a rare sulphide), the only native compounds known are selenides and tellurides; and conversely, the only native selenides and tellurides known are of copper (rare), silver, gold, mercury, thallium, lead, and bismuth, except that there is a very rare nickel telluride. Oddly enough, the only native compounds known of the platinum metals are ruthenium sulphide and platinum arsenide, no selenides or tellurides of these being known.

Returning to the intermediate interlocking meander zone, it may be well to point out some features that show to which of the two

main groups the several elements there belong, and allude to another feature of interest regarding this part of the table.

Rubidium and caesium are known only as silicates, caesium forming the rare metasilicate pollucite, and both entering in small amount into other silicates, as beryl, lepidolite, and a few others. Strontium and barium, apart from their sulphates and carbonates of secondary origin, enter only into silicates, a barium silicate forming a member of the feldspar group, and both being the bases in some of the hydrous zeolites. The proper position of yttrium and lanthanum, in group 3, is somewhat uncertain, but they both enter into the composition of various silicate minerals, and are not known as sulphides, arsenides, etc. The position of zirconium and cerium is quite clear; both form silicates, zircon being especially widespread among granitic rocks, and they also enter into the composition of some members of the pyroxene group. The position of columbium (niobium) is also somewhat uncertain, as no silicates of it are known, but it may be basic in some titanates, and its general affinities as to mineral occurrence would place it almost surely with the petrogenic elements. Closely related to it, and occurring with it almost always, is tantalum, whose true place is uncertain. Minerals containing these two elements, however, are very rarely met with. The researches of Hillebrand¹⁹ have shown that molybdenum is very widely distributed among the more silicic igneous rocks, such as granites, so that, even though its most abundant mineral is the sulphide, it should be reckoned with the petrogenic elements.

Of the intermediate metallogenic elements, the positions of copper and silver are unquestionable, as both occur combined most frequently as sulphides and other such minerals. Silver does not occur as a silicate or oxide, but silicates and oxides of copper are not uncommon, though these are of secondary origin. The same may be said of zinc and cadmium, the oxide and silicate of zinc being secondary. Gallium and indium are found only in zinc sulphide (sphalerite), and germanium occurs only as a sulphide with silver and tin. Though tin is most commonly met with as the oxide (as well as a rare silicate), yet sulphides of it are known, so that, in spite of its frequent occurrence as oxide, it is to be reckoned with the metallogenic elements. Arsenic and antimony, as well as selenium and tellurium, belong, of course, in this group, as does sulphur, the necessary inclusion of which among the metallogenic elements carries them somewhat into petrogenic territory, and renders the meander somewhat unsymmetrical toward this end. Bromine and iodine, as we have seen, are only met with in nature in combination with metallogenic elements (except in solution in sea water), so that

¹⁹ Hillebrand, W. F., Amer. Jour. Sci., vi, p. 209, 1898.

they may probably be placed with these. The metals of the ruthenium and the platinum groups clearly belong here, because of their occurrence as metals, and because of the existence of the sulphide of ruthenium and the arsenide of platinum as the only native compounds known.

On referring to the periodic classification presented in Table III, it will be seen that the intermediate, meandered zone, where the petrogenic and the metallogenic elements interlock, shows a very large proportion of elements with atomic weights that are quite far removed from whole numbers, which would imply, as has been suggested by Harkins, that this is especially the region of isotopes. Whether this is fortuitous or whether it is (if it be true) connected with the division here suggested of the elements into the petrogenic and the metallogenic groups, is quite unknown, and it is needless here to speculate upon the subject.

It should be mentioned that the relations between the positive and the negative elements, and their occurrence in nature as minerals, as set forth above, form an elaboration and an extension of what Clarke has already called attention to,²⁰ namely, "In combination unlike elements seek each other, and yet there appears to be a preference for neighbors rather than for substances that are more remote. * * * The elements of high atomic weight appear to seek one another, a tendency which is indicated in many directions, even though it can not be stated in the form of a precise law. The general rule is evident, but its significance is not so clear." A possible significance, or rather a possible connection between this rule and the occurrence of the elements, both as to their relative abundance and their mutual relations, in the earth's crust and below it, may be suggested here, as a somewhat speculative hypothesis.

THE INTERIOR OF THE EARTH.

The hypothesis (already adverted to), that the interior of the earth is composed, at least in part, of an iron-nickel alloy like that which composes many meteorites, is commonly held. This is based on the mean density of the earth, its rigidity and magnetic character, and the composition of many meteorites, the siderolites, which may be regarded as fragments of a preexisting large body. Following Charles Darwin and Durocher, who published their view in the first half of the last century, the idea is now held by many that the material composing the interior of the earth is arranged, in a general way, according to relative density,²¹ there

²⁰ Clarke, F. W., "The Data of Geochemistry," U. S. Geol. Survey, Bull. 330, p. 35, 1908; and Bull. 695, p. 39, 1920.

²¹ See, for example, Suess, *The Face of the Earth* (English translation), vol. IV, p. 547, 1909; Daly, *Igneous Rocks and Their Origin*, pp. 162-168, 1914.

being a nucleus or core of iron-nickel and possibly other heavy metals, above this a zone of heavy silicate rocks, and at the surface the lighter silicate rocks of the "crust," but presumably passing gradually one into the other, without sharp borders.

Wiechert and Knott have recently shown, through a study of the propagation of earthquake waves, that there is a change in the material, or in the physical properties of the material, at a depth of about 0.5 of the earth's radius. Still more recently, by laboratory measurements of the compressibility of rocks, as well as by the study of earthquake waves, Adams and Williamson²² of the Carnegie Geophysical Laboratory, have shown that the much greater density of the interior of the earth can not be accounted for by the compressibility of the materials, whether rocks or metals. They are also led to the conclusion that, while there is segregation of heavier material toward the center, the change is continuous, and not discontinuous, as is held by Wiechert and Knott.

Following the views of Adams and Williamson, and accepting a lower zone of nickel-iron beneath the silicate "crust," I would suggest here the idea that the central core, the real nucleus, of the earth is composed of the metallogenic elements, that is, the elements or metals of highest atomic weight, either as "native" metals, or possibly in the form of selenides, tellurides, arsenides, antimonides, bromides, and iodides. Above this would be the nickel-iron zone, and above this the silicate crust.

We can not here discuss this suggestion in all its rather complex aspects. But the somewhat intermediate chemical character of the metals of the iron group, with manganese and chromium, is in accord with the hypothesis, differing as they do from the other petrogenic elements in their occurrence as sulphides and arsenides, in which they resemble the heavier metallogenic elements. Iron is the fourth most abundant element, and if the position of the nickel-iron zone, or a zone of alloy mixed with silicate rocks, were comparatively near the surface, this would be expected. The occurrence of iron-bearing basalts at the surface (met with in Greenland, Russia, Spain, and elsewhere) is also in line with this supposition.

Again, as on this supposition the true metallogenic elements are most deeply buried, their relative scarcity at the surface is readily understandable. Forming the nuclear core, not only would their total volume be relatively small, but it would also be difficult for them to find their way, even as vaporized or soluble compounds, from the great depths to the surface. The generally low melting points of the ore minerals is also in line with the opinion of Adams

²² I must express my thanks to my colleagues for permission to mention briefly here some of their conclusions which have not yet been published.

and Williamson that the deepest interior is not entirely a rigid solid, but more in the nature of a very viscous, thick liquid, which damps the transverse earthquake vibrations. The possible factor of the disintegration of the elements of highest atomic weight must be taken into account, but more can not be said here on this topic.

It is of interest to note that this idea, that the elements of higher atomic weights, the metallogenic elements, occupy for the most part the deepest portions of the earth's interior, is in harmony with Abbot's view as to the distribution of the elements in the sun.²³ He points out that the elements showing the most intense spectrum lines are those of low atomic weight, with the exception of the negative elements, none of which (with the possible exception of oxygen), for some unknown reason, show solar spectral lines. It is interesting to compare Abbot's table of intensities (p. 91) with the elements as presented in our Table III of the periodic arrangement. It will be seen that the first 22 elements showing the most intense lines are all terrestrially petrogenic elements, and that (apart from the negative elements) all the terrestrial petrogenic elements are among those that show the more intense lines, with the curious exceptions of glucinum, cerium, and especially potassium, which show but very weak lines. The order is not the same, but the first 10 elements in order of spectral intensity include calcium, iron, hydrogen, sodium, magnesium, silicon, aluminum, and titanium, which, with oxygen, potassium, and phosphorus, are the first 11 elements in order of abundance in the earth's crust. On the other hand, the metallogenic elements show the least intense or no solar spectrum lines. Thus in Abbot's intensity tables Nos. 23 to 36 (the last) include in order palladium, copper, zinc, cadmium, germanium, rhodium, silver, tin, and lead. The metals of the platinum group, with tungsten, bismuth, mercury, thallium, and one or two others, give extremely feeble or doubtful lines. As Abbot shows, taking the elements in groups of order of intensity, this diminishes with increase in the mean atomic weight of the group.

Abbot explains this distribution, to which the only real exceptions are cerium, glucinum, and potassium, by the supposition that "the explanation of the decrease of intensities with increasing atomic weights seems to depend on the depth of these gases below the sun's surface," and this supposition is confirmed by the spectrum observations of displacements of the lines of various elements due to pressure and those that show in the "flash" spectra during eclipses. The coincidence between the occurrence of the elements in the earth and in the sun, as regards relative abundance and depth, is apparently so very close and detailed as to be suggestive of a similar

²³ Abbot, C. G., *The Sun*, 1911, pp. 91, 94, 99, 104, and 252 ff.

arrangement in both bodies. It is also quite in harmony with the general idea of arrangement according to specific gravity or "gravitative adjustment."

We may conclude therefore that the metallogenic elements are rare on the earth's surface and do not show intense spectrum lines in the sun, because they are too deeply buried in both. Connected with this, however, is the difference in the chemical relations already pointed out, the significance of which is as yet problematical.

It might be pointed out here that such a theory of the vertical distribution of the elements seems to be opposed to Chamberlin's hypothesis of the planetesimal origin of the earth, though the matter can not be discussed in this paper. Attention may only be called to the fact, probably very significant in this connection, that the melting points of the oxides and silicates, the typical natural compounds of the petrogenic elements, are much higher than those of the sulphides and arsenides, the typical natural compounds of the metallogenic elements. The bearing of this will be discussed elsewhere.

Much more might be said of this suggestion of the distribution of the elements of highest atomic weight and greatest density at the center. The idea is not wholly new, having been held speculatively by others. One might even recall, to pass from science to fiction, that the idea was, in a way, foreshadowed by Jules Verne, who in one of his stories describes a comet or huge meteorite composed of telluride of gold.

CORRELATION OF THE ELEMENTS.

But we have wandered far from our proper topic, the crust of the earth, having reached not only the center of the earth, but the sun, and become enmeshed in somewhat transcendental chemical speculation. Let us come back to the surface of the earth.

Before returning, however, to the consideration of the actual crust and its rocks, it may be as well to examine briefly a feature of the mutual relations of the elements (for the most part petrogenic), that is shown us by chemical study of the rocks and of the many minerals with which we are acquainted. Since the chemical analysis of rocks and minerals began to assume large proportions, so that sufficient and sufficiently accurate data became available, it has been noticed that certain elements are prone to be found in rocks of certain general compositions, and also in association with one another in minerals. In other words, there has been observed a certain correlated distribution of the elements in the earth's crust—that is, in the rocks and minerals composing it—by which certain of the elements tend to occur together in greatest abundance or most often, while other elements are seldom if ever found along with these. As this is a

matter of considerable interest and importance from the mining engineer's point of view, several attempts have been made to formulate the relations, and it will be pertinent to give a very brief account of the subject.

Among the earliest of the more modern workers to investigate this problem are Vogt, Kemp, and De Launay,²⁴ who confined their attention chiefly to whether the various elements considered were most abundant in the more or the less siliceous rocks.

The writer pointed out²⁵ that "the relations are more complex and are dependent, not so much on the relative amount of silica, as on the relative amounts of other constituents, notably soda, potash, iron, magnesia, or lime." Such relations of common association are shown, in part among the most abundant constituents of rocks and minerals, and in part among the rarer ones, generally in connection with the more abundant. For the most part, the relations so far observed, which may be considered as best established, are confined to the petrogenic elements, as would be expected, but there seem to be similar relations, not yet quite clear, between some of the metallogenic and the petrogenic elements.

Broadly speaking, silica, alumina, soda, and potash tend to go together; thus the rocks that are highest in silica have, in nearly all cases, alumina and the alkali metals as the next most abundant constituents. At the same time, the alkali metals, and lime (not iron or magnesia), tend to go with alumina; so that a very large number, and among these the most common, of the silicate minerals are silicates of alumina and (or aluminosilicates of) soda, potash, and lime. The iron oxides and magnesia do not show nearly so strong a tendency to combine with silica or with alumina. In this connection may be mentioned a tendency toward combination with (or affinity for) silica, which may be expressed thus:



That is, potash will endeavor to take all the silica that it can, so far as is compatible with certain physical conditions, soda next, and so on; iron being the only very abundant element (except silicon) that commonly forms an oxide alone, that is to say, uncombined with silica. This general law or rule, which is based on the most generally observed relations among rock-forming minerals, is the basis of a recently introduced classification of igneous rocks, and it gives

²⁴ Vogt, J. H. L., *Zeits. Prakt. Geol.*, 1898, p. 326; Kemp, J. F., *Ore Deposits*, 3d edition, pp. 34-37, 1900; De Launay, L., *La Science Géologique*, p. 637, 1906. Cf. also Hillebrand, W. F., *U. S. Geol. Survey, Bull.* 700, p. 25, 1919; and Clarke, F. W., *U. S. Geol. Survey, Bull.* 695, p. 13, 1920.

²⁵ Washington, H. S., *Trans. Amer. Inst. Min. Eng.*, p. 751, 1908; Cf. Washington, *Manual of the Chemical Analysis of Rocks*, 1st edition, p. 14, 1904; 3d edition, p. 17, 1919.

promise of fruitful application in the future. A similar "order of affinity" as regards alumina is also true of the same elements.

Magnesia and the iron oxides tend to go together, or to replace each other in many minerals, which seems to be of much the same import, and these oxides are, as we have seen, generally opposed to soda, potash, and lime.

Among the more interesting of such correlations are those of soda and iron on the one hand, and of potash and magnesia on the other, these two pairs tending to go together. This is shown by many minerals, the details concerning which it is unnecessary to give here, though there may be mentioned the sodic pyroxenes, which contain much iron and little if any magnesia, and the potassic micas, which

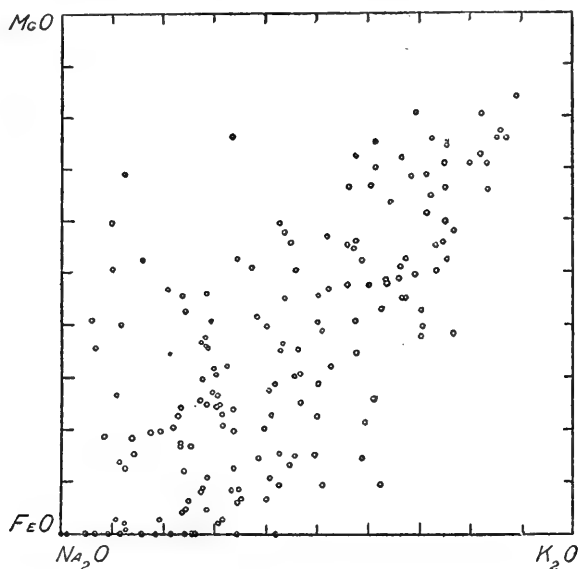

FIG. 1.—Relation of Na and Fe to K and Mg.

generally contain more magnesia than iron along with the potash. Study of many analyses of igneous rocks also brings this relation out very clearly, and it is expressed in the above figure (fig. 1) published some years ago.²⁶ In this the abscissas represent the relative amounts of soda and potash, and the ordinates those of iron oxide and magnesia. The general drift of high soda coincident with high iron, and conversely of high potash with high magnesia (though such rocks are comparatively few), is clearly shown, and, as the data are derived from numerous analyses, and are substantiated by many others more recently made, the general "drift" may be considered as fairly well established. That the points fall in a rather broad zone,

²⁶ Washington, H. S., Proc. Natl. Acad. Sci., 1, p. 574, 1915.

instead of along a narrow line, is to be attributed to the complications that may be introduced in such correlations by the presence of silica, lime, and possibly aluminum or titanium.

It may be mentioned here, *en passant*, that, curiously enough, the same correlation between these two pairs of elements, soda and iron, and potassium and magnesium, seems to hold good in the organic world.²⁷ This is apparently shown by the following facts: In autotrophic plant metabolism potash is an essential element, as is also magnesium, in that chlorophyll (which in the leaves acts as the carbon-transferring substance) is a magnesium salt of a complex organic acid, while sodium and iron are generally toxic toward (at least the higher, gymnospermous and angiospermous) plants. On the other hand, sodium, rather than potassium, is the alkali metal essential to the higher animals, salt being a very necessary article of diet (in part because of its chlorine, and in part because of its sodium content), and sodium chloride is present in the blood plasma; and at the same time, hemoglobin and its derivatives (which act as oxygen carriers, and are analogous to chlorophyll in plants) are iron salts of organic acids closely related to that of chlorophyll; while, similarly, potassium and magnesium are more toxic toward the higher animals than are the other pair.

Let us now pass briefly in review some of the correlations that are shown in igneous rocks by the rarer, and generally petrogenic, elements with the most abundant ones. In the first place, the rocks that are dominantly sodic seem to show the greatest tendency toward the segregation of many of the rarer elements. Thus, lithium, zirconium, cerium (and some of the other rare earth metals), chlorine and fluorine, and probably glucinum and tin, are found most often, both as components of minerals and in rocks, that are high in soda. Barium seems to be most abundant in those that are high in potash; titanium,²⁸ manganese, vanadium, nickel, and cobalt, in those that are specially high in iron; and chromium and platinum in those that are high in magnesium. Of the proclivities of the more truly metallogenic elements, as gold, silver, mercury, lead, and zinc, we know little as yet, but further study may indicate such relations, if they exist.

It is needless to enlarge here on the bearing of such observations on the practical search for ores and metals, especially those of the rarer kinds, some of which are now coming into prominence, such as tungsten and tantalum for electric lights, and zirconium for refractories. It will be self-evident that a knowledge of the rocks of a region can thus give us a clue as to what elements, or their ores, may be most likely met with, so that, for instance, we would not search for

²⁷ Washington, H. S., Proc. Natl. Acad. Sci., ii, p. 623, 1918.

²⁸ Titanium also evinces preference for sodium, like its congener zirconium.

platinum in a region of sodic rocks, but would here look rather for the minerals of cerium, the rare earths, uranium, or tungsten.

COMAGMATIC REGIONS.

Let us now return to the earth's crust and endeavor to answer the second question propounded above, namely, whether all large portions of the crust are alike in general, or whether they show marked differences; that is, whether the crust is essentially alike or unlike over different areas.

Nearly 50 years ago Vogelsang²⁹ pointed out that the igneous rocks of certain districts showed certain textural or mineral characters in common, which served to distinguish them from the rocks of other districts. The same idea was expressed later by Judd,³⁰ and still later by Iddings,³¹ the latter showing that the differences between different districts were referable ultimately to differences in the chemical composition of the rocks. Such districts were called "geognostische Bezirke" by Vogelsang, "petrographic provinces" by Judd, the latter name being that in common use, Iddings using the term "consanguinity," while the writer later³² called them "comagmatic regions," to indicate the idea that the various rocks of a given region are derived from a common magma, by processes of so-called differentiation. Into the discussion of differentiation we can not even begin to enter here, though it forms one of the most important and most complex features of petrology, the science of rocks.

The proper study of petrographic provinces, or, as we shall here term them, comagmatic regions, is as yet, so to speak, in its infancy. Only a few regions have been described at all adequately from the most general point of view, such as the Christiania region in southern Norway, that of central Montana, the Yellowstone Park, and the volcanoes of western Italy; and these descriptions leave much to be desired.

Indeed, even the fundamental data for our definition of a comagmatic region are somewhat uncertain and the application of the idea is somewhat loose. Thus, considering the time element, the life of a region may extend over many geological periods, as that of Great Britain from the Silurian to the Tertiary; or it may be confined to but little more than one period, as with the western Italian volcanoes. The areal extent may vary from many thousands of square miles to a few hundreds, though we are beginning to believe that the smaller "regions" are probably to be regarded as but parts of larger ones. The shape of the area may also vary; it may be more or less equilateral, a long zone, either broad or narrow and

²⁹ Vogelsang, H., *Zeits. deutsch. geol. Ges.*, xxiv, p. 525, 1872.

³⁰ Judd, J. W., *Quart. Jour. Geol. Soc.*, xlii, p. 54, 1886.

³¹ Iddings, J. P., *Bull. Phil. Soc. Wash.*, xii, p. 128, 1892.

³² Washington, H. S., *Carnegie Inst. Publ.*, No. 57, p. 5, 1906.

perhaps forked, or be evident only as small, separate, and apparently structurally unconnected occurrences of similar rocks.

Although some of the characters of any given region may be most evidently recognizable by the mineral features, such as the color of the pyroxenes or the peculiarities of the feldspars, yet these are all dependent on the prominent chemical characters of the magma, so that the chemical characters constitute the fundamental basis of distinction and characterization. In order to show the reader how, and in how far, the chemical characters of various portions of the earth's crust may differ, it will be well to note very briefly some of the best-known comagmatic regions of the earth, stating only their most prominent chemical features and omitting all details.

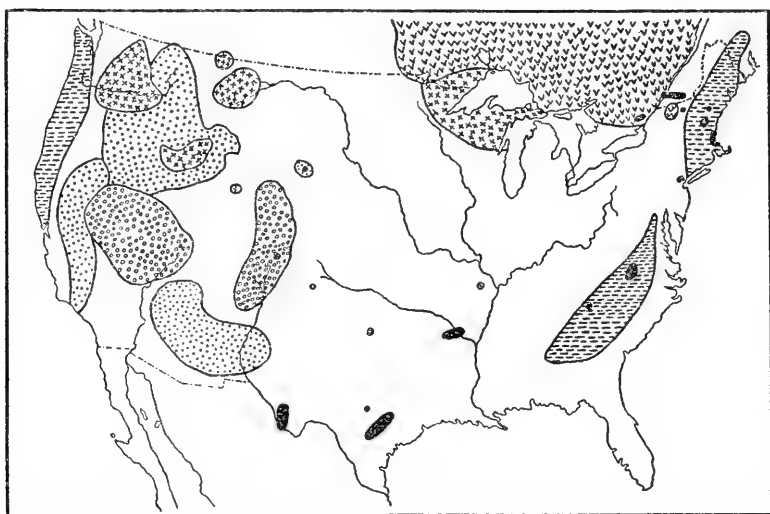

FIG. 2.—Comagmatic regions of the United States.

In the United States we find a long zone of disconnected areas whose rocks are dominantly sodic. This zone apparently begins in southwest Greenland, appears as a group of very similar small areas in Ontario, Quebec, and New England (the so-called Novanglian region), appears in New Jersey, Virginia, probably North Carolina, in Arkansas, and finally as several areas in Texas. It is apparently continued south in Tamaulipas in Mexico; and what may be a continuation of it appears in some of the Antilles, in Brazil, and as far south as Paraguay. These areas in the United States are marked solid black in figure 2. The large "Canadian shield" around Hudson's Bay forms another region, which is dominantly calcic (anorthosites), marked with v's on the map. Along the Appalachian uplift, and probably extending into Maine, is another region, the rocks of which are characteristically rather sodic granites, though some very

unusual rocks occur along this zone. This is marked with dashes (—) on the map. The sodic areas just mentioned may be connected with this. West of the Appalachians we find a few small sporadic occurrences of peculiar rocks, high in potash and magnesia, as in New York, Pennsylvania, Kentucky, and Arkansas, which seem to be distinct from the preceding, and which may represent the great body of magma that underlies this eastern part of the Mississippi Valley.

Around Lake Superior, in Minnesota, Wisconsin, and Michigan, and probably extending into Canada to the north, is an area of igneous rocks that are low in silica but high in lime and iron oxides. To the last feature is due the importance of this region for its very abundant iron ores. It is marked with x's on the map. In the southern part of the Mississippi Valley, about the Ozark uplift, are some small and as yet little-studied occurrences of granitic rocks, which seem to form a distinct region.

West of the Mississippi Valley the comagmatic relations are more complex, as are the geological structures, but we can distinguish some fairly well-defined comagmatic regions. One of the most clearly marked is that which extends from, and possibly beyond, the Canadian border through central Montana, where it is represented by several volcanic centers described by Pirsson and others, into Wyoming, and with patches that probably represent it in eastern Colorado. These rocks are characterized by decidedly high alkalis, and with potash generally dominating soda. The areas are marked by +'s on the map. Covering the great plateau of Colorado, Utah, and Nevada, with parts of Idaho and Wyoming (including the Yellowstone Park) and probably in northern New Mexico and Arizona, is a large and complex region, the rocks of which are decidedly of average composition, distinctly high in silica, moderate lime and alkalis, and low iron and magnesia. North, west, and south of this is a rather ill-defined region, whose rocks are similar but somewhat more calcic. The first is distinguished by small circles and the latter by dots on the map. These regions need further study, and it is doubtful if they should be treated separately.

In southern Idaho and in Washington and Oregon are the very extensive flow basalts of the Snake and Columbia Rivers, high in lime and iron oxides, which resemble chemically the rocks of the Lake Superior region and which are marked similarly on the map. The true relationship of these to the surrounding regions is doubtful. Along the Pacific coast, chiefly in California; but extending to the north about as far as Puget Sound, there are indications of a narrow zone of decidedly sodic but rather highly silicic rocks. This may extend south along the west coast of Mexico, and may there be connected with the origin of the jadeite objects found in that

country, the exact provenance of which is unknown. Thus may petrology aid archaeology.

The long chain of the Andean volcanoes seems to form a continuation of the main Cordilleran region, which is continued northward along the Aleutian volcanoes, and thence southward, along the west coast of the Pacific, through the volcanoes of Kamchatka, Japan, and the Philippines, and so on to the Dutch East Indies. This so-called "Circle of Fire" surrounds a large area, that of the Pacific Islands, whose rocks are dominantly basaltic—that is, low in silica and alkalis, and high in lime, magnesia, and iron, associated here and there with occurrences of alkalic rocks.

In Europe the various comagmatic regions are so numerous, so complex, and so little known from this point of view, that only a few need be mentioned. There is the extensive, though broken-up, region that embraces the British Islands and their outliers, with Iceland, eastern Greenland, Jan Mayen, Spitzbergen, and Nova Zembla, the rocks of which are dominantly basaltic. The highly sodic Christiania region in southern Norway has been well studied by Brögger, as has the calcic Bergen region by Vogt. Germany and Austria are filled with a complex of different regions, the relations of which are not yet clear, but which seem to be either dominantly sodic, as that of Bohemia, or with basaltic tendencies. The Alps and the Tyrol form a central region of prevailingly granitic rocks which differ markedly from the various and different regions that surround them; this is a point to which we shall recur. In Italy is the so-called Roman comagmatic region, embracing the volcanoes along the west coast from Bolsena to Vesuvius, the rocks of which are decidedly unusual in their very high potash, with considerable lime. A zone of distinctly sodic rocks appears to extend from southern France and eastern Spain, down Corsica and Sardinia, through the island of Pantelleria, into Tripoli. Hence, by way of Kordofan, this region is possibly connected with the highly sodic one that stretches from Abyssinia down the Ethiopian Rift Valley, in East Africa, and which branches northwardly along the Red Sea and Arabia as far as Syria. At the east end of the Mediterranean, on the other hand, is a region embracing Greece and the Balkan Peninsula, the Archipelago, and western Asia Minor, whose rocks resemble very closely those of the Colorado plateau and of the Andes volcanoes.

We could go on thus over the surface of the earth, so far as its rocks are sufficiently well known chemically. Unfortunately, this is not the case with many large, and otherwise thoroughly studied, areas or regions, such, as, for instance, the Greater Antilles, Cuba, Jamaica, Haiti, and Porto Rico. But this very rapid sketch will serve to give the reader some idea of how diversified, chemically, are the different portions of the earth's surface.

It has been suggested by several prominent petrologists³³ that the comagmatic regions may be referred genetically to two large types of magma or "provinces," called "alkaline" and "subalkaline" by Iddings, or "Atlantic" and "Pacific" by Becke. The latter goes so far as to attempt to ascribe all the comagmatic regions to two areas, the one dominantly alkalic and surrounding the Atlantic Ocean, and the other more calcic and surrounding the Pacific. Harker, furthermore, would connect these two main types of comagmatic region with two main types of crustal movement or stress, such as are recognized by Suess, which give rise to different types of coast, mountain formation, etc. In the opinion of the writer such recognition of but two types is not consonant with what we know of the general distribution of the igneous rocks. The whole subject is very complex, far too much so for proper discussion here, and the data available seem to the writer to be inadequate for very broad generalizations at present.

CHEMICAL COMPOSITION AND ROCK DENSITIES.

The above outline of comagmatic regions leads us to the consideration of two subjects with which we may close this sketch of the chemistry of the earth's crust; that is, the relation between the chemical composition of rocks and their density, and that between these and the theory of isostasy.

In the preceding pages we have considered igneous rocks almost only from the chemical point of view. As we know, however, they are actually aggregates of definite chemical compounds, minerals, mostly silicates. Furthermore, we know that magmas of the same general chemical composition may crystallize as diverse aggregates of different minerals, according to the conditions that obtain during solidification. If we know the chemical compositions of the various rock-forming minerals, the quantitative mineral composition may be readily calculated from the chemical analysis of the rock. But from what has just been said, it is evident that the particular mineral aggregate to be calculated will depend on the conditions controlling solidification. It is also obvious that if we know the mineral composition and the densities (specific gravities) of the minerals, that of the rock as a whole may be readily calculated.

In the conception and elaboration of a system of classification of igneous rocks that was proposed some years ago by some American petrologists, the chemical composition of igneous rocks was regarded as their most fundamental character, and therefore that on which their classification was primarily based. But, in order to recognize the fact

³³ For some general discussion of this and related topics, the reader is referred to Harker, *The Natural History of Igneous Rocks*; Iddings, *Igneous Rocks*, Vol. I; and Daly, *Igneous Rocks and Their Origin*.

that they are actually mineral aggregates and so as to be able to compare them one with another on this basis, in spite of the various possibilities as to mineral composition introduced by the varying conditions of solidification, the chemical composition shown by analysis is calculated in terms of mineral composition according to one uniform system; that is, one general assumption as to the minerals that are formed, or may be formed, from the particular magma. In this way, all igneous rocks are comparable and classifiable *inter se*, both chemically and mineralogically. The details of the procedure and the results of this system of classification can not be gone into here, but may be looked for elsewhere.³⁴ It will suffice here to say that the general principles which are considered basal are the so-called "affinities" of the various basic oxides for, first, silica, and, second, alumina, which have been given on a previous page and which are deduced from the general knowledge of rock minerals. Carried out along the lines so laid down the results of the calculation from the data of the chemical analysis give a mineral composition which, although ideal, corresponds with the actual mineral composition in the great majority of cases.

Some years ago Iddings³⁵ pointed out that the density (specific gravity) of a rock as calculated from the calculated mineral composition on the assumption that the rock is holocrystalline, corresponds very closely with the actual density. This fact is of great interest; partly because of its justification of the fundamental basis of the classification, and also because it thus furnishes a uniform means of comparing the densities, not only of particular rocks, but of the average rocks of different regions, and quite irrespective of such factors as those due to porosity or the presence of glass. Following the suggestion of Iddings, I have calculated the average densities of the continents, the ocean floors (represented by the lavas of the volcanic islands in the Pacific and the Atlantic), and of the igneous rocks of various countries and comagmatic regions, whose average chemical compositions were calculated by Doctor Clarke from the data in Professional Paper 99.

³⁴ Cross, Iddings, Pirsson, and Washington, *A Quantitative Classification of Igneous Rocks*, Chicago, 1903; Washington, H. S., U. S. Geol. Survey, Prof. Paper No. 99, 1917. There is a considerable literature on this and other systems of the classification of rocks.

³⁵ Iddings, J. P., *The Problem of Volcanism*, p. 123, 1914. For a later and more detailed statement, see Iddings, *Amer. Jour. Sci.* (4), xlix, p. 363, 1920.

TABLE IV.—Average compositions of continents and ocean floors.

	1	2	3	4	5	6	7	8	9	10
SiO ₂	59.09	60.01	61.09	59.66	61.77	58.20	59.99	53.56	50.63	50.06
Al ₂ O ₃	15.35	15.71	15.13	15.07	15.45	15.31	14.69	16.79	15.82	15.51
Fe ₂ O ₃	3.08	2.87	3.02	3.16	3.16	3.52	2.59	4.00	4.44	3.88
FeO.....	3.80	3.66	3.29	3.66	2.75	3.74	4.40	5.33	5.79	6.23
MgO.....	3.49	3.15	3.46	3.60	2.63	3.51	3.75	4.66	5.79	6.62
CaO.....	5.08	4.79	4.86	4.96	4.49	5.10	5.02	7.57	7.36	7.99
Na ₂ O.....	3.84	3.89	4.07	3.72	4.09	4.84	3.49	3.57	4.27	4.00
K ₂ O.....	3.13	3.06	2.68	3.39	3.22	3.28	3.02	2.32	2.31	2.10
H ₂ O.....	1.14	1.01	1.04	1.24	1.23	1.26	1.19	.93	1.47	1.16
TiO ₂	1.05	1.01	.56	.83	.68	.84	1.01	.87	1.63	1.96
P ₂ O ₅30	.26	.11	.23	.12	.20	.26	.17	.43	.25
MnO.....	.12	.10	.12	.08	.10	.07	.15	.03	.04	.15
Incl.....	.48	.19	.16	.14	.04	.17	.1307	.08
	100.00	99.71	99.59	99.70	99.75	100.14	99.70	99.80	100.05	100.00

1. Earth (5159 analyses). Density=2.77. Elevation = +2,252 feet.
2. North America (1709 analyses). Density=2.75. Elevation=1,888 feet.
3. South America (138 analyses). Density=2.72. Elevation=2,078 feet.
4. Europe (1985 analyses). Density=2.75. Elevation=939 feet.
5. Asia (114 analyses). Density=2.72. Elevation=3,189 feet.
6. Africa (223 analyses). Density=2.77. Elevation=2,021 feet.
7. Australia (287 analyses). Density=2.79. Elevation=805 feet.
8. Antarctica (103 analyses). Density=2.79. Elevation=? feet.
9. Atlantic floor (56 analyses). Density=2.85. Depth = -13,500 feet.
10. Pacific floor (72 analyses). Density=2.89. Depth = -14,820 feet.

Before we discuss the densities it will be well to examine the average chemical compositions of the different continents and ocean floors, the data for which are given in Table IV. It will be seen that they vary considerably the one from the other, as well as from the general average of the earth's crust. Taking, for example, silica, the most abundant constituent, its percentages for North and South America, and especially for Asia, are decidedly above that of the earth's crust as a whole, while those for Europe and Australia are only slightly above this. On the other hand, the silica percentages for Africa and Antarctica, and still more for the Atlantic and the Pacific floors, are very notably lower.⁸⁶ There is little difference, comparatively, in the figures for alumina, the alkalis, and the minor constituents, but those for the iron oxides, magnesia, and lime are distinctly lower in those cases where silica is higher and higher where this is lower.

The continental and oceanic averages shown above represent, in fact, different comagmatic regions on a large scale, but in concise form. Though the data for some of them—as Asia, South America, Africa, and Antarctica—are not numerous enough to be wholly satisfactory, yet there would seem to be no valid reason for doubting that, taken as representing broadly the general chemical compositions of the larger structural divisions of the earth's surface, they may safely be assumed to give us a fairly trustworthy idea of the relations between them. In any case, they are the only large body of data that we have available, so let us use them provisionally and see to what results their consideration may lead.

Before doing this, however, it will be as well to devote a few words to the average density of the crust as a whole, as this is an important

⁸⁶ If the analyses of the rarer rocks are disregarded, the density of the Atlantic floor is about 3.05 and that of the Pacific is about 3.10.

factor in the consideration of isostasy, to be taken up later. It will be seen from the table that the average density of the crust is calculated, from the average chemical composition, to be 2.77. An average might be arrived at by considering all the determinations of specific gravity of rock specimens that have been made by the ordinary physical methods, and that are found abundantly in the literature. An average thus arrived at would seem to suffer from several disturbing factors that are eliminated by the method based on the chemical averages. Thus it would include the densities of many lavas that are more or less glassy, which are decidedly lighter than holocrystalline rocks, and which, furthermore, are surficial rocks, not found at any considerable depth beneath the surface. It would also be seriously affected by the porosity of the surface rock specimens; and at great depths this must be very largely or wholly done away with by the pressure of the superincumbent crust, as shown by Van Hise and others. On the other hand, however, the density determinations are probably more equably distributed among the various kinds of rocks than are the chemical analyses, which may reasonably be expected to include a possibly undue proportion of "interesting" and rarer types of rocks, as has been mentioned.

It is impossible at present to evaluate the relative influences of these several factors, but I might incidentally express my surprise that such a simple means of arriving at an estimate of the average density of the rocks of the earth's crust as is here suggested does not seem yet to have been attempted—at least nothing seems to have been published on the subject. An estimation that I am now making along this line is not yet complete enough for publication in this paper, but will be given later elsewhere.

On the whole, after due consideration of the several factors involved, I am inclined to put much greater weight on the final result arrived at from the averages of the chemical compositions. This, also, is subject to certain possible corrections in the future. It would seem to be probable that it is somewhat too high, as it does not include any, or at least a proportionate, number of analyses of many large areas which are almost certainly generally granitic and therefore relatively light. This applies to the interiors of Asia, South America, Australia, and probably Africa, to mention the larger divisions, and also to smaller ones, such as Spain, Egypt, South Africa, the Greater Antilles, and others. It is impossible now to estimate the magnitude of this correction.

On the other hand, if we are dealing with the rocks of the crust to any (humanly) considerable depth, such as the 10 miles assumed by Clarke, and which might justly be placed at 20 or more, we meet with the possibility of a correction in the other direction; that is, toward a higher density. This conclusion is based on the ideas of

Daly and others as to the existence of a basaltic substratum beneath the dominantly granitic outer shell, that is brought about by "gravitative adjustment."

Balancing up these conflicting factors, I am inclined to place the average density of the crust at about 2.75, at least for the uppermost shell, while that of 2.80 would probably be nearer the truth for the average of any considerable depth, such as 20 or more miles. In the present state of our ignorance and the paucity of our data, however, it would seem to be wisest to accept the figure given by the many analyses available and assume a density of 2.77 as that of the earth's crust.

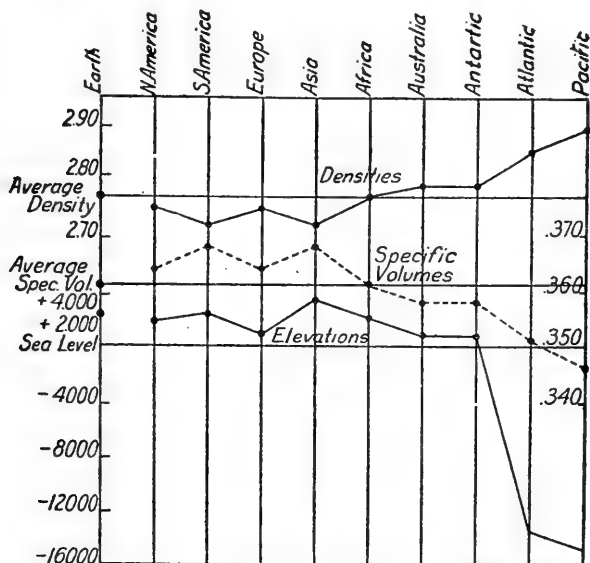

FIG. 3.—Elevations and densities of the continents.

Geodesists have assumed a density of 2.67 for their studies of isostasy, as will be noted elsewhere. They take into their calculations, however, only the extremely superficial layers, including such strata as soil and light sedimentary deposits. As will be mentioned later, I am inclined to think that this estimate is much too small and that the basis of their calculations should be a considerable higher density. That of 2.77, here assumed, or possibly better, 2.75, would seem to be the best available under the circumstances.

ROCK DENSITIES AND ELEVATIONS.

With the analyses in Table IV are given the calculated densities and the average elevations of the continents and the depths of the ocean floors referred to sea level. The general relations are graphically expressed in figure 3. The lowest graph is that of elevations, the uppermost is that of densities, while the intermediate one is that of specific volumes, or reciprocals of the densities, which serves

better to bring out the parallelism. The sequence of the continents and oceans is arbitrary.

It will be evident from the Table IV and from the graphs that there is a close relation between the average densities of the continental masses and of the ocean floors and their average elevations or depressions. They stand in inverse relation to each other; that is, the higher portions of the earth's crust are composed of the lighter rocks and the lower portions of the heavier. When it is remembered that these relations are shown by a very considerable number of averages based on a very large number of trustworthy analyses (the largest so far available) from all parts of the earth, the correspondences are too striking to be explicable by an appeal to chance or coincidence. This is even more obvious when we come to consider the relations in greater detail, as we shall do presently.

In discussing this subject it must be kept in mind that we are dealing with the averages of large areas and of many analyses, so that small and local details are lost. Thus a number of volcanoes show flows of heavy basalt covering lower flows or inner cores of lighter rhyolite or andesite. Again, it is not uncommon to find sheets of heavy basalt capping plateaus or forming the summits of their mountain remnants. But such apparent contradictions to the general law shown above are but local and minor details, insignificant as compared with the immeasurably greater masses of which they form but topographic surface features.

The general relations between rock density and elevation are also, and possibly more strikingly, seen when they are presented in greater detail, as is done in figures 4 and 5.³⁷ These are based on the average densities calculated from the average chemical compositions of the rocks of different countries and regions, as determined by Doctor Clarke. These represent the general elevations and corresponding average densities along two zones around the earth, the one roughly between latitude 40° and 50° N. and the other between latitude 10° and 20° S. It is to be understood that the graphs are much generalized, representing average densities and elevations, so that there is little detail.

The outer circle is that of sea level and the irregular line that crosses it is a generalized graph of the land elevations and the ocean depths. Though the positions in longitude are approximately correct, the vertical scale of these is not that of the earth as represented by the sea-level circle, but the heights and depths are very greatly exaggerated, otherwise the differences would not be perceptible in any practicable illustration. The portions of the land surface are, however, all drawn to the same (exaggerated) vertical scale, while that of the ocean depths is one-half of this. The elevations shown for

³⁷ For the suggestion of this method of presentation I am indebted to Dr. L. H. Adams, of the Geophysical Laboratory.

the interiors of South America, Africa, and Australia are the continental elevation averages as given by Murray.

The inner circle is that of the average specific volume ($\frac{1}{2.77}=0.361$), and the inner broken line, made up of arcs, is that of the average specific volumes of the portions of the earth's crust radially above the successive small arcs. Specific volumes (the reciprocals of the densities) are used instead of densities because the relations are brought out more clearly and immediately by the parallelism with the elevation graph shown by the former. The arc portions of the specific volume graphs in solid lines are the ascertained averages, while portions that are unknown, because of the absence of exposures of igneous rocks or for other reasons, are indicated by dotted arcs, their radial distance being roughly estimated, so far as is possible. These various arcs are connected by radial dotted lines.

The center of the circles is the locus of the axis, seen from the North Pole, and is at the same time the zero point for the two graphs.

The graphs show the correspondence between elevation and specific volume so clearly that it is scarcely necessary to go into a detailed description; yet a brief summary of the northern zone may be of interest. This represents the conditions around a zone which extends roughly between 40° and 50° north latitude, varying somewhat north or south so as to include available data and complete the circle. The data on which the graphs are based are given in Table V.

TABLE V.—Average densities, specific volumes, and elevations.¹

	Density.	Specific volumes.	Average elevation.
			<i>Feet.</i>
Earth.....	2.77	0.361	+2,252
North America.....	2.75	.364	1,888
United States.....	2.75	.364	2,500
South America.....	2.72	.368	2,078
Europe.....	2.75	.364	939
Asia.....	2.72	.368	3,189
Africa.....	2.77	.361	2,021
Australia.....	2.79	.358	805
Antarctica.....	2.79	.358	?
Atlantic floor.....	2.85	.351	-12,800
Pacific floor.....	2.89	.346	-15,400
ZONE 40°-50° NORTH LATITUDE.			
California.....	2.742	.365	+ 3,000
Oregon and Washington.....	2.773	.361	2,500
Utah and Nevada.....	2.717	.368	6,000
Colorado.....	2.735	.366	7,000
Ozark region.....	2.728	.367	2,000
Michigan, Wisconsin, Minnesota.....	2.803	.357	1,000
Appalachia (Pennsylvania to Georgia).....	2.749	.364	2,000
New England and New York.....	2.759	.362	750
Great Britain.....	3.041	.329	300
France.....	2.867	.349	600
Germany.....	2.772	.361	800
Switzerland and Tyrol.....	2.729	.366	5,000
Austria-Hungary.....	2.784	.359	2,000?
Urals and Caucasus.....	2.829	.353	2,000+
Pamirs.....	2.72-	.368+	13,000
Japan.....	2.723	.367	1,420
ZONE 10°-20° SOUTH LATITUDE.			
Andes.....	2.717	.368	6,000?
East Brazil.....	2.745	.364	2,500?
Africa (east and west).....	2.77	.361	2,021
Madagascar and Reunion.....	2.830	.353	2,199
New Zealand.....	2.749	.364	2,134

¹ For the hypsometric data I have consulted Murray, Scot. Geog. Mag. iv, pp. 1-29, 1888; Gannett, U. S. Geol. Survey, Am. Rep. 13, ii, d. pp. 283-289, 1892; Bull. No. 274, 1906; and other authorities.

Let us take a little journey around the earth along the northern zone. (Fig. 4.) Beginning at the Pacific coast, the land gradually rises across California to the high plateau of Nevada and Utah, culminating in Colorado. Thence it slopes gradually down, across the Great Plains (Kansas), to the Mississippi Valley. Along this slope practically no igneous rocks are met with, except for sporadic and little-studied occurrences in the Ozark Ridge. The slight rise seen in the Mississippi Basin is the level of the rocks of the Lake Superior region (Minnesota, Wisconsin, Michigan). East of this (Kentucky) few igneous rocks are known except those mentioned above, and the land slopes gradually up to the Appalachian Ridge,

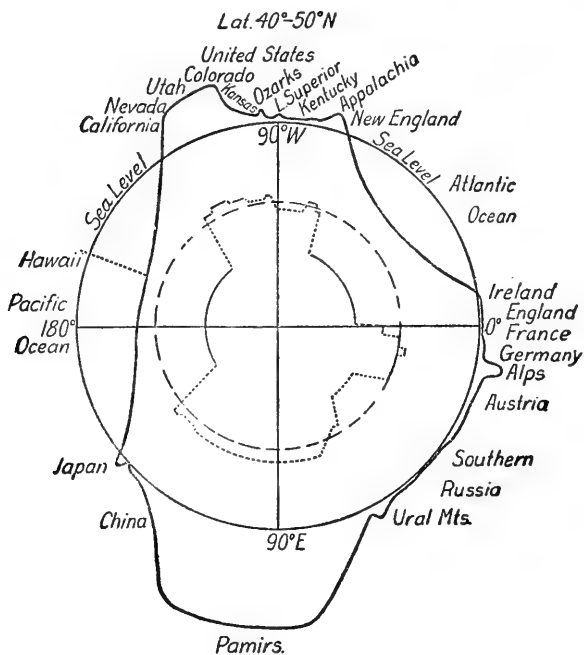

FIG. 4.—Surface relief and specific volume.

and east of this, across New England in the graph, descends to sea level.

The floor of the North Atlantic is rendered very summarily, and the Azores and Iceland are about our only source of information as to the composition of its floor along this zone. On the east coast of the Atlantic the British Isles rise to but a small height (on the average) above its surface. The average elevation of France is slightly higher; that of Germany (which is inserted in the zone a little out of latitude) is still somewhat higher, and thus we come to Switzerland and the Tyrol, the culminating portion of Europe. To the east of this, with an average elevation slightly greater than that of Germany, lies

Austria-Hungary, and then to the east the low-lying plains of south Russia. East of these are the Ural Mountains, and then (bending somewhat southerly) we pass through Turkestan and Persia, and reach the very high Pamirs, the "roof of the world." Thence the surface slopes down across China, rises again in Japan, and again drops to the depths of the Pacific Ocean.

Let us now see how the rock densities, or rather the rock specific volumes, correspond with the elevations. This inner graph, it is to be remembered, represents the specific volumes, that is the reciprocals of the densities, so that it is inverse to what the graph of the densities would be—that is, the heavier the average rock the nearer to the center it is on this graph, and the lighter the farther away.

Starting with California, we find its specific volume arc above the average, and that of Nevada-Utah to the east still higher. The average of Colorado is a trifle lower, though the elevation is higher, and this is one of the very few notable exceptions to the general rule. We are ignorant of the igneous rocks beneath Kansas; they are indicated as but a little above the average, which is probably not very far wrong. There is a decided rise below the Ozark Ridge (with its greater elevation), while the arc below the Mississippi Valley is represented by the small arc for the Lake Superior rocks, which are high in iron oxides and with high average density. Of the rocks below "Kentucky" (east of the Mississippi) we know little, but the Lake Superior arc is continued here because of the sporadic occurrences of some heavy peridotites in Kentucky mentioned above. The graph rises sharply in the arc beneath the Appalachians, falling again beneath New England, which is distinctly below the average.

With the Atlantic floor we descend to an arc beneath it that is well toward the center, as its rocks are of very high density. The arc for Great Britain is scarcely above that of the Atlantic floor, that of France distinctly higher, though still below the average, while the arc below Germany is just above the average.³⁸ With the Alpine and Tyrol arc we rise well above the average and here, just as in the elevation graph, we reach the culminating point of Europe. The arc beneath southern Russia (dotted) is placed at a level but slightly different from that of Great Britain, because, though igneous rocks are rare in this district, there are occurrences in Volhynia of very heavy iron-bearing basalts. The arc beneath the Urals is but slightly above this, corresponding with the heavy rocks of these mountains which, it is to be remembered, are low and little more than large

³⁸ The specific volume arc for Germany should be but little above that of France to correspond with the relative elevations; it appears to be much higher because very many of the German analyses of the heavier rocks (diabases, basalts, etc.), the analysis of which is most liable to error, are of very poor quality, and are therefore omitted.

hills. Of the rocks of Persia and Turkestan we know but little, so the arc below this is dotted and slopes up to that beneath the Pamirs, or central Asia. Here again our knowledge is far from precise, so that the arc is dotted and is placed at the level of that of the average of Asia, though it should probably be somewhat higher. Analyses of Chinese rocks are few, but they would seem to be in general like those of the Pamirs, though a trifle heavier. The Japan arc is above that of China, and east of this we reach the wide arc beneath the Pacific Ocean—the lowest of all, just as its rocks are the heaviest.

After the journey around the world that we have just made in the Northern Hemisphere it seems quite needless to describe that in the Southern. (Fig. 5.) The reader may follow the correspondence

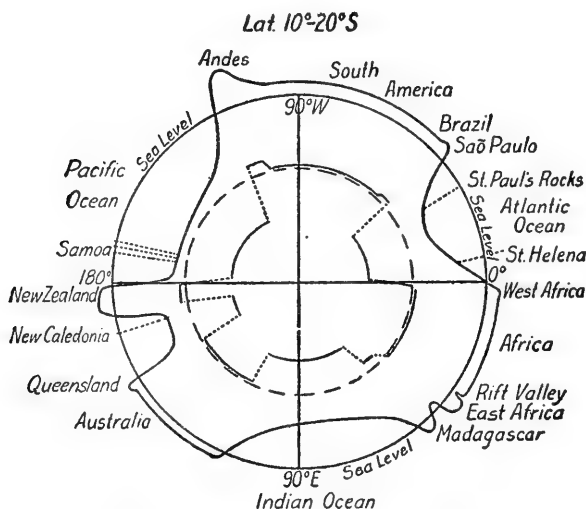

FIG. 5.—Surface relief and specific volume.

for himself, remembering that the available data along this zone are far less numerous than along the northern; though we have good knowledge of the rocks of Madagascar,³⁹ Eastern Australia and New Zealand, and fair knowledge of those of the Andes and western Africa and the Ethiopian Rift Valley.

ROCK DENSITIES AND ISOSTASY.

We come now to the final section of our study of the earth's crust, the application of the data just presented to an important theory regarding the stability conditions of the crust, the theory of isostasy.

³⁹ The average density of Madagascar is unquestionably less than that here given, as is shown by the many more analyses now available. The density 2.83 represents more properly that of Reunion, and thus that of the floor of the Indian Ocean.

As far back as 1852 J. H. Pratt suggested that there was a deficiency of gravity beneath the Himalaya Mountains, basing this on the anomalous behavior of the plumb bob.⁴⁰ He also propounded the view that the heavier portions of the earth's surface were sinking. Later, Dutton⁴¹ first clearly expounded the idea that the various portions of the earth's surface, being laterally unlike or heterogeneous, are in a delicately balanced condition of equilibrium, so that the lighter portions (those of less specific gravity) tend to rise and the heavier (those of greater specific gravity) tend to sink, the various portions thus balancing each other. This theory, later called isostasy (meaning equal standing), was taken up by Hayford, and he and William Bowie, of the United States Coast and Geodetic Survey, and others,⁴² have done much to develop it, especially as regards its application to gravity problems. While still in dispute, especially as to some details, it is now a well-recognized and generally accepted geodetic theory.

It will be well to quote in part Hayford's definition⁴³ of isostasy. Assuming a condition of lateral heterogeneity, he says:

Different portions of the same horizontal stratum may have somewhat different densities, and the actual surface of the earth will be a slight departure from the ellipsoid of revolution in the sense that above each region of deficient density there will be a bulge or bump on the ellipsoid and above each region of excessive density there will be a hollow [depression], relatively speaking. The bumps on this supposed earth will be the mountains, the plateaus, the continents, and the hollows [depressions] will be the oceans. The excess of material represented by that portion of the continent which is above sea level will be compensated for by a defect of density in the underlying material. The continents will be floated, so to speak, because they are composed of relatively light material, and, similarly, the floor of the ocean on this supposed earth [will] be depressed because it is composed of unusually dense material. This particular condition of approximate equilibrium has been given the name "isostasy."

As has been noted above, in the case of northern India it has long been known, from pendulum determinations of gravity, that in many portions of the earth the observed force of gravity does not correspond with that calculated from the form of the geoid, after making corrections for the influence of topography (such as the attraction of near-by mountain masses) and for the elevation of the station above sea level. Thus, it has long been known that gravity is on the whole greater over the ocean than over land areas, and this has naturally been connected with the fact that the rocks of oceanic islands are mostly basaltic and therefore heavy.

⁴⁰ Cf. Iddings, J. P., *The Problem of Volcanism*, p. 64, 1914.

⁴¹ Dutton, C. E., *Bull. Phil. Soc. Wash.*, xi, p. 51, 1889.

⁴² For some references, see Iddings, *op. cit.*, p. 65.

⁴³ Hayford, J. F., *The Figure of the Earth*, p. 66, 1909; Cf. Bowie, W., *U. S. Coast and Geodetic Survey, Special Publication No. 40*, p. 7, 1917.

These departures from the normal are known as "anomalies." They may be either positive, when the gravity is above the normal, or negative, when it is below. The anomalies have been studied with great care and in great detail, especially by Hayford and Bowie in the area of the United States, who have invoked the theory of isostasy to account for them. This explanation is satisfactory to a very large extent, but, as Iddings says, "There remain anomalies of density which need to be accounted for." On the whole, however, it appears that the theory of isostasy "obtains for the major features of the earth's surface." It may be suggested here (though the matter can not be discussed) that the discrepancies may be due, in part at least, to the fact that the geodesists have taken account of the rock densities only of those portions very near the surface, mostly soils and sedimentary rocks, and have neglected the deeper-lying portions. The average density assumed by geodesists for the surface rocks is 2.67, while, as we have seen, that of the igneous rocks of the earth's crust is 2.77 or 2.75.

It will be seen that the idea of the continental masses being composed of light material while the ocean floors are of heavy is by no means new. Up to the present, however, there has been no quantitative verification of this, except for the few figures covering limited areas given by Iddings. The data given above, with the graphs, therefore, are of special interest as furnishing a first approximation to a knowledge of the actual densities of the various portions of the earth's crust. It is evident that they are, on the whole, and even in considerable detail, quite in harmony with the theory of isostasy. Indeed, based, as these figures are, on a large number of data (the largest by far yet available) from all parts of the earth, and showing such a complete harmony between average density and average elevation everywhere, they may fairly be said to be more than coincidental, and to constitute almost a conclusive proof of the general validity of the theory of isostasy.

One further point of agreement may be mentioned. In figure 6 is given a map of the United States reproduced by Barrell⁴⁴ from Bowie, showing the distribution of the gravity anomalies over the United States. Let us compare this with the description of the comagmatic regions of the United States (fig. 2). In figure 6 the dotted areas are those of positive anomaly (excess gravity), while those not dotted are of negative anomaly (deficient gravity).

In the extreme northeast is a small area of positive anomaly about the Adirondacks, which corresponds with the small comagmatic outlier there of the Canadian Shield, of which the rocks are above the average in density. The greater part of Maine, with its

⁴⁴ Barrell, J., *Jour. Geol.*, xxii, p. 153, 1914.

granites, of low specific gravity, shows negative anomaly, and this area is continued down along the Appalachian region, the rocks of which are of general low density. The small areas of positive anomaly in eastern Massachusetts, Connecticut, and New Jersey may probably be connected with the extensive Triassic flows of heavy diabase and basalt which are so common here. Around the Lake Superior region we find an area of very high positive anomaly, which corresponds with the high density of the rocks of this region. On the other hand, in the Missouri-Arkansas-Oklahoma region is an area of pronounced negative anomaly, which corresponds with the low density of the region of the Ozark uplift. East of this, in Kentucky and Tennessee, is an area of somewhat high positive

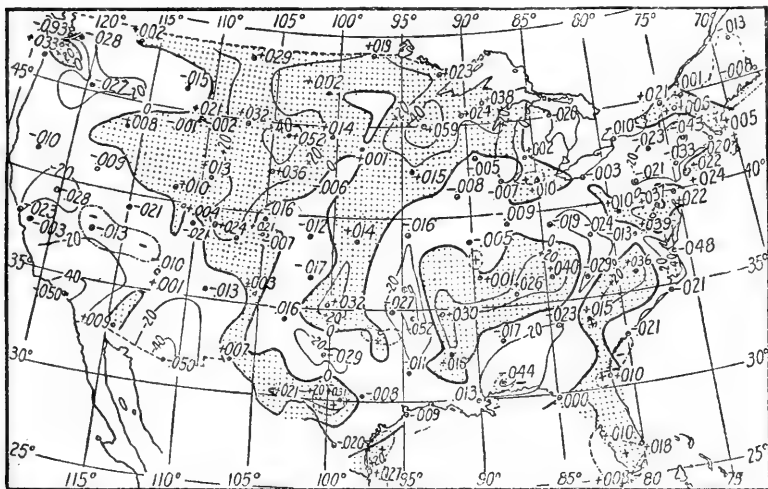

FIG. 6.—Dotted portions: Areas of positive anomaly, excess of mass. Due to surface too high or density of upper crust above mean. Blank portions: Areas of negative anomaly, deficiency of mass. Due to surface too low or density of upper crust below mean. Gravity anomalies in the United States.

anomaly, and this is in harmony with the supposition made above that the rocks underlying this area are decidedly heavy.

Toward the west the relations become more complex, just as is the geological structure and as are the comagmatic relations. We can not here go into details, which are reserved for a future publication, but the general area of negative anomaly covering the Colorado and Nevada-Utah plateau, consonant with the light rocks here, may be pointed out, as also the small area of high positive anomaly in Washington and Oregon, which may be connected with the very extensive flows of heavy basalt of the Snake and Columbia Rivers.

More might be said on this topic, but sufficient has been brought out here, it would seem, to show that there is a coincidence, even to very localized relations, between the average densities of comagmatic

regions in the United States and their gravity anomalies. Also, they appear to be too concordant to be the result of chance, so that we are justified in assuming that the two are causally related and that the theory of isostasy is thus justified.

SUMMARY.

After brief consideration of the interior of the earth, the general characters of igneous rocks are discussed, and the presence of water vapor and other gases in the magma, and its analogy with a salt solution, are pointed out. In the discussion of the mineral characters of rocks, stress is laid on the fact that the number of essential rock-forming minerals is very small. These are mostly silicates of Al, Fe, Mg, Ca, Na, and K. Any two or more of these minerals (with two or three exceptions) may occur together and in any proportions.

The chemical characters of igneous rocks are summarized and the ranges and maxima of the various constituents are given. The average igneous rock is considered, and after some discussion of the sources of error involved in the calculation, a new average in terms of oxides (based on 5,159 analyses) is given. The average rock is shown to be approximately a granodiorite.

The average composition of the earth's crust in terms of elements is also given. Twelve elements (O, Si, Al, Fe, Ca, Na, K, Mg, Ti, H, P, and Mn) make up 99.61 per cent of the crust.

The elements are referred to two main groups in the periodic table: (1) The petrogenic elements, characteristic of and most abundant in the igneous rocks, of low atomic weight, and occurring normally as oxides, silicates, chlorides, and fluorides; (2) the metallogenic elements, rare or absent in igneous rocks, but occurring as ores, of high atomic weight and forming in nature "native" metals, sulphides, arsenides, bromides, etc., but not primarily oxides or silicates. The suggestion is made that beneath the silicate crust of petrogenic elements is a zone essentially of nickel-iron and beneath this a central core of the metallogenic elements. This vertical distribution is in accord with Abbot's views as to the distribution of the elements in the sun.

In igneous rocks and minerals the elements show a correlation, in that certain of them are prone to occur with others, and a similar limited correlation is apparently true of the animal and vegetable kingdoms.

The idea of "comagmatic regions"—that is, the distribution of igneous rocks in regions of chemically related magmas—is discussed, and some of these are briefly described.

The calculation of rock densities from their chemical composition is discussed and the average chemical compositions and densities of the continental masses and oceanic floors are given. It is shown by these that the average densities of the continents, ocean floors, and various smaller regions of the earth stand in inverse relation to their elevations. The bearing of this relation of average density and elevation on the theory of isostasy is pointed out, and it is shown that the data presented are confirmative of the theory.

1871
1872
1873
1874
1875

MAJOR CAUSES OF LAND AND SEA OSCILLATIONS.¹

By E. O. ULRICH,
United States Geological Survey.

That the position of the strand line—hence the relation of land and sea levels—is and has ever been subject to change is a fact now established beyond all possible contradiction. The evidence shows that at times the shore line retreated, leaving such features as elevated sea plains and cliffs on the enlarged land areas; at other times the seas advanced on the land, drowning previous river valleys, cutting new sea plains, and laying marine deposits much farther inland than before. These frequently recurring positive and negative movements of the strand line varied greatly in amount, but on the whole they were rhythmic in occurrence and volume. But neither the record of these movements nor the rhythm that runs through it is at all simple. Most of the criteria by which we determine that submergence has occurred in one case and emergence in another are relatively simple and easily applied. But when it comes to correlating the successive stages of emergence and submergence in different localities, or when we seek to arrange the movements in proper sequence and to determine their relative duration, the problems become involved and often exceedingly complex.

The evidence presented, especially in the past few years, by Vaughan, Daly, and Barrell seems to prove that at least the marginal parts of the continents have been subjected repeatedly in recent geologic ages to positive and negative displacements of the strand line; also that the vertical element of these oscillations is not uniform in amount at different places. Considering only the Pleistocene to Recent movements, their differential character at once suggests that these were in no case *wholly* due to either the alternate storing and unloading of water in the form of ice on the lands or, as Suess and Schuchert have it, to retreats occasioned by periodic deformation and deepening of oceanic basins and ensuing slow sub-

¹ Presidential address delivered before the Geological Society of Washington, Dec. 10, 1919. Reprinted by permission from the *Journal of the Washington Academy of Sciences*, vol. 10, No. 3, Feb. 4, 1920.

mergence by deposition of land detritus in the seas. Doubtless both of these processes contributed to the displacements of the strand line—clastic deposition continuously, and deglaciation more occasionally, in effecting submergence; accumulation of glacial ice and submarine deformation in effecting emergence. In all cases the work of these agents tended to produce an even rise or fall of the sea level. So far then as the coast lands are concerned the displacement of the strand line by these two causes would have been essentially eustatic.

But we know that, commonly at least, the displacement of the strand line was not entirely eustatic but more or less differential even in short distances. Other causes, such as deformation by loading, variable gravitational attraction, etc., must have contributed to produce the complex result. Of these other factors, I am sure locally varying movements within the land masses themselves, including the more or less submerged shelf, are the most important. What the relative effects of the several factors in each particular case may have been constitutes a most difficult and varying problem. These proportions can not possibly have been the same in all cases. Besides only one of the causes of submergence—namely, the filling of the sea basins with deposit—could have been constantly in operation though obviously most variable in the volume of result. Then, on the other hand, either sudden or gradual deepening of an ocean basin would by itself suffice in effecting emergence.

Up to a certain point I agree with the suggestions of Penck, Daly, and others concerning the competence of the Pleistocene ice sheets to effect considerable lowering of the sea level; and the evidence indicating warping of the land surface, because of the uneven distribution of the ice load, as first pointed out by Jamieson, seems to me reasonably compelling. I believe also that in deglaciation the land surface largely reestablished itself by elastic, or rather, isostatic rebound to preceding relief.

Though accepting in modified form the idea of glacial control of particularly Pleistocene sea levels, it is not to be denied that the present well-known occurrence in Newfoundland and in remote outlying stations along the coast of New England and the Maritime Provinces of many plants characteristic of the coastal plain of New Jersey and the south tends, as expressed by Barrell,² "to rule out the hypothesis that emergence was controlled only by the level of the ocean water as controlled in turn by glacialiation." The extraordinary distribution of plants referred to could not be brought about by natural processes to-day. Evidently the northern occurrence of this flora is to be viewed as remnants of a

² Amer. Journ. Sci., 40, 17, 1915.

preceding continuous distribution established when the climate of the northeastern coast was warmer and its coastal strip higher, wider, and much less broken by water gaps. These required land conditions may be readily conceived as having obtained during, and as having resulted from, the ice loading of the glaciated regions to the west and northwest. As the latter sank under their growing load the continental shelf bulged its surface above sea level. But whether the plant migration could have been effected during the maximum extent of the Labrador Pleistocene ice sheet is so doubtful that Barrell³ thought it necessary to assume delay in the settling back of the upwarped marginal zone after the removal of the ice sheet. As defined by Barrell, his hypothesis is "that the weight of the ice sheets caused crustal depression directly below the load, but moderate elevation in a wide zone beyond the load. Upon the removal of the ice it appears the first isostatic upwarping carried up higher this marginal upwarped zone with it. Being already an upswollen tract the broader regional movement carried it up to a level where it became unstable and a slow settling back occurred as an after effect, coincident with the last stages of upwarping over the centers of glacial load. The actual evidence at hand does not decide between these hypotheses. The association with the close of glaciation appears to favor a genetic connection with deglaciation, but, on the other hand, it remains to be demonstrated why the extra-marginal zone should rise together with the region directly glaciated, or that the cycle was restricted to such an extra-marginal zone."

That the eastern margin of the continent, south of Labrador, did rise to higher levels than the present during the retreat of at least the last Pleistocene ice sheet seems, with Barrell's interpretation of Woodworth's⁴ data and conclusions regarding "Ancient Water Levels" of the Champlain and Hudson Valleys, highly probable. Indeed, supported as this evidence is by the facts concerning the distribution of the coastal plain flora just alluded to, emergence of this marginal area at this time may justly be accepted as reasonably established. As will have been observed in the quotation, Barrell's hesitancy in adopting this hypothesis arose mainly from the uncompleted demonstration of "why the extramarginal zone should rise together with the region directly glaciated."

In thinking this matter over the possible solution of the difficulty somewhat crudely illustrated in figure 1 has been reached. The diagram represents in generalized profile four Pleistocene stages of eastern North America, the profile running southeastwardly from Labrador to the edge of the continental shelf. The stages are repre-

³ *Idem*, pp. 19-21.

⁴ N. Y. State Education Department, Bull. 84, 1905.

sented separately, showing relief of land surface in each and the extent of the ice sheet in the maximum and two partly deglaciated stages. The fourth represents the present condition. One of the new features is that as the ice retreated the normally positive strip bordering the present eastern shore responded at once to the release from directly applied weight pressure by rising. Emergence of this Piedmont and Coastal plain strip would be further insured by the necessity of maintaining isostatic balance with the outer strip of the continental shelf which had bulged to emergent status by subterranean flow from beneath the ice loaded land. In consequence, as the

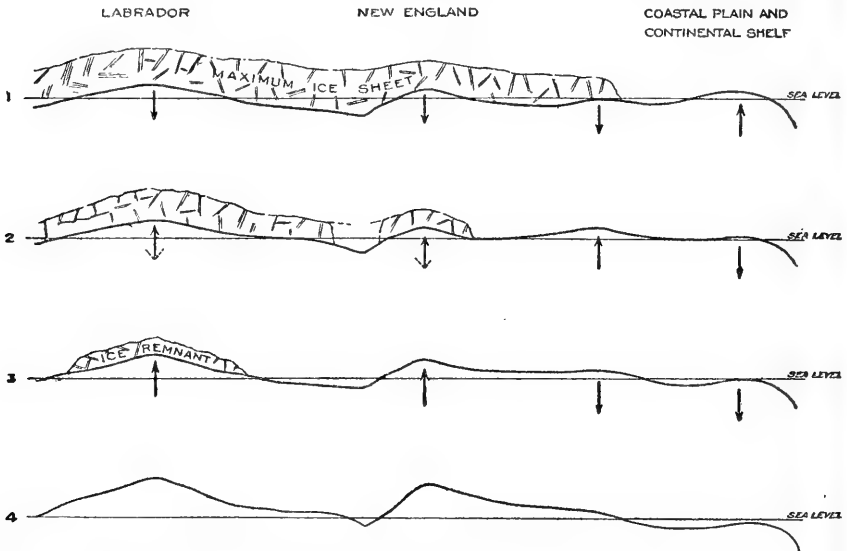

FIG. 1.—Generalized profiles of eastern North America in Pleistocene stages, indicating isostatic vertical movements of surface of lithosphere in process of deglaciation: 1, During maximum extent of ice sheet, when the outer part of continental shelf was emergent; 2, When the ice load had retreated from the present coastal strip; 3, A later stage when the ice sheet had been reduced to the area of Labrador; 4, Present relief of land, with submergence of continental shelf. Approximately similar conditions may be supposed to have obtained in the growing stages of the ice sheet.

ice sheet retreated the emerged outer part of the continental shelf began to sink, whereas the strip along the landward side of the present shore rose. Among the physiographic changes that may be supposed to have occurred at the time of this southwardly decreasing elevation of the coast lands north of Baltimore is the cutting of the now buried deep channel of the lower Hudson; also the sharp southward deflection of the Delaware and Susquehanna Rivers. During the preceding maximum extent of the ice sheet Maryland is supposed to have stood higher than at present and the lower stretches of these rivers either flowed northeastwardly or they emptied more directly and much sooner into the sea, which then probably covered

the New Jersey part of the coastal plain and extended widely into the eastern valleys of the adjacent Appalachian region. As the ice sheet retreated Maryland settled back while the coast lands to the north rose. The resulting emergence and the reversal of the tilt of the land surface must have produced corresponding changes in the direction of flow of affected rivers. Obviously results like these required practically immediate isostatic response to both the accumulation and the removal of the burden of ice and not as Barrell thought, "a deferred intermittent, and possibly oscillatory, readjustment." (Op. cit. p. 21.) On further retreat of the ice front the upward movement of the latter was arrested and finally reversed, so that it shared in the general subsidence of the marginal area when the complete withdrawal of the ice sheet permitted isostatic rebound of the unloaded interior highlands to their preceding and present normal land altitudes.

In consequence of the bulging of the sea bottom adjacent to shore lines that in the maximum spread of the ice sheets had sunk beneath the load of ice, the capacity of the ocean basin must have been correspondingly lessened. This in turn would have tended to retard and finally reverse the downward direction of the change in sea level previously prevailing on account of subtraction of ocean water for the making of the ice sheet. That is, it would have caused actual raising of sea level except in those parts of the shore line that were covered by the ice sheet and therefore directly affected by its weight. The upward movement of the sea level thereby occasioned would have been worldwide and eustatic.

But the displacements of the Pleistocene strand line along the Atlantic coast that were in any wise connected with glaciation must, because of varying conditions arising from the fact that the ice sheets did not reach the shore line south of New Jersey, have varied greatly in amount and direction at different places. It was only in the early stages of glaciation, before peripheral elevation of the surface of the lithosphere with respect to areas bearing ice loads had progressed to the stage wherein it caused material lessening of capacity of ocean basins, that the sinking of sea level could have been eustatic. On the reversal of this sea-level movement, when the Pleistocene ice sheet stretched to the shore and when as stated above, the consequent bulging of adjacent parts of the continental shelf reduced the capacity of the ocean basin, the change in sea level as manifested in the advance and retreat of the Atlantic shore north of, say Cape Hatteras, was far from eustatic. During this maximum extent of the Labrador ice sheet, the ice-covered near-shore lands about the Gulf of St. Lawrence must have sustained extensive submergence. Southwardly from northern Maine to New Jersey the amount of this submergence decreased perhaps to its minimum. On the other hand, in

Maryland, which I take to have lain at that time within the belt of peripheral isostatic elevation, the land was pushed up with resultant apparent or relative sinking of sea level. Farther south, beyond the belt of peripheral bulging, the Atlantic shore probably shared in the eustatic rise of sea level that prevailed generally, because of the temporarily decreased capacity of ocean basins except in the areas affected immediately and differentially by the ice sheets.

Correlation of Pleistocene sea beaches in Maryland and Maine therefore suggests and perhaps requires comparison of the low beaches in Maryland with high beaches in New England.

Because of this dissimilarity in manifestation, it seems to me that it is only in the warm temperate and tropical zones lying well beyond the areas in which isostatic balance would be materially disturbed by known ice loading of lands, that the sequence and amount of the several glacially controlled Pleistocene changes of sea level are recorded in their proper relations to the actual fluctuations of the volume of sea water and to the capacity variations of the basins holding it. But even in tropical areas the complete sequence of the oscillations and the immediate cause of each can not be worked out without taking strict account of what was happening at the same times in higher latitudes.

In thinking of the progressive and regressive sequences of movements it is well to remember that ice loading and sediment (rock) loading of epicontinental areas are comparable in their deformational effects on the lithosphere only in one respect—that is, in both cases the loaded area sinks. They differ, primarily, in that the ice cap originates on, and spreads outwardly from, normally positive areas, whereas the rock sediments are laid only in areas of relatively negative tendencies. Subsidence because of ice loading, therefore, is an abnormal process in that it is carried on under unusual conditions, so that normal gravitational tendencies are reversed; in the other case not only the process but the results also are perfectly in accord with the normal gravitational tendencies of the affected areas. Next, they differ in that the ice sheets presently melt away, whereas the water-laid rock deposits commonly remain as a permanent asset of the area covered by them. A third difference is that in the first cases the removal of the ice load tends to reestablish the normally positive tendencies of the deglaciated areas, whereas in the areas loaded with rock deposits their normal negative tendency is not reversed.

Finally, there is the rather generally accepted belief among stratigraphers and students of paleogeography that in the past the advances of the sea usually were slow and gradual, whereas the retreats were more rapid and relatively impulsive. Many facts in

Paleozoic stratigraphy are cited in my *Revision* in support of this belief, and Barrell, in 1915, expressed himself as favoring the view.

Now, if we accept this conclusion it certainly does not help the hypothesis of measurable sea-level fall by storing of oceanic waters in continental ice sheets. Obviously, the subtraction of water from the seas to make the ice sheets must have been a slow and on the whole gradual process; and the time consumed in the growth of the ice sheets probably was not materially shorter or longer than that required in their melting.

From these considerations it is clearly evident how exceedingly difficult is the proper determination of the part actually played by glaciation and ensuing deglaciation in the emergence and submergence of the continental borders. The fall and rise of sea level directly resulting from the storing of oceanic water to make a great ice sheet that later is returned to the sea is so intricately connected and interwoven with genetically similar but at times oppositely directed general and local deformations of land areas and also of sea-bottom areas adjacent to the strand line, that the reliable valuation of the two or more factors seems as yet practically hopeless. Moreover, it appears to me that only the early and the late stages of a period of glacial control could have made and left anything approaching world-wide and vertically equal records of consequent displacements of the strand line. The early stages would be those in which the lateral growth of the ice sheet had not yet reached the zone in which the weight of the ice would have caused extramarginal bulging and apparent lowering of sea level far in excess of the fall actually occasioned by transferal of water from the sea to the land. Similarly the later stages would be those following the retreat of the ice sheet to the same relatively innocuous limits.

It follows then that only the eustatic smaller shiftings of the Pleistocene sea levels may be definitely ascribed to storing and subsequent release of frozen water on the land. And for these even it is mainly their occurrence in a known ice age that induces one to admit their probable glacial origin. However, the larger and in most instances also much more local Pleistocene oscillations of the strand line, even granting that their causation is intimately connected with ice loading and unloading of land areas, belong to another category. Strictly speaking, these larger displacements have resulted from truly diastrophic causes and processes that are concerned with the maintenance of the isostatic equilibrium of the lithosphere.

Under the circumstances, then, I must agree with Barrell in concluding that the amount of water taken from the seas for the formation of the ice sheets was not a direct "major factor in the control of Pleistocene sea levels." Movements, acting within, beneath, and

upon the lithosphere thus appear to have been the more effective factors.

That the marginal areas of the continents were at times elevated and folded is, of course, accepted by all—even by Suess and his followers, who speak of the continents as having the character of "horsts" and of the ocean basins as being permanently "sunken areas." Suess, however, believed that the median areas of the continents are essentially stable, a view adopted by Schuchert, who holds "that the continent (North America) is a horst, that the great medial region remained unmoved, while the margins were often folded and elevated. The seas periodically flowed over this medial land—in fact, were elevated over it—owing to the detrital materials unloaded into the oceanic areas, thus filling them and causing them to spill over on to the lands."

I can not subscribe to this opinion. On the contrary, though accepting the idea of permanent oceans and continents, it seems to me that the crust of the lithosphere was subject to periodic movement away from the poles; that the surface of the lands was exceedingly unstable in the median areas as well as along the borders of the continents. Schuchert's paleogeographic maps, indeed, offer convincing proof of such instability; and the more detailed maps made since his appeared further substantiate my claim.

In reaching these conclusions I am mainly influenced by a lifetime study of Paleozoic formations and their faunas. The criteria and principles used in the course of these stratigraphic investigations are defined and discussed in my *Revision of the Paleozoic Systems*, published in 1911. In this work more than 100 previously undescribed instances of differential vertical movements of lands and consequent shifting of seas are discussed in varying detail. Since 1910 much additional information has been gathered concerning such oscillations in North America.

On this occasion I shall mention briefly some of the more convincing of the published cases and in greater detail a few of the more recently determined instances—enough of both to show that from the beginning of Cambrian time the surface of the continents was exceedingly unstable and subject to frequent oscillation, and that the epicontinental seas were correspondingly inconstant, shallow, relatively small, and frequently withdrawn in part or entirely. Even in the same geological provinces the outlines of the new sea may agree essentially and often very closely, in parts, with the next preceding or some earlier sea, but in other parts the new shore line departs radically from the older.

These movements occurred in Paleozoic ages which, unlike the Pleistocene, have left no record of great ice accumulations. Doubtless even in the Paleozoic there were times of relative frigidity,

when some of the higher parts of the marginal lands were ice-covered, in some instances attaining locally to glacial conditions. Here and there regular tillites are indicated, notably as recently brought out by Dr. Edwin Kirk, in the Silurian deposits along the coast of Alaska. Occasionally, too, transportation of bulky erratics by heavy shore ice is suggested, as, for instance, by the late Ordovician Rysedorph hill conglomerate near Albany, New York, and the great masses of unworn limestone of Ordovician and Silurian ages found in the early Pennsylvanian Caney shale of eastern Oklahoma. But the Paleozoic history of North America so far as known affords no suggestion of ice ages comparable to the Pleistocene period in the amount of water abstracted for the formation of the ice sheets. Moreover, by far the majority of the displacements of the strand line in the continental seas occurred at times and places that give no indication whatever of particularly cool climates. On the contrary, the entombed faunas in the overlapping and interfingering marine formations could hardly have lived in the shallow seas if the climate of the adjacent lands had not been mild.

With the data in hand I feel warranted in asserting that the level of the Paleozoic continental seas was seldom appreciably affected and certainly never controlled by glaciation. Besides, the apparently irregular, though doubtless rhythmic, shiftings of the strand line almost without exception indicate local differential movement in the continental surface. And these movements must have been connected with other more general movements, requiring at times partial or complete withdrawal of the waters from the land depressions, at other times permitting readvance in the same or some other newly depressed land basin.

The varying distribution of marine deposits of successive ages naturally suggests differential upward and downward movement of the lands as the immediate cause. If the submergences had been occasioned solely by rise of the waters, the successive submergences would have been always similar in geographic pattern and different only in lateral extent. In fact, a general similarity or repetition of old patterns is recognizable, but there is also exceeding diversity of expression, and often the difference is greatest when directly succeeding stages are compared. Often, again, when one stage appears to have been very different from the next, the following third or fourth may be very much like the first. Only oscillatory movements or warping of the land surfaces could produce such results. The area affected by such movements may be very large, as, for instance, during the Middle Ordovician and Middle Silurian, when nearly half of the continent of North America was involved. During these periods the Gulf waters seem at certain times to have been completely withdrawn from the southern part of the continent, the middle and

northern parts at such times being tilted so that the boreal sea extended southward beyond Chicago and occasionally as far as northern Tennessee.

Strictly, these widely operating movements hardly fall under the category of epeirogenic movements. On the other hand, they are not truly orogenic, if that term is to be confined to movements originating in shrinkage of the centrosphere. Apparently they indicate a combination of causes, perhaps beginning or ending with the play of orogenic factors that built mountains in the submarginal areas, whereas the warping and deformation of the more stable interior areas was mainly occasioned by the necessity of isostatic readjustments to stresses incident to the greater deformations of the orogenic movements.

Then there were many relatively local changes in the strand line of continental seas that may be explained only by assuming correspondingly local differential, vertical movements of the lithosphere. I do not refer to movements connected with volcanism. On the contrary, the best examples of the kind in mind are found in areas but rarely or not at all directly affected by volcanism. These differential movements indicate actual elevation of one area while another near by was sinking. Moreover, in the next recorded age the directions of ensuing movements at the two places often were reversed. The phenomenon might be likened to a gently convex platform supported in the middle and tilted alternately to the east and west and at other times to the north and south. The condition is recognized by the alternate presence and absence of sediments of particular ages on opposite sides of the tilting platform. (See fig. 2.)

Comparative studies of the Paleozoic deposits in the Appalachian Valley region, from eastern Pennsylvania on the north and central Alabama on the south, have brought out over a hundred clearly defined examples of such oscillations. They are manifested by the restricted distribution or local deposition of many overlapping formations, having maximum thicknesses of from 200 to over 2,000 feet. In many cases these formations are wholly or mainly confined to one or more narrow, troughlike, longitudinal divisions of the Appalachian geosyncline and commonly to one or another of three divisions of the geosyncline that are more or less effectively separated from each other by low transverse axes. The most northerly of these broad axes passes across the valley between Carlisle and Lebanon, Pennsylvania. It is known as the Harrisburg axis. The next, to the south, intersects the valley of Virginia between Staunton and Harrisonburg. The third, or Wytheville axis, passes across southwestern Virginia, which is to-day the highest and narrowest part of the great valley. The fourth axis crosses in a more northerly direction than

the others through the belt lying between Rome, Georgia, and Gadsden, Alabama.

These transverse axes do not cross the longitudinal troughs of the geosyncline in continuous direct lines. On the contrary, their course zigzags within the varying limits of a broad band, so that the northern head of a bay in one trough may extend 50 miles or more beyond the latitude of the southern head of another younger or older bay in an adjacent trough. The band is wide enough and was always low enough so that regional tilting occasionally permitted overlap of edges of formations transgressing from opposite directions. Often

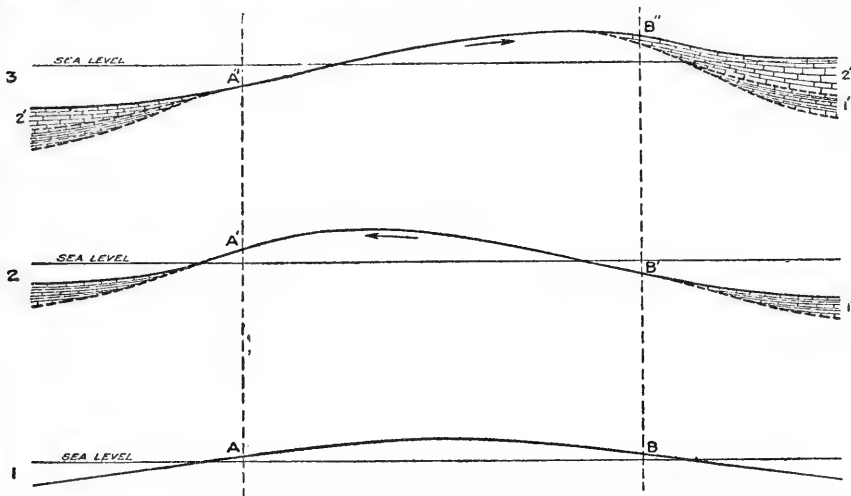

FIG. 2.—Diagram illustrating tilting of interior areas of uplift (for example, the Cincinnati dome), and the consequent variations in amounts of advance and retreat of the sea on their opposite sides. Arrows indicate direction of horizontal stresses. The letters A, A', A'', on the one side, and B, B', and B'', on the other, mark the same points on the flanks of the dome in all of the three stages. In 1 the sea laps equally on both sides; in 2 the elevation of the dome is accentuated and its summit has migrated to the left, while the sea has advanced much more on the right side than on the left; in 3 the summit has migrated in the opposite direction so that the deposits of the preceding stage on the right flanks are largely emerged, whereas on the submerged left flank the new sea widely overlaps the deposits of the two preceding stages (1' and 2').

the axis formed an efficient barrier in one trough and was much less effective in the one next to the west or east. More rarely, a bay, terminated at the north by a transverse axis, connected laterally with waters in an adjoining trough in which the submergence was not stopped by the axis. Finally, at other times the axis offered no serious obstacle to the passage of the marine invasion. Of course, the individual troughs were submerged over and over again, but in none do we find representatives of all of the formations known to have been deposited in the Appalachian Valley.

Varying geographic expressions like these could have been made possible only by differential vertical movements in the concerned

parts of the lithosphere, and these Appalachian oscillations in sea level were by no means small affairs. Most of them are measured by hundreds of feet and some by thousands.

Excellent and very interesting oscillations occurred about those more inland and very ancient positive areas known as the Cincinnati and Nashville domes, the Ozark and Adirondack uplifts, and the Wisconsin peninsula. Of the many formations that are found on their flanks and which failed to pass over them much the greater number are confined to one or the other side. The sequence of formations on either side therefore differs greatly from that on the opposite side.

Much space is devoted in my *Revision of the Paleozoic Systems* to a description of the inequalities in areal distribution of the formations that were laid down on the flanks of these epicontinental domes. With a few corrections and modifications, in every case tending to emphasize rather than to weaken the argument based on the observed phenomena, the published statements concerning them in that work have been further substantiated by more recent investigations. Instead of overstating the number of oscillations in that paper we can now prove many more instances than were known or even suspected by me in 1910.

In New York State alone the joint investigations carried on in the Ordovician shales and limestones on the south and west sides of the Adirondack mass by Doctor Ruedemann and myself, and on the Medina and Clinton formations with Mr. Hartnagle, have increased the established cases of sea shifting implying more or less decided differential vertical movements in the adjacent land masses to more than twice the number contemplated when I wrote the *Revision*.

Similarly the work of Mr. Charles Butts and myself on the Mississippian formations in Illinois, Kentucky, Tennessee, and Alabama has developed oscillations of like character that were scarcely suspected six years ago.

Very notable additions to our knowledge of Cambrian and Ozarkian oscillations also have been made in the course of my work on the Paleozoic formations in Wisconsin. Before closing permit me to give some details concerning at least one of many similar new discoveries in this and adjoining States.

Only a few years ago the stratigraphy of the Cambrian deposits in the upper Mississippi Valley was practically unknown or at best only very imperfectly understood. Because of certain misapprehensions, now clearly understood, the correlations of the several sections by the State geologists of Wisconsin, Minnesota, and Iowa were not only inadequate but quite in error.

So long as the observed variations in character of deposits and their fossil faunas were supposed to indicate nothing more than

merely local variations in contemporary seas and life it was almost impossible to work out the true relations of the beds in the largely drift-covered, and hence discontinuous exposures of the Cambrian rocks. A new viewpoint was required; also closer investigation of bedding planes, greater accuracy in noting the vertical and geographic ranges of particular species and faunal associations and of particular beds. In short, it was necessary to employ more modern criteria, principles, and methods than had been used before.

When the work of revising the Paleozoic stratigraphy of Wisconsin was begun in 1914 the task seemed relatively simple in view of the success that had attended our investigations in the supposedly more difficult fields in the Appalachian region, about the Cincinnati and Nashville domes, and the Ozark and Adirondack uplifts. Indeed, the results of the first season's work in Wisconsin were so satisfactory to Doctor Walcott that he decided to publish my revised section in his work on the Dikelocephalid trilobites.⁵ As therein given the Upper Cambrian series in the Mississippi Valley is divisible into six lithologically and faunally distinct formations, named from below upward: The Mount Simon sandstone, which rests on pre-Cambrian crystallines, followed in turn by the Eau Claire shale, the Dresbach sandstone, the Franconia (glauconite bearing) sandstone, the St. Lawrence formation of limestone, shale and sandstone, and the Jordan sandstone. Above these came the Lower Ozarkian Mendota limestone and the Madison sandstone, the last of which is overlain by the Oneota dolomite of the "Lower Magnesian" series. Aside from the determination of the lithologic and faunal sequence of the Cambrian in the western half of the State, the most important improvement brought about by the first season's work was the proof that the Mendota limestone and Madison sandstone are really post-Cambrian formations and not, as had been supposed previously, the eastern representatives of, respectively, the St. Lawrence limestone and the Jordan sandstone of Minnesota. In fact, it was then believed and has since been definitely proved that whereas the St. Lawrence extends uninterruptedly from Minnesota and Iowa across the southern half of Wisconsin and under cover of later formations into northern Illinois, the Mendota limestone is entirely absent to the west of a narrow trough running southeastwardly from the southern slope of the pre-Cambrian Baraboo quartzite range.

In the following field season of 1915 doubt arose as to the eastward extension of the Franconia formation to and beyond Madison. At this place there is a more or less decidedly calcareous sandstone formation, approximately 100 feet in thickness, which lies between un-

⁵ *Dikelocephalus* and other genera of the *Dikelocephalinae*. Smithsonian Misc. Coll. 57, 1914.

questionable Dresbach sandstone and no less certainly established St. Lawrence limestone and shale. The intervening formation therefore seems to occupy the same stratigraphic position as the Franconia. But its lithological characteristics, except that it also contains considerable, though more disseminated glauconite, are quite different from those of the Franconia; and whereas good fossil remains of characteristic types are exceedingly abundant in the Franconia they appear to be much fewer and, so far as could be determined from the handful of fragments then procured, of different species.

In casting about for a means of determining the problem I thought of an old anticline that extends southwestward from the Baraboo range across southern Wisconsin into Illinois. This axis had previously been found to have had an important effect on the distribution of the Ordovician formations and it seemed worth while to see whether it had not been in existence, and functioning as a barrier,

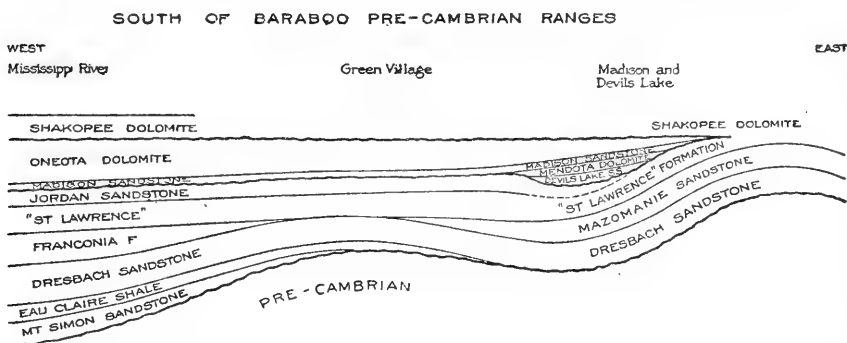

FIG. 3.—Section across southern Wisconsin, showing sequence of Upper Cambrian (St. Croixian, and Ozarkian formations, the apparently similar stratigraphic positions of the Franconia and Mazomanie formations, and the absence of both on the summit of the pre-Cambrian anticline.

already in the Cambrian. Accordingly, a part of the season of 1916 was devoted to following the nearly continuous exposures of Cambrian rocks in the bluffs and valley walls along the Wisconsin River.

Beginning at Boscobel and going upstream, the Franconia, in typical development, was found to hold its own for a distance of about 20 miles, when it began slowly to lose thickness by overlap. The succeeding 15 miles, which brought us to the town of Lone Rock, sufficed to pinch the formation out entirely. Beyond Lone Rock, for a distance of about 10 miles, in which we passed through the town of Spring Green, the Franconia is absent, the top of the underlying Dresbach sandstone has risen considerably above the river level and is immediately followed by characteristically fossiliferous shales and limestone of St. Lawrence age. (See fig. 3.)

Just east of Spring Green the closed contact between the Dresbach and St. Lawrence opens again to receive the wedge of magnesian sandstone whose age was the quest of the undertaking. Where first

exposed in the bluffs east of Spring Green the Mazomanie sandstone, as the new formation is called, is about 10 feet thick. Four miles east of the town it has thickened to 80 feet, and at Fairy Bluff it reaches 100 feet. Wherever it rises to considerable heights above the valley bottoms in Dane, Sauk, and Columbia counties it forms cliffs, which is not at all true of the typical Franconia.

But, so far as positive evidence regarding the age relations of the Franconia and the Mazomanie is concerned, these investigations of the bluffs along the Wisconsin River left the question as unsolved as before. Nor did we come any nearer to its satisfactory solution in the course of the following season's work when a series of sections was made on the south side and around the eastern end of the Baraboo Range. But just before the close of the field studies in 1918 some very promising but under the circumstances inconclusive

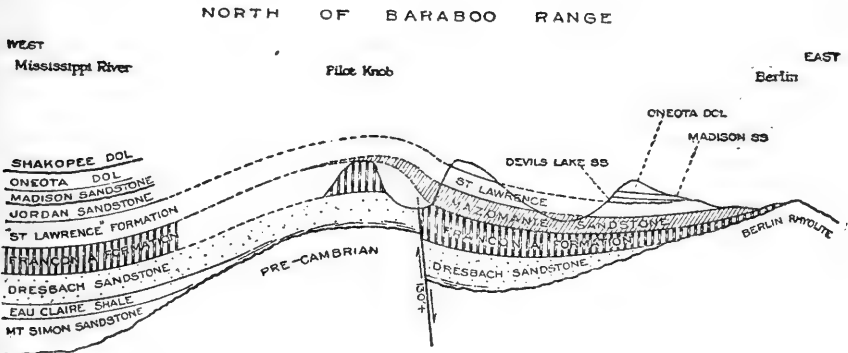

FIG. 4.—Section across central Wisconsin, showing greater eastward extent of the Franconia in this part of the State and intercalation of the Mazomanie between the top of the Franconia and the base of the St. Lawrence.

observations were made in sectioning the outliers and bluffs which dot the sandy plain of central Wisconsin. Namely, at one of these bluffs I found a perfectly characteristic Mazomanie cliff and beneath it a 2-foot exposure of reddish sandstone that seemed to me to be of Franconia age.

However, the evidence at this place was not satisfactory to Dr. W. O. Hotchkiss, State Geologist, and Mr. F. Thwaites, who accompanied me on this as on most of the other trips through the State. Their doubts arose mainly from the fact that my interpretation required the assumption of a fault hitherto unsuspected between this bluff and Pilot Knob, which lies less than a mile to the northwest.

And so it was left to the work of the past summer to clear away all doubt, if possible. And it was cleared away. Other outliers in this vicinity were visited until finally we found two that were capped by Mazomanie and St. Lawrence and beneath the Mazomanie showed

from 50 to 100 feet of profusely fossiliferous Franconia. Incidentally the presence of the fault just mentioned was unquestionably established. As an interesting and welcome confirmation of the earlier conviction that the Franconia is older than the Mazomanie—welcome despite the fact that it came to light after the case had been proved by actual superposition—I may add that two entirely new faunas, one from near the top, the other just above the base of the formation, were discovered in the Mazomanie. The upper of the two occurs rather widely distributed but in a sandstone so friable that it can not be picked up without crumbling in one's hand. Despite this difficulty a considerable collection was made and safely transported to Washington by soaking the sand with shellac.

I have described the solution of this problem in greater detail than may seem necessary, first because of its intrinsic value and interest as a new instance of oppositely overlapping formations, second because of its bearing on the question of differential surface movements, and third as an illustration of the thoroughness of modern stratigraphic investigations.

The case shows differential movement, first in the fact that the Franconia is confined to the western half of the State, whereas the preceding Dresbach was laid down on the east side and over the south side as well as the west. Next, the very different distribution of the Mazomanie shows reversal of the tilt from the west toward the east. Further—through the fact that the two formations are separated to the south of the Baraboo Range by a broad strip, in which neither is present, whereas to the north of the pre-Cambrian range both formations were laid down so that the younger overlaps the older for a distance of at least 50 miles—it is proved that the movement was not simply an east-west reversal of tilt but that it was accompanied by additional local subsidence on the north where a depression was formed that subsequently lodged a considerable embayment of the Mazomanie sea.

But this does not exhaust the known record of diastrophic movements of this time in Wisconsin. Uplifts of the relatively evenly distributed floor of Dresbach sandstone are indicated in many places; and depressions occurred in other localities so that the Franconia lapped over in such places onto the pre-Cambrian rocks. This occurs at Taylors Falls, and possibly at Berlin,⁶ towns located on opposite sides of the area covered by the formation. At Osceola, on the other hand, there is a narrow ridge on the surface of the Dresbach that completely cuts out the Franconia, though the formation is well developed both to the north and south of Osceola. Finally, we recog-

⁶ Larger collections and a more thorough study of the fossils found in the Cambrian sandstone that lies on the uneven pre-Cambrian floor at Berlin, Wisconsin, tend to the conclusion that this bed is of Mazomanie or possibly even of St. Lawrence age, hence younger than the Franconia.—E. O. Ulrich, Mar. 18, 1921.

nize two longer upwarps of the Dresbach floor that extend in a south-westerly direction from the central pre-Cambrian land mass which formed the backbone of the Wisconsin peninsula. These buried ridges divided the Franconia sea into basins sufficiently distinct to show well-marked differences in their respective depositional sequences and faunas.

But why pile up the evidence, the sameness of which must weary you. Suffice it to say that the phenomena indicating differential vertical displacements of the strand line are everywhere about us and as abundant and well displayed in the areas of Paleozoic rocks as in those of more recent ages. One need but to compare a series of paleogeographic maps which, even despite their admittedly generalized and synthetic nature, yet show—unmistakably and clearly—variations in outlines of successive continental seas that would have been impossible if the land surfaces periodically invaded by them had not been subject to frequent oscillation and warping.

Physiographers, apparently, have paid little attention to these paleogeographic maps and the discussions of stratigraphic correlations that usually accompany them. Perhaps the reason for this oversight lies in the fact that most of them have been made by paleontologists—a kind of geologist who should be seen but not heard on physiographic and diastrophic questions. But, after all, does not the stratigraphical paleontologist deal with a wider range of geological data and criteria than any other specialist in the science? Of them all, I regard the stratigraphical paleontologist the best equipped to bring out the dominant facts in questions of the kind before us. He has the same opportunities and desires to observe and note the physical factors of the problem, and in addition an appreciation of organic criteria that may not only be applied directly in the field but the tangible evidence—in the form of specimens usually small enough to be collected—may be carried to the laboratory and there be studied at leisure and as often as desired. I have found this of very great advantage.

For such reasons I would be disposed to prejudice in favor of earth students like Vaughan or Schuchert in cases of controversy with others who can not personally take into account and weigh the organic as well as the physical aspects of a problem. However, in the present instance I have gathered so much competent evidence of my own that I feel warranted in reaching the conviction that the major factors in the control and migration of the strand line lie and have always lain in deformative movements within the lithosphere. These movements, whether large or small and whether due to shrinkage of the centrosphere, to local changes in crustal density, to unequal loading by rock or ice, or to erosion and further lightening of positive areas, are all primarily concerned with the maintenance of isostasy.



THE BRYOZOA, OR MOSS ANIMALS.

By R. S. BASSLER,
United States National Museum.

[With 4 plates.]

CONTENTS.

	Page.		Page.
Introduction.....	339	Types of Bryozoa—Continued.	
General characters.....	340	Superorder Gymnolaemata.....	353
Classification.....	342	Order Ctenostomata.....	353
Collection and preparation for study....	344	Order Cyclostomata.....	356
Methods of study.....	346	Order Trepostomata.....	359
Types of Bryozoa.....	350	Order Cryptostomata.....	363
Subclass Entoprocta.....	350	Order Cheilostomata.....	364
Subclass Ectoprocta.....	351	Distribution of the Bryozoa.....	375
Superorder Phylactolaemata.....	351	Stratigraphic value.....	376

INTRODUCTION.

To the layman the paradoxical term "moss animals" has little significance, and even to the scientific student this, or its Greek equivalent, "Bryozoa," is often no more than a name. Yet these microscopic animals, growing often into mosslike colonies, are extremely abundant in the present-day seas at all latitudes, and their fossil remains are equally common and widespread in almost all the sedimentary rocks since early geologic times. Notwithstanding this great development in both the past and the present, the study of the bryozoa has always been limited to a comparatively few specialists who have been unable to overcome the popular belief that this group of animals presents too difficult a problem for any but the expert willing to spend a lifetime of research upon them. This belief has been strengthened by the fact that practically all of the published works upon the bryozoa are of a highly technical nature and usually deal with some special subject. In none of them is there a review in relatively simple language of the class as a whole. The present article has been prepared in an endeavor to remedy this condition. Descriptions and illustrations of typical examples of the various types of bryozoa, both fossil and recent, the methods employed in studying them, and the interest and value of this study from various standpoints are presented in the hope that the class will in future receive the attention that it deserves.

The bryozoa are perhaps best known to-day from the paperlike fronds called "sea mats" and the mosslike structures tossed upon our seacoasts. These are not plants as was long supposed but are animal colonies consisting of a great number of small cells opening side by side.

Before their true nature was learned these organisms were placed in a halfway group termed "zoophytes," partly animal and partly plant. The coral-like appearance of the calcareous bryozoa gave origin to another term "corallines." When it was discovered, however, that each individual cell of the composite colony contained an animal with a complete alimentary canal totally unlike the corals or any other group with which they had been compared, the name "Bryozoa" was definitely introduced for them as a new group of animals by C. G. Ehrenberg in Germany in 1831. Another term, "Polyzoa," applied by J. B. Thompson in Ireland in 1830, was not so precisely defined, and a long controversy arose concerning the two rival terms. This has been settled by a curious division of opinion, namely, the term "Polyzoa" is preferred by most English naturalists, but all of the continental and American authors employ the designation "Bryozoa."

GENERAL CHARACTERS.

The bryozoa are small, composite, usually marine animals arising from a free-swimming larva which becomes attached to some foreign object and then develops into the primary individual or *ancestrula*. By repeated budding from the *ancestrula*, colonies of various shapes and sometimes considerable size arise. Each individual animal or zooid is composed of a double-walled membranaceous or calcareous sac, the *zoecium*, within which is the visceral mass, the *polypide*, consisting of a freely suspended alimentary canal U-shaped so that the mouth and anus open close to each other. The mouth is surrounded by the *lophophore*, bearing a crown of hollow, slender, ciliated tentacles arranged in a circle or crescent by which microscopic organisms such as diatoms are gathered for food. Both sexes are usually combined in the same zooid. It is a curious fact that the same *zoecium* may be inhabited at different times by different *polypides*.

The colony which the individual zooids form is known technically as the *zoarium*; it presents a great variety of form and structure, although the form is quite constant in individual species. Very frequently the *zoaria* grow over shells, stones, or other bodies, forming delicate incrustations of exquisite patterns. By the superposition of many such incrustations, hemispherical, globular, nodular, or irregular masses, often of considerable size, may result. Again, the *zoaria* may arise in fronds or branching stems, and at other times

they form open-meshed lacework of the most regular and beautiful patterns. Most bryozoa are attached either basally or by the greater part of their surface to extraneous objects or are moored to the bottom by rootlike appendages. In many forms the zoarium is regularly jointed to give greater mobility.

The individual zooids of the zoarium conform to a simple and definite type of structure throughout the class. The soft parts of the animal consist of an alimentary canal with three distinct regions discernible—esophagus, stomach, and intestine. The alimentary canal is inclosed in a sac and bent upon itself so that the two extremities are close to each other. The mouth, or oral opening, is either entirely or partially surrounded by a row of slender, hollow, ciliated tentacles which serve for respiration and for sweeping food toward the mouth. The two large divisions under which the bryozoa are classed (Entoprocta and Ectoprocta) are based upon the position of the anal opening. In most cases the anal opening is situated without the row of tentacles (Ectoprocta); rarely it is placed within this row (Entoprocta). A heart and vascular system are wanting, but there are numerous leucocytes floating in the general cavity. A nervous ganglion is present between the mouth and anus and sends delicate nerve filaments to the tentacles and esophagus. The upper part of the sac is generally flexible and can be invaginated through the action of numerous longitudinal and transverse muscles which traverse the fluid-filled visceral cavity.

The reproductive organs are developed in various parts of the body cavity, although the spermatozoa occur usually in the lower and the ova in the upper part. The ova may be developed in a special receptacle, in an inflation of the surface, or in a modified zoecium. The general term oecium or oviceil is applied to all of these structures.

The above general description of the anatomy of the bryozoan applies, with certain exceptions, to all divisions of the class, and more modification in structure is to be observed in the protective covering or home of the animal, the zoecium, than in the animal itself, the polypide. The accompanying diagram of the anatomy of a single zoecium (text fig. 1), with its polypide retracted, will illustrate this general structure. The mouth leads into the ciliated pharynx, and this into the esophagus, followed by the stomach, which in turn passes into the intestine, and this through the rectum, communicates with the exterior by the anus. When retracted the tentacles lie in a cavity, the tentacle sheath, which opens to the exterior by the orifice.

Many bryozoans exhibit, attached to the zoecium, organs resembling a bird's head, termed "avicularia," and other bristlelike appendages named "vibracula." The jaws of the avicularia open

and close with a snapping motion, which has given rise to the probably erroneous idea that they are organs of defense. These two organs are mentioned in more detail in the consideration of the cheilostomatous bryozoa. Both the avicularia and vibracula are incapable of preservation in the fossil state, but their former presence is indicated by the porelike excavations in which they lodged.

The extended polypide is withdrawn into the zooecium by the contraction of retractor muscles attached to the tentacular crown. In the bryozoa with flexible zooecia the contraction of the body walls by parietal muscles produces protrusion of the polypide, but

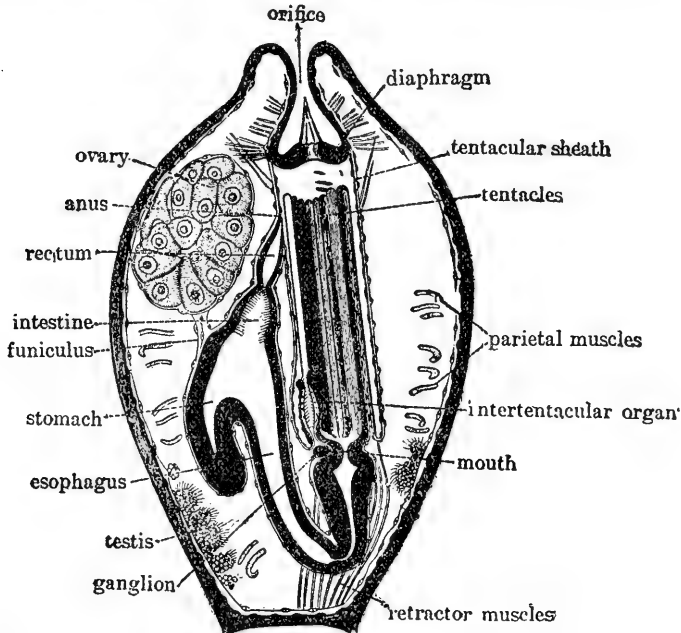

FIG. 1.—Anatomy of the polypide. Diagram showing the anatomy of a single zooecium of *Alcyonidium albidum* Alder, highly magnified, with its polypide retracted. (After Prouho.)

in the rigid calcareous zoaria the means for protrusion are more complicated as explained under the Cheilostomata.

The zooecium, the protective covering of the polypide, varies so much in structure that its description is reserved for the discussion of each order.

CLASSIFICATION.

The first serious attempt at a classification was made by D'Orbigny,¹ whose wide acquaintance with recent and fossil bryozoa has perhaps been equaled by no subsequent writer. But the system he devised was so largely artificial and burdened with so perplexing a

¹ 1850-1852. D'Orbigny. *Paléontologie française, Terrain Crétacé, Vol. V.*

nomenclature that it failed to gain acceptance. The labors of Nitsche, Allman, and Busk have fixed the principal groups. To Nitsche² is due the division into the two groups Ectoprocta and Entoprocta, the latter containing only a few, singular genera such as *Pedicellina* and *Loxosoma*. Allman³ formed the orders Phylactolaemata and Gymnolaemata, the latter including most of the bryozoa and all forms capable of preservation as fossils. Busk's suborders Cheilostomata, Cyclostomata, and Ctenostomata⁴ are now generally accepted as orders. To these Ulrich, in 1882,⁵ added the Trepostomata, to include, besides uncontested bryozoa, a number of forms which had been generally regarded as corals; and Vine, in 1883,⁶ added the Cryptostomata, which like the Trepostomata is known only from fossil forms.

The bryozoa and the brachiopoda are considered as constituting the phylum Molluscoidea, although some authors believe there is no relationship between them and regard the bryozoa as representing a distinct phylum. The two large subdivisions of the bryozoa, Ectoprocta and Entoprocta, based upon the position of the anus with reference to the tentacles, have been mentioned before. These subclasses differ widely from each other in many respects and here again some authors believe they are not even distantly related. However, the great majority of these animals belong to the Ectoprocta and under this to the superorder Gymnolaemata. Five orders of Gymnolaemata are known, of which the Cheilostomata is perhaps the largest in number of species. The relations of these various classificatory terms are expressed in the following table:

Phylum MOLLUSCOIDEA.

Class BRYOZOA.

Subclass ENTOPROCTA.

Row of tentacles circular, inclosing both the mouth and anal orifice.

Subclass ECTOPROCTA.

The tentacles surround the mouth only.

Superorder PHYLACTOLAEMATA.

Fresh-water Ectoprocta with the tentacles arranged in horseshoe shape and the mouth protected by an overhanging lip.

Superorder GYMNO LAEMATA.

Almost exclusively marine Ectoprocta with a circular row of tentacles surrounding the mouth, which is at their center.

² 1869. Nitsche. Beitschrift für wissenschaftliche Zoologie, Vol. XX.

³ 1856. Allman. Monograph of the Freshwater Polyzoa, p. 10.

⁴ 1852. Busk. British Museum Catalogue of Marine Polyzoa.

⁵ 1882. Ulrich. Journal Cincinnati Society Natural History, Vol. V, p. 151.

⁶ 1883. Vine. Report British Association Advancement Science, p. 196.

Order 1. CTENOSTOMATA.

Zooecia gelatinous or chitinous with toothlike processes resembling a comb closing the aperture when the tentacles are retracted. Range, Paleozoic to Recent.

Order 2. CYCLOSTOMATA.

Zooecia calcareous and tubular with a circular aperture. Range, Paleozoic to Recent.

Order 3. TREPOSTOMATA.

Zooecia calcareous and superposed upon each other so as to form long tubes intersected by straight or curved partitions, and showing an axial, immature zone and a peripheral, mature zone. Monticules or maculae of larger or smaller cells distributed on the surface at regular intervals. Range, Paleozoic only.

Order 4. CRYPTOSTOMATA.

Gymnolaemata differing from the Trepostomata in that the primitive part of the tube is usually much shorter and the passage to the mature region is more abrupt. Triparietal gemmation. Probably the Paleozoic representatives of the Cheilostomata.

Order 5. CHEILOSTOMATA.

Zooecia calcareous or chitinous with the aperture closed when the **polypide** is retracted, by a chitinous lip or operculum. Range, Mesozoic to Recent.

COLLECTION AND PREPARATION FOR STUDY.

In view of their abundance in the sedimentary rocks and in the recent seas, collecting specimens of bryozoa is a simple matter although certain features of it should be mentioned. With regard to the fossil forms, bryozoa are practically wanting in most sandstone strata, but beginning with the Ordovician there is scarcely a limestone formation, especially if it has shale alternations, in which they are not abundant. Generally the specimens are calcareous, and in this condition are easily sectioned for study under the microscope by the method mentioned later. Sometimes, however, they are found silicified and the internal structure is, to a certain extent, obliterated so that they can then rarely be successfully sectioned for study. Such specimens, however, frequently preserve the surface characters with great fidelity. In certain strata their substance has been dissolved away leaving a perfect mold in the matrix. A gutta-percha impression of this mold will often give a very satisfactory idea of the exterior of the original fossil.

The best specimens are usually obtained from the shales between or just above or below limestone layers. The smaller forms may be obtained free by carefully washing the shales and picking them out from the débris. Some kinds of shales or clay will wash away better if first allowed to become thoroughly dry. Others do better after thorough soaking in water.

Often the surface characters are obscured by the clayey matrix. This may be removed by the use of caustic potash (KOH in stick

form). The deliquescence of small pieces of this substance, which needs to be handled gingerly with unprotected hands, laid upon the fossil loosens the clay, which is then easily brushed off. Some workers accomplish the same result by placing their specimens in a saturated solution of Glauber's salts, which, in crystallizing, also loosens the clay. To prevent continued action of the small amount of caustic potash still remaining the specimen must be carefully neutralized by washing in water containing very dilute hydrochloric acid.

The Paleozoic species usually belong to the so-called stony bryozoa (pl. 1) in which the zoarial fragments are large enough to be readily visible to the collector. In weathered outcrops these fossils occur as twiglike fragments or lace-like fronds, often so numerous that they can be gathered in large quantities. The solid limestone, such as, for example, the well-known Tennessee marble, is often crowded with branching and rounded fragments of stony bryozoa, which can not be broken out of the rock without destroying the form of the zoarium. Fortunately these can be identified by thin sections just as readily as the free specimens.

Mesozoic and Cenozoic bryozoa occur in unconsolidated sediments more frequently than in the Paleozoic, so that free specimens are very easily obtained. However, although these bryozoans often occur literally by the millions in a stratum, they are usually so inconspicuous as to be unnoticed by the average collector. When these fossils are present, a careful examination of a weathered outcrop will almost invariably reveal a few minute twiglike stems or porous, flattened fragments projecting from the surface. Further search along the outcrop, especially along a seam in the rock, is very liable to result in the discovery of many such fragments (pl. 2).

As most of the post-Paleozoic bryozoa occur in soft limestone or marls, the collection of the material for study consists simply in scooping up a large amount of the loose rock containing these fragmentary remains. If the specimens are found in a hard, indurated rock it is usually only a matter of search to find a spot where the matrix has decomposed, leaving the soil filled with free specimens. In any case it is not advisable to pick up the specimens one by one, not only on account of loss of time but also of breakage. On arriving at the laboratory the clay or other rock holding the bryozoans should be allowed to soak in water for some hours. The material may then be agitated and the muddy water poured away. Continuing this process until the agitated water no longer becomes muddy, the residual mass is set aside to dry. The débris when dry is then ready for assorting, although passing it through several sieves of different mesh greatly facilitates the separation of the contained fossils.

When bryozoa are quite rare in any exposure it is well to do most of the sieving in the field, if possible. For example, the interesting

lowest Eocene fauna secured at Upper Marlboro, Maryland, was collected only after several days' active work of sieving the sand, and a small pill box was sufficient to hold the entire results.

In case these fossils can not be found in soft rock it is often still possible to obtain good specimens for study. A comparatively hard fossiliferous rock, when crushed in a sack with a wooden mallet, will often afford fairly well-preserved fossils after the débris has been washed and sieved as mentioned above. In such a case the bryozoans, although likely to be broken into smaller fragments than usual, are generally well enough preserved for accurate determination. If the rock is calcareous and too hard to yield to such treatment, thin sections may be employed to determine the bryozoa.

The separation into species of the fragmentary specimens resulting from the washings can be made with an ordinary hand lens, magnifying 8 or 10 diameters. The identification of these species can also be made under such a lens providing the species have already been well described and illustrated. In the identification and discovery of the characters of new species, however, a higher magnification is necessary.

Bryozoa in the recent seas are collected in quantity by dredging (pl. 2), although a thorough search of seaweeds and shells cast upon the beach or of piling and other structures exposed at low tide will reveal them in considerable numbers. A prolific source of bryozoa for the student is the common oyster and clam of Eastern markets. Many of the specimens secured in the above ways are dead, that is, they contain no living polypides. The study of such bryozoa follows the various methods indicated for the fossil forms. Specimens retaining the polypide may be preserved in alcohol or formaldehyde for an indefinite time before the structure of the animal itself is lost. After decalcifying and embedding in paraffin, thin sections of such specimens may be cut with the microtome as usual for tissues. If the removal of the animal matter is desired in order to study the zoecia unobscured, boiling in Javelle water as described below is necessary.

METHODS OF STUDY.

The relationship between the polypide or living animal and the zoecium or home which it secretes for itself, is such that the study of recent bryozoa embraces two distinct processes, first that dealing with the anatomy of the polypide itself interpreted by the usual histological methods, and second, the determination of the structures belonging to the zoecia. The first is a subject upon which much remains to be done and the attention of biologists is directed to it as a favorable field for research. The second will be discussed in some detail here because the classification of the bryozoa and the identifica-

tion of the fossil forms particularly, is based upon the zoecial structure.

On account of the compound calcareous colonies which many of the bryozoa build, thin sections are a necessity in the study of some of the orders, particularly the Trepostomata and Cryptostomata or fossil stony bryozoa. Again the zoaria of many of the Cyclostomata are so similar to those of the Trepostomata that thin sections are here again required, while even in the Cheilostomata they are frequently needed. The preparation of thin sections is described in a subsequent paragraph.

In the Cheilostomata the form of the chitinous appendages such as the operculum and the mandible of the avicularium is an essential feature, and hence the preparation of these structures for examination under the microscope as well as other preparations as described on p. 371, are necessary in detailed study.

Javelle water.—The various zoecial structures in the recent bryozoa are sometimes obscured by the ectocyst, the chitinous membrane covering the zoarium and by remains of the animal tissue. These are removed by boiling in Javelle water,⁷ whereupon the specimen assumes the aspect of the fossil forms in which naturally all of the chitinous and fleshy parts of the organism have disappeared.

Ammonium-chloride process.—The zoaria of many recent bryozoa are so semitransparent or glasslike that the various zoecial structures can be observed only with difficulty. However, they may be brought out in great perfection and clearness by whitening the surface with ammonium chloride. A simple apparatus for this purpose is illustrated in figure 2. By blowing through the mouthpiece, M, the fumes of hydrochloric acid (HCl) and ammonia (NH₃OH) will unite at the outlets of the tubes, O, and form a white sublimate of ammonium chloride upon any object held at this point. This sublimate can be deposited upon the object in such a uniform, thin film, varying in color according to its thickness, from a light blue to an ivory white, that all the details of structure are reproduced perfectly and can be viewed under the microscope without exhibiting any crystalline structure of the ammonium chloride. By this process the minute sculpturing or structures scarcely visible on the corneous or transparent calcareous colony are brought out in clear relief. While this whitening process is a great aid in the preliminary study it is almost indispensable in the illustration of recent bryozoa by photography. Fossil bryozoa also lend themselves admirably to this process of study and illustration. It may be remarked that the am-

⁷ Javelle water can usually be obtained from any druggist, but it is easily prepared by dissolving 1 pound of washing soda in 1 quart of cold water and adding to this one-quarter pound of ordinary bleaching powder (calcium hypochlorite). After filtering, the solution should be kept in a tightly closed bottle.

monium-chloride deposit can be removed by simply blowing the breath upon the object so coated. The hydrochloric acid and ammonia used should be of great strength to secure the best results. Small quantities only should be employed so that the bottles can be emptied and dried frequently, as the reagents not only absorb moisture but lose their strength in a day or two of use.

Thin sections.—The preparation of satisfactory sections is not difficult but some experience and care are required to produce uniformly good results. Without a machine for cutting rock sections the following method gives excellent results. The materials required are, first, a piece of sandstone 8 or 10 inches wide, several inches thick,

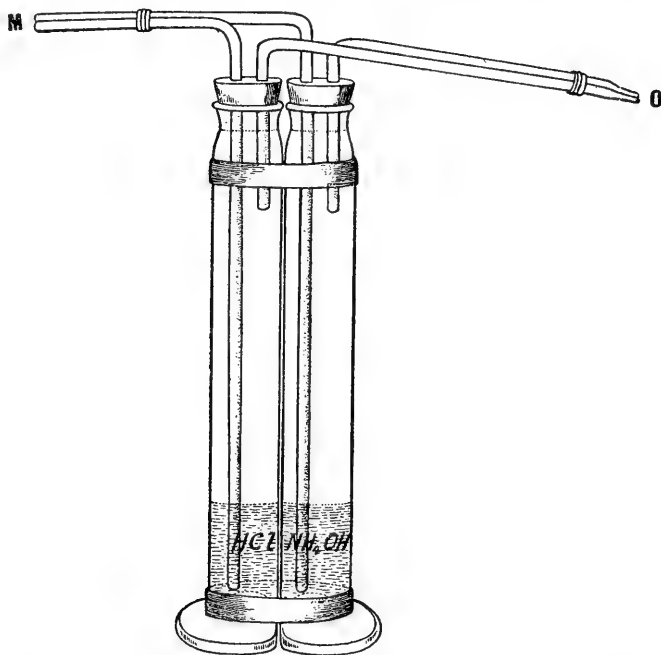

FIG. 2.—Apparatus for preparation of ammonium chloride sublimate.

and 18 or 20 inches long; second, a water hone an inch thick and 4 or 5 inches long; and third, a block of wood 2 inches wide, 4 or 5 inches long, and an inch thick. In place of the sandstone a carborundum slab about an inch thick, 8 inches wide and 18 inches long, to be obtained from the Carborundum Co., at Niagara Falls, is very durable and more efficient. The wooden block should have its upper edges rounded to fit the hand, while on the lower side an excavation should be made of a size to fit the ordinary glass slip. A carborundum hone of considerable fineness is also quite useful.

The procedure for sectioning specimens large enough to be handled without difficulty is as follows: With a pair of wire nippers a frag-

ment is pinched from the specimen and is rubbed upon the sandstone until the surface of which a section is desired is perfectly flat. This surface is then smoothed upon the hone, after which it is cemented upon a glass slip with Canada balsam. The heating of the glass slip to harden the Canada balsam is the most important part of the process, for if the balsam be allowed to boil too long on the heating stage or over a lamp it will be brittle when cold and the fragment will spring off; if too short a time, the section when thin will granulate. After heating and subsequent cooling, the balsam should be tested for hardness, the correct degree being intermediate between brittleness and the point where the finger nail can make an impression upon it. If too soft, the slip must be reheated; but if too hard, it is better to remove the fragment, clean it by smoothing it off on the hone, and then reheating again. When of the proper hardness, the glass slip is then placed in the excavation of the wooden block, which is dipped into water to secure adhesion. Then after rubbing away upon the sandstone or carborundum slab all of the superfluous material until the section is quite thin, the slide is removed from the block and the thinning of the section is completed upon the hone.

In this process the glass slip becomes scratched and unsightly, so for a permanent mount the entire slip should either be ground down to give the ground-glass effect or, better still, the thin section should be transferred to a clean slip and covered in the usual way for permanent preservation. The transfer is accomplished by first cleaning off all old gum around the section with alcohol, then adding a drop of fresh gum, heating, and when the thin section has become loosened sliding it onto a clean glass slip with a sharp-pointed instrument.

Specimens too small to be cut with the wire nippers are sectioned by placing them on a slide in balsam which has been only partially hardened by heating. They may then be rubbed down until the required surface of the section is reached. The balsam is then melted and the specimens are turned over with a sharp-pointed instrument. After cooling, the thin sections are made in the manner described above.

Although this method of sectioning applies particularly to the Trepostomata, it is employed to advantage in species of the other orders where the zoarium is a solid mass composed of numerous tubes. In all cases these sections must be prepared to show the peculiar structural features of the bryozoa, particularly the inner immature zone and the outer peripheral area, where the zooecia are in the mature state and develop accessory features, such as acanthopores, mesopores, diaphragms, etc. To observe these features two sections are always needed, a vertical section parallel with the axis of growth of the tube and a tangential section parallel to the surface and close enough to it to show the structure of the mature zooecia.

Various other preparations necessary in the study of certain groups of bryozoa are described under the discussion of these groups.

In the study of the bryozoa two bibliographies are useful, one by Miss Jelly on the recent species⁸ and the second by Nickles and Bassler,⁹ which, in addition to the citations of all North American fossil species, includes a complete list of the literature up to the date of publication, classified in various ways for easy reference.

TYPES OF BRYOZOA.

The zoecial structural features and methods of study of the bryozoa differ so decidedly for the various divisions that it is preferable to consider each one separately.

Subclass ENTOPROCTA.

Of the two very unequal major divisions of the bryozoa, the Entoprocta, characterized, as indicated in the name (*endon*=within, *proktos*=anus), by the position of the anal opening within the row of tentacles, is especially interesting in that the comparatively few species classified here probably represent the most primitive expression of the class. In this subclass the tentacles during retraction of the polypide are infolded into a vestibule which can be closed by a sphincter. Definite excretory organs are present as are also reproductive organs which have ducts leading to the vestibule. The different zooids or individuals formed by budding, are further marked by their isolation from each other. In this respect the subclass differs from almost all other bryozoa, as the rule is for adjacent zoecia to be in contact. In *Loxosoma*, a typical entoproctous genus, colonies even are not formed as each zooid leads an independent existence.

As shown in figure 3, these bryozoa grow from a thread-like stolon emitting cylindrical stalks each of which expands into the body of a zooid. The calyxlike zooids are lost from time to time and then the end of the stalk generates another polypide bud which matures into a new calyx. In no case is the body wall calcified so that the Entoprocta is not represented in the fossil state.

Loxosoma and *Pedicellina* represented in figure 3, and *Urnatella* are the best known genera. *Urnatella* is a beautiful form found at present only in fresh water in the United States. In this genus the calyx surmounts a segmented stalk and the stalks arise quite regularly in pairs from a common base. For a more detailed account of the Entoprocta the reader is referred to Ehler's work of 1890.¹⁰

⁸ 1889. Jelly, E. C. Synonymic Catalogue of Recent Marine Bryozoa.

⁹ 1900. Nickles and Bassler. Synopsis of American fossil bryozoa, Bul. 173, U. S. Geol. Surv.

¹⁰ 1890. Ehlers, Zur Kenntniss der Pedicellineen. Abhandlungen der physical. Klasse der Königlichen Gesellschaft der Wissenschaften zu Göttingen, XXXVI, pp. 1-200, pls. 1-5.

Subclass ECTOPROCTA.

Almost all of the known bryozoa, both fossil and recent, belong to the Ectoprocta (*ektos*=without, *proktos*=anus), characterized by the position of the anus without the row of tentacles surrounding the mouth. Here again two very unequal divisions have been instituted, the Phylactolaemata with a horseshoe-shaped lophophore, represented by a few species, and the Gymnolaemata, with a circular lophophore, comprising practically all the fossil forms and the great

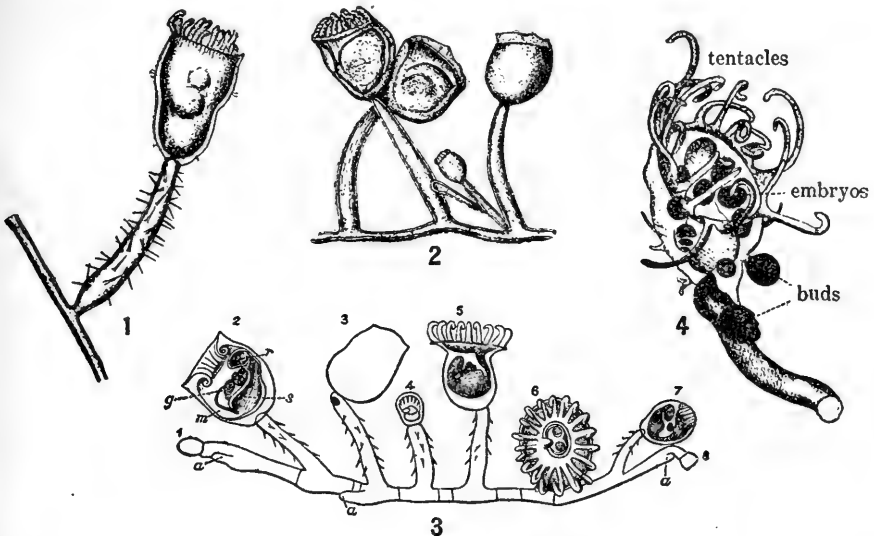

FIG. 3.—Structure of the Entoprocta. 1-3, *Pedicellina cernua* Pallas. Atlantic off England. 1. Polypide borne on a flexuous stolon showing a spinose peduncle, $\times 36$. 2. Several polypides in various stages of growth, $\times 20$. (After Hincks.) 3. An entire colony, $\times 22$, exhibiting three growing ends (*a*); zooids 1 and 8 are quite immature; 7 (tentacles retracted) is still young; 2 is seen in longitudinal section; *g*, generative organ, and below it the ganglion; *m*, mouth; *r*, rectum; *s*, stomach; between *g* and *r* are three embryos in the brood-pouch; the tentacles are retracted; in 5 and 6 the tentacles are expanded; in 6 two embryos are seen within the circle of the tentacles; to the left of them is the rectum, and to the right the mouth; 3 is in the act of losing its calyx, and has already developed the beginning of a new polypide-bud; in 4 the primary calyx has been lost, and the new calyx is clearly marked off from the stalk. 4. *Loxosoma cirriferum* Harmer, an entoproctous bryozoan from the East Indies. A female polypide magnified, showing the circle of tentacles with several embryos within them and buds in various stages of development. (After Harmer.)

majority of living species. Unlike the Entoprocta, the reproductive organs are developed in the body cavity and have no ducts leading into the vestibule, while specific excretory organs are absent.

Superorder PHYLACTOLAEMATA.

The bryozoa of this superorder have the tentacles arranged in a horseshoe shape about the mouth, which is protected by an overhanging lip. They are fresh water in their habitat and have special peculiarities which allow them to live under conditions where the

change of temperature and the danger of drying up is ever present. Their special characteristic is the habit of dying down in the winter with the formation of the so-called statoblasts, hard-shelled reproductive bodies consisting of internal buds protected by a chitinous shell capable of resisting unfavorable conditions for a period and then forming new zooids. Sexual reproduction also occurs as in other bryozoa. The Phylactolaemata have a body structure somewhat similar to the Ctenostomata, the first order of the Gymnolaemata, which also show a tendency to live in fresh water, and from which these exclusively fresh-water bryozoa are believed to have been derived. They are often quite common in a zone of water about 2 feet below the surface, where their colonies are found attached to water plants or stones. A few forms are found in running water but most of them occur in still water.

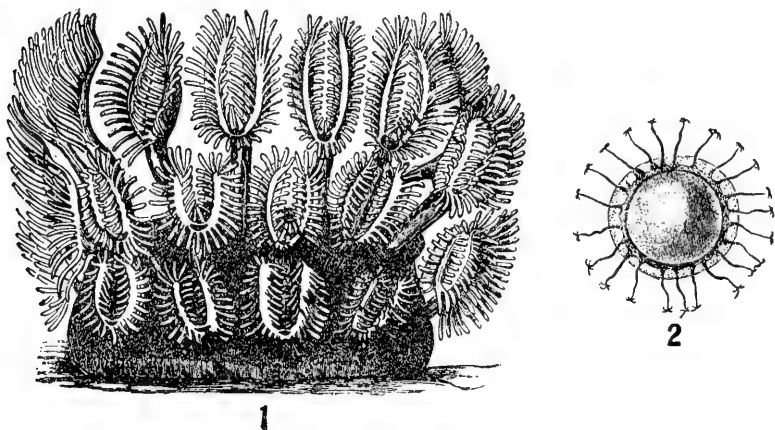

FIG. 4.—*Cristatella mucedo* Cuvier, a fresh-water bryozoan from England, $\times 24$, a typical member of the Phylactolaemata, showing slug-shaped body and the horseshoe-shaped lophophore (1); a statoblast (2) of the same species, $\times 28$.

The zoarium may consist of gelatinous masses of varying size, of aggregations of parallel tubes or of single branching tubes, in all of which cases the body cavities of the zooids are continuous with each other. The body cavity in the Phylactolaemata is thus a continuous space, while in the Gymnolaemata each zooid has its own body wall. As in the Entoprocta, the body wall is uncalcified, and fossil forms are not to be expected. Protrusion of the polypide is effected by the contraction of the muscular body wall compressing the fluid of the body cavity. The tentacles sometimes interlace to form a sort of cage in which infusoria used for food are imprisoned.

Cristatella (text fig. 4), a typical member of the superorder, consists of a slug-shaped gelatinous mass, sometimes eight inches long but only one-half inch wide with a flattened sole on which it has the power of crawling. The protruding polypides form a delicate fringe

along the upper side while around the edge of the mass a zone of budding tissue gives rise to new zooids. *Fredericella*, another typical genus, is a member of the deep-water fauna of the Swiss Lakes. *Plumatella* forms aggregations of parallel tubes. *Lophopus* and *Pectinatella*, like *Cristatella*, show powers of locomotion. These genera have a wide geographical distribution, probably due to their reproduction by statoblasts. They have been recovered from Europe, North and South America, Africa, Australia, and other widely separated areas.

Although the species of Phylactolaemata are comparatively few, they give rise to such interesting phenomena that the literature on these fresh-water bryozoa is quite extensive. The monographs of Allman¹¹ and of Jullien¹² should be consulted for a general review.

Superorder GYMNOLAEMATA.

As mentioned before, this superorder, characterized by the circular row of tentacles surrounding the mouth only, is almost exclusively marine and comprises most of the known recent bryozoa and practically all of the fossil forms. The body cavities are not continuous with one another nor is the body wall muscular as in the Phylactolaemata. In the majority of species, calcareous zooecial walls are deposited and form very interesting objects of study.

ORDER 1. CTENOSTOMATA.

In this order the zooecia, which are frequently isolated, are developed by budding from the internodes of a distinct tubular stolon or stem, thus resembling to this extent the Entoprocta. Again they unite laterally to form sheets, but in both cases the zooecial walls are usually quite soft and uncalcified. The stolon is often threadlike and gives off cylindrical stalks, each of which dilates at its end into the body of the zooid. The zooecial orifice is terminal and is closed during retraction by an operculum of setae, which on account of its resemblance to a comb, gives the name to the order (*ctenos*, comb). All appendicular organs, such as avicularia, ovicells, and vibracula, are wanting. In all the known forms the zooecia are membraneous, and little capable of preservation. In some cases, fortunately, the stolon becomes partially calcified and may thus be preserved fossil, although all traces of the zooecium itself are lost. Then, again, many of the Ctenostomata have the power of excavating a place for themselves in the substance of the host they incrust, so that the size

¹¹ 1856. Allman, G. J. A monograph of the fresh-water Polyzoa, including all the known species, both British and foreign. London, viii + 119 pp. 11 pls.

¹² 1885. Jullien. Monographie des Bryozoaires d'eau douce. Bulletin de la Société Zoologique de France, X, pp. 91-207, 250 figs.

and shape of such excavations serve very well for the identification of many fossil species.

All of the known Paleozoic Ctenostomata have been described by Ulrich and Bassler¹³ in their Revision of the Paleozoic Bryozoa, to which the student is referred for a discussion of these peculiar fossils which had formerly been regarded as trilobite eggs, sponge borings, or foraminifera. Mesozoic and Cenozoic ctenostomatous bryozoa are apparently rare, and little study has been put upon them. In the recent seas, the order is specifically the least represented of

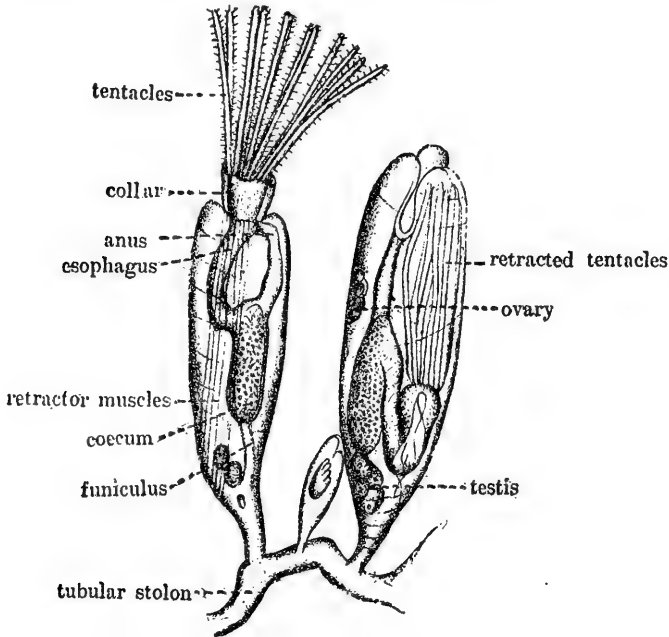

FIG. 5.—Structure of the Ctenostomata. Three polypides of *Farrella repens* Farre, rising from a stolon, one with expanded tentacles, another with tentacles retracted, and the third in the young stage, highly magnified. Eastern Atlantic. (After Van Beneden.)

the bryozoa, although some of the species are quite abundant in individuals and widespread. Hincks's¹⁴ memoir of 1880 on British species and Harmer's¹⁵ work on the East Indian forms published in 1915 will give the student a good idea of the recent Ctenostomata. The latter publication includes a good account of the methods of study necessary in this order.

In figure 5 the anatomy of an animal of a recent ctenostomatous bryozoan is illustrated, and its similarity to that in the other orders

¹³ 1904. Ulrich and Bassler. Revision of the Paleozoic Bryozoa. Part 1, Ctenostomata. Smithsonian Misc. Coll., vol. 45, pp. 256-294.

¹⁴ 1880. Hincks. British Marine Polyzoa, pp. 488-582.

¹⁵ 1915. Harmer. Polyzoa of the Siboga Expedition, pt. 1, pp. 36-92.

is evident. Figure 6 gives a résumé of the important types of both fossil and recent Ctenostomata. The pinnately arranged stolons of *Rhopalonaria* usually represented by excavations in shells or corals are perhaps the commonest of Paleozoic forms, although the chain-like *Allonema* and the radially arranged bulbs of *Ascodictyon* are occasionally found. The threadlike species are interesting in that the oldest known bryozoan *Heteronema priscum* from the Lowest Ordovician rocks of Esthonia is apparently of this type. In the Mesozoic and Cenozoic eras few Ctenostomata have been found, and all of these show great similarity to the Paleozoic *Rhopalonaria*. However, as only their excavations are usually known, it is probable that the structure of the zooecia was quite different.

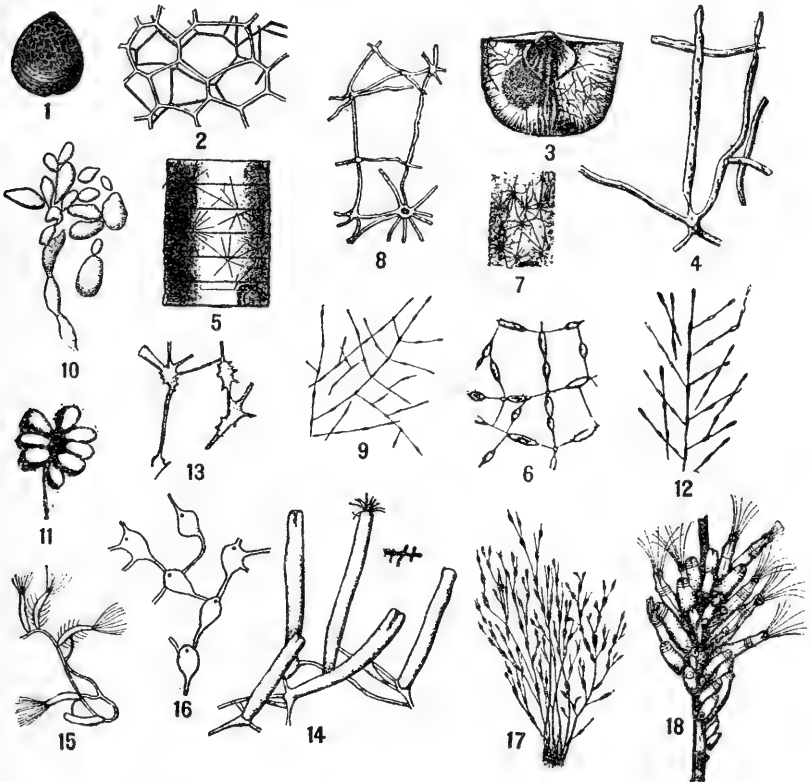

FIG. 6.—Fossil and recent Ctenostomata.

- 1-2. *Heteronema priscum* Bassler. The oldest known bryozoan, a ctenostome from the lowest Ordovician (Ugulite sandstone) of Esthonia; (1) a colony attached to a brachiopod shell, $\times 3$; (2) parts of two colonies, $\times 22$, with one growing over the other.
- 3-4. *Vinella repens* Ulrich, Middle Ordovician shale of Minnesota; (3) two colonies attached to a brachiopod shell, $\frac{2}{3}$ natural size; (4) portion of a zoarium, $\times 12$, showing a nucleus with five divisions of the tubular stolon radiating from it. The pores mark the points where the zooecia were attached.
5. *Vinella radialis* Ulrich. Upper Ordovician, Cincinnati, Ohio. Four colonies attached to a cephalopod shell, two-thirds natural size.

6. *Rhopalonaria venosa* Ulrich. Early Silurian of Southwestern Ohio. Portions of the encrusting colony, $\times 12$.
- 7-8. *Vincella radiceiformis conferta* Ulrich from the Silurian (Waldron) shales of Indiana; (7) the encrusting colony, $\times 3$, showing the close development of the nuclei; (8) nuclei and their connecting stolons, $\times 12$.
9. *Rhopalonaria attenuata* Ulrich and Bassler, $\times 6$, Silurian (Rochester) shales of New York. This characteristic Silurian species occurs as an excavated mold on shells and other fossils.
10. *Allonema fusiformis* Nicholson and Etheridge, jr. Middle Devonian shale of Michigan. Portion of the encrusting colony, $\times 6$, composed of numerous vesicles.
11. *Ascodiotyon stellatum* Nicholson and Etheridge, jr. Middle Devonian shales of Western New York. A cluster, $\times 12$, composed of vesicles one of which shows the punctate structure.
12. The excavation on the surface of a shell left by a species of *Terebripora*, $\times 10$, from the Miocene rocks of North Carolina.
- 13-14. *Cylindroecium dilatatum* Hincks. (13) Incrusting basal part of this recent species, $\times 12$, showing spinose dilatations at the base of the zooecia; (14) the erect zooecia, $\times 12$, attached to the tubular basal expansion.
15. *Avcnella fusca* Dalyell, a living species, $\times 10$, illustrating the tubular stolons with the erect zooecia.
16. *Arachnidium hippothoides* Hincks. Part of the encrusting network of zooecia, $\times 10$, connected by slender fibers.
- 17-18. *Bowerbankia pustulosa* Ellis and Solander. (17) The erect zoarium, two-thirds natural size, showing the group of polypides at regular intervals; (18) a group, $\times 10$, with the polypides expanded. (Figs. 13-18, after Hincks.)

Among the living Ctenostomata *Aleyonidium* and related genera grow into soft incrustations or into masses 6 inches or more high in which the zooecia are closely united. In *Bowerbankia* the erect branching zoarium bears tufts of zooecia at regular intervals, while in *Amathia* an interesting spiral arrangement of the branches occurs. The Ctenostomata are typically marine, but a few genera have a tendency to live in estuaries. For this reason and other characteristics they are believed to have given origin to the exclusively freshwater Phylactolaemata.

ORDER 2. CYCLOSTOMATA.

The zooecia in this order are simple calcareous tubes, usually without transverse partitions, with a plain, rounded, uncontracted orifice not closed by an operculum. The walls are thin and minutely porous and do not show the complicated structures visible in the Cheilostomata or Trepostomata. The ovicell, when present, is an enlarged zooecium or an inflation of the zoarial surface. The zoarium assumes very many different forms of growth (pl. 3), although the method of growth is quite constant for a species.

Hitherto the families and genera of Cyclostomata have been founded almost entirely upon the form of the zoarium and the arrangement of the zooecia. As a result, very complicated artificial classifications have been proposed, which the reader may consult in the review given by Gregory in 1909.¹⁶

¹⁶ 1909. Gregory. Catalogue of Fossil Bryozoa in Department of Geology, British Museum, Cretaceous, vol. 2, pp. xxiv-xli.

The distinction between the families of Cyclostomata, like other orders of bryozoa, is or should be based on their larval forms, each family being characterized by a special larva. The larvae of the Cyclostomata are very similar to each other and difficult to discriminate, but fortunately they show their differences by the evolution of the embryos in ovicells of very different size, form, and position. The first tube of a zoarium is the ancestrula, and its lower part (pl. 4, fig. 1) is a dilated blisterlike form called the protoecium. It is in the protoecium that the histolysis of the fixed larva and its replacement by the first normal polypide living in the ancestrula occurs.

Without doubt the same principles of classification applied to the apparently more complicated Cheilostomata, as described on a later page, should be employed in the study of the Cyclostomata; indeed, a natural classification can be built up only by a study of the physiologic functions of the organs. In the Cheilostomata it will be noted that the form of the aperture and of the operculum, the presence of cardelles, and the modifications of the ovicell are the essential characters of generic and family classification. In the Cyclostomata the aperture is always more or less circular, the operculum and cardelles are wanting, leaving the ovicell as the single remaining essential character showing on the zoecia.

The value of the ovicell in the classification of the Cyclostomata is therefore of utmost importance, but unfortunately its study has been much neglected. Some species of Cyclostomata possibly did not develop ovicells, but the majority of them will after some search undoubtedly reveal specimens showing this organ. Indeed, one of the most interesting features in the study of the Cyclostomata is the search for ovicelled specimens among the many described species where now no ovicell is known. A beginning toward a natural classification of the Cyclostomata was made by Canu several years ago, and Canu and Bassler in 1920¹⁷ have amplified this subject. The student is referred to their work for more details and references to other researches upon the Cyclostomata. Some of the more common types of ovicell are figured on plate 4.

In spite of their general simplicity the Cyclostomata exhibit other features which can be used in connection with the ovicell in classification. For example, in many Cyclostomata there are accessory tubes developed either on the frontal or the dorsal side of the zoarium. These are zoecia, closed or open, which appear to be without a polypide. Thin sections of the zoarium are frequently necessary to determine the nature of such accessory tubes. The

¹⁷ 1920. Canu and Bassler. North American Early Tertiary Bryozoa. Bulletin 106, U. S. National Museum.

dorsal side of many branching forms is sometimes occupied by short tubes called *nematopores*, which appear at the surface as thread-like and in thin sections as narrow tubes upwardly directed. Somewhat similar tubes on the dorsal side grow in the opposite direction—that is, toward the zoarial base. These are the *firmatopores*. Certain Cyclostomata exhibit pores on the dorsal side as large as the polypide tubes, but with polygonal orifice. These are termed "*tergopores*." Somewhat similar pores on the frontal side, but covered by calcareous closures, are known as *dactylethrae*, while *cancelli*, another curious development on the frontal side, are cylindrical tubes closed by a finely perforated lamella and garnished in the interior with numerous spinules. Still other forms of tubes in this order are the ramifications of the polypidian tubes, termed "*vacuoles*" and "*mesopores*." The physiologic function of these various accessory tubes is still unknown, but they are constant in their development and are therefore of value in classification. Plate 4 exhibits the aspect of these various tubes both at the surface and in thin sections.

The method of division or gemmation of the zoecial tubes in the Cyclostomata is also quite important. In one method (peripheral) the tubes bifurcate at all heights and in all directions. In another method (oriented) gemmation occurs in a definite manner on a single or on two sides of a basal lamella or of an axial zone. Thin sections here again are indispensable in the study of this order.

Although many researches upon the Cyclostomata have been published, comparatively little attention has been devoted to the anatomy of the polypide, the study of its method of protrusion, and to the larval forms in addition to the ovicell. So far as known the ovicells contain numerous embryos, which have arisen by fission of a primary embryo developed from an egg.

The Cyclostomata commence in the Middle Ordovician and continue until the end of the Paleozoic era fairly well developed in number but of less importance than the two strictly Paleozoic orders, Trepostomata and Cryptostomata. In the Early and Middle Mesozoic they constitute the predominating order, but in the Cretaceous the Cheilostomata assume first place and continue so until the present. The Paleozoic forms have been described by Ulrich and other workers mentioned under the Trepostomata. The Mesozoic species have been the subject of numerous publications among which may be mentioned those by Gregory¹⁸ and by D'Orbigny.¹⁹ The Cenozoic Cyclostomata likewise have received much attention, as will be noted by consulting the monograph by Canu and Bass-

¹⁸ Gregory. Catalogue of Fossil Bryozoa in British Museum, Jurassic (1896), Cretaceous vol. 1, 1899, and Cretaceous vol. 2, 1909.

¹⁹ 1852. D'Orbigny. Paléontologie française, Terrain Crétacé, Vol. V.

ler of 1920. Hincks' British Marine Polyzoa (1880), Busk's Catalogue of Cyclostomatous Polyzoa in the British Museum (1875), and his Challenger Expedition Report (1886) as well as numerous papers by Waters, Smitt, Harmer, Canu, and other authors treat of the recent Cyclostomata.

The study of many Cyclostomata particularly those forming solid calcareous zoaria requires thin sections. The preparation of such sections is discussed in this article under methods of study.

In addition to the ovicells and other features just mentioned, the size of the orifices and the distances between them are important in specific identifications. Probably the simplest and most trustworthy method of identifying closely allied species is by the preparation of uniformly magnified photographs of the zoarial surface. The magnification of 12 and 25 diameters for the Cyclostomata has been found most useful and is recommended for comparative purposes.

ORDER 3. TREPOSTOMATA.

This order is limited to the Paleozoic era when it flourished in a wealth of species forming stony colonies which contributed largely to the formation of many limestone strata. These colonies were always calcareous and consist of masses, sometimes of considerable size, composed of long coherent, prismatic, or cylindrical tubes with terminal orifice. Each tube is composed of an inner or axial region with thin walls and an outer, peripheral zone with thicker walls and complicated structure. This change in the character of the tubes which gives the name to the order (*trepos*, change) is accompanied by the development of other features, namely, mesopores, acanthopores, more numerous diaphragms and similar structures of the more mature zooid.

The Trepostomata include the greater portion of the so-called Monticuliporoids which for a long time were regarded as corals, although their bryozoan nature was long insisted upon by Ulrich who published many proofs of their affinities to undoubted bryozoa. This relationship has been strengthened by the discovery by Cumings that the budding plan of certain Ordovician genera is precisely the same as in typical recent bryozoa, namely, that it consists of (1) a protoecium or minute circular disk, (2) the ancestrula, a tubular zoecium of the type seen in the Cyclostomata, and (3) several primary buds arising from and adjacent to the ancestrula. These primitive structures are separated from the rest of the colony by a considerable thickening of their posterior walls. In the corals, development from the larva is direct the moment it becomes sedentary and therefore the presence of the protoecium alone is practically conclusive as to the systematic position of the Trepostomata with the bryozoa.

Some of the Trepostomata are incrusting and consist of one or more superimposed layers, but most of them either rise into fronds and bifoliate expansions or form hemispherical to rounded masses of a size ranging as high as 2 feet in diameter. Such massive types of zoaria arise from the fact that the zooecia in the Trepostomata are directly superimposed upon one another to form the long tubes which by continued budding result in the branching or massive stony zoaria. These tubes are intersected by straight partitions (diaphragms) or curved ones (cystiphragms), which represent the covers and floors of successive layers. The diaphragms may be incomplete or provided with a central perforation. As a rule, they are few or wanting in the immature zone of the zooecia, but are more numerous in the outer or mature zone, where also the zooecia are often separated by more or less closely tabulated porelike spaces called mesopores. Zooecial covers with a small subcentral orifice may occur.

One characteristic of the Trepostomata, which, however, the order shares with the Cryptostomata, is the presence at regular intervals over the surface of elevated groups containing cells differing from the average in size (monticules) or spot-like areas (maculae) of such cells on a level with the zoarial surface or depressed below it. The size, shape, elevation, and distance apart of the maculae or monticules are usually specific characters. The monticules may vary from small sharp tubercles through rounded nodes to elevated rings completely encircling the zoarium while the maculae, although often inconspicuous spots on the surface, are sometimes quite distinct solid depressed areas or, as in one family, beautiful star-shaped regions.

The spine-like projections on the zooecial walls called acanthopores are found in thin sections to consist of minute tubes included in the wall substance, but with a definite structure of their own. These acanthopores traverse the mature region and undoubtedly represent structures with some definite function possibly like the avicularia or vibracular pores of the Cheilostomata.

For many years the identification of the Trepostomata was based upon external features such as the form of the zoarium, the shape of the zooecia, and such surface characters as the tubercles or maculae. This led to so much confusion that the order deservedly was not considered of much use in the identification of stratigraphic horizons. The internal structure of these stony forms gives the true specific characters, and so the preparation of thin sections for examination under the microscope has become indispensable in their study. However, when once a species has been thoroughly worked out it can generally be distinguished externally from associated forms of similar appearance by quite constant differences which often seem trifling and yet are doubtless of morphological importance. Even

the internal structure can be determined without the preparation of actual thin sections, for by smoothing the surface of the bryozoan and etching it slightly with acid most of the characters seen in tangential sections become visible. A similar procedure for the vertical section exhibits the internal characters very well. The aspect of the surface and the structure seen in thin sections of a few species of Trepostomata are illustrated in text figure 7. An outline of the

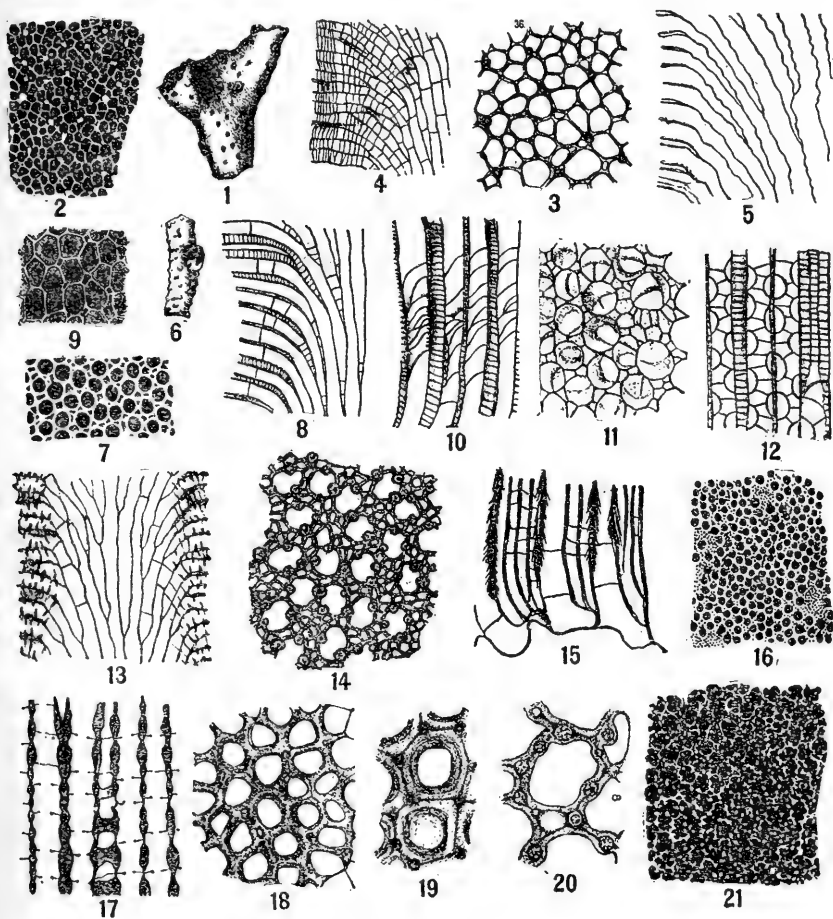

FIG. 7.—Structure of the Trepostomata.

- 1-4. Views of *Dekayella praeunantia* Ulrich, a common Middle Ordovician bryozoan, showing (1) the solid stony branch, \times two-thirds; (2) surface of the same, \times 6, with the spinelike acanthopores and thin zooecial walls; (3) a tangential section, \times 12, illustrating the same features in thin sections, and (4) a vertical section, \times 6, with few diaphragms in the immature zone to the right and numerous ones in the mature zone.
5. Longitudinal thin section \times 12, of an Ordovician species (*Halloporena crenulata* Ulrich) with crenulated zooecial tubes in which diaphragms are absent in both the mature and immature zones.
- 6-8. Views of an Ordovician species (*Halloporena pulchella* Ulrich) illustrating (6) a fragment, \times two-thirds, with tubercles developed at regular intervals on the surface; (7) the surface, \times 12, showing the zooecia and the intervening mesopores and (8) vertical section, \times 12, with numerous tabulae in the mesopores.

9. Surface of *Hallopora multitabulata* Ulrich, $\times 12$, showing ornamented zoecial closures.
10. Vertical section, $\times 12$, of a discoid bryozoan (*Mesotrypa infida* Ulrich) from the Middle Ordovician shales of Minnesota, showing curved diaphragms in the zoecia and closely tabulated mesopores.
- 11-12. Internal structure of *Prasopora selwyni* Nicholson, a small hemispherical Ordovician bryozoan; 11, a tangential section, $\times 12$, exhibiting the zoecia and numerous mesopores; 12, a vertical section, $\times 12$, showing the isolation and semicircular form of the cystiphragms, the diaphragms, and the close tabulation of the mesopores.
13. Vertical section, $\times 6$, of *Hemiphragma irrasum* Ulrich from the Middle Ordovician shales of Minnesota, a solid branching bryozoan characterized by the occurrence of semidiaphragms in the mature region.
14. Structure of a thin laminar bryozoan (*Lioctema foliatum* Ulrich) from the Lower Carboniferous (Warsaw limestone) of Illinois; 14, tangential section, $\times 18$, exhibiting numerous mesopores and the zoecia indented by large acanthopores; 15, vertical section, $\times 18$, through the zoarium, showing a very short immature region and a development of numerous mesopores and strong acanthopores in the mature zone.
16. Surface, $\times 12$, of a ramose species (*Halloporina crenulata* Ulrich) from the Middle Ordovician shales of Minnesota, illustrating the occurrence at regular intervals of the clusters of mesopores termed maculae.
- 17-18. Thin sections of *Stenopora*, a typical Upper Paleozoic genus of the Trepostomata; 17, vertical section, $\times 12$, through the mature region of *S. americana* Ulrich, from the Mississippian (Keokuk limestone) of Illinois. The beading of the walls and the occurrence of perforated diaphragms are characteristic features; 18, tangential section, $\times 12$, showing wall structure.
- 19, 20. Two zoecia of *Batostoma winohelli* Ulrich, from Middle Ordovician shales of Minnesota, $\times 30$, as seen in tangential sections (19); and a variety of the same species, $\times 30$, in which the acanthopores are strongly developed and thin structure is apparent (20).
21. Surface, $\times 12$, of an incrusting bryozoan (*Atactoperella typicalis praecipita* Ulrich) from the Middle Ordovician shales of Minnesota, with a floriform aspect due to the indentation of the zoecial cavities by numerous acanthopores.

detailed classification of the Trepostomata may be found in the Eastman edition of Zittel's Textbook of Paleontology, while most of the genera and many species of the order are described and illustrated by Nicholson,²⁰ Ulrich,²¹ Ulrich and Bassler,²² Cumings,²³ and Bassler.²⁴

Ulrich and Bassler, in their Revision of the Paleozoic Bryozoa, 1904, proposed two divisions of the Trepostomata based upon the minute structure of the walls separating adjoining zooids. Of the seven families now recognized under the Trepostomata, four have the calcareous investment of adjoining zoecia amalgamated together so that one wall can not be distinguished from its neighbor. In the remaining three families the walls retain their duplex character, and when the zoecia are adjacent their boundaries are marked by a dark, divisional line. This line in all probability rep-

²⁰ 1881. Nicholson, H. A. The Genus Monticulpora.

²¹ 1882-1884. Ulrich, E. O. American Paleozoic Bryozoa, Journal Cincinnati Society of Natural History, vols. 5-7. 1890. Ulrich, E. O. Paleozoic Bryozoa, Geological Survey, Illinois, vol. 8. 1893. Ulrich, E. O. Lower Silurian Bryozoa, Geological Survey of Minnesota, Final Report, vol. 3, pt. 1.

²² 1904. Ulrich, E. O., and Bassler, R. S. Revision of the Paleozoic Bryozoa. Trepostomata. Smithsonian Miscellaneous Collections, vol. 47, pp. 15-55.

²³ 1908. Cumings, E. R. The Stratigraphy and Paleontology of the Ordovician Rocks of Indiana. Thirty-second Annual Report, Department of Geology and Natural Resources of Indiana, pp. 605-1190.

²⁴ 1911. Bassler, R. S. Early Paleozoic Bryozoa of the Baltic Provinces. Bull. 77, U. S. National Museum.

resents the fossilized remains of animal matter which filled this space during the life of the organism. Occasionally this narrow intervening area is occupied by a light-colored tissue, and in this case the outer boundaries of the wall of each zoecium can be seen. In certain genera of both divisions the amalgamation or the distinct character of the walls is difficult to determine, especially when mosopores are numerous, but if the zoecia are in actual contact there is little trouble in deciding the position of the particular form under study. Doubt has been cast upon the value of this differentiation in recent years, but even if the two divisions should not ultimately prove natural they are at least quite useful.

ORDER 4. CRYPTOSTOMATA.

In this order the zoecia are usually short and have their orifice concealed (*cryptos*, hidden) at the bottom of a tubular shaft or vestibule which is surrounded by a solid or vesicular calcareous deposit. The primitive zoecium is short and quite regular in its outline, being pyriform to oblong, quadrate or hexagonal with the aperture anterior. This same characteristic is shared by the Cheilostomata also and it is probable that the Cryptostomata are nothing more than Paleozoic Cheilostomata. The Cryptostomata differ, however, from the typical members of the Cheilostomata, first in having neither ovicells nor avicularia, second in the much greater deposit of calcareous material upon the front of the zoecia, third in the frequent development of successive layers of polypides, one directly over the other, thus forming a continuous tube, and fourth, in that whenever a zoarium attains an uninterrupted width of more than 8 millimeters it exhibits clusters of cells, differing more or less either in size or elevation from the average zoecia. The last two distinctions are suggestive of the Trepostomata, but the Cryptostomata differ chiefly in that the immature region (primitive cell) is usually much shorter and the passage to the mature region more abrupt, and that hemisepta occur at the bottom of the vestibule.

Some of the Cryptostomata are ramose and have long thin-walled prismatic tubes in the axial region, with or without diaphragms, precisely as in the ramose Trepostomata and Cyclostomata. They are distinguished from both these orders, however, by the presence of the hemiseptum, the incomplete plate which extends downward and forward from the posterior side of the base of the vestibule into the primitive cell. Sometimes a second hemiseptum is found springing from the bottom of the cell, in which case the latter is known as the inferior hemiseptum and the former as the superior one. The purpose of the hemisepta is unknown, although it is possible that they served as supports for a movable operculum.

The relationship of the Cryptostomata to the Cheilostomata is further suggested in the zoarial forms they assume and in the beauty of the surface of the zoecia. In the typical Cryptostomata the zoarium consists of two thin layers of zoecia growing back to back into erect sword-shaped, ramose, ribbonlike or fan-shaped expansions. In other Cryptostomata the zoaria form lacelike expansions consisting of only a single layer of cells with the reverse side covered by a dense layer of striated or minutely granulose tissue. In the remaining sections of the order the zoaria are ramose with the zoecia arising from a real or imaginary axis and opening on all sides of the cylindrical stems. Usually the zoaria are continuous, but in some of the bifoliate and ramose forms they are divided into segments, articulating with each other.

Most of the Cryptostomata can be identified from the zoecial surface characters, but in some of them, particularly the bifoliate and solid ramose species, thin sections are as essential as in the Trepostomata. On account of their geometrical regularity of zoecial form, thin sections of the Cryptostomata are often most beautiful objects under the microscope.

The order commences in Early Ordovician times, reaches its greatest development in the Devonian and Mississippian, and becomes extinct at the close of the Permian. Typical examples of the order are illustrated in text figure 8. Many of the Ordovician genera and species were described and illustrated by Ulrich in 1893²⁵ and Bassler in 1911,²⁶ the Silurian by Bassler in 1906,²⁷ the Devonian by Hall and Simpson in 1887,²⁸ and the Carboniferous by Ulrich in 1890.²⁹

ORDER 5. CHEILOSTOMATA.

The Cheilostomata, characterized by the closure of the aperture by a chitinous lip or operculum when the polypide is retracted, included most beautiful objects from an esthetic standpoint because usually in this order the frontal wall of the zoecium is composed of calcite assuming often the most delicate and sometimes bizarre patterns. Until recently the differences in these patterns were relied upon for the discrimination of genera and species, with the result that a most unnatural classification prevailed. The calcification of the frontal wall is only one of the functions of the bryozoan and a natural classification should be based upon all the important fea-

²⁵ 1893. Ulrich, E. O. Lower Silurian Bryozoa of Minnesota, *Geology of Minnesota*, vol. 3, pt. 1.

²⁶ 1911. Bassler, R. S. The Early Paleozoic Bryozoa of the Baltic Provinces. *Bulletin* 77, U. S. National Museum.

²⁷ 1906. Bassler, R. S. The Bryozoan Fauna of the Rochester Shale. *Bulletin* 292, U. S. Geol. Survey.

²⁸ 1887. Hall and Simpson. Corals and Bryozoa. *Paleontology of New York*, vol. 6.

²⁹ 1890. Ulrich, E. O. Paleozoic Bryozoa. *Geological Survey, Illinois*, vol. 8.

tures. The Cheilostomata exhibit the highest type of development in the bryozoa and for that reason the description of the various functions of the animal has been reserved for this place. The living bryozoan shows that these functions in the order of their importance are first those dealing with reproduction, namely, with the

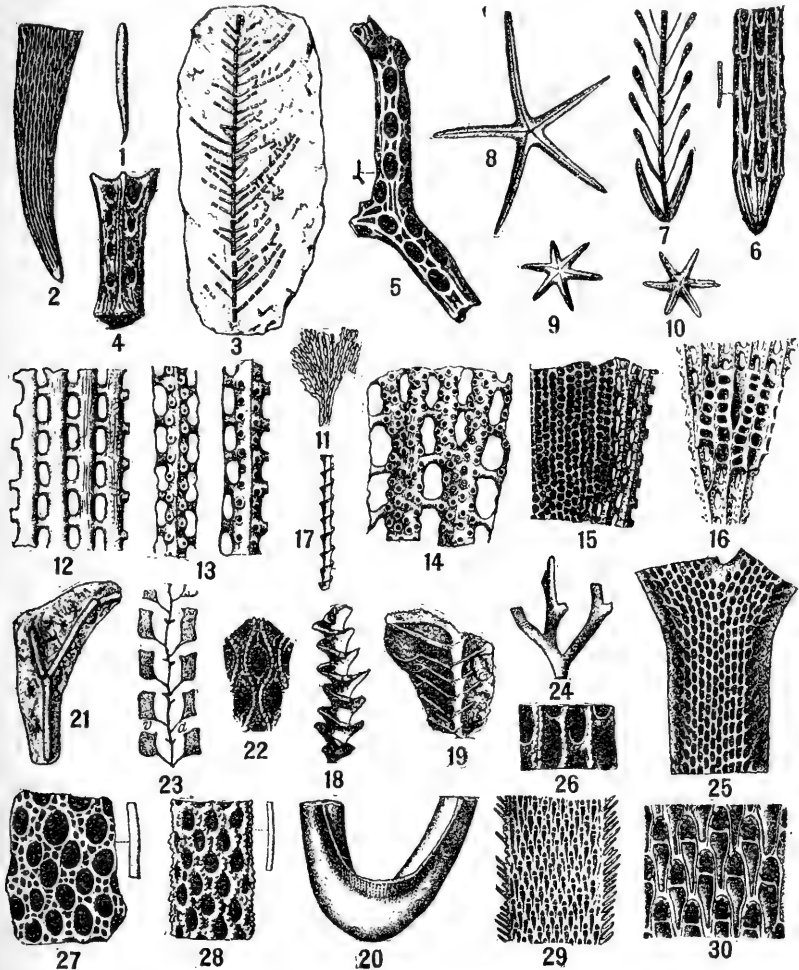

FIG. 8.—Cryptostomata.

- 1-2. *Escharopora subrecta* Ulrich. Middle Ordovician (Black River) shales of Minnesota. A typical member of the Cryptostomata. 1. The narrow bifoliate zoarium, two-thirds natural size, with a pointed striated base which fits into a corresponding socket attached to other objects. 2. Surface of the basal part of a specimen, $\times 6$.
- 3-4. *Arthroclema billingsi* Ulrich. Ordovician (Trenton) limestone, Ottawa, Canada. 3. Zoarium composed of numerous joints articulating with each other, two-thirds natural size. 4. A single joint or segment, $\times 12$, of a related species (*A. cornutum* Ulrich) with a socket for articulation on top and the pointed basal articulating process at the bottom.
5. A threadlike bryozoan of this order (*Nematopora ovalis* Ulrich) natural size and $\times 12$, from the Middle Ordovician shales of Minnesota.

- 6-7. *Helopora spiniformis* Ulrich. Ordovician (Lebanon) limestone of Central Tennessee. 6. One of the jointed segments natural size, and the lower portion of the same, $\times 18$. 7. Longitudinal thin section of the same species showing the short immature region and the thickened mature zone.
- 8-10. Cryptostomata with star shaped zoaria, two-thirds natural size, often mistaken for fossil star fishes. 8. A five-rayed form (*Evactinopora quinqueradiata* Ulrich) from the Lower Carboniferous (Burlington) limestone of Iowa. 9, 10. Two views of a six-rayed form (*E. scarradiata* Meek and Worthen) from the same locality.
- 17-19. *Archimides*, a characteristic Lower Carboniferous bryozoa, two-thirds natural size, in which the lacelike cell-bearing zoarium similar to *Fenestella* is wound around a solid spiral axis. Specimens (17, 18) with the celluliferous portion broken away are most frequently found but occasionally more of the frond is preserved (19).
20. Another characteristic Lower Carboniferous bryozoan (*Lyropora*) in which the solid support is lyre shaped with the lacelike portion stretched between two supports.
- 21-23. A typical member of the Cryptostomata (*Arthropora simplex* Ulrich) from the Middle Ordovician (Black River) shales of Minnesota, showing several segments, two-thirds natural size, preserved in their natural position (21), the ornamentation of the zooecial surface, $\times 22$ (22) and a vertical section $\times 12$, illustrating the typical internal structure of the Cryptostomata (23), namely, the short boxlike immature zone with its hemisepta and the thickened mature zone with the zooecial aperture (*a*) at the base of the vestibule (*v*).
- 24-26. A bifoliate ribbonlike cryptostomatous bryozoan (*Rhinidictya mutabilis* Ulrich) from the middle Ordovician shales of Minnesota. 24. A specimen, two-thirds natural size. 25. The surface, $\times 12$, showing the very regular arrangement of the zooecia characteristic of the Cryptostomata. 26. Several zooecia still further enlarged and illustrating the surface ornament.
27. *Streblotrypa herzeri* Ulrich from the Lower Carboniferous rocks of Ohio. A narrow ramose zoarium, natural size and $\times 12$, simulating Trepostomata externally but having the internal structure of the Cryptostomata.
28. *Rhombopora ohioensis* Ulrich from the Lower Carboniferous of Ohio, natural size and $\times 12$, a representative of a characteristic Upper Paleozoic genus.
- 29-30. *Worthenopora spinosa* Ulrich, from the Lower Carboniferous (Warsaw) limestone of Illinois, showing possible relationship of the Cryptostomata to the Chelostomata. 29. A view of the bifoliate branch $\times 9$, illustrating the spinose margin. 30. Zooecia of the same, $\times 28$, showing the Chelostomatous type of zooecia.

passage of the eggs and the escape of the larvae, or, in other words, the relations between the operculum and the ovicell; second, the hydrostatic system and extrusion of the polypide, and lastly, calcification and chitinization, or the nature of the skeletal part of the animal. Therefore the least important of these functions has as mentioned before been almost invariably alone considered. These functions are not difficult to determine in the recent forms, but in the fossil species, where only the calcareous skeleton remains, it would seem sometimes impossible to discover all of them. Fortunately the form of the aperture indicates the hydrostatic function, the presence of cardelles or projections on the apertural wall reveals the movements of the operculum, and the nature and position of the ovicell illustrates the function of reproduction.

Function of reproduction.—A permanent classification of the bryozoa is impossible at present, because each family is undoubtedly characterized essentially by its larva and unfortunately the larval form is known at present in only a few families. The fertilized eggs of the bryozoan are transformed into embryos and these into larvae

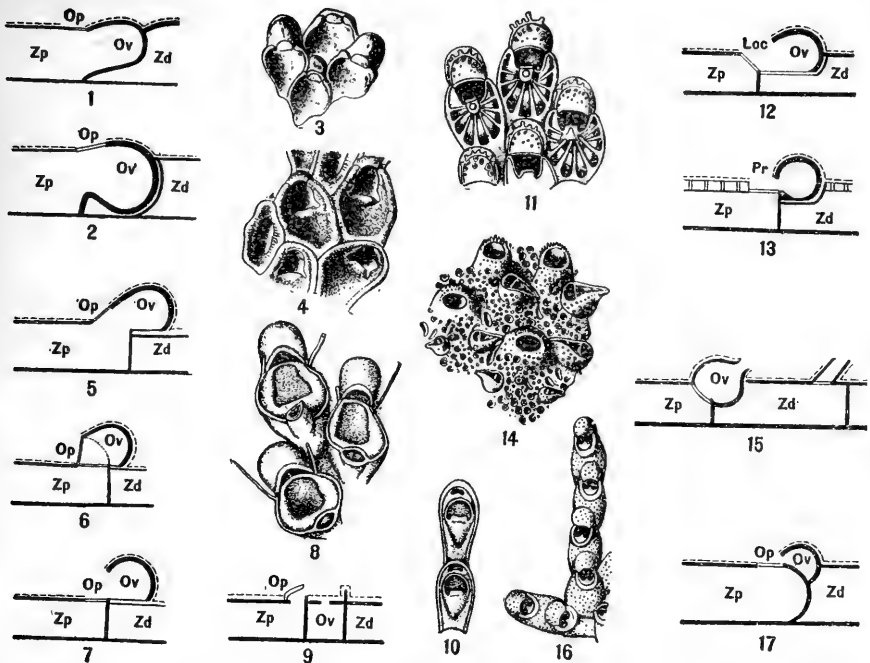

FIG. 9.—Ovicell structure in the Cheilostomata. Op=Operculum; Ov=ovicell; Zd=distal zoecium; Zp=proximal zoecium; Loc=locella; Pr=peristomie or tube developed by growth of peristome. The thin broken line indicates the membranous ectocyst, while the thin double line represents the operculum.

- 1-2. Longitudinal sections through zoecia with an endozoecial ovicell. The ovicell is within the zoecium itself and the operculum closes both the zoecium and the ovicell. In 2 a fold of the zoecial wall separates the ovicell from the zoecium.
3. *Micropora coriacea* Esper. A group of zoecia, $\times 25$, with two showing the endozoecial ovicell and the operculum closing the ovicell as well as the zoecia.
4. *Velumella levinseni* Canu and Bassler. Zoecia, $\times 40$, with the two uppermost bearing the small endozoecial ovicell.
- 5-7. Sections showing three types of hyperstomial ovicell in which the ovicell is placed on the distal zoecium. In 5 the ovicell opens below the operculum, and there is thus only one aperture. In 6 there are two apertures, and the operculum in opening closes the ovicell. In 7 the ovicell opens above the operculum.
8. Three ovicelled zoecia of *Ramphonotus minax* Busk, $\times 50$, illustrating the hyperstomial form of ovicell.
9. Sketch of endotoichal ovicell in which the ovicell is completely separated from the zoecium and its orifice is removed from the aperture and placed in the same plane.
10. Two zoecia, $\times 50$, of *Cellaria sinuosa* Hassall, showing the apertures of the small endozoecial ovicell in advance but on the same plane as the large zoecial apertures.
11. Ovicelled zoecia, $\times 36$, of *Umbonula verrucosa* Esper with hyperstomial ovicell opening largely above the aperture.
- 12-13. Hyperstomial ovicells. In 12 the ovicell is placed in a deep cavity of a distal zoecium. The operculum is very oblique and operates in a special chamber or locella. 13 represents a special type in which the ovicell opens above the operculum in the peristomie or tube formed by the growth of the peristome.
14. A group of zoecia, $\times 23$, of *Tubiporella magnirostris* MacGillivray, with two peristomial ovicells.
15. Diagram of a peristomial ovicell showing its formation by an enlargement of the peristomie.
16. Typical example (*Phylactella labrosa* Busk) of the recumbent ovicell, $\times 30$, in which the ovicell is placed on the distal wall of the zoecium itself.
17. A sketch of a recumbent ovicell showing its relations to the zoecia and operculum.

within special cavities of incubation which, when visible, are called ovicells. A large number of species of Cheilostomata show no ovicells and nothing on the exterior reveals their mode of reproduction. Some are oviparous and expel their eggs by an intertentacular organ, but most of this order have some visible ovicell. An ovicell of a particular form and position usually characterizes all of the genera of a family, and it is of course an invariable rule that all the species of a genus should bear the same kind of ovicell. In addition to the position of the ovicell, the relationship of the operculum to the ovicell is also quite important. Its various methods of operation are illustrated in the accompanying diagram, which shows sketches of the more important types of structure. (Text fig. 9.) A section passing lengthwise through the zoecia or individual cells is necessary to determine the nature of the ovicell as well as the general structure. This section requires much care, as the specimen must be mounted on edge and the abrasion must follow a definite row of cells. By the use of small wire nippers it is easy to trim the specimen to just the right form, then by mounting it in hardened balsam between two small bits of wood (fragments of a match serve excellently) to hold it on edge, the abrasion can be continued until the desired section is obtained. Actual dissection of the specimens with a fine needle under the microscope is often necessary, especially to determine the nature of the ovicell.

Hydrostatic function.—The discovery of the zoecial hydrostatic function by Jullien in 1888 explained many manifestations of the bryozoan which for a long time had remained absolutely unknown. This function of the extrusion of the polypide is so important that the two suborders of the Cheilostomata, the Anasca and Ascophora, are based upon it. In the suborder Anasca the so-called compensation sac is wanting and the polypide is extruded from the zoecium through the depression of the chitinous frontal wall by parietal muscles. This feature, as well as the general anatomy of the polypide in this order, is illustrated in text figure 10. In the Ascophora the polypide can emerge from the zoecium only if an equal volume of water is introduced to compensate for the extrusion. For this purpose the compensation sac (text fig. 11) or compensatrix is placed beneath the dorsal under the larger part of the zoecial length and communicates with the aperture. At the moment of extrusion of the polypide, muscles attached to the compensation sac contract, thus enlarging the sac, and the operculum in opening for the extrusion of the polypide frees its orifice. A minute drop of water then penetrates into the sac, thus compensating for the polypide. The entrance of the water into the compensation sac is thus the hydrostatic function and it is exercised in many ways which

are indicated by the nature of the frontal and of the operculum. The nature and shape of the operculum is thus very important and whenever possible the student should make a special study of this organ.

Operculum.—This small chitinized organ closes at the same time both the orifice of the polypide and of the compensation sac, its anterior part, or *anter*, closing the former and the posterior part, or

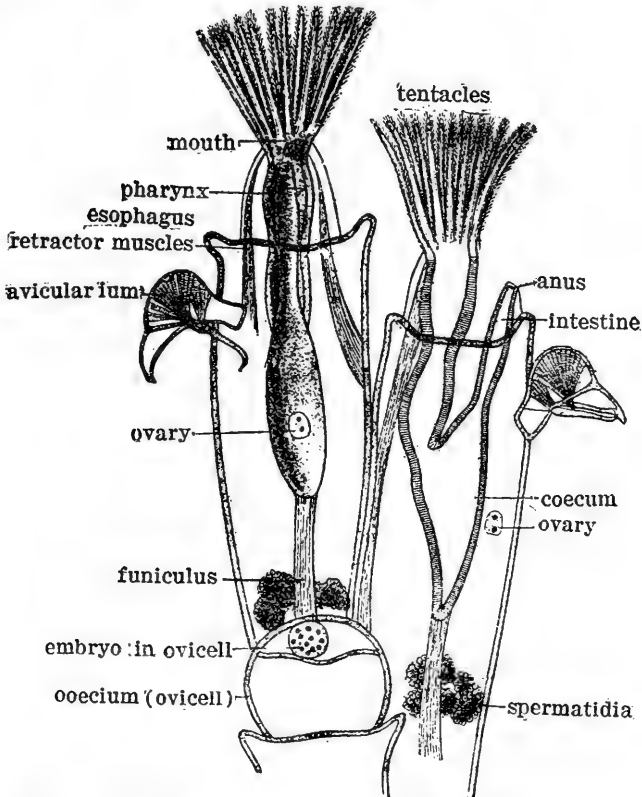

FIG. 10.—General anatomy of the Cheilostomata. Two zooids of the common corneous cheilostomatous bryozoan (*Bugula avicularia* Linnaeus) from the Atlantic, showing the various parts of the polypide, highly magnified. (After Parker and Haswell.)

poster, similarly closing the latter. Thus the shape of these two portions is evidence of the nature of the tubes they close and the determination of the operculum is an important feature. (Text fig. 12.) In one large group of the Ascophora the orifice of the compensation sac is very small and the operculum has a corresponding small narrow tongue; in another group this orifice is quite large and the corresponding portion of the operculum is large; again a special tube, the spiramen (text fig. 13), may introduce the water into the com-

pensatrix. Finally, the compensation sac may not end in the aperture at all, but may open exteriorly by a special pore, the ascopore.

The form of the operculum is therefore in most cases identical with that of the aperture, but the latter on fossil forms is not always

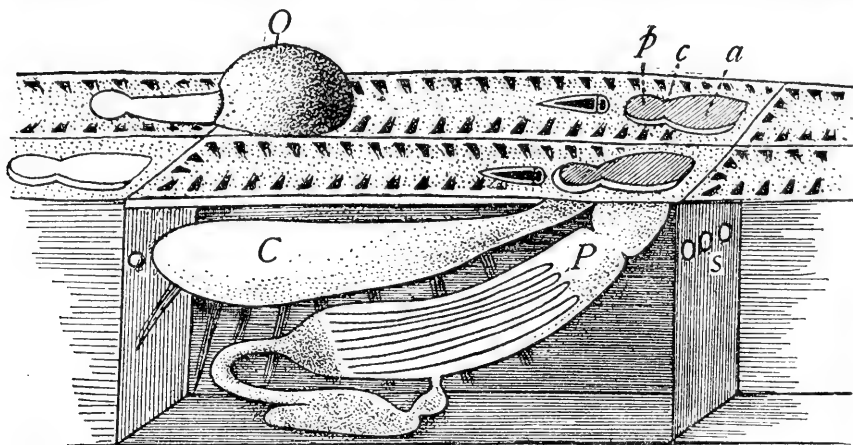

FIG. 11.—Diagrammatic drawing of a Cheilostomatous bryozoan belonging to the sub-order Ascophora, showing the ovicell (*O*), the ornamental calcareous frontal wall with a spear-shaped avicularium and the form of the operculum with its posterior portion (*p*), which leads into the compensation sac (*c*), the anterior portion (*a*) closing the orifice of the polypide (*P*). The hinge or cardelle upon which the operculum operates is shown at *c* and the communication pores or septulae, between the zooecia, at *s*.

visible exteriorly, for it may be hidden by excessive calcification of the frontal or by exterior organs such as the avicularia. The only safe means of determining the true form of the aperture is the ex-

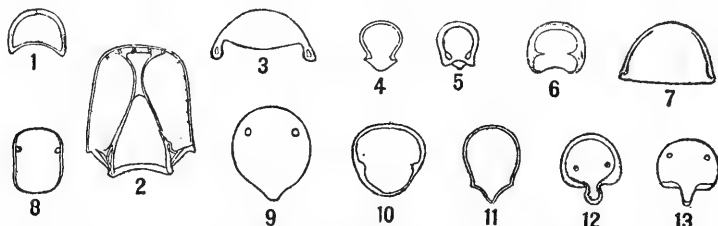

FIG. 12.—Opercula. Sketches showing the operculum in different genera of Cheilostomata.

1-3. *Anasca*, no compensation sac (1, *Thalamoporella*; 2, *Steganoporella*; 3, *Aspidostoma*).

4-13. Ascophora, illustrating the variations in form of the anterior portion of the operculum (anter) through which the polypide emerged and the posterior part (poster) by which water was introduced into the compensatrix. (4, *Trypostega*; 5, *Triphyllozoon*; 6, *Smittina*; 7, *Holoporella*; 8, *Stichoporina*; 9, *Bipora*; 10, *Peristomella*; 11, *Schismopora*; 12, *Rhynchozoon*; 13, *Schizopodrella*.)

amination of the interior of the zoecium obtained by abrasion of the basal surface. This preparation is easily made by mounting the fragment to be studied in hard Canada balsam on a glass slip, cellu-

liferous side down, and then rubbing away the superfluous material until the inner side of the calcified frontal wall is revealed when the true nature of the frontal unchanged by any external influence may be found.

The preparation of the operculum, which remains only on recent forms of course, is another important and quite simple operation. The simplest way to prepare slides for viewing under the microscope is to scrape off a few zoecia with the operculum in place, crush these carefully in a drop of water on the slide and after drying add Canada balsam and a cover glass. Some of the opercula will be

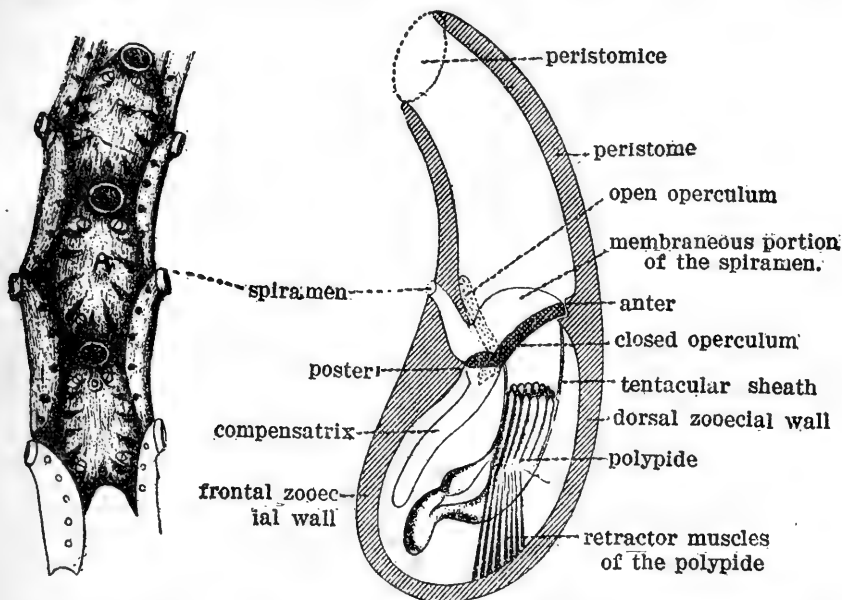

FIG. 13.—Structure of the Ascophora. *Tessardoma gracile* Sars. A recent species of the Ascophora showing a zoarial branch, $\times 60$, and a drawing of a longitudinal section through a single zoecium with the various parts of the zoecium and polypide indicated. (After Hincks and Jullien.)

broken by this crude method, but enough perfect specimens will remain to make the saving of time worth while.

Formation of the zoarial skeleton.—The living tissue of the bryozoan giving rise by its differentiation to all the various organs is a delicate epithelial membrane, the endocyst, lining the interior of the skeletal parts. The first differentiation of the endocyst is the ectocyst, a thin outer covering membrane which has no secreting power. Next, the endocyst secretes the mesenchyme, which in turn gives origin to the polypide and other portions of the organism.³⁰ The calcareous or chitinous secretion forming the zoarial skeleton occurs be-

³⁰ 1900. Calvet, L. Contributions a l'histoire des bryozoaires ectoproctes marins. Tra-vaux de l'institut Zoologie de l'Université de Montpellier, new ser., Memoire No. 8.

tween the ectocyst and endocyst and with all of its variations in structure and accompanying organs, such as vibracula and avicularia, is a result of the activity of the endocystal buds. The walls of the zoarial skeleton may consist simply of a smooth thin calcareous deposit, the olocyst, or above this may be secreted a second very porous layer, the tremocyst, intimately joined with the olocyst, although sometimes clearly detachable. A third layer, the pleurocyst, consisting of a granular deposit with lateral punctations, may also occur. The pores of these several layers are traversed by mesenchymatous fibers which likewise pass from zoecium to zoecium through the lateral walls by small pores called septulae. These may be uniporous or multi-

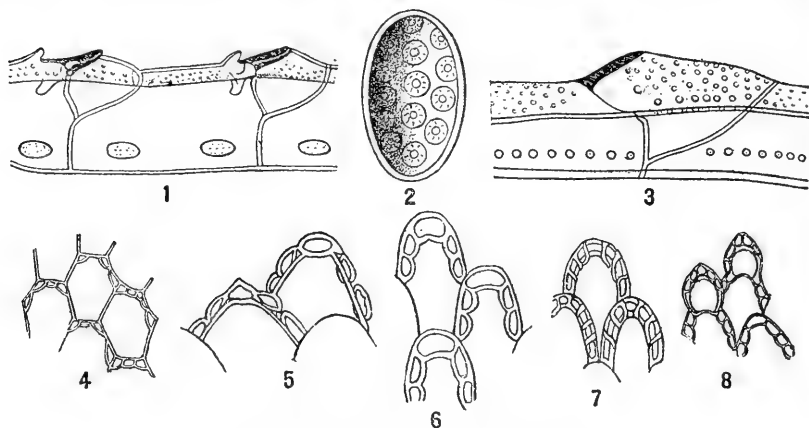

FIG. 14.—Septulae and diatellae.

1-3. Septulae or parietal pores through which the mesenchymatous fibers pass from one zoecium to another. 1. Edge view of a zoecium of *Cheilopora sincera* Smitt with multiporous septulae developed (=rosette plates of authors). 2. A greatly enlarged view of a multiporous septula illustrating details of the structure. 3. Edge view, $\times 23$, of portions of two zoecia of *Hippopodina fecgensis* Busk showing uniporous septulae through the lateral walls.

4-8. Diatellae or pore chambers. Views of various species of Cheilostomata magnified, as seen from the basal side and illustrating the variation in aspect of the diatellae. 4. *Peristomella prestans* Hincks. 5. *Ellisina levata* Hincks. 6. *Callopora lineata* Linnaeus. 7. *Cauloramphus spinifer* Norman. 8. *Trypostega venusta* Norman.

porous (text fig. 14), but before reaching the septulae the mesenchymatous fibers traverse small lateral chambers in the proximal part of the zoecium, called diatellae or pore chambers.

The discrimination of the characteristics of these various zoecial skeletal features is important in the determination of genera and species, and so it is necessary in study that the following preparations be made. First, thin sections of the wall, particular the frontal, are needed to illustrate the characters of the three layers, olocyst, tremocyst, and pleurocyst. Second, the frontal must be abraded away to show the occurrence of such structures as diatellae. This abrasion is effected by mounting the specimen, frontal side up, in Canada balsam

on a slide and after heating to harden the balsam rubbing it gently on a soft hone.

Avicularia and vibracula.—The “bird’s head” organ or avicularium (text fig. 15) attached to the zooecia of many Cheilostomata consists of a small cell containing a rudimentary polypide and of a

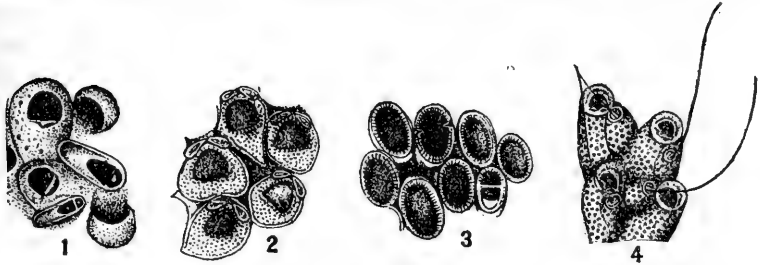

FIG. 15.—Avicularia and Vibracula.

1. *Holoporella descostilii* Savigny-Audouin, $\times 25$, with large avicularia preserving bar on which the mandible operates.
2. *Antropora granulifera* Hincks, $\times 30$. The avicularia are small and developed in pairs just above the aperture.
3. *Grammella crassimarginata* Hincks, $\times 30$, in which the avicularia are very similar to the zooecia but may be distinguished by the occurrence of the bar.
4. *Mastigophora hyndmanni* Johnston, $\times 30$. Zooecia preserving the long vibraculum and the pore from which it emerges. (After Hincks.)

mobile chitinous mandible which in life keeps up a snapping motion. The latter peculiarity led to the belief that the purpose of the avicularia was one of defense, but it is more probable that they have something to do with alimentation or oxygenation. The mandibles are symmetrical objects corresponding to the opercula of normal zooecia

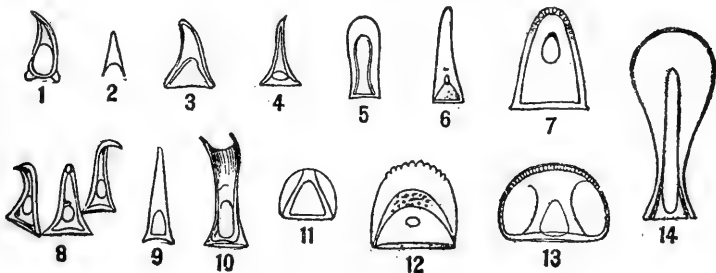

FIG. 16.—Mandibles.

Various types of this chitinous portion of the avicularium, magnified, which is useful in the identification of cheilostomatous bryozoa. 1, *Adeonclopsis*; 2, *Smittina*; 3, *Peristomella*; 4, *Schizopodrella*; 5, *Smittina*; 6, *Retepora*; 7, *Holoporella*; 8, *Retepora*; 9, *Adeona*; 10, *Triphylozoon*; 11, *Thalamoporella*; 12, *Smittina*; 13, *Umbonula*; 14, *Thalamoporella*.

and like them varying in shape with the species, so that the determination of their size and shape is as essential in detailed work as that of the opercula. Their preparation for study under the microscope is the same as for the opercula, already described; indeed, the two will almost always be found on the same slide. Some of the variations in the form of the mandibles are illustrated in text figure 16.

They usually have a straight proximal edge, which works against a calcareous bar, or, when this is not complete, from two teeth. In the fossil forms and in many dead specimens of recent species the mandible has been lost, but its position is clearly indicated on the porelike spaces left by the avicularia in well-preserved specimens.

The vibracula (text fig. 15) are modified zooecia, similar to the avicularia, but differing in the occurrence of a long cilium or seta in place of the mandible. The porelike excavation it leaves in the fossil forms does not show the variation of structure observed in the avicularia.

Classification.—From the foregoing discussion it will be noted that more factors enter into the determination of a cheilostomatous bryozoan than in those of any other order. First the presence or absence of a compensation sac must be learned in order to place the species in its proper suborder (*Anasca* or *Ascophora*). Then the relationship between the operculum and the ovicell and, again, between the operculum and the compensatrix, the position of the ovicell, the form of the aperture, the nature of the frontal wall, which may be chitinous or, when calcareous, may be smooth (*olocyst*), punctate (*tremocyst*), or radiately ribbed (*pleurocyst*), the occurrence of dietellae and septulae, and of avicularia and vibracula, as well as other more detailed structural features which have not been discussed in this article, are to be observed in turn. The proper description and illustration of a species of Cheilostomata is a considerable task in itself, which can not be accomplished simply by publishing a diagrammatic figure of the zooecial surface characters.

Formerly the classification of the Cheilostomata was based on purely zoarial features, but in the latter half of the nineteenth century the zooecial characters were more closely studied, especially by Busk,³¹ D'Orbigny,³² Smitt,³³ and Hincks.³⁴ The latter author considered especially the form of the aperture—in other words, only the hydrostatic system—but Jullien³⁵ in various publications emphasized the more important characters for consideration. The microscopic anatomy of the polypide in the Cheilostomata is described and illustrated in detail in Calvet's important contribution in 1900.³⁶ Various

³¹ Busk George. Catalogue of Marine Polyzoa in Collection British Museum. Cheilostomata (1852); Polyzoa collected by H. M. S. *Challenger*, Pt. 1. Cheilostomata, Vol. X, Pt. XXX (1884), and various articles entitled "Zoophytology in the Quarterly Journal Microscopical Science from 1855 to 1867.

³² D'Orbigny, Alcide. Paléontologie française, Terrain Crétacé, Vol. V, 1852.

³³ Smitt, F. A. Kritisk förteckning öfver Skandinaviens Hafs-bryozoer. Öfversigt af Kongl. Vetenskaps-Akademiens Förhandlingar, vols. 22 to 24 (1865-1867) and vol. 28 (1871).

³⁴ Hincks, Thomas. British Marine Polyzoa (1880).

³⁵ Jullien, Jules. Mission Scientifique du Cap Horn, 1882, 1883, Vol. VI, Zoologie, Bryozoaires (1888).

³⁶ Calvet, L. Contributions à l'histoire des bryozoaires ectoproctes marins. Travaux de l'Institut Zoologie de l'Université de Montpellier, new ser., Mem. No. 8, 1900.

works on the structure of the Cheilostomata have been issued by Harmer, and Waters since 1878 has been a most important contributor to this subject. His many memoirs on both Cenozoic and Recent bryozoa likewise are of the highest value. In 1909 Levinsen³⁷ published a memoir which is indispensable to the modern student.

The fossil Cheilostomata also form the subject of numerous researches, among which the work on Cretaceous faunas by D'Orbigny and various monographs on the Tertiary of Europe,³⁸ Africa,³⁹ and South America⁴⁰ by Canu and of North America⁴¹ by Canu and Bassler should be mentioned. The last-named work contains numerous text figures illustrating family and generic structure, in addition to detailed references to the literature.

DISTRIBUTION OF THE BRYOZOA.

The continent of North America is undoubtedly the most favored part of the earth for reading Paleozoic history, and it is equally favored for the study of fossil bryozoa, as many of the Paleozoic marine limestone and shale formations abound in these organisms. The Eurasian land mass presents many surface exposures of Paleozoic age, but they are to a greater or less extent disconnected, and the fossil forms are not so well known as in America. In Asia the Salt Range of India has yielded Carboniferous bryozoa, while in Europe the region of the Ural Mountains and the areas bordering on the Baltic Sea, England, and Scotland contain most of the Paleozoic strata which have thus far afforded specimens. Three or four times as many species have been made known from the Paleozoic of North America as from all the rest of the world.

The earliest undoubted bryozoan is a species of the peculiar trepostomatous genus *Nicholsonella*, occurring in the Canadian rocks of Arkansas, although a species referred doubtfully to the Ctenostomata has been described from the Ungulite sandstone of Early Ordovician age in Esthonia. The limestones and shales of the various divisions of the Ordovician above the Canadian abound in stony bryozoa of the Cryptostomata and Trepostomata (pl. 1, fig. 1), although the Cyclostomata are represented and an occasional species of Ctenostomata may be found. In the Silurian, bryozoa are not so common, and the

³⁷ Levinsen, G. M. R. Morphological and systematic studies on the Cheilostomatous Bryozoa (1909).

³⁸ Canu, F. Bryozoaires des terrains tertiaires des environs de Paris. *Annales de Paléontologie*, tomes 2 (1907), 3 (1908), 4 (1909), and 5 (1910).

³⁹ Canu, F. Etude comparée des Bryozoaires Helvétiques de l'Egypte avec les Bryozoaires vivants de la Méditerranée et de la mer Rouge. *Mémoires de l'Institut Egyptien*, tome VI, 1912.

⁴⁰ Canu, F. Iconographie des Bryozoaires fossiles de l'Argentine. *Anales del Museo Nacional de Buenos Aires*, tomo XVII (1908), tomo XXI (1911).

⁴¹ Canu and Bassler. North American Early Tertiary Bryozoa. *Bulletin* 106, U. S. National Museum, 1920.

Cryptostomata developed at the expense of the Trepostomata. In the Devonian and Carboniferous the Trepostomata became much reduced in numbers and finally disappeared, while the Cryptostomata formed a wealth of species, especially of the lacelike *Fenestella* (pl. 1, fig. 2) and its allies. The Ctenostomata remain as sparsely represented as before, but the Cyclostomata have increased in number by the development of the great family Fistuliporidae.

With the beginning of the Mesozoic a decided change occurs in the bryozoa. The Cryptostomata and Trepostomata have disappeared entirely, the Ctenostomata are as rare as before, but the Cyclostomata now develop great numbers of species, with zoaria quite similar in many instances to the Paleozoic Trepostomata. The Cyclostomata remain the predominating type until Upper Cretaceous time, when the Cheilostomata, which appear in the Jurassic, now expand into so many species that they soon attain supremacy. D'Orbigny alone has described not less than 537 species of Upper Cretaceous Cyclostomata and 300 Cheilostomata, although many of these are synonyms. This great development of the bryozoa in the Mesozoic is known only in European strata, for in North America and in other parts of the world these rocks have yielded comparatively few bryozoan faunas.

Both North America and Europe are noted for their Cenozoic bryozoan faunas. The Atlantic and Gulf coastal plains of North America and the northern and southern slopes of the Alps, as well as numerous other localities in Europe, are rich in bryozoa with the Cheilostomata and Cyclostomata well represented and the former predominating. Southern Australia likewise affords an abundant Tertiary bryozoan fauna.

In the recent seas the Cheilostomata, exhibiting the bryozoa at the highest stage of their perfection and beauty, is the predominating order and numerous species have been described from all the oceans where they occur, usually in abundance, from tide level down to great depths. The voyage of the *Challenger* brought forth a wealth of species which has since been greatly augmented by various expeditions, as well as by the activity of local collectors. The seaweed tossed up so abundantly along certain coasts is a fertile collecting place for many parasitic species of Cheilostomata and Cyclostomata.

STRATIGRAPHIC VALUE.

The use of fossil bryozoa in stratigraphic work has scarcely attained the importance it deserves. In American Paleozoic strata they are preeminently the fossils to be relied upon in correlation work. They are nearly always abundant, and even when poorly preserved exteriorly can be identified by thin sections. Crinoids and

crustaceans are usually too scarce; mollusca, abundant in some formations, are almost wanting in others, and likely to be poorly preserved; vertebrate remains are too few, and usually local in distribution. The brachiopods are also usually abundant in all Paleozoic strata, but have commonly too great a range vertically to be trusty guides in close work.

In the Mesozoic rocks of America bryozoan faunas are few and so far little known, but in Europe they assume an importance equally as great as the Paleozoic faunas in America. In both continents the Cenozoic faunas are abundant and of great value for correlative purposes. In North America over 1,000 Cenozoic species are known, while in Europe the number is equally large.

Because to the unaided eye there seems little variation of form among the bryozoa, they have been generally neglected by collectors and geologists. Early writers are also to some extent responsible for this neglect, for they failed to discriminate the different species, and made a few names, such as *Chaetetes lycoperdon*, *Stenopora fibrosa*, etc., serve for a multitude of diverse forms. It is no doubt true, and this is another cause for the neglect of the bryozoa, that their discrimination does require good powers of observation and careful, often tedious, study. Furthermore, the number of species is great. Somewhat more than 1,500 species have been described from American Paleozoic formations, yet these are probably but a half or a third of the distinguishable forms present and already largely known to specialists in the subject. The determination, at least the first determination, of the species often, and among the Trepostomata nearly always, requires the preparation of microscopic sections, a tedious operation at best. However, when once a species has been thoroughly worked out, it can generally be distinguished externally from associated forms of similar appearance by quite constant differences, which often seem trifling and yet are doubtless of morphological importance. These various considerations would seem to compel greater labor for the mastery of the bryozoa than for any other class, but accurate determination of the brachiopods, corals, graptolites, and other more widely studied groups requires equally great efforts.

In spite of numerous researches on the bryozoa as a whole, a beginning only has been made in the work of determining the geographical distribution of species and genera and of elucidating the many obscure questions regarding the migration of faunas in the ancient as well as in the modern seas, their extinction or evolution, their reappearance and like phenomena. Similarly the study of the larval forms, the anatomy of the polypide, and of the various subjects concerned in the relationship between the polypide and the zoecium offers a wide field of research.

EXPLANATION OF PLATES.

PLATE 1.

FIG. 1.—Limestone slab, natural size, composed mainly of Trepostomata or stony bryozoa. Middle Ordovician, St. Paul, Minnesota.

FIG. 2.—Surface of limestone, $\times 2$, from the Lower Carboniferous (Warsaw) limestone at Columbia, Illinois, exhibiting the remains of lacelike bryozoa (*Fenestella* and *Polypora*) of the order Cryptostomata.

PLATE 2.

FIG. 1.—Bryozoan marl from the Early Tertiary rocks of South Carolina. The figure to the left ($\times 2$) represents the rock as exposed by weathering and the one to the right the appearance of the specimens ($\times 2$) after preparation for study.

FIG. 2.—Dredgings from the vicinity of the Philippine Islands showing various types of recent cheilostomatous bryozoa, natural size, in a more or less fragmentary state.

PLATE 3.

Growth forms in the Cyclostomata.

FIG. 1.—A typical encrusting linear species *Stomatopora pratti* Canu and Bassler, $\times 4$, from the Eocene (Jacksonian) of North Carolina. A second, very minute, species of *Stomatopora* is also present.

FIG. 2.—Portion of the zoarium of *Stomatopora polygona* Canu and Bassler, $\times 4$, illustrating tendency of the branches to form polygons.

FIG. 3.—A fragment of Early Silurian stony bryozoa (Cryptostomata) with an encrusting cyclostomatous species, *Corynotrypa turgida* Ulrich, and the latter magnified, $\times 6$, to show the curious club-shaped zooecia.

FIG. 4.—Another species of encrusting Cyclostomata, *Corynotrypa inflata* Hall, $\times 6$, introduced for comparison with the preceding to show how these simple species differ from each other.

FIG. 5.—A common, recent bryozoan, *Crisia*, magnified, consisting of erect tuftlike zoaria made up of articulated segments with the zooecia arranged in two rows. The prominent ovicell is present.

FIG. 6.—Another recent jointed bryozoan, *Crisidia cornuta* Ellis, $\times 16$, with uniserial zooecia.

FIG. 7.—Noncelluliferous side of an erect, much-branched zoarium, *Hornera frondiculata* Lamouroux, from the recent seas.

FIG. 8.—Celluliferous side of *Discosparsa marginata* D'Orbigny, magnified, from the Cretaceous of France, showing subcolonies in various stages of growth.

FIG. 9.—A pear-shaped zoarium, *Lichenopora franqana* D'Orbigny, magnified, from the Cretaceous rocks of France.

FIG. 10.—A recent fungiform bryozoan, *Fasciculipora ramosa* D'Orbigny, from South Patagonia, slightly magnified.

FIG. 11.—Lateral view of *Idmonca magnireversa* Canu and Bassler, $\times 8$, from the Eocene (Jacksonian) of North Carolina, showing the zooecial openings on one side of the branch only.

FIG. 12.—Another branching species, *Mecynoccia cylindrica* Canu and Bassler, $\times 8$, from the Eocene rocks of North Carolina, in which the apertures open on all sides of the zoarium.

FIG. 13.—A branching species, *Zonopora cottaldina* D'Orbigny, magnified, from the Cretaceous of France, with the zooecial apertures and mesopores arranged in regular zones.

FIG. 14.—Magnified view of a solid ramose species, *Multicavea magnifica* D'Orbigny, from the Upper Cretaceous of France.

FIG. 15.—A solid ramose bryozoan, *Tretocycloecia attenuata* Ulrich, x 8, from the Lower Eocene (Midwayan) of Arkansas, with mesopores and a zoarium as in the Trepotomata, but possessing the ovicell (broken) of the Cyclostomata.

FIG. 16.—A composite zoarium, *Centronca (Multitubigera) micropora* Reuss, enlarged, from the Eocene rocks of Northern Italy.

FIG. 17.—A very common, simple ramose species of Cyclostomata, *Mecynocia proboscidea* Milne-Edwards, x 8, from the Tertiary (Vicksburgian) rocks of Alabama.

FIG. 18.—Another branching species, *Spiropora majuscula* Canu and Bassler, x 8, from the Eocene of South Carolina, showing the arrangement of the apertures in regular rows.

PLATE 4.

Structural features of the Cyclostomata.

FIG. 1.—Zoarium of *Stomatopora parvipora* Canu and Bassler, x 12, from the Eocene rocks of Mississippi showing the orbicular protoecium from which the first zooecium or ancestrula develops.

FIG. 2.—Drawing of a recent, bilinear, encrusting species, *Peristomocia (Stomatopora) divergens* Waters, enlarged, in which the free portion of the tube enlarges to form the ovicell.

FIG. 3.—A recent encrusting species, *Oncousoecia (Tubulipora) lobulata* Hincks, magnified, with the axis of the ovicell parallel to the tubes.

FIG. 4.—An ovicelled branch, x 6, of a fossil species, *Idmonea grillator* Canu and Bassler, from the Eocene rocks of Alabama, showing the ovicell on the celluliferous side.

FIG. 5.—Ovicelled example of *Tervia irregularis* Meneghini, x 6, illustrating the position of the ovicell on the dorsal, noncelluliferous side, characteristic of the family Terviidae.

FIG. 6.—Ovicelled zoarium, x 10, of the recent species *Tubulipora flabellaris* Fabricius.

FIG. 7.—The characteristic ovicell of the family Macroeciidae Canu, x 6, in which the oeciostome or opening of the ovicell is unusually large.

FIG. 8.—Basal side of an ovicelled zoarium of a discoidal species, *Discocytis eudesi* Michelin, x 3, from the Cretaceous rocks of France. The ovicells (some of them broken) form a regular circle about the base.

FIG. 9.—A portion of the jointed colony of *Crisia* showing the characteristic ovicell in the family Crisiidae.

FIG. 10.—A common recent and fossil bryozoan, *Mecynocia (Entalophora) proboscidea* Milne-Edwards, x 6, illustrating development of the ovicell parallel to the tubes.

FIG. 11.—A recent encrusting species *Plagioecia patina* Lamarck, x 6, exhibiting position of ovicell at right angles to the direction of the zooecia, characteristic of the family Plagioeciidae.

FIG. 12.—The ovicell of *Partretocycloecia porosa* Canu and Bassler, x 6, from the Eocene rocks of South Carolina, showing characteristics of the Tretocycloeciidae, a family of the Cyclostomata with mesopores and other features resembling the Trepotomata.

FIGS. 13-15.—Tergopores. 13. Longitudinal thin section of *Pleuronea subpertusa* Canu and Bassler from the Eocene of Mississippi, x 12, illustrating the structure of the tergopores (to the right) and the zooecial tubes. 14. Lateral side of the zoarium, x 6, showing oblique arrangement of the apertures. 15. Dorsal side of the zoarium, x 6, illustrating the large tergopores.

FIGS. 16-18.—Vacuoles. 16. Dorsal side, x 12, of *Hornera frondiculata* Lamouroux showing the vacuoles at the base of longitudinal sulci. 17. Celluliferous side of the same species, x 12. 18. Longitudinal thin section, x 12, of *Hornera antarctica* Waters showing vacuoles on both the frontal (to the left) and dorsal sides.

FIGS. 19-21.—Cancelli. 19. An ovicelled specimen of *Lichenopora radiata* Audouin, x 12, showing the zooecial apertures in regular rows separated by the cancelli. 20. Longitudinal thin section, x 12, of *Lichenopora goldfussi* Ruess. The cancelli are the superposed and ramified tubes. 21. Portion of a zoarium of *Lichenopora holdsworthi* Busk, x 12, illustrating the spinules in the cancelli.

FIGS. 22-24.—Dactylethrae. 22. Dorsal side of a branch, x 12, of *Erkosonea admota* Canu and Bassler, from the Eocene (Jacksonian) of North Carolina exhibiting the dactylethrae. 23. A longitudinal thin section of *Erkosonea scemota* Canu and Bassler, x 12, showing zooecial tubes to the left and dactylethrae to the right. 24. Celluliferous side of *E. admota* Canu and Bassler, x 12.

FIGS. 25-27.—Firmatopores. 25. Lateral view of a branch of *Idmidronea cutter* Canu and Bassler, x 6, from the Eocene (Jacksonian) of North Carolina showing the openings of the zooecial tubes in the upper right hand corner and the remainder of the branch covered with firmatopores. 26. Longitudinal thin section, x 12, of *I. coronopus* Milne-Edwards, illustrating structure of firmatopores (to the right) and zooecial tubes. 27. Celluliferous surface of *I. rosacea* Canu and Bassler, x 12, from the Eocene (Jacksonian) of North Carolina, exhibiting the zooecial apertures and the firmatopores.

FIGS. 28-29.—Nematopores. 28. Longitudinal thin section, x 12, of *Diplo-desmopora opposita* Canu and Bassler, from the Cretaceous rocks of France showing the zooecial tubes to the right and nematopores to the left. 29. An ovicelled branch of the same species, x 6, showing lateral position of the ovicell and the nematopores on the basal (right) side.

FIGS. 30-31.—Mesopores. 30. Longitudinal thin section of *Tretocycloecia reticulata* Canu and Bassler, x 6, showing the formation of the numerous mesopores in this species. 31. A zoarium of this species, x 6, from the Eocene (Jacksonian) of South Carolina illustrating the resemblance at the surface between the zooecia and mesopores.



FIG. 1.

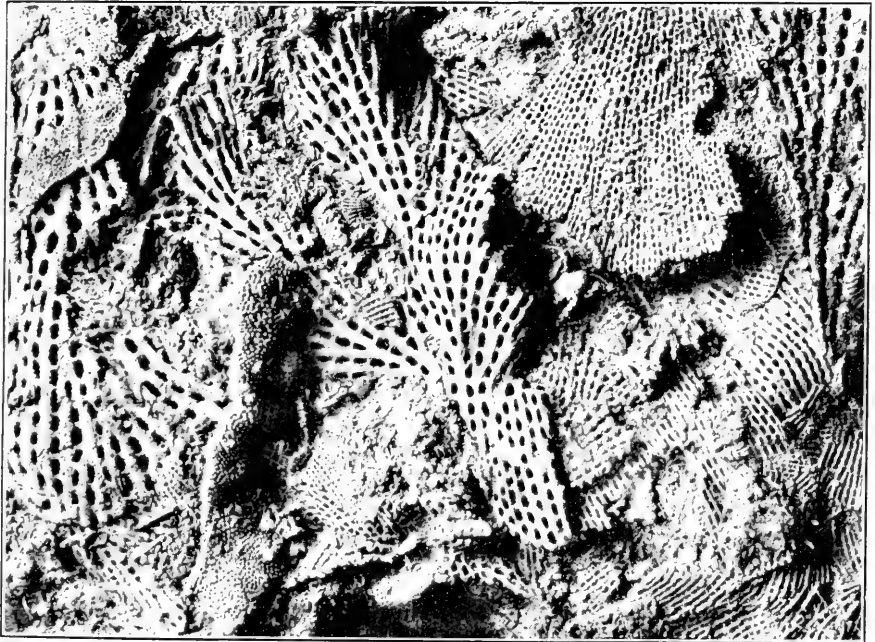

FIG. 2.

FOR EXPLANATION SEE PAGE 378.

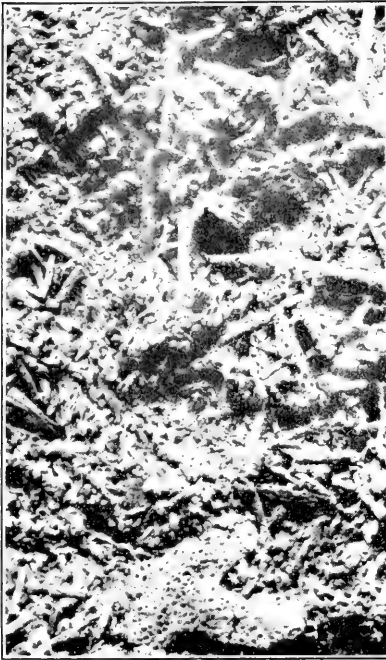

FIG. 1.

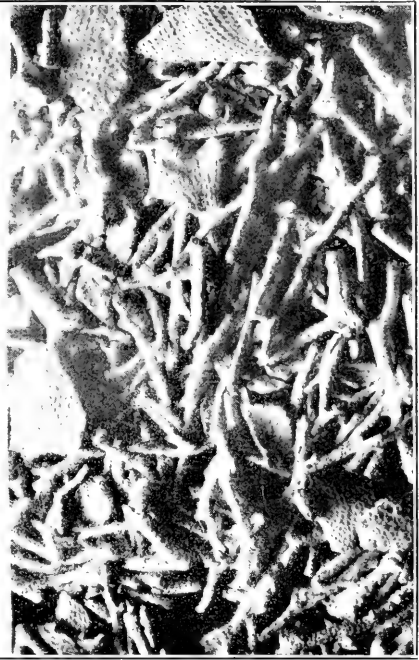

FIG. 2.

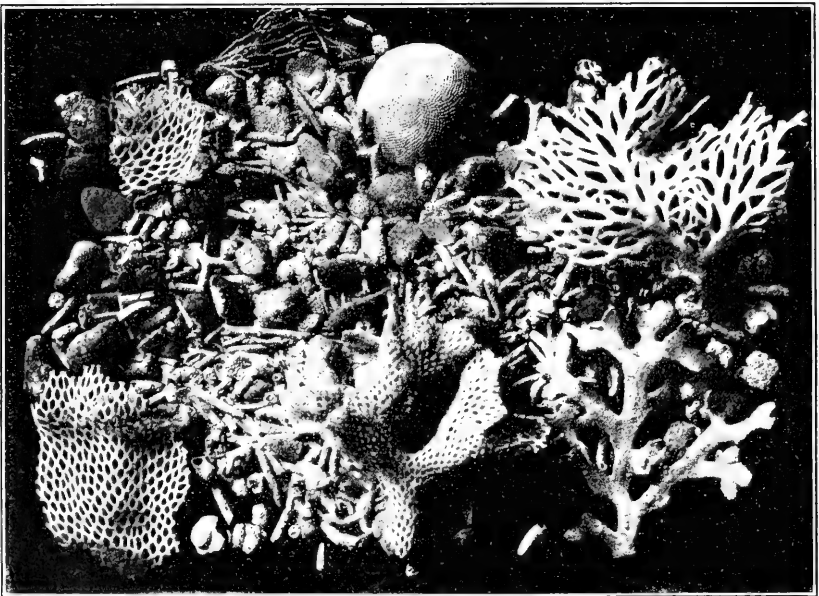
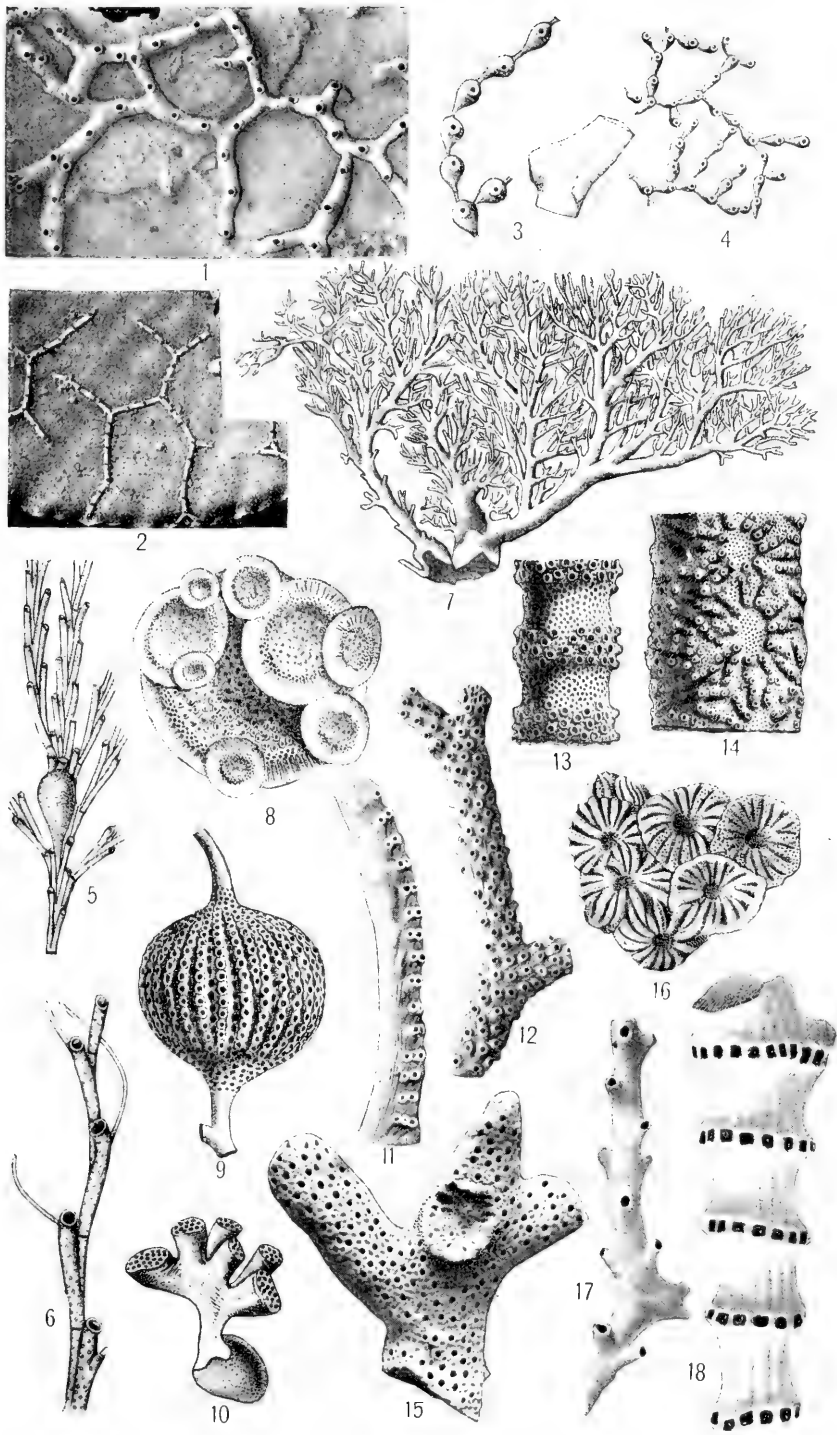
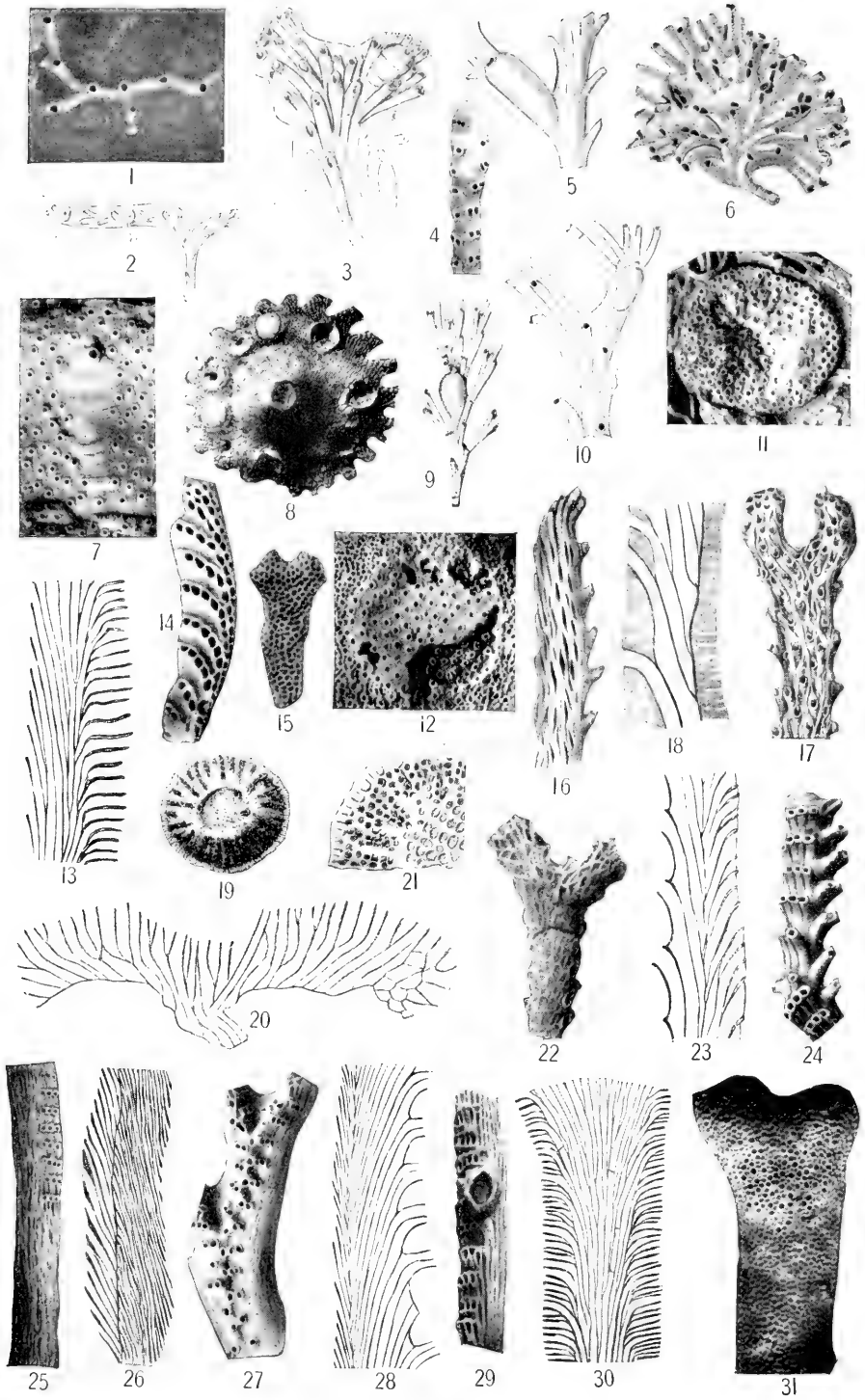

FIG. 3.

FOR EXPLANATION SEE PAGE 378.





THE HORNED DINOSAURS.

By CHARLES W. GILMORE,

Associate Paleontologist, Division of Palaeontology, U. S. National Museum.

[With 8 plates.]

The suborder of extinct reptiles known collectively as the Cera-
topsia, or as they are more popularly called the horned dinosaurs, is
one of the most remarkable of the many groups of extinct animals
known from North America. All the more interesting perhaps,
since they are, so far as known at this time, a strictly American
product.

Their fossil remains are confined to a narrow belt along the eastern
uplift of the Rocky Mountains, ranging from Alberta, Canada, on
the north to the Big Bend of the Rio Grande on the south. Geo-
logically they are found only in the latter half of the Upper Creta-
ceous, appearing suddenly in the Judith River formation (Belly
River of Canada), again in the Edmonton formation, where cera-
topsian remains are less common, and continuing through to the close
of the Lance, where they are the most abundant vertebrate fossils
found. In seven years exploratory work in the Lance formation
(Hell Creek Beds) of Montana, Mr. Barnum Brown says: "I identi-
fied no less than 500 fragmentary skulls and innumerable bones
referable to this genus" (*Triceratops*). The geological continuity
of their course is, however, incomplete, owing to the intervention of
marine deposits of considerable thickness, in which from the nature
of things few remains of land animals are found.

There are in the United States National Museum a pair of horn
cores (see pl. 3, upper figure) that were discovered in 1887 in the
suburbs of Denver, Colorado, by Prof. George I. Cannon, of the
Denver high schools. These were submitted to Prof. O. C. Marsh,
and he published a brief account of what he then supposed to be the
horns of an extinct buffalo, giving the specimen the name *Bison*
alticornis, and it was not until the discovery two years later of com-
plete skulls in Wyoming having similar horn cores that it was found
to be a large reptile instead of a bison. This error does not reflect
on the sagacity of Professor Marsh, for up to that time such extraor-
dinary creatures were unknown, and it was perfectly natural that

he should have been misled by their resemblance to the horn cores of some of the extinct buffaloes.

It appears that certain teeth and bones found first by Dr. F. V. Hayden on one of his expeditions to the West as early as 1855, and later discoveries by Prof. E. D. Cope in 1873 and 1876 were also ceratopsian reptiles, but the fragmentary parts found by the Philadelphia professor gave him no idea of what the creatures were like, though with his usual perception he recognized that they differed from any animals then known to science, and they were given the names *Agathaumas* and *Monoclonius*.

These were the first of a long series of discoveries leading down to the present day, which through scientific and popular descriptions have made the horned dinosaurs familiar to the world at large.

There are a great many different kinds of these horned dinosaurs. Most of them are known from skulls or parts of skulls, for the complete skeletal structure has been found only in the genus *Monoclonius*, and of their evolution and early history we know comparatively little as yet.

The most striking feature of the horned dinosaurs is the gigantic head armed with horns and a great bony crest or frill that projects backward over the neck. In *Triceratops*, the last of the race, the skull with its projecting frill sometimes attains a length of 8 feet in old individuals, with a pair of large horns that extend upward and forward from above the eyes, and a smaller horn on the nose. In *Monoclonius*, a geologically older genus, these horn conditions are exactly opposite, the single horn on the nose being the larger, the brow horns being short and rudimentary, the frill being pierced by large openings or "fenestra," as they are called. The examples mentioned represent in a way the two extremes for between them lie other genera intermediate in size and in the development of their horn cores and frill. There are small-horned and large-horned animals, some that have horns curving forward, others that bend backward, others that turn outward, and still others that stand erect. At this time we do not know whether these horns were found only on the males or whether they are the marks of distinct species.

Space permits the mention of only a few of the striking forms, for it is beyond the scope of the present article to describe all of the various kinds.

That the horned dinosaurs were fighters and often engaged in combat is shown by the healed wounds that are found in many skulls, broken horns, fractured and healed jaws, and pierced frills. A pair of horn cores of *Triceratops* in the National Museum bear witness to such an encounter; that the right horn was broken off in life is evident from the fact that the stump has rounded over and healed while the size of the other shows the animal to have reached a good old age.

The frill and horn cores of most of these animals were in life undoubtedly invested in a close-fitting covering of horny skin, as implied by the deep ramifying system of depressed channels on their outer surfaces for the transmission of blood vessels. The character of this covering was probably like that found on the horns of the horned toads, as shown in plate 6, figure on right, where the right-hand spike of the central pair has its outer horny covering still in place. It will also be observed that this sheath slightly increases the length of that horn as compared with its fellow of the opposite side, and it is presumed that the horn cores of the *Ceratopsia* would be similarly lengthened. Professor Lull¹ has observed on a young specimen in the Yale Museum "a layer of black powdery substance, a half inch in thickness, doubtless the carbonized remains of the actual horn, surrounding the base of the horn-core."

All of these animals were quadrupedal with short massive limbs, and broad elephantine feet that doubtless had the toes tipped with hoofs, a short, rounded, but broad-barreled body, with a short neck that was completely covered by the projecting frill of the skull. The tail for a dinosaur was comparatively short, though in life it probably dragged upon the ground.

The teeth form a single cutting row in each jaw, the lower closing inside the upper so that the wear is on a vertical plane, and in the process of opening and closing the mouth they act like the opposing blades of a pair of shears, the teeth functioning as the cutting organs. Their structure and arrangement indicate that these animals fed on herbage, probably the stems, branches, leaves, and twigs of shrubs and trees. This food gathered up by the efficient cropping beak, was passed back to the teeth there to be reduced into smaller bits and made suitable for reception into the stomach.

The eyes were set in deep thick-rimmed sockets, which look directly outward, thus evidently limiting the forward range of vision, but affording ample protection to these highly sensitive but necessary organs. It is now known from the completely preserved skeleton of *Monoclonius* (see pl. 2), that the eyeball was still further protected by a ring of bony sclerotic plates.

Although having such immense heads the brain is smaller in proportion to it than in any known vertebrate animal, being but little larger than a man's fist. The small size of this organ is graphically depicted in the accompanying illustration of a skull sectioned through the center of the brain cavity. (See pl. 3, lower figure.)

The preservation of anything that pertains to the soft anatomy of the horned dinosaurs was little expected, and yet within the past few years specimens have been discovered having considerable

¹ Proc. Seventh Internat. Zool. Cong., Boston, 1907, 1910, p. 3.

areas of the skin, or rather impressions of the skin, preserved. These show that the epidermal covering was made up of small nonimbricating scales that form definite patterns. At present not enough of the skin impressions are known to show how the patterns vary in the different genera, but no doubt continued explorations will result in the gradual accumulation of that knowledge, and who can say that within a few years from now the different kinds of horned dinosaurs may not be classified by the patterns of their skin coverings. The late Mr. L. M. Lambe was the first to recognize the impressions mentioned as being of the skin, in a specimen called *Chasmosaurus belli* in 1914. (See upper figure, pl. 4.) He wrote:

The natural impressions of the integument of *Protorosaurus* [*Chasmosaurus*] *belli* consist of smooth polygonal surfaces, ranging in diameter from about one-eighth of an inch up to $1\frac{1}{2}$ inches, indicative in the living animal of non-imbricating scales or plates, fitting close to each other, and having generally five or six sides. The plates themselves are not preserved but they have impressed their shape in the sandstone (molds) from which natural casts have been made by the matrix replacing the plates. * * * The impressions of the plates so far as seen are mostly from the trunk region in the neighborhood of the shoulder, where the increase in size seems to be from below upward. Other impressions from lower down on the body are of the small tubercles apparently indicating an absence here of the larger sizes of plates.²

A second specimen from the same fossil field on the Red Deer River, Canada, and now in the American Museum of Natural History, New York, has an area of the epidermal impressions overlying the lower end of the femur (thigh bone) (see pl. 4, lower figure), and Mr. Barnum Brown³ considers them typical of the genus *Monoclonius*. They consist of small polygonal tubercles and large tubercles, all low and of the same height.

The National Museum has the distinction of having the only mounted skeletons of *Triceratops* (see pl. 8), the largest member of the Ceratopsia, and also of *Brachyceratops*, the smallest horned dinosaur (see pl. 8) that has as yet been discovered. Whereas the skeleton of *Triceratops* measures nearly 20 feet in length and stands 8 feet high at the hips, the little *Brachyceratops* is only about $5\frac{1}{2}$ feet long and 27 inches high at the hips. The latter represents one of the earliest of the race, while *Triceratops* represents the latest or the culmination of this group before their final extermination. The skeletons mentioned above are composite, that is, made up of the bones of more than one individual, but in plate 2 is shown a skeleton of *Monoclonius* in the American Museum of Natural History, New York City, that is intermediate in size, and complete in all details,

² The area of skin impressions shown in the upper figure of plate 4 pertain to the same individual as described above, but these were not available to Mr. Lambe at the time of writing that description.

³ Bull. Amer. Mus. Nat. Hist., vol. 37, 1917, p. 305.

from the tip of the tail to the end of the nose, with most of the bones articulated in position. It was lying on its left side with the phalanges exposed and some of the bones were damaged, but parts of all were present. Part of the skeleton was surrounded by sandstone and ironstone matrix of such nature that much of the scientific value of the skeleton would have been sacrificed by extracting it for a free mount. Consequently, the skeleton has been worked out in relief and mounted as a panel. This is probably the most perfect example of a Dinosaur skeleton that has ever been found.

The evolution of the ceratopsian dinosaurs, so far as we know it, consisted in an increase in size, the development and perfection of the bony frill, retrogression of the large nasal horn and reciprocal increase in length of those borne above the eyes, until in the latest types they have attained tremendous proportions. (Compare figures 1 and 3, plate 7.)

Could the collectors of these specimens be induced to tell of the privations endured, the difficulties encountered, and the obstacles overcome in securing the remains of these huge reptiles, it would form a most interesting chapter of North American vertebrate paleontology.

The collection of dinosaur bones nearly always involves much hard, back-breaking labor, and especially the collection of the large skulls of the Ceratopsia. This work oftentimes involves the tedious task of chiseling the specimen out of the solid sandstone (see pl. 5, upper figure); the bandaging of the fossil in a plaster of paris jacket (see pl. 5, lower figure) in order to keep the broken pieces of bone in their proper places as well as to protect the specimen from damage while in transit to the museum laboratory. It also involves the handling, often by primitive methods, of these heavy masses of bone and rock; the lowering down from precipitous places in order to reach a level where they can be loaded on to wagons; and the building of roads through the roughest of rough country, that they may be gotten out of the bad lands and to the nearest railroad, sometimes as far as 150 miles away.

The late J. B. Hatcher brought to light by far the greater number of the known *Triceratops* specimens, comprising some 40 or more skulls and partial skeletons, all from the now famous Lance Creek locality in eastern Wyoming. One large skull collected by him, inclosed in a concretionary mass of rock, when received at the Yale Museum was found to weigh 6,850 pounds, and this great weight had to be transported by wagon for nearly 40 miles through a country which at that time was practically roadless.

Though many different kinds of horned dinosaurs have been discovered, it remained for the veteran collector of fossils Mr. Charles

H. Sternberg to find in the Upper Cretaceous rocks of Alberta, Canada, the most ornate head of one of these animals that has yet been brought to light. The skull of *Styracosaurus*, as this specimen has been called, is over 6 feet long, with a great horn above the center of the nose that is nearly 20 inches high and 6 inches in diameter at the base. Most striking, however, is the development of the six horn cores that radiate from the rim of the frill, as shown in plate 6, left-hand figure, a top view of the head, which at its widest part measures $4\frac{1}{2}$ feet across. The name *Styracosaurus* is in allusion to these spikelike horns, which must have made this reptile a veritable moving *chevaux de frise*.

Among the laity there is the mistaken notion that extinct animals and especially the dinosaurs have a corner on all that is unusual in size and peculiar in form. In size, some of the extinct reptiles, as *Brontosaurus* and *Brachysaurus*, were the largest land animals the world has ever known, though in bulk probably none exceeded the present-day whales. In the matter of appearance it must be borne in mind that many of the striking peculiarities of the extinct forms is enhanced by their great size, and that is especially true of *Styracosaurus*, for when contrasted with the skull of the common horned toad (*Phrynosoma*), which by the way is not a toad at all, but a lizard, a startling resemblance is found in the hornlike decorations of their skulls. Though in size the *Styracosaurus* skull is 72 times as long as the horned toad, when the latter is enlarged to the same size as the fossil it appears quite as bizarre as the extinct reptile. (See pl. 6.) Again in the dwarf chameleon (*Chameleo owenii*) from the Kamerun of Africa, a small living reptile possibly 8 inches in length, we find a resemblance to the large-headed *Triceratops*. It has not only a fairly perfect backwardly projecting frill, but three horns as well, one on the nose and a pair above the eyes, as shown in the accompanying illustration, plate 7. (Compare figs. 1 and 2.)

The ceratopsians made many attempts to perfect their skeletal organization in order to bring it into harmony with their changing surroundings, and it seems a pity they should have been so suddenly exterminated, but all things have their day, even the horned dinosaurs.

EXPLANATION OF PLATES.

PLATE 1.

Restoration of *Triceratops*. Duck-billed dinosaurs in the distance. This picture also depicts the low, swampy character of the country at the time these animals lived. From a painting by Charles R. Knight. After Hatcher.

PLATE 2.

Skeleton of the horned dinosaur (*Monoclonius*), from the Belly River formation, Upper Cretaceous, of Alberta, Canada. Shown as now exhibited in the

American Museum of Natural History, New York City. This is the most perfect skeleton of a horned dinosaur that has yet been discovered. About $\frac{2}{3}$ natural size. After Brown.

PLATE 3.

Upper: Horn cores of *Triceratops alticornis* (Marsh), found in the Denver formation, Upper Cretaceous, near Denver, Colorado, in 1887. Cat. No. 4739, U. S. N. M. About $\frac{1}{2}$ natural size.

Lower: Longitudinal section through a skull of *Triceratops* to show the very small size of the brain case, as indicated by the white area near the center of the picture. Cat. No. 5740, U. S. N. M.

PLATE 4.

Upper: Impressions of the skin overlying the hip bone and the upper portion of the articulated thigh bone (femur) of the right side. The lower part of the femur lies exposed to view at the left of the rule. The bone to be observed on the extreme left of the picture is the ischium, one of the pelvic bones. Photograph reproduced through the courtesy of the Geological Survey of Canada. Photo by Charles M. Sternberg.

Lower: Impressions of the skin overlying the right femur of a specimen of *Monoclonius* in the American Museum of Natural History, New York City. After Brown.

Both of the above specimens are from the Belly River formation, Upper Cretaceous, as exposed along the Red Deer River, Alberta, Canada. A region now famous for the remarkable preservation of the dinosaurian specimens found there.

PLATE 5.

Upper: Skull of a *Triceratops* shown partially chiseled out of a sandstone cliff in eastern Wyoming. Photograph by Charles H. Sternberg.

Lower: Skull of *Triceratops*, excavated and swathed in plaster-of-Paris bandages and now ready for boxing. Collected on Hell Creek, Montana, by Mr. Barnum Brown. Photograph reproduced through the courtesy of the American Museum of Natural History.

PLATE 6.

A comparison of the skull of a horned dinosaur, *Styracosaurus* (left), and the skull of a horned toad (right). Both viewed from above. The *Styracosaurus* skull measures 6 feet, the horned toad skull 1 inch in length. Photograph of *Styracosaurus* after Lambe.

PLATE 7.

FIG. 1.—Skull of *Triceratops prorsus* Marsh. Cat. No. 2100 U. S. N. M. About $\frac{1}{8}$ natural size.

FIG. 2.—Head of *Chameleo owenii* from South Africa. A living lizard that has a fairly perfect crest or frill and three horns, placed precisely as in *Triceratops*. Adapted from Metcalf. After Lull.

FIG. 3.—Skull of *Monoclonius*, one of the earliest known forms of the horned dinosauria, showing the large openings or fenestra in the frill, the small horns above the eyes, and the large forwardly curved horn on the nose. About $\frac{1}{3}$ natural size. After Lambe.

PLATE 8.

Mounted skeletons of the largest (*Triceratops*) and the smallest (*Brachyceratops*) known members of the horned dinosauria, shown as now exhibited in the United States National Museum. About $\frac{1}{7}$ natural size.





RESTORATION OF TRICERATOPS.
From a painting by Charles R. Knight.

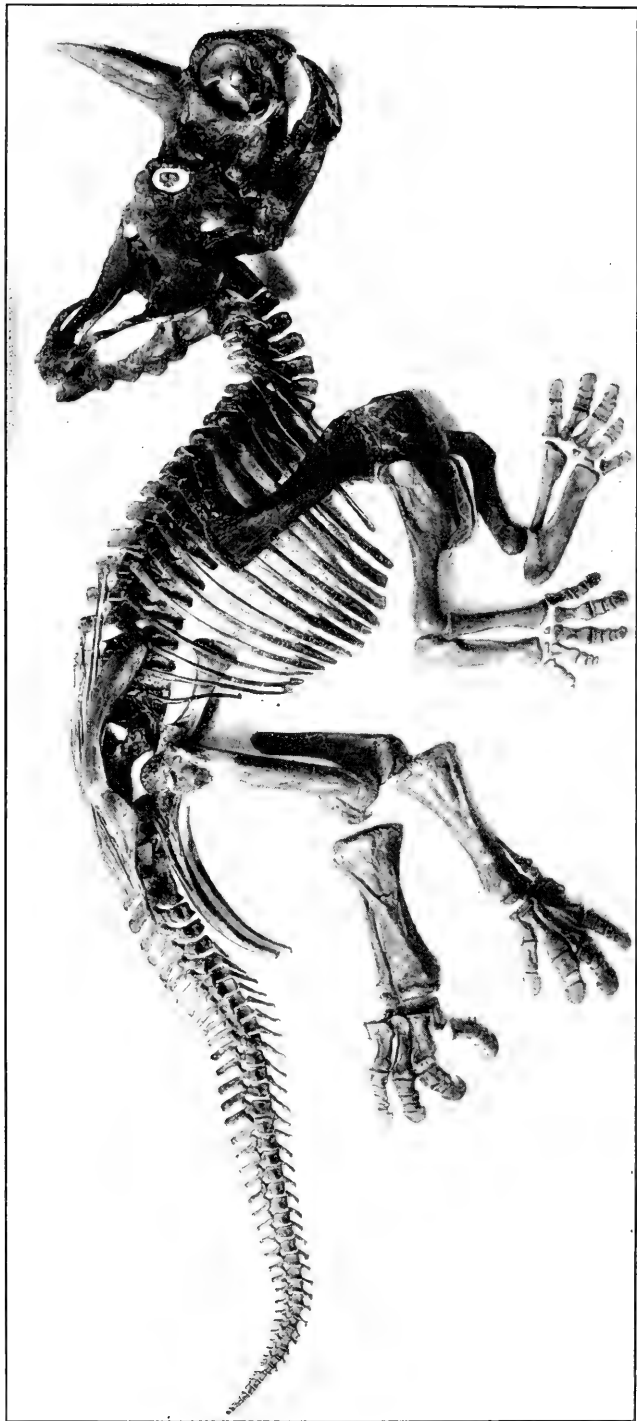

SKELETON OF MONOCLONIUS NASICORNIS BROWN.



HORN-CORES OF TRICERATOPS (BISON) ATTICORNIS (MARSH).



SECTIONED TRICERATOPS SKULL.

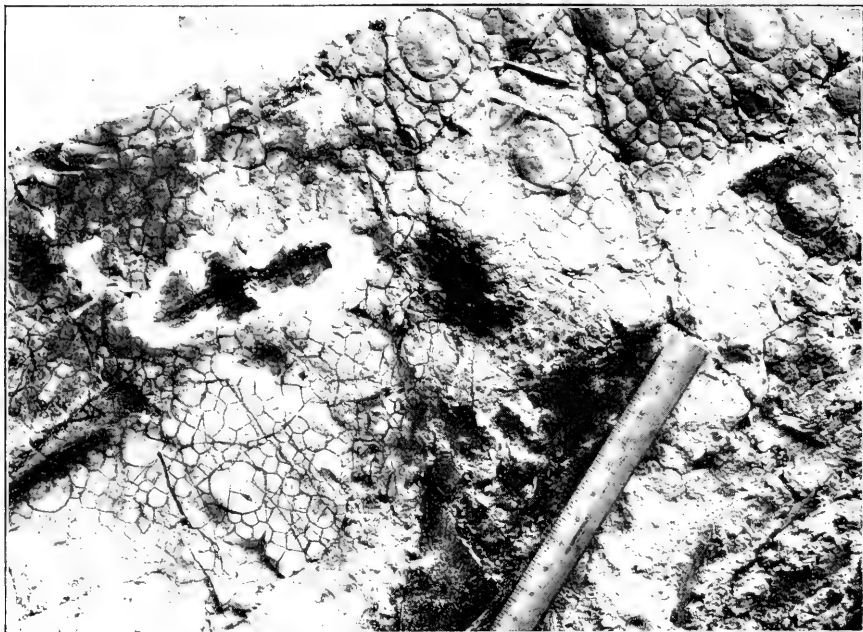

SKIN IMPRESSIONS OF CHASMO SAURUS.

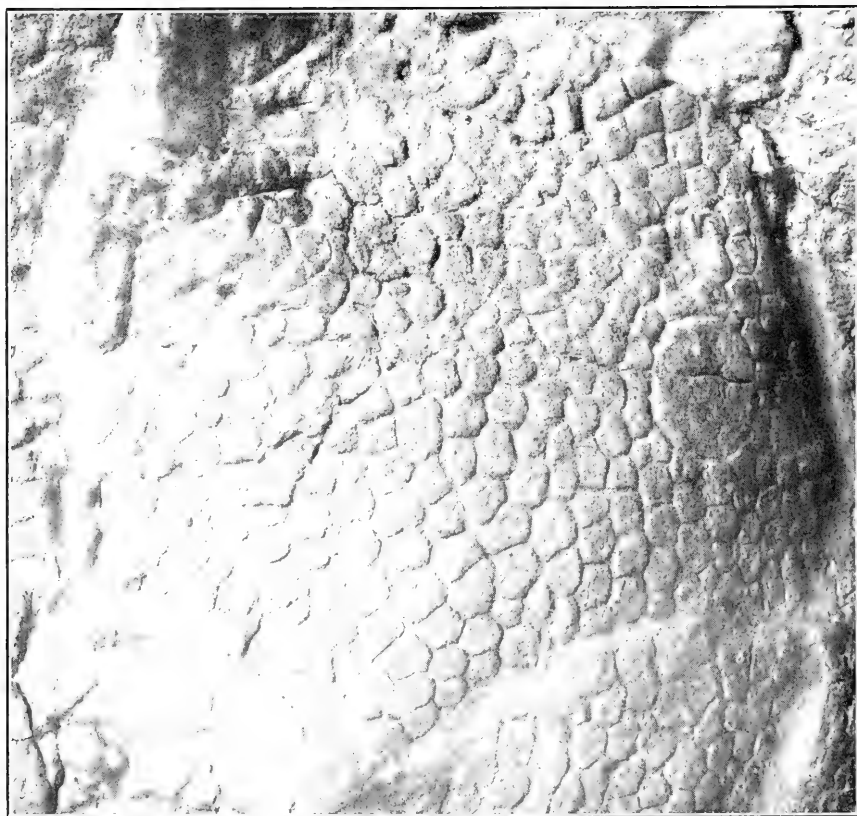

SKIN IMPRESSIONS OF MONOCLONIUS.



SKULL OF TRICERATOPS IN SANDSTONE CLIFF, WYOMING.



SKULL OF TRICERATOPS, EXCAVATED AND READY FOR SHIPMENT, MONTANA.





SKULL OF TRICERATOPS.

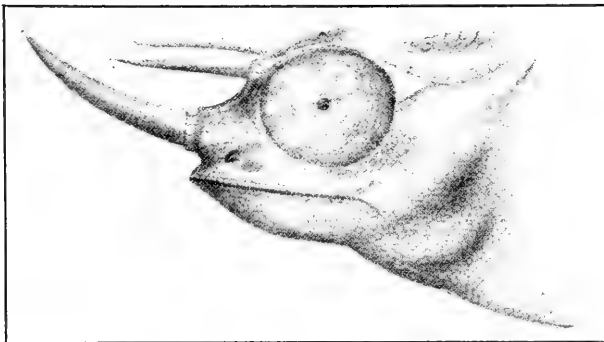

HEAD OF CHAMELEO.

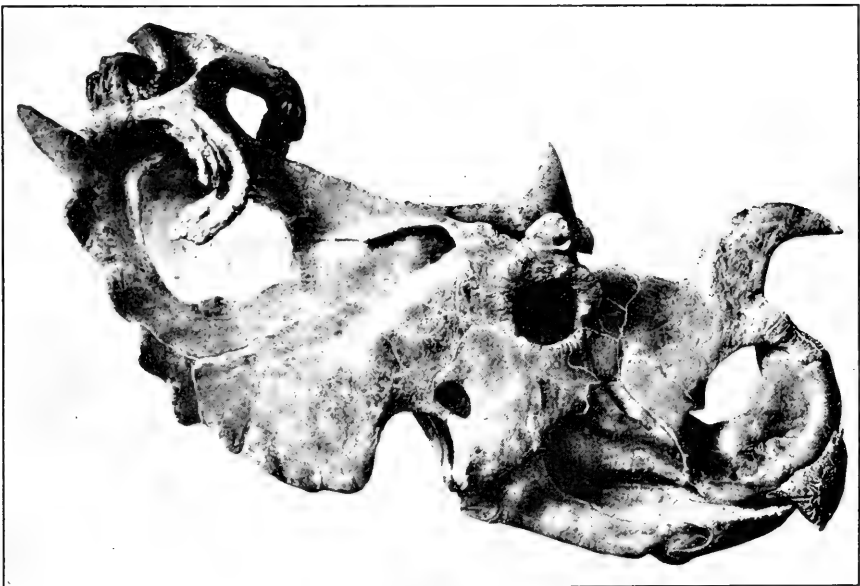

SKULL OF MONOCLONIUS.

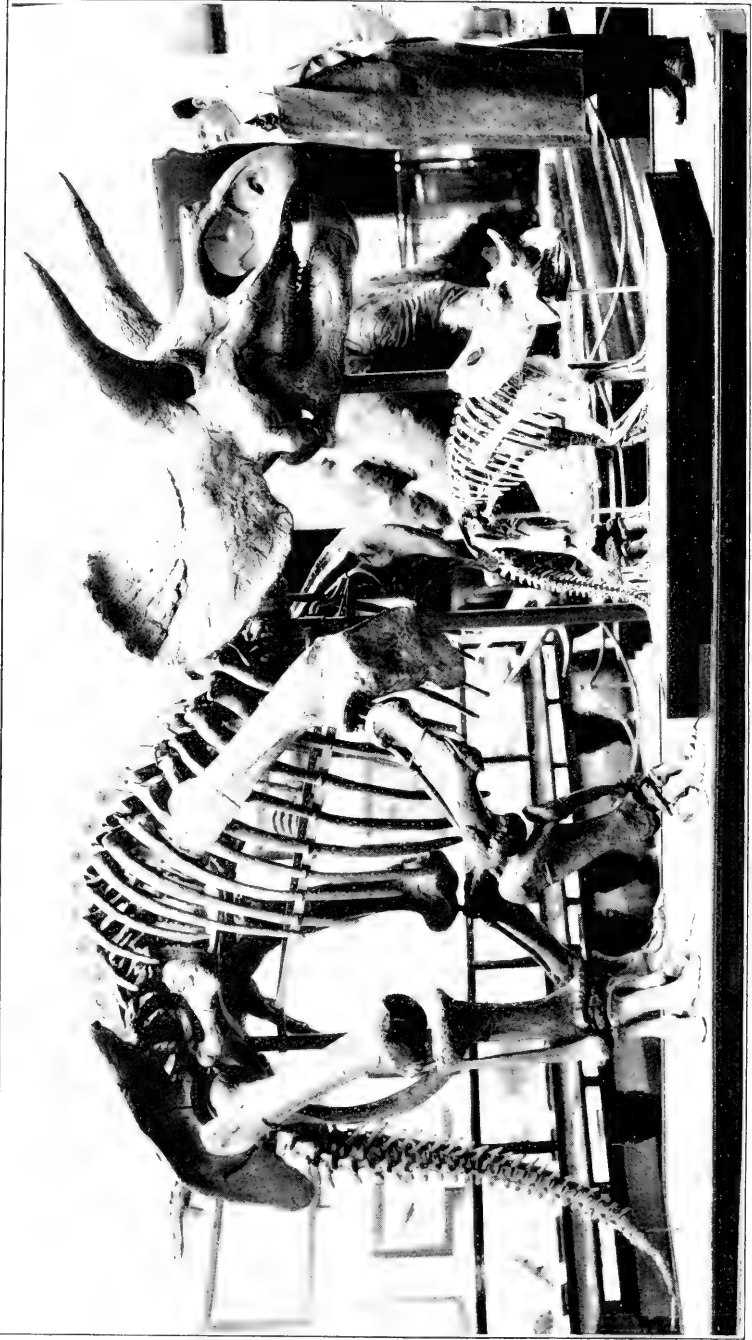

MOUNTED SKELETONS OF TRICERATOPS AND BRACHYCERATOPS.

RHYTHM IN NATURE.¹

By F. W. FLATTELY,

Senior Assistant in Zoology, University, Aberdeen.

That so many phenomena in nature should be of a recurrent or periodic type is not surprising when we consider that the earth on which we live forms part of a rhythmic universe. From the biological point of view, however—and it is with the biological aspects of rhythm that the writer is concerned—these phenomena, though possibly all of the same nature fundamentally, must, for practical purposes, be regarded as of two distinct kinds.

We have, in the first place, the numerous cases of periodic behavior in response to, or imposed by, external factors of a cosmic nature, such as the alternation of night and day, the regular and ever-recurring sequence of the seasons, the ebb and flow of the tides, and so on. Here the mainspring of the rhythm is obviously external. In contrast to this, however, are the cases of the second type in which the rhythm is not dependent on the environment, but is of an intrinsic or vital nature, and corresponds to something inherent in the organism.

The periodicities of this latter type may all be regarded as identical except as regards the time factor. They are of the nature of *age cycles*.

In temperate countries, where the difference between the seasons is very marked, the periodical phenomena of plants and animals take place at about the same time in all species. With us, in consequence, the seasons have come to typify the chief stages in the life cycle of plants and animals. Notwithstanding this, the phenomenon of an age cycle must be regarded as something intrinsic in the organism and not merely as the result of environment, the synchronizing of the stages of the age cycle with the seasons being of a secondary nature. "In Europe," says Bates,² "a woodland scene has its spring, its summer, its autumnal aspects. In the equatorial forests the aspect is the same or nearly so every day in the year; budding, flowering, fruiting, and leaf-shedding are always going on in one species or other."

¹ Reprinted by permission from *Science Progress*, vol. 14, No. 55, January, 1920.

² Bates, H. W., *The Naturalist on the Amazons*.

The activity of birds and insects proceeds without interruption, each species having its own separate time; the colonies of wasps, for instance, do not die off annually, leaving only the queens, as in cold climates; but the succession of generations and colonies goes on incessantly. It is never either spring, summer, or autumn, but each day is a combination of all three."

The age cycle, with its sequence of birth, growth, maturity, decay, and death, is the most typical and most inevitable phenomenon in nature. It is not only the normal sequence in the organism as a whole, but the phenomena of senescence and rejuvenescence are continually being repeated *within* the organism. These internal periodicities are of essentially the same character as the age cycle of the organism, except as regards the time factor. "In cells," says Child,³ "where function is accompanied by extensive accumulation and discharge of substances, such, for example, as the gland cells, storage cells, etc., the cycles of activity and morphological change are essentially age cycles—that is to say, the period of loading of the cell is a period of decreasing metabolic activity, of senescence, and the period of discharge one of increasing activity, of rejuvenescence, which makes possible a repetition of the cycle." In the pancreas of the toad, for example, the cells, when ready to secrete, are loaded with granules, and in this condition are only very slightly active metabolically. As the cell secretion is discharged, the granules gradually disappear to a point when they are practically absent. In this condition, the cell is again capable of a high rate of metabolic activity; if nutrition is present, the process of loading occurs once more. This cycle of changes, which may occur within a few hours, and which may be repeated within a single cell, Child believes, is not fundamentally different from the age cycle of organisms. It exhibits all the essential features, up to a certain point, of senescence and rejuvenescence. The cell undergoes changes similar to those of the age cycle, though their period is short. At the same time, as Child says, the gland cell may be undergoing senescence in the stricter sense—that is to say, changes in the more stable framework of the protoplasm may be occurring which are not wholly compensated by the functional cycle.

According to Benjamin Moore,⁴ the living cell may be regarded, from the physico-chemical point of view, as a peculiar energy transformer: Chemical energy in the living cell being converted by the colloidal structure into biotic energy, this latter being convertible into mechanical energy, electrical energy, heat energy, or chemical energy. Like all energy transformers, living cells have their phasic

³ Child, C. M., *Senescence and Rejuvenescence*, University of Chicago Press, 1915.

⁴ Benjamin Moore, *The Origin and Nature of Life*, London, Williams & Norgate, 1912.

periods or revolution time in which they pass through a cycle or oscillation, the period varying from one type of cell to another.

The contraction of the heart is an example of a vital rhythm which can escape nobody. The series of movements taking place in the heart during one complete beat constitutes what is known as a "cardiac cycle." This, again, is essentially an age cycle, although the rapid recovery after fatigue tends to obscure its real nature. Disregarding the immediate causes underlying the repetition of the cycle, the point to notice is that rhythm is associated with efficiency. The rhythmic method represents the best means of accomplishing a purpose, and may, in fact, be regarded as an evolutionary goal toward which all life processes are tending. To take a concrete example: It is certain that the circulation in vertebrates is both a more orderly and a more efficient process than the flow of blood in an animal, let us say, like an earthworm. The correctness of this view of coupling rhythm with efficiency is supported by the phenomenon of the disordered and arrhythmical action of the heart and lungs in disease. The loud "bourdon" of the engines at a power station conveys a most distinctly rhythmic impression, and a practiced ear can readily detect the smallest of functional troubles by the modification of the normal rhythmic note.

We now turn to cases of periodicity of the external type.

It is well known that not a few diseases, particularly those like malaria, produce markedly periodic symptoms. It is an interesting fact, however, that not only does the malarial parasite itself show regular development cycles within the organism, but the mosquito, the carrier of the parasite, is markedly periodic in its habits. Some interesting observations have been made on the flight of the mosquito in the course of the construction of the Panama Canal.⁵ Gatun, about 7 miles south of Colon, is one of the largest settlements in the Canal Zone. Between January and March, 1913, more mosquitoes were found there than in any settlement since the beginning of work on the canal. The weekly catch of *Anopheles* was from 7,000 to 20,000. Just to the south of Gatun is a lake which seemed a likely breeding ground for mosquitoes, but it was soon found that they did not have their origin here. To the west of Gatun, across a part of the old French canal, there was some flat land into which sea water and mud from the American canal were being pumped. This land was so located that, to reach the settlement, adult mosquitoes would have to fly from half a mile to a mile across, or at right angles to, the stiff breezes which prevail at Gatun. It was eventually discovered "that a regular purposive flight of mosquitoes toward the town took

⁵ Le Prince, J. A., and Orenstein, A. J., *Mosquito Control in Panama*, London, Putnam, 1916.

place in the evenings before nightfall from 6.30 to 7 p. m. After dark the flight was reduced to practically nothing. During the period of flight, the observers were bitten continuously. After the flight ceased, the observers were bitten only once or twice in an hour's time. A return flight began at 6 a. m. and took place with extraordinary rapidity. As daylight became stronger, the speed of the returning *Anopheles* increased. The termination of both forward and return flights was remarkably abrupt. One observer said the flight stopped with almost mechanical precision when there was too much daylight or too much darkness."

Willey⁶ records an interesting example of periodic habit occurring among crows and so-called "flying foxes" (really fruit-eating bats) on the coast of Ceylon. At one place, a small lighthouse islet off the coast of Ceylon, they congregate in the palm trees alternately by night and by day. "At sundown," says Willey, "the passage of immense flocks of crows and flying foxes in opposite directions across the strait which divides the island from the mainland can be witnessed, the former bound for the island to rest for the night, the latter speeding their way to the mainland intent upon their nocturnal forage. * * * The reverse passage—namely, the matutinal flight—takes place toward sunrise, the bats returning from the mainland to rest for the day suspended in rows from the midribs of the palm leaves, the crows crossing over on their daily quest for garbage." As a result of these markedly periodic habits, the two classes of animals are able to make their homes in the same trees without in the slightest degree interfering with each other.

The effect of external periodicities on the organism and its behavior is nowhere better seen than on the seashore. The case of *Convoluta roscoffensis* is perhaps too familiar to need much description. *Convoluta roscoffensis* is a minute, elongated flatworm covered with cilia, and containing green algal cells living with it symbiotically. Its habitat is a narrow strip of sandy beach on the coasts of Normandy and Brittany situated at the level reached by high water at the slackest of neap-tides. Though of very small size, the worms occur in such enormous numbers as to form at low tide great patches of green scum. As the tide laps the edges of the colony the green patches disappear, the worms remaining beneath the surface till the next ebb tide. Twice during 24 hours the zone occupied by the colonies is submerged and the animals live in darkness underground, and twice the zone is uncovered and the animals rise to the surface. The burrowing reaction is due to the necessity of avoiding extermination by wave-shock, the upward movement is determined by the presence of the algal cells and their light requirements. The egg-

⁶ Willey, A., *Convergence in Evolution*, London, Murray, 1911.

laying of *Convoluta roscoffensis* is also periodic, and is related in a remarkable way to the rhythm of the tides. Egg-laying begins with the onset of the spring tides and continues for a week. The reason for this is as follows: In the summer, the time of year when these observations were made, the low-water of spring tides at Roscoff occurs about midday and midnight.⁷ When, however, the zone occupied by the *Convolutas* is uncovered during the nighttime, the animals in the absence of light do not rise to the surface. Hence, during the spring tides, the worm has an uninterrupted period of some 18 hours in which to lay its eggs. Experiments in the laboratory have shown that egg-laying reaches its maximum when the animals are not obliged to come to the surface twice in 24 hours—that is to say, when they can have the longest possible spell of darkness; in other words, the conditions most favorable to egg-laying occur when the moon is full or new—a remarkable example of the effect of the tides on the habits of shore animals.

Shore animals like the common periwinkle, for instance, are submitted to a double periodic influence—the rhythmic ebb and flow of the sea and the alternation of day and night. The existence of periwinkles comprises regularly alternating periods of active life in the water or moist air (at high tides) and periods of suspended animation within their shells. This constant reaction to the tidal rhythm is not without a profound influence on the functions of the organism. For instance, inert periwinkles, even in a dry environment, can be reactivated by shaking; but, according to Bohn, the reactivation occurs much more readily at certain times and hours. Bohn⁸ states that if a collection of these mollusks has been isolated for a certain length of time in a laboratory, it is easily demonstrated that, at periods of low tide, one has to shake much longer to produce the reactivation than when the tide is high. That is to say, the periods of inertia in the laboratory correspond to the periods of desiccation on the shore.

The impress of the external rhythm on the organism is, of course, not permanent, but becomes gradually weaker with the passage of time. Numerous similar cases occur, both in plants and animals, but the above are sufficient for our purpose.

It is common knowledge that in many animals the color is not fixed, but varies according to the hue of their surroundings. This power of color change has been investigated most minutely in the case of the *Æsop* prawn (*Hippolyte varians*).⁹ The color of this

⁷ Keeble, F., *Plant Animals*, Cambridge, University Press, 1910.

⁸ Bohn, Georges, Institut Psychologique, Travail du Groupe d'Étude de Psychologie zoologique. Mémoire I: Attractions et Oscillations des Animaux marins sous l'influence de la lumière, Paris, 1905.

⁹ Keeble, F., and Gamble, F. W., *Phil. Trans. Roy. Soc.*, B. vol. cxvii, London, 1904.

crustacean is extremely variable, the change in coloration being brought about by the expansion or contraction of masses of pigment. The cells in which the pigment is situated are very irregular in form, with branched processes. On appropriate stimulation, the pigment flows out along these branching spaces in such a way that what was a mere pin point of pigment becomes spread out over a wide surface. The result is a change in coloration. The *Æsop* prawn owes its color to three pigments—red, yellow, and blue. In the daytime the many changes of color in response to varying surroundings are due entirely to the red and yellow pigments. At nightfall the color of Hippolyte, whatever it may happen to be at the time, changes to a transparent azure blue, this blue color being replaced at daybreak by the prawn's diurnal tint. The *Æsop* prawn thus exhibits rhythmic color change corresponding to the transition from light to darkness and vice versa.

So far the cases we have been considering of rhythmical behavior are all of a clear-cut and simple kind, being directly due to the succession of the seasons, the regular alternation of night and day, the ebb and flow of the tides, etc.; moreover, the nature of these latter phenomena is also well understood. On the other hand, the causes underlying the now well-established cyclical changes of climate are not only themselves decidedly more complex, but there is still a great deal to be learned about their effects in relation both to animals and mankind.

The first type of climatic change and the best known is that of the glacial period. It is now known that the glacial period was not a continuous period of intense cold, but was punctuated by epochs in which the weather was much warmer, and when the retreat of the ice sheet allowed many animals and plants to regain, temporarily at any rate, the ground they had been obliged to cede. These fluctuations of climate are believed to have affected the whole world simultaneously, and it is certain that the whole of the Northern Hemisphere was affected.

The second type of climatic change is less familiar, having been only recently established. Brückner, Clough, and others consider that the whole world passes through a climatic cycle once in every 36 years. At one end of the cycle the climate of continental regions for a period of years is unusually cold and wet, with relatively frequent storms; at the other the climate is warmer and drier, with high barometric pressure and few storms. The extremes of low temperature are ascribed, somewhat paradoxically it may seem, to periods of maximum solar activity as shown by the number of sun spots and the rapidity with which they are formed.

The Swedish hydrographer, Petersson, has published data showing the importance of these climatic cycles to the study of hydro-

graphy, and thence to the study of fish migrations.¹⁰ Increased solar activity results in oceanic circulation being more intense. As a result of this, the Baltic, the water of which is normally distinctly brackish, receives a greater quantity of salt water from the Atlantic. Owing to the increased oceanic circulation outside, large quantities of water are pumped into the Baltic through the narrow neck between the Skagerrak and the Kattegat. As a result of the increased salinity of the Baltic, the herring shoals are enabled to extend their migrations to this sea, which is normally closed to them owing to their intolerance of water with a low-salt content. The times of the appearance of herring in the Baltic thus correspond to the periods of increased solar activity; in other words, the appearance of herring in the Baltic is a regularly periodic phenomenon.

A recent American expedition to Turkestan has brought to light regular cycles of wet and dry climate in this region.¹¹ One of the most convincing pieces of evidence of these climatic cycles is furnished by the changes of level which can be traced in the waters of the Lop Nor Basin, a huge inclosed area about three times as large as the British Isles, situated in the heart of the Asiatic Continent. The periods of drought result in periods of famine which cause the nomadic races, which live on lands too dry for agriculture, to migrate and so come into conflict with the peoples of more favored regions. The wave so started, say in the center of Asia, propagates itself in ever-widening ripples, the most remote of which may even be the cause of a commercial crisis as far away as the United States. Anyone who has lived for a few years in southern Italy can not fail to marvel how the old Romans could ever have achieved so much if the climatic conditions were as enervating as they are now. But evidence is forthcoming to show that such was not the case.

The historian, Gibbon,¹² mentions two remarkable facts which tend to show that the climate of Europe in Roman imperial times was much colder than it is now. The Rhine and the Danube were frequently frozen over and capable of supporting the most enormous weights, a thing unparalleled in modern times. In the time of Cæsar, the reindeer, now confined to the area around the poles, was a native of the Hercynian Forest which then covered a great part of Germany and Poland. To quote Mr. Huntington:

Apparently the climate of the earth is subject to pulsations of very diverse degrees of intensity and of varying length. The glacial period as a whole represents the largest type of pulsation; upon it are superposed the great pulsations known as glacial epochs, each with a length measured probably in tens of thousands of years; their steady progress is in turn interrupted by smaller

¹⁰ Petersson, Otto, *Der Fischerbote*, III, Nr 7, 8, 9, Hamburg, 1911.

¹¹ Ellsworth Huntington, *The Pulse of Asia*, London, Constable, 1907.

¹² Gibbon, E., *Decline and Fall of the Roman Empire*, Chap. I.

changes of climate such as those of which evidence has been found during historic times in central Asia; and, finally, the climate of the world pulsates in cycles of 36 years.

In spite of the undoubted influence of climate, it would seem that the growth and decay of successive civilizations is in great part a biological phenomenon analogous to the age cycles referred to above, although the matter is evidently far too complex to allow one to generalize with safety.

According to Prof. Flinders Petrie,¹³ as quoted by Spurrell,¹⁴ "there have been eight distinct periods of civilization in Europe, from the earliest dawn of civilization in Egypt, the duration of each period tending to be longer than its predecessor; and the intervals are marked by an inrush of barbarian races and an interlude of destruction and admixture of blood." Professor Petrie finds his analysis of civilization on sculpture, on the grounds that sculpture is available over so long a period and is so easily presented to the mind. In the sculpture of every period can be seen the same sequence of growth and decay. The archaic stage, in spite of crudity, is invariably marked by boldness and vigor. Next, the treatment loses its archaic character and becomes more free, the details being more skillfully subordinated to the whole. From this point the period of highest achievement is soon reached; all traces of archaism have disappeared, inspiration is still powerful, and workmanship well-nigh, sometimes entirely, perfect. After this the treatment tends to become over-elaborate, the inspiration is lost, and a period of unintelligent copying ensues, followed by one of degradation and ultimate decay.

Civilization is an intermittent phenomenon, its growth and fall being comparable to summer and winter in nature. Professor Petrie shows how this analogy was familiar to the ancients under the guise of the "great year," the Etruscans speaking of the great year as the period of each race of men that should arise in succession. He makes the following quotation from Plutarch's *Life of Sulla*, which refers to the close of the Etruscans' own period of 1,100 years, in 87 B. C.:

One day, when the sky was serene and clear, there was heard in it the sounds of a trumpet, so shrill and mournful that it frightened and astonished the whole city. The Tuscan sages said that it portended a new race of men, and a renovation of the world, for they observed that there were eight several kinds of men, all differing in life and manners; that Heaven had allotted to each its time, which was limited by the circuit of the great year; and that when one race came to a period, and another was rising, it was announced by some wonderful sign from either earth or heaven. So that it was evident at

¹³ Flinders Petrie, W. M., *The Revolution of Civilization*, London, Harper, 1912.

¹⁴ Spurrell, H. G. F., *Modern Man and His Forerunner*, London, Bell, 1918.

once to those who attended to these things, and were versed in them, that a different sort of man was come into the world, with other manners and customs, and more or less the care of the gods than those who had preceded them. * * * Such was the mythology of the most learned and respectable of the Tuscan soothsayers.

From the foregoing examples it becomes evident that life, in its main aspects, is essentially a rhythmic phenomenon. The essence of rhythm being order, it seems, indeed, inevitable that, with the progress of time, all biological phenomena of importance, whether concerned with the inner functioning of the organism or with its behavior in relation to the outside world, should tend to become increasingly rhythmic in character.

Finally, it should be evident that the sense of rhythm, which forms so large a part of the pleasure conveyed by all the higher forms of art, results from the successful expression by man of his appreciation of the order and measured flow so characteristic of his own nature and of the world about him.

PARASITISM AND SYMBIOSIS IN THEIR RELATION TO THE PROBLEM OF EVOLUTION.¹

By MAURICE CAULLERY.

[Translated, with permission, by Gerrit S. Miller, jr., from *Revue Scientifique*, 1919, pp. 737-745.]

Everyone is now clearly aware of the critical phase that the problem of transformism is passing through, a phase which F. le Dantec called attention to in 1909 in the title of one of his books: *La Crise du Transformisme*. This crisis, although very real, is certainly nothing more than a crisis of growth. For my part I shall not try to meet it, as Le Dantec does, by the affirmation of an uncompromising Lamarckism. And I shall recognize that Lamarckism and Darwinism, the great partially seen solutions of the problem, in which more than a generation of naturalists had faith, are now insufficient, at least in their orthodox form. All nature forces upon our minds, and the more strongly the better it becomes known, the conviction that organisms have evolved, that they have passed through many stages in order to become the species of which we find the fossil remains or which are now living before our eyes. But it must be recognized that we do not know at present what have been the essential factors of this evolution. All attempts thus far made to prove in an exact manner by the experimental method the real transformational power of natural selection or of the inheritance of acquired characters have led to nothing but very meager results. And in presence of these results the experimental study of heredity and variation, pursued so actively and so fruitfully since the beginning of the twentieth century, leads, at least tentatively, to conclusions which do not harmonize very well with Darwinism and Lamarckism. It is true that they themselves lead, at least in their most extreme form, to strange paradoxes such as Bateson brought forward in 1914. (Presidential address, British Association for the Advancement of Science, Australian meeting, 1914.) It is also true that the hypotheses best established in science, such as universal gravitation or the principles of electromagnetism, finally encounter in our minds difficulties which temporarily hold us in check.

¹ This article was the inaugural lecture of a course which was given at the Sorbonne in Paris, and which has since been published *in extenso* in a book, "Le Parasitisme et la Symbiose" (*Encyclopédie Scientifique*, Doin, éditeur), Paris, 1921.

But as regards organisms, the conformity of their structure to the conditions under which they live, their adaptation in other words, a fact everywhere seen in nature and forcibly expressed by the structure of organized beings, can not be explained, with the fine simplicity which Lamarck imagined, by the direct action of the ambient medium in modeling the organism, precisely because of the organism's own activity. It seems rather that the organism when it varies reacts, in a manner which is peculiar to it and which results from its constitution, to the most varied factors which can attract it, and that it passes, either continuously or discontinuously, through a series of forms tending toward a fixed limit. Eimer has expressed this by the word "orthogenesis," and the idea is taking a larger and larger place in biology. Thus a branch of ungulates sprung from some ancestor analogous to *Phenacodus* has terminated in the horses; thus from *Palaeomastodon* has gradually come the elephant type. At present we have more and more numerous examples of series of this kind. The environment could at most have had only an indirect action on this unfolding process, which is the essence of evolution, hurrying it or retarding it, or perhaps accomplishing a certain amount of elimination.

Under the influence of these conceptions we see reappearing, among biologists who are firm supporters of evolution, conceptions that are related to those which were brought up in opposition to Darwinism at its origin. Thus Mr. D. Rosa has recently published, under the title "Hologenesi" (Ologenesi, Nuova teoria dell' Evoluzione, etc., Florence, 1917), a theory in which he practically returns to ideas nearly related to those of Naegeli, and in which he attributes the whole of evolution to the play of internal factors of the constitution of organisms.

If adaptation is not necessarily a direct and normal effect of the action of the environment on organisms, we are led to conclude that it results secondarily from the choice on the part of organisms of a mode of life which is appropriate to their preexisting constitution. This is called by Mr. Cuénot preadaptation. The idea, however, is not new. Darwin had difficulty in understanding how selection had been able to bring about the perfection of the tongue of the woodpeckers, so marvelously adapted to searching for insects in the bark of trees. But Buffon, one of the precursors of the transformist ideas, when describing the habits of these birds, concluded, as Bateson reminds us: "Such is the narrow and rude instinct of a bird limited to a life of hardship and difficulty. It has received from nature organs and instruments appropriate to this destiny, or rather it has this very destiny on account of the organs that it is born with." Here the organ would create the function inversely to the Lamarckian aphorism.

But even if this explanation would fit certain cases, as might be suggested by present experimental research on heredity, we hesitate to admit its general applicability, in view of the mass of adaptive arrangements which exist in nature, and especially in view of the graduated series presented by these arrangements. Can a harmony so exactly coordinated with the environment exist unless the environment has had something to do with bringing it about? Can such a general fact be due to a mere series of coincidences between environment on the one hand and on the other the special constitution of organisms as well as the necessary laws of their transformations; setting aside naturally all teleological and creationistic ideas?

We hesitate still more, because we see that the reaction of the individual to the environment is in large measure adaptive; the transformations of the plant passing from the plain to the mountain, or, inversely, are proof of it. But these modifications do not show themselves to be hereditary. Perhaps the solution of the difficulty lies in the general indications which paleontology give us. The different types have not varied in time in a uniform and permanent manner. Each seems to have had its period of variability. At this period were the hereditary variations really independent of the environment, as we see them to-day in organisms which are perhaps in a phase of stability, or, on the contrary, was individual adaptive reaction inherited?

However this may be, the problem of adaptation remains fundamental. Parasitism offers an excellent field for its study, while at the same time it raises the whole question of evolution in all its diversity. Moreover, its aspect is not merely morphological; it is at the same time a problem of a physiological order.

From the physiological point of view, parasitism raises a series of questions which have the greatest interest to general biology.

In the first place, it is an excellent field for the study, under particularly well-defined conditions, of the reciprocal influences of organisms. All organisms are dependent on each other. Among them there exists a vital competition in the broad sense, a phenomenon of primary importance the demonstration of which is one of Darwin's greatest titles to renown. But here the bond between parasite and host is a definite one, and the reciprocal action of the two antagonists is clearly limited. A definition of parasitism is again needed. An organism is a parasite of another when it lives directly at the expense of that other, feeding on its substance or utilizing the activities of the other's organs to obtain its own subsistence and accomplish its life cycle. Except the plants, which directly assimilate the carbon of the atmosphere or the nitrogen and the mineral constituents of the soil, all organisms subsist at the expense of others, and

it might apparently be said that they are all parasites. But under habitual conditions an animal kills and devours its prey; does away with it, in fact. This kind of life is called "predatism," and it is properly distinguished from parasitism. The parasite, contrary to the predator, feeds on the organism at whose expense it lives, but without destroying it; it exploits its victim methodically, so to speak, by deflecting in its own favor a part of the victim's energy, thus causing the victim more or less harm and exercising an influence which is more or less pathogenic but which is sometimes perfectly tolerated.

Between predatism and parasitism there will be found in nature a continuous series of intermediates. Sometimes, also, two beings are associated in a relationship of dependence which is to a certain degree an exploitation of one by the other, without there being, however, any direct borrowing. This is the condition in commensalism. *Nereilepas fucata*, a polychete annelid which is always found at the apex of gastropod shells (such as *Buccinum*) inhabited by hermit crabs (*Pagurus bernhardus*), profits by the current of water which the crab produces and, moreover, robs the crab, when eating, of some of its food. The annelid is not parasitic, it is commensal. But if many of these associations can be easily labeled as commensalism, the limits between this category and those of parasitism are difficult to draw. Certain creatures, such as many infusorians, like the Urceolarians, the Trichodinians and the Vorticellae make their homes, and necessarily, on other animals; they are *epizoarians*; still commensals, borrowing directly from the animal which carries them locomotion and often the conditions of aeration and renewal of water assured by the functioning of the latter's gills. Thus there is no real boundary between commensalism and parasitism.

One of the characters of parasitism is the fixity and necessity of the relations between host and parasite. A true parasite can not go through its life cycle without the aid of its host; and lives at its expense. These associations are therefore fixed and more or less intimate in degree. But it is not always easy to say of such an association that it exists to the detriment of one of the partners; there are well-defined cases in which it can be demonstrated that for both there is a physiological advantage and sometimes a necessity in carrying out the partnership. Thus are formed complexes of two organisms for mutual benefit and close reciprocal interdependence; they are designated under the name of "symbiosis." In the two kingdoms there are now known a fair number of well-defined cases.

There exist, however, all transitions leading from parasitism to symbiosis. No exact line between them can be drawn. And here our subject touches on a matter of immediate interest. The publication,

a few months ago, by Mr. P. Portier of his book *Les Symbiotes* has once more brought this question to attention. While not stating it in a really new manner, but rather by bringing forward hitherto-expressed ideas in new associations, Mr. Portier has wished to show in his book that symbiosis is a widespread phenomenon, one of the fundamental bases of the life of cellular organisms. The cell, indeed, universally regarded by biologists at present as the fundamental and indivisible unity, would be, according to this view, a symbiotic association; the cell strictly speaking, such as we conceive it, would be by itself unable to subsist, if, in its interior, it did not contain symbionts, bacteria having the power of direct assimilation, a power which they use for the good of the cell as well as of themselves. And Mr. Portier believes he has recognized these symbiotic bacteria or bacterioids in the *organites* studied in histology under the name of mitochondria. There would thus be two classes of beings: The bacteria, sufficient to themselves, *autotrophes* according to Mr. Portier's expressive terminology; and cellular organisms, assimilating through the intermediary of the symbiotic bacteria, *heterotrophes* in the same terminology. Without going further we can see the capital importance of such conception. It would bring about, as its early partisans said, a renovation of the fundamental concepts of biology comparable in importance to the revolution due to the ideas of Pasteur. But however clear and suggestive this conception may be, it has no value except in the event that the facts verify it; it must be seen in what measure Mr. Portier has justified the affirmation which he has made in a decisive form. This will be one of the questions which, later in our course, we shall examine at our leisure; making allowance for the discussion which I shall arouse, I do not hesitate now to declare formally that in my opinion the proof is in no way furnished by the author, and that, on the contrary, his argument can be met by objections of fundamental importance. I declare this without hesitation, but I recognize that I shall have the burden of proving what I assert.

From the physiological point of view the study of parasitism touches on numerous other questions. For a parasite there is always a more or less definite relation to a particular host, a relationship which sometimes becomes exclusive. Thus *Gonospora longissima*, a gregarine which Mr. Mesnil and I have studied,¹ is always present and abundant in one of the forms of *Dodecaceria concharum*, the form which we have designated as B; it is never found in form A; and yet these two forms represent a single species of annelid, or two species which are very nearly related. Many given species of entomo-

¹ Caullery et Mesnil, Les formes épitoques et l'évolution des Cirratulien, Ann. Univ., Lyon, fasc. 38, 1898.

phagus hymenoptera deposit their eggs in only one definitely determined kind of insect. Giard asserted with great plausibility, it seems, that each of the species of epicarid isopods definitely parasitises only one species of crustacean, and that two similar parasites found on related species are actually distinct, even when, morphologically, we are unable to discover definite differences of structure or form. The parasitic copepod which Mr. Mesnil and I have just been studying² under the name *Xenocoeloma brumpti* is found on only one species of *Polycirrus* (*P. arenivorus*) and not on the related species which are found on the coast, such as *P. caliendrum* or *P. haematodes*. What is the mechanism of this definite relationship? In those cases, as in the insects, where the penetration of the parasite into the host is active, how does the parasite find its host in the immensity of nature and how does it distinguish this host from related species? Is it by some tropism as J. Loeb supposes, by some olfactory sensation, for instance? In the case of the passive ingestion of spores, as with the gregarine mentioned above, where the two forms of *Dodecaceria* which live side by side certainly ingest the same sporocysts, why does infection take place in form B only? And this is related to the other question: How is it that internal parasites, sometimes in the digestive tube, sometimes in the deep-seated organs or the body cavity, are able to subsist in their host, possessing immunity to its fluids and phagocytes which digest or destroy the foreign bodies or organisms which succeed in finding their way there? We are here faced by the whole problem of immunity.

How is it that the parasite applies its action to its host, an action which is very definite as regards certain organs? Thus in numerous instances the parasite, at a distance, through alteration in the metabolism of its host destroys the genital glands of the latter, producing parasitic castration. And having produced this result the parasite furthermore induces morphological changes, especially in the secondary sexual characters. It is a remarkable fact that the transformations brought about by parasitism sometimes occur in groups such as the arthropods in which experimental castration, no matter how early, has never yet succeeded in producing any change in these sexual characters. And yet *Sacculina* which infects the crab more or less late in life often profoundly modifies the secondary sexual characters of the crab's abdomen and abdominal appendages. G. Smith has strikingly extended and illustrated the facts first pointed out by A. Giard.

The list of important questions in general physiology brought up by parasitism could easily be lengthened.

But let us come back to the morphological problems and to their connection with the more general problems of evolution. And, more-

² Bull. biologique de la France et de la Belgique, vol. 53, 1919.

over, in reality they are not independent of the physiological problems.

The reaction of parasitism on morphology is striking. It is even true that there is no category of analogous facts in biology which shows the same breadth. Parasites are distinguished from other forms belonging to the same groups by such marked features that the affinities of these parasites often become unrecognizable. In the various groups the transformations which are undergone present an evident parallelism.

Parasitic degradation is a well-known idea. The more profound the parasitism—that is, the more the parasite uses the activities of its host's organism to insure its own nutrition—the more it is deformed and simplified; in a general way the organs of locomotion and of the senses retrogress and finally disappear. It even goes so far that no trace of the primitive nervous system can be found. The organs of digestion become simplified when the parasite, absorbing substances already completely elaborated and assimilable, is dispensed with the labor of first bringing them itself to this condition; hypertrophy then takes place only in an organ of storage such as the "liver" or hepatopancreas. The digestive tube on the other hand, sometimes disappears completely, as in the cestodes, and the animal, bathed in assimilable nourishment, feeds by simple osmosis through its integument; the reproductive organs especially are changed, and in a general manner hypertrophied, but in different ways. Sometimes parasitism obviously brings on hermaphroditism. Sometimes it exaggerates sexual dimorphism, making of the female, stuffed with eggs, a giant on which the dwarf male lives permanently like a parasite. In the one case as in the other the number of eggs produced by parasites is enormous: there is in this enormous production of eggs a compensation for the extreme mortality of the embryos and larvae which do not reach in time the indispensable host; an essentially adaptive compensation which is likely to give rise to teleological illusions. Thus parasites finally become nothing more than voluminous egg sacs, and the animal's cycle after the host is found resolves itself into building up the substance of these eggs, laying them, finally incubating them until the hatching of the larvae.

Thus there is a great simplification of the various systems which do not take part in reproduction—a degradation if you wish, in relation to free forms; but that is a subjective point of view, and we can just as well say that parasites show a specialization carried more or less far, and, all in all, an adaptation which often reaches a very great perfection. In their way parasites are much specialized forms which may be regarded as in a sense extremely high in organization. We shall illustrate these ideas by a few examples and we shall see in particular how a single group often presents successive stages of trans-

formation which connect the extreme, scarcely recognizable forms, with the normal ones. Taken all together, parasites more than any other category of organisms, are a collective and striking illustration of adaptation. Nowhere else does structure appear so sharply outlined as modeled by the kind of life, nor does preadaptation appear less probable.

The adult is not alone in being thus influenced; the young stages are no less influenced, and the conditions of entering the host, often the necessary passage through an intermediary host (and consequently the enormous destruction of individuals in course of development) are in correlation with adaptive peculiarities of the larvae, frequently with phenomena of embryonic multiplication dependent on asexual reproduction. Comparison of the various groups is very suggestive in this connection, because among them we can see parallel divergences from normal embryological development carried out in perfectly distinct series, as if the action of the environment were effective in directly modeling, in the purely Lamarckian sense, the development and structure of parasites.

Let us not suppose, however, that the problem is simple. Conditions which appear to be similar sometimes bring about the most opposite results. In this connection the examples of the parasitic copepods is a striking one. They attach themselves to their host after a period of free life during which they have in general gone through the same principal stages of larval development as the free forms, reaching the stages known as cyclopoid; then they attach themselves, deform themselves, and degrade themselves in the usually understood sense. Mr. Mesnil and I have just finished studying the truly astonishing regression of the genus which we have called *Xenocoeloma* which actually succeeds in literally appropriating a part of the organs of its host. It is impossible to imagine a more complete degradation and more intense parasitism. As a contrast here is another type of copepods, the Monstrillidae. They enter their host in the nauplius larval stage. They then lose all their appendages and become a simple undifferentiated cellular mass which undergoes its development in the circulatory system of an annelid,³ that is, under conditions of supreme parasitism. We should expect that from this mode of life would result a creature as degraded as possible. Nothing of the kind. On the contrary from this juvenile parasitism there arises a copepod splendidly endowed for life in a free medium and armed with powerful swimming appendages for pelagic life. One detail of its organism was, however, paradoxical, constituting an enigma before all the initial parasitic

³ One species has been found parasitic in a mollusk (*Odostomia*). See Pelseneer, Bull. Scien. France-Belgique, vol. 47, 1913.

stages were known. The digestive tube of these adult Monstrillidae is atrophied. This peculiarity can now be explained by the fact that the animal undergoes all its development as a parasite, and that its life in the adult condition is nothing more than a short phase at the beginning of which the sexual products are already ripe and needing nothing further than to be disseminated. The animal has no further need to assimilate. In the same manner the innumerable insects called entomophagous, Hymenoptera, and Diptera for the most part, are laid in the interior of other species where they develop as parasites and become free and perfect imagos. In the same manner again, among the annelids we know a series of Eunicidae which develop as internal parasites in other annelids, to arrive, in the adult, at a free stage which is in no way degraded by parasitism. For the present I shall limit myself to this brief outline, which shows that we must not believe that the state of parasitism has been reached by simple and uniform series of transformations. In each case there are special determining factors, and the consequences of these factors are no less special.

Thus it is not evident that the very striking adaptations of parasites, any more than in the case of free forms, are explicable by the simple Lamarckian mechanism that we thought at first. Here again parasites have been able to react in accordance with the successive steps of a vast orthogenesis. But nevertheless it is striking to see parasitism bring about, in the most diverse groups, parallel modifications which can not be wholly independent of circumstances outside the organism itself. When a rhizocephalous crustacean finally shows the asexual reproduction, which the work of F. A. Potts has demonstrated in *Peltogaster socialis* and *Thompsonia*,⁴ can it be imagined that this final stage was a predestined evolution resulting from mere internal factors of these organisms independent of external circumstances? Can we refuse to think that the progressive action of parasitism, which in the general evolution of types can be nothing more than a side issue, has nevertheless been an external factor of much importance, one which, many times in similar conditions but in independent series, has led to results of the same kind?

Free organisms without doubt give rise to analogous problems, but the case of parasitism is of a special nature. The establishment of the fundamental types of the animal kingdom goes back, as we now know, to a past which is practically inaccessible. The dawn of tangible paleontology shows us evolution almost completed in its main features. But the differentiation of parasites is a second evolution consecutive to the first. We can not reasonably suppose that the parasites with their intense anatomical, embryological, and physio-

⁴ Carnegie Institution, Publication No. 215, 1915.

logical deformations should have made their appearance complete as we see them. They evidently originated from normal forms. Nowhere does the idea of evolution assert itself more positively. When the zoologist is in the presence of such astonishing forms as those which are shown him by the epicarid isopods, parasites on other crustaceans, he is forced to believe—as the development of these creatures proves—that originally they were normal isopods which did not differ from the existing free forms. It is, therefore, only after the perfection of the isopod type that the evolution of the epicaridae took place under the influence of parasitism. This secondary evolution, less far away from us than the first, may be more accessible to us. Consequently the study of the parasitic forms has a special interest in helping us to reach a knowledge of the laws of evolution. At least these laws will perhaps appear more clearly to us in this field.

The material offered by the facts of parasitism, and by those of commensalism or of symbiosis which are connected with them, is, as you can imagine, immense, and the real difficulty is to choose among these facts to keep oneself within the limits imposed by a course of lectures. The harvest of new facts to be gathered is still large and fruitful. We have reached a period in the history of the biological sciences where we accurately measure the difficulty of the great problems. During the heroic period of Darwinism it was generally believed that embryology would reveal all the secrets of morphology. To-day we know that it can not be thus. Morphology often asserts its truth; it does not actually explain itself, because we do not succeed in seeing in it the exact result of a definite mechanism which might if necessary be produced experimentally. On the other hand, the great laws of morphology are established. The golden age was that of Cuvier, Geoffroy Saint-Hilaire, and their immediate successors. In the domain of physiology, on the contrary, which is that of the existing factors and which ignores the past, the progress of all the experimental sciences brings forward every day the possibility of new investigations. Thus cellular physiology is to-day in full development and in rapid progress. And we are therefore sometimes tempted to say that morphology is finished, or nearly so, that in any event we can not expect from it results which are worthy of extended efforts. Therefore let the young generations turn away from it and give themselves entirely to the physiological side of biology.

I shall not deny that there is a certain amount of truth in this idea, yet I believe that, formulated in a rather positive manner as it sometimes is by eminent biologists, it is a dangerous exaggeration. Doubtless many of the pillars of morphology and of descriptive zoology are firmly set up and will not move. But it is an illusion to believe for this reason that we really know morphology. The enormous

effort which has been put forth since 1859 under the impulse of Darwin's book has not led us to the essential solution of the problem of transformism; it may even leave certain persons at the present moment in a rather discouraged state of mind. But this effort has brought us to an incomparably more advanced knowledge of animal forms, of their intimate structure and of the manner in which they are developed. It is thanks to this progress that we see the impossibility of certain explanations which seemed almost obvious immediately after 1859. And the very difficulties presented by the problem of adaptation make it inevitable that morphology can not reduce itself to a few simple laws. It is, moreover, through the progress which has been accomplished that we have been able to state, and shall be able to state, in the physiological field, the questions which appear to use to be the most interesting. What would all the experiments on the animal egg amount to if we were ignorant of all that morphological embryology has taught us? Morphology still offers an endless field for learning, and the facts yet to be discovered may be decisive in directing physiological research. For my part, therefore, I hold that it is not correct to say that the interest in morphology is exhausted and that we ought to turn away from it or turn younger investigators away from it. Should morphology be too much neglected the foundation on which modern cellular physiology would rest would rapidly become insufficient. We can not do otherwise than deeply admire, even to-day, that which Claude Bernard wrote in his "Leçons sur les phénomènes de la vie communs aux animaux et aux végétaux" about the individual characters and the respective parts of morphology and physiology. And yet when we see, a little further along in the volume, what he was able to say, at his time, about the general phenomena of the development of the egg we can measure how vast and fertile a field the work of the morphologist has since then furnished for the physiologist. This fertility of morphology is not exhausted. The study of parasitism which we are going to take up will confirm our opinion that morphology and zoology are not ended and that it is worth while to continue to work on them, without for that reason failing to recognize the enormous interest offered by the physiological method. And what good can come from setting in opposition two methods which ought to support each other mutually, and each of which is better fitted to the peculiarities of certain minds?

LOCAL SUPPRESSION OF AGRICULTURAL PESTS BY BIRDS.

By W. L. McATEE,

Biological Survey, United States Department of Agriculture.

[With 3 plates.]

INTRODUCTION.

The general utility of birds in checking the increase of injurious animals and plants is well understood. It must be admitted, however, that while birds constantly exert a repressive influence on the numbers of the organisms they prey upon and even exterminate certain pests locally, they are not numerous enough to cope successfully with widespread invasions.

Birds are prone to feed upon things which are abundant and easily accessible. For instance, in elderberry season a very large number of birds take elderberries; if May-flies swarm in a locality, practically all of the birds there devour May-flies. Thus, under unusual conditions, such as attend outbreaks of insect or other pests, birds very naturally turn their attention to the plentiful and easily obtained food supply, and the attack on a particular pest often is intensified also by the flocking in of birds from surrounding areas.

Hence birds at times materially reduce or even suppress severe infestations of insects or other pests. Many striking instances of such results of their work are recorded in the Old World, and the purpose of the present paper is to present evidence relating to similar cases in the United States. These instances are grouped with reference to the natural classes and orders to which the pests belong.

From necessity the present paper is almost entirely a compilation, and an effort has been made to exclude all instances of insect suppression that seemed at all questionable. Nevertheless, the writer can not vouch for the authenticity of the accounts of occurrences which from the nature of the case he is unable to verify.

SUPPRESSION OF INVERTEBRATE PESTS. ORTHOPTERA (GRASSHOPPERS AND CRICKETS).

Probably the most conspicuous insect outbreaks that have occurred in the United States were those of the Rocky Mountain or migratory

locust (*Melanoplus spretus*), which are recorded from as early as 1818 up to 1888. The most destructive and widespread migrations occurred from 1873 to 1876. Then the insects devoured every green thing over extensive areas and were a veritable plague to the farmers of the Great Plains.

Cyrus Thomas, of the United States Entomological Commission, which investigated and reported on the Rocky Mountain locust problem, gives evidence which he says proves positively the great usefulness of birds in locally suppressing the locust. He notes that in one instance "a garden was attacked by an innumerable host of minute locusts; the owner battled bravely with them for a while, but at last, giving up in despair, sat down to watch the progress of destruction of his vegetables and flowers, when suddenly a flock of blackbirds alighted on the young cottonwoods he had planted in his yard." Presently "they flew into the garden; when they left, an hour or so after, the dreaded 'hoppers' were gone and his garden saved."¹

The most important data published by the Entomological Commission on the relation of birds to the locust were contributed by Samuel Aughey, of Lincoln, Nebraska. Professor Aughey cites several instances in which birds completely destroyed the locusts on limited areas. He says:

In the spring of 1865 the locusts hatched out in countless numbers in northeastern Nebraska. Very few fields of corn and the cereal grains escaped some damage. Some fields were entirely destroyed, while others were hurt to the amount of from 10 to 75 per cent. One field of corn northwest of Dakota City was almost literally covered with locusts, and where the indications were that not a stalk would escape. After, and about the time the corn was up, the yellow-headed blackbirds in large numbers made this field their feeding ground. Visiting the field frequently I could see a gradual diminution of the number of locusts. Other birds, especially the plovers, helped the yellowheads. And although some of the corn had to be replanted once, yet it was the birds that made the crop that was raised possible at all.

During the season I visited Pigeon Creek Valley, in this county, and found among the eaten-up wheat fields one where the damage done was not over 5 per cent. The Irishman who pointed it out to me ascribed it to the work of the birds, chief among which were the blackbirds and plover, with a few quail and prairie chickens.

In another locality, where the old Omadi Road then crossed Omaha Creek, there were a few old abandoned fields where there were enormous numbers of young locusts toward the end of May. I see from my note-book that I estimated that about 300 locusts hatched out here to the square foot. Some cottonwood and other timber was near by where many species of birds were breeding at that time and later in the season. The birds soon spied out this locust-covered spot and made it their feeding grounds. I frequently stopped at this place as I passed by, both to find out what birds existed in the State and to observe their effect on the locust, as I had been then in the West but a short time. But go when I would, for at least a month more or less, birds

¹ 1st Rept. (for 1877), U. S. Ent. Comm., pp. 335-336, 1878.

could be seen on these grounds. Among these were various species of black-birds, Bartramian and other plovers, quails, snipes, curlews, prairie-chickens, and occasionally larks, and in June occasional orioles, sparrows, bobolinks, and robins. Over a thousand birds must have been feeding here. Long before the middle of June arrived most of the locusts had disappeared * * *

During this same season [the spring of 1865], many of the bluff lands west of Dakota City, especially where there was new or old breaking, became the feeding grounds of great numbers of prairie-chickens and plover. There were then very few settlers there, many of them having left because of the locust invasion of the preceding fall. But to me it was remarkable how rapidly the young locusts disappeared where the prairie-chickens and plovers were daily feeding. In such spots by the middle of June hardly a locust was left.

At a point about 9 miles west of Ponka, on the Niobrara Road, the locust hatched out as elsewhere in prodigious numbers. Here, however, there were some fields that the yellow-headed blackbirds, the quails, and plovers visited in such numbers that few locusts survived to injure the crops. I saw them at work here, and a settler afterward told me that the birds scattered over wider areas after the locust supply began to give out * * *.

In the summer and fall of 1874 the locusts appeared in southeastern Nebraska in unusual numbers even for this region. In Lancaster County, where the road to Milford crosses the Middle Creek, the blackbirds that were passing southward so persistently fed on some spots as hardly to leave a locust behind.

No Nebraskan will forget the countless number of young locusts that hatched out in the spring of 1875. Only where they were removed by causes known or unknown were crops produced during this season over the infested region. Among the few causes operating in the destruction of locusts during that period was the work of insectivorous birds. Among the spots that birds frequented was one on the west side of Salt Creek, not more than 2 miles from Lincoln. There was a small area of about 320 acres that harbored an immense number of locusts. The birds, however, made it one of their feeding grounds, and the locusts lessened daily in numbers. Within a month hardly a locust was left. Similar instances of the work of birds were observed farther down on Salt Creek and on Middle Creek.

In the spring of 1877 the locusts disappeared so rapidly from other causes after they had hatched out that little opportunity was given to examine what effect the birds had on them. Yet, on Middle Creek and its tributaries, and in various other places, I could see that the birds sensibly and rapidly diminished their numbers. One notable point was a few miles down Salt Creek from Lincoln. In May I visited the spot owing to the reported great numbers of locusts there. I estimated the number when I visited the place to be about 135 to a square foot. Already the birds had discovered it, and within sight were quail, larks, bobolinks, yellowheads, plovers, curlews, and a few prairie-chickens. They were all apparently feeding on these locusts. With my glass I could see them picking up these insects. In a month hardly a locust was left at this place.

The following letters, giving instances similar to the preceding of the good deeds of birds, have been received in reply to my inquiries:

"DEAR SIR: In answer to your inquiries I have only this to say: During the last season I planted a tract of Mr. Brentlinger's land, north of Omaha Creek, in addition to my own, in corn. It was on new breaking, where the locusts had laid their eggs. After planting my corn the locusts began to hatch, and in immense numbers, and threatened to destroy all my corn. The blackbirds, however, in large numbers, commenced to feed on the locusts, and devoured them almost as fast as they hatched out. This gave my corn a chance, and I obtained

a good crop, but without the work of the blackbirds this would have been impossible."—Jacob Heikes, Dakota City, Nebraska, October 3, 1877.

"My DEAR SIR: In reply to your inquiry relative to the value of our birds as insect destroyers, I will mention one instance that came under my personal observation last spring. Adjoining my residence in West Point in this State there was a wheat field. About the time the wheat was 2 inches high young grasshoppers made their appearance in great numbers, and in a short time they had eaten the wheat so that the field in many places was as bare as a street. About that time I noticed that large flocks of birds—mostly the common blackbirds—were frequenting this field daily. I soon discovered that they were after the hated 'hopper. I went out frequently to make observations, and I am satisfied that each bird destroyed at least 300 locusts daily. In about 10 days the birds ceased their visits, and upon inspection I found that the 'hoppers had disappeared also. The wheat sprung up again, and made a good crop.

"There are many other similar instances where birds save wheat fields from being destroyed by the grasshoppers in my county, to which my attention has been called by farmers * * *."—Senator Crawford, West Point, Nebraska, November 7, 1877.

"DEAR SIR: I had one field of wheat on which the locusts were at work during the last spring in such numbers that it looked as if nothing would be left. The blackbirds, however, and also the plover, found it out, and came in such numbers that they cleaned out every 'hopper, and I got a good field of wheat."—Elias Brumer, Grand Island, Hall County, Nebraska, September 28, 1877.

"DEAR SIR: In answer to your question about the birds and the locusts, I must say this: Every farmer that shoots birds must be a fool. I had wheat this last spring on new breaking. The grasshoppers came out apparently as thick as the wheat itself, and, indeed, much thicker. I gave up that field for lost. Just then great numbers of plover came, and flocks of blackbirds, and some quail, and commenced feeding on this field. They cleaned out the locusts so well that I had at least three-fourths of a crop, and I know that without the birds I would not have had any. I know other farmers whose wheat was saved in the same way."—S. E. Goodmore, Fremont, Nebraska, October 5, 1877.²

We may quote also the testimony³ of Mr. E. S. Abbott, of Pleasant Hill, Sabine County, Nebraska, who says:

All wild birds prey upon them, especially the prairie-chickens and quails. It is believed that a prairie chicken eats one pint per day; quails about one-half that quantity. The bird which has done us the best service is the [yellow-headed] blackbird * * *. They came in great quantities, probably a thousand in a flock; they marched over the field like a band of soldiers, cleaning the ground * * * where it was actually black with 'hoppers.

W. J. McLaughlin of Centralia, Kansas, pays tribute to the same birds, which, he says,⁴ "made themselves valuable to the farmers last spring in devouring the swarms of young grasshoppers. I had a lot of land on which the grasshoppers deposited their eggs by the million; as they began to hatch the yellowheads found them out, and a flock of about 200 attended about 2 acres daily, roving over the entire lot as wild pigeons feed, the rear ones flying to the front as the in-

² 1st Rept. (for 1877), U. S. Ent. Comm., pp. 339-342, 1878.

³ 2d Rept. U. S. Ent. Comm. (1878-1879), 1880, appendix [p. 6].

⁴ Am. Nat. II, pp. 493-494, 1868.

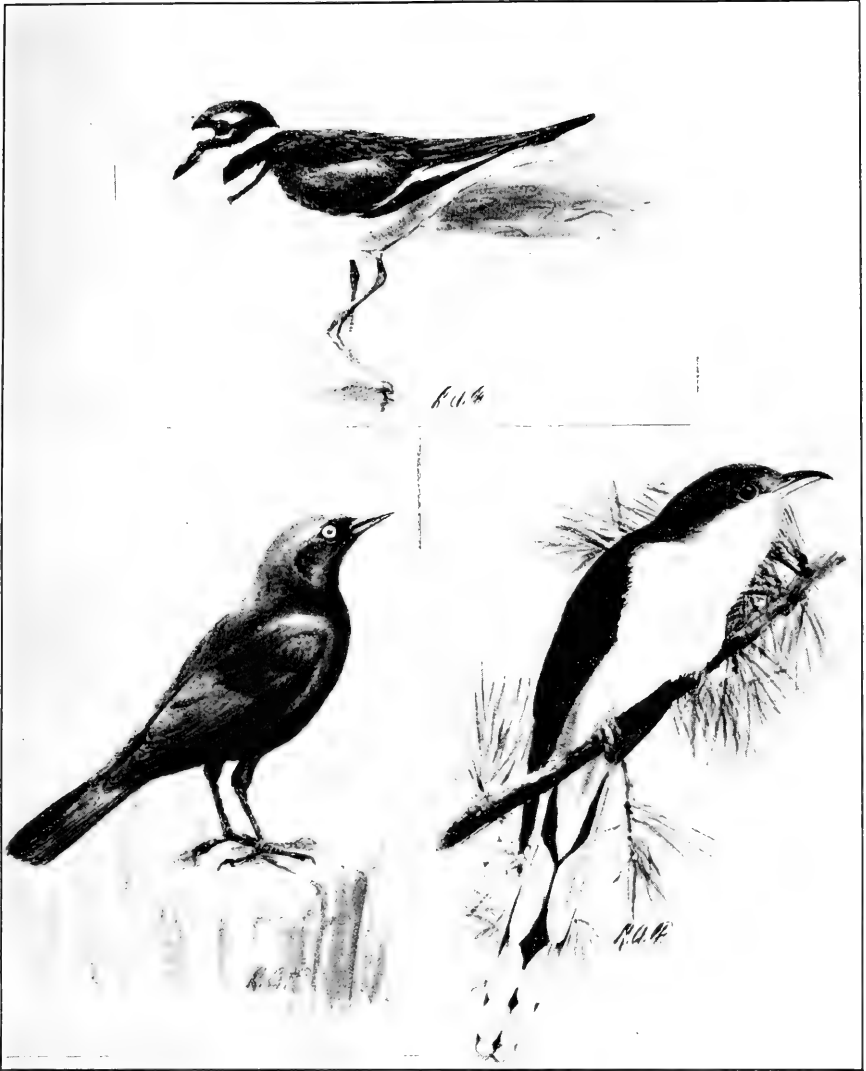

BREWER'S BLACKBIRD.

KILLDEER.

YELLOW-BILLED CUCKOO.

Upper figure. This useful shorebird was one of the species prominent in local suppression of outbreaks of the Rocky Mountain locust.

Lower left. Has helped to extirpate local infestations of the rose weevil and cankerworms.

Lower right. A highly beneficial bird which is a great destroyer of caterpillars. Has cleared trees of such pests as the tent caterpillars, walnut caterpillars, and catalpa sphinx.



sects were devoured. The farmers of Kansas are under great obligations to the little yellowheads, or, as some call them, copperheads, for their service last summer."

The above testimony proves that birds render valuable assistance even in the case of insect infestation so serious that almost all of the crops over enormous areas are destroyed. The evidence leaves no doubt that in many instances birds exterminated the locusts in restricted localities, and that it was due to their work alone that crops were secured in these areas.

The most important species concerned were the various blackbirds, especially the yellow-headed, and the prairie-chicken, bobwhite, and killdeer plover.

An insect almost as important in certain parts of the West as the Rocky Mountain locust is known to have been effectually checked on one occasion by California gulls (*Larus californicus*). This is the short-winged grasshopper (*Anabrus simplex*), commonly known as the black or Mormon cricket. Hon. George Q. Cannon spoke of this insect and its bird enemies in an address before the Third National Irrigation Congress, in Denver, 1894. He said:⁵

After our grain had been sown and our fields looked promising, black crickets came * * * by the millions and devoured our crops. I have seen fields of wheat as promising as they could be in the morning and by evening they would be as bare as a man's hand—devoured by these crickets. * * * To us who lived in Utah about that time it seemed there was a visitation of Providence to save us. Sea gulls came by hundreds and by thousands, and before the crops were entirely destroyed these gulls devoured the insects, so that our fields were entirely freed from them.

This testimony is corroborated by that of a correspondent of the first entomologist of the United States Department of Agriculture, Townend Glover, who records⁶ that "Mr. James McKnight, who lives in Salt Lake City, states that when the Mormons first emigrated to Utah this cricket appeared in immense swarms, destroying their whole crops of wheat, etc., and that the second year they also appeared, but providentially, or miraculously, as it was deemed by the Mormons, vast flocks of white gulls suddenly appeared and destroyed the crickets to such an extent as to almost eradicate them for the time being, thus saving the remainder of the crop, upon which alone the half-starved Mormons had to rely for food for the next season. Since that time these birds are held almost sacred in Utah." It may be added that a monument commemorating the valuable aid of the gulls has been erected in Salt Lake City.

An insect closely related to the Mormon cricket is the Coulee cricket (*Peranabrus scabricollis*) of the Northwestern United States.

⁵ Irrigation Age, Vol. VII, No. 4, pp. 188-189, Oct., 1894.

⁶ Rep. Comm. Agr., p. 79, 1871.

Mr. A. C. Burrill, at the time an agent of the United States Bureau of Entomology, reports⁷ that—

The State of Washington, with the aid of agents of the United States Department of Agriculture, has been attempting to control the Coulee cricket, which devastates large areas in the vicinity of Adrian, Washington. According to Mr. Max Reeher, scientific assistant in the United States Bureau of Entomology, western meadow larks appeared in great numbers in the Dry Coulee last fall and began eating the newly hatched crickets. So efficient were these birds in controlling the situation that arrangements for a 1919 control campaign were abandoned. The meadow larks were almost entirely responsible for the complete clean-up of the area.

HOMOPTERA (CICADAS, PLANT LICE, AND SCALE INSECTS).

An insect which is commonly called locust, but which is not closely related to the true locust family, causes some damage in the eastern United States. This is the periodical cicada or 17-year locust (*Tibicen septendecem*). J. B. Smith in his *Economic Entomology* says⁸ that "Wherever the English sparrow has been introduced, the periodical cicada is doomed." These birds "seem to have an intense hatred for the insects, attacking and pulling [them] to pieces in the most wanton manner. Near the large cities where the sparrows are numerous, entire broods have already been destroyed. In 1889 the insects appeared in large numbers in Prospect Park, Brooklyn, and in the surrounding woodland, but in an entire day's careful search I found only a single branch containing eggs."

The common crow blackbird, also, according to C. L. Marlatt, is at times a very destructive enemy of the periodical cicada. In his account⁹ of an experimental breeding record for this insect, Mr. Marlatt says the holes which the cicadas make when they come out of the soil were so numerous under certain trees—

as to indicate the emergence of thousands of cicadas. Under one tree a count and estimate were made of more than 5,000 openings, and under other trees the openings ranged from a few hundred to from one to three thousand. The actual emergence took place between May 14 and 21. The writer visited the grove on two evenings, and witnessed the issuance of numbers of cicadas and collected some specimens. In spite, however, of the considerable number of cicadas which emerged, none was seen on the trees during the days and weeks following. Each morning about the planted trees would be found a considerable group of blackbirds, which evidently had been feasting on the newly issued cicadas. The cast pupal shells were numerous on the trunks of the trees and especially on the foliage, and also on the ground, but scarcely a single cicada escaped the sharp eyes of these birds, and the characteristic song was not heard during June in this grove, although thousands of adults had come forth.

* * * * *

⁷ Calif. Fish and Game, vol. 6, No. 1, Jan., 1920, p. 38.

⁸ Pages 142-143 [1896].

⁹ Proc. Ent. Soc. Wash., IX, 1907, p. 18.

The absolute failure of these insects to establish themselves when planted in such enormous numbers, even when the underground period had been successfully passed, owing to the relentless onslaught of birds, is a striking illustration of what is happening every year with the different broods in nature, especially in thinly forested regions, and accounts for their great reduction in numbers and the practical disappearance of many local swarms formerly abundant.

The order Homoptera besides the cicadas includes among other forms the plant lice (*Aphididae*), which are universally a favorite bird food, and the jumping plant lice (*Psyllidae*), both of which cause damage. Pests of each of these families are known to be suppressed by birds.

The late H. M. Russel, of the United States Bureau of Entomology, notes¹⁰ that he observed in California a white-crowned sparrow "eating rose aphids as fast as it could pick them from the bush. This was continued for fully 10 minutes, during which time many hundreds must have been eaten, as the plant was almost cleaned up by this bird."

Will C. Colt, of Mission, Lewis County, Washington, in correspondence with the Biological Survey (July 15, 1904), says:

Early this spring there were but few chickadees (*Penthestes atricapillus occidentalis*) to be seen here, but in June the green aphids came to the young fruit trees and in a short time the orchards were just alive with chickadees. They have nearly cleaned the aphids out.

E. H. Forbush, State ornithologist, notes a clear case of aphid suppression by birds in Massachusetts. He says:¹¹

One morning in the fall of 1904 I noticed in some poplar trees near the shore of the Musketaquid a small flock of myrtle and black-poll warblers busily feeding on a swarm of plant lice. There were not more than 15 birds. The insects were mainly imagos, and some of them were flying. The birds were pursuing these through the air, but were also seeking those that remained on the trunks and branches. I watched these birds for some time, noted their activity, and then passed on but returned and observed their movements quite closely at intervals all day. Toward night some of the insects had scattered to neighboring trees, and a few of the birds were pursuing them there; but most of the latter remained at or about the place where the aphid swarm was first seen, and they were still there at sundown. The swarm decreased rapidly all day, until just before sunset it was difficult to find even a few specimens of the insect. The birds remained until it was nearly dark, for they were still finding a few insects on the higher branches. The plant lice I had secured for identification were destroyed or liberated during the night, probably by a deer mouse which frequented the camp; so the next morning at sunrise I went to the trees to look for more specimens. The birds, however, were there before me, and I was unable to find a single aphid on the trees. The last bird to linger was more successful than I, for it was still finding a few; but it soon gave up the effort and left for more fruitful fields. Probably a few insects escaped by

¹⁰ Bul. 90, U. S. Dept. Agr., May, 1914, p. 10.

¹¹ Useful Birds, pp. 70-72 [1907].

flight; but in examining the locality in 1905 I could not find one. The apparently complete destruction of these insects may have been due in part to the hard winter that ensued, but the effect produced by the birds was most obvious.

The same writer gives an instance¹² of the destruction by birds of a serious garden pest, the imported destructive pea louse (*Nectarophora destructor*), which he says—

was very prevalent in 1900, and we were prepared for its appearance in the spring of 1901. The lice appeared as expected, but failed to increase as heretofore. One morning one of the boys at work in the garden [Wareham, Mass.] reported that chipping sparrows were eating the pea louse. This proved true, for all through the season and also the next season wherever peas were planted these birds appeared and fed on these plant lice persistently, day after day, so long as they could be found. A row of late peas about 100 yards in length became infested in August. These peas were one-eighth of a mile from where the early peas were planted and in a locality not ordinarily frequented by the chipping sparrow, but the birds soon found them and haunted the vines day after day until the lice were so reduced in numbers that they did no further injury.

One of the jumping plant lice, the pear psylla (*Psylla pyricola*), is often seriously destructive. H. A. Surface, State entomologist of Pennsylvania, states¹³ that—

A prominent grower of pears in New York reported to us that he had lost many of his pear crops, amounting to thousands of bushels, by this pest, and in the fall, as it was present in great numbers on the trunks of the trees, it appeared that it would pass the winter there and destroy his crops again next year. However, the white-breasted nuthatches came to the orchard in numbers, and he encouraged them to remain by fastening pieces of fat meat in his trees and protected them from molestation. The nuthatches remained and fed on the pest all winter and cleaned up the trees so effectively that he could scarcely find any of the insects in the spring.

Numerous species of birds feed upon scale insects and some of them do very effective work. An item current in the western press in 1908 was to the effect that Dr. W. J. Chambers, of Los Angeles, California, who kept a number of valley quail (*Lophortyx californica vallicola*) found them very efficient destroyers of scale insects. A brood of young quail quickly cleared the black scales from a number of marguerite bushes in the doctor's yard. In correspondence Doctor Chambers has confirmed this report and adds that in his opinion two or three dozen quail in a 10-acre orchard will keep the black scale down to a minimum and render the expense of fumigation unnecessary.

COLEOPTERA (BEETLES).

Many of the most notorious pests of farm, forest, and orchard belong among the Coleoptera or beetles. One that made a spectacular and destructive advance from west to east across the United

¹² Two Years with the Birds on a Farm, p. 29, 1908.

¹³ Zool. Bul. Penn. Dept. Agr., Vol. V, No. 3, p. 79, July, 1907.

States, many years ago, and which was then expected to render the profitable growing of potatoes impossible—the Colorado potato beetle—is now known to be eaten by a large number of birds. One of these, the rose-breasted grosbeak (*Zamelodia ludoviciana*) has been reported to clear fields of the beetles in various localities in Pennsylvania, Wisconsin, and Iowa. A striking instance was recorded by Prof. F. E. L. Beal, before his death a member of the United States Biological Survey, who describes¹⁴

a small potato field [in Iowa] which earlier in the season had been so badly infested with the beetles that the vines were completely riddled. The grosbeaks visited the field every day, and finally brought their fledged young. The young birds stood in a row on the topmost rail of the fence and were fed with the beetles which their parents gathered. When a careful inspection was made a few days later, not a beetle, old or young, could be found; the birds had swept them from the field and saved the potatoes.

According to Vernon Bailey, of the Biological Survey, the cliff swallow (*Petrochelidon lunifrons*) must also be credited with the local suppression of the potato beetle. He states that—

In 1891 Mr. Denney Smith, who then lived on a farm about a mile from my father's farm at Elk River [Minn.] found that his potatoes were covered with young and old potato bugs. He bought 10 pounds of Paris green, but did not get ready to apply it for several days, and when he went into the field again he found that the potato bugs had nearly all disappeared and that a large colony of cliff swallows, which had built under the eaves of his barn, were constantly skimming up and down between the rows of potato vines. Mr. Smith could account for the sudden and unusual disappearance of the potato bugs only on the supposition that the swallows had picked them off the vines, which he thought he could see them doing. The Paris green was never applied and a good crop of potatoes was harvested.

Asparagus is subject to severe attack by beetles of the same family as the potato beetle. Constant aggressive measures against these pests are usually necessary in order to get a crop, but occasionally birds prevent this necessity. Such a case is given by M. F. Adams, of Buffalo, N. Y., who says:¹⁵

Beetles and larvæ of [asparagus beetles] *Crioceris asparagi* and *C. 12-punctata* were abundant June 9. Two days later great numbers of English sparrows were observed on the shoots, and in places where they had been few larvae or beetles remained; apparently they had been eaten by the birds.

A most annoying and destructive imported pest, the elm-leaf beetle, seems to have few bird enemies. The bird oftenest reported to eat it is the cedar bird (*Bombycilla cedrorum*). Outram Bangs reports that during midsummer, 1903, a row of about a dozen young elm trees at Wareham, Mass., became very badly infested with the larvae and adults of the elm-tree beetles (*Galerucella luteola*). At this time the cedar birds discovered the beetles and came in parties of six or

¹⁴ Farmers' Bul. 54, p. 29, 1904.

¹⁵ Bul. N. Y. State Museum, Vol. VII, No. 36, p. 1007, 1901.

eight and fed persistently upon these insects day after day and throughout the day until they had absolutely cleaned up the trees to the last beetle. They searched the twigs and leaves with great care and detail, often hanging back down like a chickadee to get at the underside of the leaves.

An observation¹⁶ of similar nature by Mary Treat brought out that in one town all of the elms had been defoliated for several years by the elm-leaf beetle, but that cedar birds came and afterwards the trees were comparatively free from the beetles.

Yet another of the leaf beetles is known to have extremely efficient bird enemies. The reduction by birds of an infestation of locust-leaf miners at Marshall Hall, Maryland, was observed by the late Dr. S. D. Judd, of the Biological Survey. He states¹⁷ that—

In 1895 the locust-leaf mining beetles (*Odonotota dorsalis*) became overabundant and turned the beautiful green of the locusts, fringing the buff into an unsightly brown. All the birds, including the sparrows, ate these beetles freely and constantly and largely aided by their united attack in reducing the beetles in number to such an extent that they have not appeared subsequently in sufficient force to repeat the damage.

White grubs, the larvæ of the beetles commonly known as May beetles or June bugs, extensively damage lawns, grain crops, and other property of man. Birds are very fond of them, however; in fact, are their principal natural enemies, and occasionally suppress them locally. Mr. J. J. Davis, of the United States Bureau of Entomology, who gives high credit to the bird enemies of white grubs, states¹⁸ that to his knowledge "fields of timothy sod have been literally overturned by crows in their search for grubs, and in some fields the grubs were almost exterminated by them."

Mr. E. H. Forbush, State Ornithologist of Massachusetts, relates how robins were equally effective against white grubs under entirely different conditions.

In 1914, he notes,¹⁹ on a portion of three sections of a cranberry bog on my place at Wareham nearly every plant was killed by the white grub of a May beetle (*Lachnosterna*) which destroyed all the roots. As this insect, which remains for several years in the soil, is difficult to control on a cranberry bog, it was concluded to reset the tract with new vines in 1915 and see what happened. The vines were set, and almost immediately numbers of robins were seen at work upon the tract. They dug into the sand with their beaks and pulled out the grubs. In a few cases the roots of the vines were cut off by the grubs, and these vines the robins pulled up, discarded, and dug out the

¹⁶ Forbush, E. H., *Useful Birds*, p. 211 [1907].

¹⁷ *Bul.* 15, *Biol. Surv.*, p. 35, 1901.

¹⁸ *Farmers' Bul.* 543, U. S. Dept. Agr., July 18, 1913, p. 10.

¹⁹ *Eighth Ann. Rept. State Orn., Mass. State Board of Agriculture* (Dec. 8, 1915), 1916, pp. 26-27.

grubs. The robins worked so diligently that practically no grubs escaped. A few that had come to maturity emerged from the sand as beetles and disappeared, but apparently the birds got all the rest, and as a result the vines set this year nearly all survived.

Among the most injurious groups of beetles are the weevils. They are eaten in large numbers by practically all insectivorous birds, and we have one record of local suppression of an invasion of weevils. Mr. John G. Tyler, of Fresno, California, says:

One spring vast numbers of rose beetles (*Aramigus fulleri*) invaded the country about Clovis [California], and after destroying the rose flowers they took to the vineyards, doing considerable damage to the foliage by boring numerous holes through the leaves, causing them eventually to wither up and drop off. Every day for nearly a week a great flock of Brewer blackbirds hovered over a certain vineyard that I had an excellent opportunity to observe. Crawling over the branches or alighting on the topmost shoot, these black-plumaged birds were conspicuous objects against the green of the tender new foliage. As a result of the efforts of these birds, in a short time the vineyard was almost entirely free from the beetles.

LEPIDOPTERA (BUTTERFLIES AND MOTHS).

The Lepidoptera, or butterflies and moths, include a large number of destructive species, many of them ranking among our worst pests. The adults are eaten in numbers by only a few birds, but their immature stages, caterpillars and chrysalides, especially the former, are staple bird food. Hence it is not surprising that a large number of cases of local suppression of lepidopterous pests have been observed. One of the most injurious of these insects, the orchard tent-caterpillar (*Malacosoma americana*), seems especially subject to destructive onslaughts by birds. J. P. Kirtland notes²⁰ the blue jay as an effective enemy near Cleveland, Ohio. He says:

Soon after they [the blue jays] had emigrated to my evergreens I one day noticed one of the birds engaged in tearing open a nest of the bagworm [*Clisiocampa americana*] on an apple tree. Thinking the act was a mere destructive impulse, I was about walking away when the bird, with its bill apparently filled with several living and contorting larvæ, changed its position to a tree close by where I was standing. * * * Its next removal was to an adjacent black-spruce tree, where I could plainly see it distributing the captive bagworms to sundry open and uplifted mouths.

From this hint I was led closely to watch the further proceedings of the community. Before the young birds had passed from the care of the parents most of the worms' nests had been broken into, many were torn into threads, and the number of occupants evidently diminished. Two or three years afterwards not a worm was to be seen in that neighborhood, and more recently I have searched for it in vain, in order to rear some cabinet specimens of the moth.

²⁰ Atlantic Monthly, Vol. XXV, pp. 483-484, 1870.

A Rockville, Conn., correspondent of the *Cultivator and Country Gentleman*²¹ contributes the following on the Baltimore oriole as an enemy of this pest:

Speaking to a friend to-day regarding the remarkable absence of the tent-caterpillar from our fruit trees this year, and speculating as to the cause of it, he asked if I knew what an enemy they had in the Baltimore oriole. On my replying in the negative, he related an incident in point which I thought might interest your readers, as it did me:

Being out in the apple orchard, he noticed a large caterpillar's nest at the top of a tree, and, while thinking how it could be reached, an oriole flew into the tree and, spying the nest, went to it at once, tore it open with his bill, and proceeded to devour the occupants greedily. Soon, however, it flew away, but returned speedily with its mate, when the two resumed the feast until apparently not a single worm was left. The next day all that remained of the late thriving colony or to indicate its ever having existed were the shreds and tatters of the once populous canopy.

George Donaldson, of Warren County, Ohio, in a letter (Oct. 18, 1885) to the Biological Survey, gives the cedar-bird great credit for devouring tent-caterpillars. He states that "the cedar-birds rendered great service by the destruction of the tent-caterpillar in our apple orchard, which, after a great deal of labor, we could not free from them until the birds came to our assistance."

Speaking of another bird enemy, the yellow-billed cuckoo (*Coccyzus americanus*), A. W. Butler says:²²

Few birds are of so much service to the farmer. Especially are the fruit growers and nurserymen its debtors. In early spring they love the orchard. I have known them to destroy every tent-caterpillar (*Clisiocampa americana*) in a badly infested orchard and tear up all the nests in a half day. While they may have eaten some caterpillars, out of most of them the juices were squeezed and the hairy skin dropped to the ground.

Almost identical testimony is given by several observers quoted by Forbush.²³

The closely related forest tent-caterpillar (*Malacosoma disstria*) is equally relished by the cuckoo and other birds. The fondness of these birds for it and the results of their warfare on it are described²⁴ by Mary B. Sherman from observations in Ogdensburg, New York. She wrote on May 18, 1900, that—

The town is full of birds, and they are doing good work feeding on the forest tent-caterpillars. * * * The English sparrow has been eating the forest tent-caterpillars, and last summer they attacked the cocoons and fed on the moths. We have an unusual number of orioles, which I have seen feeding on the caterpillars. I have also seen the yellow and several other warblers, the yellow-billed cuckoo, the robin, the cedar-waxwing, and, I believe, the house

²¹ Vol. XLIV, p. 407, 1879.

²² Rep. Dept. Geology and Natural Resources of Indiana (1897), p. 824, 1898.

²³ Useful Birds, p. 266 [1907].

²⁴ Bul. N. Y. State Museum, VII, p. 1019, 1901.



HAIRY WOODPECKER.

BOBWHITE.

WHITE-BREADED NUTHATCH.

Upper figure. While not a highly insectivorous bird the bobwhite feeds to some extent upon farm pests and has assisted in the local control of the Rocky Mountain locust.

Lower left. An effective enemy of tree-infesting insects, one of which, the tussock moth, it has locally extirpated.

Lower right. Health inspector of the bark of trees, ridding it of many pests. Has cleared an orchard of pear psyllas.



wren feeding on the caterpillars. The maples in front of the house have been filled with warblers, all of which were very busy with the trunks and branches, and yesterday I noted five varieties.

On May 26 she states:

We have practically no forest tent-caterpillars in town. They hatched in large numbers, but the cold evidently killed many and the birds appeared to have cared for the remainder.

Even so tenacious a pest as the gipsy moth is not always proof against losses due to birds. E. H. Forbush states²⁵ that—

Instances were recorded during the State [Massachusetts] campaign against the gipsy moth, from 1890 to 1895, where small isolated moth colonies appeared to have been suppressed and even annihilated by birds. A serious outbreak was discovered in Georgetown, Massachusetts, in 1899. It had been in existence for a long time, but its spread had evidently been limited by the great number of birds that were feeding there on all forms of the moth. Several months later the State abandoned the work against the moth and little hope was entertained that anything more than a severe check had been given the insect in Georgetown. Nevertheless, in the six years that have since elapsed comparatively few moths have been found in that locality. The most feasible explanation of this seems to be that up to 1906 the birds have kept the numbers of the moths below the point where they can do appreciable injury.

It has frequently been remarked that few birds attack any stage of the tussock moth (*Hemerocampa leucostigma*), but the English sparrow, the Baltimore oriole, and yellow-billed cuckoo are known to eat the larva, and the hairy woodpecker, according to Dr. E. Sterling, of Cleveland, Ohio, sometimes is an extremely effective enemy of the tussock moth or, as he calls it, the New Haven elm-tree caterpillar. Doctor Sterling says:²⁶

In the summer of 1880 the elms along Euclid Avenue, especially in my vicinity, were attacked by the "New Haven elm-tree caterpillar." Fearing a repetition of their trouble, numbers of us fought the cocoons in the fall and destroyed thousands, but when winter set in tens of thousands still remained on the outer branches beyond reach. About the 1st of December a pair of hairy woodpeckers (*Dryobates villosus*) made their appearance and fed daily on the grubs; in the course of that month and the next over a dozen of the birds were added to the number and by their industry on this particular pest attracted the attention of all who passed. Suffice it to say that when March came not a cocoon was to be seen in those places where the branches were literally white with them before, and more, this is the last we ever saw of the New Haven visitor.

The tent-caterpillar, the gipsy moth, and tussock moth larvae all belong to the class of hairy caterpillars which were formerly thought to be practically immune from attacks by birds. But this idea has long been disproved, and instances like the ones above quoted convince one that hairy caterpillars are by no means distasteful to birds. Two other cases may be cited in which infestations of hairy caterpillars have been subdued by birds.

²⁵ Useful Birds, p. 70 [1907].

²⁶ Insect Life, III, p. 295, 1891.

A. W. Anthony states²⁷ that—

In southern California the passion vine is everywhere infested by a red butterfly (*Agraulis vanillae*), the larvæ of which feed extensively if not entirely upon this plant. So great is the damage that plants are often completely defoliated and become so unsightly that in some regions many have destroyed their vines and replaced them with other species, less desirable, perhaps, but less apt to breed a horde of pests.

Not long since I called on a friend living in the suburbs of San Diego who had a large number of unusually thrifty passion vines climbing over his fence. Upon inquiring the reason of their freedom from what I considered an inevitable pest he informed me that a pair of roadrunners (*Geococcyx californianus*) had for several months paid daily visits to his vines, climbing through them in all directions until the last caterpillar had been captured.

Robert Ridgway, America's foremost ornithologist, gives the following account of the extirpation of a colony of caterpillars (*Datana integerrima*) on black walnut at his former home in Brookland, District of Columbia:

We first noticed the caterpillars something like two weeks ago, our attention being attracted to them by noticing several branches which had been stripped of their leaves. We then discovered the caterpillars in clusters on the twigs and foliage, and a little later a compact mass of them, about a foot long by 6 inches wide, on the bark of the trunk, a foot or so from the ground. Within a day or two of our first discovery of the pests we saw a yellow-billed cuckoo in the tree busily engaged in eating the caterpillars. Later this was joined by another (probably the mate), which, however, only made occasional visits to the tree, its time being doubtless mainly occupied with incubating or brooding. The other cuckoo practically *lived* in the tree, being very seldom absent, even for a short time, and was so persistent in his destruction of the caterpillars that whenever one fell to the ground he would immediately follow it and then dispatch and devour it; and later, when few were left on the tree, we saw him carefully searching the ground beneath. The results of the work of these two cuckoos (principally one of them) was that within a week the colony of caterpillars was absolutely exterminated, and I have not been able to find one in the neighborhood. (July 30, 1906.)

Smooth caterpillars are eaten by almost all birds and usually in considerable numbers. None are more suitable for bird food than canker-worms, a fact that has in many cases led to great reduction in numbers of these insects. O. E. Bremner, of the California State Horticultural Commission, communicates the following observations on birds and canker-worms to the Biological Survey (Mar. 16, 1908):

In one district, Dry Creek Valley, Sonoma County, there has been a threatened invasion of the prune trees by spring canker-worms several times, but each time the blackbirds (Brewer's) come to the rescue and completely clean them out. I have often seen bands of blackbirds working in an infested orchard. They work from tree to tree, taking them clean as they go. If a worm tries to escape by webbing down they will dive and catch him in midair.

Mr. Ehrhorn tells me of an incident near San Jose where the canker-worms were badly infesting a prune orchard, and when they commenced to irrigate the land the blackbirds seemed to be attracted by the water, and inside of three days there was not a single worm left.

²⁷ Auk, XIV, p. 217, 1897.

Prof. F. E. L. Beal learned in an interview with Mr. H. Kimball, of Haywards, California (June 6, 1901), that several years ago cankerworms infested his orchards and threatened their complete destruction. He banded the trees to prevent the larvæ from ascending, but soon after this was done Brewer's blackbirds discovered the worms. They came in large flocks and very soon not a worm was to be found.

Prof. D. E. Lantz, who up to the time of his death was employed by the United States Biological Survey, relates how an infestation of cankerworms so severe that all the trees except poplars near his former residence in Manhattan, Kansas, were defoliated the previous year, was checked by birds. English sparrows, assisted principally by warbling vireos, but at times by warblers and other small birds, got control of the pests early in the season and prevented defoliation. A group of apricot trees near the house was so carefully searched that the foliage remained in almost perfect condition.

E. H. Forbush, State ornithologist of Massachusetts, records²⁸ that—

Mr. E. W. Wood, of Newton, a well-known member of the State board of agriculture, informs me that during one season, when the spring canker-worms (*Anisopteryx vernata*) became quite numerous in his orchard, a pair of Baltimore orioles appeared and built a nest near by. In the meantime they fed daily upon the cankerworms. This they continued to do so assiduously that by the time the young were hatched the numbers of the worms were considerably reduced. They then redoubled their diligence, sometimes carrying 10 or more worms to their nest at once. Soon the canker-worms in that orchard were a thing of the past. The foliage and fruitage were saved for that and many succeeding years.

Other smooth caterpillars known to be sometimes kept in check by birds are cabbage worms, ground cutworms, climbing cutworms, catalpa sphinx, tomato sphinx, and drop worm. The chipping sparrow (*Spizella passerina*) has frequently been recorded as an enemy of the cabbage worm (*Pontia rapae*). Dr. J. Schwenk says²⁹ of this species:

By accident I was observing the patch early in the morning, from daybreak to a short time after sunrise, when I chanced to find a number of chipping sparrows * * * taking worms [cabbage worms] as busily as possible. By continuing my observations I found this was the case every morning as long as the worms lasted.

Mr. J. B. Dunn, of Corpus Christi, Texas, gives information concerning a destructive bird enemy of the cabbage looper (*Autographa brassicae*). He is quoted³⁰ by Dr. F. H. Chittenden, of the Bureau of Entomology, to the effect that "a bird known locally as jackdaw (*Megaquiscalus major*) was particularly fond of these cabbage

²⁸ Mass. Crop Rep. Bul. 5, p. 30, 1894.

²⁹ Am. Nat. XIV, p. 130, 1880.

³⁰ Bul. 33, Div. Ent., p. 68, 1902.

loopers. These birds would alight in the fields and feed on the larvæ daily until they would clean them up and save the crop." Mr. Dunn further remarks in a letter to the Biological Survey that: "At various times they have been known to save whole crops of cabbage and lettuce when the cabbage worm or looper was destroying them. Just a few days after I mentioned this bird to Mr. F. H. Chittenden they came into my field and what worms the poison had not reached they devoured." (Corpus Christi, Texas, Dec. 6, 1901.)

Mr. J. L. Harris records³¹ the fact that another cabbage pest, the diamond-back moth (*Plutella maculipennis*), was entirely extirpated from his patch by a flock of blackbirds. He notes, however, that they tore the cabbage considerably in getting them.

Ground cutworms are a familiar pest to every gardener and farmer; they are freely eaten by a large number of birds, and sometimes, it appears, entirely destroyed by birds in small areas.

Mr. G. U. Clark, writing from East Northfield, Massachusetts, June 24, 1919, states that introduced starlings

have been conspicuous among the crow blackbirds the past few days, picking cutworms from a recently mowed patch by the house where I am staying. I noticed years ago, and published in the Independent, that we have no native bird so diligent in the pursuit of cutworms; when I lived in New Haven, Connecticut, my place was so overrun with cutworms that I had to give up trying to raise early peas and lettuce, but after the starlings arrived they speedily rid the place of them almost entirely.

In further reference to effective bird enemies of cutworms, Mr. Irving C. Emmitt, a Federal game warden, reports that—

In the spring of 1918 the tomato growers in northern Utah were very much worried about the cutworm. The tomato plants are generally set out between the 1st and 15th of May, and during this spring in some districts, especially near the shores of the Great Salt Lake, where the soil is of a sandy loam, the cutworms would attack these young plants and some nights would cut down as high as 10 acres during the one night. It was soon noticed that in fields where there were birds, especially meadow larks, the cutworm did not bother the plants, consequently an investigation was made as to whether the meadow lark was attacking the cutworm. Together with the county agent, the writer went out among the different fields and found that wherever there were meadow larks in the field the tomato plants had been practically left alone. We killed one meadow lark while in one of these fields, and upon examining its stomach found it contained 36 cutworms. Since that time the farmers in this tomato-raising district have encouraged the breeding of meadow larks, and you will find thousands there now where there were only hundreds before, the result being that the cutworms are not bothering the tomatoes anything like they did previously. In fact, the farmers look upon the meadow larks as saviours to them, and if anyone was found shooting a meadow lark in this district it might go very hard with him.

³¹Trans. Minn. State Hort. Soc., Jan., 1878, p. 63.

Respecting the suppression of climbing cutworms, O. E. Bremner states (San Francisco, California, Mar. 16, 1908) :

In the spring of 1905, a species of climbing cutworm, I am unable to say what one, attacked the vineyards of the Italian-Swiss colony in Sonoma County, on low land along the Russian River, and before we had a chance to do anything had stripped 10 acres or more of every vestige of green, even the stems and buds, back to the old wood. When I arrived on the scene where they were destroying thousands by handpicking I found large numbers of crows assembled [which] * * * were busily engaged in hunting out the fat worms. There has not been a repetition of the attack since, and I attribute this at least partly to the crows.

The catalpa sphinx (*Ceratonia catalpae*), which sometimes rapidly defoliates extensive growths of catalpa, is said to be a favorite food of cuckoos. Judge Lawrence C. Johnson is quoted³² by C. V. Riley as follows on this subject :

While lying ill a few days at a hotel in Eutaw, Alabama, I could hear the well-known notes of these birds as if in uncommon numbers. A large water-oak (*Q. phellos*) shut out the prospect from my window ; but the cuckoos frequently lit in it, giving me a good view of them. There they were, both species—*Coccyzus erythrophthalmus* and *C. americanus*. The latter is more numerous in the bottoms, but the river is only 2 miles away. The question with the sick man was, What could be drawing these shy birds into the midst of a city? As soon as I could walk out the mystery was explained. Across the street stood a line of Catalpa (*bignonioides*). Every caterpillar was cleaned off the upper branches. Not one to be found much defoliated, except very near the ground.

Another sphinx caterpillar, the common tomato worm, although a large, repulsive-looking creature, is eaten by several kinds of birds, and at times by the crow, at least to a very effective extent. Mr. Frank N. Wallace, State entomologist of Indiana, reported to an agent of the Biological Survey that he had observed crows clean up a potato patch infested by tomato sphinx caterpillars, eating some and killing the others, and Mr. A. W. Butler, of the same State, says³³ that an observing farmer near Indianapolis reports that—

A year or two ago his tomato patch was infested with great numbers of worms, and he was compelled to wage relentless warfare against the unwelcome visitors. One day he observed a crow acting in an unusual manner among his plants. Upon investigation he found it was eating "tomato worms." The next day more crows were seen among the vines, and for a few days the company increased, until quite a number daily sought his tomato plants, depending upon the insects caught for their food. This was continued until the "worms were all killed."

The army worm, a pest almost as spectacular and destructive in its invasions as the Rocky Mountain locust, is known to be freely eaten by many kinds of birds, but usually occurs in such numbers that the birds are unable to cope with it. In some cases, however, great execu-

³² Rep. Comm. Agr., p. 415, 1884.

³³ The Birds of Indiana, 1890, p. 65.

tion is done, as described in the following account by Mr. J. M. Eheim, of Hutchinson, Minnesota :

On July 28, 1920, a field of oats was cut on account of the ravages of the army worm. In a very short time a large number of birds came to feed on the worms, including the bronze grackle, yellow-headed blackbird, English sparrow, vesper sparrow, and a few migrant shrikes.

On August 2 the army worms left the oat field and went to an adjoining cornfield. This field seemed covered with the birds feeding on the army worms. The English sparrows would take two or three worms at a time to feed their young, and by the next day there were neither worms nor birds to be seen in that field.

Near by was a cornfield, of which about 3 acres were destroyed. There seemed to be no birds in that field. On August 3 they came from the other field, by August 4 there were only a few worms to be found, and by August 8 there were neither worms nor birds on that field.

The drop worm, or, as now generally called, the snow-white linden moth (*Ennomos subsignarius*), seems to be the special prey of the English sparrow. A. R. Grote, a distinguished entomologist, said³⁴ in 1883 :

Many will recollect that the maple and other shade trees in Brooklyn and New York used to be completely defoliated by the middle of summer by the common brown drop, or measuring worm * * *. The English sparrow rid us of this nuisance; it ate every one of them.

John B. Smith, entomologist, of New Jersey, made the following interesting observations³⁵ on the relations of the sparrow and this insect :

On the evening of July 17 [1908], Newark, Elizabeth, Paterson, Jersey City, and some of the surrounding towns were treated to a unique experience; a veritable swarm of snow-white moths flying around the electric lights and giving the appearance of a snowstorm in midsummer * * *. On the morning after the flight the sparrows apparently became very busy soon after daylight, and all that was left to mark it was numerous quantities of wings without bodies * * *. This flight was composed of individuals of the snow-white *Eugonia*, known everywhere half a century ago as the parent of the "span worm." It was at that time the most abundant and destructive shade-tree insect in the eastern United States, and its caterpillars, feeding upon most of the shade trees, were a nuisance by their habit of suspending themselves by threads from the foliage upon which they fed and dropping upon pedestrians moving beneath.

These caterpillars were responsible for the introduction of the English sparrows into this country. So abundant were they and so helpless were the authorities against them that the suggestion was made and favorably acted upon that this foreign bird be introduced for the specific purpose of dealing with the "worms." The sparrows did their work well. It was not long before the caterpillars practically disappeared from the cities.

Glenn W. Herrick, in a bulletin of the Cornell University Experiment Station, sums up the evidence as follows:³⁶

³⁴ Can. Ent. XV, p. 235, 1883.

³⁵ Rep. N. J. Agr. Exp. Sta., pp. 317-318, 1908.

³⁶ Bul. 286, p. 62, 1910.

The testimony regarding the activity of the English sparrow in exterminating this pest in cities seems to show rather conclusively that this much disliked bird did actually bring about the destruction of this insect. Nearly every writer on the snow-white linden moth makes acknowledgment to the sparrow and declares that the cities owe their freedom from this insect to that bird.

Most of the records quoted under Lepidoptera refer to the warfare upon larvae by birds, while those under the snow-white linden moth refer in part to the destruction of the adult insects. Lepidoptera are occasionally effectively attacked also in the cocoon or chrysalis stage. F. M. Webster, late of the United States Bureau of Entomology, notes³⁷ that at Waterman, Illinois, only 2 out of a total of over 20 cocoons of the cecropia moth (*Samia cecropia*) in a small grove of box elders had escaped destruction by hairy woodpeckers (*Dryobates villosus*).

The cocoons and chrysalides of the codling moth also are favorite morsels with many species of birds. It has been ascertained by actual count that in some localities from 66 to 85 per cent of the hibernating larvae are destroyed. Thorough search often fails to reveal a single cocoon, showing that birds have devoured all but the inaccessible larvae and pupae. Mr. A. P. Martin, of Petaluma, California, attributes valuable work of this nature in his locality to the red-shafted flicker (*Colaptes cafer collaris*). He says:³⁸

In examining the crevices and bark of the trees for codling moth larvae, I failed to find any where there were thousands last fall. This surprised me, and I thereupon commenced an investigation. I discovered plenty of cocoons, but in every case the former occupant was absent. Being too early in the season for the transformation into the moth, and also finding none of the discarded "skins" or pupa cases usually left by the moth when it emerges, I was at a loss for a time to account for their disappearance. But after looking at both sides the mystery was solved to a degree, for in the scales of bark over each cocoon I found small holes. I send you samples by mail.

Evidently through these holes the worms had been drawn out. Now the question arises, What made these holes and extracted the worms? My belief is that it was done by a bird whose ornithological epithet I am unacquainted with, but which is variously called "yellow-hammer," "flicker," "high hole," etc.

During the early spring months they were to be seen by the hundreds in my orchard industriously examining the bodies and larger limbs of the fruit trees. I suspected at the time that they were in search of apple worms but did not then know that they could locate the position of the larvae under the bark and dig through after them. What induces me to think that they are the parties to whom the credit is due is that I observed great numbers of them busy around the sheds when I stored my winter apples and pears. They got every worm that they could reach, even picking holes deeply into the wood where there were cocoons in nail holes or crevices in the boards of which the sheds were constructed.

As the result of several hours' search at various times before the moth emerged, I found only one worm, and he just escaped by the "hair of the teeth," for there had been several taken out within a quarter of an inch of him.

³⁷ Am. Nat. 15, pp. 241-242, 1881.

³⁸ Pacific Rural Press, Vol. XXXIX, No. 23, p. 580, June 7, 1890.

LIST OF INSECT PESTS AND BIRDS MENTIONED AS DESTROYING THEM.

Rocky Mountain locust (<i>Melanoplus spretus</i>).....	Jack snipe (<i>Gallinago delicata</i>). Curlews (<i>Numenius</i> sp.) Upland plover (<i>Bartramia longicauda</i>). Plovers. Quail (<i>Colinus virginianus</i>). Prairie-chicken (<i>Tympanuchus americanus</i>). Blackbirds. Yellow-headed blackbird (<i>Xanthocephalus xanthocephalus</i>). Bobolink (<i>Dolichonyx oryzivorus</i>). Western meadowlark (<i>Sturnella neglecta</i>). Orioles. Sparrows. Robin (<i>Planesticus migratorius</i>).
Mormon cricket (<i>Anabrus simplex</i>).....	California gull (<i>Larus californicus</i>).
Coulee cricket (<i>Peranabrus scabricollis</i>)...	Western meadowlark (<i>Sturnella neglecta</i>).
Periodical cicada (<i>Tibicen septendecim</i>)...	Crow blackbird (<i>Quiscalus quiscula</i>). English sparrow (<i>Passer domesticus</i>).
Rose Aphis (<i>Macrosiphum rosæ</i>).....	White-crowned sparrow (<i>Zonotrichia leucophrys</i>).
Plant lice (<i>Aphidæ</i>).....	Myrtle warbler (<i>Dendroica coronata</i>). Blackpoll warbler (<i>Dendroica striata</i>). Oregon chickadee (<i>Penthestes atricapillus occidentalis</i>).
Pea louse (<i>Nectarophora destructor</i>).....	Chippy (<i>Spizella passerina</i>).
Pear psylla (<i>Psylla pyricola</i>).....	White-breasted nuthatch (<i>Sitta carolinensis</i>).
Black olive scale (<i>Saissetia oleæ</i>).....	Valley quail (<i>Lophortyx californica vallicola</i>).
Potato beetle (<i>Leptinotarsa decemlineata</i>)..	Rose-breasted grosbeak (<i>Zamelodia ludoviciana</i>). Cliff swallow (<i>Petrochelidon lunifrons</i>).
Asparagus beetles (<i>Crioceris asparagi</i> and <i>C. 12-punctata</i>).	English sparrow (<i>Passer domesticus</i>).
Elm leaf-beetle (<i>Galerucella luteola</i>).....	Cedar-bird (<i>Bombycilla cedrorum</i>).
Locust leaf-miner (<i>Odontota dorsalis</i>).....	Yellow-billed cuckoo (<i>Coccyzus americanus</i>). ³⁹ Kingbird (<i>Tyrannus tyrannus</i>). Great-crested flycatcher (<i>Myiarchus crinitus</i>). Phoebe (<i>Sayornis phoebe</i>). Wood pewee (<i>Myiochanes virens</i>). Orchard oriole (<i>Icterus spurius</i>). Baltimore oriole (<i>Icterus galbula</i>). English sparrow (<i>Passer domesticus</i>). Chippy (<i>Spizella passerina</i>). Field sparrow (<i>Spizella pusilla</i>). Song sparrow (<i>Melospiza melodia</i>). Chewink (<i>Pipilo erythrophthalmus</i>). Cardinal (<i>Cardinalis cardinalis</i>). Scarlet tanager (<i>Piranga erythromelas</i>).

³⁹ List in Biological Survey Bul. 17, 1902, p. 30.



CHIPPING SPARROW.

ROBIN.

ENGLISH SPARROW.

Upper left. This familiar bird is a special enemy of garden insects and has been known to control local infestations of the pea louse and cabbage worm.

Upper right. Often a nuisance, but also an effective destroyer of numerous injurious insects. Here recorded as in at the death of outbreaks of the periodical cicada, asparagus beetles, cankerworms, and the dropworm.

Lower figure. The best-known bird in the United States. Eats much fruit and earthworms, but injurious insects also; has helped to subdue local irruptions of the Rocky Mountain locust, white grubs, and tent caterpillars.



- Locust leaf-miner (*Odontota dorsalis*).....Cedar-bird (*Bombycilla cedrorum*).
 Red-eyed vireo (*Vireosylva olivacea*).
 Warbling vireo (*Vireosylva gilva*).
 Yellow warbler (*Dendroica æstiva*).
 Catbird (*Dumetella carolinensis*).
 Carolina wren (*Thryothorus ludovicianus*).
- White grubs (*Phyllophaga* sp.).....Crow (*Corvus brachyrhynchos*).
 Robin (*Planesticus migratorius*).
- Rose weevil (*Aramigus fulleri*).....Brewer's blackbird (*Euphagus cyanocephalus*).
- Orchard tent-caterpillar (*Malacosoma americana*). Yellow-billed cuckoo (*Coccyzus americanus*).
 Blue jay (*Cyanocitta cristata*).
 Orchard oriole (*Icterus spurius*).
 Cedarbird (*Bombycilla cedrorum*).
- Forest tent-caterpillar (*Malacosoma disstria*). Yellow-billed cuckoo (*Coccyzus americanus*).
 Baltimore oriole (*Icterus galbula*).
 English sparrow (*Passer domesticus*).
 Cedar-bird (*Bombycilla cedrorum*).
 Yellow warbler (*Dendroica æstiva*).
 Robin (*Planesticus migratorius*).
 Hairy woodpecker (*Dryobates villosus*).
- Tussock moth (*Hemerocampa leucostigma*). Hairy woodpecker (*Dryobates villosus*).
- Passion-vine caterpillar (*Agraulis vanillæ*). Road runner (*Geococcyx californianus*).
- Walnut caterpillar (*Datana integerrima*)... Yellow-billed cuckoo (*Coccyzus americanus*).
- Canker-worms (all probably *Paleacrita vernata*). Brewer's blackbird (*Euphagus cyanocephalus*).
 Baltimore oriole (*Icterus galbula*).
 English sparrow (*Passer domesticus*).
 Warbling vireo (*Vireosylva gilva*).
- Cabbage worm (*Pontia rapæ*).....Chippy (*Spizella passerina*).
- Cabbage looper (*Autographa brassicæ*)....Boat-tailed blackbird (*Megaquiscalus major*).
- Diamond-back moth (*Plutella maculipennis*). Blackbirds.
- Cutworms (*Noctuidæ*).....Starling (*Sturnus vulgaris*).
 Western meadowlark (*Sturnella neglecta*).
- Climbing cutworms.....Western crow (*Corvus brachyrhynchos hesperis*).
- Catalpa sphinx (*Ceratomia catalpæ*).....Yellow-billed cuckoo (*Coccyzus americanus*).
 Black-billed cuckoo (*Coccyzus erythrophthalmus*).
- Tomato worm (*Protoparce carolina*).....Crow (*Corvus brachyrhynchos*).
- Army worm (*Cirphis unipuncta*).....Bronze grackle (*Quiscalus quiscula æneus*).
 Yellow-headed blackbird (*Xanthocephalus xanthocephalus*).
 English sparrow (*Passer domesticus*).
 Vesper sparrow (*Pooecetes gramineus*).
 Migrant shrike (*Lanius ludovicianus migrans*).
- Drop worm (*Ennomos subsignarius*).....English sparrow (*Passer domesticus*).
- Cecropia moth (*Samia cecropia*).....Hairy woodpecker (*Dryobates villosus*).
- Codling moth (*Carpocapsa pomonella*)....Red-shafted flicker (*Colaptes cafer collaris*).

SUPPRESSION OF VERTEBRATE PESTS.

Birds of prey often have been known to greatly reduce the numbers of injurious rodents, and in the Old World cases are recorded in which birds have utterly destroyed invading armies of rodents. No such striking instances have been observed in the Western Hemisphere, although birds rendered valuable service in the Nevada mouse plague of 1907-8, the only outbreak of this kind in the United States, that has been scientifically studied.⁴⁰ It was estimated at the time that bird predators were destroying 500,000 of the mice monthly.

Few birds are considered pests, and fewer yet of those so considered have unusually efficient bird enemies. The English sparrow, generally looked upon as a nuisance about buildings, but whose food habits, as indicated in previous pages, have many good points, is an exception, in that crows, particularly fish crows, which often nest in or near southern cities, sometimes rely upon its eggs and young as a steady source of food. Occasionally the activity of crows in this direction results in a noticeable diminution of the number of sparrows.

Prof. Philip R. Uhler, provost of the Peabody Institute, Baltimore, says:⁴¹

One way, and a very peculiar way, of putting a check on the sparrows has been brought to my attention. Three years ago the Peabody Institute was simply swarming with sparrows. They built nests in the hollows of the balustrade on the roof, in the rain-pipe gutters on the extensions, and fluttered and flew all over the place. They were laying hundreds of eggs upon the roof and about and had gotten so bold as to fly down the ventilators straight into the library. They were almost as thick on the top and steeple of Mount Vernon Place Methodist Episcopal Church, across the street. Besides this our roof was already tenanted by about 500 or more pigeons, kept by the janitor of the institute and his son, who set their traps up there and fed them. One day I noticed a crow on the roof of our building. I saw him look about curiously, up, around, and down where the sparrows' nests were. The next thing he did was to get to work on the eggs. A few days passed, and I saw him again, this time accompanied by two other crows that were at the same scheme. The crows from that time on increased until 12 came to that spot.

Meanwhile there was trouble among the sparrows and the pigeons. Their eggs were being eaten at an alarming rate, and they were obliged to go. And go they did, so that now there is not a sparrow to be found on our roof or about the institute where before there were hundreds. On the Mount Vernon Place Church they have vanished in the same way, and the pigeons likewise have disappeared.

SUPPRESSION OF PLANT PESTS.

Most pests among plants are known as weeds, and by far the majority of weeds depend upon seeds for their continued existence. Many species of birds devour large quantities of weed seeds, but this work is a specialty of the sparrow family. Where they are

⁴⁰ See Farmers' Bul. 352, pp. 21-22, and Yearbook U. S. Dept. of Agr., 1908, p. 309.

⁴¹ Forest and Stream, 51, p. 264, 1898.

abundant they destroy tons upon tons of weed seeds, but only rarely are they able even to locally extirpate any of the very prolific plants known as weeds. Dr. Sylvester D. Judd, late of the Biological Survey, gives the following instance⁴² of great reduction in the numbers of weed seeds:

On one of the Maryland farms visited in 1896 tree sparrows, fox sparrows, white-throated sparrows, song sparrows, and juncos fairly swarmed during the month of December in the briers of the ditches between the cornfields. They came into the open fields to feed on weed seed, and were most active where the smartweed formed a tangle on low ground. Later in the season the place was carefully examined. In a cornfield, near a ditch, the smartweed formed a thicket more than 3 feet high, and the ground beneath was literally black with seeds. Examination showed that these seeds had been cracked open and the meat removed. In a rectangular space of 18 square inches were found 1,130 half seeds and only 2 whole seeds. During the ensuing season no smartweed grew where the sparrows caused this extensive destruction.

PRACTICAL UTILIZATION OF BIRDS IN SUPPRESSING PESTS.

Successful utilization of birds in suppressing pests has been made both indoors and out. In the former case birds have been captured and confined in cellars, granaries, and greenhouses, and in the latter, farm practice has been modified to take advantage of beneficial activities of the birds, or the number of birds on certain areas has been increased by introductions, by protection from enemies, by furnishing nesting sites and building materials, and by supplying food when the natural supply is scanty. Experience shows that efforts to attract birds bring their own reward.

Taking up first the use of birds indoors, we present two accounts of the successful use of owls in destroying rodents. B. H. Warren, formerly State Ornithologist of Pennsylvania, says⁴³ of the screech owl (*Otus asio*):

Some few years ago an acquaintance of mine placed two of these birds in his cellar which was overrun with mice, and in a few weeks the place was depopulated of these little four-footed pests.

The late Dr. W. L. Ralph who was curator of birds' nests and eggs in the United States National Museum, furnished the following note regarding the barred owl (*Strix varia*):

At the Oneida County Brewery in Utica a subcellar was used for storing large quantities of barley. The rats made serious inroads on this grain and destroyed at least \$800 to \$1,000 worth annually. For the purpose of lessening this damage cats were placed in the subcellar on several occasions with the result that when the door was opened in the morning they rushed out showing every indication of fear and desperately resisted any attempt made to take them back. At this juncture two boys brought an owl to the Doctor who purchased it with the idea of liberating it so soon as the slightly injured wing healed. In looking

⁴² Bul. 15, Biol. Surv., pp. 27-28, 1901.

⁴³ Birds of Pennsylvania, p. 154, 1890.

about for a place to keep it during convalescence he thought of the subcellar, which was immediately fitted up with several perches. The morning after the owl was placed in this cellar 9 headless rats were found, and for the next three months varying numbers of headless carcasses were found daily. About this time, however, the rats were becoming so scarce that the owl had to devour the entire animal to secure sufficient food, and finally had to be fed on raw meat. For nearly 10 years afterwards practically no damage was done by rats in this cellar.

Birds have also been successfully employed to destroy insects in greenhouses. In a letter to the Biological Survey, March 27, 1893, R. Bingham, of Camden, New Jersey, says:

I am engaged in market gardening both under glass with artificial heat in winter, and in the open field in summer, and until the past two years used tobacco smoke twice each week to keep in check the aphides or plant lice in our plant houses. But as all insecticides while killing the insects injure the health and dwarf the growth of plants, I tried the more natural, I think the more economical, and certainly the pleasanter remedy, birds. First tried the indigo bird (*Cyanospiza cyanea*) and although a seed-eater it prefers insects. Being small it runs under the lettuce leaves and sometimes disappears for several feet. Also have a pair of mocking birds (*Mimus polyglottos*) in each place. One pair of mocking birds has taken care of the attic garden 20 by 28 feet. One pair of mocking birds, a pair of song sparrows (*Melospiza melodia*), a snow bunting (*Plectrophenax nivalis*) and a winter wren (*Nannus hiemalis*) have kept the insects in check in the larger plant house 25 by 250 feet. Have had much less insect trouble, and healthier and better crops than when I smoked the houses twice each week taking one hour of time for each smoking.

The more natural and desirable use of the services of birds, of course, is that made out of doors which has been done by modifying farm practice to take advantage of the normal useful habits of birds, by introducing birds so as to increase the number in a given area, and by augmenting the bird population by bird attraction methods.

As an example of the first class of these uses, we may cite the recommendations⁴⁴ by Mr. Norman Criddle, of the Dominion Entomological Laboratory of Manitoba, for the control of white grubs. He says:

Birds are most persistent followers of the plough during their breeding season or while migrating, gulls and terns from May 16 to June 22, and for a short time late in July; crows and blackbirds, including grackles, from the time grubs appear in May until July 1. * * * To attain the best possible results ploughing should be done between May 14 and July 1, and at an average depth of 5 inches. * * * Fall ploughing in Manitoba, while accounting for a few pupae in September, is not a practical means of destroying white grubs. Birds at that time have congregated into flocks preparatory to migrating southward and are then more inhabitants of grain fields. Thus, the grubs readily make their way into the ground again.

The introduction of birds for the eradication of pests is a step which should be taken only within the limits of similar faunas or

⁴⁴ Agr. Gaz. Canada, vol. 5, No. 5, May, 1918, pp. 452-3.

with birds strictly under control. Poultry are so used against invasions of insects, particularly grasshoppers, and native birds have been used in a few instances. Mr. Irving C. Emmett, Federal game warden, reports on the usefulness of—

the California Valley quail, which was introduced into Utah some few years ago. For a while the farmers objected to this bird, their claim being that it ate considerable of their grain. The alfalfa weevil was first found in the Salt Lake Valley and gradually worked from there northward and west until it covered a great part of the alfalfa district of the western part of the United States. It was noticed, however, that in some localities the weevil affected the alfalfa but very little, while in an adjoining field the entire crop would be taken. Upon investigation it was found that quail were nesting in the fields in which the weevil had not attacked the alfalfa. A number of the most prominent growers then decided to introduce quail into their fields, and they were captured in the fall and put into boxes and partly domesticated during the winter and then taken out into the alfalfa fields and released in the spring. In almost every case these birds remained near where they were released, and nested in the fields or in the brush near to them. In practically every case where these birds were released the alfalfa weevil disappeared. There is one district in particular where this method was introduced, being a stretch of country about 36 miles long between the cities of Ogden and Salt Lake City, and the experiment worked out so well that the farmers in this district will not allow any hunter to kill any quail on his farm, notwithstanding the fact that they are very liberal toward sportsmen and will allow them to hunt on their lands for other birds, but look upon the quail as one of their greatest friends.

Another instance involving the introduction of birds is reported by Dr. Samuel G. Dixon, late health commissioner of Pennsylvania. He writes:⁴⁵

After trying the ability of fish to devour larvae and pupae of mosquitoes with varied success, I built two dams near together on the same stream, so that each would have the same environment for the breeding of mosquitoes. Each covered nearly 1,400 square feet. In one 20 mallard ducks, *Anas platyrhyncha*, were permitted to feed, while the other was entirely protected from waterfowl, but well stocked with goldfish *Carassius auratus*, variety *americanus*.

The one in which the ducks fed was for several months entirely free from mosquitoes, while the pond protected from ducks and stocked with fish was swarming with young insects in different cycles of life.

To the infested pond 10 well-fed mallard ducks, *Anas platyrhyncha*, were then admitted, and as they entered the pond they were first attracted by the larval batrachians, tadpoles. They, however, soon recognized the presence of larvae and pupae of the mosquito and immediately turned their attention to these, ravenously devouring them in preference to any other foodstuffs present. At the end of 24 hours no pupae were to be found and in 48 hours only a few small larvae survived. The motion of the water made by the ducks, of course, drowned some of the insects—what proportion can not be estimated.

For some years I have been using ducks to keep down mosquitoes in swamps that would have been very expensive to drain, but I never fully appreciated the high degree of efficiency of the duck as a destroyer of mosquito life until the foregoing test was made.

⁴⁵ Journ. Amer. Med. Assn., vol. 63, No. 14, p. 1203, Oct. 3, 1914.

Beneficial results obtained from increasing the bird population by bird-attraction methods have been reported by various observers, among whom Mr. B. R. Bones, of Racine, Wisconsin, gives the following account of some of the benefits he received from encouraging birds.

I commenced as a companion and disciple of Doctor Hoy over half a century ago, and have fitted my place for a bird paradise, with plenty of trees and shrubbery and 1 acre of lawn. Commencing with a single pair of grackles about 20 years ago I have now over 20. * * * I counted 17 on the first furrow plowed this spring. White grubs are about played out, and I have not seen a cutworm in five years.

Mr. E. H. Forbush, quoted a number of times in preceding pages, is convinced that bird attraction pays. He says:⁴⁶

My first attempt at availing myself of the services of the birds in an orchard was made in 1894-95. * * * The winter birds were attracted to the orchard and frequented the trees during the entire winter. * * * In the fall, winter, and spring they destroyed many thousands of the imagos and eggs of the fall and spring canker-worm moths, the eggs of the tent-caterpillar, and probably also the pupæ and imagos of the codling moth, besides scales, tineids, and other enemies of the trees. When spring came, efforts were made to attract the summer birds to the orchard. These attempts met with such signal success that, although most of the eggs and young birds were destroyed by cats, boys, crows, and other agencies, the remaining injurious insects were so completely disposed of by the birds that the trees bore luxuriant foliage during the entire summer and produced a good crop of fruit. This occurred in a season when both the tent-caterpillar and the canker-worm were remarkably prevalent. The only other orchard in the neighborhood that produced any fruit whatever was that of the nearest neighbor. This had been partly protected by tarred bands and partly by the birds from my place. Elsewhere in the town most of the apple trees were defoliated, and very few produced any fruit that year.

Mr. Forbush found birds equally efficient in ridding a garden of weeds.

In our garden [he states⁴⁷] we attempted to keep the weeds in subjection. This in 1900 was almost an impossibility. In 1901 it was a serious task and necessitated frequent weeding or hoeing all summer and into the fall. In 1902 the labor was much lightened, and this was in part due to the birds. All farmers know that, while hoed crops in the main may be kept nearly free from weeds, it is impossible to weed a squash or melon patch without injuring the plants. Such crops invariably foul the land. It is also very difficult to keep all fences and borders of fields clear of weeds. We depended mainly on the birds to take care of such weed seeds as were left in the squash or melon patch or along the borders, and they did their work well.

The first year birds were not numerous enough to destroy all the weed seed; the second year there was hardly enough seed to gather an increased number of birds. A small patch of Japanese barnyard grass was planted north of the garden. The seed of this millet proved very attractive to birds, but it was not molested except by goldfinches and an occasional English sparrow until

⁴⁶ Useful birds and their protection (1907), pp. 150-151.

⁴⁷ Two years with the birds on a farm, pp. 12-14, 1908.

the seed began to fall. The millet was then reaped and the seed saved, but not until a great quantity of it had fallen to the ground.

All the fall and winter this seed proved a great attraction to the birds. Sparrows were almost constantly feeding in the vicinity, and the seed seemed to be relished by all of them. There were probably some bushels of this seed on the ground in the fall, but by spring hardly one could be found and only a very few scattering plants grew there the following spring. This plant is merely a cultivated variety of a common wild grass or weed, hence its attractiveness to birds.

Juncos and tree sparrows came in greatest numbers. They not only destroyed the millet seed but they also found and ate practically all of the weed seeds remaining. * * * Our work in conjunction with that of the birds had been so efficient in exterminating the weeds that during the winter of 1901-2 it frequently was necessary to scatter chaff and hayseed from the barn floor around the dooryard to provide sufficient food for the birds.

ATTRACTING BIRDS.

There is no reason why cultivators in any part of the United States should not avail themselves of the advantages to be derived from an increase in the number of birds. The basic principles of attracting birds are simple. They include as perfect protection as possible against all enemies, provision of food in the season of scarcity, of nesting boxes for the species which will use them, of nesting sites and even materials for the others, and of a constant supply of water both for bathing and drinking in a place where the birds using it will be safe. Detailed information on the subject of attracting birds may be obtained from publications of the United States Department of Agriculture.

SUMMARY.

While birds may exercise a noticeable degree of control of an injurious insect over an extensive range, actual suppression is accomplished usually only in very limited areas.

However, as appears in the preceding pages, instances of the local suppression of pests by birds are sufficiently numerous to have attracted the attention of many observers.

Omitting references to vertebrate and plant nuisances, the instances cited relate to 32 insect pests, most of which are exceedingly injurious. In more than 70 cases birds apparently exterminated one or another of them locally or at least have so reduced them that no further damage ensued. In many of these cases the saving of a crop seemed to be due solely to the work of birds. It goes without saying that we have accounts of only a small proportion of the instances of pest suppression by birds that have actually occurred, and there is no doubt that the work of birds along this line has been of great value to American agriculturists.

It is most encouraging, therefore, that it has proved possible to make practical use of birds in destroying pests. Certain birds of prey have been used in granaries and other storage rooms to clear them of rats and mice, and small insectivorous birds have done good service in greenhouses. The beneficial results of attracting birds to farms and gardens are striking. They indicate, moreover, that even greater results may be expected when more organized and widespread efforts are made to increase the number of birds.

THE OCCULT SENSES IN BIRDS.¹

By HERBERT H. BECK,

Franklin and Marshall College, Lancaster, Pa.

That animals below man, in the accepted biological line, have retained in efficient form much that has been greatly reduced or nearly lost in the process of developing nature's master product—the human mind—is a fact of common knowledge. The senses of sight, smell, and hearing in man are almost rudimentary when compared with the same senses as developed in the hawk, the setter dog, and the fox.

It is not so generally recognized, though none the less perhaps a fact, that certain senses widely or selectively a part of animal life are absolutely gone in man. So thoroughly are these senses atrophied or lacking in the human mind that man, with all his highly developed imagination, can not even vaguely visualize the subtle processes by which they operate.

In bird life one of these occult senses, the homing sense, exists to a remarkable degree. The complex phenomena of migration, often over trackless regions, the homing acts of pigeons, and the speedy returns over unfamiliar sea courses of sooty terns taken a thousand miles from their nests can not adequately be explained on the basis of acuteness of vision or persistence of memory in the birds that make these wonderful flights. There apparently is something entirely apart from human consciousness or subconsciousness that holds the bird to a true course between widely separated points.

The homing sense is broadly, though somewhat selectively, distributed among animals. It is exhibited by many insects and by some mammals. It only finds its greatest development in birds.

Nor is there anything supernatural about this seemingly occult faculty. It probably is only a common trait of animal life strongly carried through in certain groups. A highly efficient homing sense is but an example—like the keeled sternum in birds or the mind in man—of a well-established principle of progressive evolution. The inordinate development in selected species of organ or sense common to many is a course so regular in nature that it can not be considered an irregularity.

¹ Presented before the Delaware Valley Ornithological Club. Reprinted by permission from *The Auk*, Vol. XXXVII, No. 1, January, 1920.

Akin to this homing sense and operating in a way equally intangible to man there exists, in all probability, a food-finding sense. Widely distributed and occasionally highly specialized within several lower groups, notably the insecta, the food-finding sense has persisted in only a limited way among vertebrates. There is little evidence that it exists among mammals. It is somewhat broadly a part of bird life, and among birds it seems to be most highly developed in the carrion feeders.

In many species of birds doubtless only an adjunct to activity in ranging or acuteness of vision, the food-finding sense—at least on the basis of strong presumptive evidence—is so highly developed in certain individuals among these carrion feeders that it can act independently of the known senses.

Many of the writer's observations on food finding in turkey vultures (*Cathartes aura septentrionalis*) have been insufficiently explained by the common theory that these birds are directed to their food by the senses of sight or smell. But the most striking observation—and the one which most strongly leads him toward a belief in a definite food-finding sense—is an incident the facts of which are as follows:

At daybreak, January 1, two hunters, one of them the writer, were out with their pack of foxhounds in the farming valley of the Little Conestoga south of Lititz, Lancaster County, Pennsylvania. The bottom was bare of snow, though it was gray white with a heavy frost. The morning was quiet, practically windless, and the temperature was about 28°—just cold enough to keep the ground firm. The scene had in it all the charm that attends starting a fox at winter sunrise. The voices of the hounds on the twisted night track were rapidly going up toward the happy burst that would tell of jumping the fox—when something went wrong. The music changed its tone and the younger hounds began to straggle in toward the horses; and then with the rest of the pack, and striking right and left among the hounds, came the cause of the breakup—a mad dog.

To borrow a gun, kill the dog, and throw his carcass into a limestone sink hole was the work of about half an hour. It was then 9 o'clock. Three hours later, at the request of a local veterinarian who wished to examine the dog, I returned to get the carcass. As I neared the hole two vultures climbed out and flapped away. They had been at the dog evidently some time, for the flesh about the hams was much eaten away.

There were two unusual features in the situation which, as the mind dwelt upon them, made the presence of those vultures in the sink hole most impressive, if not uncanny.

The first of these was that there was no winter camp of the vultures nearer than the southern slope of the South Mountain—8 miles

north of the spot. This roost, above the Speedwell farms, always had fifty to a hundred birds about it, and the vultures apparently stayed near the South Mountain. I have rarely, if ever, seen vultures ranging in the Little Conestoga Valley during the winter before or since the incident.

The second was that the dog was invisible from any part of the sky. The sink hole was 6 or 7 feet deep, with an opening of about 3 feet. The shaft, inclined toward the south, went down at an angle of about 45°, and the walls were so irregular with projecting rocks and soil that the carcass at the bottom was completely hidden from view.

Under the existing conditions it is difficult to account for the finding of the carrion by either eye or nose sense in the vultures. The dog being invisible and there being no vultures in the neighborhood when it was thrown into the hole, sight could scarcely have been involved; and the possibility of a freshly killed dog at the bottom of a 6-foot hole giving off enough scent in midwinter to attract birds miles away is out of the question, even after eliminating the fact that the sense of smell is but poorly developed generally among birds.

Assuming the correctness of the theory of a food-finding sense as it exists to-day in certain species, the imagination naturally runs back to the earlier stages in the evolution of these species. Given by nature the right to life—if life can be maintained, and the first essential of continued existence, food—it is perhaps logical and it is certainly well supported by analogies, that chance superiority in food finding would develop into something of permanent value in the species, and that the sense thus evolved would be the determining factor of survival among a host of related forms many of which succumbed in the struggle for existence. And it is reasonable, too, that this food-finding sense should have been most highly evolved during centuries of widespread forest areas, and that it should have persisted up to the present times in those species which were high soaring and carrion feeding; for logically, among the *Raptores* where hunting and killing powers were lacking, subsistence depended upon food that must have been, almost invariably, concealed as well as fortuitous.

Again assuming that two leading essentials for the maintenance of the species—finding food and finding the home—had been assisted by specialized senses, it should follow that the third prominent factor—mating—had been similarly safeguarded.

While there is no convincing evidence at hand in support of a definite mate-finding sense among vertebrates, there are many baffling incidents of field observations which would find explanation in such a theory.

In insect life, however, there is evidence which if not conclusive is strongly contributive. Thus a common wasp, *Pelecinus*, has been known and collected almost invariably in the female form. Specimens taken are always fertilized. Apparently rare to a mysterious degree, the male wasp has seldom been collected or observed. A well-known entomologist conceived the plan of rearing a female *Pelecinus* from the pupa. Properly caged the virgin wasp was placed out of doors. Within a few hours the screens of her cell were swarming with the mysterious male of her species. These wasps may have been guided by some highly refined phase of a well-known sense, but it seems unlikely.

Unfortunately research on these occult senses is difficult—often impossible. Theories have to be based upon analogies and chance observations. Under these conditions chance observation must assume a somewhat greater significance than ordinarily is placed upon it.

On the basis of some impressive though fragmentary evidence then we are justified in assuming—at least as an attractive and perhaps stimulating working hypothesis—that intimately interwoven with the life histories of thousands of animal species of past ages and many species of the present day there is an active sense which may be called occult simply because it is hidden from the experience and understanding of man. This occult sense, involving direction, has taken three phases as developed by the prime necessities of life—food, mate, and home in their relations to space. The purely defensive or offensive elements that have determined survival have evolved chiefly along physical and chemical lines in animals and finally along mental lines in man. All phases of the occult sense have long since been lost in the channels of life that progressed toward civilized man; they exist only selectively in animals below man to-day; but they are still an important factor of existence in many life forms, as they have been a potent determinant in past ages.

ADVENTURES IN THE LIFE OF A FIDDLER CRAB.

By O. W. HYMAN,
Fellow in Biology, Princeton University.

[With 6 plates.]

One of the most widespread and familiar crustaceans of the coasts of the United States is the fiddler crab. On the Atlantic coast this small and active crab is abundant in the marshes and along the beach from Cape Cod southward. Every child that lives by the sea or spends a part of the year building houses on its sandy beach or wading along its shallow shores is sure to make the acquaintance of the sand fiddlers. The child's excited glee when a female has been captured or pained indignation if the captive has been a pinching male is enough to introduce the fiddlers to a wide circle of older folks. The fiddler crabs are almost as well known to seaside people as the butterflies are to inland dwellers.

THREE KINDS OF FIDDLERS.

To scientists this common species of shore crabs is known as *Uca pugilator*.¹ They occur in droves of thousands on favorable beaches. The beaches that are most favorable are those on which there is an expanse of rather clean sand exposed at low tide and conditions are even better for the fiddlers if there is a growth of sedges near the high-water line. The sedges form a ready refuge for the crabs when they are frightened. Since this species is especially partial to a sandy habitat it may well be designated as the sand fiddler—a name that is already given to it locally. The sand fiddler is a small crab, being, as a rule, about two-thirds of an inch broad across its body and something less than 2 inches between the tips of its outstretched legs. The color of the crab is, in general, a gray which matches very well the color of wet sand. However, if one examines the upper surface of the body more closely he will find there an intricate pattern of violet, lavender, pink, and black. The great claw of the male is generally white with few color markings.

¹ Formerly known as *Gelasimus pugilator*.

There are two other species of fiddlers that are well known to scientists although they are rarely differentiated by other observers. One of these is *Uca pugnax*. Whereas *pugilator* prefers to make its home in the sand, *pugnax* is essentially a mud lover. It frequents muddy estuaries along the sounds of the coast and dwells among the roots of the sedges far out on the marshes. This species is probably as abundant as the sand fiddler, but it is less often seen. *U. pugnax* may well be called the marsh fiddler. There is no easy or definite way of distinguishing them from the other fiddlers. They are generally somewhat smaller than sand fiddlers, and, in accordance with the dark background of their abode, they are darker in color. Their upper parts are generally dark olive green, which shades off into the soiled yellow color of the under parts and legs. Sometimes the upper parts are dark blue instead of green.

A third species of fiddler is known as *Uca minax*. This form is not so abundant as the other two and is generally found in rather remote localities. It is often found at the borders of pools out on the dunes, where the water is brackish or nearly fresh and at times will dig its burrows in the sides of ditches 2 or 3 miles from salt water. Brackish-water fiddler, although an awkward name, seems to be the most appropriate one for this species. Again, the differences between it and the other species are relative only. It is larger than either the sand fiddler or the marsh fiddler. In color it resembles the former rather closely though it often has much more red in its markings.

HABITS OF THE SAND FIDDLER.

As has already been noted the three species of fiddlers are so closely similar to each other in structure that they are differentiated by relative differences only. As would be expected, the developing young of the species are equally difficult to distinguish and a description of one may well serve for all three. The habits and development of *U. pugilator*, the sand fiddler, only will be referred to in the following description.

Instead of the bellicose appellation, *pugilator*, which scientists have bestowed upon them, the common name, "sand fiddler," is much more appropriate to the little crabs. They are quite wary and are comparatively harmless even when cornered. Only the males possess the large claw, which has given rise to both scientific and common names for the species. This claw, which is almost as long as the span of the walking legs from tip to tip, is generally carried held in front of the body somewhat in a position of a fiddle, which it also resembles in shape. When one of the males is caught he may use the large claw for pinching, but the crab is so small that the pinch is comparatively ineffectual. It will draw blood from only

the tenderest finger, and it is not to be compared with the powerful pinch of the blue crab (*Callinectes*) or stone crab (*Menippe*). Furthermore, the attack is altogether that of a cornered animal eager to escape and lacks the truly vicious quality of the attack of the blue crab.

The sand fiddlers are agile runners, but are easily overtaken by a man. As a protection from their enemies they rely in the main upon their burrows. These are dug along the beach just below the high-tide line and extend downward a foot or more at a very steep angle. When the tide comes in the crabs crawl into their burrows and the beating of the wavelets soon stops their doors with sand. When the tide begins to ebb and leaves the wet beach the fiddlers dig themselves out again. The excavated sand is gathered in wet balls and distributed at a distance about 6 or 8 inches from the opening of the burrow. It is to be expected that the next time the fiddler enters his burrow he will be in a hurry and want a clear road. After he has made sure of his means of retreat he joins his companions at the water's edge.

Each wavelet of the receding tide casts up on the beach a tiny "windrow" of sand. There is much more than sand in this "windrow," however. Among the sand grains are caught and left countless numbers of microscopic plants and animals that dwell at the surface of the sea. The fiddlers walk along the "windrows" as they are formed and with the spoon-shaped tips of their smaller claws or hands scoop up the food-laden sand and stuff it into their mouths as fast as their hands will work. At meal times the females have an advantage. Both of their hands have spoon fingers and both are kept busy. The crabs seldom enter the water, although their station so close to the water's edge exposes them to many a ducking in the wavelets. At times, too, when an enemy approaches from the land side the fiddler may elect to hide in the water, partially burying himself in the loose sand, rather than run for the burrow. These short intervals in the water are the most hazardous periods in the lives of adult fiddlers. Blue crabs like to lie in the shallow water and wait for little fish that get stranded, and they have learned that they can also pick up a considerable number of fiddlers. When the tide begins to rise and no new "windrows" are left on the beach the fiddlers will wander elsewhere in search for food. They will climb about over stones or piling at the water's edge and always there are a few that lose their footing in spite of their eight legs and fall overboard. A fiddler overboard is a fiddler lost. They can not swim, and hungry fishes, like the black sea bass and the sheepshead, quickly gobble them down.

Although there is a continual daily loss of their members, the droves of fiddlers on the beach do not get smaller year by year. The

pugnacious and swift blue crab is unable to hold its own, and the powerful stone crab is almost extinct over part of its range, but the small and comparatively helpless fiddler maintains its millions undiminished. There must be large numbers of young fiddlers growing up each year to take the places of those that feed blue crabs and fishes.

HOW EGGS ARE LAID AND HATCHED.

A study of the female fiddlers shows that they produce and hatch their eggs much as do all crabs and shrimps. The higher crabs (*Brachyura*) differ most conspicuously from the lower crabs (*Anomura*) and shrimps (*Macrura*) in the relative size of the parts of the body. In the higher crabs the cephalothorax forms the boxlike region that comprises most of the body. The abdomen is relatively quite small and is carried permanently flexed under the cephalothorax, which has a groove to accommodate it. The appendages of the abdomen are usually concealed between it and the cephalothorax. The abdomen of the male fiddler is narrow and bears only two pairs of appendages. These are used to transfer the sperm to the female. The abdomen of the female is much broader and it bears four pairs of genital appendages.

The female crab lays her eggs in the early spring. Hundreds of them are laid at one time. As they pass from the oviduct they are entangled in a sticky fluid that covers the genital appendages. This fluid then hardens and the eggs are left hanging to the appendages like many bunches of tiny purple grapes. The bunches are packed very closely together, however, and there are so many of them that the abdomen is pushed far out of its groove and hangs down from the body. The color of the eggs is due to the yolk, which, instead of being yellow as in the bird's egg, is a dark purple. The eggs were fertilized as they were laid and at once begin to develop. As the embryos are formed inside the egg shells the yolk is used up and the color of the egg mass gradually changes from deep purple to light purple and at length to a dirty gray. When the mass is gray the embryos are nearly ready to hatch. The female aerates the eggs by standing in the water and jerking the abdomen backward and forward.

Since the fiddlers may be supposed to be very prolific, one expects on examining the droves during the spring and summer months to find many of the females carrying eggs. On the contrary, however, one may examine thousands of the females on the beach without finding a single one egg-laden, or even dig them from their burrows by the hour and find very few. This is due to the fact that one searches the beach by day, and the only burrows whose locations are shown by openings are those whose occupants are out on the beach. When carrying an egg mass the females are clumsy. They run

awkwardly and have difficulty in entering the burrows. It is doubtless on this account that the egg-carrying females remain hidden in the burrows during the day. After dusk, however, they go down to the water's edge with the others when the tide is ebbing.

While the egg-laden females come out to feed at any time after dusk, there is a very definite time for the embryos to hatch. Hatching always occurs just at dusk—that is, between 7 and 8 o'clock. The mother crab comes down to the water's edge and fans her abdomen back and forth to aerate the eggs as usual. If the embryos are ready to hatch, however, the little larvae burst out of the egg shells and at each forward flirt of the abdomen a small spray of young larvae is shot forward into the water. If the female is not disturbed, this continues for 15 to 20 minutes until all the embryos are hatched. It is hardly to be thought that the female ever washes the eggs with the purpose of aerating the embryos. It is possible that she is merely trying to rid herself of a burden. On the evening when the embryos hatch, the washing continues for an unusually long time, possibly because the burden on the abdomen is gradually being thrown off.

In many crustacea the female molts very soon after her eggs hatch. The old body shell, with the remnants of egg shells sticking to it, is shed. Whether such a molt occurs among the fiddlers is not known. Since the crabs molt in their burrows, observations on their moltings are seldom made. It is also known that in many crustacea a new batch of eggs is laid as soon as the old ones have hatched. This may occur after a molt, as in many shrimps, or without a molt intervening, as in the stone crab (*Menippe*). This has not been determined for the fiddlers either, but it is possible that each crab lays several times during the warmer months, because egg-bearing females are found from early spring until late September.

HAZARDOUS EARLY LIFE OF THE LARVA.

The young crab that is suddenly shot from the shelter of its mother's abdomen out into the teeming sea is exceedingly minute. When fully extended it is about a millimeter long, but in swimming the body is bent double, so that the swiftly moving larva is only about half a millimeter in length and the same in width. It is just visible to the unaided eye. The structure of the crab larva is so different from that of the adult crab that scientists of the eighteenth and early nineteenth centuries described the larva as an entirely separate genus of crustacea and gave it the name *Zoea*. Although it was discovered by Thompson in 1835 that the genus *Zoea* was made up of the newly hatched larvae of various crabs, the name *Zoea* has been retained to describe all crustacean larvae

that resemble the newly hatched crab larvae, just as caterpillar describes a certain form of larva among the insects.

The body of the zoea (figs. 1 and 8) is divided into two regions, cephalothorax and abdomen, just as is that of the adult fiddler. The cephalothorax of the larva, however, is very different from that of the adult. Instead of being flattened from above downward it is flattened from side to side as are the bodies of many other swimming forms, *e. g.* shrimps. It is covered by a shield or carapace dorsally and laterally. Laterally the carapace extends downward over the bases of the appendages. Posteriorly it has a broad, deep notch, through which protrudes the abdomen. At just about its central point, dorsally, the carapace is produced upward into a stout, slightly recurved spine. (Fig. 1, a.) Another spine of this kind extends ventrally from the anterior margin of the carapace. (Fig. 1, b.) It is difficult to imagine how these spines may be of use to the zoea. Blood circulates through them and it may be aerated in its passage. On the other hand the spines often become entangled in floating débris or algae and the larva is unable to free itself. Whatever may be their service to the zoea, however, the spines are of definite use to the scientist. They enable him to distinguish the zoea of *Uca* from that of most other crabs. Most crab larvae have a dorsal spine, an anterior spine and two lateral spines on the carapace. The zoeas of the fiddler crabs and some of their relatives lack the lateral spines.

The abdomen of the zoea is a segmented cylinder. It is divided into five parts, and each of these is a simple, short cylinder, except the terminal segment. This is produced posteriorly into two long laterally diverging horns. The abdomen is carried flexed under the cephalothorax in swimming, although not pressed up against it as in the adult. It is not used as an organ of locomotion, but when the zoea comes to rest on the bottom, or is swept against an obstruction of any kind, the abdomen lashes out and about, and the larva squirms and wriggles in very lively fashion.

On each side of the anterior part of the cephalothorax there is a large compound eye. These are not borne on stalks as in the adult and they can not be moved in any way. They resemble in this respect the eyes of such lower crustacea as the water-flea (*Talorchestia*), pill-bugs (*Oniscus*), and *Cyclops*. The color of the eyes is dark green, almost black. In spite of the large size of the eyes, the zoea can not see in the sense of distinguishing shapes. It can, however, differentiate different intensities of light. This ability makes possible one of the most important tropisms of the larvae. They always swim toward a region where the light is brightest. This serves to keep them at the surface of the sea in spite of the fact that they have no organ of equilibration. When the zoea bursts from its egg

shell it at once swims to the surface of the water. There it finds conditions that give it a chance to survive. It is swimming among countless larvae of other crustacea and mingling with the young of worms and mollusks and starfishes and jellyfishes, not to mention hosts of minute forms such as lower crustacea and small jellyfishes and protozoa. Besides these animals there are millions upon millions of microscopic plants swimming and floating along. In this world of tiny forms, young fishes swim about as devouring giants. They take toll of all the smaller forms alike and many of the zoeas are eaten. It is well that they are hatched at dusk and have all night to be scattered by the tide before they enter upon the adventures of their first day.

The body of the zoea is composed of a head and abdomen, between which lies a small region representing the thorax. (Fig. 1, f.) The seven pairs of appendages of the zoea are attached to the ventral surface of the cephalothorax. It is from their attachments that we know that most of the cephalothorax is composed of the head region and only a small part of it is the thorax. Moreover the region of the legs or pereopods which forms the largest part of the adult body is represented in the zoea by a minute area in the region where the abdomen is joined to the cephalothorax.

The first two pairs of appendages, the antennules (fig. 2) and antennae (fig. 3), are sense organs just as in the adult. They are quite different from those of the adult, however, in both structure and function. The antennules are little more than knobs on the surface of the head, each bearing a few sensory hairs at its tip. They show no sign of a statocyst, or organ of equilibration. Some of their hairs are tactile and others are sensitive to chemical changes in the water, whether this be called taste or smell. The antennae are queer, spikelike appendages extending down parallel with the frontal spine of the carapace. Each bears a movable process, the exopodite, on its lateral surface. The exopodite bears one or two minute tactile hairs at its tip.

The other three pairs of head appendages form the mouth parts of the zoea. They resemble very closely the same parts in the adult in their essential structure. The mandibles (fig. 6) are simple blades with their median borders produced into denticles for cutting and mashing the food. They do not have sensory palps. The maxillules (fig. 4) are flattened plates. The basal segment of each is produced into two median lobes, each of which has stout spines at its tip. These lie just laterally to the mouth and posteriorly to the mandible. Each maxillule bears a small palp with tactile hairs. The maxillae (fig. 5) also are flattened appendages. Their basal segments are produced into median lobes with spiny tips. There is also a palp with tactile hairs and laterally the scaphognathite is already developed. These

three pairs of appendages act together as very effective instruments for securing food. The scaphognathites beat rapidly and continuously in such a way as to draw a stream of water backward past the mouth and along the bases of the mouth parts. As the zoeas live in the thickly populated surface area of the sea, this stream of water will contain some of the small animals and plants that abound there. When such an animal touches the hairs of one of the tactile palps the spiny lobes of the maxillules and maxillae close in upon the prey and secure it for the mandibles. It is pushed up between these and they crush it. There is a hairy lip in front of the mouth (fig. 1, d) and another behind it. These serve to guide the food to the mouth opening.

The two pairs of thoracic appendages that are present in the zoea are the first and second maxillipeds. (Fig. 9.) The absence of the third maxillipeds serves to distinguish the zoeas of the higher crabs (*Brachyura*) from those of the lower crabs (*Anomura*) and shrimps (*Macrura*) in which the third pair of maxillipeds are also present. The maxillipeds of the zoea are very different from those of the adult, both in structure and in function. Each is composed of a basal segment bearing two distal rami. The outer ramus, or exopodite, is a simple rodlike segment which bears four long plumose hairs at its tip. The inner ramus, or endopodite, is a segmented cylinder. It bears a few tactile hairs scattered along its segments and the terminal segment bears a short plumose hair that may possibly be "auditory" in the sense that it enables the zoea to perceive vibrations in the water. The endopodite of the first maxilliped has five segments while that of the second had only three.

The chief function of the zoeal maxilliped is locomotion. The exopodites beat rapidly up and down in such a way as to drive the little animal upward and forward. Each of the plumose swimming hairs is jointed near its middle so that it bends on the up stroke and straightens on the downward beat. The zoeas swim actively nearly all the time. Their efforts, however, are chiefly to keep at the surface. The tides serve to carry them from place to place. As the zoeas are hatched on an ebb tide most of them will be swept away to sea in a few hours and by dawn they will be widely scattered. Locomotion is not the only function of the maxillipeds. The endopodites are organs of touch and possibly of "hearing." The entire body of the young zoea is covered by a thin layer of chitin that is tough and inelastic. There has not yet been any calcification in the chitin and so it is very transparent. Many of the internal organs may be seen easily. The heart lies just beneath the base of the dorsal spine. It beats rapidly but quite irregularly, stopping for a minute or two at times.

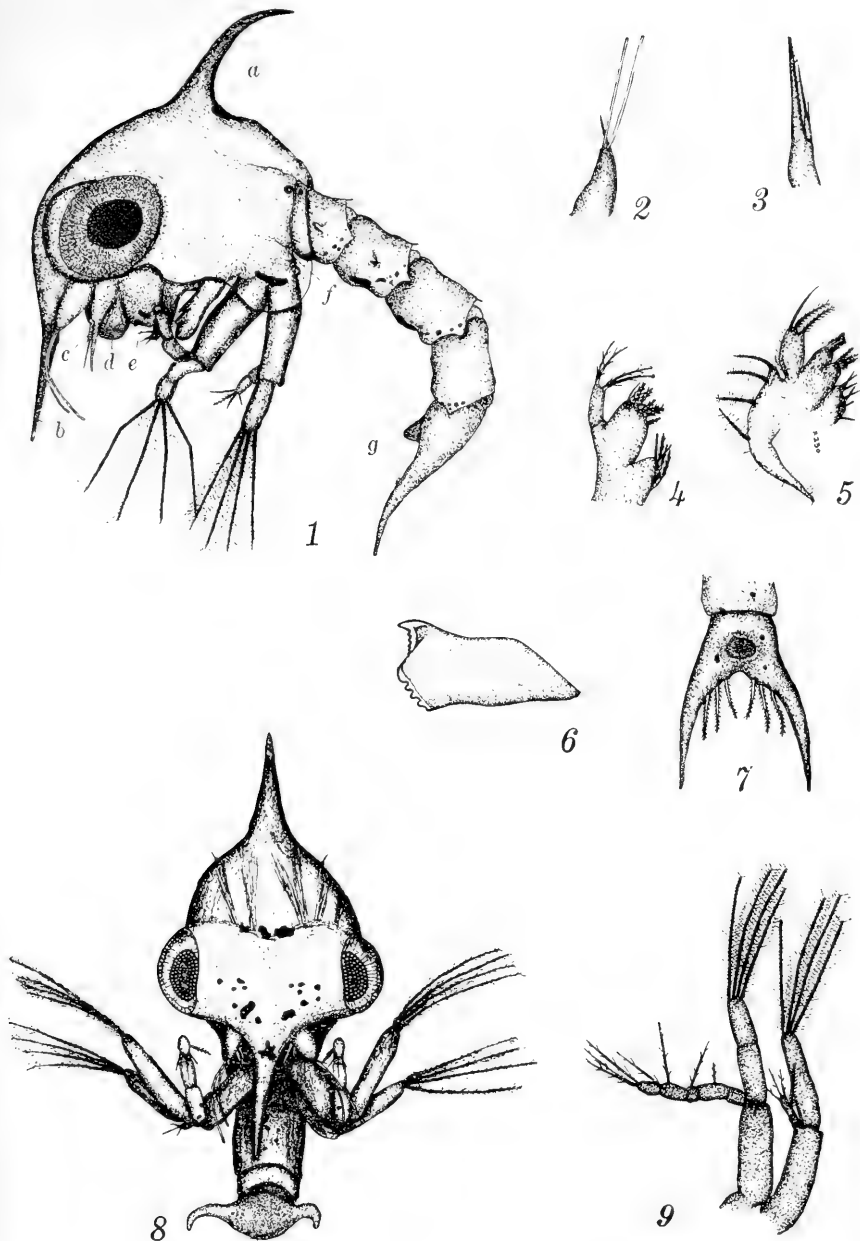

1. First Zoa, lateral view; *a*, dorsal spine; *d*, labrum or upper lip; *c*, mandible; *f*, region of future periopods; *g*, anal protuberance.
2. Antennule.
3. Antenna.
4. Maxillule, ventral view of right maxillule.
5. Maxilla, ventral view of right maxilla.
6. Mandible. Left mandible (this is from third Zoa instead of first).
7. Sixth abdominal segment and telson, ventral view. (Part of fifth abdominal segment is shown.)
8. First Zoa, frontal view.
9. First and second maxillipeds.

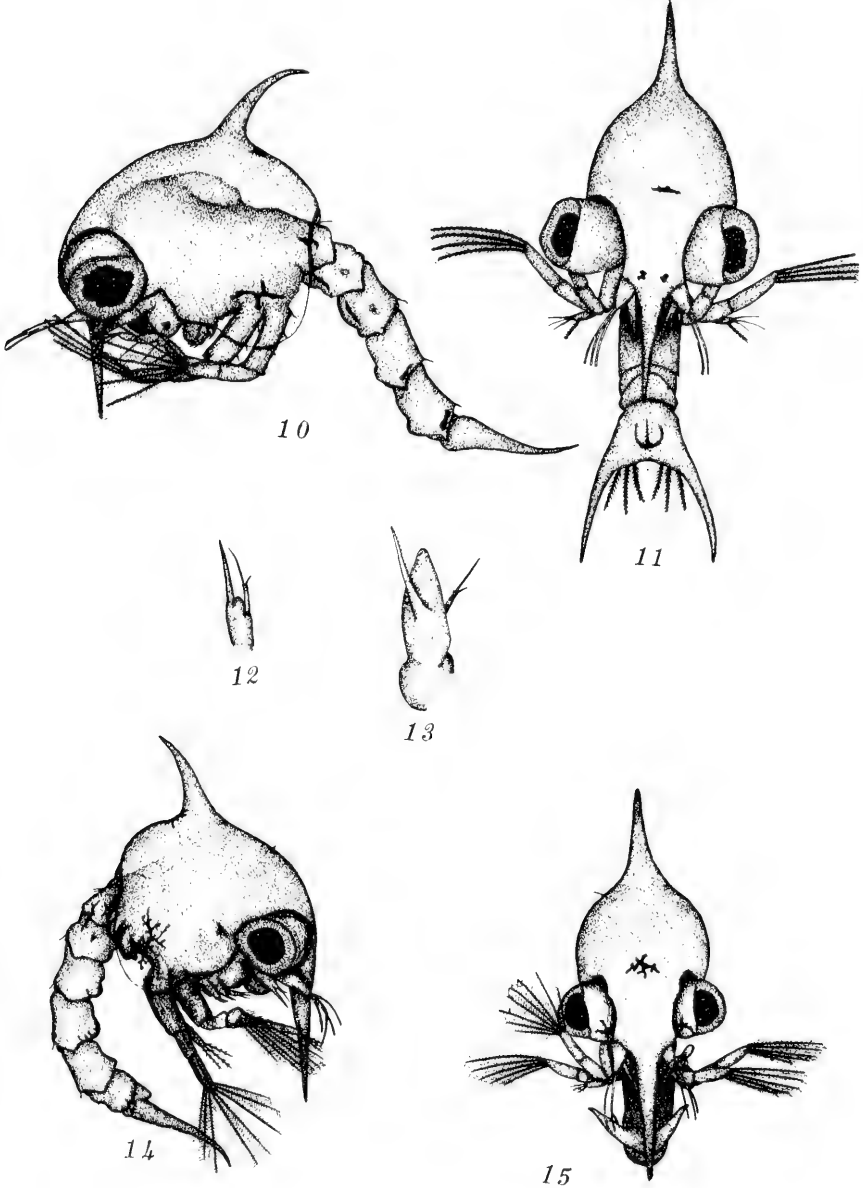

10. Second Zocia, lateral view.
 11. Second Zocia, frontal view.
 12. Antenna of third Zocia showing tubercle of flagellum.
 13. Antenna of fourth Zocia.
 14. Third Zocia, lateral view.
 15. Third Zocia, frontal view.

The parts of the alimentary canal may be seen, the intestine in active peristalsis. Many of the muscles and much of the nervous system are also visible.

The only color of the larva is that of the eyes and the pigment spots. The pigment is jet black when fully contracted, but in the expanded condition shows colors ranging from orange through red-brown to olive. The pigment spots have a perfectly definite distribution over the body. They may be of considerable help in identifying the zoeas of related crabs. For instance, it is very difficult to discover any other easy means of distinguishing the zoeas of fiddler crabs from those of wharf crabs (*Sesarma cinerea*) or purple marsh crabs (*Sesarma reticulata*). They may be distinguished easily and certainly by the fact that those of the fiddlers have a pigment spot at the *distal* end of the basal segments of the first maxillipeds, while the spot is at the *proximal* end of the same segment in *Sesarma*.

When the zoea is thrown out into the water by the flip of its mother's abdomen, it at once begins to beat its maxillipeds and wabbles up to the surface. It is soon swept out to sea by the tide and begins to feed upon the smaller of its countless companions. For the next four or five days the zoea continues to float in and out with the tide. Occasionally the maxillipeds cease beating and the body slowly sinks, only to be driven back to the surface in a few moments. All the time the mouth parts are catching, crushing, and swallowing tiny animals and plants. As a result of this feeding the zoea begins to grow. Its inelastic chitin coat soon becomes too small. A new covering of larger size is formed beneath the old. For a short time now the zoea becomes motionless and sinks toward the bottom. The old coat then splits along the back at the place where the abdomen joins the cephalothorax. The zoea first pushes its body through the slit, and then draws its abdomen and appendages from their old sheaths. This is the first molt. The zoea which emerges is somewhat different from the first hatched zoea and is called the second zoea. The molting period is a perilous time in the life of the zoea. The larva is quite helpless, but fortunately it is almost invisible against the sandy or shelly bottom on which the molt generally occurs.

CHANGES IN THE STRUCTURE OF THE ZOEAE.

The second zoea (figs. 10 and 11) as soon as it is free of the old shell drives upward to the surface again. It is now somewhat larger and stronger and it begins again to feed on its neighbors. The number of swimming hairs on the maxillipeds of the second zoea has been increased to six and so the increased weight of the body can still be maintained at the surface. The large eyes of the zoea

have changed a little too. They are borne on stalks now, and these may rotate slightly in the groove in which they lie, although they can not be raised from the groove.

Of the hundreds of zoeas hatched and set adrift with the tide, less than half live long enough to pass through the first molt. Many are eaten by small fishes and jellyfishes. Others are swept ashore by the tide and may form a part of the food harvested from the sand "windrows" by the old fiddlers. Others become entangled in bits of algae and other débris that float on the ocean and die there. The survivors that become zoeas of the second order continue to float with the tide and feed continually. After about a week they have again outgrown their coat and then undergo the second molt.

When the third zoea (figs. 14 and 15) comes swimming back to the surface it is again larger and heavier and as a compensation the swimming hairs are again increased in number, the exopodite of each maxilliped now carrying eight of them. The weight of the body has increased more rapidly than the power of the maxillipeds, however, and it is more difficult for the third zoea to keep at the surface. It sinks faster when the maxillipeds rest and they drive it more slowly upward. Besides its increase in size the body shows other changes. The chitinous coat becomes spotted with centers of calcification and the shell begins to harden. The dim beginnings of new organs appear.

On the straight spike of the antenna a tiny knob appears just at the base of the exopodite. (Fig. 12.) This is the primordium of the flagellum that forms most of the antenna of adult fiddlers. Behind the bases of the second maxillipeds a series of tiny buds appear on the sides of the body. They appear in the region that represents the thorax of the adult, and they are primordia of the third maxillipeds and the first four pairs of pereopods or walking legs. The buds of the first pair of pereopods are noticeably larger than the others. They will later become the pincers. On the lower surface of each of the abdominal segments except the first there now appear two small buds. These are the primordia of the later larval swimming organs or pleopods.

After another week of feeding and growth a third molt occurs and the fourth zoea is formed. The fourth zoea (fig. 16) is just twice as long as the first zoea. It is getting large enough now to be seen readily with the unaided eye although it is still only 2 millimeters long with the tail extended. All of the primordia that made their appearance in the third zoea have grown larger and the buds of the fifth pereopods have appeared. The telson is now separated from the fifth abdominal segment by a joint. The growth of the body and especially the development of the primordia have made the fourth zoea rather awkward and clumsy. The swimming hairs on the max-

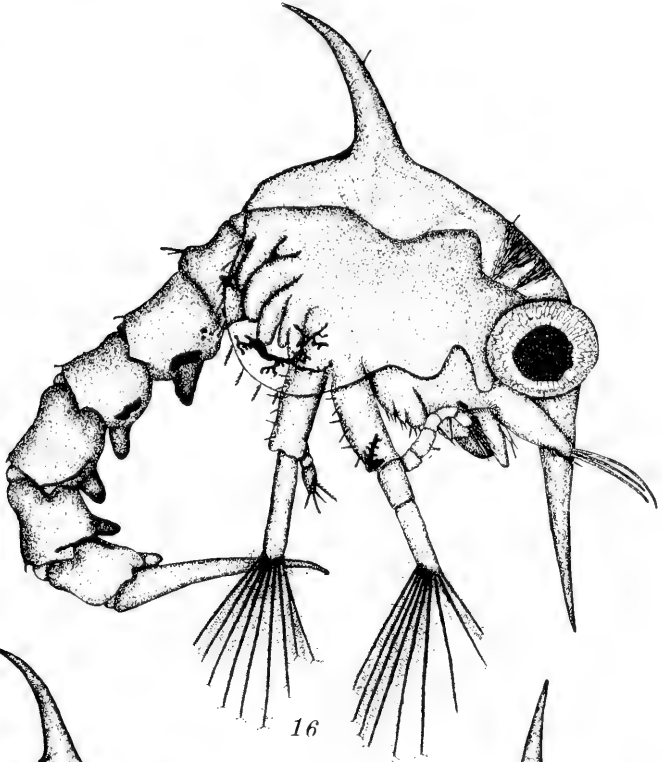

16

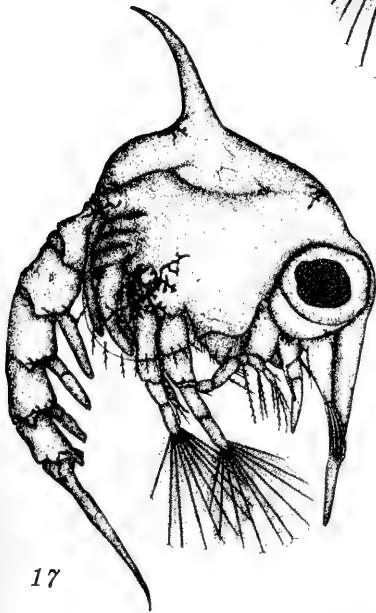

17

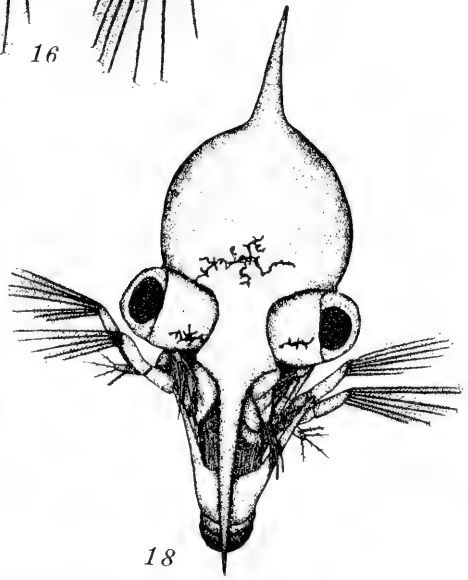

18

16. Fourth Zoea, lateral view.
17. Fifth Zoea, lateral view.
18. Fifth Zoea, frontal view.

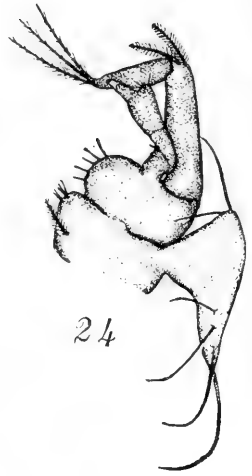

20

23

22

24

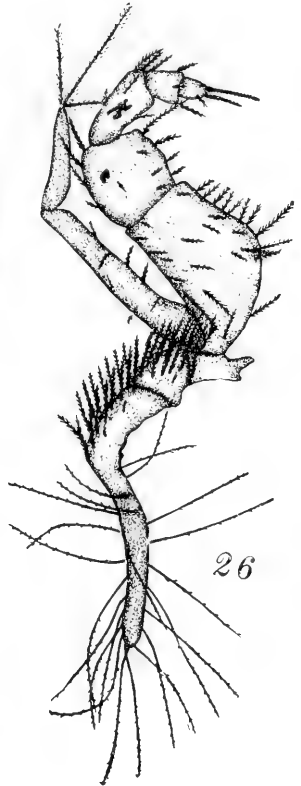
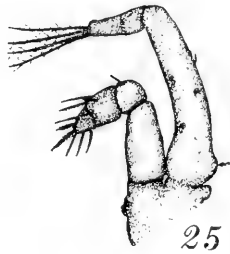
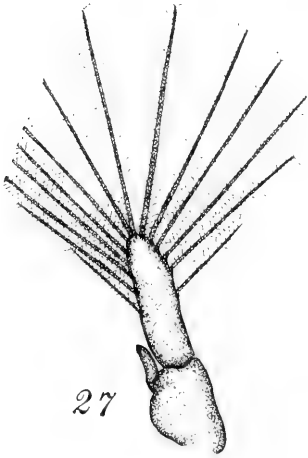

27

25

26



29

28

- 19. Antennule, fifth Zoea.
- 20. Antennule, megalops.
- 21. Antenna, fifth Zoea.
- 22. Antenna, megalops.
- 23. Mandible, megalops.
- 24. First maxilliped, megalops.
- 25. Second maxilliped, megalops.
- 26. Third maxilliped, megalops.
- 27. Pleopod, megalops.
- 28. Endopodite of pleopod, highly magnified.
- 29. Telson, megalops.

illipeds are now 9 or 10, but they are not sufficient and the zoea is on the bottom more often than at the top.

After another week the fourth molt occurs and the fifth zoea (figs. 17 and 18) is formed. This is no longer the graceful, restless, palpitating form of larva that suggested the name *Zoea*, "Life," to describe it. The body is so heavy that the maxillipeds can only keep it at the surface for short periods. Most of its life is spent drifting along near the bottom. The awkwardness of its movements is increased by the greater development of all its primordia. These have no function for the zoea and only serve to impede its movements. In this stage of the larva the antennule shows its first pronounced change. Its basal part becomes swollen and the development of the organ of equilibration, or statocyst, begins within it. (Fig. 19.) The flagellum of the antenna is now elongated and cylindrical. (Fig. 21.) The buds of the thoracic appendages are long and finger-shaped, and at their bases are two or three minute buds that are the primordia of gills. The pleopods are also elongated and finger-shaped.

For a little over a week the fifth zoea struggles along near the bottom of the sea, driving upward a short distance and then settling down again, and all the time being brushed along by the tide. At length it no longer bobs up at all, but merely rolls along with the tide. All movements have stopped except those of the mouth parts and of the internal organs. The maxillipeds are no longer organs of locomotion. The exopodites are shrunken and partially withdrawn from their sheaths of chitin. Other profound changes in the form of the larva are occurring. The flesh is withdrawn from the great spines of the carapace and from the horns of the telson. The flagellum of the antenna and the distal part of the antennule show dim annulations around them. These changes require about 30 hours, and then the zoea undergoes its last molt. It has now been living at sea a little over a month. Of the hundreds hatched only a score or so will have survived. These are rolling helplessly along with the tide when they drag themselves out of their last zoeal shell.

THE MEGALOPS, A BEAST OF PREY.

The larva that stretches itself after jerking loose its last attachments to the zoeal skin could hardly be recognized as derived from a zoea—even the changed zoea of the fifth stage. As a matter of fact, it was described by earlier naturalists as an entirely separate genus and called *Megalops*, from its large and prominent eyes. This name has been retained to describe this stage in the larval history, just as pupa describes the second stage in the larval history of the butterflies. The megalops (figs. 30 and 31) is a larva far different from a pupa, however. Instead of being a motionless, sluggish creature it is a powerfully swimming corsair of the ocean's surface.

All those organs whose growing primordia so encumbered the zoea are now developed and functional. The megalops is about 3 millimeters long. It is easily seen as it darts about the surface. The sensory organs are now well developed. The eyes are large and well formed. In the base of the antennule there is a statolith, and the animal swims about in any direction and can change direction quickly and accurately. It is no longer guided in its movements solely by its reaction to light, but is independent of this tropism and seeks its prey at all depths. It remains at the surface most of the time, however, as food is most abundant there. Besides the statoliths and eyes other sense organs are now better developed than in the zoea. Both the antennule (fig. 20) and antenna (fig. 22) bear numerous hairs that are tactile and also others that are the organs of the chemical sense, taste, or smell. The animal can hear, in the sense that its delicate hairs perceive the vibrations in the water just as the ears of higher animals record the sound waves of the air. These "hearing" hairs are especially located on the antennae and antennules. The antennae now have lost the spine and the exopodite of the zoea, and only the flagellum remains. The first two pairs of appendages are practically in their adult crab condition, although still minute, of course.

The shape of the body is now more that of a crab than that of a zoea, but in some respects it is intermediate between the two. The spines of the zoeal carapace are lost and the body is somewhat flattened from above and below. However it is still considerably longer than broad and in this respect resembles somewhat the body of a shrimp. In fact the megalops may be said in general to have the body of a shrimp or crayfish with the legs of a crab. The abdomen is like that of the crayfish and in swimming is carried extended straight out behind. When the animal comes to rest, however, it is folded under the body and the megalops then looks very much like a tiny crab.

The zoeal mouth parts are very little changed in the megalops. They become larger and more hairy. The mandible (fig. 23) shows one considerable change in accordance with the development of all the sense organs, it now bears a palp, which is an organ of taste and of touch. In addition to the mouth parts of the zoea the megalops has three other pairs of mouth parts. The first (fig. 24) and second (fig. 25) maxillipeds are no longer organs of locomotion. Their exopodites are not now their main functional parts, but on the contrary form rather slender palps that probably have merely a tactile function. The basal portions of the appendages are greatly enlarged and along their median borders bear stout hairs. The endopodites are enlarged and muscular. Their proximal segments bear stout hairs along their median borders and with

similar structures on the basal segments of the appendage these act as mouth parts for holding the food and passing it up to the mandibles. The third maxillipeds (fig. 26) have undergone a wonderful growth. They are now by far the largest and most powerful of the three pairs of maxillipeds. With these changes in structure and functions the maxillipeds reach practically their adult condition. Their further development consists mostly of increase in size and power and the development of their hairs as organs to aid in eating. The six pairs of appendages that form the mouth parts of the megalops are practically the same in structure as those of the adult.

The greatest change in the transformation from zoea to megalops occurs in that region of the body that carries the pereopods or walking legs. This region now becomes the largest part of the body and is considerably larger than the head region. All of the pereopods are well developed and each has practically its adult condition except the fifth. The pincers are large and are well developed. They form effective organs of offense, and the megalops does not swim along the surface and trust to luck to send a few diatoms or protozoa to the spiny basket of its mouth parts. It can see well and swim swiftly. It singles out its prey and pursues it. The food of the megalops consists of any animal small enough for it to cope with successfully. Other smaller crustacea come within this category and many a luckless zoea of its own race falls a prey to the fierce cannibalism of the megalops. The prey is caught and crushed in the pincers and passed back into the grasp of the mouth parts. These prepare it for swallowing. The prey is not bitten into pieces but rather is mashed until it can be crammed whole into the mouth opening. The second, third, and fourth pairs of pereopods are well developed, but are seldom of use to the megalops at this time. They are carried folded in swimming but enable the larvae to cling very tenaciously when it comes to rest on some floating bit of seaweed or bark or when on some rare occasion it has the good fortune to find a bit of decaying meat. The fifth pair of pereopods are peculiar. Instead of ending in pincers or needle points for clinging they end in a tuft of long hairs and the appendages are carried folded up over the back. They seem to be of no use to the megalops. In their position they recall the fifth pereopods of those peculiar crabs that use these appendages for clinging to protecting shells like the clam-shell crab (*Hypoconcha*), or those forms that cling to sponges or sea weeds like the red sponge crab (*Dromidia antillensis*). The gills of the megalops are borne at the base of some of the pereopods.

The abdomen is the distinctive feature of the megalops. It is not like that of either the zoea or the crab. The appendages of the abdomen are now the organs of locomotion. On each of its six segments,

except the first, are two well-developed pleopods or swimming appendages; each of these consists of basal segment, exopodite, and endopodite. (Fig. 27.) The exopodites carry from 7 to 14 plumose swimming hairs. The endopodites (fig. 28) are small and bear two or three curly processes which are said to serve to lock together the pleopods of a pair and insure their beating synchronously. When the abdomen is extended and all the pleopods are beating together they serve as a very effective locomotive apparatus, and the megalops is driven forward with great swiftness. It is perhaps the swiftest swimmer of all the minute animals at the surface. Not many of the crab larvae lose their lives during the megalops stage.

The megalops swims about for nearly a month. Unlike the zoea it does not go through a series of molts during this time, although it undergoes considerable internal development. After some three or four weeks of its roving existence these internal changes begin to affect its swimming powers. The swimmerets or pleopods begin to shrivel up slightly. After this begins the megalops is glad to find some convenient place to cling and hide. Such places are most commonly found in the shallow water near the shore where a rotting board already honeycombed by the tiny tunnels of the wood-boring amphipod (*Chelura*) or an encrusted oyster shell may offer an ideal hiding place. This loss of the power of the pleopods for swimming marks the end of the sea life and adventures of the larva. When these organs lose their function it will never again be able to swim.

The megalops may spend several days or even a week crawling around in its new and temporary shelter. The flesh of its pleopods is withdrawing more and more from the hairy chitinous sheath that made them organs of swimming. At length the megalops molts and out of the megalops shell crawls the first tiny fiddler crab although even at this stage it could hardly be recognized as a fiddler although it is undoubtedly a crab.

CHANGE TO THE YOUNG CRAB.

The young crab (fig. 32) differs most from the megalops in the shape and relative size of its thoracic region and in the changed abdomen. The thoracic region is now distinctly flattened and nearly as broad as it is long. It is quite different in detail, however, from that of the adult fiddler. Its lateral margin forms a wavy line instead of being straight. Up to this time the developing larva has retained practically the same distribution of pigment spots as was characteristic of the earliest zoea. The spots are larger in the megalops and a few additional spots appear in the thoracic region but even in the megalops the distribution of the spots coincides very closely with that of the first zoea. In the earliest crab, however, the entire body is closely covered by numerous small pigment spots rather uniformly

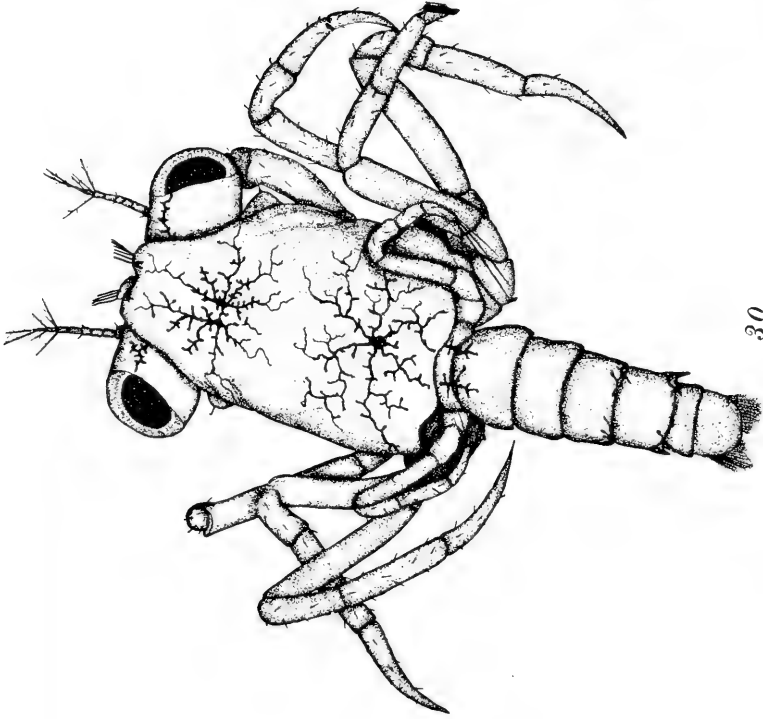

30

30. *Megalops*, dorsal view.

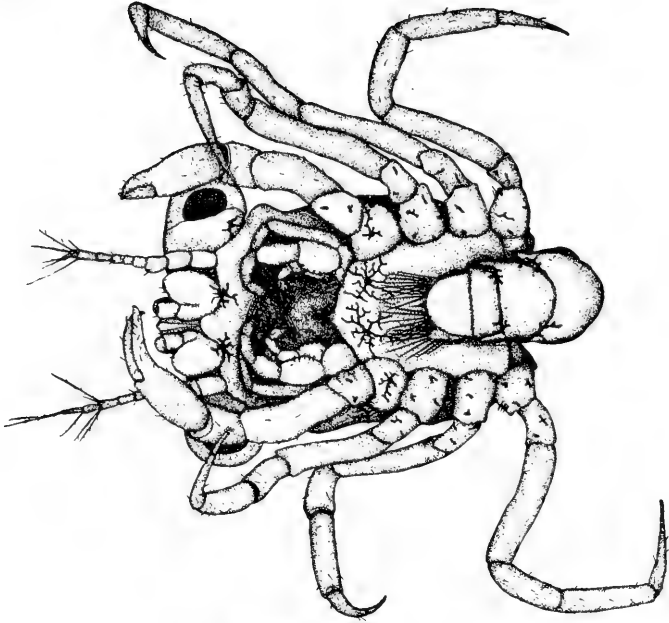

31

31. *Megalops*, ventral view.

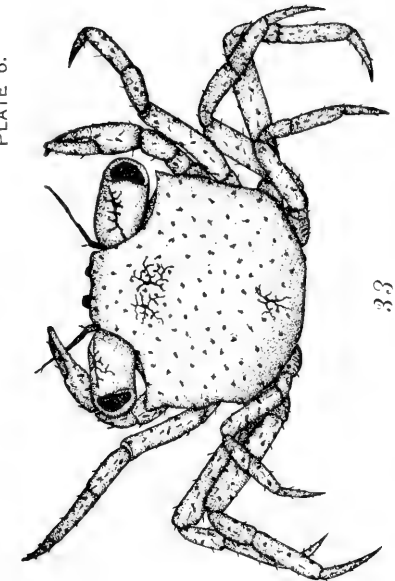

33

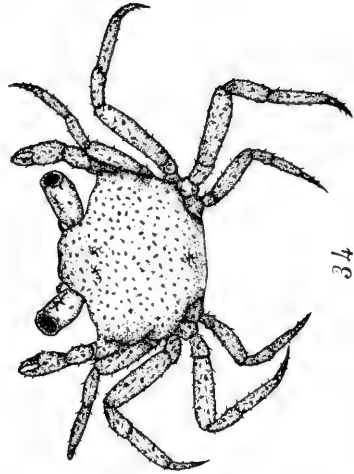

34

35. Small hand of fourth crab stage.
36. Large hand of fourth crab stage.

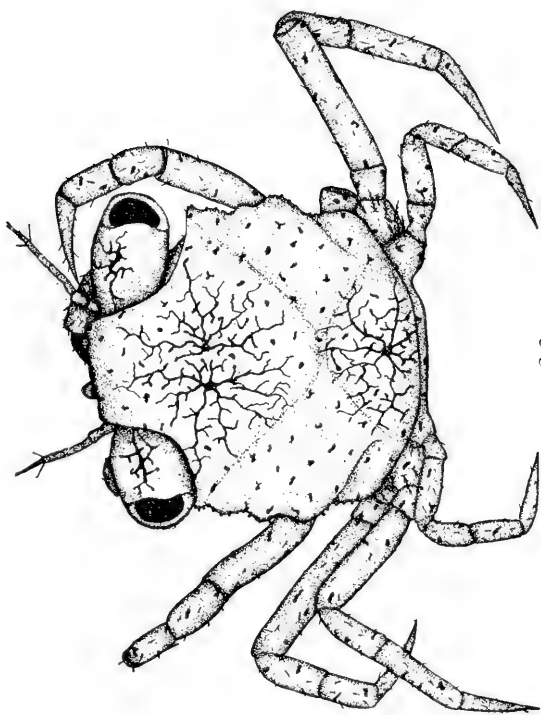

32



36



35

32. First crab stage.
33. Second crab stage.
34. Third crab stage.

distributed. These continue to multiply from this time on and later arrange themselves into the definite color patterns of the adults.

The abdomen of the young crab is greatly changed. It, too, is considerably flattened and it is carried permanently flexed under the thorax as it is in the adult crab. The abdomen fits closely into a groove on the under surface of the thorax. The pleopods of the megalops are still present but they are sadly changed. Instead of being powerful swimming organs they are mere wrinkled finger-shaped sacs. They are almost empty of flesh and, of course, contain no muscles.

Since it can no longer swim the young crab must depend upon its pereopods for locomotion. During the megalops stage these were used for clinging only and in the young crab they are conspicuously more efficient for clinging to its refuge than for walking, and running is quite out of the question. The young crab has undergone very little change in its sensory appendages and mouth parts. Each appendage is somewhat larger and somewhat better adapted to its physiological use. One or two new gills are beginning to appear on the bases of the maxillipeds.

More noticeable changes occur in the appendages of the posterior part of the thorax. The fifth pereopods have lost their long hairs and are no longer carried tightly folded over the back. They now have the sharp distal points of clinging legs and they still have a tendency to turn up over the back. They are distinctly useful to the little crab now, however, in clinging to an object behind it. The fingers of the pincers are now just alike on both hands of all the young crabs. They are of the same size and both fingers end in rounded points that are hollowed out like spoons. They are well adapted for picking up small objects and from now on the young crab must get nearly all of its food by picking it up from the bottom rather than seizing it in chase as the megalops did. Consequently it begins to make for the shore where an abundance of food is washed in by the sea and left in accessible places. The young crab is very weak and awkward, but by clinging to any support that offers it slowly gains the beach and crawls out on the land for the first time. It does not leave the wet parts of the beach, however, but remains down between the tide lines. Here they may be found crawling around in considerable numbers during the latter part of the summer. They are very weak and awkward and even the tiniest wavelet will roll them over and over. Accordingly they do not venture far out on the open beach but remain hidden under the protecting rim of a bit of oyster shell or water-logged wood or else cling to tiny sedge rootlets that have been washed bare by the tide. The crabs are very helpless, but are almost invisible on the damp sand where they live.

After crawling feebly about for three or four days picking up what food it can find, the young crab molts. After the molt the second crab (fig. 33) shows only minor and relatively slight changes in structure. The carapace is now about $1\frac{1}{2}$ millimeters long and nearly 2 broad. It is thus very nearly the same shape as in the adult crab. The only other notable change in structure is the further atrophy of the abdominal appendages. These have become quite minute and are entirely absent on the sixth segment. Although the changes in structure have been slight, the second crab is much more active than the first and runs about on the beach with more assurance and speed. It still remains near some protecting bit of beach débris, however. After about four or five days a second molt occurs.

The third crab (fig. 34) is slightly over 2 millimeters broad across the carapace. It now runs about freely enough and may even dig its first burrow. This burrow is only an inch or two deep and is just wide enough to admit the little crab, but it is sufficient to protect him from the incoming tide and the lively small enemies that come in along with the tide. The only considerable difference in structure is the complete atrophy of the megalops pleopods. These are generally absent entirely but they may be present as extremely minute buds that may only be seen under the high magnifications of a microscope (500 diameters).

After about a week the third molt occurs. The fourth crab is about 3 millimeters broad across the carapace. A careful examination of the little crabs of this size would show that they are no longer all exactly alike in their external structures. In about half of them one of the pincers is slightly heavier and larger than the other. (Figs. 35 and 36.) These are the male crabs. On the first and second abdominal segments of the males there are now developed minute buds that will develop into the sexual appendages of the adult fiddler. The females show no differentiations of the pincers and an examination of their abdomens shows appendages on the second, third, fourth, and fifth segments although these are still very minute. From this time on sexual differentiation becomes more and more pronounced.

When the young crab is about 4 millimeters or a sixth of an inch across its carapace it has become quite distinctly differentiated as a fiddler crab. The large pincer of the male has become considerably larger than the feeding claw, although it is shorter and thicker in proportion than the enormously elongated claw of the adult male. The carapace shows the square box shape of the adult, and on the area around the mouth-parts there are developed brushy hairs on which the water that is driven out of the gill chamber may be aerated before it is sucked in again. This makes the little crab

more independent of the moisture of the immediate water's edge and he may wander about more freely on the beach. The eyes are also provided with a joint and an erectile muscle at this time so that they may be raised upright over the carapace like two periscopes and carried in this position which is so characteristic of beach crabs. The abdominal appendages are not fully differentiated, but they show clearly all the parts that will form the sexual appendages of the adult. The young crab after this lives just like the adult. It gets its food from the sand on the beach, digs its burrow between the tide lines, comes out and feeds when the tide is falling, and hides in its burrow when the tide is coming in. It continues to grow, and as it grows continues to molt time after time. Of course, as the crab grows larger it digs a deeper and larger burrow.

During the remainder of the summer and the early autumn the young crabs continue to grow and molt and grow again. The colony on the beach is always being recruited by late arrivals from the sea, because the breeding season of fiddlers is a long one, beginning in early spring and extending through the summer and on into September. Besides their increase in size, each sex undergoes a slow transition to its sexually mature conditions. In the males the great claw becomes disproportionately larger and larger. It retains its juvenile shape, with its short, thick parts, until the young crab is about a year old. Then, with the completion of sexual development, the hand and the fingers lengthen to form the threatening claw of the adult male. The chief change in the female is in the abdomen. This gradually gets broader and broader until it fits over the under-surface of the body like an apron. It is becoming better and better fitted to serve as a support for the great batch of eggs that will later be attached to the swimmerets.

When the weather begins to get cold in the late autumn all the crabs on the beach crawl into their burrows for the winter hibernation. The unlucky larvae and little crabs that are not yet strong enough to dig their burrows perish of exposure during the first cold weather. All during the winter the crabs remain buried. If there comes a period of warm sunny weather lasting several days, however, a few individuals may come out and run about on the beach. They can not get much food now, because the surface of the sea is not teeming with life as in the warm summer and the sand "windrows" of the beach are little more than sand.

As soon as the first warm weather comes in spring all the little fiddlers become lively again and dig themselves out. Some of the young crabs of the preceding summer may have become sexually mature by this time and by early April they lay their eggs, and soon the sounds and adjacent sea are receiving new swarms of delicate, active zoeas, setting out upon the great adventures through which every fiddler crab must pass in its youth.



THE SENSES OF INSECTS.

By N. E. McINDOO, PH. D.,
Insect Physiologist, Bureau of Entomology, Washington, D. C.

[With 1 plate.]

Insects, like all other animals, acquire their information concerning the world through their senses, and this is accomplished by means of impressions or stimuli affecting the sense organs. The world to us is chiefly a world of visions or sights; all the other senses are secondary, and one of them—i. e., the sense of smell—is so rudimentary that it is no longer comparable to the same sense in some other animals. The world to a bloodhound is chiefly a world of scents, odors, or smells, and in this case the other senses play a secondary place, and the world to such insects as ants and bees is not only a world chiefly of smells, but the olfactory sense plays such an important part in their lives that should it be suddenly destroyed these insects could no longer exist. Thus an individual's world is determined principally by his most important sense, i. e., we gain most of our knowledge through our eyes, while a blind man acquires most of his knowledge through the senses of hearing and touch, which are closely allied. Every person lives in a world somewhat different from that of any other person, and reasoning along this line there must be as much difference between our world and the insect world as there is between day and night. Now let us briefly discuss the various senses of insects in order to determine the nature of the insect world, but it must be remembered at the outset that we are liable to misinterpret their activities, because the best that we can do is to compare under similar conditions their behavior with ours, and since insects are developed so differently from us, we really have no right to make such comparisons.

THE SENSE OF SIGHT.

Insects have two kinds of eyes, simple and compound. On most species both kinds are found, on some either kind alone, and in a few no eyes at all. The most primitive living forms and the larvae of the specialized insects (those with complete metamorphoses) have

only simple eyes, which seem to be direct heirlooms from the eyes of worms. The compound eyes (figs. 1 to 4) are paired and lie on the sides and top of the head, while the simple eyes (fig. 4, only one

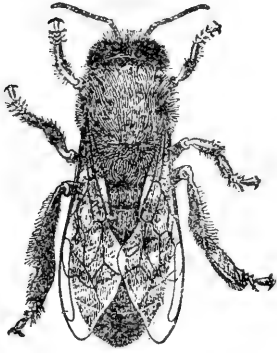

1

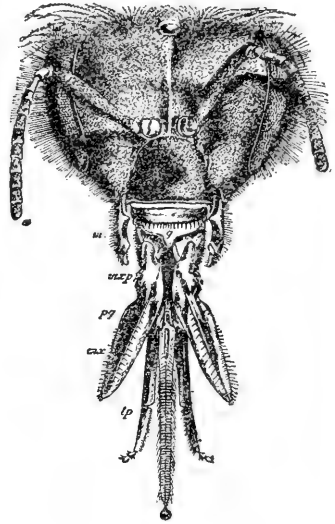

4



2

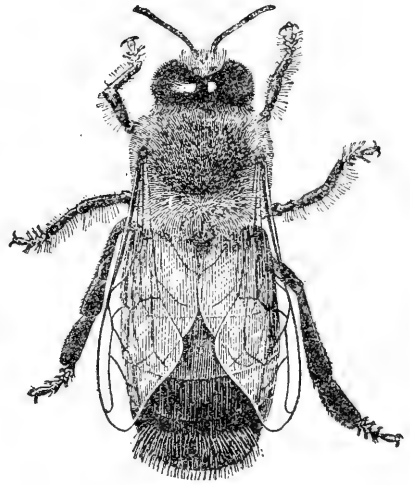

3

FIGS. 1 TO 4.—The three castes of honeybee, enlarged. Fig. 1, worker; fig. 2, queen; fig. 3, drone; and fig. 4, head and mouth parts of worker.

shown), usually three in number and arranged in a triangle, lie near the top of the head between the compound ones.

The compound eyes are not complex or specialized derivations of the simple ones, but are of independent origin and of obviously distinct structural character. In structure they are wonderfully complex and most delicately organized, being far more so than those of the vertebrates or mollusca. Externally each compound eye presents a number (from 7 to 27,000) of facets or microscopic polygonal cuticular windows. These are the cornea of the eye. Behind each facet or corneal lens there is a distinct and independent subcylindrical eye element which is composed of (1) a crystalline lens (wanting in many insects), (2) of pigment matter, and (3) of a special nerve ending. According to Müller's mosaic theory of insect vision, each of these eye elements perceives that bit of the external object which is directly in front of it—that is, from which light is reflected perpendicularly to its corneal lens. All of these microscopic images, each of a small part of the external object, form a mosaic of the whole object, and thus give the familiar name "mosaic vision" to the particular kind of seeing accomplished by the compound eye.

The character or degree of excellence of sight by the two kinds of eyes obviously varies much. The fixed focus of the simple eyes is extremely short, and probably their range of vision is restricted to an inch or two in front of the insect's head. It is generally agreed among entomologists that they avail little beyond distinguishing between light and darkness. Relative to the compound eyes the focus is also fixed, but is longer, and the range of vision probably extends to 2 or 3 yards. According to Müller's theory, which is supported by several reliable observers and which is generally accepted by entomologists, the larger and more convex the eyes the larger will be the visual field, while the smaller and more abundant the facets the sharper and more distinct will be the image. Although no change in focus can be effected, as in the human eye, nevertheless Exner claims that certain accommodation or flexibility of the seeing function is obtained by the movement of the pigment, which tends to regulate the amount of light admitted into the eye, and by differences in size and pigmental character of the eye element, which tends to make part of the eye especially adapted for seeing objects in motion or in poor light, and another part for seeing in bright light and for making a sharper image.

Both Plateau and Exner claim that while the compound eye is inferior to the vertebrate eye for making out the forms of objects, it is superior to the latter in distinguishing the smallest movements of objects in the total field of vision. They believe that it is used mainly for perceiving moving bodies. Mallock agrees with Plateau in that insects do not see well; at any rate, as regards their power of defining distant objects and relative to insects having compound eyes there is hardly any practical limit to the nearness of the objects

which they can examine, whereas in the simple eye the focal length of the lens limits the distance at which a distinct view can be obtained. Plateau thinks that the compound eyes are not complete visual organs, but mainly organs of orientation, and that they do not distinguish the form of objects, or, if they do, distinguish them very badly. Lubbock, however, does not agree with Plateau, and claims that they discern the form of bodies better than Plateau supposes. Forel says that insects only distinguish the contours and forms of objects in a more or less indistinct fashion, the more indistinct as the number of facets is less, as the crystalline lenses are shorter, as the object is farther off, or as it is smaller. Insects which have large eyes, with several thousand facets, see forms fairly distinctly. By aid of their compound eyes certain insects appreciate the direction and distance of objects during flight; this is at least correct for near distances, and Forel also thinks that they appreciate, even when at rest, the distance of immobile objects.

Some insects can distinguish colors. Lubbock has experimentally proved that bees, wasps, and ants have this power, blue being the favorite color of the honeybee and violet of ants, the ants being sensitive to ultra-violet rays. Butterflies, high in the air, will descend, mistaking bits of colored paper for flowers; certain white butterflies usually preferring white flowers, and yellow butterflies showing a preference for yellow flowers.

THE SENSE OF SMELL.

Of all the human special senses, we seem to know least about the olfactory sense. This is pardonable because the sense of smell in us is more or less rudimentary. Despite our degenerated olfactories, we can, by special effort, cultivate this sense, and should do so by all means, because odors are daily becoming more important. Alexander Graham Bell, discussing the physical-chemical possibilities of odors, says that an odor has already made one man famous, and wants to know who is ready to evolve a new science by measuring or reflecting a smell. He says:

Find out what an odor is—whether it is an emanation and therefore subject to being weighed, or a vibration and therefore capable of being reflected. Odors are becoming more and more important in the worlds of scientific experiment and in medicine—and the need of more knowledge will bring forth more knowledge, as surely as the sun shines.

The following discussion will show that in regard to odors insects have already evolved a new science and are capable of classifying and analyzing odors, many of which are unknown to us. They can do this, of course, not as we may be able to some day, but, furthermore, have evolved special organs for producing odors and highly developed ones for receiving them. In fact the olfactory sense of insects,

particularly in the honeybee, is so highly developed that we do not have any more conception of it than does the honeybee (if it could think as we do) of our wonderfully developed sense of sight, which is able to distinguish accurately the size, form, and color of objects.

It has always been a matter of conjecture as to how the various lower animals recognize each other, and by what means the sexes of any species distinguish one another. At first thought it might be claimed that sight is the chief means by which any animal having eyes can recognize other animals, but after a second thought we recall that the eyes in the lower animals are not as highly developed as they are in the higher animals; and we know that many of the lower animals live in dark places and that some of them are partially or totally blind. For example, the eyes of some beetles and spiders inhabiting caves function little or not at all, and despite this fact, these animals seem to distinguish one another as easily as do those with normal eyes living in light places. Relative to blind or partially blind species, touch may be the chief means by which they recognize one another, but during the courtship of cave spiders the writer observed that the males recognize the females of the same species at short distances and even before the males touch the webs of the females. Touch, therefore, can not be the chief means of recognition for cave spiders and perhaps not for any other animal. Since we know so little about the senses of hearing and taste in the lower animals, we may safely eliminate them as the chief factors in recognition.

That the lower animals do recognize one another without using the tactile organs, and as their sense of sight is not sufficiently developed to be the chief factor in recognition, we may assume that the most important factor is some chemical sense, perhaps similar to our olfactory sense. If the olfactory organs are the chief means of recognition they must constantly receive stimuli in the form of odors, and these odors must be emitted by the animals themselves. If this is true, it would seem that the odor emitted by one animal should be at least slightly different from that of any other animal, and reasoning in this way Jaeger believes that most animals emit odors peculiar not only to the individual, variety, race, and species, but also to the genus, family, order, and class, and that these odors are the chief means by which one animal recognizes other animals. Without the aid of the eyes he claims that the degenerate human olfactories are able to distinguish a horse from a cow, a goat from a roe, a dog from a cat, a martin from a fox, a crow from a pigeon, a parrot from a hen, a lizard from a snake, and even a carrion crow from a hooded crow. Blackman remarks that the anal mucous membrane of our domestic animals, particularly the dog and cat, contains glands whose secretion emits a comparatively mild odor, which prob-

ably serves as a secondary sexual purpose, but in other carnivores, such as the otter, badger, wolverine, mink, martin, ferret, ermine, weasel, and skunk, the scent may be far from mild, and in many cases is used either as a means of defense or offense.

The present writer has described a special organ for producing odors in the honeybee. It consists of many tiny glands which empty their secretion into the folded articular membrane between the fifth and sixth abdominal segments on the back of the bee. Specially devised experiments showed that the secretion was the source of the individual, family, and sexual odors.

Scent-producing organs have already been found in most orders of insects and probably all insects have some way of producing odors. The known organs vary widely in structure; the simplest type consists of many tiny glands widely distributed over the entire body, and the most highly developed type is much more complicated than that found in the honeybee.

The present writer determined from his own experience that the human nose can be trained to recognize a number of characteristic odors pertaining to the honeybee. At the beginning of his experiments he was able to distinguish the hive odor (the smell of the bees in the hive, collectively), the brood odor (the smell of the larvæ and pupæ, fig. 5, *B-D* (pl. 1)), the honey (*A*) odor, the pollen or bee-bread (*E*) odor, the wax (*J*) odor, and the odor coming from the bee sting. After a few months' practice he was able to recognize the three casts of bees (figs. 1-3)—queens, drones, and workers—merely by smelling them.

Old workers constantly give off the characteristic bee odor, and when seized they emit another distinct odor which comes from the poison ejected through the sting. No difference between the odor of a guard (fig. 5, *I* (pl. 1)) and that of a fanner (*G*) could be distinguished; the odor from each closely resembles the hive odor; that is, the odor which comes out of a hive when the hive cover is removed. A worker carrying pollen gives off besides the bee odor another odor which comes from the pollen.

The younger the workers the less pronounced is the bee odor emitted. To the human nose the odor emitted by nurse bees (fig. 5, *F* (pl. 1)) and wax generators (*H*) is much less pronounced than is the odor from old workers.

Workers just emerged from the cells have a faint sweetish odor, but lack the characteristic bee odor, and workers removed from the cells just before they begin cutting their way out emit a fainter sweetish odor.

Old queens have a strong, sweetish odor, while the odor from queens just emerged from their cells is much less pronounced. The queen

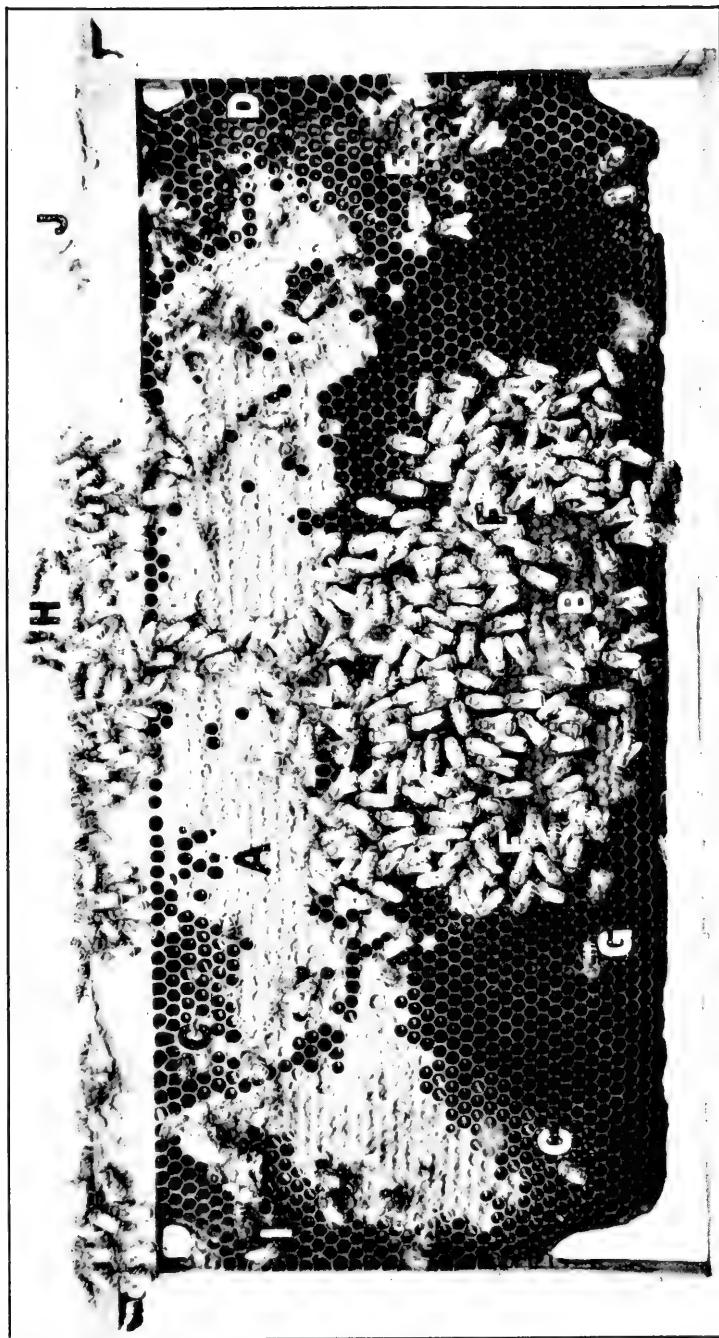

Fig. 5.—Frame removed from a hive of bees, showing: A, sealed honey; B, sealed brood (pupae); C, brood (eggs and young larvae); D, old larvae, cells ready to be sealed; E, pollen or beebread; F, nurse bees; G, fanner; H, guard; I, wax generators; J, old wax. Much reduced in size.



odor is very pleasant and is as characteristic for queens as is the bee odor for workers.

The majority of old drones have a faint odor, while almost every young drone has a stronger odor. This odor is slightly different from that of young workers and is less sweetish.

By means of specially devised experiments the writer proved that the bees themselves can distinguish a much greater variety of smells, and that these play a most important part in their lives.

It is certain that a queen gives off an odor, and it seems reasonable that the odors from any two queens would be slightly different. All the offspring of the same queen seem to inherit a particular odor from her. This odor, called the family odor, perhaps plays little or no part in the lives of bees, for it is certainly masked by the other odors. Drones seem to emit an odor peculiar to their sex, but little can be said about it. It seems certain that each worker emits an individual odor which is different from that of any other worker. It is also probable that the wax generators and nurse bees emit odors slightly different from those of the field bees.

Of all the odors produced by bees, the hive odor is probably the most important. It seems to be the fundamental factor or principle upon which the social life of a colony of bees depends and perhaps upon which the social habit was acquired; without it a colony of bees could not exist. The hive odor is composed chiefly of the individual odors from all the workers in a hive and is supplemented by the odors from the queen, drones, combs, frames, and walls of the hive, etc. From this definition it is easily understood why no two colonies have the same hive odor. The hive odor of a queenless colony is perhaps considerably different from that of a colony which has a queen. The absence of a queen odor in the hive odor probably explains why the workers in a queenless colony are irritable and never work normally. All the bees—workers, queen, and drones—in a colony carry the hive odor of that colony on their bodies among the hairs. This odor serves as a sign or mark by which all the occupants of a hive know one another. Since the queen and drones are "aristocrats," they seem to disregard the sign that has been thrust upon them, but whenever a queen enters the wrong hive she soon "realizes" that she wears the wrong badge.

Worker bees returning to the hives from the field pass the guards unmolested because they carry the proper sign, although the hive odor that they carry is fainter than when they left the hive, and it is also partially masked by the odors from the nectar and pollen carried by these bees.

Bees kept in the open air for three days lose all the hive odor carried on their bodies, but each bee still emits its individual odor. When a colony is divided the hive odor in each half soon changes,

so that by the end of the third day the original colony possesses a hive odor so different from that of the other half of the colony that when the workers are removed from the two new colonies and are placed together in observation cases they fight one another as though they had been separated all their lives.

While a foreign hive odor calls forth the fighting spirit in workers, the queen odor always seems pleasant to workers regardless of whether the queen belongs to their hive or to another hive. Even though the queen odor forms a part of the hive odor, it is probable that this odor to the workers stands out quite prominently from the hive odor. That workers do not miss their queen for some time after she has left the hive indicates that her odor thoroughly permeates the hive odor and that whenever this odor grows faint the workers "know" that she is not among them.

There has been much speculation concerning the ruling spirit or power in a colony of bees. The present writer is inclined to believe that a normal hive odor serves such a purpose. The hive odor is a means of preserving the social life of the bees from without and the queen odor which is a part of it insures continuation of the social life within. As already stated, the workers "know" their hive mates by the hive odor they carry. This odor insures harmony and a united defense when an enemy attacks the colony. The queen odor constantly informs the workers that their queen is present. Even though she does not rule, her presence means everything to the bees in perpetuating the colony. Thus by obeying the stimuli of the hive odor and queen odor, and being guided by instinct, a colony of bees perhaps could not want a better ruler.

Fielde claims that a certain species of ants bears three distinct odors as follows: (1) A scent deposited by her feet, forming an individual trail, whereby she traces her own steps; (2) an "inherent" and inherited odor, manifested over her whole body, identical in quality for queens and workers of the same lineage, and a means for the recognition of blood relations; and (3) a nest odor, consisting of the commingled odors of all the members of the colony and used to distinguish their nest from those of aliens. Miss Fielde says that the odor of ants changes with their age, and that "a cause of feud between ants of the same species living in different communities is a difference of odor arising out of difference of age in the queens whose progeny constitutes the communities, and difference of age in the ants composing the community." She calls this odor the "progressive" odor, and further claims that "fear and hostility are excited in the ant by an ant odor which she [the ant] has not individually encountered and found to be compatible with her comfort." The same author calls the family or "inherent" odor the "specific" odor which is transmitted by the mother ant to all her offspring of

both sexes within the species. Miss Fielde claims that ants not only differentiate the innate odors peculiar to the species, sex, caste, and individual, but also the "incurred" odor of the nest and environment, and furthermore they can detect "progressive" odors due to change of physiological condition with the age of the individual. She says that "as worker ants advance in age their progressive odor intensifies or changes to such a degree that they may be said to attain a new odor every two or three months."

Wheeler, writing about the odors of ants, says that the specific odor may be readily detected by the blunted human olfactories. Thus the odor of one species is pungent and ethereal; of two other species, smoky; of another species, like the lemon geranium or oil of citronella; of some other species, like mammalian excrement; and of still other species, like rotten coconuts.

Concluding from the experiments on ants made by various observers, the family odor in these insects seems to play an important rôle by enabling the offspring of one queen to distinguish members of their family from those of alien families. Relative to ants, the family odor is probably as important as is the nest odor, but in the honeybee, where certain social habits have been advanced to a higher degree, the family odor is of little or no use, because the hive odor has assumed such an important rôle in the recognition of the members of the same or of a different colony. Each colony of bees has its own hive odor, a small portion of which adheres to the body of each member of that colony, so that a bee is never entirely devoid of the hive odor. Should workers be forced to remain in the open air for at least three days, which is scarcely possible, they would lose their hive odor, and should they try to enter their own hive they would be attacked by their sister guards, because the family odor emitted by them would not be a sufficient proof to the guards that they were friends; of course if the guards had also lost their hive odor they would let these sisters enter unmolested.

Now, let us end the discussion concerning the recognition among insects, based on the olfactory sense, and let us endeavor to locate the olfactory organs. Ever since the time of Aristotle many writers have speculated about the seat of smell in insects, but this subject has been the greatest puzzle of all. The earliest writers, forgetting that the insect organization is entirely different from that in the vertebrates, tried to homologize certain parts in insects with correspondingly similar parts in the higher animals. Thus the snout, mouth cavity, esophagus, and certain glands in the head were declared by their various advocates to be the proper places for the location of the olfactory organs. When real investigators began to reason and to experiment all of the above imaginary seats were abandoned and the spiracular and antennal views were accepted. Then it was finally

shown that the seat is not located in the spiracles or breathing pores on the sides of the insect's body. With the spiracles eliminated there remained only the view that the seat of smell must be in the antennae or feelers. (Fig. 4, *a.*) This view was still more or less doubted up to 1880, when Hauser's comprehensive and apparently infallible results appeared in print. His results were generally accepted, and for several years the debated question was settled, but a critical analysis of his results has proven to the satisfaction of the present writer that the antennal view can not hold good either from an experimental or from an anatomical viewpoint.

In 1909 the present writer began to study the senses in spiders. After a period of two years he described and determined the function of the lyriform (lyre-shaped) organs in spiders, and in 1911 began to work on similar organs, then called Hicks's vesicles but now olfactory pores, common to insects. Up to date he has thoroughly studied the olfactory pores in many families of spiders and in most of the insect orders, including dozens of families and hundreds of species. So far he has never failed to find these organs in any specimen examined, and furthermore they are probably present in all larval forms, although the larvae of only two orders have yet been examined. As in spiders, they are widely scattered over the body, head, and appendages of insects, but the more highly developed the insect the more they are arranged in groups, most of the groups being found on the legs, wings, and mouth parts. So far only a few olfactory pores have been found on the antennae, these being present on the bases of the antennae of bees, grasshoppers, roaches, and crickets.

Briefly described, an olfactory pore is nothing more than a nerve (fig. 6, *N*) passing through a tiny hole in the "skin" or chitin (*Ch*) of the insect. The internal and external anatomy varies considerably, according to the insect order examined, but structurally those on the halteres (rudimentary hind wings of flies and mosquitoes) have reached the highest degree of perfection. Here they are beautifully sculptured and their architecture is really marvelous, as may be seen by looking at figures 7 and 8, and furthermore since they stand, knob-like, above the "skin" they are well protected by large curved hairs (figs. 7 and 8, *Hr*) bending over them.

In the experimental part of the work, the writer used hundreds of ants, bees, hornets, beetles, grasshoppers, crickets, and caterpillars. The insects were first tested to ascertain their normal reaction times to various sources of odors, among which were their food and some others not regarded as irritants. Some of the adult insects were then mutilated by having their antennae either cut off or covered with a harmless substance, while the other adults were mutilated by having most of their olfactory pores either covered with a harmless sub-

stance or many of them totally destroyed by removing the wings. After the mutilated insects had apparently recovered from the operations, they were again tested with the same sources of odors. Those ants, bees, and hornets with mutilated antennae usually failed to respond to odors, but they were very abnormal, soon became sick and never lived long. Those beetles, grasshoppers, and crickets with mutilated antennae usually responded to odors and lived practically as long as others not mutilated. All of those insects with destroyed

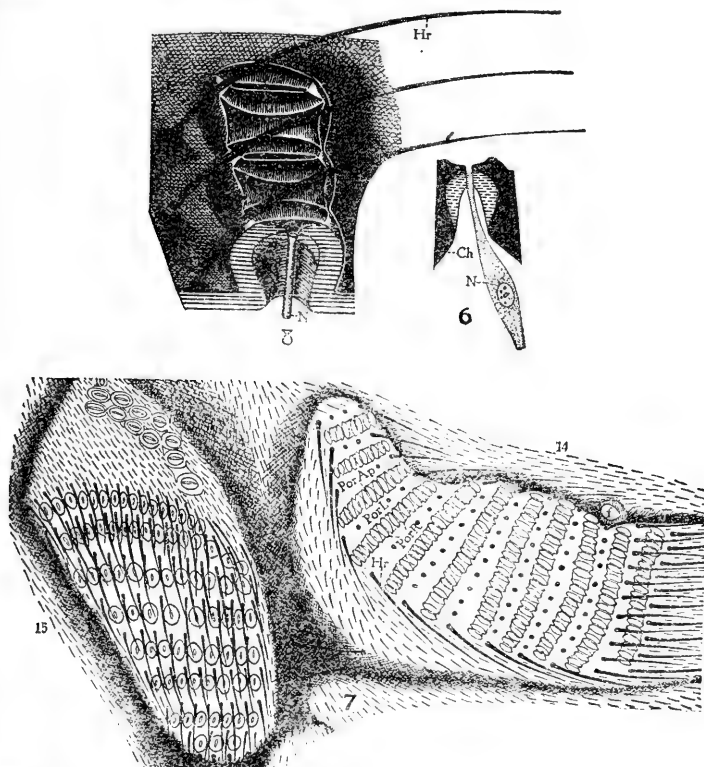

FIGS. 6 TO 8.—Olfactory organs of insects. Fig. 6, section of olfactory pore in leg of worker honeybee, showing nerve (*N*) passing to exterior through aperture in "skin" or chitin (*Ch*); enlarged 600 times. Fig. 7, external view of four types of olfactory pores (Nos. 14–16 and *f*) on halter (rudimentary hind wing) of house fly; enlarged 500 times. Fig. 8, schematic drawing of a portion of a row from group No. 14, showing the remarkable architecture of these organs in perspective and in section.

or covered olfactory pores responded to odors more slowly than before being mutilated, and the degree of slowness depended on the number of pores prevented from functioning. All of these insects were apparently normal in other ways and lived practically as long as intact ones.

The question has often been raised as to how certain female moths are able to attract males from miles away. Mayer attempted

to answer this question by carrying 450 *Promethea* cocoons from Massachusetts to the Florida keys, where on separated small islands the moths issued from the cocoons. This isolation insured that no other individuals than those controlled by the experimenter could confuse the observations. Some of the female moths were confined in glass jars with the mouths covered with netting, while other females were confined in glass jars turned upside down with the mouths buried in sand. Males being released at various distances, soon found their way to the jars whose mouths were covered with netting, but no males came to the jars whose mouths were buried in sand, although the moths in all the jars were plainly visible to the experimenter. These experiments would seem to preclude sight as a factor, and that the moths did not communicate with one another by any such means as radiography or telepathy; but if they did, the agency used in the communication could not pass through the glass jars. Therefore, it would seem that emanations passed away from the jars whose mouths were covered with netting and that these emanations were sensed in some way by the male moths. The females of these giant silkworm moths, however, certainly have highly developed scent-producing organs, and the males highly developed olfactory organs, although they have not been described; but in the common silkworm moths these organs are so highly developed that should the excised scent-producing organ be laid a few inches from the female's body from which it was removed, the male moths always neglect the nearby live female and go directly to the scent-producing organ and try to copulate with it.

THE SENSE OF SMELL AND TASTE COMBINED.

Little experimental work has ever been performed to determine whether insects have a true gustatory sense, although the sense organs on the mouth parts of various insects have been studied considerably. At least three different kinds of sense organs on the mouth parts have been called organs of taste, but no one has ever attempted to prove experimentally the function of these organs. Judging from the fact that insects prefer some foods to others and that certain insects often refuse poisoned foods, it is generally believed that insects can taste, regardless of whether or not they have gustatory organs.

At this place it is desirable to define the human senses of smell and taste, so that we may use the definitions as a basis for interpreting the responses to the same or similar stimuli in honeybees, which were used by the present writer to determine whether or not insects have a true sense of taste. The sense of smell is called forth by substances in a gaseous or vaporous condition, although gases

dissolved in the liquids of the mouth may give rise to actual tastes. The sense of taste is brought about by substances either in solution when introduced into the mouth or dissolved by the liquids in the mouth. Parker and Stabler, after experimenting upon themselves, and Professor Parker upon other vertebrates, say:

We therefore definitely abandon the idea that taste and smell differ on the basis of the physical condition of the stimulus, a state of solution for taste, a gaseous or vaporous condition for smell, and maintain that both senses are stimulated by solutions, though in smell, at least for air-inhabiting vertebrates, the solvent is of a very special kind * * *. In air-inhabiting vertebrates the olfactory solvent is a slimy fluid of organic origin and not easily imitated.

From the preceding definitions it is evident that the senses of smell and taste in vertebrates can not be sharply separated, and the following discussion will show that these two senses in the honey bee can not be separated at all. In the honey bee it will be shown that the sense of taste is only one phase of the olfactory sense. We have not the slightest conception as to how odor and taste stimuli in any animal act upon nerve endings to produce the various sensations of smell and taste, and as shown in the following pages, when bees are fed foods which contain undesirable substances emitting extremely weak odors they refuse to eat the foods after "tasting" them. In view of the two preceding facts we may call this perception an olfactory-gustatory sense, although the writer will endeavor to show that the gustatory sense plays no part in these responses.

Since it is impossible to eliminate the olfactory sense while determining whether bees have a true gustatory sense, and as the various sense organs on the mouth parts can not be mutilated without causing considerable abnormality in the behavior of the bees while eating, it was decided to ascertain if bees have likes and dislikes in regard to foods and to make a careful study of the structure of all the sense organs on the mouth appendages in order to be able to judge whether or not bees have a true sense of taste.

The preliminary experiments in feeding bees foods containing various substances suggested five classes of foods to be used in other experiments. Foods containing strong repellents were employed to determine the importance of the olfactory sense in causing bees to avoid such substances, and foods containing sweet, bitter, sour, and salty substances were used to ascertain if bees show preferences between foods having the four attributes of human taste. Pure cane-sugar candy (powdered sugar mixed with honey) and honey were used as standard or control foods and the five classes of foods employed are as follows: (1) Repellents—carbolic acid, oil of peppermint, whiskey, formic acid, xylene, formaldehyde, kerosene, and lime-sulphur, each mixed with candy or honey; (2) sweet foods—candies

made of levulose, maltose, raffinose, dextrose, lactose, dextrine, and various varieties and mixtures of honeys and sugar sirups; (3) bitter foods—quinine, strychnine, and picric acid, mixed with candy, and chinquapin honey alone; (4) sour foods—lemon juice, acetic, hydrochloric, sulphuric, and nitric acids, mixed with honey; and (5) salty foods—various sodium and potassium salts, including our common table salt, mixed with candy.

The results obtained clearly demonstrate that bees have likes and dislikes in regard to foods, and it seems that their faculty to discriminate between foods is more highly developed than ours, because they can distinguish differences between the foods fed to them better than the writer. The candies containing strychnine and quinine best illustrate this point. Equal amounts of these two bitter salts were used; but when the writer tasted the candies containing them, little or no difference in bitterness could be detected, although, judging from the number of bees that ate them when the two foods were fed alone, the bees distinguished a marked difference between them.

As a general rule, foods agreeable to us are also agreeable to bees, but there are a few marked exceptions. All foods scented with peppermint are pleasant to us, but repellent to bees. The writer does not care for candy containing potassium ferrocyanide, but bees are rather fond of it, and it does not seem harmful to them.

In regard to the repellents used, the few experiments performed do not warrant definite deductions, but the results indicate that lime-sulphur and kerosene are the strongest of the repellents used, while formic acid repels the least and carbolic acid the most among the acids. That the acids as a rule are not better repellents may possibly be explained by the fact that bees are more or less accustomed to the odors from the acids found in their foods and various secretions.

The results obtained demonstrate that bees like honey best of all foods and that they are able to distinguish marked differences between various kinds of honeys. Substitutes for honey as food for bees may be better than honey in a few instances, but these investigations indicate that no substitute can be had which will be liked by bees as well as the best pure honey.

The fact that bees must first eat more or less of the foods before being able to discriminate differences between them, unless they contain repellents, indicates that bees have a true gustatory sense, providing this discrimination is not accomplished by means of the olfactory sense. Since this point can not be determined experimentally, our only criterion is to make a thorough study of all the sense organs on and near the mouth parts. This part of the work was accomplished, and only two kinds of sense organs were found, as may be seen by referring to the innervated hairs, marked *b*, *c*, *e*, and *f*, and to the olfac-

tory pores, marked *Por*, in figure 9. Neither kind of these sense organs is suitable as taste organs.

The present writer, and the few other authors who have fed insects foods containing undesirable substances, have observed that the insects sooner or later refuse such foods after eating more or less of them. Judging from this behavior, the other authors have concluded that insects can taste, regardless of knowing whether or not they have sense organs anatomically adapted for receiving gustatory stimuli, and without considering the rôle played by the olfactory sense in these responses. As Parker has already said for vertebrates, and as we well know for ourselves, it is almost impossible to determine whether we taste or smell certain substances when we eat them. To us sometimes a food, before being eaten, emits only a faint odor or no odor at all; but when we eat it, we perceive a pronounced odor. In such a case the odorous particles are not given off until the food is taken into the mouth and mixed with saliva. The same principle is certainly applicable when bees eat candies which contain undesirable substances emitting extremely weak odors. As quickly as the saliva has dissolved the candy and has had time to effect a chemical or physical change, the odorous particles are given off, and since the olfactory pores on the mouth parts are nearest the food, they are the first ones to receive the odorous particles. For this reason the so-called gustatory sense in insects is only a phase of the olfactory sense.

That we can not smell certain substances is no proof that insects can not smell them, for the many experiments performed by the present writer cause him to believe that the olfactory sense in the honeybee is much more highly developed than ours.

It is reasonable to think that many foods and chemicals emit odors, although we may not be able to perceive all of them; but judging from the experiments cited, it is not impossible for bees to discriminate between them better than we can. If they are not able to do this without eating them, only a few "tastes" are necessary to demonstrate their preferences. In a few instances the present writer was not able to discriminate differences between candies containing certain chemicals by using both senses of smell and taste, but the bees were able to distinguish marked differences. It therefore seems evident that this faculty in the honeybee is more highly developed than in man.

In all probability bees have no other means of chemically discriminating between foods than by smelling them, because no sense organs were found connected with the alimentary tract between the pharynx and the honey stomach, and because the innervated hairs described are not anatomically adapted for this purpose. The walls of the ali-

mentary canal certainly can not serve such a function except when corrosive or caustic substances are eaten.

After once refusing foods which contain undesirable substances emitting weak odors bees seem to know these foods and seldom eat any more of them unless forced to partake of them by the removal of the foods they like better.

In conclusion, it may be said that the olfactory sense in the honeybee is highly developed and that it serves as an olfactory and gustatory perception combined.

THE SENSE OF TOUCH.

Excluding spiders, perhaps no other class of animals (including man) has the sense of touch so highly developed; this is particularly true with those insects—as, for example, ants and bees—that carry their eggs in their mandibles or jaws from place to place. The eggs are almost microscopic, and so extremely delicate that the least rough handling of them prevents them from hatching, but the comparatively large and hard jaws of ants and bees are so wonderfully controlled by the sense of touch that the eggs are handled without the least injury.

Relative to spiders, their sense of touch seems to be of a different nature, and in this particular line of evolution there is no comparison. A female orb-weaver at the center of her web can tell friend from foe, male from female of her species, an insect suitable for food from one not suitable, an insect of a certain size from an inanimate object of the same size, and she can also distinguish between sizes of any two objects which happen to fly or to be thrown into her web. This is all accomplished by touch vibrations passing along the radii of the orb on which the legs of the female spider rest. Moreover, during courtship of spiders this system of touch vibrations is utilized as a means of signals to inform the male concerning the proper mood of the female for mating—but pity the dwarfed male should he misinterpret her signals, for instantly she pounces upon him and devours him without showing the least mercy.

In man the sense of touch is accomplished by touch corpuscles lying in the skin, but since insects have an exo-skeleton, a different system has been evolved. In them touch or tactile hairs, connected with nerves, take the place of touch corpuscles in us. Thus, when the air blows against these hairs or an object touches them the stimuli are transmitted through the hairs and their nervous connections to the brain, where the impulses are interpreted as touch.

In insects, as in man, all parts of the external anatomy are not equally sensitive to touch stimuli. In man the tips of the tongue and fingers are the most sensitive, while in the honeybee the tips of

the antennae (feelers) and jaws are probably the most sensitive, although the tongue and other mouth parts are also extremely sensitive, as may be judged from the tactile hairs shown in figure 9. The other appendages are likewise well provided with touch hairs and in fact every prominence on them which is apt to come in contact with objects bears a group of these hairs, which are usually much larger than those found on the antennae and mouth parts. Even the palate and pharynx are provided with many delicate touch hairs; and the head and body of insects also bear many irregularly scattered sense hairs, although the majority of the hairs found on insects are not connected with nerves.

In size the tactile hairs vary from very large ones (fig. 9, *c*₁₃), widely distributed, to microscopic ones found in the mouth cavity and elsewhere. In structure they also vary considerably, but may be roughly divided into spinelike (figs. 10, 12, and 13) and peglike hairs (fig. 11), the former usually being the larger and more common,

while the latter are always microscopic and found only on the antennae and on some of the mouth parts. The peglike ones shown in figure 11 are called olfactory hairs by other authors; they are found only on the antennae of insects, excepting the antennae of drone honeybees. The spinelike ones shown in figure 12 are found only on the epipharynx or palate; these, and also those on the tongue (fig. 9,

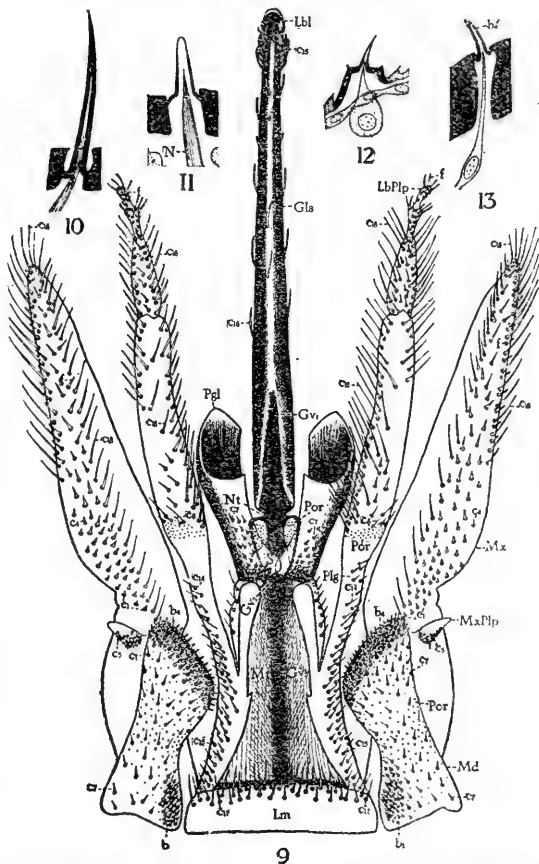

FIGS. 9 TO 13.—Organs of touch on the honeybee. Fig. 9, diagram of mouth parts of a worker, spread out flat, showing location and number of touch hairs (*b*, *c*, *e*, and *f*), all of which are connected with nerves, while the long hairs on the tongue (*Gls*) are not connected with nerves. The latter hairs are omitted in the drawing. Figs. 10 to 13, sections of touch hairs, showing nerves (*N*) running into bases of hairs; enlarged 500 times.

c_{16}), have been called taste hairs by other authors. While eating solid food the fleshy epipharynx, suspended at the roof of the mouth cavity, acts like a real tongue by feeling the food and pushing it into the mouth opening, where it then comes in contact with the sense hairs at the entrance of the pharynx, which act as a safety device to prevent pieces of solid food, too large to go through the esophagus, from passing into the pharynx.

A person often wonders how bees, since they are covered with a hard integument, are able to perform their many duties of caring for the brood, building comb, etc., but it seems obvious that they first examine objects with the tips of their antennae which are covered with the peglike tactile hairs, then the jaws (fig. 9, *Md*) seize the object and handle it so skillfully that it really appears marvelous. All of these activities are accomplished by many tactile hairs on the various appendages, but particularly by the row of curved hairs (fig. 9, b_4 and fig. 13) at the tip of the jaws, which act like tiny fingers, although perhaps a hundred times more sensitive than our fingers. These hairs are able to perceive the size, shape, and firmness of any small solid object, and now it is easy to understand how bees are able to mold the walls of all their cells of uniform thickness.

THE SENSE OF HEARING.

Concerning the special senses of insects, the sense of hearing is perhaps the least understood; but according to the earliest writers on this subject, this sense would seem to be highly developed in spiders and insects, because we are told that some species not only make musical sounds, but also are great lovers of music. This is particularly claimed for spiders, but not one iota of truth can be accredited to certain old romantic stories in which the hero, confined in a dungeon, charmed spiders with sweet music and prognosticated the weather by observing their behavior. According to the latest experimental results, spiders are not only deaf, but also most of them are dumb, only a few being able to make sounds.

Much has been written about the auditory sense of insects, but critics still contend that it has never been demonstrated beyond a doubt that any insect can really hear; nevertheless, we should not expect insects to respond to sounds which have no significance to them, nor to sounds not in their category, because they may not hear the sounds that we do. The number of vibrations perceptible to the human ear varies from 16 to 60,000 per second, but most human ears can not hear when the frequency is lower than 32 vibrations per second. Now, it may be that the insect ear is so poorly developed that it can hear only sounds having vibrations below 32 per second.

It is generally believed that insects can hear, for three reasons, as follows: (1) Many have special sound-producing organs; (2)

some have so-called auditory or sound-receiving organs; and (3) many of the experimental results obtained indicate that insects can hear.

Judging from the known sound-producing apparatus and the so-called auditory organs in crickets, grasshoppers, and katydids, the males are usually neither deaf nor dumb, but the females are always dumb, although not generally deaf. The males of crickets, katydids, and of some grasshoppers make sounds by rubbing their wings together, whereas other grasshoppers make sounds by rubbing their hind legs against the wings. Both sexes possess so-called ears, which in crickets and katydids (*Locustidae*) are found on the front tibiae, but in grasshoppers (*Acrididae*) on the abdomens. As far as known, the female cicada is both deaf and dumb, but her mate is only deaf, his sonorous sound-producing organ being found in the abdomen. "Happy is the cicada, since its wife has no voice," says Xenarchos, could just as well be said about the males of crickets, grasshoppers, and katydids. Graber, after cutting off the front tibiae of crickets and katydids, found that they responded as well to a violin and to their chirping and singing as before the operation.

Stridulation, special sound-producing apparatus, and various types of supposed auditory organs, have been described in true bugs, moths and butterflies, flies and mosquitoes, beetles, ants and bees, and also in a few larvae and pupae; yet we know very little about this subject.

During the past few years the writer has made a study of the auditory sense in the honeybee, but no experiments were performed demonstrating that bees really hear, although, like others who have studied bees, he believes that they do have some kind of a sense of hearing. His original idea was to conduct experiments, in which he hoped to be able to classify and to record on phonograph records the various sounds heard in a hive of bees. If this were possible, he intended to reproduce these sounds and then determine whether or not bees respond to them. Other duties prevented this experimentation. Turner, experimenting with moths in the field, did not have to resort to such a procedure, but, nevertheless, obtained results that should satisfy the most severe critics who contend that insects can not hear.

The present writer has just finished a study of the special sound-producing apparatus and two organs which might serve as auditory organs in the honeybee. Only a very brief description of them, however, can be given here.

The special sound-producing apparatus of the honeybee consists of the membranes lying between the axillaries or roots of the front wings. Muscles, lying in the thorax and attached to these axillaries,

contract and relax very rapidly, thereby causing the axillaries to vibrate; consequently the above membranes are caused to vibrate rapidly, thus producing the piping, teeting, or squealing noise, commonly heard when a bee is squeezed.

The pore plates, lying so abundantly on the antennae and called olfactory organs by other authors, were found to have two grooves (fig. 14, *G*) encircling each elliptical plate (*P*), thereby allowing the

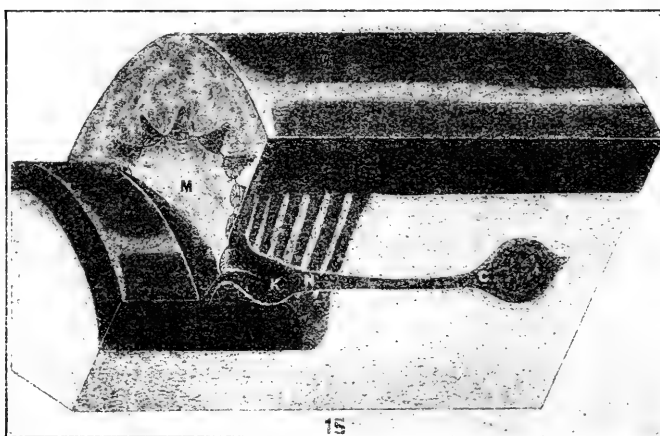
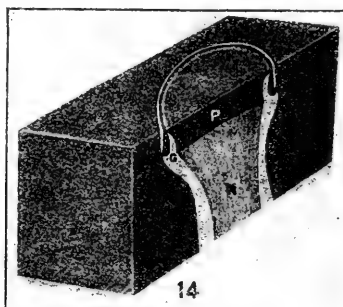

FIGS. 14 AND 15.—Schematic drawings of supposed ears or auditory organs of honeybee. Fig. 14, portion of a pore plate from antenna in section and in a superficial view, showing plate (*P*) supported by a double hinge between two grooves (*G*), and the nerve (*N*) attached to plate. Fig. 15, portion of a longitudinal section through articular membrane (*M*) between second and third antennal segments, showing Johnston's organ, which consists of knobs (*K*), extending inward from membrane, to which nerves (*N*) are attached.

plate to move in and out on a double hinge, as may be seen by looking at figure 14. Judging from this mechanism, the function of these organs might be interpreted in a new light. It is well known that many insects, when flying swiftly toward an object such as a window, light on their feet instead of butting their heads into the object. Now, it may be that the pore plates act as an air-pressure apparatus, in which capacity they inform the insects of the object immediately

in front of them. In case of the honeybee, they might also be sensitive to the weak currents of air caused by workers fanning. It is possible that the sense hairs are not affected by these weak currents, and, therefore, some method is badly needed to keep the bees constantly informed that the fanners are working properly. If this interpretation is correct, we here have another form of touch.

Lying in the second antennal segment there is a peculiar structure, known as the Johnston's organ. It consists of the modified articular membrane (fig. 15, *M*) between the second and third segments, and of many sense cells (*C*), whose fibers (*N*) unite with peculiar knobs (*K*) extending inwardly from the articular membrane. Child has described a similar organ in mosquitoes and thinks that it is an auditory organ, but in the honeybee it is no better adapted to receive sound vibrations than are the pore plates. In both organs the external membranes are well fitted for such a purpose, but the nervous connections seem too crude.

Schön has described a structure in the tibiae of bees, which he regards as an auditory apparatus. It is similar in internal structure to those found in the tibiae of crickets and katydids, but it has no external membrane as they have. The present writer has not yet succeeded in finding all the details described by Schön.

In conclusion, it may be that the sense of hearing in insects is on no higher plane than that advocated by Forel, who believes that insects do not hear, at least as we do, but compares this perception in them to that in deaf-mutes who feel the rolling of a carriage at a distance. Forel says:

Hearing is a physical sense. Sonorous waves, especially those of low sounds, are nearer to large mechanical vibrations than luminous, caloric, or electric waves. Hearing, therefore, must be in its origin connected with touch, but we make a distinct difference between the perception of a very low sound by touch and its perception by hearing. We must not forget that the specialization of the organ of hearing has reached in man a delicacy of detail which is evidently not found again in lower vertebrates. It is, I believe, the sense which removes us most from the lower animals. In animals as high as fish the auditory nerve is confused with other nerves, and the portion of the labyrinth most specially affected by our audition, the cochlea, has disappeared.

THE GENERAL SENSES.

Among the general sensations might be mentioned those of temperature, humidity, direction, and pain.

The sense of temperature appears as much or as little developed in insects as in ourselves. In our skin there are distinct temperature nerves, located in warm and cold points, but they do not end in special nerve-end organs. Probably the same is true for insects,

although all that we can say about the sense is that the most intelligent insects, such as ants and bees, utilize this sensation to the best advantage in rearing their young which need a warmth as gentle and constant as possible.

All insects can probably distinguish dry air from humid air. Ants are very sensitive to changes of humidity in the soil, while bees are always irritable and cross on very humid days. Bees can also tell when a thunder shower is approaching.

Much has been written about the supposed sense of direction in insects. Bethe calls it a mysterious force that guides bees and ants back to their home. Forel strongly denies any such sense or force and says that the faculty of orientation is the result of the experience of known senses, combined or not, especially of sight, smell, and touch, according to the case and species. In aerial orientation vision mostly predominates; this is well illustrated by the carrier-pigeon and the honeybee, both of which remember landmarks. In terrestrial orientation the sense of smell often plays a predominant part, as illustrated by dogs and ants; but smell gives place to sight in many animals, among which are man, monkeys, and arboreal reptiles. In the orientation of subterranean and cave-dwelling animals, smell and touch reign as masters. In spiders, it is touch which is the principal orienting sense.

Forel thinks that pain is much less experienced in insects than in warm-blooded vertebrates. Cases could be cited showing that certain insects experience little or no pain at all when wounded, while other cases could be cited indicating that they do experience pain; nevertheless, their signs of discomfort when wounded can probably be explained merely by reflex actions. On the other hand, bees with mutilated antennae seem to suffer considerably and do not live long. They do not bleed to death for the wounds soon heal, but appear to die from effects of the shock. Since pain in the higher animals is nature's indicator that something is wrong, there is no good reason why the higher insects should not also experience pain.

INTELLIGENCE OF INSECTS.

Now as we have closed the brief discussion concerning the senses of insects, let us inquire as to how well the sensory impressions have been stored in the brains of insects. This subject has been much debated and we find two of the chief authorities taking opposite extremes. Bethe regards insects as reflex machines and does not use any term which has any resemblance to anthropomorphism, whereas Forel probably goes to the other extreme by attributing too much to the intelligence of insects.

Bethe claims that all the activities of insects, being guided by instinct, can be explained by reflex actions, and therefore it is not necessary for insects to think and to remember past experiences.

Forel claims that insects have passions which are more or less bound up with their instincts. Their passions vary enormously according to the species. Certain species are extremely irritable and choleric, as for example, wasps, certain ants, and a few beetles. On the other hand, other ants are gentle, peaceful, and timid. The rage of a certain ant can make it like a mad thing and leads it to kill its own slaves. Forel has noted the following passions or traits of character among ants: Rage, hatred, devotion, jealousy, perseverance, gluttony, discouragement, despair, fear, and temerity. When we observe the more stupid species, we no longer recognize passions, apart from hunger, thirst, and sexual appetite. The memory of insects varies much according to the species, being best developed in the social Hymenoptera and least in the small brained forms. Forel says:

It must be admitted, therefore, that insects are capable of perceiving, of learning, of recollecting, of associating their recollections and of utilizing them to accomplish their ends. They have various emotions and their will is not purely instinctive, but offers individual plastic modifications, adapted to circumstances.

Bouvier in 1918 (*Le Vie Psychique des Insectes*) seems to support Forel's view by saying that insects can not be regarded as simple reflex machines, because they can adapt themselves to circumstances, acquire new habits, learn to remember, and manifest discernment.

In conclusion, let us cease looking with scorn upon insects. Instead we should marvel at the things they have accomplished. Comparing their organization with ours, they have perhaps accomplished comparatively more than we have. Some of the social insects probably adopted the laws of physiological division of labor before did primitive man, and they had not only equal suffrage, but also woman suffrage long before the dawn of our civilization. In fact, their evolution of female suffrage has been carried to such an extreme that the males are now not only defenseless and helpless in many ways but also have become drones in the fullest sense of the word; the males have degenerated to such a degree that their only purpose in life is to propagate the species, while the true females (queens) are nothing more than egg-laying machines. Furthermore some insects, for example honeybees and plant lice, have evolved methods for controlling sex; this subject has probably puzzled man as much as life itself, yet man can neither control sex nor knows how to control it.

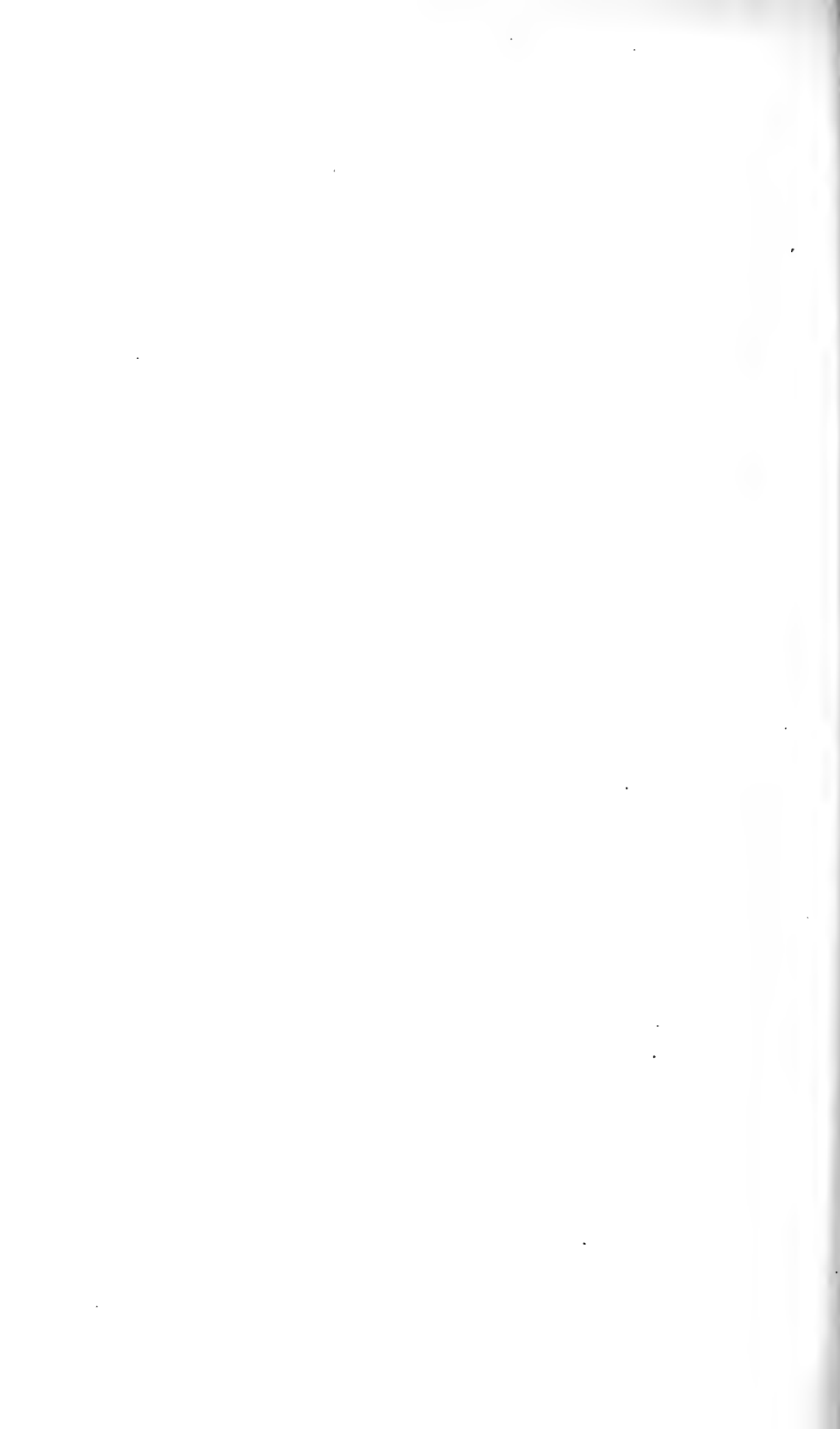

THE RESPLENDENT SHIELD-BEARER AND THE RIBBED-COCOON-MAKER: TWO INSECT INHABITANTS OF THE ORCHARD.

By R. E. SNODGRASS,
Office of Deciduous Fruit Insects, Bureau of Entomology.

[With 3 plates.]

THE RESPLENDENT SHIELD-BEARER.

In the early days of autumn, when the orchard begins to color with the mellow tints of fall, there may be seen in many of the apple leaves little oval holes, each in the larger end of a triangular spot of dead-leaf tissue. An examination of the twigs and branches of the same trees will reveal, attached to them here and there, small yellowish scalelike objects fastened at one end to the bark by a cluster of root-like threads. These disks may be fitted exactly into the perforations

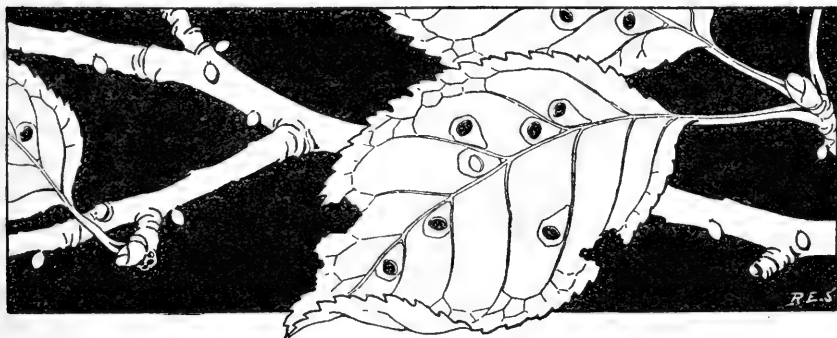

FIG. 1.—Showing winter cases of the Resplendent Shield-Bearer attached to twigs in late fall, and holes in leaves where they were cut from the summer mines.

of the leaves, thus identifying their origin, but giving no hint of how they arrived at their present positions on the twigs. If, however, we split open one of the little shields, there is disclosed within a diminutive caterpillar, whom we may rightly suspect of having cut out the bit of leaf and carried it away to use as a winter home. If not disturbed, the caterpillar would have hung up in his case all winter, transformed within it to a pupa in the spring, and finally come out as a minute, feathery moth.

When the caterpillar first hangs up in its case it is a dark, flat-bodied legless creature, but it soon sheds its skin and becomes a

soft, orange-colored grub, retaining, however, all the vital organs of an insect. The moth produced by this simple larva's transformation, though but a tenth of an inch in length, not only has all the parts of a perfect insect, but is richly dressed in a splendor of color, as if to recompense itself for its long season of poverty and confinement by an extravagance of luxury. Entomologists have, therefore, given its species the name of "Resplendent Shield-bearer," or, for technical purposes, *Coptodisca splendoriferella*. The creature fully deserves both parts of its name, though it divides them between the two principal stages of its history, since as a moth it is not a shield bearer and as a caterpillar it is not resplendent.

The body of the moth (pl. 1, *C*) and the front halves of the folded wings are plain silvery gray, with a bluish cast and iridescent reflections. The ornamentation from which the species gets its name is lavished upon the expanded rear halves of the wings, which fold together in a steep declivity on either side. On each, in a field of gold, three silvery white spots stand out in strong relief against areas of black, while the end of the wing, tapering abruptly to a point, is bordered by a wide fringe of pale brown hairs, in which a pencil of black makes a shaft through the apex. The concealed parts of the body and the hind wings are plain pale gray, the legs and antennae brownish. But the hind wings, brought into view when the others are spread (pl. 1, *D*), though plain in color, are remarkable in form. Each consists of a feathery fan, its membrane being reduced to a mere tapering strap, fringed all around with long, soft hairs, which reach a length on the hind margin greater than half that of the supporting strap itself.

All the caterpillar's labors and endurance might appear to be for the purpose of producing this microscopic bit of perfection, yet the moth lives for no other purpose than to produce more caterpillars. The writer was not able to find the eggs of the shield-bearer moth, and others report finding them only after hatching, yet those of related species are easily found, and from them we know that the hatching caterpillar gnaws its way through the bottom of the egg and tunnels directly into the interior of the leaf. The young shield-bearer at least enters the leaf at a very early age, and there lives between the upper and lower surface or epidermal layers, feeding on the soft tissues, called parenchyma, between them (pl. 1, *F*). It soon hollows out a flat chamber or mine, and as it grows the cavity widens and becomes of a triangular or ovate form. The epidermal layers of the leaf die and the mine shows as a semitransparent, yellowish, or reddish brown spot on the surface (pl. 1, *E*), the smaller end usually wedged into an angle between the midrib and the base of a vein or into that between a vein and one of its branches. Most of the mines occur somewhere along the median parts of the leaves.

When an infested leaf is held to the light the body of the caterpillar can be seen within the mine occupying a clear space at the larger end, the smaller end being filled with a dark mass of granular material.

Since the caterpillar's whole business at this stage of its life is to eat, it has no affairs to take it outside of its abode in the leaf, and, since it never cleans house, it has no need of either doors or windows. It feeds along the edge of the ever widening larger end of its one room and packs all undigested refuse into the smaller end, which accounts for that dark granular mass just noted. As the caterpillar grows it sheds its skin at least twice, and the discarded garments are thrown into the common rubbish heap.

By the time the larval shield-bearer has sated its appetite it has constructed a mine from three-eighths to half an inch in length with a widest diameter of about a quarter of an inch, though different mines vary much in size and many are smaller than this. The caterpillar itself, when fullgrown, reaches a length of from one-tenth to one-eighth of an inch. Its body is flattened, wide in front, tapering toward the rear (pl. 1, *F*), and consists of 13 segments, with a small head, usually more or less retracted into the large first one. The color is blackish above and below, pale yellowish or orange along the sides. The skin is roughened all over with microscopic rugosities, round or oval in shape, but is naked except for a few minute hairs scattered over its surface and a group of larger ones on the side of each segment. The creature has no legs, but on the back and venter of segments 2, 3, and 11 are pairs of colorless oval spots situated on soft elevations, while on segments 6 to 9 there are similar transversely elongate areas on the ventral surfaces only. The skin on all these areas is thin and flexible, though covered with small oval thickenings, and is capable of being puffed out and retracted in such a manner as to suggest that these points act as adhesive disks, enabling the caterpillar to retain its position between the two walls of its mine. Those on the lower side of the body are used also as organs of progression, for as we have seen, the caterpillar eventually walks away with the part of its mine it uses for a winter case. Thus the worm-like creature, though legless, can not only maneuver about in its flat dwelling, where legs might be an incumbrance, but, having attained any desired position, is probably able to maintain itself there against the swaying of the leaf by three pairs of adjustable hydraulic wedges. To our imagination such a mode of life in a cell so small that the occupant can but worm about on his stomach seems nothing short of medieval torture; yet, pleasant or not from a human standpoint, there is always plenty to eat, and if the supposed unfortunate is liberated from his prison he starves to death from helplessness.

The caterpillar's head is a delicate capsule, conical in outline as seen from above or below, but very much flattened. The jaws are

also flat but have no other special characters, each being triangular with a pair of teeth at the cutting angles. The outline drawings in figure 2, *B* show on each the socket above and the knob below by which the jaw is articulated to the head on a vertical axis, allowing it to swing out and in but forbidding any grinding motion. The jaws are excavating tools rather than organs of mastication. On the edge of the lower lip (fig. 2, *C*) is a large hollow spine (*Spn*),

the spinneret, through which the ducts of the silk glands within the body open to the exterior. We shall see later the use which the caterpillar has for silk.

The majority of the caterpillars of the spring generation attain their full growth by the latter part of July, when they cease feeding, cut out their cases from the mines, hang them up on the twigs, change to soft, orange-colored grubs, then to pupae and transform to moths. At this season only about two weeks elapse between the cutting of the cases and the appearance of the moths. It is, however, seldom possible to set down exact dates for the acts of any insect because its activities always vary with the season and with the latitude. In the northern parts of a species' range the individuals have to hurry through the summer stages in order not to get caught unprepared for winter, while in the south they may dally along to a much later date. Like-

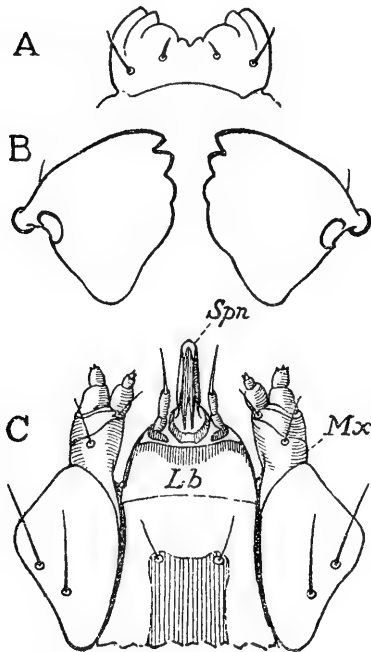

FIG. 2.—Mouth parts of the feeding caterpillar of the Resplendent Shield-Bearer. *A*, the upper lip or labrum; *B*, the jaws or mandibles; *C*, the combined maxillae (*Mx*) and labium (*Lb*), situated below the mouth; *Spn*, the spinneret.

wise, the same species may have only one yearly generation in the extreme northern parts of its territory and go through several in the southern parts. Hence, it is only a matter of local interest in the study of any species whether it has one generation during the year or six, though the determination of this as well as the approximate dates often becomes a matter of much importance for the application of control measures in the case of injurious species.

The resplendent shield-bearer in southern New England and in New York goes through two generations each season. The second brood of moths, appearing during August, lays eggs which produce the second or late summer brood of caterpillars, and these cause

the fall perforation of the leaves we first noticed. In order, therefore, to make a single narrative out of a double story, let us resume our history with those caterpillars that mature in the autumn. Some of these cease feeding during the latter part of September while others keep on till the last week of October. But, at some time during this period, there comes a prompting to the caterpillar to do an act it has never done before, an act which it has even carefully avoided doing up till now. This is to bite a hole through the wall of its mine. The hole is not a careless puncture but is made deliberately and so placed, in the large end of the mine, that a crescentic line drawn through it would leave plenty of space for a similar reversed crescent on the same surface with the concave edges toward each other. The caterpillar next proceeds to lengthen the hole into a slit, following this imaginary crescentic line, and then cuts a corresponding slit in the opposite wall, after which it carries the two along together till there is formed perhaps an almost semicircular incision through both surfaces of the leaf. The caterpillar all the while works from the concave side of the cut and, in order to hold the two resulting flaps in place, sews their lips together as the work progresses, with threads of silk spun from the spinneret.

A caterpillar at work on an incision like this was watched till the job was finished in order to get a complete report on the procedure. Having finished the crescent, the worker continued the cutting from one end of it toward the other in a corresponding reversed crescent, herself between them, till she had thus all but severed two small, oval disks which finally remained attached to the rest of the leaf by only a slender tongue from the lower one. Two hours and fifteen minutes had elapsed since the start, but as the cutting progressed the caterpillar frequently interrupted it to stitch the severed edges together, so that, at this stage she was inclosed in a little case made of the two leaf disks fastened together along the sides but open at each end.

With the case thus all but free from the leaf, the caterpillar turned about and occupied herself with further sewing within. But after a few minutes she came back and gnawed very carefully at the connecting strap, reducing it to such a narrow width that it looked as if the little piece must certainly drop out. But it did not, and the caterpillar returned to her sewing. Presently, however, she reverted to the attachment and this time reduced it to the merest shred. Yet the case did not even sag. The caterpillar again went about her spinning with no outward mark of excitement or of apprehension, though her habitation hung by a thread. At length she came once more to the edge, felt slowly along the lower lip till the connecting strand was located, and with a clip or two of her jaws severed it. Nothing happened; the shell remained in place, held in its frame by the tangled

hairs on the lower side of the leaf. Had the leaf been inverted the house might have fallen, though as a precaution against such an emergency the caterpillar had already sewed the lower flap of the door to the edge of the leaf. To test the efficiency of this anchorage I gently poked the case out of the hole in the leaf. It dangled safely in mid air, demonstrating that just this contingency had been provided against, except that ordinarily the wind would be the cause of it and not some meddling entomologist.

Another hour had gone by. During the next hour and a half the caterpillar occupied herself with the weaving of a thin silk lining over the inner walls of her future dwelling. I now put the hanging structure back into its frame and set the twig bearing the leaf before an electric light, thinking that the coolness of the evening might interfere with the worker's activity. In immediate response she poked her head and thorax out of the door at the anchored end, grasped the lower surface of the leaf with her ventral thoracic footpads and drew the case out of its hole, letting it hang as before. But now the time to be off had arrived. The tether was cut by a bite with the mandibles, and with her fore parts protruded the caterpillar dragged her house a short distance from the hole, when suddenly down went both house and occupant—but at the end of a thread run out from the spinneret. The drop had been planned deliberately and a new thread attached to the leaf before the caterpillar relaxed her hold upon it. This happened at just 8 o'clock. Before the case landed on the table it was caught on a leaf, then removed to a piece of twig and the latter placed in a wide bottle. Here the caterpillar traveled about with her house for about 15 minutes and then rested. It was not until after 5 o'clock the following afternoon that she finally came to a permanent anchorage, selecting as a site the under side of the cork stopper to the bottle.

During the first part of October one may see many of the shield-bearer cases dangling from the apple twigs at the ends of long threads (pl. 1, *G*, *d*), swinging about in all directions or blown out like kites in the wind. Since walking is a very slow means of progression for creatures without legs who must, moreover, carry their houses on their backs, this aerial mode of travel is the more popular style. When the case happens to land on a twig, it is first secured there by a thread and then hauled off to some suitable place where it is made fast for the winter. Most of the caterpillars observed did not go far on foot. Their gait is slow, awkward, and laborious. With the head and thorax out of the case door (pl. 1, *I*), the support is grasped by the lower thoracic pads, a few strands of silk attached to the bark by dabbing the point of the spinneret against it several times, then by contracting the rear part of the body the case is pulled up over the head and the anchoring threads are stuck to the lower flap of the door. Again the traveler reaches out, dabs on some more silk, draws the case up as before, and secures it in the new position. Since I

never saw one cut the anchorage before pulling up, it may be that the caterpillar uses enough force to break the old threads each time. As the process is repeated over and over, the little bag flops this way and that in its progress, now stands vertical, now topples over or hangs from the side of the twig, wavers, and goes forward again by a short jerk.

At last a place is found that appears to fill requirements for a hibernation site, and the case is there firmly anchored to the twig by a fan-shaped bunch of threads glued to the threshold (*J*). During the journey both ends of the case are wide open, but when finally attached the front door is closed by a wall of silk spun within the vestibule. Later the back door is usually closed also, but by only a very thin web. The occupant, now reversed, rests in this position after its work and travel. The caterpillar observed through this period remained thus until the 23d of October, when it shed its summer working clothes and appeared in its soft orange-colored suit for winter. Having cut its case on the 15th and attached it to the cork in the bottle the following day, a week had elapsed before the molting. Others worked more rapidly than this one, and many tied up to a twig only a short distance from the deserted leaf.

Examination of cases out of doors showed, however, that it is normal for the caterpillars to molt a short time after the case is attached for the winter.

In its winter condition the caterpillar looks much more delicate than in its summer form, being, as already stated, a soft, pale-orange creature about one-twelfth of an inch in length, or one-sixth to one-third shorter than in the mature feeding stage. (Pl. 1, *K*.) It is cylindrical in shape, consisting of a small head and 13 body segments, and lacks both legs and sucker pads, though there is a dark, horny ridge across the under side of the first segment which in some way may assist it to hold itself steady in the case. The skin is finely granular all over and apparently naked, except for a few hairs on the head and last body segment, though other very minute hairs are present as in the preceding stage. The head is wider in proportion to its length than in the feeding form, the upper lip is less deeply notched (fig. 3, *A*), and the jaws (*B*) are relatively smaller. The spinneret (fig. 2, *C*, *Spn*), however, is still well developed and is soon put to work. The caterpillars in the summer cocoons change also to the orange-colored form, but remain in this stage only a few days before transforming to the pupa.

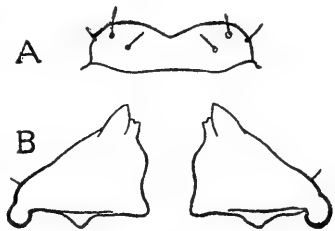

FIG. 3.—The upper lip (*A*) and jaws (*B*) of the cocoon stage of the caterpillar of the Resplendent Shield-Bearer.

After the molt the discarded skin is shoved off to one side of the room and the caterpillar proceeds to improve its inherited domicile by putting in a new silk lining. This, when finished, makes a closed inner chamber which fits the caterpillar's present size much more snugly than did the dimensions of the original case. Beneath the eaves of the latter there is now an empty closetlike space on each side, in one of which are stored the old summer clothes.

Out in the orchard in late fall and all through the winter the tiny yellowish cases may be found stuck about most anywhere on the twigs and branches of the trees or even down against the trunks and on the bases of the larger limbs. Most lie flat against the bark, some are pendent, a few stand on edge, and an occasional one sticks straight up. On windy days they flap from side to side, whirl about on the pivot of their anchorage, or are set into a rapid and continuous vibration. By spring the occupant has been put through a test of equilibrium such as few aspirants for aviation could endure, but its functions have been in no way upset.

The cases vary somewhat both in size and shape, some being much broader than others in proportion to their length. The larger ones measure about 4 by $2\frac{1}{2}$ millimeters, the smaller 3 by $1\frac{3}{4}$, the variation in width being greater than that of the length. The side formed from the under surface of the leaf, which usually retains some of the original leaf hairs, is flat or a little concave, while the other bulges out, especially along the middle. This difference of the two sides appears to be due to unequal shrinkage of the two leaf layers, since both were of the same size when newly cut out.

If nothing happens to interfere with the course of its normal life, the hibernating caterpillar will survive in its case all vicissitudes of winter weather, and in spring, about the end of April in southern New England, will change to the chrysalis stage or pupa, finally casting off its larval skin. The pupa (pl. 1, *B*) is also a soft creature, of a pale yellowish color, which becomes brownish on the fore parts and on the areas covering the future legs and wings. During the next month the moth develops within the pupa and, when all is ready for its emergence, the pupa penetrates the silk wall of its chamber, squirms through the door at the free end of the case, and hangs out over the threshold, with two-thirds of its body in the air. Then its skin breaks at the head end and the moth emerges, leaving the empty pupal shell sticking in the vestibule of the now deserted case (*A*).

The arrival of the moth means that the cycle of the insect's life has been again successfully accomplished. But in nature few of the little cases cut out and hung up with such care and labor by the caterpillars are destined to give forth moths in the spring. After spending almost their entire existence under cover, either in the mines or in

the cases, exposing themselves only during the brief journey from the mine to winter quarters, but a small percentage of the autumn brood of caterpillars escapes destruction at the mouths of enemies. Most of the cases examined in the spring are found to contain not the original occupant, but either the grub or the pupa of another insect, a usurper, a parasite that by some means gained entrance to the house, destroyed the rightful owner, and without any skill or work of its own, enjoys the protection that the shield-bearer worked so hard to insure for itself during the period of its helplessness. It was not by any negligence on the part of the shield-bearer caterpillar that the parasitic grub invaded its home, nor was it through any cleverness of the changeling. It was the mother of the intruder that got it into its present comfortable quarters, for the grubs are the young of a

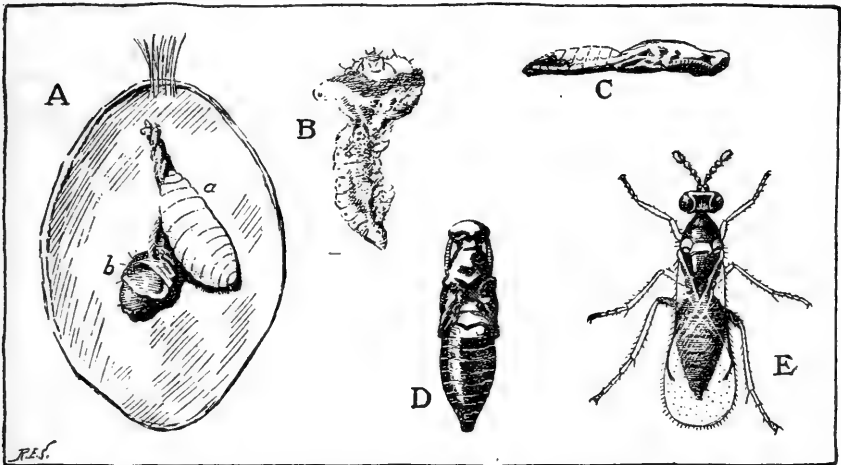

FIG. 4.—A parasite of the Resplendent Shield-Bearer (*Cirrospilus flavicinctus* Riley). A, Winter case of the shield-bearer with one side removed, showing the parasitic grub (a) and the remains shield-bearer caterpillar (b); B, remains of a parasitized caterpillar reduced to a dry flake; C, the pupa of the parasite, side view; D, the same, back view; E, the adult parasite.

minute, wasplike insect which, with a needlelike ovipositor, is able to pierce the mine and insert an egg probably into the body of the caterpillar itself.

The history of this particular parasite of the shield-bearer is perhaps not known, but, with others related to it, the egg hatches within the body of the caterpillar, where the young grub feeds on the caterpillar's blood, but does not destroy its life till the caterpillar has spun its cocoon. Then when the grub is full grown it comes out of the body of its long-suffering host, leaving the latter weak and emaciated, to die of exhaustion, while it changes to a pupa and finally to the adult of its own species. The writer has seen this shield-bearer parasite, or another very similar to it, piercing the mines of the trumpet-miner of the apple. The dead shield-bearer caterpillar found in the parasitized cases by spring is usually reduced either to

a blackened mummy (fig. 4, *A, b*) or to a mere dry flake (*B*), but it is always the remains of the summer larva (pl. 1, *F*), indicating that the caterpillar probably carried the parasitic grub from the mine in its own body, but that, once the case was secured for the winter, its further development was inhibited. The parasitic grub transforms in early spring within the case, alongside the remains of its victim, to a flat, shiny-black pupa (fig. 4, *D, C*), and this to the adult (*E*), which emerges by gnawing a hole through the side of the case.

The adult parasite is about one-twelfth of an inch in length, of a brilliant blue-black color, showing green or bronze reflections according to the angle of the light. On the middle of the back there is a bright yellow spot, and there are generally yellow epaulets at the bases of the wings. The eyes are bordered above with yellow and there is usually more or less yellow on the face. The four wings are

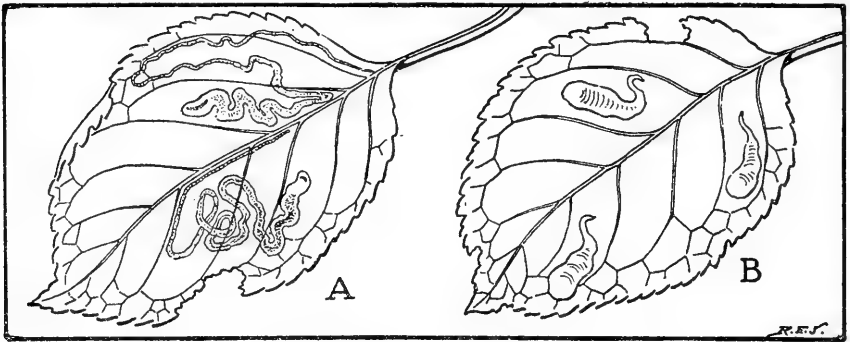

FIG. 5.—*A*, mines of the Serpentine Miner in an apple leaf; *B*, mines of the Trumpet Miner in an apple leaf.

transparent and without markings, but are iridescent with emerald, violet, and purple. The legs are pale yellow, with darker feet and usually brown hind femora. The name of this species is *Cirrospilus flavicinctus*.¹ It belongs to the family Chalcididae of the order Hymenoptera.

The summer cases were found infested by another parasite, *Closterocerus tricinctus*,¹ the pupa of which is black and flattened like that of the other. The adult is even smaller. Its body is of a shining blackish-blue color, turning to green and gold where the light strikes it strongest. But the front wings give the distinguishing character to this species, since they are crossed by three distinct, curved, blackish-brown bands.

The resplendent shield-bearer is but one of a number of moths whose caterpillars feed by making mines in the apple leaves. Another common one is the trumpet miner, so called because the shape of its mine suggests that of a flaring horn. (Fig. 5, *B*.) This spe-

¹ Identified by Mr. A. B. Gahan, U. S. Bureau of Entomology.

cies carries the mining instinct further than does the shield-bearer, for it not only spends all of its caterpillar life in the mine, passing the winter thus in the dead leaf, but it pupates in the mine, coming out only as the adult moth. The trumpet miner, furthermore, takes more pride in the character of its mine than do most other leaf miners, the walls being lined with smooth white silk and all refuse discharged through trapdoors in the floor, so that the interior is kept fresh and clean. Still another species, the serpentine miner (fig. 5, *A*), is, as the shield-bearer, a miner only during its larval life. But when it leaves the mine it comes out naked and crawls off to a twig, where it spins a cocoon of silk for its pupal period, as does any ordinary caterpillar. A fourth species, the ribbed-cocoon-maker, is less of a miner than any of these, since it tunnels into the leaf during only the first stage of its caterpillar life, after which it

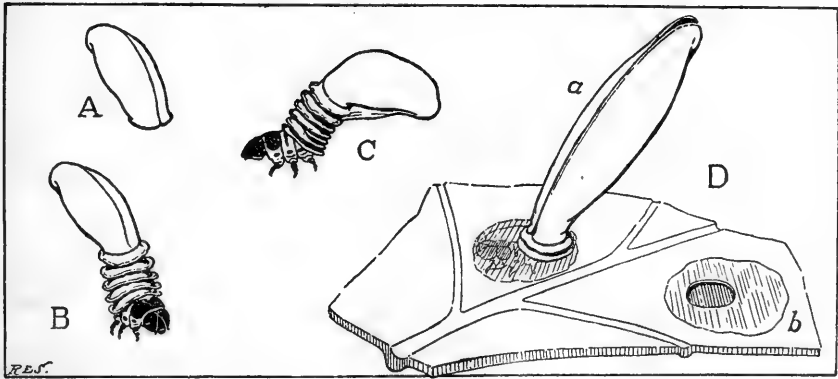

FIG. 6.—The Cigar Case-Bearer. *A*, the winter case; *B*, *C*, the caterpillar in its spring case, consisting of the winter case with additions at the lower end; *D*, the same caterpillar with new cigar-shaped case (*a*) feeding within a small mine in a leaf from lower end of case; *b*, a deserted feeding mine.

feeds openly on the surfaces of the leaves, finally spinning a remarkable fluted cocoon in which to pupate.

On the other hand, there are species that specialize as case makers, neglecting the art of mining or discarding it entirely. Two well known examples are the cigar case-bearer and the pistol case-bearer. The former mines into the leaf when very young to cut out a case which it thereafter wears as a suit of armor, traveling about in it and feeding from its lower end. During winter it hibernates in this case (fig. 6, *A*) after firmly attaching it to the bark. In spring the caterpillar becomes active again, adding frills of leaf cuttings to the lower end of its case as it grows (*B*, *C*), but soon is forced to cut out a new one to accommodate its increased size. This second case (*D*, *a*) is long and cigar-shaped, whence the wearer gets its name. The caterpillar feeds by burrowing into the leaf only as far as it

can reach from the lower end of its case, the latter being sewed to the leaf surface (*D, a*). After each meal the caterpillar detaches its case and moves off to another place. The cigar case-bearer thus makes many small mines (*D, b*), but its mining habit is only incidental to its feeding. It derives its protection from its cases, which it wears throughout its larval life, finally using the second as a retreat during its chrysalis stage. The pistol case-bearer renounces mining altogether, making its case of silk, and enlarging it as it grows. In feeding it makes irregular holes clear through the leaf or eats their tissue down to the larger veins and the mid rib after the manner of common leaf-feeding caterpillars. These species of minute moths and several others that frequent the orchard are thus noted for the great variety of skill they possess in their



FIG. 7.—Apple twigs in fall showing *Bucculatrix* cocoons along lower sides, and scarred leaves on which the caterpillars have fed.

caterpillar stages as miners or as case makers. But one of them is famous as a cocoon builder. This is *Bucculatrix pomifoliella*, or

THE RIBBED-COCOON-MAKER OF THE APPLE.

As with the resplendent shield-bearer, autumn is the time when one is most likely to make first acquaintance with *Bucculatrix* in the orchards. A search at this season along the under sides of the twigs and branches of the apple trees is pretty likely to reveal little, whitish, spindle-shaped objects, about a third of an inch in length, stuck lengthwise against the bark. (Fig. 7, and pl. 2, *A*.) A closer inspection (fig. 8) shows that each is fluted with a number of ridges that disappear at the tapering ends; which character identifies them as the cocoons of the *Bucculatrix* caterpillar. Ordinarily they are scattered along here and there, but, when the caterpillars have been

specially abundant during the summer, the cocoons often lie close together or may be even massed against one another. When newly made each cocoon is hedged about by a bristling palisade of silken spikes, 25 or 30 of them, standing erect in an oval about its long axis (pl. 3, *H*). But these delicate threads are soon broken off or beaten down by the wind and rain till little evidence of them remains.

If we would interview the occupant of one of these fluted wigwags we must break in by force, for there is neither door nor other entrance; and, once in, we are likely to find that the owner is asleep, already in the chrysalis or pupa stage, and therefore in no condition to give us much information. However, though we can learn little at this season of the creature that made the house, the structure of the dwelling itself is well worth a study. Its form (fig. 8) is not entirely symmetrical, one end being slightly thicker than the other and tapering more abruptly, unless the other happens to abut against some projection of the bark, as it frequently does, when it may be cut off square. There are usually seven of the lengthwise ribs, one median and three on each side, though the uppermost pair, those nearest the foundation, are sometimes lacking.

The tapering ends are made of thinner material than the middle part,



FIG. 8.—Cocoon of *Bucculatrix pomifoliella*, the Ribbed-Cocoon-Maker of the apple (enlarged 10 times).

and, in the larger end, the edges of several sloping, crosswise partitions are faintly visible. There are usually three of these but the number varies from one to four.

The walls of the cocoon consist of two layers (pl. 3, *F* and *G*), a thick outer sheathing (*c*) in which lengthwise thickenings form the ribs, and a smooth inside lining (*d*) which has a different texture and is of a pale yellowish tint. The outer sheath is securely attached to the support all around the base line, while the inner layer forms a complete capsule within the shelter of the other. The interior is divided into a main chamber (*e*) and several antechambers by the crosswise partitions (*f*) above noted. The main compartment (*e*) is a snug little room, well lined with silk, about two-thirds the total length of the outer cocoon. It is occupied by the pupa (*g*) which lies on its stomach with its head just behind the rearmost of the front partitions. Tucked away in a wad at the rear end of the chamber is the cast-off skin of the caterpillar that built the cocoon and inclosed itself in the pupal compartment, then shedding its working clothes and assuming the pupal form for the long winter rest.

The *Bucculatrix* pupa is a compact, cylindrical chrysalis, about one-eighth of an inch in length, of a dark reddish or purplish-brown

color (pl. 2, *B*). Its thick skin forms a rigid shell except at the articulation between the seventh and eighth segments of the abdomen, where the flexible membrane of this joint permits a free rolling motion to the terminal segments, the ninth of which is provided with a strong spine on each side. The head terminates in a sharp, beak-like point directed downward (pl. 3, *F*). In the spring when the moth is ready to emerge from the pupa, the pupa forces itself through the front end of the cocoon, when the moth makes its escape by breaking through the head end of the pupal skin, leaving the latter projecting from the rent in the cocoon (pl. 2, *C*).

We may get an idea of how the pupa makes its exit if we cut a small hole in the rear end of its chamber and push the hard-shelled creature gently forward with some blunt-pointed instrument. As the head is forced under the sloping partition in front of it, the beak penetrates the floor and the pupa gently slips out of the widening rupture. (Fig. 9.) A further examination of the partitions shows that, though each consists of a tough disk of felted silk, they are very insecurely attached to the chamber walls except at their bases, the lower

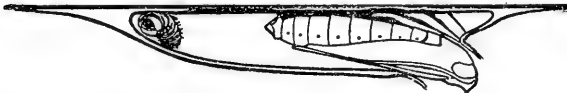

FIG. 9.—Diagram illustrating how the pupa of *Bucculatrix* emerges from its cocoon. (Compare with *F* on plate 3.)

edges being but loosely stitched or scarcely attached at all. They thus suggest valves or trapdoors rather than

true partition walls, and the above experiment has given us an indication of their function.

The living pupa has its own propeller at the rear end of its body, consisting of the motile terminal segments and the lateral spines on the ninth. We can imagine that by a semirotary motion of these parts the pupa pushes itself forward, the spines enabling it to obtain a hold on the silk walls of its chamber. As its head comes beneath the sloping surface of the nearest valve-like partition (pl. 3, *F*, *f*) the latter gives somewhat, but, as this one crowds against those in front, it exerts an increasing downward pressure on the pupa's head which forces the beak of the latter through the floor of the cocoon. The pupa, continuing to press forward as the rent enlarges, eventually forces half or two-thirds of its body through the opening. (Fig. 9.) The desired position being thus obtained, the spines of the quieted propeller probably now serve to anchor the rear end of the body in the cocoon.

The moth of *Bucculatrix* (pl. 2, *D*) is larger than the shield-bearer moth, being about one-seventh of an inch in length to the tips of the folded wings. The general color is yellowish, mottled with brown, black, and white. The crown of the head is covered with long plumes combed forward over the brow in bangs which almost conceal the

face. Two little, black, featherlike tufts project from the shoulders, and on the middle of the back of the closed wings is a large black spot.

The first part of May is the usual time of emergence in southern New England and in New York State, with the date earlier farther south. The female moths lay their eggs on the leaves, usually on the under surfaces (pl. 2, *E*) but sometimes on the upper. Each egg (*F*) is a tiny, flattened, elliptical object of a pale greenish tint closely resembling that of the under side of the apple leaf, where it is generally placed close to a midrib or one of the larger veins, well concealed amongst the tangled leaf hairs. The writer made no record of the incubation period, but others have stated that the eggs hatch in from 6 to 10 days. The young caterpillars are born with the instinct of miners and burrow directly through the bottoms of their eggs into the tissue of the leaf. Here each eats out a mine as does the young shield-bearer, only the mine of the young *Bucculatrix* is a winding tubular gallery (pl. 2, *G, c*) gradually enlarging as it lengthens. The mines might be mistaken for those of the serpentine leaf miner (fig. 5, *A*), except that they never reach the length that these mines do, and they can usually be identified by a dark, purplish red discoloration of the leaf immediately about them. The young caterpillars feed in the leaf only about eight days, when the mines attain a length of one-half or three-fourths of an inch. Then the caterpillars leave the mines through a slit cut at the larger end, usually on the upper side of the leaf, but occasionally below.

When the young *Bucculatrix* caterpillar leaves its mine it is ready to molt, but it still feels the need of protection and proceeds at once to build a special molting tent on the surface of the leaf. It is not evident why it does not do the easy thing and shed its skin in the mine before emerging, but *Bucculatrix* is an individualist and insists on its own way at any cost. Selecting a small depression anywhere on the leaf, a favorite spot being at the very tip where the edges curl up slightly, it lays down a thin carpet of silk against the surface and then weaves over this a flat canopy sewed fast all around the edges but with a round hole in the center. The caterpillar now crawls into the tent through the hole in the top (fig. 10) and closes it with a webbing of silk spun from the inside, often laying on so



FIG. 10.—A *Bucculatrix* caterpillar entering its molting cocoon on the surface of a leaf.

much silk here that the central part finally shows as an opaque disk. The shelter completed, the caterpillar coils up within and waits for the molting process to proceed.

To the naked eye the molting cocoons form tiny glistening spots on the leaves (pl. 2, *G*, *d*), usually near the margin or at the tip, the largest scarcely the twelfth of an inch (2 mm.) in diameter. After two or three days the molting is completed and the caterpillar emerges through a slit cut in one side of the roof, leaving the old skin and the head capsule behind on the floor.

From now on the *Bucculatrix* caterpillar is a free creature, feeding in the open on the upper surfaces of the leaves where it eats out little patches of the epidermis, giving the leaf a spotted appearance (pl. 2, *H*). But after several days of undisturbed feeding it must shed its skin again and for this purpose builds a second molting cocoon. These cocoons become abundant on the leaves during mid-summer. They are larger than those of the first molt, the largest being twice their width, about one-sixth of an inch (4 mm.) in diameter. They may be spun over any little depression of the leaf, most of them on the upper surface but some on the lower, though, as before, the apex of the leaf where the usual twist makes a small hollow, is a favorite site. The caterpillar weaves the whole structure, enters it and closes the door in about an hour's time.

After the second molt the caterpillar appears in the last stage of its larval growth and spends another period of feeding on the leaves (pl. 2, *J*, *e*), many of which on infested trees now become spotted all around their edges with little red-brown areas where the upper epidermis has been eaten off and the exposed lower skin has died. In the network of its veinlets a leaf presents to the caterpillar hundreds of little pans of food, all of which should be of equal quality; but the *Bucculatrix* caterpillar, after having emptied a few pans at one place, moves over to a neighboring spot and there cleans out a few more. Either its appetite is quickly sated for the moment or it always thinks perhaps the fare is fresher farther on, for it keeps up this wandering style of feeding, leaving small groups of empty dishes all over the leaf. After a while it seeks a new leaf, usually dropping down to one below from the end of a thread. Thus each caterpillar damages a single leaf over a wide area and injures many more leaves than necessary for its support. It is not good form with *Bucculatrix* to eat the bottom out of its dish, though sometimes a careless caterpillar makes an accidental puncture with the points of its jaws, but the exposed lower epidermis often cracks as it dries, and leaves that have been badly injured frequently turn brown all over and curl up. Thus, while *Bucculatrix* usually only disfigures the leaves, it may, when exceptionally abundant, do serious damage to an orchard by its widespread feeding on the foliage.

When the caterpillar is full grown in this, its third and last stage (pl. 2, *I*), it reaches a length of 7 millimeters, almost a third of an inch. The body is thickest behind the middle, the skin is naked except for small hairs distributed over its surface as shown by figure 11. The head and prothoracic shield are brown, the latter with a number of small, dark spots (pl. 2, *I*), the body olive or brownish green with a whitish band along each side and around the front edge of the prothoracic shield. The hairs of the body arise mostly from whitish spots on the tops of small swellings.

The caterpillars of the spring brood reach maturity from the latter part of July to the end of August in southern New England and then construct the ribbed cocoons in which they pupate. Slingerland and Fletcher state that in southern New York these cocoons are spun during the first half of July, but at Wallingford, Connecticut, the writer first noted fresh cocoons in the orchard on July 19 and saw others spun as late as August 28 and 29. The summer pupal cocoons are spun on the leaves and even on the fruit, as well as on the twigs, branches, and trunks, the permanency of the site being

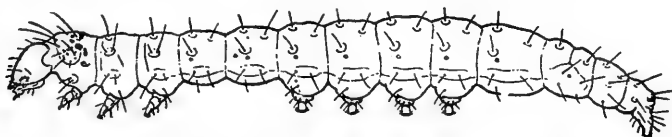

FIG. 11.—The mature caterpillar of *Bucculatrix* (enlarged 12 times).

of little consequence now because at this season the pupal stage is completed in less than two weeks. The moths of this generation emerge during midsummer and lay eggs for a late summer and fall brood of caterpillars. These simply repeat the history of the first brood, but they are generally more numerous, and the damage from their feeding becomes particularly noticeable by early fall. The first to mature in southern New England spin their cocoons during the early part of September while others feed till almost the end of October. As the cocooning time for each approaches, the caterpillar becomes restless, leaves its feeding grounds, explores the tree from the end of a thread, and travels about over the branches till it finds a suitable place for its winter quarters. Though the trees are still full of leaves and fruit, instinct this time tells the caterpillars that safety for the winter is to be found only on the more permanent parts of the tree. Consequently almost all the cocoons spun at this season are on the twigs, branches, or trunks, though an occasional careless or misguided individual builds its house on a leaf. The structure of the cocoon is the same whether built for the brief summer occupancy or for the long period of hibernation between October and May.

When the wandering caterpillar finally chooses a place for her cocoon she proceeds first to weave against the bark a thin oval mat of silk, about as long as her own body when fully stretched out. She thus puts down her carpet first and afterwards builds her house over it.

A caterpillar's silk is formed in a pair of long, tubular glands within the body which open by a single duct through a hollow spine on the tip of the under lip. This spine is the spinneret (figs. 2 and 12, *Spn*). The fresh silk is a gummy liquid which sticks tightly to whatever object it touches and, by contact with the air, hardens almost immediately to a solid substance. To spin this liquid silk into a thread the caterpillar touches the point of the spinneret to the desired support and draws back its head. The viscid raw silk, adhering to the point touched, pulls out of the spinneret as a delicate filament which at once sets into a tough, flexible, inelastic thread.

Most silk structures made by caterpillars are woven from a continuous thread laid on in a multitude of irregular figure-8 loops as the worker rhythmically swings her head from side to side with a forward and backward twist at each turn. The caterpillar thus weaves toward herself, all the while retreating slowly before the advancing edge of her fabric. In this way *Bucculatrix* lays down her carpet, beginning at one end and working toward the middle, then reversing and starting

FIG. 12.—Mouth parts of the *Bucculatrix* caterpillar. *A*, upper lip or labrum (*Lm*) and edge of head with upper hinges of mandibles (*a, a*); *B*, jaws or mandibles; *C*, part of lower side of head with under lip or labium (*Lb*) and spinneret (*Spn*), maxillae (*Mx*), antennae (*Ant*), and eyes (*o*).

the other end as far as she can reach with her hind toes at the end where the weaving was begun. In this way the caterpillar fits the carpet to her own length, and all her subsequent work is based on this one measurement.

After the carpet is finished, the next thing in order is the construction of the stockade. This, when completed, ordinarily forms a symmetrical oval (pl. 3, *H*); but some caterpillars are not expert surveyors, so one often sees stockades of very irregular shapes. One caterpillar, whose procedure the writer followed from beginning to end, eventually placed her pickets in a very good oval but had difficulty in making a proper start. She first set up six palisades in an

arc near one end of the carpet, working from left to right (fig. 13, 1-6). Then she turned about and located the seventh (7) at the opposite end, half again her own length from the arc of the first six. This she followed with six others placed in a regular curve to the right, ending with the thirteenth (13). Again changing position she erected the fourteenth (14) to the left of the seventh and proceeded to the left till the nineteenth (19) was in place. Now she went back and inspected the first six. Evidently deciding that these were too far away, she erected palisade 20 nearer the carpet at this same end, and then filled the gap between 20 and 19 with six pickets. The last three of these were a little crowded and 26 was out of line. Finally, 27 and 28 were placed with good spacing between 20 and 13, when the stockade was completed. Eighteen minutes had elapsed since the start, during which time the caterpillar set up 28 palisades, and 6 of these were superfluous.

A completed palisade looks like a tapering thread of silk standing upright on a spreading base, and, before seeing one made, it is rather puzzling to imagine how the caterpillar can spin such a filament. The palisade, how-

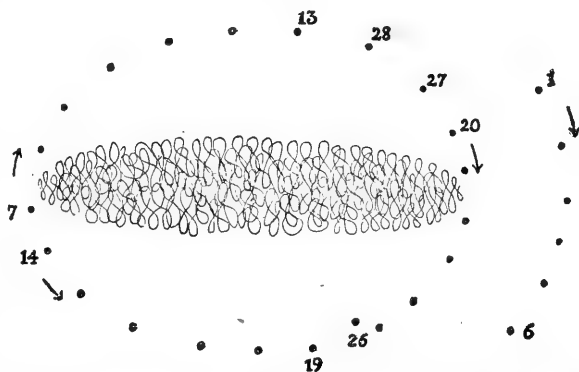

FIG. 13.—Diagram of plan followed by a *Bucculatrix* caterpillar in constructing its stockade. The numbers indicate the order in which the palisades were set up.

ever, is not made of a single thread nor of a strand of threads, but of many short loops drawn up one over the other till finally a long apical loop is whipped out, when the caterpillar works rapidly down again, but only to bind the fibers together here and there. The whole is completed in 30 seconds. While working the caterpillar rears up on her abdominal legs (pl. 3, C) but uses only the first pair of thoracic legs to support herself against the palisade. When the last picket was in place the caterpillar under observation made no further inspection of her fence, appearing to know by instinct that the job was done, or should be. In fact, from now on she ignored the stockade.

Having gone through with the preliminary formality of fencing herself in, the caterpillar stretched herself out on her carpet and indulged in a short rest. After seven minutes repose she became active again, turned to the end of the carpet first made, and there

spun a small mass of silk. In a few seconds this mass took on the form of the tapering end of the cocoon, with five ridges showing almost from the start. As the structure increased in length the caterpillar backed away from it, the rear end of her body going farther and farther off the other end of the carpet. When the cone had widened to the full width of the cocoon an extra pair of ridges was added, one on each side next the base, so that from now on the walls had the regular seven-ribbed construction. The work progressed very rapidly, the weaver being in no way hindered by the fact that never before in her own life had she ever attempted such a task. She needed no apprenticeship; right from the start she knew her trade like an expert workman. Swinging her head regularly from side to side, with an abrupt jerk toward herself where each rib should be, the perfect structure advanced before her. There was no suggestion of cumbrous human methods of putting up a

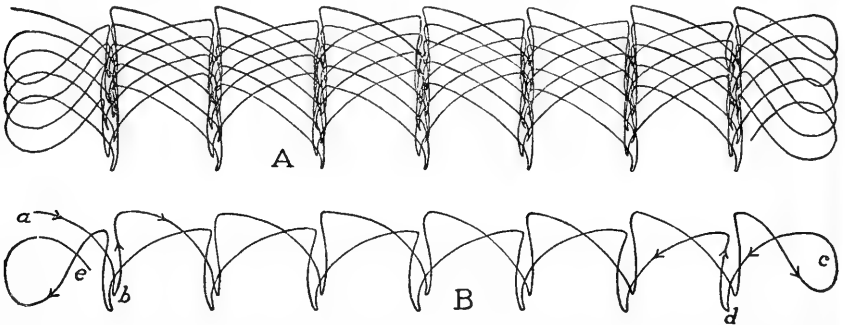

FIG. 14.—A, diagram of the structure of the ribbed cocoon of *Bucculatrix*; B, two crosswise strands of thread (*a-e*), showing how a series of loops to the right (*b*) and a second set to the left (*d*) on the return make both network and ribs.

skeleton of rafters first and then laying on the sheathing. The whole went up together, the seven ridges not only keeping pace with the intervening network, but extending a little in advance all the while.

The work was fascinating to watch and at first it is rather mystifying to see such a complicated edifice grow at such a rate, but by close observation the human eye can grasp the fine technique of the caterpillar, and figure 14 will give the reader an idea both of the cocoon structure and how it is made. A part of the network and its seven ribs is shown at A; the method of the weaving is more clearly seen at B where only two consecutive, crosswise strands are shown. The thread (*a-e*) starting to the right at *a*, swings forward in an abrupt angle at the point *b*, then goes back and again swings forward to the right in another corresponding loop, and so on till there are seven of these advancing points. Then the thread turns on itself at *c* and comes back in the opposite direction, looping, as at *d*, to

the left and a little in advance of each point made in its course to the right. Reaching the left end it loops on itself once more at *e* to repeat the course to the right, and if it were continued in diagram *B* a ribbed network such as that shown at *A* would be produced. This, then, shows the simple method by which the *Bucculatrix* caterpillar arrives at such astonishing results. The ridges are merely the aggregate of the pointed loops, and the network between them results from the two sets of threads crossing obliquely in opposite directions. At the ends the caterpillar does not always make the simple loops shown in the diagrams, since she interrupts the regular swing now and then to run a light foundation a little in advance to which the cross strands are attached. The mesh of the network is not perfectly regular since all the threads in each set are not entirely parallel nor laid on exactly the same distance apart, yet the whole is remarkable for its symmetry.

Simple as the thing may appear when we see how it is done, let any one who thinks it easy attempt to make a rapid, free hand sketch of the pattern of the cocoon fabric. Confusion soon results. Even after laying

off parallel guide lines with compass and ruler it takes much practice to swing off even a fairly correct diagram with anything like the speed of the caterpillar. The caterpillar, moreover, not only works without guide lines but she does not do her work on paper—she must bring up each sharp angle of the rib loops to just the right point in empty space. The caterpillar is shown at work in figure *D* on plate 3, but it must be remembered that in nature the cocoon is nearly always built against the under surface of the support, and hence has more of the nature of a hammock than of a house. Yet, if the support is inverted while the caterpillar is at work, the changed position in no wise interferes with her work.

It is interesting to note here some structural peculiarities about the caterpillar's feet. The first terminate each in a small, simple claw (fig. 15, *A*) such as is common to most caterpillars, but the other two

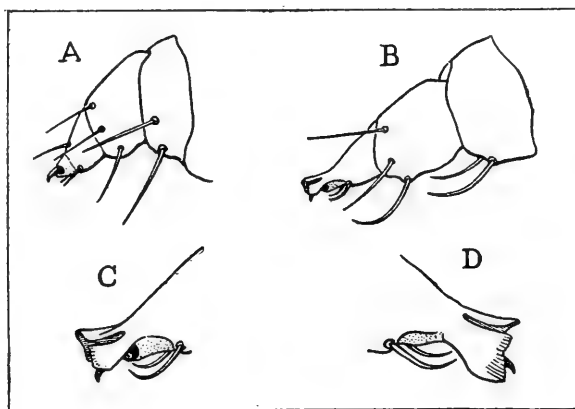

FIG. 15.—Thoracic legs and feet of *Bucculatrix* caterpillar. *A*, Rear view of left front leg, showing exposed claw; *B*, rear view of left middle leg, showing split cuff protecting the claw; *C*, foot of middle leg more enlarged; *D*, front view of left hind claw and cuff.

thoracic pairs end with stiff, projecting cuffs which cover the claws above and on the sides (*B, C, D*). Since the caterpillar uses only the front feet for supporting herself against her work while spinning, or perhaps for holding the fresh thread in place, one might suppose that the cuffs on the other feet serve as guards to prevent their claws from becoming entangled in the thread. But the cuffs themselves are complicated, each being split into two lobes, and it really looks as if they must offer only increased chances for possible entanglement. Other caterpillars get along without claw guards, and none are so clumsy, anyhow, as to get their feet snarled in their knitting.

When the *Bucculatrix* caterpillar has woven about 60 cross strands in each direction, or 120 in all, including over 800 rib loops, the cocoon has reached about two-thirds of its final length and has crowded the worker mostly off the carpet. It is evident that if she keeps on in this fashion she will eventually shut herself out of her own house. But just at this point it appears that the same idea occurs to the caterpillar, for she stops work and crawls into the cocoon till her head touches the inner end. Then she turns "back to back" and emerges in the opposite direction till she reaches the other end of the carpet, which leaves about two-thirds of her body under cover. In this reversed position she weaves the second end of the cocoon in the same way that the first was made, except that she now backs into the part already completed as her work advances (pl. 3, *E*). Thus she is at least assured of being inside when the thing is done. But now the question arises of how she will be able to bring the opposing edges together when the space between them becomes too narrow to emit her head and shoulders. When this stage is reached, however, and just when the observer is most keen to witness some clever trick, the caterpillar calmly withdraws her head and deliberately bridges the space with a network of ordinary figure-8 loops, continuing till the interval is closed by a plain sheet of silk. A commonplace finish enough, and one that makes a very weak ending to an otherwise highly entertaining show, yet the simplest thing to be done in the face of an impossibility. The caterpillar observed for this description connected the two ends of her cocoon very neatly and finished with the ends of the opposing ribs in good alignment. An examination of other cocoons, however, shows that the weaver is often somewhat bungling in this last act of her work, for the lines of the ridges frequently do not match at the bridge, and sometimes those of one end run into the grooves of the other. Usually a slight sag is evident at this point.

But the closing of the ribbed cocoon is not the end of the caterpillar's work. When the bridge is finished she keeps right on with

her spinning, weaving figure-8 loops over and over the entire inner surface of the cocoon till the meshes of the latter are closed and the whole becomes opaque, while the worker within gradually disappears from view. This task continues for several hours and the result is the snug inner pupal chamber already described (pl. 3, *G*, *e*). Finally the valves (*f*) are put into the short section of the cocoon and this end becomes the front of the final edifice, i. e., the end from which the moth is destined to emerge. Therefore, the last act of the caterpillar before molting is to arrange herself with her head toward the valves, so that when the skin is cast off the pupa may lie in position to break through the proper end when the time for the emergence of the moth arrives.

The caterpillar can not stretch out full length in the pupal compartment, because the latter is much shorter than the length of the outer cocoon, which is scarcely longer than the length of the fully extended caterpillar. But all is well with the shedding of the skin for, by the accompanying change to the pupa, the creature shrinks to half its larval length. The moth again (pl. 2, *D*) is still smaller than the pupa and, except for its wings, looks entirely too diminutive to be the parent of such a monster as a full-grown caterpillar (pl. 2, *I*). The mature caterpillar, therefore, represents the period of maximum bulk attained by the insect, after which there is a retrogression in size. This is accounted for by the fact that the caterpillar is a specialized feeding stage in the insect's life, during which it manufactures within its body a sufficiency of food products to carry it through the fasting pupal stage and to supply most of its wants as a moth, whose special function is that of reproduction.

There is nothing more delicately beautiful in insect architecture than the freshly spun, waxy white, finely ribbed cocoon of *Bucculatrix*, surrounded by its bristling wall of delicate thread-like palisades (pl. 3, *H*). But exposure to the weather soon reduces this fairy wigwam to a shabby thing of dirty gray, while the slender palisades are so beaten down by wind and rain that by spring it takes an expert search to locate even traces of them. At best a stockade of silken hairs must be but a flimsy barrier against any sort of enemy. And whatever military theory of defense the caterpillar may have held while building it, she evidently attaches little of practical importance to it for, even as she erects the slender pickets, she heedlessly brushes down those she has just set up and frequently tramples others in her subsequent maneuvers. To the caterpillar, however, instinct says that a stockade must be there before the cocoon shall be built, and the mandate of instinct is law in the insect world.

Many other papers have been published on these interesting little pests of apple orchards, chief amongst which are those by J. H.

Comstock, Report of United States Entomologist for 1879; A. E. Brunn, Second Report, Cornell University Agricultural Experiment Station for 1882-83; J. H. Comstock and M. V. Slingerland, Cornell Experiment Station Bulletin 23, 1890; and M. V. Slingerland and Philena B. Fletcher, Cornell Experiment Station Bulletin 214, 1903. These papers and others deal also with the destructiveness of the insects to apple trees and treat of means for controlling them. The resplendent shield-bearer occurs only occasionally in such numbers as to make it a serious pest, and late summer sprays with arsenicals are usually sufficient to keep the *Bucculatrix* caterpillars in control, though winter washes of lime sulphur or miscible oils are also recommended for killing the hibernating pupæ in their cocoons.

PLATE 1.

The resplendent shield-bearer (*Coptodisca splendoriferella*).

- A. The winter case ($\times 7$) from which the moth has emerged, leaving the pupal skin (*a*) projecting from the door.
- B. Pupa ($\times 7$).
- C. Moth at rest on twig ($\times 7$).
- D. Moth with wings spread ($\times 7$).
- E. Apple leaves containing the larval mines.
- F. Leaf mine broken open, showing the summer larva feeding within between the two surface layers of the leaf ($\times 7$).
- G. Leaves showing perforated mines (*b, b*) from which the caterpillars have cut their cases; *c*, a caterpillar with its case out on the leaf; *d*, another hanging at end of a thread.
- H. Cases attached to the twigs at *e* and *e*.
- I. Caterpillar crawling, carrying its case on its body ($\times 7$).
- J. Case hung up for the winter ($\times 7$).
- K. The prepupal and hibernating stage of the caterpillar ($\times 7$).

PLATE 2.

The ribbed-cocoon-maker of the apple (*Bucculatrix pomifoliella*).

- A. Apple twigs showing *Bucculatrix* cocoons (*a, a*) attached to it.
- B. Pupa ($\times 7$).
- C. Winter cocoon from which the moth (D) has emerged, leaving the pupal skin (*b*) projecting from the opening ($\times 7$).
- D. Moth sitting on a piece of bark ($\times 7$).
- E. Eggs on under side of apple leaf.
- F. An egg near midrib on piece of leaf (greatly magnified).
- G. Upper surface of leaf, showing mines of young caterpillars (*c*) and first molting cocoons (*d*).
- H. Leaf showing feeding areas of caterpillars in subsequent stages.
- I. The mature caterpillar ($\times 7$).
- J. Tip of a leaf ($\times 2\frac{1}{2}$) showing a caterpillar feeding at *e*, and a second molting cocoon at *f*.

PLATE 3.

The ribbed-cocoon-maker.

- A. Caterpillar weaving the carpet for its cocoon, showing the figure-8 loops of the thread ($\times 7$).
- B. Side view of the head and prothorax of a spinning caterpillar, showing the thread issuing from the spinneret (*a*) on the underlip (greatly magnified).
- C. Caterpillar constructing the palisades that will surround the cocoon.
- D. Caterpillar spinning first part of the ribbed cocoon ($\times 7$).
- E. Caterpillar finishing the outer walls of the ribbed cocoon.
- F. Diagrammatic vertical section of the finished cocoon on under side of its support after the caterpillar has changed to a pupa; *b*, the support; *c*, the outer wall of the cocoon; *d*, the inner wall; *e*, the pupal chamber; *f*, the anterior valvelike partitions; *g*, the pupa; *h*, the discarded skin of the caterpillar.
- G. The cocoon opened from above (lettering as on *F*).
- H. The finished cocoon surrounded by its stockade of silk palisades.





THE RESPLENDENT SHIELD-BEARER.

Coptodisca splendoriferella.

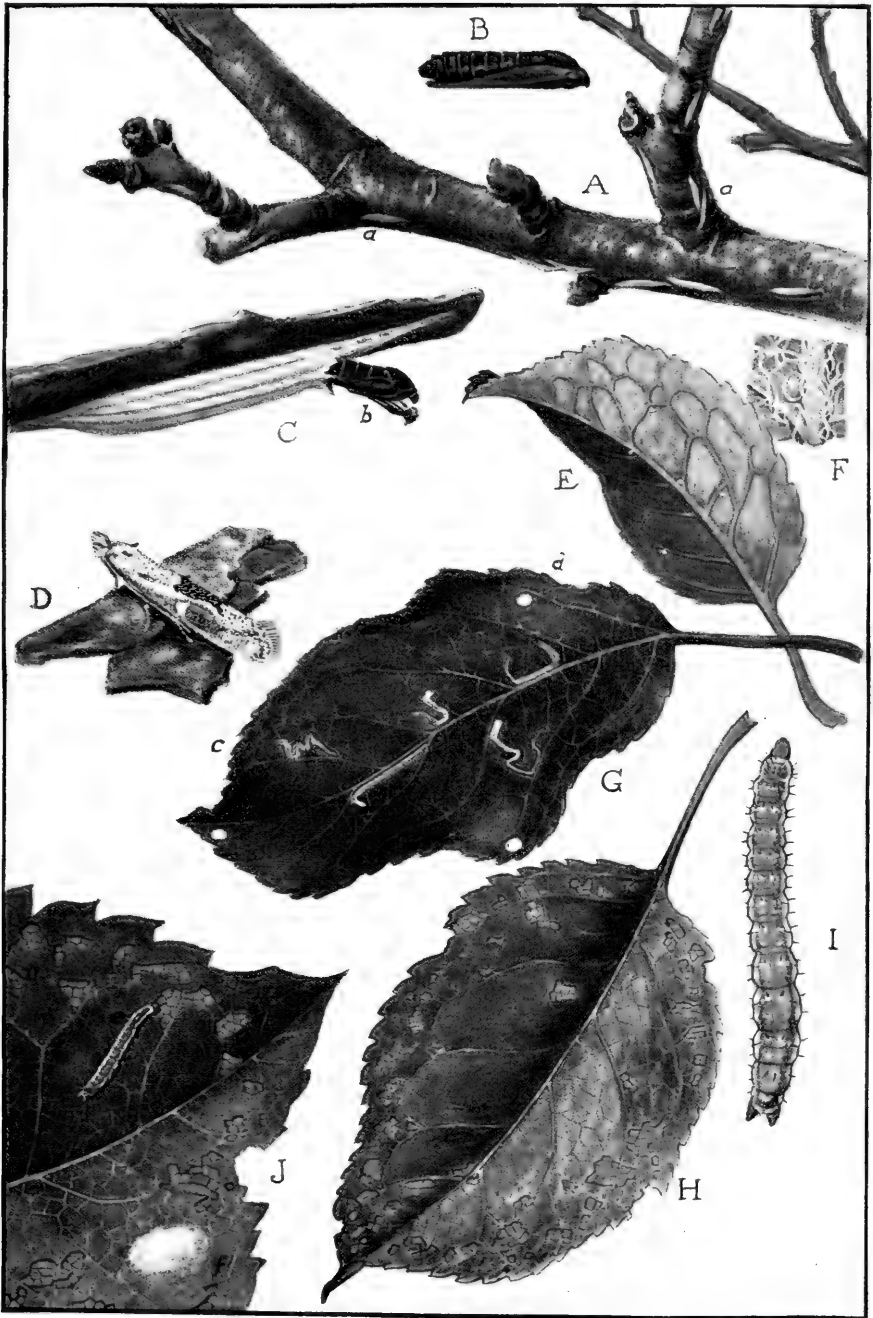

THE RIBBED COCOON-MAKER.

Bucculatrix pomifoliella.



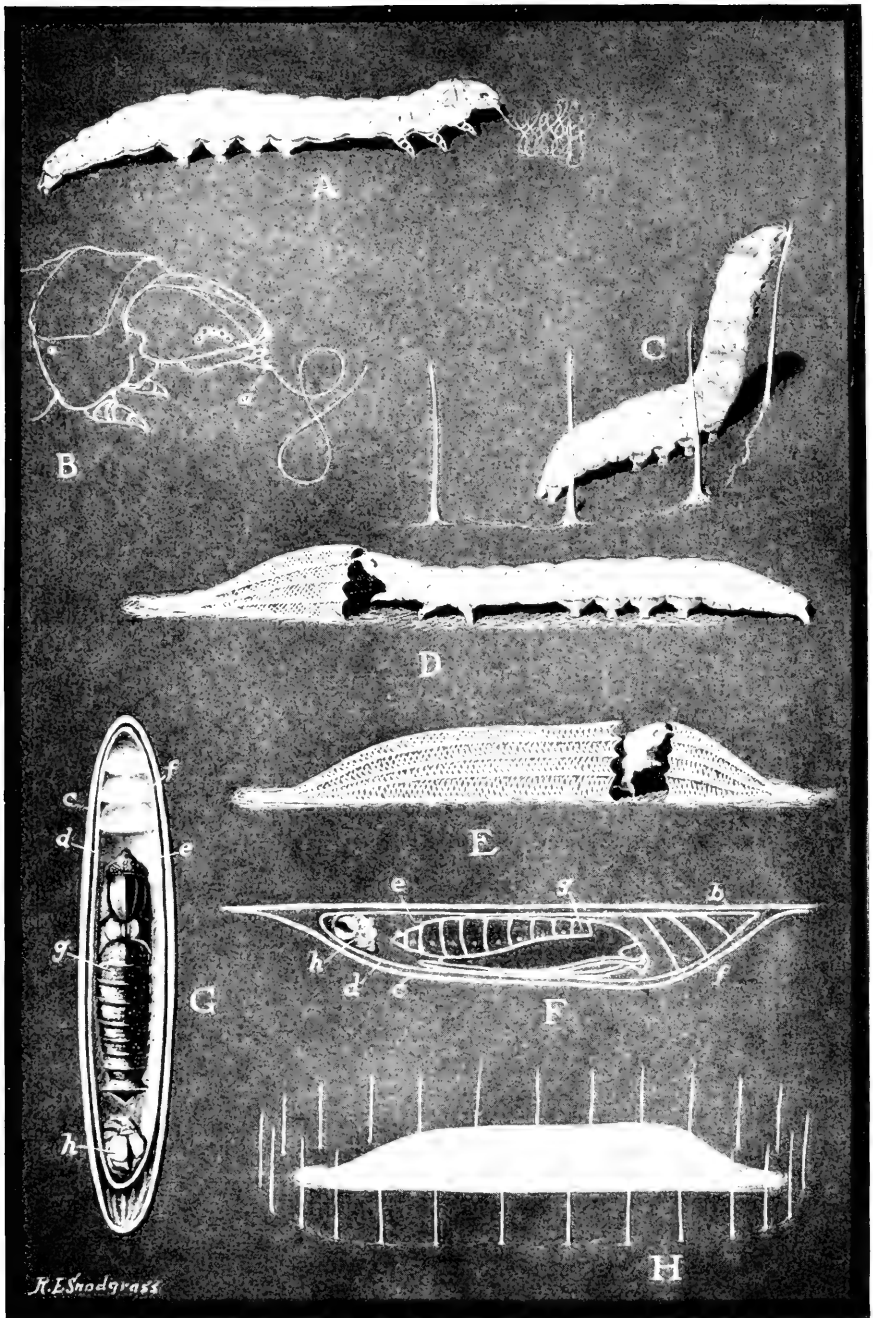

THE RIBBED COCOON MAKER (*BUCCULATRIX POMIFOLIELLA*).



THE ORIGIN OF INSECT SOCIETIES.¹

By AUGUSTE LAMEERE,

*Professor at the University of Brussels, Member of the Royal Academy of
• Belgium.*

I.

We have given in the preceding lectures the essential facts relating to insect societies. We have studied successively the termites, the wasps, the bees, and the ants; we will now take up the complex problem of the origin of phenomena which are among the most instructive in the natural history of organized beings.

From our knowledge of the genealogy of insects we know that the social customs were established independently among the termites, which undergo an incomplete metamorphosis, and among the hymenoptera, insects with a complete metamorphosis; the wasps, bees, and ants did not descend one from the other, and, moreover, many of the wasps and bees are solitary in habit, so that association appeared independently in these three groups also; it is even possible that all social wasps did not come from the same solitary ancestor, and it is almost certain that the humblebees, the melipona, and the bees properly speaking, are related to different solitary bees. The social phenomenon is then polygenic among the insects, although it is relatively rare if we think of the considerable number of groups which do not present it. However, the societies of termites and the various societies of hymenoptera show common characteristics giving them a close resemblance, which leads to the supposition that comparable circumstances were present at their original constitution.

The dominant feature of these societies is the presence of neuters, individuals which, among other peculiarities, present that of having their genital organs atrophied and of being normally sterile. These neuters form an immense majority of the population, a couple among the termites, a single fertilized female among most of the wasps, bees, and ants being the only fertile individuals of the association. Through the existence of the neuters, the society of insects, considered in the ensemble as a superorganism, resembles singularly a multi-

¹ Translated by permission from the *Revue générale des Sciences*, Aug. 15-30, 1915.

cellular organism. A comparison between these two kinds of association suggests itself, and might be fruitful.

To the fertilized egg from which comes the multicellular organism corresponds the creative couple among the termites, and the female, who contains the male in the form of spermatozoa filling her seminal receptacle, among the social hymenoptera. Just as the fertilized egg produces mortal somatocytes and virtually immortal gonocytes, so are born in the insect societies neuters whose biological cycle is interrupted and sexed individuals who are able to repopulate the association. There is this difference: The fertilized egg is divided integrally into blastomeres, leaving no residue, while the founders, or the fertilized female founder, of the insect societies exist beside their immediate descendants. But this difference is not fundamental, for each offspring in a society of insects originates from a particle of the hereditary substance of its parents, just as the cells of a multicellular organism are only a fraction of the initial fertilized egg.

The only important difference is this: The multicellular organism is a concrete association in which the members are bound together by anatomical connections, while the societies of insects are discrete associations formed of anatomically independent elements, being unable to influence each other except through their ethological behavior.

When we studied the origin of multicellular organisms, we recognized that it was brought about by particularly favorable economic conditions, not necessitating the emigration of the cells after their division, and allowing them to exploit a territory in common; to the same cause may be attributed the origin of insect societies: The termites as well as the hymenoptera are nest-building animals, and the nest, abundantly provided with food, constitutes for these organisms a privileged territory where the offspring may live in the midst of the family.

We have previously shown the contrast which exists between the puny multicellular organisms, all of whose cells are equally reproductive, without differentiation, and the powerful multicellular organisms with much more numerous cells, among which there is produced a differentiation into gonocytes and somatocytes, the latter being the humble servants of the former and sooner or later passing into a lifeless condition.

Similarly we know of familylike associations of insects or of spiders in which all the individuals are equal, in which there are no neuters, and these associations are but little developed and ephemeral, for the necessities of the struggle for existence force an emigration of the individuals. It is only in the societies of termites and of hymenoptera that simple families have been able to become permanent populations, thanks to the appearance of innumerable in-

dividuals which do not reproduce and which are sacrificed to the complete life of the fertile individuals. This phenomenon of the limitation of sexual reproduction, a corrective for excessive population, common to perfect multicellular organisms and to the perfected societies of insects, is characteristic of all stable biological associations, for we find it elsewhere in another form. The only mammals which would have been able to originate permanent populations are the ungulates and the primates, polygamous animals which give birth to only one or two young after a long gestation.

Let us add also that to the polymorphism of the somatic cells of the multicellular beings corresponds a polymorphism of the neuters among the social insects, since, at least among the termites and the ants, there are the soldiers, and since the workers of the ants can themselves be differentiated.

The astonishing resemblance which exists between multicellular organisms and societies of termites and hymenoptera causes us to believe that we can reason by analogy in solving the still unsettled problems which bear on both.

II.

Granting this, regarding the problem of the historic origin of insect societies, it will be necessary from the beginning to choose between two opinions.

Herbert Spencer, with whom some biologists are agreed, thought that the societies of insects were due to a gathering of a number of individuals building the same nest in common; there resulted from this an advantage in the struggle for existence, a division of the subsequent work having produced the neuters. The association then came together before becoming a composite family, and consequently in the beginning resembled a myxomycete.

The majority of naturalists are, on the contrary, of an entirely different opinion. They think that the historic determination of the phenomenon was just the same as its present determination. The association was at the outset a family proceeding from a single founder, a couple among the termites, a fertilized female among the hymenoptera. The association was in this respect comparable to a multicellular animal.

The first interpretation has in its favor only very feeble arguments. It encounters, moreover, insurmountable difficulties, of which the principal one is the necessity of admitting that the initial manner of constitution of these associations has been completely modified in the course of time. As a matter of fact, all observations agree in showing us that it is always a couple who found a society of termites, that it is always a fertilized female

who is the origin of the association among the social hymenoptera, as it is always a fertilized female who builds the nest, moreover, among all the solitary hymenoptera, from which the social hymenoptera are descended.

It is true that it has been sometimes stated that hymenoptera have wintered in numbers under the same shelter, that certain solitary wasps have built nests so close to one another that their nests ended in being joined; it is true that nests of *Polistes* and of *Vespa* have been found containing two or more queens, but it was not observed how these nests were originated, and these cases are so rare that we may consider them purely as exceptions. It is true also that H. von Ihering discovered in Brazil that the nests of various social wasps continually contained a certain number of fertilized females, and that R. von Ihering saw that the case was the same for the humblebees in the same region, but the origin of these nests is unknown to us. To pretend with the authors that the "monogamy" of the social hymenoptera of the temperate regions was derived from the "polygamy" of the social hymenoptera of tropical regions under the influence of the lowering of temperature since Tertiary time, the winter causing the death of the neuters and the dispersion of the fertilized females, is to forget two positive facts: First, that there are monogamous societies of hymenoptera in the tropical regions; the polygamous associations might be derived from them through the fact of the climate, the new fertilized females remaining in the association, which is permanent, with the neuters; second, that in the temperate regions there exist societies of wasps which disperse well before the appearance of the first cold weather, the evolution of their nest building being entirely comparable with that of the solitary hymenoptera from which they sprang.

We conclude, then, that the present phenomena of the constitution of insect societies are a reproduction of the phenomena which originally gave them birth, and with this view we shall not have too much difficulty in interpreting the facts.

III.

We shall take up separately the termites and the social hymenoptera. Among the most primitive termites, the nest is hollowed out of rotten wood. It is built by the future royal couple, and after the long betrothal necessary to the ripening of their genital glands, the king and queen are both busy feeding the young. These evolve rapidly into neuters, which are either male or female, and thus is the society constituted. The completely sexed individuals appear much later.

The termites have then for ancestors insects among whom the male as well as the female looks after the offspring, which explains why the male neuters act in the same way as the female neuters in taking the place of the parents in this function.

It is interesting to note that it is among the very insects which attack wood that is most frequently encountered an association of the two sexes for raising the young. This is notably the case with the hymenoptera of the genus *Trypoxylon*, as Fabre has shown, and with the coleoptera of the genus *Passalus*, of which the male and the female eat the wood to nourish their larvae.

Previously we have shown that the termites are merely specialized *Blattidae* dating from the tertiary. Now, there exist to-day in North America cockroaches of the genus *Dasypoma* which live in rotten wood. The females and males are encountered side by side with the young. What more is necessary to arrive at the association of the termites? First, that the individuals of both sexes occupy themselves with raising their offspring and constitute a family, and then that the first young be neuters and proceed to transform the family into a society.

Among the social hymenoptera, all of the ants have social habits, while only the higher of the wasps and bees live in associations. Wasps, bees, and ants belong to the group of hymenoptera known as diggers, so remarkable for their habits, but to different classes of diggers. The society is, however, of the same type in these three categories, and in these different cases the origin may be considered as being identical. Among the fossorial hymenoptera the solitary wasps and bees already possess the nest, the basis of every association, a nest built by a fertilized female and formed of cells which the insect fills with provisions for the future larvae. Her task completed, the mother dies without seeing her offspring. In the social types a fertilized female begins the construction of the nest and nourishes her first larvae, but her work is far from being done, for very soon the larvae become adults, and these adults, small in size, are neuters of the female sex. The neuters, instead of scattering, help their mother and gratify their own maternal instincts, devoting themselves to bringing up the family. More neuters, all females, come to augment these, and it is only later that are born the males and finally the perfect females.

The production of neuters among the hymenoptera has then, as for the termites, transformed a family into a society.

IV.

The phenomenon which dominates the origin of insect societies is the appearance of neuters, and we will examine more closely this

peculiarity. To proceed logically, let us ask first how it comes about that the neuters are exclusively females in the societies of hymenoptera, which are, indeed, essentially feminist societies, while they are of both sexes among the termites, where a male lives with a female. This peculiarity is related to another strange fact which we find among the social hymenoptera—the fact that the male is born from an egg which is not fertilized.

First formulated as an hypothesis by Dzierzon, this parthenogenesis has been demonstrated indirectly by the fact ascertained by Duesberg for the wasps, by Meves for the domestic bee, by Lams for the ants, that in the spermatogenesis of these insects there is no karyogamic reduction. Of the two kinds of spermatozoa which are produced, as among the other animals, one contains no chromosomes and dies while the other includes all the chromosomes of the spermatogonia. The corollary of this is that the nuclei of the male should be haploidic—that is, containing only half the number of chromosomes of the nuclei of the female, the latter being diploidic, as in the other animals. The positive demonstration of this difference is, however, yet to be made. The absence of karyogamic reduction confirms the fact, ascertained among the wasps and bees by von Siebold, that the egg giving birth to a male contains no spermatozoa.

Is this phenomenon peculiar to the societies of hymenoptera? Is it a social peculiarity which could have as a useful consequence an economy of spermatozoa allowing the fertilized female to produce more neuters? It is not probable, for it would presuppose a peculiar polygenism. It is more likely that it already exists among the ancestral solitary forms, and a special study of the spermatogenesis of the diggers should be able to prove it.

It is acknowledged that the seminal receptacle of the fertilized female of the social hymenoptera can be contracted to let out the spermatozoa which it contains. If the organ contracts after the egg laying, a spermatozoa penetrates into the egg and that one produces a female individual; if the receptacle does not contract, the egg remains untouched and produces a male.

M. Paul Marchal has tried to complete this explanation in an ingenious manner. Being granted that the different kinds of eggs succeed each other in a regular manner during the egg laying of the social hymenoptera, that the female first for a long time lays eggs from which come neuters—therefore fertilized eggs, since the neuters are female—then eggs of males, and finally eggs of perfect females, he supposes that a time arrives when the seminal receptacle of the female is fatigued and ceases to function, to take up its activity later.

It is this regular succession in the laying of fertilized and non-fertilized eggs, manifesting itself either during the one-year life

of the female or each year, when, as among the domestic bee and the ants, its existence is much more prolonged, which explains how it comes about that the neuters of the hymenoptera are exclusively females: Under the conditions in which neuters are produced, their mother is in a period when she lays only fertilized eggs.

V.

Let us follow the study of the neuters among all of the social insects. We note that they differ from normal individuals by certain characteristics peculiar to each of the categories to which they belong and by various features which are common to all. Let us examine these.

The neuters are sterile, but this sterility is relative. At birth their genital organs are in general simply arrested in development; it is rarely that they are completely atrophied, as in the ant *Tetramorium caespitum*. This castration is the result of insufficient nourishment in the larval state. It is followed, as M. Paul Marchal has observed, by a nutrimental castration, the neuter passing to the young the greatest part of the nourishment which it can gather, and keeping for itself only a portion too scant to develop its genital organs. M. Paul Marchal has proved that worker wasps, when restrained from their duties as nurse and abundantly nourished, begin to lay eggs. In this way can be explained why the neuters, as well among the wasps as among the bees and the ants, can under special conditions of nourishment be fertile and lay eggs which always produce males, since these neuters never pair. It is also by means of special nourishment that the termites can transform from workers, and even from soldiers, to supplemental kings or queens, not resembling completely, however, the true king or queen, in case of the death of these.

The neuters, as they are, differ further from normal individuals through a partial suppression of their instincts. The desire to mate is absent among them, which is due, no doubt, to the condition of their genital organs. Having no offspring except in exceptional cases, they gratify their instincts as builders and as nurses, which remain intact, to the profit of their brothers, and they do not emigrate, probably in accordance with the law of least effort. They profit from the work begun by their parents or by their mother.

VI.

The morphological characteristics which greatly differentiate the neuters from normal individuals, or the new instincts which the neuters present, are much more difficult to explain. We are confronted by various theories, the biologists having tried to apply to insect societies the explanations which they have adopted to interpret

the differentiation of the somatic cells from the reproductive cells among multicellular organisms.

Herbert Spencer and the Lamarckians, believers in the heredity of acquired characters, not being able to understand, for instance how a termite soldier or an ant soldier being sterile is reproduced in the following generation with a plasticity and with instincts which appear to be neither male nor female, have supposed that the characters peculiar to the neuters are nevertheless transmitted from generation to generation, owing to the fact that some neuters, even soldiers, are sometimes fertile. This opinion should be abandoned, because the reproduction of neuters is exceptional and entirely insufficient, when not lacking entirely. We are, on the contrary, forced to admit that the characters of the neuters are not due to the inheriting of functions, but to the inherent properties of the egg of the species, and this is of great importance. Establishing the comparison with multicellular organisms, we have the right to ask ourselves whether the heredity of acquired characters enters into their evolution, since we must explain without this fact the sometimes considerable state of perfection which the neuters show among the social insects.

The naturalists who do not share the opinion of Herbert Spencer are divided into two camps. Those of the first, with Emery, think that the eggs from which the neuters come do not differ from the eggs from which the fertile individuals are born, but that the germinative plasma of the eggs is labile, producing under the influence of various conditions of nourishment different results; the neuters would be trophogenic.

The others, with Weismann, believe that the eggs giving birth to the neuters contain a germinative plasma distinct from that contained by the eggs from which come the normal individuals, and that external conditions have no influence on the result; the neuter would be blastogenic.

What do the facts tell us? Among the wasp *Polistes gallicus*, among the most primitive of the *Vespa*, and among the humblebees the workers differ from the fertilized female only in size; as the year advances, as the society increases in number, as the conditions of nourishment become more favorable, neuters are born whose size is more and more developed, and there is scarcely any hiatus between the smallest neuters which appear first and the perfect females. Both represent the extreme fluctuations of the same type, between which exist all transitions. With M. Paul Marchal we can believe that it is the variable quantity of nourishment which determines these differences, and in consequence that this category of neuters is trophogenic.

With M. Paul Marchal we can also believe that among the higher types, as a result of a social perfection which accentuates the differ-

ence in conditions under which are produced the workers and the perfect females and which removes the conditions under which these last are produced further from those vested in the presocial ancestor, there will be established a wider and wider divergence of characters between the neuters and the queens.

The case of the domestic bee is extremely suggestive. Here the queen is profoundly different from the workers; these have preserved nearly all the characters of a female of solitary hymenoptera, while having acquired several new instincts. The queen, on the contrary, has departed from the ancestral beaten track; she has lost the pollen-collecting organs, as well as her nursing instincts; her wings are shortened, her sting modified; on the other hand, her genital organs are enormously developed through an extraordinary increase in the number of egg-bearing sheaths, and she is ready to lay eggs a few days after birth. These differences are no longer those of two extreme fluctuations, but rather those of true mutations; they are, however, of trophogenic origin, nourishment entering into the question here not only as to quantity, but also as to quality. We know, in fact, since the discovery of Schiraz, that the workers can create a queen from a young worker larva which they bring up as a queen larva. Instead of leaving it in a narrow cell and feeding it with a coarse paste, they build for it a large cell, which they fill with the royal jelly, produced from the secretion of their digestive tubes.

These facts evidently arguing against the opinion of Weismann, we are tempted to extend, with Emery, to the neuters of the ants and also of the termites the ideas which the wasps and the bees teach us. Let us see if this is possible.

VII.

Among the ants, as among the termites, it is the normally fertile individuals which, contrary to what is shown by the domestic bee, have preserved the characters of the presocial ancestor, while the neuters have advanced in evolution. The neuters are notably always without wings, and they are especially characterized by a great development of the head, to the detriment of the abdomen. This feature is connected with the power of the jaws, and it goes on increasing with the size, for the workers among the ants and the soldiers among the termites can be divided according to this feature into several categories. The soldiers of the termites constitute a caste entirely distinct from that of the workers, and often very different from the parents, while among the ants the neuters having a maximum size are called soldiers.

Now Professor Bugnion, of Lausanne, has made an important discovery regarding a termite of Ceylon. The soldier of *Eutermes*

lascustris as it comes from the egg already shows the frontal horn, at the extremity of which opens the orifice of the enormous cephalic gland which enables it in the adult state to cover an enemy with a repugnant liquid. If the sterility of the soldier is of a trophogenic order, as is most probable, since the soldiers of the termites can sometimes become fertile, its very unique characters, entirely absent among its progenitors and among the workers, are of a blastogenic order. We are here in the presence of a phenomenon comparable to that which is shown by those *Papilio* which bear in the same egg laying two or three kinds of females, or else simply something analogous to sexual dimorphism. Is there, as for the male and the female, a difference in the chromosome content of the nucleus which characterizes the egg from which the soldier comes? We do not know yet, but in that case it is Weismann who would be right.

Is it necessary to conclude from this that, as for the soldier of the termites, if the sterility of the workers of the termites or of the neuters of the ants in general is of a trophogenic nature, their morphological peculiarities are blastogenic? We do not think so.

The workers of the termites differ much less from the normal individuals than the soldiers, and as for the ants it can be said that their neuters are not more differentiated from the female than is the worker bee from the queen. Weismann has, moreover, made an observation of great value to the point of view which we take. The ant hills of *Formica sanguinea* are frequently infested by coleoptera of the family of Staphylinides, *Lomechusa strumosa*. These are parasites which the ants take care of and of which they even bring up the larvae. The *Lomechusa* have hairs on which is spread a secretion on which the ants dote and which intoxicates them. When these parasites become very numerous the ant hill falls into decay, the ants concerning themselves more with their guests than with the individuals of their own species. It is established, then, that the larvae which ought to give birth to winged females, being poorly cared for, produce only "pseudogynes," degenerate wingless females offering transitional characters which approach those of the workers. It is the counterpart of the transformation of a worker into a queen among the bees!

We arrive, then, at this probability: That, except in the special case of the soldiers of the termites, which are in some way grafted on to the general phenomenon, the neuters of the social insects are of trophogenic origin. Was it not the same in the beginning for the somatic cells of multicellular organisms?

As a result, the historic determination of the appearance of the neuters, original cause of the transformation of a family into a society, cause of the existence of insect societies, is an insufficient

nourishment of the larvae by their parents. The initial couple among the termites, the nest-building fertilized female among the hymenoptera, would not have been able to furnish their young with the food necessary to the development of their genital organs. This misfortune would have been able to entail the extinction of the species had not the social life come to save it.

Insect societies are anomalies if this term is applied to every phenomenon deviating notably from that which is usual in nature. The neuters are extraordinary beings capable of maintaining their existence, being useful through their behavior. They bear witness to the triumph of life through death. The multicellular organisms owe their power to the death of the somatic cells; in the same way the exuberance of the insect societies results from the death of innumerable neuters, sacrificed to certain privileged individuals, in the interest of the race.

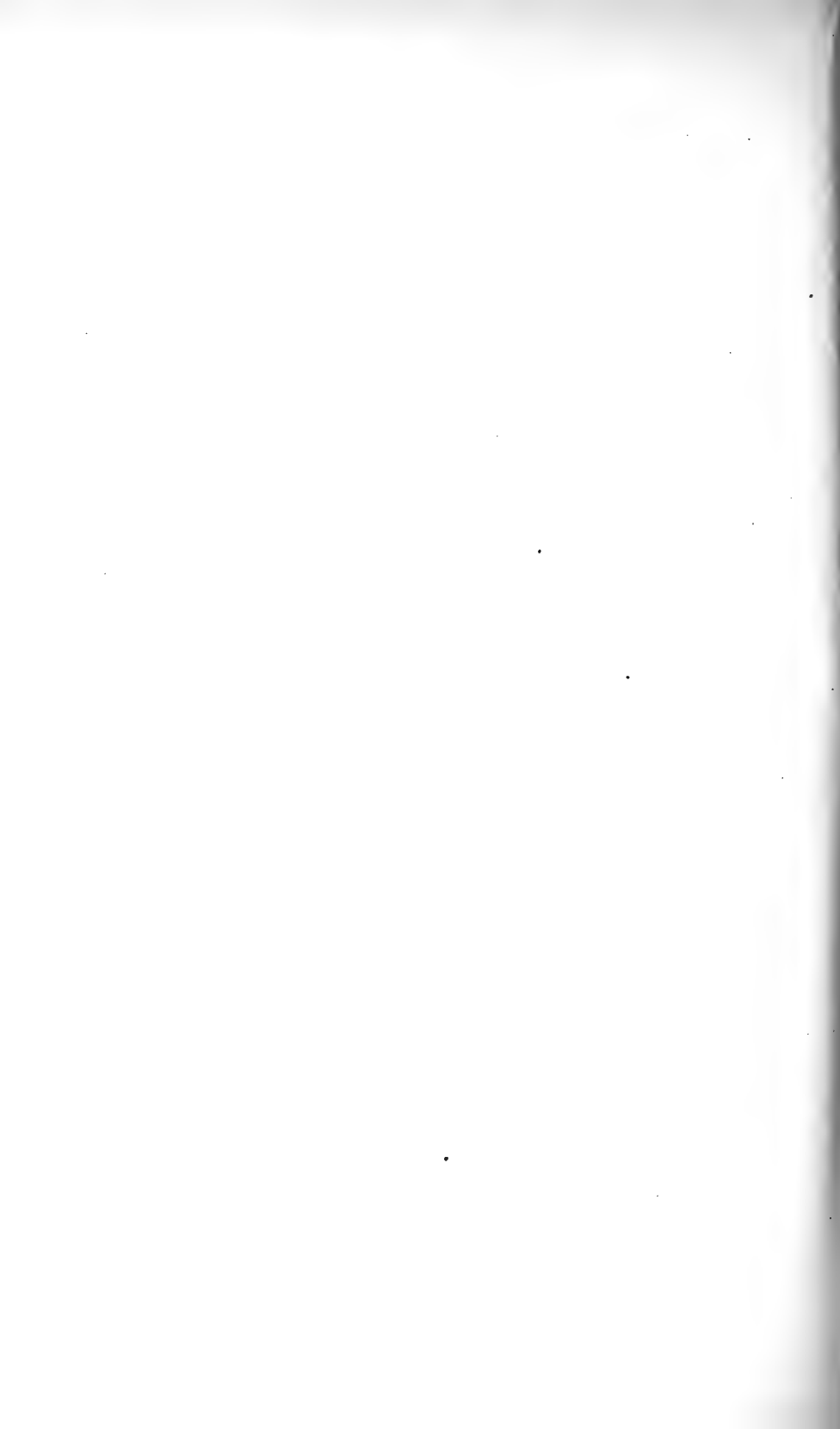

THE BOTANICAL GARDENS OF JAMAICA.

By WILLIAM R. MAXON.

[With 20 plates.]

To many Americans who have enjoyed their first acquaintance with the Tropics through a voyage to Jamaica, that island, picturesque in its unfamiliar and exceedingly luxuriant vegetation, has itself seemed like a huge botanical garden. The feeling is especially strong if the visitor has been fortunate enough to journey out of the beaten path of the tourist, back among the heavily forested Blue Mountains, which almost everywhere are visible from the lowlands in the eastern half of the island. There he will have found fulfilled every inviting promise of coolness, damp dense shade, and sheer tropical luxuriance of the "school geography" kind: the forests filled to overflowing with a bewildering profusion of ferns and clambering vines; the larger trees studded with orchids and bright bromeliads, or so smothered in hanging mosses and liverworts that their very individuality of trunk and branch is lost; and the damp forest borders no less completely green, the precipitous banks—for all Jamaica is rocky—covered with a dense mosaic of herbaceous flowering plants and of ferns in almost infinite variety and abundance.

The multitude of ferns alone will convey the impression of a botanical garden upon a stupendous scale. Of these there are not far short of 500 species in the island, 50 of which are tree ferns (Cyatheaceae), several commonly attaining a height of 40 feet or more. Tree ferns are commonest in the higher mountains, although one of the most abundant and beautiful of all (*Cyathea arborea*) is found mainly at low elevations, for example at Bog Walk and in the gullies near Port Antonio, where it has been seen and admired by thousands of American tourists.

But whether in the mountains or in the lowlands, and quite aside from the unusual character of the vegetation, there are various other features—the smooth, white limestone roads, the brilliant sunshine, the songs of strange birds, the volubility and general good nature of the blacks, and, above all, the delightfully equable climate—which

together will give the northern visitor at first a detached, exotic feeling, as of mere existence in a curious, new, and infinitely surprising out of doors. With most of us there will cling to first impressions of luxuriant tropical life a kind of glamour that lessens little in retrospect.

In the midst of the most charming and favorable surroundings the colonial government of Jamaica has established several public gardens, which not only have value as places of recreation, but serve also very diverse purposes of scientific and economic usefulness. The history of their beginnings and growth is not uninteresting, especially since for a century and a half the Government has rather consistently followed a broad policy of official support in these undertakings.

EARLY EFFORTS.

The first botanical garden in Jamaica was established nearly 150 years ago by Mr. Hinton East as a private enterprise upon his estate near the present village of Gordontown, about 9 miles from Kingston. This attempt must have been successful, for we find a committee of the legislature in 1774, under the inspiration of the governor, Sir Basil Keith, recommending the appropriation of £700 for the purchase by the Government of land suitable for a botanical garden and of £300 for the annual salary of a botanist. Accordingly, in the following year an estate named Enfield, adjacent to Mr. East's garden, was purchased by the Government and placed under the charge of Dr. Thomas Clarke, who came out from England to assume the new position of island botanist. Clarke seems to have entered upon his new duties with much enthusiasm, introducing during the next few years such useful tropical plants as the camphor tree (*Cinnanomum camphora*), the Chinese tea plant (*Thea sinensis*), the litchi (*Nephelium litchi*), the sago "palm" (*Cycas circinalis*), the clove tree (*Eugenia caryophyllata*), and the akee (*Blighia sapida*). The last-mentioned tree is to-day common in many parts of the island. Its beauty consists not only in its rich glossy foliage but in the strongly contrasting, large, scarlet fruits, which, splitting down the side, show each three large, shining, deep black seeds upon a background of fleshy white pulp which partially surrounds them; this is known as "akee," and when cooked is a favorite dish of the inhabitants, both whites and blacks. Its consumption is attended with risk, unless well-ripened fruits are used.

BATH GARDEN.

Some dissatisfaction being expressed as to the suitability of Enfield as a site for a permanent garden, an act was passed in 1778 for the purchase of a small tract of land bordering the historic little

village of Bath, lying in the eastern end of the island, 44 miles east of Kingston and distant 6 miles from the Caribbean. Accordingly, Bath Garden was founded the next year and placed under Clarke's care. Many introductions of foreign plants now followed rapidly. One lot was received in a most unusual way, namely, by capture. It is a matter of history that in 1782 a French ship, bound from Mauritius to Haiti, having been taken by the English under Rodney and sent to Jamaica as a prize, its cargo was found upon examination to include a considerable shipment of economic plants. These were all planted out in Mr. East's garden. Among them were cinnamon, jackfruit (*Artocarpus integrifolia*), and mangoes—the last two not previously imported into Jamaica. The story runs—apparently without contradiction—that in the lack of a descriptive invoice the new plants were known for a time only by the serial numbers with which they had been tagged, and that in this way the "No. 11" mango, since so well known, received its name.

In 1793 Captain Bligh, H. M. S. *Providence*, brought several hundred plants of the breadfruit (*Artocarpus incisa*) from Tahiti, and many other valuable tropical plants as well. These were distributed among the planters, besides being planted at Bath Garden and in the garden of Mr. East, the latter known commonly as the Liguanea Garden from its location at the northern edge of the dry Liguanea Plains, where these border the southern foothills of the Blue Mountains. Either from plants of this shipment or of the earlier ones the mango spread rapidly, foreshadowing its present development as the most characteristic tree of cultivated areas at lower and middle elevations.

As to the further history of the Liguanea Garden it may be noted that this property was purchased by the Government upon the death of Mr. East in 1790, only to be disposed of again in 1810 to private owners.

Clarke was followed as island botanist successively by Dancer (1797), MacFadyen (1825), and Higson (1828). Of these MacFadyen is best known, principally from his critical studies of the native Jamaican flora. Among other accessions of this time was a collection of living plants brought from South America by Higson and planted in Bath Garden, which by the addition of a few acres in 1829 was more than doubled.

In 1846 Nathaniel Wilson, who had been in the Kew Gardens for several years, was appointed island botanist and curator of the Bath Garden. Under his capable management a very large number of additional plants were imported. He gave special attention to the formation of an extensive collection of fiber-producing plants, the cultivation of which he foresaw as promising a wonderful future to Jamaica, but secured also such introductions as the mangosteen

(*Garcinia mangostana*), durian (*Durio zibethinus*), and litchi, these easily ranking to-day as among the most delicious of all tropical fruits. The introduction of the high-climbing Brazilian Bougainvillea, conspicuous for its great clusters of crimson-bracted flowers, and the flamboyant (*Delonix regia*), of Madagascar, also dates from his incumbency, besides that of many less known but conspicuous trees and shrubs. The flamboyant with its huge masses of brilliant scarlet and orange flowers and its wide-spreading limbs, nearly bare of leaves at flowering time, is now one of the common trees about Kingston and in other parts of the lowlands. It was Wilson also who successfully introduced *Amherstia nobilis*, of India, well known as the most gorgeously beautiful of all large-flowered trees.

During this period the Bath Garden appears to have been subject to frequent inundation by the Sulphur River, and this fact, together with the difficulty of further extending its boundaries to accommodate new plants, led eventually (in 1860) to the beginning of a new garden in the interior of the island at Castleton. From this time on the Bath Garden, despite its location in an extraordinarily fertile region of heavy rainfall and rich alluvial soil, was allowed to diminish steadily in importance and, unfortunately, in extent, until at the present time it covers hardly more than an acre. Very recently nursery work has been revived at this old garden, and it is now used as a center for the propagation of cacao. As a small arboretum Bath is still of value, moreover, since it includes mature individuals of many interesting trees, among which may be mentioned the durian, the huge talipot palm (*Corypha umbraculifera*) of Ceylon and southern India, the deadly upas tree (*Antiaris toxicaria*) of Indomalaya, the Andaman redwood (*Pterocarpus indicus*), the rattan palm (*Calamus rotang*), and the nickel tree (*Ormosia jamaicensis*), the last recently described as new. Wilson, while in charge of the Bath Garden, lived near by at Mansfield, an estate lying at about 1,000 feet elevation at the southern end of the almost unexplored John Crow Mountains, and made an extensive collection of native plants, particularly of ferns.

CASTLETON GARDEN.

The actual establishment of Castleton Garden under the direction of Wilson followed closely upon the selection of the site, in 1860-62, and the development of this wonderful collection of exotic plants, mainly trees, from all parts of the Tropics, has since progressed steadily. Castleton, which is ideally suited to its purpose, may be described briefly as an exceedingly humid interior valley of about 30 acres at low elevation (about 580 feet above sea level), closely shut in upon three sides by steep hills. It has an annual rainfall of 120

inches and an annual mean temperature of 76°. Across the island at this point runs a good road, leading from Annatto Bay on the north coast to Kingston on the south. Castleton lies 11 miles from the former place, 19 from the latter. Approaching from either direction the drive is through a most beautiful and picturesque country, much of it under cultivation.

No description or series of photographs can do justice to Castleton; it is a place which must be seen to be put at its proper value. The ground is somewhat broken, the declivities such as readily to permit the natural grouping and arrangement of plants according to their affinities or special requirements of habitat; and so completely is the planting in harmony with the terrain and with the beautiful surroundings that there is no suggestion of a heterogeneous assemblage of exotics brought to exhibition from the four corners of the world. Nevertheless, in these 30 acres more kinds of East Indian trees have been introduced and grown to maturity than in any other American garden.

The importation of plants for Castleton was at first not rapid; but after a few years it was determined that the distance of the garden from Kingston offered no serious obstacle to its development, and in 1869 no less than 400 species of plants, either new to the island or otherwise interesting or valuable, were introduced from the Royal Botanic Gardens, Kew, then under the direction of the late Sir Joseph Hooker. Among these were the Brazil nut (*Bertholletia excelsa*), teak (*Tectona grandis*)—one of the hardest and most durable of all shipbuilding woods—the Tonquin bean (*Dipteryx odorata*), additional plants of the mangosteen, several varieties of cacao, the ceriman (*Monstera deliciosa*), and over 30 species of exotic palms. During the same year two lots of grafted mangoes were received from India. In 1870 upward of 200 additional species new to Jamaica were introduced, and in addition selected varieties of oranges, pineapples, grafted mangoes, and other fruits. The nutmeg trees, introduced earlier, had already come into bearing. At this time, as in later years, the objects sought, though primarily economic, were recognized as being closely dependent upon precise knowledge to be obtained from an adequate botanical establishment, and to this broad view is due very largely the enviable agricultural and horticultural success subsequently attained.

To the botanist no less than the casual visitor the single feature of greatest moment will be the wonderful collection of palms, to the number of nearly 200 species, grouped or scattered over the gentle slopes. Some of these deserve special mention, as the betel nut (*Areca catechu*), the ivory nut palms (*Phytelephas* spp.), the Malayan sugar palm (*Arenga saccharifera*), the tucum palm of Brazil (*Astrocaryum vulgare*), the cohune of Central America (*Attalea*

cohune), the wine palm of Ceylon and India (*Caryota urens*), the wax palm of Brazil (*Copernicia cerifera*), the African oil palm (*Elaeis guineensis*), a huge fan palm from Australia (*Livistona australis*), the Cuban royal palm (*Roystonea regia*), the raphia palm (*Raphia ruffia*), several allies of the coconut palm (*Cocos* spp.), and the palmetto (*Sabal palmetto*) of our own Southern States, concerning each of which interesting chapters, if not books, might be written.

Of the more interesting trees aside from the palms may be mentioned the Brazil nut, of the Amazon region, its hard globular fruit shells 5 or 6 inches thick, each containing about 20 nuts fitted mosaic-like within; the so-called "cannon-ball" tree of tropical America (*Couroupita guianensis*), related to the Brazil nut; various rubber-producing trees of the genera *Hevea* and *Castilla*; the litchi nut, previously mentioned; the cinnamon tree (*Cinnamomum zeylanicum*), native in Ceylon; the camphor tree (*Cinnamomum camphora*), of eastern Asia, one of the sources of commercial camphor; the Chile pine or "monkey puzzle" (*Araucaria imbricata*), from the mountains of southern Chile; the kola nut tree (*Cola acuminata*), of western tropical Africa, the nuts well known for their stimulant and nutritive properties; the clove (*Eugenia caryophyllata*), of the East Indies; the native manchineel, a peculiar euphorbiaceous tree (*Hippomane mancinella*), celebrated for its poisonous fruit and juice; the traveler's tree (*Ravenala madagascariensis*), related to the common banana; and the nutmeg (*Myristica fragrans*), of tropical Asia. The most strikingly beautiful tree of all is the *Amherstia* (*A. nobilis*), previously mentioned. A fine specimen of this stands just within the entrance to the garden, its pendent racemes of huge vermilion flowers a fitting augury of the many beauties of the garden. Not far above are pools containing numerous waterlilies (*Castalia* spp.) and, finest of all, the remarkable *Victoria regia*, of the Amazon region, continuously in cultivation here since 1870.

The development of Castleton Garden over a period of 60 years has progressed steadily, notwithstanding the attention given to two other main enterprises, namely, the establishment of a botanical station in the mountains (the so-called Hill Gardens, at Cinchona) and the development of a garden at Hope, in the dry lowlands, where extensive experimental work on economic plants is carried on to better advantage than is feasible at Castleton.

THE "HILL GARDENS"—CINCHONA.

Castleton Garden was scarcely under way before the project of establishing the Hill Gardens took form, principally as the result of a plan to foster the production of "Peruvian bark" or cinchona

as a staple crop in the Blue Mountain region. Seeds of three species of cinchona (*C. succirubra*, *C. nitida*, and *C. micrantha*) had been received from Kew by Wilson in 1861 and plants raised from these set out at various points in the mountains. This preliminary planting resulted so favorably that in 1868 a tract of approximately 600 acres, located upon the moist upper slopes of the Blue Mountains, at 4,000 to 6,000 feet, 16 to 20 miles northeast of Kingston, was set aside and partially planted to cinchona. At various later times additional neighboring territory was acquired for this and other experimental purposes until the initial tract was greatly extended. Owing to the unforeseen and disastrous competition of the East Indies, however, the quinine industry was never a great success in Jamaica, although the growth and yield of the trees fully justified the expectation of those who had initiated the enterprise.

Besides efforts directed to the cultivation of cinchona, attention was given to the introduction and selection of various vegetables—such as peas, carrots, potatoes, cabbage, tomatoes, cucumbers, and beets—suited to temperate tropical regions, and of various fodder and fiber-yielding plants, as well as fruit trees of temperate climates. The idea of a garden in the cool moist hill country for the propagation of European vegetables had, indeed, been conceived as early as 1774, by Sir Basil Keith. The project as finally achieved a century later proved successful in many ways, and the Hill Gardens, or "Cinchona," as the place came to be generally called, became and for many years remained the headquarters of the Department of Public Gardens and Plantations, from which work in other parts of the island was directed. Excellent administrative and residential bungalow quarters (Bellevue House) had been established on an outlying southern spur at 5,000 feet elevation, commanding an almost unobstructed view in three directions and somewhat protected on the north by Sir John's Peak, John Crow Peak, and the lofty connecting ridges which here form the backbone of the Blue Mountains. These were carefully maintained also during a later period, after agricultural and horticultural activities had been centered at Hope Gardens. In 1903, following the virtual abandonment of active work at Cinchona, the buildings and about 10 acres of adjacent land were rented to the New York Botanical Garden, which with the enthusiastic approbation of a large number of botanists of both this country and Europe at once carried out a plan, long cherished, of establishing a botanical laboratory in some accessible part of tropical North America. The arrangement then begun continued for 10 years, during which period many important studies, mainly systematic and physiological, upon the flora of the region were carried on. Since 1913 the property has been leased for one year by the British

Association for the Advancement of Science and for three years by the Smithsonian Institution, the latter acting on behalf of 12 American universities and individual botanists.

The situation and surroundings of Cinchona are ideal, both for residence and for purposes of study. The cleared lands immediately surrounding the buildings are very beautiful. They embrace a wide sweep of close-cropped lawn, extending from the terraced banks and formal gardens which surround the residence, conservatories, and laboratories, far down the slopes to the south, these bordered by extensive ornamental plantings of native and exotic shrubs, trees, and tree ferns. Experimental plots and gardens are at either side, partly screened by luxuriant hedges. Excellent trails lead in all directions, notably one of 3 miles, almost on a level, to Morce's Gap, along which over 100 species of ferns occur. Just below Morce's Gap lies the deep "hothouse" valley of Mabess River, an intensely humid locality in the midst of unbroken primeval forest. The peaks previously mentioned may all be ascended by trails. They are heavily forested and the trees support a typically luxuriant rain-forest epiphytic growth.

The average annual rainfall for Cinchona (covering a period of 39 years) is 105.7 inches; the lowest recorded annual fall is 59.46 inches in 1897, the highest 178.77 inches in 1909. The monthly mean maximum temperature is invariably below 72°, so that, with the fresh east and northeast breezes which prevail, enervating hot weather is never experienced. "Hot waves" are unknown. The nights are cool, or often cold (absolute monthly minima 46° to 54°). Kingston and historic Fort Royal, basking in plain view a mile beneath, in the glaring coastal region to the south, seem half a continent distant, rather than a short 16 miles by trail.

It would, indeed, be hard to conceive of facilities better suited to general botanical laboratory investigations in tropical North America. Additional opportunities are afforded by the herbarium and laboratory at Hope Gardens and by the living collections at both Hope and Castleton, which make possible the comparative study of a wonderfully wide range of plants from many distant tropical and warm temperate regions.

HOPE GARDENS.

In 1873, only a few years after the beginning of the Hill Gardens at Cinchona, the Colonial Government obtained possession of about 200 acres of land in the Liguanea Plain about 6 miles northeast of Kingston, adjacent to the Hope Reservoirs, which supply the city with water taken from the Hope River below Gordontown, and established here a small nursery and experimental station, the beginning of the present Hope Gardens. The accessibility of Hope

to Kingston led eventually to its development in part as a pleasure garden for the inhabitants of that city, but a more immediate cause of its establishment was the need of a drier locality than Castleton for the propagation and experimental study of many plants of economic importance to the island, particularly sugar cane, of which upward of 60 varieties had been received from Mauritius and Martinique in 1872 and 1873. During the two following years the cane varieties were all removed from Castleton to Hope and planted in plots totaling 5 acres; 10 acres was planted to teak. Gradually during the next few years, and coincidentally with the development of Hope as a pleasure garden, the more utilitarian phases of purely tropical agricultural work were transferred from Castleton, and all similar activities were at length (1879) combined under a department of public gardens and plantations, with Doctor (later Sir) Daniel Morris in charge. Morris, upon his appointment as assistant director at Kew in 1886, was succeeded by Hon. William Fawcett, under whose direction, and with the able assistance of the late William Harris, subsequently superintendent of public gardens, the possibilities of Hope were brought to full realization. Within recent years Hope Gardens and agricultural experimental station, and the other botanical gardens in the island, have been placed under a newly organized department of agriculture, Hon. H. H. Cousins, director.

The influence of Hope Gardens and of the work there directed has been pronounced, and effective over a much wider area than contained within the narrow limits of Jamaica. Experimental work on tropical crop plants has consistently remained the leading feature, and experimental grounds and nurseries very naturally occupy the greater part of the Gardens. Here may be seen extensive plantings of sugar cane in many varieties, coffee, numerous varieties of banana and cacao, kola, mangoes, pineapples ("pines") of many varieties, ginger, rubber-yielding trees, oranges and other citrus fruits, spice plants of several kinds, tobacco, vanilla, cassava (*Manihot utilissima*), plantations of forage and fiber plants, and, perhaps as interesting as any to the tourist, the ippipalm (*Carludovica*), the source of so large a percentage of the cheaper "Panama" hats.

From the nurseries are supplied, at a merely nominal price, many thousands of young plants annually to the inhabitants, who otherwise could secure no such service, since there are no private nurseries in the island. The plants are grown and readily distributed in small pots made by cutting the hollow stems of the common cultivated bamboo (*Bambusa vulgaris*), 3 or 4 inches thick, into sections of appropriate length, the solid partition at the joints forming the bottom of the pots. In the same way very large numbers of herbaceous

and shrubby ornamental plants are distributed annually all over the island, by steamer and railroad. The half shrubby "crotons" (*Codiaeum*), conspicuous for their brilliantly colored and variegated leaves, are easily the favorites, and monstrous and unnatural as their garish coloration might seem in the cloud-drenched mountains, they are fairly in keeping with the scorching glare of the lowlands, where they prosper amazingly. The plazas and small parks and the formal gardens which front most of the inclosed villas, both city and suburban, would indeed be dull without them.

Hope Gardens are easily reached by a modern and well-equipped electric street car line which runs out from Kingston (at sea level) northeasterly over the dry dusty plain, past Halfway Tree (famous for its huge "Tom Cringle" silk-cotton tree) to Papine, less than a mile beyond the main entrance to the Gardens. So gentle is the rise that the altitude reached (700 feet), though not great, seems hardly credible. The ride has been through an area supporting a strongly xerophilous vegetation, of which more than half of the conspicuous scattered trees, including the mesquite (*Prosopis juliflora*) and the East Indian "woman tongue" (*Albizia lebbek*) are of foreign introduction. Of the native trees one of the most beautiful, with clean firm trunk, dense well-rounded crown of small, dark, glossy leaves, and beautiful clusters of lilac flowers, is the lignumvitae (*Guaiacum officinale*). Several terrestrial cacti of the genera *Cereus* and *Opuntia*, which were abundant toward Kingston, are here less common, but in the huge, flat-topped guango or "rain tree" (*Pithecolobium saman*), widely introduced throughout the tropics, will often be found a climbing cactus (*Hylocereus triangularis*), sometimes in its profuse growth completely taking possession of the trunk and main branches. The general character of the vegetation is not prepossessing, for although the annual mean temperature here is 76° there is a total rainfall of only 55 inches per year, and the immediate landscape is usually parched in appearance. The high Blue Mountains to the north drain the saturated northeast trade winds, and the breezes from the south bring little moisture.

The transition to the beautiful planting within the gardens is, therefore, abrupt. Two hundred acres are included in the tract, the inner portion being laid out as a botanical garden and experimental station. Leaving the main highway to Papine and Gordontown, over which trudge daily hundreds of Negro market women bearing heavy head loads of produce raised 10, 15, or even 20 miles away in the mountains, the driveway within the gardens leads for some distance through a rather dense ornamental plantation of shrubs, native and exotic, with clumps of many different kinds of cacti interspersed. Emerging from this the full beauty of the gardens comes upon one: The wide expanse of well-kept lawns, the

driveways bordered with thriving exotic palms of varied habit and foliage, shrubs massed in profusion along the borders of the grounds as far as the eye can distinguish and forming arbors over many of the walks, and a wonderful display of trees of many kinds growing singly or in groups, brought together from all the tropics. The luxuriance and perfection of growth is owing largely to irrigation from the Hope Reservoirs. There are ferneries, both open and under glass, orchid houses, propagating houses, and, above all, a wonderful double row of divi-divi trees (*Caesalpinia coriaria*) beneath which is an almost unrivaled collection of living epiphytic orchids, assembled through years of exchange. One of the most interesting trees is the native lacebark (*Lagetta lintearia*), confined to Jamaica, whose inner bark, beaten out into a strong and beautiful lace-like cloth and made up into various ornaments, is thoroughly familiar to the tourist.

At one end of the gardens is located the director's residence, and near the middle the administration building, a two-story structure which contains the offices, library, and herbarium. The herbarium is nearly complete in its representation of the native Jamaican ferns and flowering plants, the collection and study of which have always received special attention.

From an old "sugar estate" Hope has developed into an establishment of first importance, known the world over. Its influence in the island has already been mentioned. There remains to acknowledge with gratitude the courtesies which have invariably been extended to American visitors in increasing numbers for 20 years past, both tourists and special investigators of the flora or economic products of the island.

OTHER GARDENS.

Besides the gardens already described there are two which require brief mention. The first is the Kingston Victoria Park, sometimes known as the Parade Garden, situated in the heart of populous Kingston, the seat of government and now as for centuries past the principal port of the island. It is 60 feet above sea level and embraces 7 acres planted to flowering shade trees and palms, with borders of ornamental shrubs and herbaceous flowering plants. It is lighted by electric light in the evenings, and affords a fine recreation ground for the inhabitants of Kingston. The annual mean temperature here is 79°, and the average annual rainfall is slightly less than 32 inches.

King's House garden and grounds comprise the inclosed tract of ground surrounding King's House, the official residence of the governor of Jamaica, 4 miles from Kingston on the road to Hope, at an elevation of 400 feet. The mean temperature here is about that of

Kingston, but the precipitation is greater, amounting to 47.5 inches annually. The grounds contain 177 acres, of which about 30 is maintained as an ornamental garden attached to the residence. The approach is by an avenue lined with stately royal palms (*Roystonea*) and trees of the willow fig (*Ficus benjamina*), with borders of massed ornamental shrubs and creepers in noteworthy display. In the garden proper, adjoining the house, are ferns and many rare tropical palms and orchids. Numerous tropical fruit trees and economic plants are under cultivation, and here also are many tropical water lilies and the surpassing *Victoria regia* of South America.

An attempt has been made not only to indicate in a general way the main interesting features of the several botanical gardens of Jamaica and their diversity in so far as climate, composition, and usefulness are concerned, but also to show how consistent has been their support and development over a long period of years, how constantly the agricultural needs of the inhabitants have been kept in mind, and how for nearly 150 years this effort has been dictated by considerations of singular breadth and of understanding as to the fundamental part that purely botanical investigations must necessarily play in the welfare of the people and their struggle toward material prosperity.

It was in 1797 that Dr. Thomas Dancer, elected "physician of the bath of St. Thomas the Apostle" 15 years earlier, was appointed "island botanist." His duties were defined as follows:

To collect, class, and describe the native plants of the island; to use his endeavors to find out their medicinal virtues; to discover if they possess any qualities useful to the arts; and annually to furnish the House with a correct list of such plants as are in the botanic gardens, together with such information as he may have acquired relative to their uses and virtues.

The objects here sought, through systematic botany, were primarily medical, but the spirit which prompted this legislation has been widely reflected in the support since given to botanical and agricultural projects. This attitude as to the proven value of tropical botanical gardens is admirably expressed in a report of Mr. William Fawcett, director of public gardens and plantations, in 1892, when in commenting upon the work of the gardens department and its chief aims and possibilities, and particularly of the need of intelligent self-help and cooperation, he wrote:

The increase in the variety of cultural products and the humanizing influence of ornamental plants are matters of appreciation in every part of the country from mountain to seacoast. Every person who obtains plants and grows them, from the sugar planter who makes trial of different varieties of cane to the small settler who grows a nutmeg plant, is making experiments which are of direct benefit to himself and indirectly to his neighbors and to the district.

It is scarcely necessary to say anything in Jamaica about the importance generally of botanic gardens, for the need for them has been continuously recognized here for more than 100 years. The value of those existing in Jamaica, Trinidad, and Demerara is so evident that lately botanic gardens have been started in Antigua, Dominica, Montserrat, and St. Kitts Nevis, among the Leeward Islands; in Grenada, St. Lucia, and St. Vincent,¹ among the Windward Islands; and still more recently in British Honduras.

Botanic gardens in the Tropics do the work, on the plant side, of agricultural departments in temperate climates. They are in themselves experimental stations and are much more efficient in introducing new cultural products, and in distributing plants and imparting useful information, than most agricultural departments.

The tropical botanical gardens established by the British throughout their colonies are in close relation to each other, both directly and through Kew, to which they look for assistance and advice. They are "not isolated, but are branches of an agricultural department as wide as the British Empire itself." Their benefit to the Empire and its dependent peoples and to the world at large has been, literally, incalculable. Knowing this to be true, and realizing however imperfectly the enormous amount of exploratory and cultural work still to be done in furthering the production of tropical foods and raw economic materials of many kinds upon which the civilized world is increasingly dependent, may we not hope that the first activities of the newly organized Institute for Research in Tropical America will be directed toward the establishment of adequate botanical gardens in all the possessions of the United States within the Tropics?

Photographs shown in plates 12 and 13 were courteously contributed by the New York Botanical Garden; the others, with a single exception, were made by Mr. G. N. Collins, of the Bureau of Plant Industry, United States Department of Agriculture.

¹ A revival of a botanic garden established in 1765.

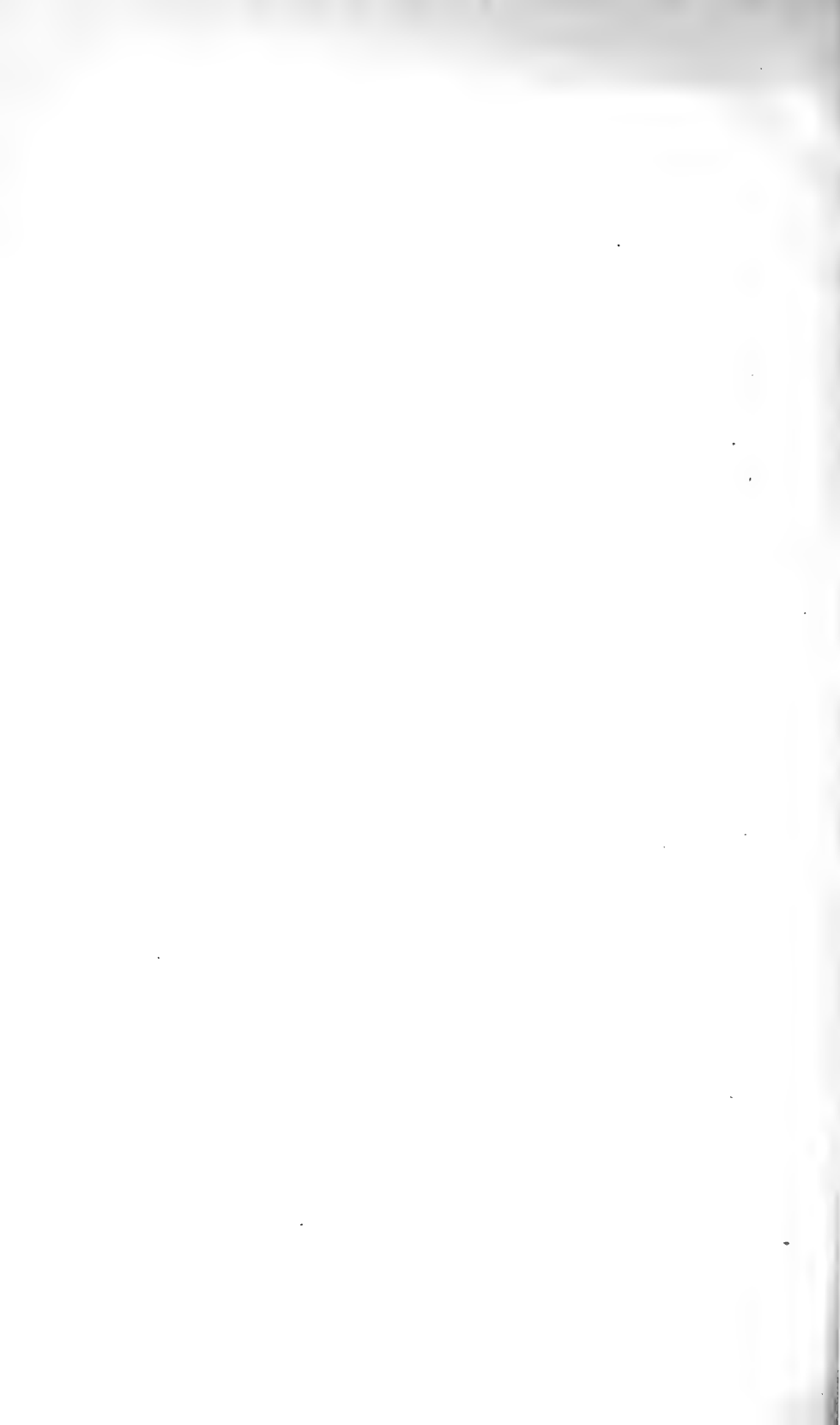



EPIPHYTES IN THE LOWER MOUNTAIN REGION.

A forest tree supporting a characteristic growth of bromeliads and several species of ferns (*Polypodium*).



THE GRU-GRU PALM (*ACROCOMIA FUSIFORMIS*).

This native species is common at low elevations. The spindle-shaped trunk is thickly beset with needle-like spines.



VIEW ACROSS HOPE RIVER, JUST BELOW GORDONTOWN.

The first botanical garden (Mr. East's) was located near this point. The palms are coconuts and the broad-leaved trees are breadfruit.

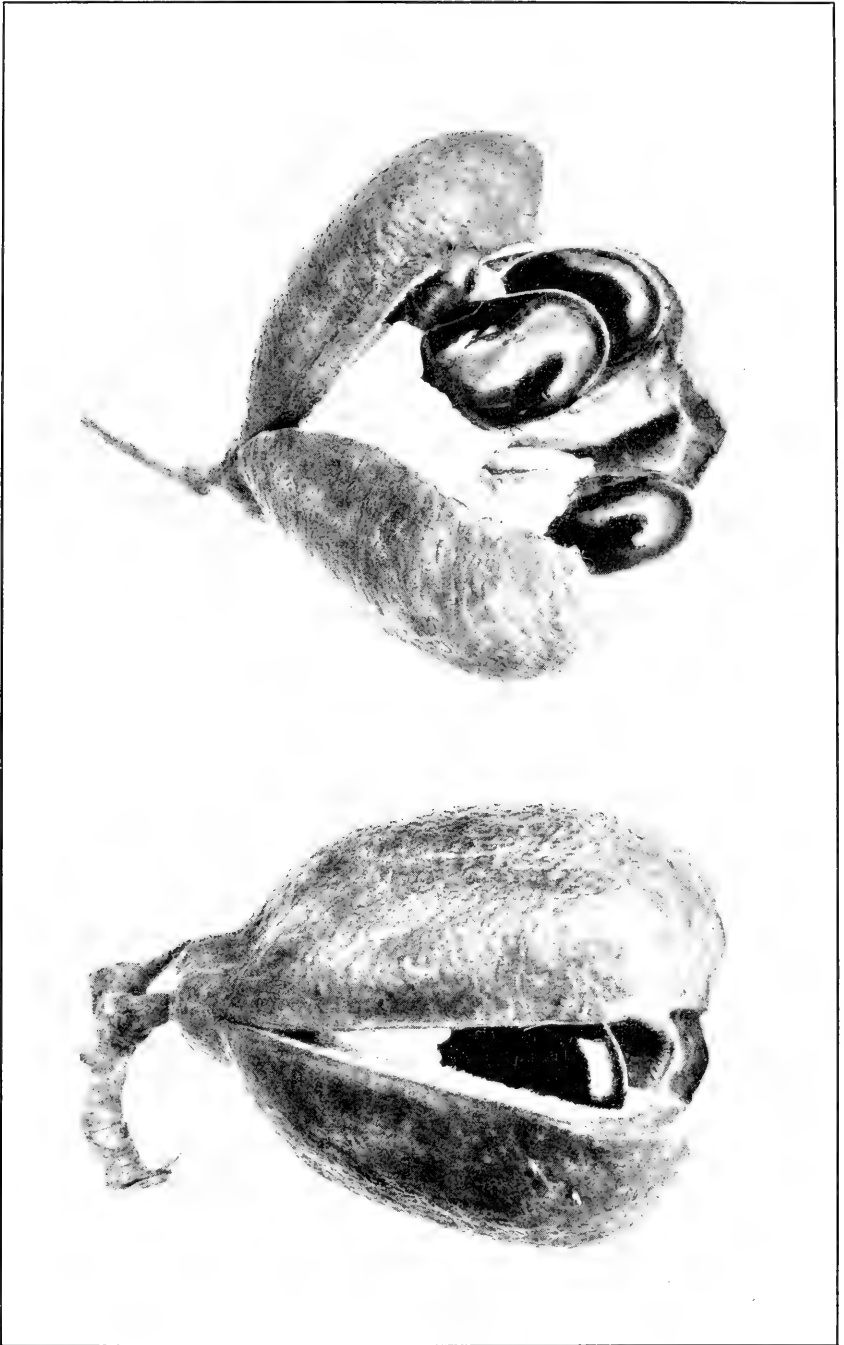

FRUITS OF THE AKEE (*BLIGHIA SAPIDA*), A FAVORITE FOOD OF THE JAMAICAN BLACKS.



FOLIAGE AND FRUIT OF THE NUTMEG (*MYRISTICA FRAGRANS*).

A nut, removed from its thick fleshy two-valved husk, is shown below; the netlike seedcoat, or arilode, closely enveloping it is the mace of commerce.



VIEW IN CASTLETON GARDENS.

A few of the many species of palms are here shown. A feathery clump of bamboo is seen in the middle-ground, beyond the water lily pool.



VIEW IN CASTLETON GARDENS.

A sago "palm" (*Cycas circinnalis*), with true palms of several genera in the background.

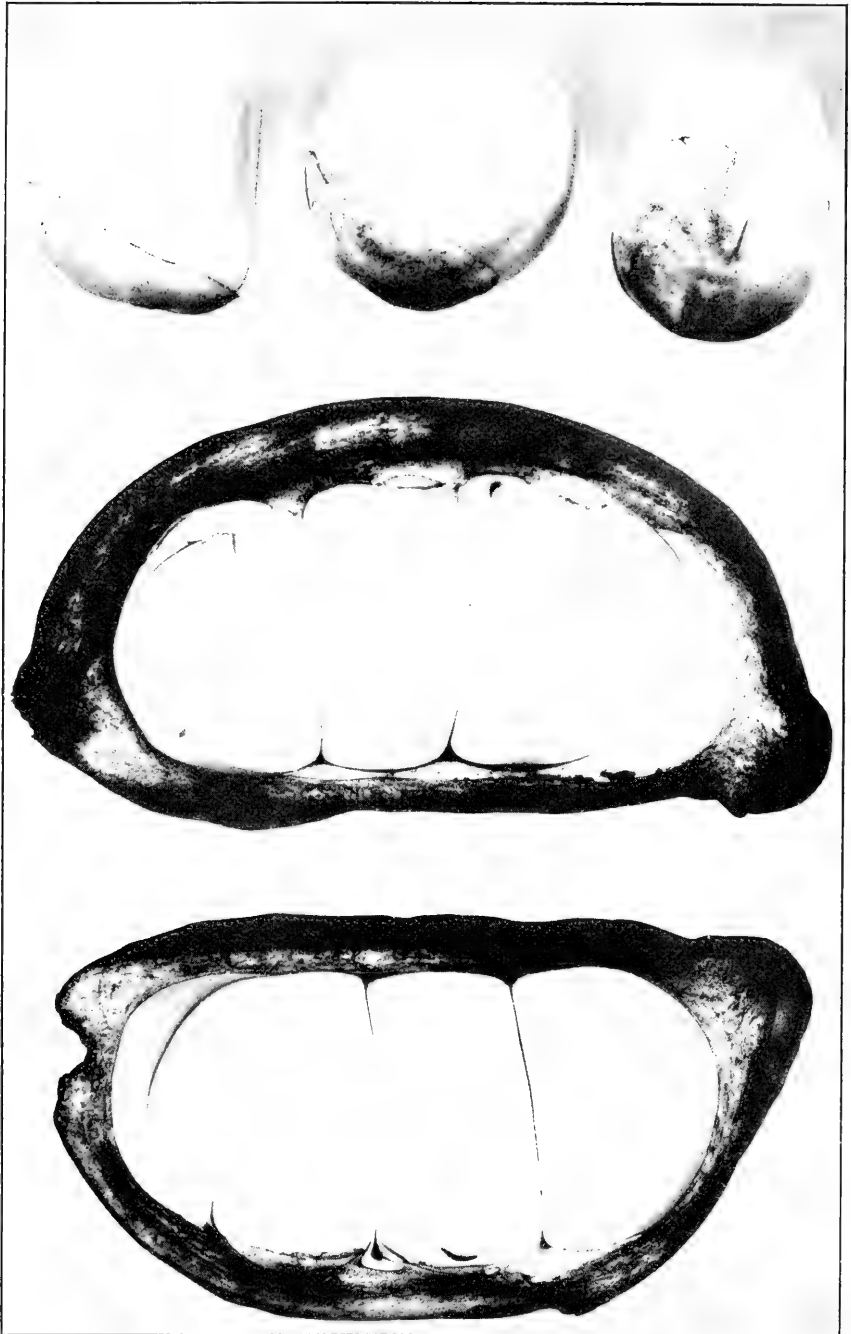

FRUIT AND SEEDS OF THE KOLA (*COLA ACUMINATA*).

This African tree, of the family Sterculiaceae, is widely cultivated in tropical America. The nuts serve many medicinal uses. (Natural size.)



FLOWERING BRANCH OF ALLSPICE OR "PIMENTO" (*PIMENTA OFFICINALIS*).

An aromatic myrtaceous tree, native to Jamaica. Harvesting and marketing the berries is an important industry. (Natural size.)



TROPICAL WATER LILIES (*CASTALIA* SP.), IN CULTIVATION AT CASTLETON AND HOPE.

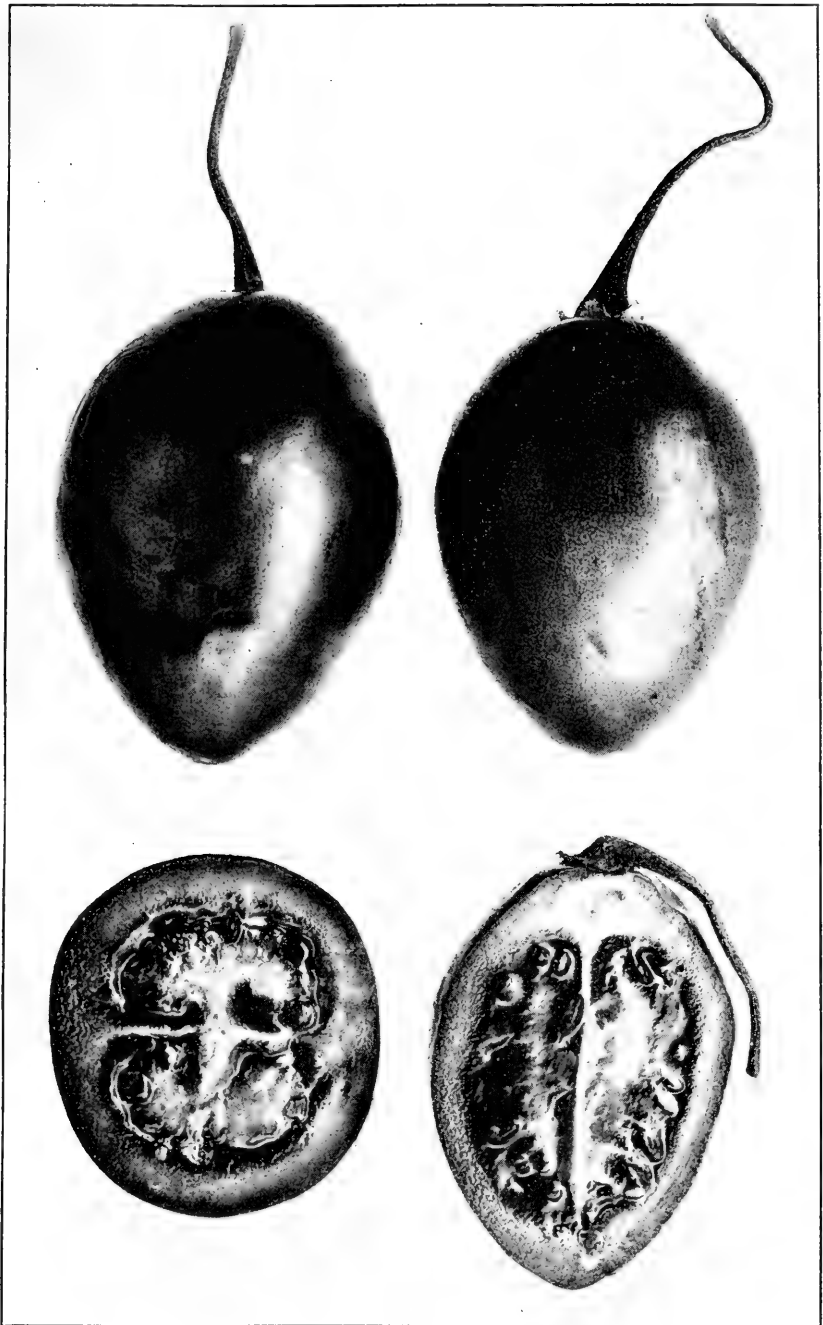

THE "TREE TOMATO" (*CYPHOMANDRA BETACEA*).

This delicious fruit, grown in the Blue Mountain region near Cinchona, is occasionally ripened under glass in the United States. (Natural size.)

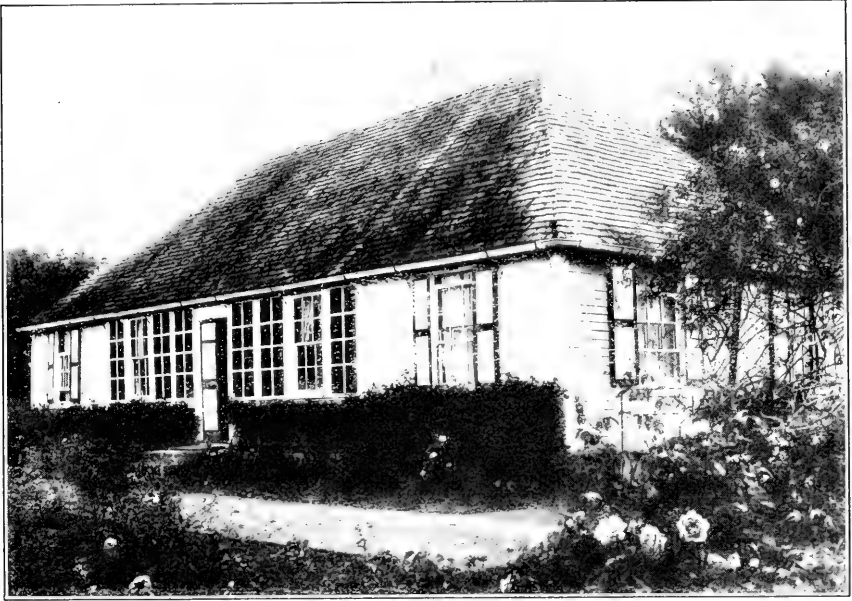

A. "BELLEVUE HOUSE," THE BUNGALOW RESIDENCE AT CINCHONA.

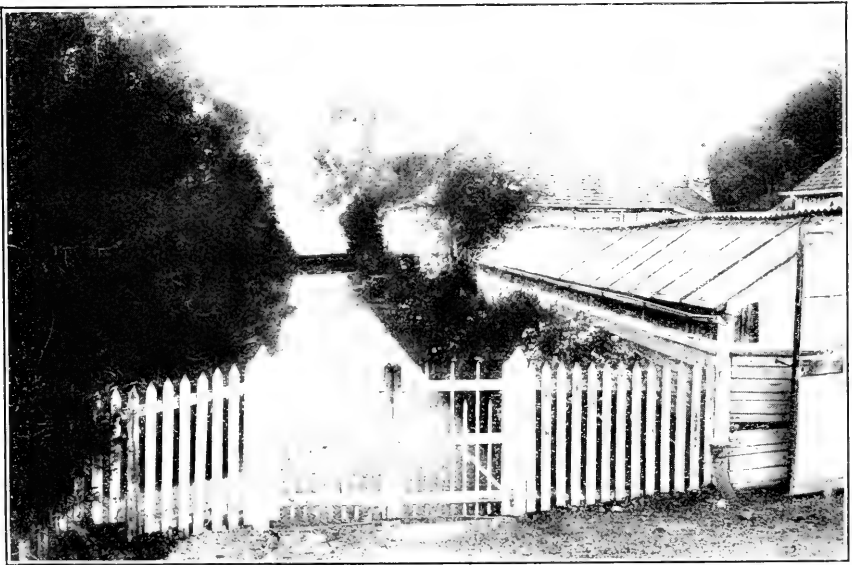

B. GREENHOUSE AND BORDER, ADJACENT TO THE RESIDENCE AT CINCHONA.



A. A CORNER OF THE LAWN AT CINCHONA, WITH PLANTINGS IN NATIVE AND EXOTIC PLANTS.



B. A FERN-BORDERED PATH AT CINCHONA. THE FERNS (PLANTED) ARE MAINLY *ALSOPHILA QUADRIPINNATA*.



THE SILK-COTTON TREE (*CEIBA PENTANDRA*).

A very large well-known individual at "Halfway Tree," between Hope Gardens and Kingston, said to be the one described in "Tom Cringle's Log."

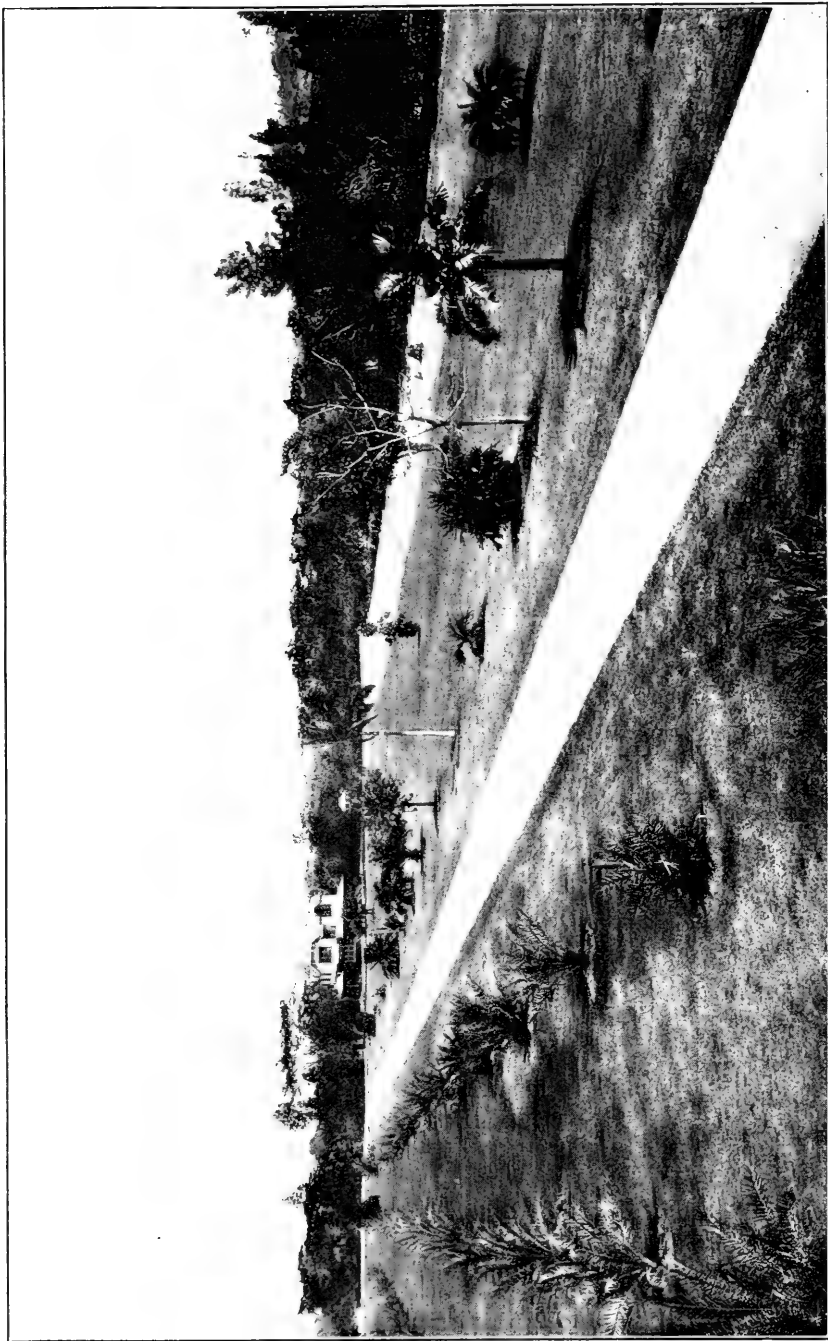

VIEW IN HOPE GARDENS (1904), THE DIRECTOR'S RESIDENCE IN THE DISTANCE.

Many of the young palms here shown have now grown to a considerable size.



A FIJI PALM (*PRITCHARDIA THURSTONI*) GROWING IN HOPE GARDENS.



A MADAGASCAR PALM (*CHRYSALIDOCARPUS LUTESCENS*), GROWING IN HOPE GARDENS.



A VANILLA PLANT (*VANILLA PLANIFOLIA*), GROWING ON DIVI-DIVI TREES IN HOPE GARDENS.

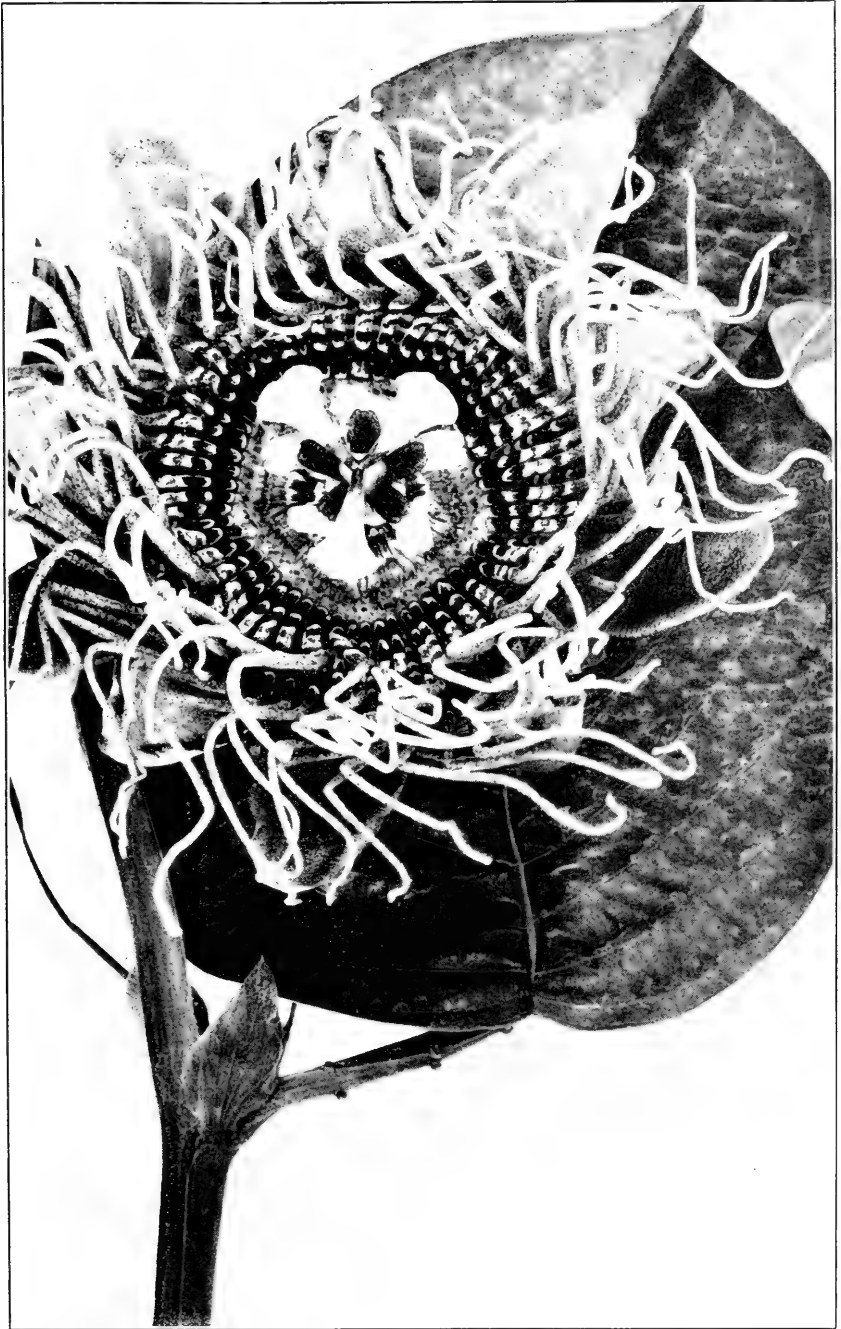

FLOWERING BRANCH OF A GRANADILLA (*PASSIFLORA MACROCARPA*).

A native of South America, cultivated at Hope Gardens. The huge fruit is much esteemed. (Natural size.)



A. LOGWOOD (*HAEMATOXYLON CAMPECHIANUM*).

This important economic tree, presumably introduced from the mainland, is now abundant at low altitudes in Jamaica.

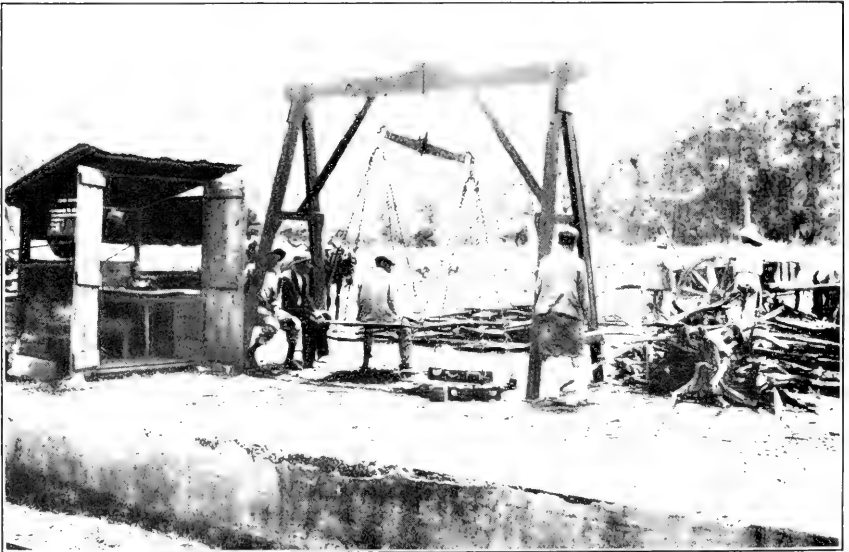

B. LOGWOOD AT RAILWAY STATION, READY FOR WEIGHING.

The well-known dye, haematoxylin, is contained in the heartwood.

DATURAS OF THE OLD WORLD AND NEW: AN ACCOUNT OF THEIR NARCOTIC PROPERTIES AND THEIR USE IN ORACULAR AND INITIATORY CEREMONIES.

By WILLIAM E. SAFFORD.

[With 13 plates.]

During the recent war, when the United States was cut off from the sources of supply of many important drugs, it was found that an excellent substitute for atropine, a product of the European *Atropa belladonna*, could be obtained from our common Jamestown weed and other closely allied plants belonging to the same genus, *Datura*.¹

A critical study of this genus has revealed great confusion in botanical literature as to the specific identity and origin of some of the most common species. Certain authors have confused a well-known plant, endemic in Mexico and northern South America, with the Asiatic *Datura metel*, a species based by Linnæus on the *jouzmathel*, or metel-nut of the Arabs and the dhatura, or dutra, of the Hindoos. Other authors attribute the origin of the purely American *Datura stramonium* to the Old World and separate its purple variety from its typical white-flowered form as a distinct species; still others segregate the tree daturas of South America as a separate genus.

This paper is part of a thesis submitted by the writer for the degree of Doctor of Philosophy at George Washington University. The remaining part, entitled *Synopsis of the Genus Datura*, was published in the Journal of the Washington Academy of Sciences, vol. 11, pp. 173-189, April 19, 1921. Its object is to clear up the existing confusion and to call attention to the remarkable properties of the various species of this genus, and also to give an account of their use, both in the Old World and the New, as intoxicants and ceremonial plants used for oracular divination.

¹These plants owe their virtues to certain alkaloids, principally hyoscyamine and scopalamine, contained chiefly in the petioles, midribs, and secondary nerves of the leaves; also in the pistils of the flowers and the germs of the mature seeds. See E. Schmidt, "Ueber die Alkaloide einiger mydriatischwirkender Solanaceen," in Arch. d. Pharm., 243; 303. 1905.

THE USE OF NARCOTIC PLANTS AMONG THE ANCIENTS.

The history of narcotic plants goes back to remote antiquity. The Pythian priestesses of Delphos prophesied while under their influence. The lovely Helen, as related in the *Odyssey*, to make Telemachus forget his sorrows, held to his lips a cup of wine into which she had secretly put the soothing nepenthe. Diodorus of Sicily, in his account of the narcotics of Egypt, tells of a plant used by the women of Diospolis for dispelling anger and grief. Early Sanscrit and Chinese writings tell of a magic plant used as a hypnotic, or narcotic, in all probability identical with the metel-nut, or dhatura, which Christoval Acosta, in his account of the drugs of the East Indies, says was so skillfully dispensed that adepts were able to gauge doses, the effects of which were to last for as many hours as it was wished to render the subject unconscious.

That Shakespeare was familiar with narcotic plants of this kind is indicated in several of his plays. The gentle Juliet, when in her distress she seeks the holy friar, skilled in physic, receives from him a potion with these directions:

Take thou this phial, being then in bed,
 And this distilled liquor drink thou off;
 When presently through all thy veins shall run
 A cold and drowsy humor, which shall seize
 Each vital spirit; for no pulse shall keep
 His natural progress, but surcease to beat;
 No warmth, no breath, shall testify thou livst;
 The roses in thy lips and cheeks shall fade
 To paly ashes, thy eyes' windows fall,
 Like death, when he shuts up the day of life;
 Each part deprived of supple government,
 Shall stiff and stark and cold, appear like death:
 And in this borrow'd likeness of shrunk death
 Thou shalt continue two-and-forty-hours,
 And then awake as from a pleasant sleep.²

That Shakespeare was familiar with the mandrake, or mandragora, whose shrieks when uprooted were declared by early herbalists to cause madness, is indicated by Juliet's reply:

How if, when I am laid into the tomb,
 I wake before the time that Romeo
 Come to redeem me? There's a fearful point!

* * * * *

Alack, alack! is it not like that I,
 So early waking, what with loathsome smells,
 And shrieks like mandrakes torn out of the earth,
 That living mortals, hearing them, run mad—
 O, if I wake, shall I not be distraught,
 Environed with all these hideous fears?³

² *Romco and Juliet*, act 4, scene 1.

³ *Ibid.*, act 4, scene 3.

After having instilled suspicion into the mind of Othello he makes Iago exclaim :

Look, where he comes! Not poppy, nor mandragora,
Nor all the drowsy sirups of the world,
Shall ever medicine thee to that sweet sleep which thou ow'dst yesterday.⁴

Cleopatra, bereft of her Antony, begs Charmian for a potion of mandragora, that she might sleep out the great gap of time when he was away from her.⁵

Again, he refers to mandragora in the second part of Henry VI, when in reply to the Queen's taunt: "Hast thou not spirit to curse thine enemies?" Suffolk replies:

A plague upon them! wherefore should I curse them?
Would curses kill, as doth the mandrake's groan,
I would invent as bitter-searching terms,
As curst, as harsh and horrible to hear.⁶

NARCOTIC SOLANACEAE.

The Solanum family, to which the genus *Datura* belongs, includes a great number of plants remarkable for their narcotic properties, among them the mandrake (*Mandragora*), belladonna (*Atropa*), henbane (*Hyoscyamus*), and *Scopolia* of the Old World, and tobacco (*Nicotiana*) of the New. Strange to say, it also includes several important food plants, such as the egg plant, tomato, and potato.

In the Old World the most famous of all was the mandrake, *Mandragora officinalis*, so frequently mentioned by Shakespeare. During the Middle Ages this plant was much used in amorous incantations. Its forked root, which by a little contrivance is easily made to assume the human form, helped to endow the plant with magical properties. According to early herbalists it would shriek aloud when torn from the ground, and so dangerous was it that those who ventured to gather it had to stop their ears to guard against deafness or even death. One of the Greek writers published an illustration representing the custom of using a dog in gathering it. The earth having been carefully dug from around the plant, a dog is tied to the stalk. In attempting to run away the dog pulls up the plant and is represented as writhing in the agonies of death. Among the famous Old World plants are the deadly nightshade, *Atropa belladonna*, the principal source of atropine; the henbanes, or "insane roots," *Hyoscyamus niger* and *Hyoscyamus muticus*; and the metel-nut, or nux-methel, belonging to the genus *Datura*. In the New World there are a number of species belonging to this genus, some of which, as stated above, have been confused with Old World species.

⁴ Othello, act 3, scene 3.

⁵ Antony and Cleopatra, act 1, scene 3.

⁶ Henry VI, second part, act 3, scene 2. See also Bulleine's Bulwarke of Defense against Sickness, p. 41, 1579.

HISTORY OF THE GENUS DATURA.

The earliest account of a plant of this genus is that of the learned Arab Avicenna, who in the eleventh century described a certain fruit under the name *jouz-mathel*, or metel nut, and mentioned it among the drugs of the Arabic pharmacopaea (pl. 1). Avicenna's account was translated by Dioscorides, and this so-called nut was recognized by Matthioli and other early botanists as the fruit of a narcotic solanaceous plant, which was described two centuries later by Linnæus under the name *Datura metel*.

Christoval Acosta, in his *Tractado de las Drogas y Medicinas de las Indias Orientales* (1578), gives an account of it under the name *Datura*, stating that in the East Indies it was much used as an aphrodisiac. Its trumpet-shaped flowers he compares to those of a *Convolvulus* in form and its seeds in size to lentils. Among the Hindu *enamoradas*, he says, few are without *Datura* seeds among their most highly prized treasures. They were ground to a powder and administered in wine or some other medium, and

he who partakes of it is deprived of his reason (*queda enagenada*), for a long time laughing or weeping or sleeping, with various effects, and oftentimes talking and replying; so that at times he appears to be in his right mind, but really being out of it and not knowing the person to whom he is speaking nor remembering what has happened after his alienation has passed. Many mundane ladies are such mistresses and adepts in the use of this seed that they give it in doses corresponding to as many hours as they wish their poor victim to be unconscious or transported. And, truly, if I were to tell stories of what I have heard or seen relating to this matter and the different ways I have seen people act when under the influence of the drug I would fill many sheets of paper, but as this is not necessary I will refrain. I will only say that I have never seen anyone die from its effects, but I have seen some who have gone about for several days perturbed, and this must have been because it had been given to them in too large doses, which, if too great, will cause death, because this seed contains venomous parts, although the Gentiles administer it as a diuretic with pepper and betel leaves and say it is efficacious, but this I have not seen nor tried, having other medicines more safe for the purpose.¹

The high esteem with which this plant was regarded by the ancient Chinese is indicated by Li Shi-Chen, in his celebrated work on the *Materia Medica of China*, *Peu ts'ao kang mu*, published in 1590. According to this author the Chinese name of this plant, *man t'o lo hua* (probably derived from the Sanscrit) is taken from a famous Buddhist sutra, "Fa hua ching," in which it is declared that when Buddha preaches a sermon the heavens bedew the petals of this plant with rain drops; and, according to a more ancient tradition of the Taoists, the name of the plant is that of one of the circumpolar stars, and every envoy sent down from this star to the earth is supposed to

¹ Acosta, Christoval, *Tractado de las Drogas y medicinas de las Indias Orientales*, p. 88, 1578.

carry in his hand one of its flowers; so that the Chinese came to call the flower by the name of the star. Li Shi-Chen gives a pretty good description of the plant, which he says has leaves resembling those of an egg plant, flowers with a white hexagonal corolla, blooming in the eighth month (September), and round prickly fruits; but this description is corrected by a Japanese botanist, Ono Ranzan, who says that the flower is normally pentagonal instead of hexagonal; and this correction is sustained by Siinuma Yokusai, another authority on old Japanese botany, who gives a very good illustration of the flower in question (fig. 1), identifying it with the white-flowered form of *Datura metel*, known to the Japanese by the name of *Chosen-asagao*, or "Korean morning-glory."⁸

Matsumara, a Japanese botanist, has recently called attention to the fact that another vernacular name applied to the white-flowered *shiro chosen-asagao* is *mandarago*; and Dr. Tyozaburo Tanaka, to whom I am indebted for the above account of this plant; informs me that the latter name is nothing else than the Buddhistic pronunciation of Li Shi-Chen's *man t'o lo kua*, undoubtedly derived from the narcotic "mandragora," so famous during the Middle Ages.

ORIGIN OF THE NAME DATURA.

It was this Asiatic "metel-nut" called in India *Dhatura*, or *Dutra*, that gave its name to the genus. In the *Hortus Cliffortianus* of Linnaeus (1737) it appears as *Datura pericarpis nutantibus globosis*, or *Datura* with nodding globose pericarps, or fruits; and the flowers were described as varying in color, with a simple white corolla, a simple purple corolla, a double or triple purple corolla, or a double corolla white within and purple on the outside.

True to his principle of not adopting a barbarous word for a generic name, Linnaeus latinized the East Indian *Dhatura*, or *Dutra*, by giving it the form *Datura*, explaining the name by the following pun: "*Daturae, licet originis sit peregrinae, vocabulum persistere valet, cum a latina derivari potest; dantur et daturae forte in Indiis posthac semina a lascivis foeminis maritis inertibus.*"⁹

CONFUSION OF SPECIFIC NAMES.

After reading the above reference to the use of the Asiatic *Datura* as a narcotic and identifying with it the *Datura metel* described by Linnaeus in the first edition of his *Species Plantarum* by means of the descriptions and figures cited by Linnaeus, it seems strange that botanists should have abandoned the valid name *Datura metel* for

⁸ It is interesting to note in this place that *Datura stramonium*, the common Jamestown weed, which many botanists believe to be of Asiatic origin is called in Japan *yoshu chosen-asagao*, *yoshu*, signifying "foreign."

⁹ Linnaeus, Hort. Cliffort., p. 56, 1737.

草部 ナス科 (茄科)

一七四

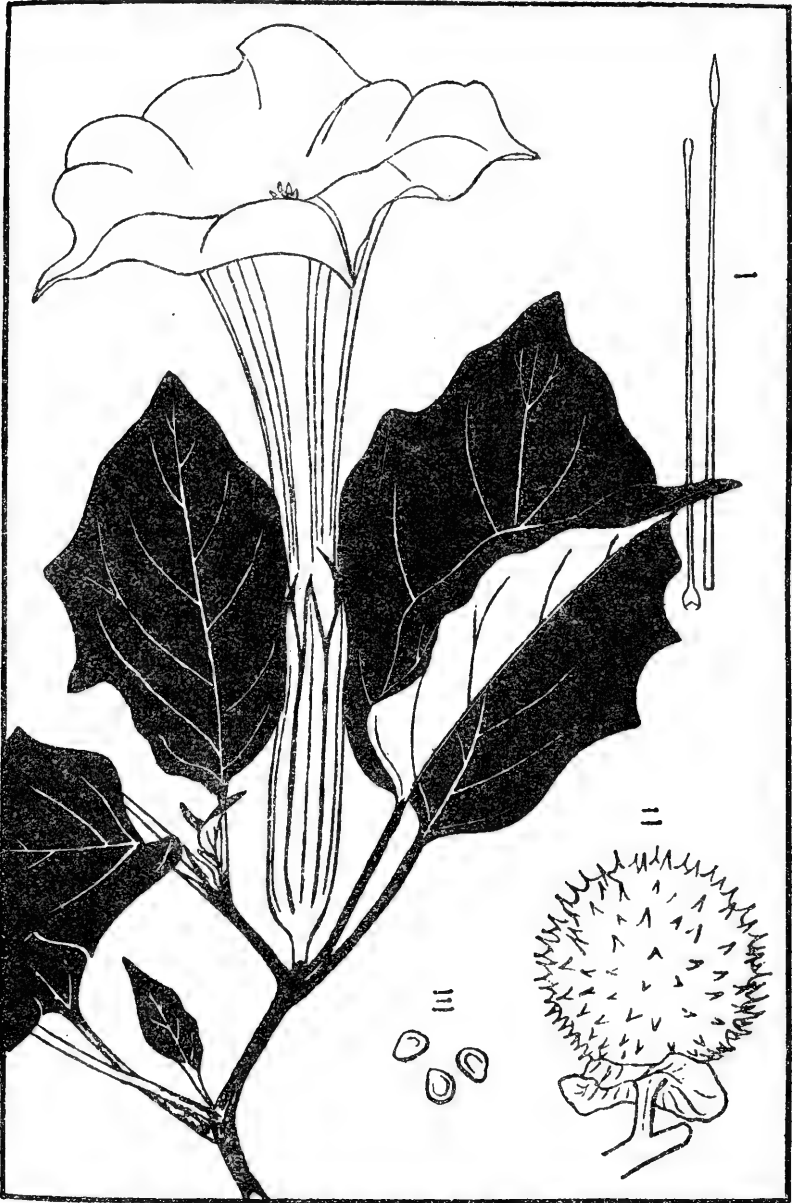

テウセンアサガホ
(Chōsen-asagao)

FIG. 1.—White-flowered single form of *Datura metel* L., called *Datura alba* by Nees.

the Asiatic species, substituting for it *Datura fastuosa*, which was first published as a specific name in the second edition of *Species Plantarum*, and transferring the name *Datura metel* to an American plant specifically distinct from the true *Datura metel* of Linnaeus.¹⁰

Under the brief description in *Hortus Cliffortianus*, above cited, the first two references lead to the identification of the *Stramonium*, or *Pomum spinosum*, described and figured by Bauhin with the *Stramonium* of Fuchsius and the *Nux methel* of Avicenna. Bauhin's figures agree with that of Fuchsius

(1542) in the form and surface of the fruit, which bears very short and thick spines, not subulate or needle-like prickles; indeed, his second illustration (fig. 2) is a reduced copy of Fuchsius's. It was not until after the publication of the *Hortus Cliffortianus* (1737) that Rumphius published his *Herbarium Amboinense* containing the plate reproduced in the accompanying illustration. (Fig. 3.) Linnaeus is careful to cite this plate, both in the tenth edition of his *Systema* and the second edition of his *Species Plantarum*, as an illustration of his *Datura metel*. In the former work he publishes *D. fastuosa* as the name of the second figure on the plate, not as a numbered species, but as a variety B; in the latter work he gives it specific rank, making it differ from the typical *D. metel* in having tuberculate instead of prickly pericarps. Fortunately the figures themselves show that these differences are nominal, and one has only to examine the fruits of the various forms of this East Indian *Datura* to be convinced of the variability of their tubercles or prickles. (See plate 1.) That the white and purple forms of the single or double flowered plants should all be referred to one species by Linnaeus, is justified by the best modern authorities on East Indian botany; but that the name *D. fastuosa* should be adopted for the species and the previously established type (*D. metel*) reduced



FIG. 2. — Bauhin's figure of *Datura metel* L., after Fuchsius (1542).

¹⁰ See Britton and Brown, *Illustrated Flora of the Northern United States, Canada, and the British Possessions*, second edition, vol. 3, p. 170, 1913, where this name is applied to a plant said to be a "native of tropical America." See also Gray's *New Manual of Botany*, seventh edition, p. 717, where the same plant is declared to be "adventitious from tropical America."

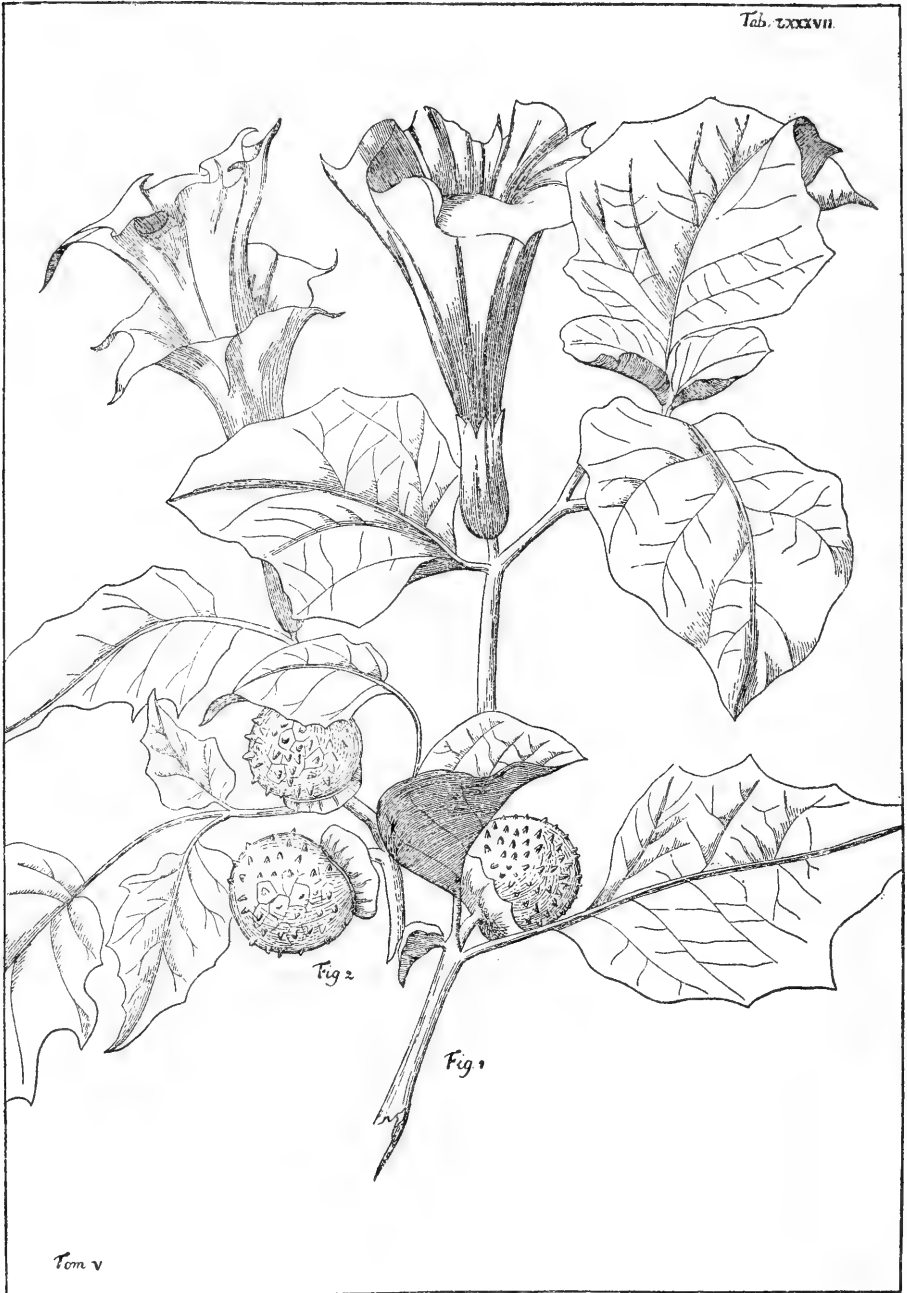

FIG. 3.—Rumphius's illustration of *Datura metel* L., single and double forms.

to a synonym, as in Trimen's Handbook of the Flora of Ceylon, is inexcusable.¹¹ Still more surprising is the treatment of this species by Nees von Esenbeck, who rebaptized the species *D. alba*, citing as its type the very plate of Rumphius which Linnaeus cites as the typical form of his *D. metel*¹² (fig. 3); while C. B. Clarke, in Hooker's Flora of British India, not only ignores Linnaeus's references above mentioned in connection with *Datura metel* but transfers this specific name from the Asiatic metel-nut to a plant of American origin and cites as an illustration of the species, not the figures of Fuchsius, Bauhin, or Rumphius, which fix Linnaeus's species, but an illustration in Curtis's Botanical Magazine (see fig. 4) of a plant grown in London from seed of American origin,¹³ clearly identical with Miller's *Datura innoxia*, which will be described below.¹⁴



FIG. 4.—*Datura innoxia* Miller. (See also pl. 3.)

For the misunderstanding of Linnaeus's *Datura metel*, Dunal is largely responsible. In De Candolle's Prodrômus (vol. 13, pt. 1, pp. 541-544) the section of the genus to which *D. metel* belongs is treated by this author in a most unsatisfactory manner. Disregarding Linnaeus's reference to the *Stramonium* of Johannes Bauhin (fig. 2) as the basis of *D. metel*, and, indeed, not referring at all to its original publication in the first edition of *Species Plantarum*, he describes as distinct species the various forms originally regarded by Linnaeus as varieties of the East Indian *Datura*, and still so regarded by botanists familiar with East Indian botany; accepts Nees von Esenbeck's *D. alba*, substituted for the previously described *D. metel*, and identified, like that species,

¹¹ Trimen, Handb. Fl. Ceyl., vol. 3, p. 238, 1895.

¹² Nees von Esenbeck in Trans. Linn. Soc., vol. 17, p. 73, 1834.

¹³ Hooker, Fl. Br. Ind., 3, 243, 1885.

¹⁴ Miller's Gardn. Dict., ed. 8, *Datura* No. 5, 1768.

with the *Dutra alba* of Rumphius; and fails to quote Linnaeus's citation of the very same illustration (see fig. 3) upon which Nees based his species. This Asiatic species (fig. 1), the distribution of which he gives as "in arenosis ubique per omnem Indian Orientalem," he makes identical with the American *D. innoxia* Miller (fig. 4) already referred to, a species which Miller definitely states grows naturally at La Vera Cruz, Mexico, whence he received the seeds. Fortunately the plant continues to grow in its type locality, where abundant material can be secured for study.

Under *D. fastuosa* Dunal does not indicate that it was in the second edition of *Species Plantarum* that it first appeared as a distinct species, but cites *Species Plantarum* without giving the edition of the work or the date of its publication; while under *D. metel* he fails to mention its appearance in the first edition, but cites only the second edition, so that the inference would be that this was the place of its first publication and that, instead of preceding, it followed the description of *D. fastuosa*. After this arbitrary treatment of *D. metel* L., one is curious to know what plant Dunal refers to this species, which he could not entirely ignore. In the De Candolle Herbarium he came upon an American plant, collected by Berlandier at Victoria in the State of Tamaulipas, Mexico, which appeared to correspond with the description of *D. metel*, and which indeed resembles that species very closely. This he settled upon as *D. metel* L. and identified with it a second Mexican plant collected by Schiede and Deppe on the sandy beach of Vera Cruz, and also an imperfect specimen of a *Datura* collected by Humboldt and Bonplend on the beach of Guayaquil, Ecuador. As for Asiatic examples of *D. metel*, definitely declared by Linnaeus to be the source of the East Indian aphrodisiac drug called *dhatúra*, he cites not a single specimen, but he does give as a synonym Rumphius's *Dutra nigra*, which is nothing else than the *kalā-dhatúrā*, or black *datura* of India, not specifically distinct from the *safed-dhatúrā*, or white *datura*.¹⁵

BOTANICAL DESCRIPTION OF THE ASIATIC DATURA METEL.

Datura metel L. is a spreading plant with dichotomous branches, usually herbaceous but sometimes becoming shrublike with the base of the stem and the lower branches woody, and the root, which penetrates deeply into the soil, bearing several large branches of similar size. The entire plant is apparently glabrous and has the appearance of being covered with fine grayish dust or flour. The terete glossy stems and older branches are marked with the scars of fallen leaves. The leaves are triangular-ovate in general outline and un-

¹⁵ See Watt's *Dict. Econ. Prod. India*, vol. 3, pp. 32-36, 1890, under *Datura fastuosa*, the black *Datura*, and *D. fastuosa* var. *alba*, the white *Datura*.

equal-sided at the base, especially those of the upper branches, acute at the apex, and with the margins usually angulate but sometimes entire. The flowers (see pl. 2) are large and funnel-shaped, often double or triple, one corolla issuing from another; in the type form pure white, but sometimes of a dirty whitish color, violaceous, reddish-purple, or purple on the outside and white within. The tubular calyx, as seen under the lens, is minutely appressed-pubescent, with five triangular, acuminate marginal teeth, and is usually about one-third as long as the corolla. The corolla limb when fully expanded is almost circular, normally with five equidistant radiating nerves terminating at the margin in a short acute tail, but often 6-toothed, and in the inner corollas of double flowers from 5 to 10-toothed.

The tubercled or muricate globose fruit (see pls. 1 and 2 and figs. 1, 2, and 3) is borne on a short thick peduncle which is never erect as in *D. stramonium* (pl. 6) but curved to one side, so that the fruit is at length more or less inclined or nodding. The persistent expanded base of the calyx is either reflexed or appressed to the pericarp, which is not valvate, as in *D. stramonium*, but cracks open irregularly, revealing a mass of closely packed, light brown, flat seeds which nearly fill the interior.

Type locality.—As to the mother country of *Datura metel*, Linnaeus states, in the first edition of his *Species Plantarum* (p. 179, 1753), "Habitat in Asia, Africa." In *Hortus Cliffortianus*, under his description of the plant which formed the basis of the species he is more definite: "Crescit in Oriente, in Malabria, Aegypte, etc.;" while in the second edition of *Species Plantarum*, where he identifies his plant with Rumphius's *Dutra alba*, he extends its range to the Island of Amboyna. Nowhere does he mention its occurrence in the Canary Islands, as cited by Nees von Esenbeck, but it is very probable that "Canara" (the district of Kanara, British India), mentioned by Rumphius as one of the localities of its occurrence, was mistaken for the Canary Islands¹⁶ by Willdenow, who, in the fourth edition of *Species Plantarum* (p. 1009, 1797) adds this locality to Asia and Africa; and it is this edition of *Species Plantarum* and not the first (where the species was originally established) that Nees cites, when he rechristens the species and improperly transfers its valid name to another.

The illustration on page 544 (fig. 3), drawn by Mrs. R. E. Gamble after Rumphius, shows the simple-flowered white *dutra*, identical with the type of Linnaeus's *D. metel*, and a double-flowered form identical with *D. metel* var. *fastuosa*. Rumphius states that the white *dutra* (see fig. 1) is very common in India and grows to a larger

¹⁶ Rumphius refers to it as follows: "Per totam fere Indiam, nota est haec planta, in uno tamen loco magis nocet quam in altero, saltem quae in Canara Malabara crescit, multo videtur efficacior esse Amboinensi & Moluocensi."—Herb. Amb., p. 243, 1747.

size than the other forms; also that, while the upper leaves have unequal margins on opposite sides of the midrib, the larger leaves near the base of the plant are frequently symmetrical or nearly so and broadest at the base, with the salient marginal angles more or less hastate. He describes the corolla as five-toothed, white, and more than a palm wide. The flowers can not endure the heat of the mid-day sun, but they open on calm cloudy days and especially toward evening, remaining expanded throughout the night and exhaling a sweet but faint lilylike fragrance. He likens the fruit to small apples as large as a hulled walnut, but rounder, subtended by a flat shieldlike pericarp which continues green for a long time, and bearing upon the surface short thick points, which do not prick but make it difficult to seize the fruit. This finally breaks up into four parts, exposing a white medulla thickly covered with dark yellow, flat, rugose seeds, shaped almost like the human ear, and having a sweetish but insipid taste. The black dutra has similar flowers and fruit but dark brown or blackish stems and more prominently angled, deeper green leaves which appear to be sprinkled with gray flour, while the red dutra, the type of the variety *fastuosa*, has double reddish-colored flowers and lead-colored foliage. He does not hesitate to identify his plant with the classic *nux-metella*, or *methel*, and he states that Anguillara believed it to be identical with the narcotic *hippomanes* of Theocritus.

The seeds of this species continue to be used widely in India. Capt. Thomas Hardwicke while traveling in 1796 between Hurdwar and Sirinagur, British India, found it common in every part of the mountains where there were villages. The natives were well acquainted with its narcotic properties, and used an infusion of its seeds to increase the intoxicating powers of their spirituous liquors.¹⁷ Dr. John Fleming, in his Catalogue of Indian Medicinal Plants and Drugs, states that *Datura stramonium* is not found in Hindustan, but that *D. metel* grows wild in every part of the country. "The soporiferous and intoxicating qualities of the seeds are well known to the inhabitants, and it appears from the records of the native courts of justice that these seeds are still employed for the same licentious and wicked purposes as they were formerly, in the time of Acosta and Rumphius."¹⁸ Many other references to such uses are given by writers on India. Mr. Baden Powell observed a series of samples in an exhibit at Lahore, illustrating the criminal methods of using the drug in Upper India. It included raw seeds, roasted seeds, essence of the seeds, and flour, sugar, and tobacco which had been drugged with them. He states that this drug is used by the thugs to stupefy their victims, and that it is derived from both the white and purple datura. For use as a poison the seeds are

¹⁷ Asiatick Researches, vol. 6, p. 351, 1799.

¹⁸ Asiatick Researches, vol. 11, p. 165, 1810.

parched and reduced to a fine powder which is easily mixed with various articles of food, tobacco, etc., and that an essence is prepared by distilling the seeds with water, 10 drops of which is sufficient to render a man insensible for two days.¹⁹

Seeds of the typical forms used as drugs in India have recently been secured for the writer by the Office of Foreign Seed and Plant Introduction, United States Department of Agriculture. It is proposed to grow them on the Arlington Farm, where the plant shown on plate 2 was propagated. This species, like our own *Datura stramonium*, is a source of a valuable alkaloid identical in its effects with atropine.

AMERICAN DATURAS ALLIED TO THE METEL NUT.

Datura innoxia Miller. Plate 3. Figure 4.

Hernandez, in his account of the medical plants of New Spain, describes a species of *Datura* of Eastern Mexico, having leaves clothed with soft hairy pubescence, which can be no other than the *Datura innoxia* of Miller. This plant was sometimes called *Nacazcul*, from the resemblance of its flattened seeds to a miniature human ear. It was also known as *Toloatzin* ("Inclined-head") on account of its nodding capsules. The name *toloatzin*, modified to the form "toloache," came to be applied to several distinct species of *Datura*. It has been recently suggested that the name was primarily applied to an arborescent *Datura* with pendent flowers, commonly known as *Floripondio*; but this can not possibly be true, since all the arborescent *Daturas* have unarmed fruits, and the fruits of the *Toloatzin* are described as spiny. Moreover, the *Floripondios* are all of South American origin, and seldom produce fruit in Mexico. According to Hernandez's description, the plant called *Nacazcul*, or *Toloatzin*, is a kind of Jamestown weed (*tlapatl*) growing in the Province of Huexotzinco, now included in the State of Puebla. It has spreading branches, white woody roots, and ill-smelling softly hairy leaves, which Hernandez compared to those of a grapevine in form. Its fruit is globose and spiny, but at length it loses the spines. The seeds are of a yellow color and resemble those of a radish (*semen est fulvum raphanino simile*). This plant was common in waste places and in the fields of Pahuatlan. It was highly esteemed by the natives as a remedy for many complaints. The dry seeds, ground and mixed with pitch, were used in setting broken bones and were wonderfully efficient in curing sprains and dislocations. In using them the Indians applied feathers and bound the broken member with splints; then they took the patient to the *temexcalli*, or vapor baths, repeating the treatment as often as might be necessary. From the

¹⁹ See Watt, Dict. Econom. Prod. India, vol. 2, p. 34, 1890.

leaves of the plant an anodyne was made and administered as a remedy for the pains of the whole body and also for the "French sickness." A poultice, for external application, was also made of them, with the addition of yellow capsicum; but warning was given that an excessive amount be not administered lest the patient be seized with madness and become the victim of "various and vain imaginations."

In Antonio Recchi's edition of Hernandez (1651) a note is appended to the original description stating that Nacazcul is a species of tlapatl, or *Datura*, which itself is allied to *Hyoscyamus*. The capsule of this plant is apparently four-celled, but when it matures it is found to be really two-celled, each cell containing many seed embedded in a spongy substance as in *Hyoscyamus*.

It is this plant that Dunal in De Candolle's *Prodromus* called *Datura metel*, in spite of the fact that its stem, according to his own description,

is densely pubescent or hairy ("caule * * * denso pubescente subvillosa"), its leaves on both sides densely pubescent, and its calyx sparsely so; features which separate it at once from the true Asiatic *Datura metel* L., the dark-colored form of which, called *Dutra nigra* by Rumphius, Dunal erroneously cites as a synonym of the American

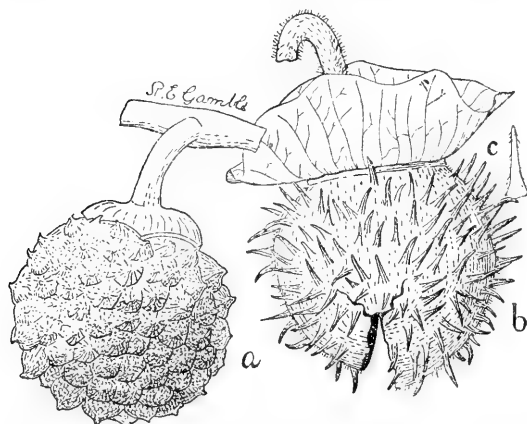

FIG. 5.—Fruits of the Asiatic *Datura metel* L. and the American *D. innoxia* Miller.

species, while calling Rumphius's white-flowered *Dutra* by Nees's name, *Datura alba*, instead of by its earlier and perfectly valid name, *Datura metel*, established by Linnaeus in the first edition of his *Species Plantarum*. In figure 5 the fruits of the two species are shown.

OLOLIUHQUI, THE MAGIC PLANT OF THE AZTECS.

Datura meteloides Dunal. Plate 4.

The identity of this plant was for a long time doubtful, owing to the fact that its Aztec name was also applied to certain species of *Convolvulaceae*, or morning-glories. It was even described and figured as an *Ipomoea* by Hernandez. It is not surprising that it should have been so confused; for its trumpet-shaped flower, like that of the

closely allied *D. discolor*, strongly suggests a morning-glory. (See pls. 4 and 5.) Like the Nacazcul (*Datura innoxia*) above described, it was the source of a medicine reputed to be efficacious in curing the "French sickness" and also for mending broken bones. Padre Sahagan does not confuse it with a convolvulus, nor does he state that the plant has a twining habit. He describes it as follows:

There is an herb which is called coatlxoxouhqui [green snake weed]. It produces a seed called *ololiuhqui*, which is intoxicating and maddening. This is administered in potions in order to harm those who are the objects of hatred. Those who eat it have visions of terrible things. Wizards or persons who wish to injure some one administer it in food or drink. The herb has medicinal properties. As a remedy for gout its seeds are ground up and applied to the part affected.

Hernandez, who received most of his information from the Indians, although erroneously figuring this plant as an Ipomoea, states that the priests of the Indians when they wished to hold converse with spirits and receive responses from them ate of it in order to throw themselves into a frenzy and to see a thousand phantasms revealed and presented to them, as in the case of *Solanum maniacum* of Dioscorides, with which this plant might possibly be identified. He adds: "It will not be a great mistake to omit telling where it grows, and it imports little that this herb be here depicted or that it should even become known to Spaniards."

From the foregoing statement it would appear that Hernandez was intentionally misleading in his account of the *Ololiuhqui*, and he did not wish its identity to be discovered. An interesting description of the use of *Ololiuhqui* by the Aztec priests, or *payni*, is given by Jacinto de la Serna, whose account, published in *Documentos ineditos para la Historia de España*, volume 104, page 163, follows:

They have also great superstitions regarding a lentil-like seed which they call *ololiuhqui*, and also another larger drug, a root called *peyote*, which they venerate as though they were divine. For in drinking these herbs they consult them like oracles regarding whatsoever maladies they may attempt to cure and whatsoever objects they wish to know about, whether lost or stolen, and those things which are beyond human knowledge, such as the origin of infirmities, especially if they are chronic and of long standing and are attributed to witchcraft. In order to dispel doubts regarding this and also for other purposes they have recourse to these herbs through the medium of their impostor medicine men, who, after drinking, reply to all their questions. The person who practices this office is called *payni*, which signifies the drinker of a purge or sirup. They also pay these persons very well; and if the medicine man is not very skillful in his office, or if he wishes to excuse himself from the trouble which the drinking of these philters would cause, they advise the sick to drink them or those in quest of lost objects who seek to discover where those things are or in whose possession they may be.

These seeds, especially the *ololiuhqui*, they hold in as great reverence as though they were God, burning candles before them and keeping them in small *petaquillas*, or boxes, expressly made for this purpose; and they place sacrificial

offerings to them on the altars of their oratories or on the canopies over them or in other secret places in their houses, so that when a search is made for them they can not easily be discovered; or they may place them between the *idolillos* of their ancestors, which they leave to guard them or, as it were, chained to them. And all this they do with such respect and reverence that when those who keep this seed in their possession are arrested or are asked for the paraphernalia with which they perform the ceremony of this drink, such as the *tecomatillos*, or little gourds and cups used to hold it, or for the seeds themselves they protest most vehemently that they have no knowledge of the matter whatever, not so much from fear of the judges before whom they are arraigned as for the reverence they feel for the sacred objects, which they do not wish to affront by a public demonstration of the ceremonial use of them, the burning of the seeds, etc.

CEREMONIAL USE OF DATURA METELOIDES BY THE ZUÑI INDIANS.

It is interesting to note that the veneration of the narcotic *Olo-luhqui* extended far to the northward and was common to the Indians of New Mexico and certain tribes of California. Mrs. Matilda Coxe Stevenson, in the Thirtieth Annual Report of the Bureau of American Ethnology, gives an account of this plant, held sacred by the Zuñi Indians, among whom the following legend is current:

In the olden time a boy and a girl, brother and sister (the boy's name was A'neglakya and the girl's name A'neglakyatsi'tsa), lived in the interior of the earth, but they often came to the outer world and walked about a great deal, observing closely everything they saw and heard and repeating all to their mother. This constant talking did not please the Divine Ones (twin sons of the Sun Father). On meeting the boy and the girl the Divine Ones asked, "How are you?" and the brother and sister answered, "We are happy." (Sometimes A'neglakya and A'neglakyatsi'tsa appeared on the earth as old people.) They told the Divine Ones how they could make one sleep and see ghosts, and how they could make one walk about a little and see one who had committed theft. After this meeting the Divine Ones concluded that A'neglakya and A'neglakyatsi'tsa knew too much and that they should be banished for all time from this world; so the Divine Ones caused the brother and sister to disappear into the earth forever. Flowers sprang up at the spot where the two descended—flowers exactly like those which they wore on each side of their heads when visiting the earth.²⁰ The Divine Ones called the plant "a'neglakya," after the boy's name. The original plant has many children scattered over the earth; some of the blossoms are tinged with yellow, some with blue, some with red, some are all white—the colors belonging to the four cardinal points.

The medicine of the *Datura* is sometimes called u'teaweko'hanna—"flowers white."

²⁰This flower is represented in Zuñi and in other pueblos by interlacing colored yarns around the desiccated fruit of *Martynia louisiana* Mill, which is attached to a leather band passing around the head. On the forehead the band is covered by the bangs of the maiden wearing the flower. This headdress is worn by women in the dance. Students have described it as symbolizing the squash blossom, an error only too pleasing to the Zuñi, as the blossom of the *Datura* is most sacred to them.

In the accompanying illustration (fig. 6) the 10-angled corolla of *Datura meteloides* is shown, together with the 5-angled *Datura metel* of the Old World.

The use of *Datura meteloides* appears to have been widely spread throughout the southwestern United States. Miss Alice Eastwood, while exploring in southwestern Utah, came upon an abundance of its seeds and seed pods "in the ruins of the ancient people who once filled this land, and guarded every spring with towers of stone."²¹ Stephen

Powers found the same species used as an intoxicant and hypnotic by the priests and wizards of the Yokuta Indians living on the banks of the Tule River and Lake Tule, California;²² and the late Edward Palmer, who also encountered it in California, states that certain tribes in that State gave it to their young women, to stimulate them in dancing. He also states that an extract from its root is used as an intoxicant by Pai Utes.²³

Other authorities describe its use by

the Mariposa Indians of California, including the Noches and Yakuts, already mentioned, in the ceremonial initiation of their youths into manhood; and the custom of the medicine men of the Hualpais, or Walapais, to utter oracular prophecies while intoxicated by it.²⁴

That this species should have been classed by the Aztecs with the Convolvulaceae, or morning-glories, is not at all surprising. In a recent article, by Willard N. Clute, published in the American

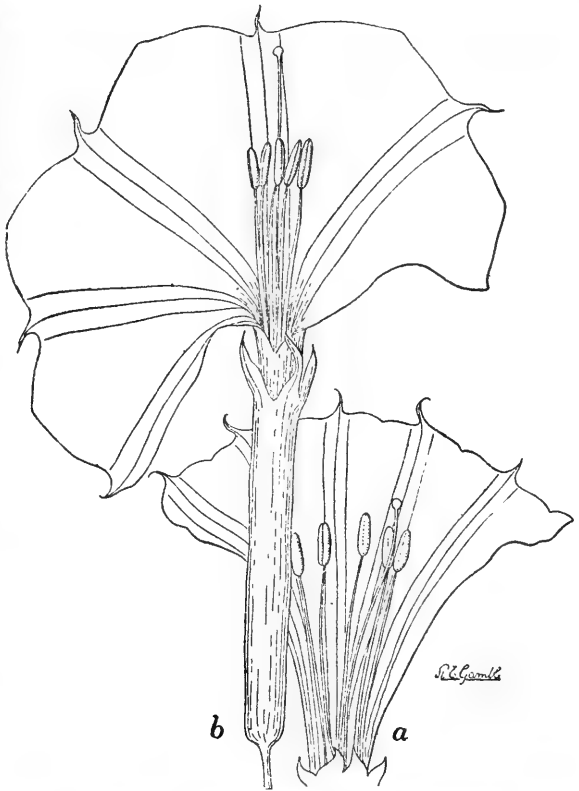

FIG. 6.—Corollas of *Datura metel* L. and *D. meteloides* Dunal.

²¹ See Zoe, vol. 3, p. 360, 1892.

²² See Contr. N. Am. Ethn., vol. 3, pp. 380 and 428, 1877.

²³ Am. Nat., vol. 12, p. 650, 1878.

²⁴ See Bourke, John G., "On the Border with Crook," p. 165, 1892.

Botanist, it is described and figured under the name of the "desert trumpet flower," and the author describes it clustering along the mesa on the morning of a snake dance performed at Walpi, adding its perfume, like incense, to the religious ceremonial of the Hopi Indians. The flowers, like many of the Convolvulaceae, open at a certain hour of the day. They, and also the seed, bear a close resemblance to those of the Old World *Datura metel*, which was likened by Christoval Acosta to a convolvulus called in Spain "corregüela mayor," with trumpet-shaped flowers and seeds like lentils.²⁵

In gathering the plant for ceremonial or medicinal purposes it is treated with great deference by the Luiseño Indians, who observe preliminary ceremonies, recalling the customs of certain Mexican tribes in gathering the narcotic *peyote*, and those of European herb gatherers of the Middle Ages in connection with the dreaded mandragora. Before beginning to dig it up the medicine man addresses the plant somewhat as follows: "I have come to get you, but not without a purpose. You were placed as medicine, and it is for medicine that I seek you. Be not humiliated, oh powerful one."²⁶

According to Dr. John P. Harrington, of the Bureau of American Ethnology, the uses of this plant in religious ceremonies and in medicine were quite distinct in the minds of the Indians. After having partaken of it ceremonially a man not infrequently would remain under its influence for two days, during which he was left to himself. On regaining consciousness he was given warm water to drink and toward nightfall some *atole*, or gruel. Among the visions experienced by him while under the influence of the narcotic might perhaps be that of some particular animal or plant, which was not infrequently adopted as a supernatural helper or familiar spirit to accompany him through life and render him aid in times of doubt or trouble. For a month after having partaken of the drug it was customary for him not to go to bathe or to eat meat or fat and during this period the society of human beings was avoided and solitude was sought among the hills. The winter season was chosen for the administration of the drug; it was supposed to be injurious if taken in warm weather; even in April the time for drinking it had passed.

INITIATORY CEREMONIAL OF THE LUISEÑO INDIANS.

The use of *Datura meteloides* among the Indians of southern California recalls the huskanawing ritual of the Virginia Indians described below. The following account is based upon a description of the ceremony, given by Lucario Cuevish to Miss Constance God-

²⁵ Christoval Acosta, *Tractado de las drogas y medicinas de las Indian Orientales*, pp. 86, 87, 1587.

²⁶ For similar apologetic preliminaries, practiced by the Indians of Mexico in cutting down trees and gathering narcotic and medicinal plants, see Safford, W. E., "An Aztec Narcotic (*Lophophora Williamsii*)," *Journ. of Heredity*, vol. 6, pp. 291-311, 1915.

dard Dubois, who, after describing the beautiful large flowers, opening toward evening and closing the next morning, speaks of the wide range of the plant in the southwestern United States and Mexico. Instead of the seeds it is the root of the plant which is used by these Indians as a narcotic.

The plant itself is called by the Luiseños *Naktamush*, or *Naktomush*; the ceremony is known as the *mani* or *manish-mani*. When it grows dark the masters of the ceremony, called *paha*, go from house to house to collect the candidates for initiation, sometimes carrying in their arms little boys who have already fallen to sleep to the place of assembly. The strictest silence is observed, and it is necessary that the *paha* be a shaman, or wizard skilled in magic. A large *tamyush*, or stone bowl, is placed before the chief, who, sitting in the darkness, pounds with a stone *mano*, or pestle, the dry scraped root of the plant, to the accompaniment of a weird chant, while the boys stand waiting. The powdered root is then passed through a basket-sieve back into the stone bowl and water is poured upon it. The boys are enjoined to keep silence. As each boy kneels in turn before the big bowl to drink the infusion, his head is supported by the hand of the master of ceremonies, who raises it when enough has been taken. It is a solemn occasion, a spiritual rebirth, suggesting the rites of baptism or confirmation. During the entire ceremony both the men and the boys are quite nude. When the drink has been administered to all the candidates, dances are performed in the darkness, accompanied by cries in imitation of birds and beasts; and when these are finished the candidates are marched round a fire, chanting a ceremonial song. As the effects of the narcotic plant overcome them, one by one they fall to the ground and are carried to another place and left until they regain consciousness. After this the dancing is resumed and kept up through the entire night. At daylight they return to the place where the drink was administered, and after a day of fasting they witness feats of magic performed by the shamans, from whom, after having been dressed in feathers and painted, they receive wonder-working sticks. The boys are also instructed by their elders in certain mysteries and rules of conduct, somewhat corresponding to one's duties toward God and to one's neighbor, as taught in the catechism. The initiatory ceremony is followed by two or three weeks of abstinence from salt and meat, after which a ceremony with a rope, called *wana-wut*, is performed. When this is finished the candidates are free.

DATURA DISCOLOR OF THE SOUTHWESTERN UNITED STATES.

Plate 5.

Closely allied to *Datura meteloides*, but differing from it in the size and color of its flowers and seeds, is *Datura discolor* Bernh., a species to which very little attention has been paid, and which has commonly been confused in herbaria with other species from which

it is easily distinguished. Its most striking characteristic is the black color of the seeds and the violet-striped throat of the flaring 10-toothed trumpet-shaped corolla. (See pl. 5.) Mr. O. F. Cook, in his field notes of 1916, records this species as occurring, together with *Datura meteloides*, in irrigated fields of a Pima village called Santan. In comparing the two species he notes that *Datura discolor* has smaller flowers, with a narrower corolla tube and a more abruptly expanded trumpet-shaped, rather than funnel-shaped, limb, and the throat of the corolla longitudinally striped with violet-colored lines. The



FIG. 7.—*Datura discolor* Berhn., showing nodding fruit and black seeds.

calyx tube is prominently angled or prismatic in form, drying back nearly to the base soon after flowering, and leaving the base itself to expand, very much as in the case of *D. meteloides*. The nodding capsule (fig. 7) has longer spines finely pubescent when young. The fruit is fleshy at first, although not so juicy as in *D. meteloides*, at length becoming brittle and dry, but never hard and woody as in *Datura stramonium*. The seeds are black, as stated above, not light brown as in *D. meteloides*, and they are smaller than in the latter species. The fresh foliage of *D. discolor* has only a trace of the pleasant odor given off by the seeds and bruised tissues of *D. meteloides*. This odor is not the fragrance of the flowers, nor the nauseous smell of the Jamestown weed, but a pleasant odor suggesting parched sesame or other seeds rich in oil. It is easy to believe that this pleasant flavor was attractive to primitive seed eaters, who were thus led to experience the intoxication of *Datura*, a mysterious effect which caused people in many parts of the world to attribute to related plants a supernatural power, making them "as gods," able to confer at will with spirits. At Bard, California, on the Yuma Reclamation Project, *Datura meteloides* is rare, and the smaller-flowered *Datura discolor* abundant.

THE JAMESTOWN WEED AND ITS ALLIES.

Plate 6.

Hernandez, in his great work on the products of New Spain, already referred to, gives an account of *Datura stramonium* under the heading *De Tlapatl: Stramonio*, accompanied by an illustration rather

crude, but sufficiently accurate for its identification. Both white-flowered and purple-flowered forms of this species occur in Mexico as well as in the United States, the purple flowered usually called "*Datura tatula*," but not differing specifically from the white-flowered, to which they bear the same relation as the colored forms of the oriental *Datura metel* to the typical white form. The species varies also in the form of its capsules. These differ from the nodding capsules of *Datura metel* and its allies in being erect and in regularly dehiscent when mature (see pl. 5); they are spiny in the typical form, but unarmed in the variety which has been called *Datura inermis* (fig. 8). It seems strange that botanists should have attributed the white-flowered form to Europe and the colored form of the same species to America. Linnaeus in establishing the species declared it to be American. Observations on growing plants show that both the white-flowered and the purple-flowered forms may bear either smooth or prickly capsules, and that of the antagonistic color characters the purple is the dominant and the white-flowered the recessive form. (See Journ. Heredity 12:184. 1921.)

ORIGIN OF THE NAME JAMESTOWN WEED.

The narcotic properties of *Datura stramonium* were known to our own southern Indians as well as to the Mexicans. Hernandez calls attention to the fact that its fruit causes insanity if eaten incautiously. That this is true is shown by the following anecdote taken from Robert Beverly's History and Present State of Virginia, in his account "Of the wild fruits of the country." It appears that the soldiers sent to Jamestown to quell the uprising known as Bacon's Rebellion (1676) gathered young plants of this species and cooked it as a pot herb, possibly mistaking it, owing to the shape of its leaves, for a solanaceous pot herb or perhaps learning of its narcotic effects from the Indians of that region, who used it as a ceremonial intoxicant. His account is as follows:

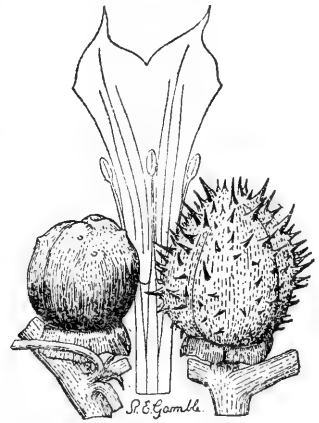

FIG. 8.—Spiny and smooth capsules of Jamestown weed, *Datura stramonium* L.

The James-Town Weed (which resembles the Thorny Apple of Peru, and I take it to be the Plant so call'd) is supposed to be one of the greatest Coolers in the World. This being an early Plant, was gather'd very young for a boil'd salad, by some of the Soldiers sent thither, to pacifie the troubles of Bacon; and some of them eat plentifully of it, the Effect of which was a very pleasant Comedy; for they turn'd natural Fools upon it for several Days: One would blow up a Feather in the Air; another wou'd dart Straws at it with much Fury; and another stark naked was sitting up in a Corner, like a Monkey, grinning

and making Mows at them; a Fourth would fondly kiss, and paw his Companions, and sneer in their Faces, with a Countenance more antick, than any in a *Dutch Droll*. In this frantick Condition they were confined, lest they should in their Folly destroy themselves; though it was observed, that all their Actions were full of Innocence and good Nature. Indeed, they were not very cleanly; for they would have wallow'd in their own Excrements, if they had not been prevented. A Thousand such simple Tricks they play'd, and after Eleven Days, return'd themselves again, not remembring anything that had pass'd." ²⁷

HUSKANAWING CEREMONY OF THE VIRGINIA INDIANS.

In the eastern United States the Algonquins and other tribes of Indians practiced a ceremony comparable with that of the California Indians, already described, in initiating their boys into the dignity of manhood. In the ritual an intoxicating medicine (*wysoccan*) was administered to the candidates, the principal ingredient of which was undoubtedly *Datura stramonium*. The following account of this is given by Beverly in his History of Virginia:

The solemnity of huskanawing is commonly practiced once every fourteen or sixteen years, or oftener, as their young men happen to grow up. It is an institution or discipline which all young men must pass before they can be admitted to be of the number of the great men, officers, or cockarouses of the nation; whereas, by Capt. Smith's relation, they were only set apart to supply the priesthood. The whole ceremony of huskanawing is performed after the following manner:

The choicest and briskest young men of the town, and such only as have acquired some treasure by their travels and hunting, are chosen out by the rulers to be huskanawed; and whoever refuses to undergo this process dares not remain among them. Several of those odd preparatory fopperies are premised in the beginning, which have been before related; but the principal part of the business is, to carry them into the woods, and there keep them under confinement, and destitute of all society for several months, giving them no other sustenance but the infusion, or decoction, of some poisonous, intoxicating roots; by virtue of which physic, and by the severity of the discipline which they undergo, they become stark, staring mad; in which raving condition, they are kept eighteen or twenty days. During these extremities, they are shut up, night and day, in a strong inclosure, made on purpose; one of which I saw belonging to the Pamunky Indians, in the year 1694. It was in shape like a sugar loaf, and every way open like a lattice for the air to pass through. In this cage, thirteen young men had been huskanawed, and had not been a month set at liberty when I saw it. Upon this occasion, it is pretended that these poor creatures drink so much of that water of Lethe, that they perfectly lose the remembrance of all former things, even of their parents, their treasure, and their language. When the doctors find that they have drunk sufficiently of the wysoccan (so they call this mad potion), they gradually restore them to their senses again, by lessening the intoxication of their diet; but before they are perfectly well, they bring them into their towns, while they are still wild and crazy, through the violence of the medicine. After this they are very fearful of discovering anything of their former remem-

²⁷ Beverly, Robert, History and Present State of Virginia, bk. 2, p. 24, 1705.

brance; for if such a thing should happen to any of them, they must immediately be huskanawed again; and the second time, the usage is so severe, that seldom any one escapes with life. Thus they must pretend to have forgot the very use of their tongues, so as not to be able to speak, nor understand anything that is spoken, till they learn it again. Now, whether this be real or counterfeit, I don't know; but certain it is, that they will not for some time take notice of any body, nor anything with which they were before acquainted, being still under the guard of their keepers, who constantly wait upon them everywhere till they have learnt all things perfectly over again. Thus they unlive their former lives, and commence men by forgetting that they ever have been boys.²⁸

The Jamestown weed and its close allies form a distinct group differing from all other *Daturas* in having erect capsules which split open regularly into four parts, as shown on plate 6. They vary considerably in the color of the stems and flowers and in the thorniness of the capsules. Specimens of the "thorny apple of Peru," were grown from seed collected by Dr. J. N. Rose in South America. The plants grew vigorously at Washington, but the flowers were smaller than in our own *Datura stramonium*, with the purple-flowered form of which (*Datura stramonium tatula*) it proved botanically identical. The smooth-fruited form has been separated from the type under the name *Datura inermis*, but both the spiny and the smooth forms shown in figure 8 grew from seeds of the same plant. Attention is called to the form of the corolla, as shown in figure 8, the teeth of which are separated by distinct sinuses, or notches, while in the sacred *Datura* of the Zuñis, shown in figure 6b, the corolla teeth alternate with salient obtuse angles, which in the smaller-flowered *Datura discolor* (pl. 5) are tipped with points giving the flowers the appearance of 10-pointed morning glories. Humboldt and Bonpland collected a dwarf oak-leaved *Datura* (fig. 9) in Mexico, which was described under the name of *Datura quercifolia*. This species is frequently confused with *Datura discolor* mentioned above, but is readily distinguished from that species by its notched five-toothed corolla and its erect seed pods. Another closely allied Mexican species of this group is *Datura villosa* Fernald, characterized by hairy branches, petioles, and calyx.

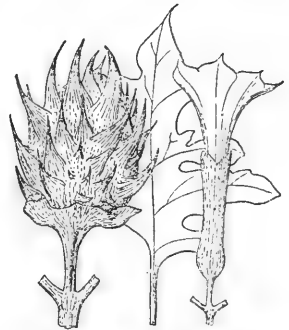

FIG. 9.—The oak-leaved Jamestown weed, *Datura quercifolia* H. B. K.

AQUATIC TORNA-LOCA OF MEXICO.

Figure 10.

This plant, described in 1800 by Ortega from a specimen of Mexican origin growing in the Royal Botanical Garden at Madrid, has

²⁸ Robert Beverly, *History of Virginia*, pp. 162-163, 1855.

marked narcotic properties, on account of which it is called by the Mexicans Torna-loca ("maddening weed"). By the ancient Aztecs, who held it sacred, it was called Sister of the Ololiuhqui (*Datura meteloides*). It was also called Atlinan, a name applied to several other water plants. In treating certain maladies their priests addressed to it the following prayer:

I invoke thee, my mother, thou of the precious waters: Who is the god, or who the so powerful one that wishes to destroy and consume my enchantment? Ea! Come thou, Sister of the Green Woman Ololiuhqui, of her whom I am about to go and leave in the seven caves, where the green pain, the brown pain, will conceal itself. Go and stroke with thy hands the entrails of the possessed one, that thou mayst prove thy might and fall not into ignominy."²⁹



FIG. 10.—The aquatic Torna-loco, *Datura ceratocaula* Ortega.

TECOMAXOCHITL OF THE AZTECS.

Closely allied to the genus *Datura* are the climbing *Solandras* of tropical and subtropical America, one of which was figured by Hernandez under the name Tecomaxochitl.³⁰ Plants of this genus contain a midriatic alkaloid which was named solandrine by Petrie (1907) and nor-hyoscyamine by Carr and Reynolds (1912).³¹ The investigation which led to its discovery was the result of the effects of the sap of *Solandra longiflora* accidentally squirted into the eyes

of a gardener while pruning a hedge of it, causing the pupils to be intensely dilated, as in the effects of atropine.

Plate 7 is a photograph of *Solandra hartwegii* N. E. Brown, grown in one of the Government conservatories at Washington. The flowers of this species resemble in form the angel's trumpet (*Datura suaveolens*), and are not contracted at the throat as in Hernandez's figure, or in *Solandra longiflora*. From the latter they also differ in color, the corolla at length becoming yellow with a purple medium

²⁹ Jacinto de la Serna, "Manual de Ministros para el conocimiento de idolatrias y extirpacion de ellas," in Documentos ineditos para la Historia de España, vol. 104, pp. 159-160.

³⁰ Hernandez, op. cit., p. 408, 1651.

³¹ See Petrie, J. M., "Solandrine, a new midriatic alkaloid," Proc. Linn. Soc. of New South Wales, vol. 32, p. 789, 1907; *ibid.*, "The occurrence of nor-hyoscyamine in *Solandra longiflora*," Proc. Linn. Soc. New South Wales, vol. 41, p. 815, 1916.

stripe on each lobe, and the stamens with pale yellow filaments and purplish anthers. The purple-petioled deep green leaves are leathery and glossy, differing from those of the closely allied *Solandra guttata* Don in being perfectly glabrous on both faces, instead of velvety.

The Mexican *Tecomaxochitl* is described by Hernandez as having leaves resembling those of a lemon, large flowers yellow on the outside, purple within, and white stamens. There are other species of *Tecomaxochitl*, he adds, with flowers entirely yellow and with smaller and more acuminate leaves. The flowers, which have the fragrance of lilies, were held in high esteem by the Aztec chiefs and were planted and cultivated with great care in their pleasure gardens.³² According to Sessé and Mociño the water contained in the unopened flower buds was reputed by the Indians to be efficacious as a remedy for certain affections of the eyes.

NARCOTIC TREE DATURAS OF SOUTH AMERICA.

The tree daturas of South America, called Campanillas, or Floripondios, by the Spanish-Americans, have been segregated by certain botanists as a distinct genus, under the name *Brugmansia*³³ and *Pseudodatura*.³⁴ *Brugmansia candida*, the type of this group, is a synonym not of *Datura arborea* Linnaeus (pls. 8 and 9), but of *Datura arborea* Ruiz and Pavon (fig. 11), which is specifically distinct from the former and which, according to the rules of priority must take the name *Datura candida*.³⁵ Among the travelers and explorers who have called attention to the narcotic properties of these plants are de la Condamine, Humboldt and Bonpland, and Tschudi.

M. de la Condamine, while exploring the headwaters of the Rio Marañon in 1743, observed the use of a floripondio as a narcotic by the Omagua Indians inhabiting its banks. This plant he referred to *Datura arborea*, a species based by Linnaeus on a plant first described by Père Feuillée. Very closely allied to the latter is *Datura cornigera* Hooker, a species with the calyx terminating in a hornlike point. *Datura candida* has very much larger flowers, with the principal nerves of the corolla terminating in long taillike appendages between which the margin is entire or rounded, and not cordate or notched. Its fruit, moreover, according to Ruiz and Pavon (see fig. 11), has at its base the persistent husklike calyx, while in the true *Datura arborea* the calyx falls off with the corolla and the fruit is round and peachlike (pl. 9). In addition to the species of this group al-

³² Hernandez, ed. Matr., vol. 1, pp. 286, 287, 1790.

³³ Persoon, Syn., vol. 1, p. 216, 1805; Lagerheim, G., Monographie der ecuadorianischen Arten der Gattung *Brugmansia* Pers. 1895.

³⁴ Van Zijp, C., Natuurkundig Tijdschrift voor Ned. Indie., vol. 80, pp. 24-28, 1920.

³⁵ See Safford, W. E., A synopsis of the genus *Datura*, Journ. Wash. Acad. Sci., vol. 11, p. 182, 1921. See also Journal of Heredity (Washington), vol. 12, 1921.

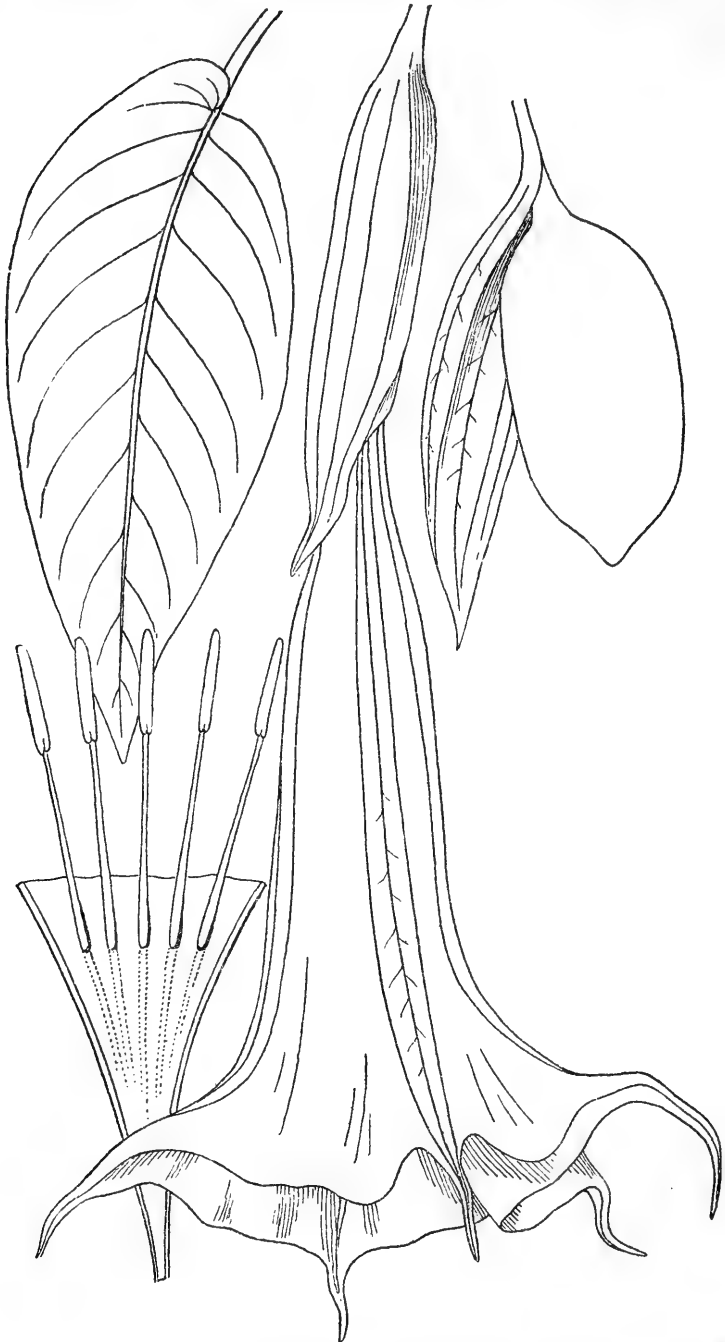

FIG. 11.—*Datura candida* Safford, the white-flowered tree-datura of Ruiz and Pavon, often confused with *D. arborea* of Linnaeus.

ready mentioned, several others, closely allied to *Datura arborea*, have been described, including *Datura aurea* Lagerheim, which bears beautiful golden-yellow flowers; *Datura dolichocarpa* (Lagerh.) and *D. versicolor* (Lagerh.), which have very long and slender fruits; *Datura suaveolens* H. & B., distinguished by its inflated five-toothed calyx and its coherent anthers, which has a spindle-shaped fruit (fig. 12); and *Datura pittieri* Safford, a Colombian species, with narrowly oblong fruit (pl. 10). Differing from the species mentioned above in their narrower corolla and short inflated calyx and also in their fruits, which have a persistent husklike calyx about the base, are two red-flowered daturas, one of which with entire upper leaves was described by Ruiz and Pavon under the name *Datura sanguinea*, while the other, with the upper leaves coarsely toothed and densely velvety, has been recently segregated by the writer under the name *Datura rosei*. Still another recently described red-flowered species, *Datura rubella* Safford, is readily distinguished from the preceding by the long caudate apex of its calyx.¹

DATURA SUAVEOLENS, THE ANGEL'S TRUMPET.

Plate 11.

The tree datura most commonly cultivated in conservatories is *Datura suaveolens*, a species often miscalled *D. arborea*. As stated above it can readily be distinguished by its coherent anthers and by its much inflated calyx, which never ends in a point but has several terminal teeth. Its chief distinction from *Datura candida* and *D. arborea* is the form of its fruit, which is spindle-shaped. (Fig. 12.)

This is the "fleur trompette" of the French Antilles. It is widely cultivated in the West Indies. Willdenow attributes its origin to Mexico, but all the herbarium specimens of tree daturas from Mexico seen by the writer belong to the species *Datura candida* (*Datura arborea* R. & P., not *D. arborea* L.). Fruiting specimens in the United States National Herbarium were collected in the Province of Minas Geraes, Brazil, by Regnell. That this species seldom produces fruit in cultivation is in all probability due to the absence of the humming birds or sphingoid moths by which it is pollinated in its natural habitat.

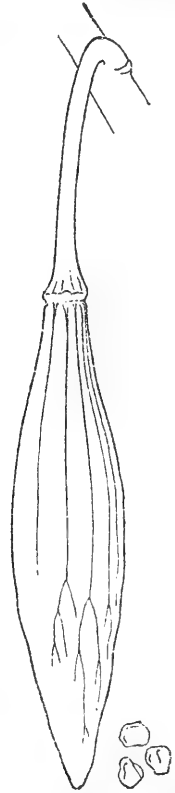

FIG. 12.—Spindle-shaped fruit of the Brazilian *Datura suaveolens*.

¹ See Journ. Wash. Acad. Sci., 11: 185, 188, 1921.

DATURA SANGUINEA, THE SACRED NARCOTIC OF THE TEMPLE OF THE SUN.

Plates 12 and 13.

Humboldt and Bonpland give an account of the use of a reddish-flowered *Datura* by the priests of the Temple of the Sun at Sagamoza, situated in the interior of what is now the Republic of Colombia. The narcotic prepared from it, locally called *tonga*, was declared by the natives of that region to be more efficacious than that prepared from the white-flowered *Daturas*. The following account of its use is given by Tschudi, who found it growing in the Peruvian Andes above the village of Matucanas:

The Indians believe that by drinking the *tonga* they are brought into communication with the spirits of their forefathers. I once had an opportunity of observing an Indian under the influence of this drink. Shortly after having swallowed the beverage he fell into a heavy stupor; he sat with his eyes vacantly fixed on the ground, his mouth convulsively closed, and his nostrils dilated. In the course of about a quarter of an hour his eyes began to roll, foam issued from his half-opened lips, and his whole body was agitated by frightful convulsions. These violent symptoms having subsided, a profound sleep of several hours succeeded. In the evening I again saw this Indian. He was relating to a circle of attentive listeners the particulars of his vision, during which he alleged he had held communication with the spirits of his forefathers. He appeared very weak and exhausted.

In former times the Indian sorcerers, when they pretended to transport themselves into the presence of their deities, drank the juice of the thorn-apple in order to work themselves into a state of ecstasy. Though the establishment of Christianity has weaned the Indians from their idolatry, yet it has not banished their old superstitions. They still believe that they can hold communications with the spirits of their ancestors, and that they can obtain from them a clue to the treasures concealed in the huacas, or graves; hence the Indian name of the thorn-apple—huacacachu, or grave plant.

Closely allied to *Datura sanguinea* Ruiz & Pavon, which Doctor Rose collected near Ambate, Ecuador, is a species with equally narrow corolla, but easily distinguished from that species by the dense soft hairs clothing its coarsely toothed leaves (fig. 13), younger branches and peduncles. Doctor Rose collected it in 1918, in the vicinity of Cumbe, Ecuador, noting that the flowers were of a saffron yellow color. It is undoubtedly identical with the plant which Lindley figured under the name *Brugmansia bicolor* (Bot. Reg. 20, t. 1739, 1834), believing it to be the plant so called by Persoon (Synops., 1, 216, 1805). The latter, however, is a synonym of the true *D. sanguinea*, and is a pubescent (not woolly) plant with entire leaves.

This species I have named *Datura rosei*, in honor of Dr. J. N. Rose of the United States National Herbarium. Lagerheim, who mistook it for *D. sanguinea*, states that in the vicinity of Quito it is called

Huantuc, and that its seeds are used to make the fermented *chicha* of the natives more intoxicating. Its pollination, he states, is accomplished in certain localities through the agency of a humming bird, *Docimastes ensifer*.



FIG. 13.—Leaves of the (a) red-flowered *Datura sanguinea* Ruiz and Pavon and (b) *D. rosei* Safford.

Specimens of the true *Datura sanguinea* Ruiz & Pavon, quite distinct from the woolly-leaved plant, so called by Lagerheim and other authors, were collected in the Peruvian Andes in 1915 by Mr. O. F. Cook, to whom I am indebted for much valuable information regarding plants belonging to this genus. It grows in the form of a tree

somewhat smaller than the white-flowered *Datura arborea* L. and having a very different appearance from that species, with a more open habit, narrower leaves, and scarlet-and-orange flowers. At Ollantaytambo it is locally known as *Puca Campancho*, *puca* being the Quichua word for "red." Here it flowers abundantly, beginning in May. About the middle of July only a single small fruit of this species could be found in this locality, while trees of *Datura arborea* were bearing an abundance of fruit. Higher up, however, in the pass of Panticalla above Piñasñiocj, at an altitude of 12,000 feet, where there was frost every night, trees were found fruiting abundantly, showing it to be a hardy species, likely to grow in such localities as the California coast region. On plate 12 are shown specimens of flowers of this species collected by Mr. Cook, with leaves and peduncle pubescent but not densely woolly as in *Datura rosei*, and with the blades of the leaves entire instead of coarsely toothed or notched. On plate 13 are two fruits of the same species, the smaller collected by Mr. Cook at Ollantaytambo at an altitude of 9,500 feet, the larger at Piñaneñiocj at an altitude of 12,000 feet.

It is not strange that the tree daturas above described, with their pendulous indehiscent fruit so very different in form from the erect four-valved capsules of *Datura stramonium*, should have been regarded as a distinct genus (*Brugmansia*) by botanists who were unfamiliar with the other groups. This proposed genus "differs from *Datura* in its treelike stem, its persistent longitudinally cleft calyx, at length quite deciduous, its two-celled ovary and unarmed indehiscent fruit."³⁶ As a matter of fact, in most of the species, including *Datura arborea* (pl. 9), *D. suaveolens* (fig. 12), and *D. pittieri* (pl. 10) the calyx is not persistent; in *D. suaveolens* (pl. 11) it is five-toothed at the apex and not split more than in *D. meteloides* (pl. 4); while in *Datura sanguinea* (pl. 13) it persists until the fruit is quite ripe and is never deciduous. As for the ovary, it is really two-celled in all species of *Datura*. The fruit of *Datura ceratocaula* (fig. 10) is both unarmed and indehiscent, and none of the fruits of the section *Dutra* (pls. 1, 2, 3) are really dehiscent, but break up irregularly when quite mature.

It therefore follows that the tree daturas of South America can not be separated as a distinct genus on account of their split or deciduous calyx, their two-celled ovary, or their spineless indehiscent fruit. As for the essential parts of the flowers and the forms of the corolla they do not differ from those of other sections of *Datura*, with which they are connected by the marsh-loving torna-loca (*Datura ceratocaula*) of Mexico.

³⁶ Lagerheim, G., in Engler's Jahrb., vol. 20, p. 662, 1895.

SUMMARY.

1. The family Solanaceae includes a number of narcotic plants, some of them of Old World origin, others belonging to the New World, which have been used from remote antiquity as intoxicants and medicines.

2. These plants owe their virtues to certain midriatic alkaloids, principally to atropine, hyoseyamine, and scopolamine, to which may be added the more recently discovered solandrine, or nor-hyoseyamine.

3. Perhaps the most remarkable feature in connection with these plants is the independent discovery in remote parts of the world of their remarkable hypnotic effects, which have been attributed to magic, or to supernatural agencies, and have caused them to be regarded with dread.

4. Scarcely less remarkable is the independent utilization of distinct species in both the Old World and New in religious ceremonials, especially in oracular divination, in the discovery of hidden objects, and the foretelling of future events.

5. The shortage of certain imported medicines during the recent war has resulted in the cultivation of some of our own plants, especially the common *Datura stramonium*, as the source of a substitute for atropine. Other solanaceous plants of both North and South America might be similarly utilized.

6. The use of endemic plants of America by the magicians and medicine men of various native tribes illustrates, in the most striking manner, the process of discovering the virtues and the utilization of plants of primitive people, and throws valuable light upon the early history of magic and medicine.

7. After a careful study of all the species of *Datura* it does not seem advisable to separate the floripondios, or tree-daturas of South America, from the rest as a distinct genus.

8. For a classification of the daturas and descriptions of new species mentioned in the present paper the reader is referred to Synopsis of the Genus *Datura*, in the Journal of the Washington Academy of Sciences, vol. 11, pages 173-189, 1921.

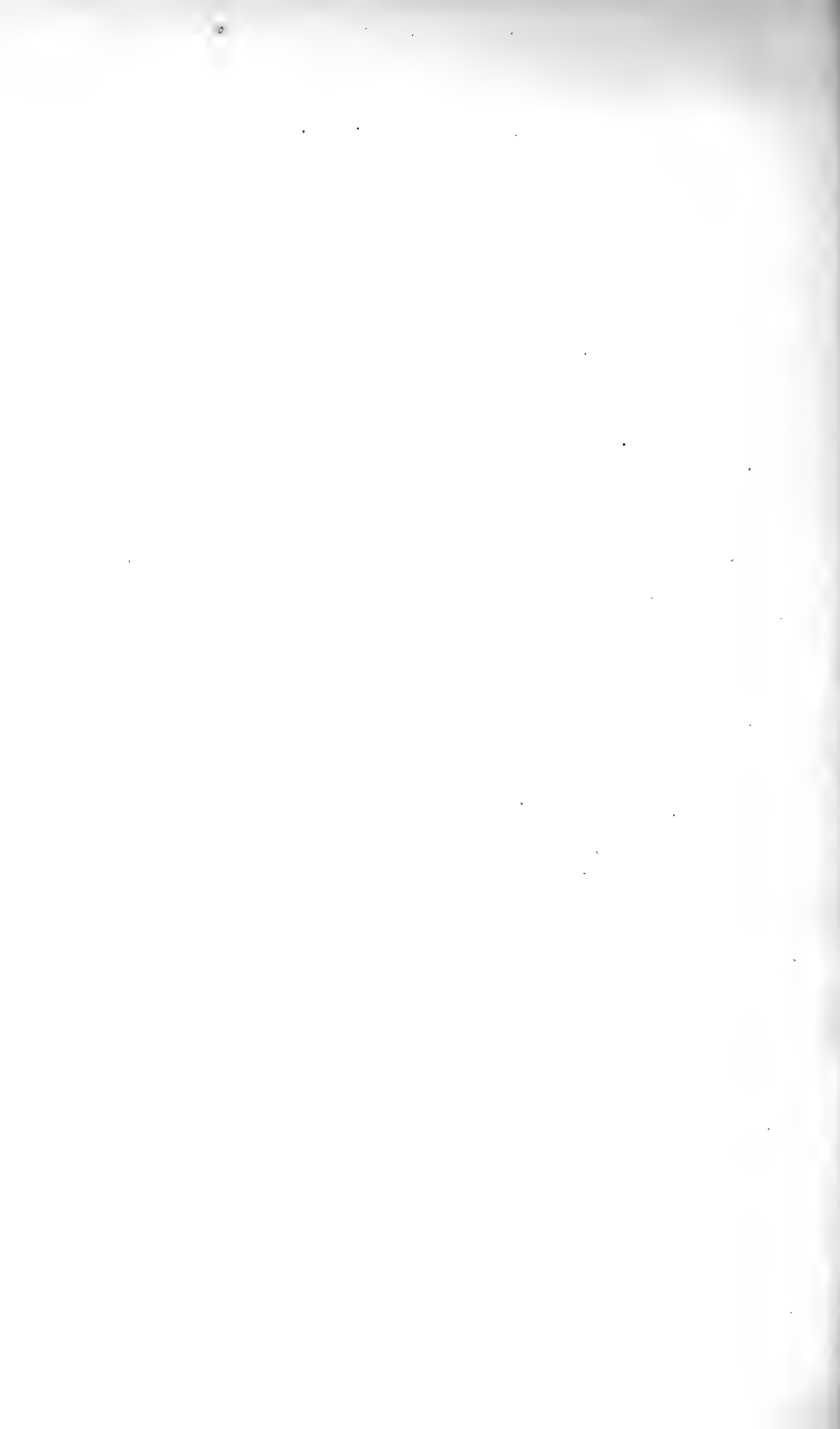



THE NARCOTIC METEL NUT OF THE ARABS.

Specimens in the U. S. National Museum.



DOUBLE-FLOWERED FORM OF DATURA METEL L., COMMONLY CALLED *D. FASTUOSA*.



THE DOWNY THORN-APPLE OF MEXICO, *DATURA INNOXIA* MILLER.



THE AMERICAN DATURA METELOIDES DUNAL, USED AS A CEREMONIAL PLANT BY ABORIGINES OF MEXICO AND THE SOUTHWESTERN UNITED STATES.

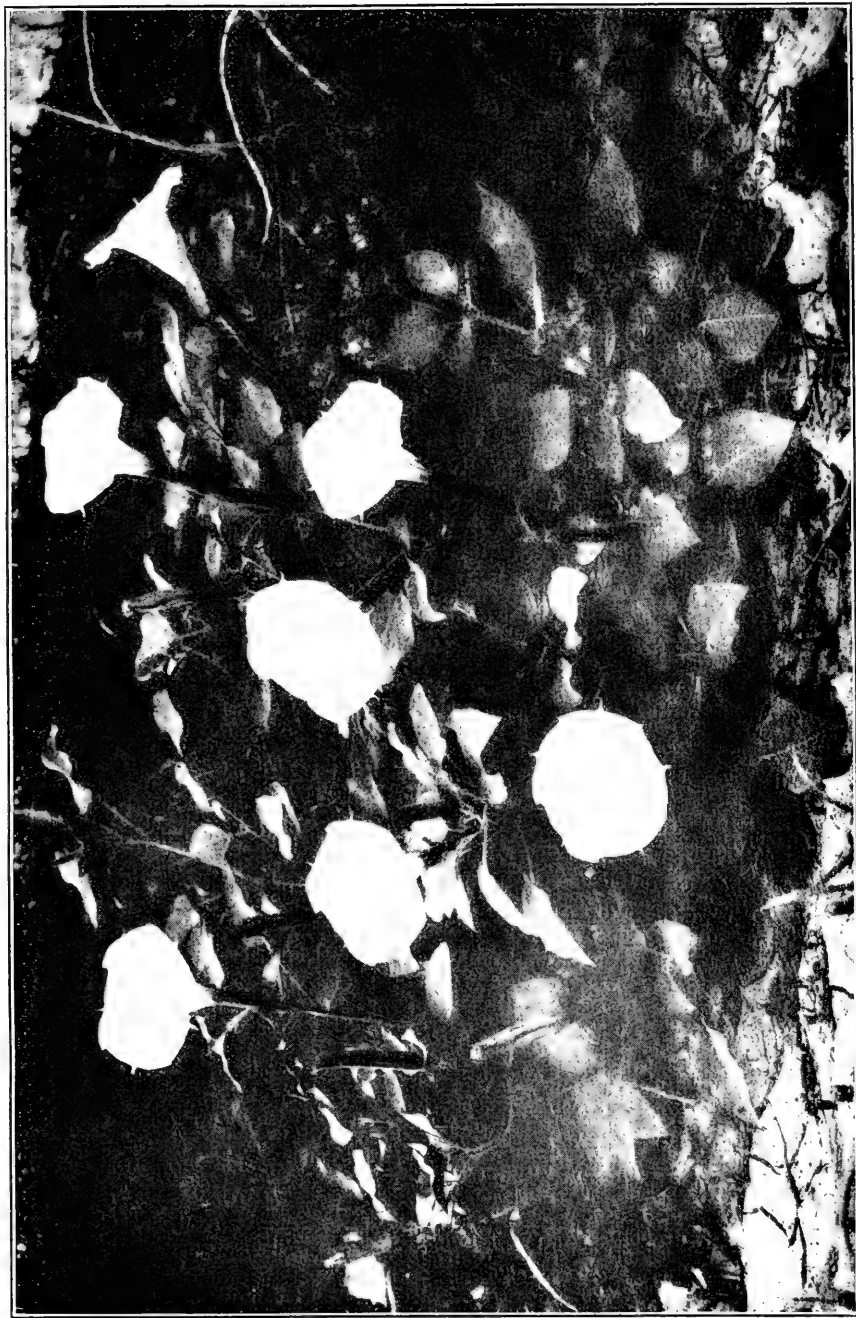

THE PURPLE-STAINED TOLOACHE, DATURA DISCOLOR BERNH.

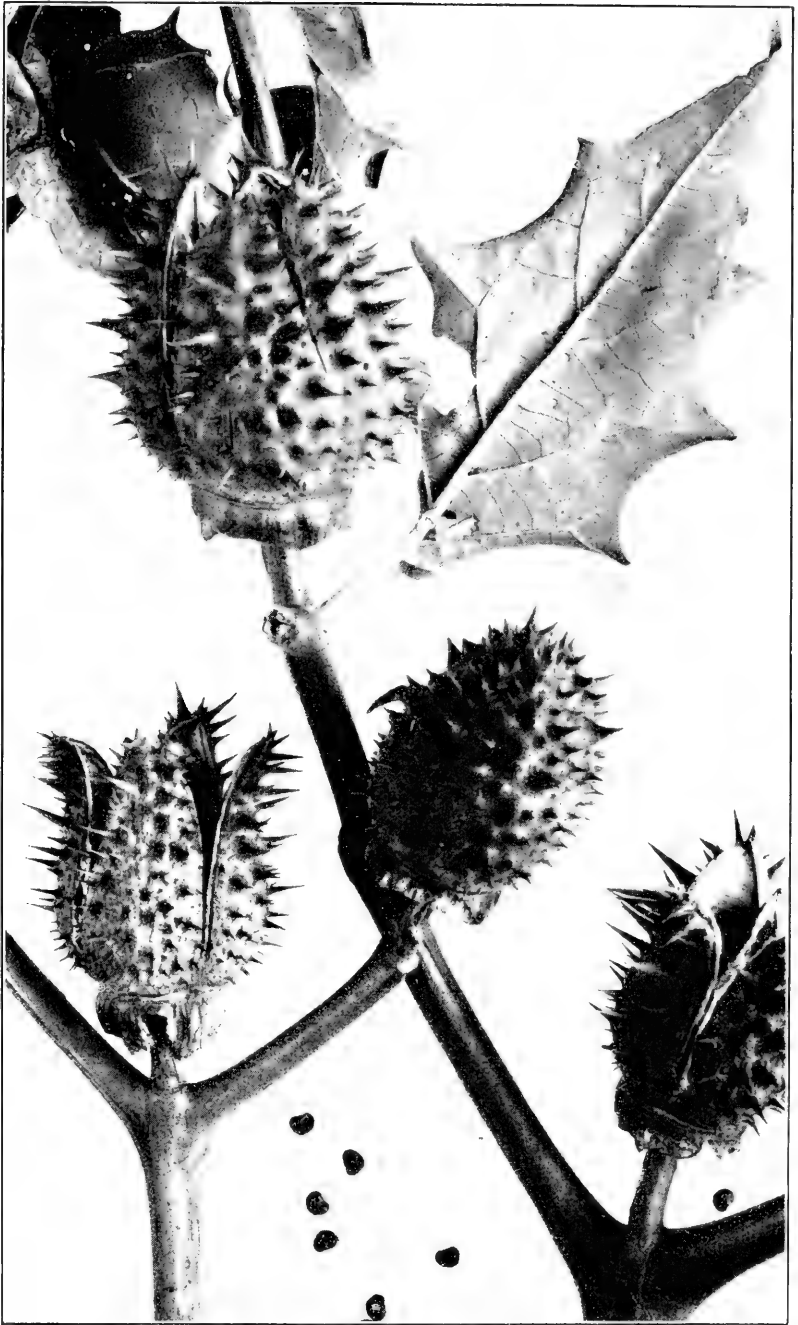

THE JAMESTOWN WEED, *Datura stramonium* L., A POWERFUL NARCOTIC OF THE ALGONQUIN INDIANS.



A CLIMBING DATURA, SOLANDRA HARTWEGII, CALLED TECOMAXOCHITL BY THE AZTECS.

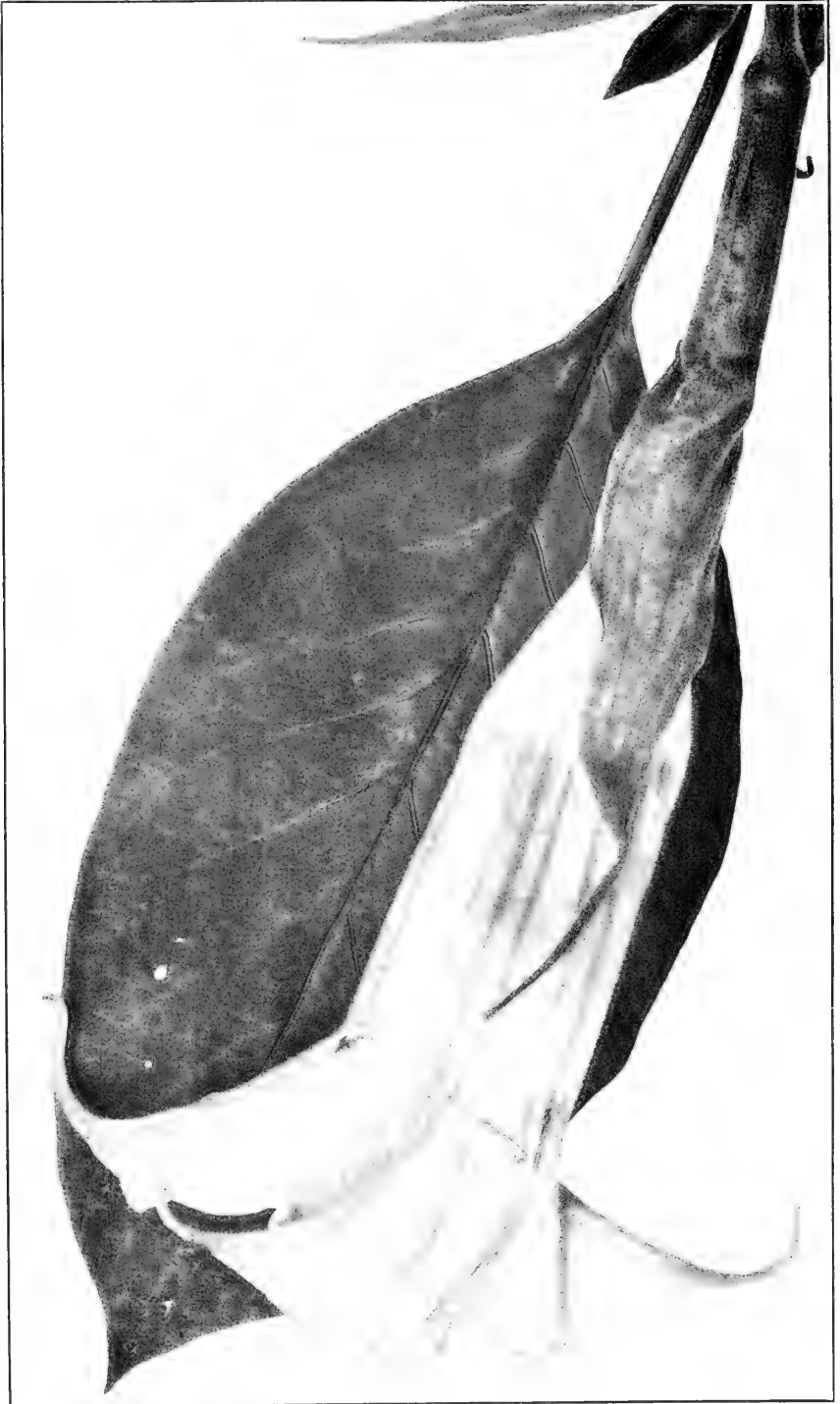

THE TRUE DATURA ARBOREA L., OF SOUTHERN PERU.



FRUIT OF *DATURA ARBOREA* L., QUITE DEVOID OF A CALYX.

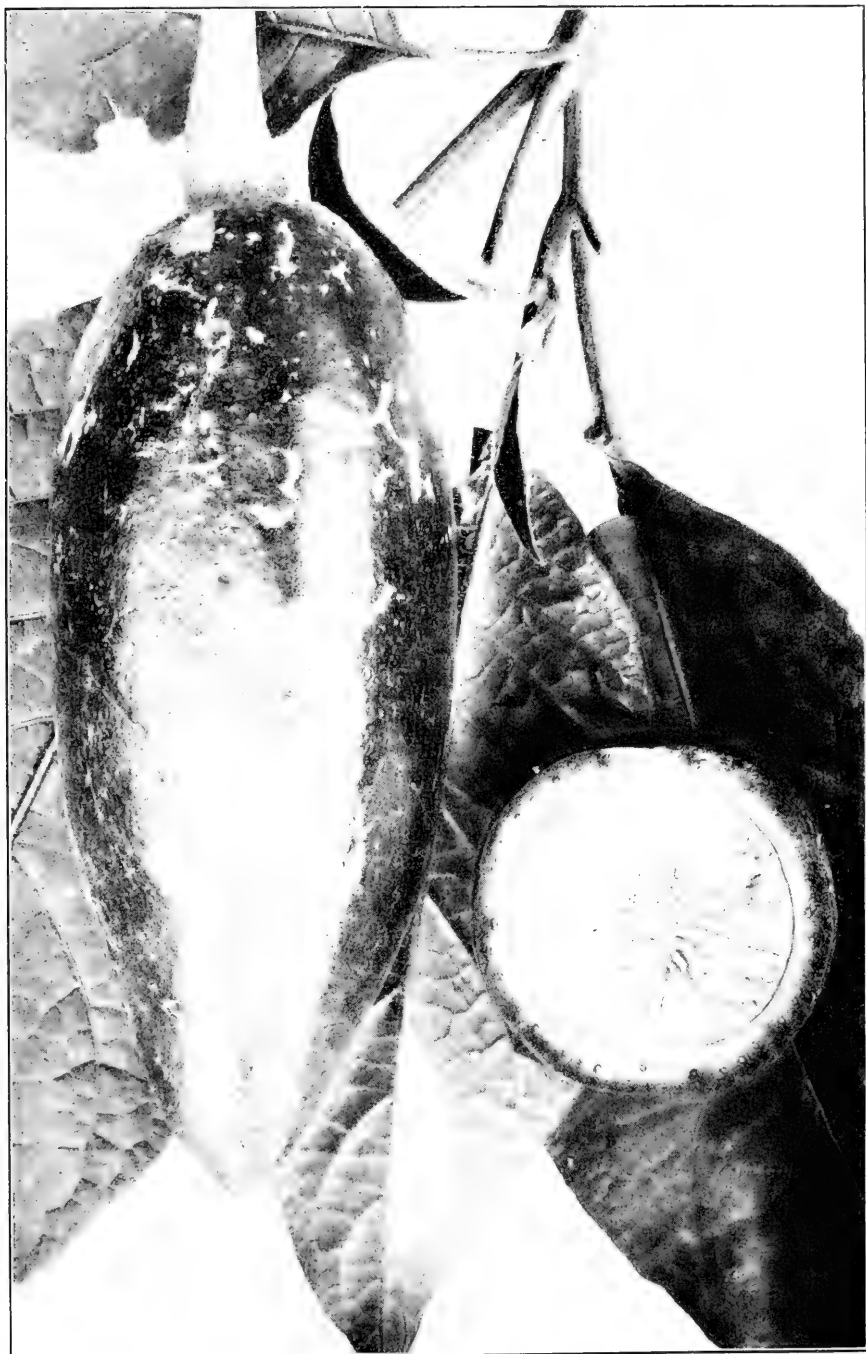

FRUIT OF THE COLUMBIAN *DATURA PITTIERI* SAFFORD.



THE ANGEL'S TRUMPET, *DATURA SUAVEOLENS* R. & P., A PLANT OF BRAZILIAN ORIGIN.



THE INTOXICATING TONGA PLANT, *DATURA SANGUINEA* R. & P.

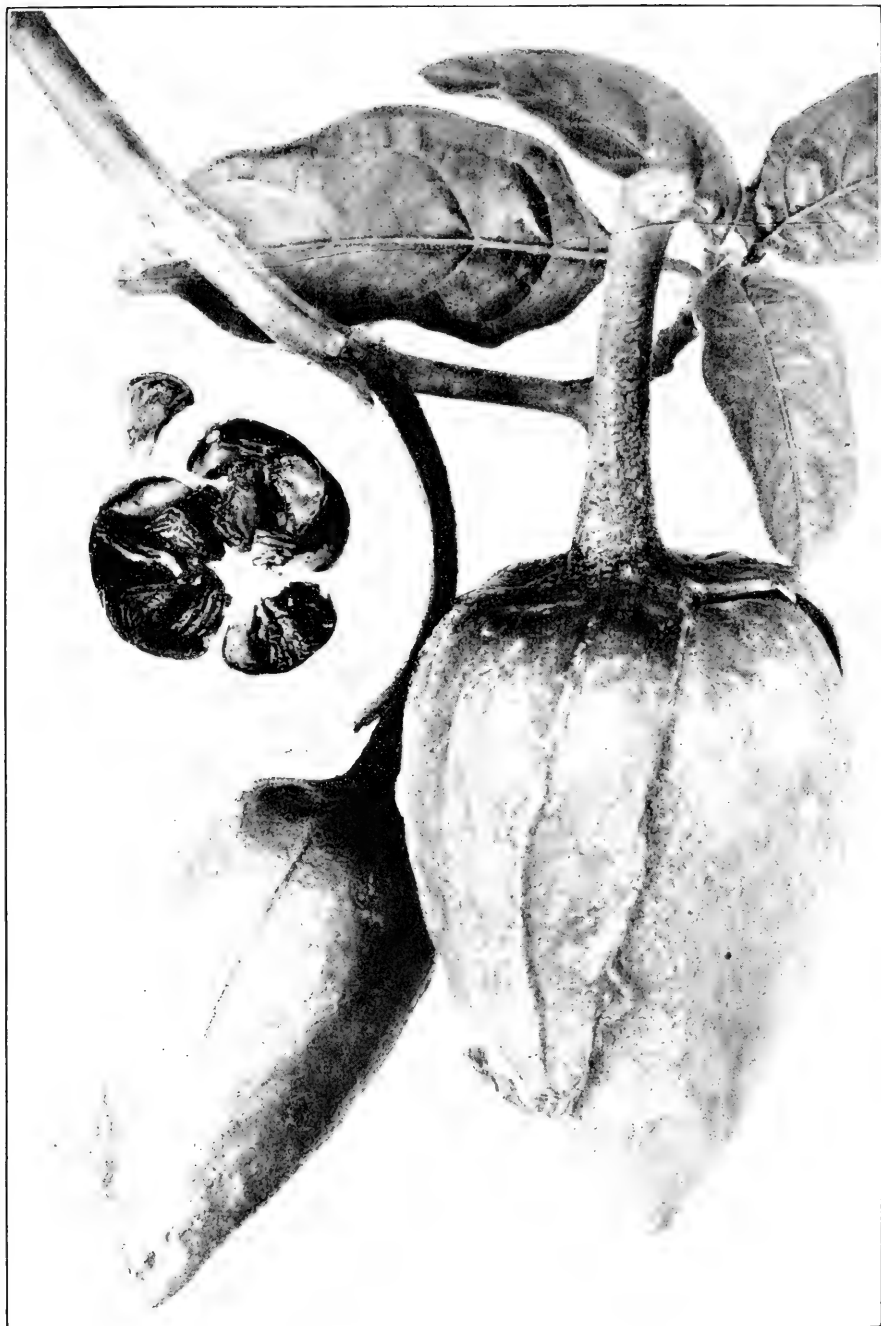

FRUITS OF *DATURA SANGUINEA* R. & P. WITH PERSISTENT CALYX.

Used as a narcotic by priests of the Temple of the Sun.

EFFECT OF THE RELATIVE LENGTH OF DAY AND NIGHT ON FLOWERING AND FRUITING OF PLANTS.

By W. W. GARNER and H. A. ALLARD,
Physiologists, United States Department of Agriculture.

[With 17 plates.]

One of the marvels of nature is the transformation of the green, growing shoot of the plant into the blossom, closely followed, as a rule, by the appearance of the fruit. As everyone knows, flowers are to be found in an endless variety of shape, size, and color, and the fruits which follow are equally varied in form and color. Those who systematically observe this profusion of form and coloration in flower and fruit are almost led to conclude that nature has pretty well exhausted the possibilities, even if no account be taken of the countless numbers of plant forms appearing in the past which, for various reasons, were unable to maintain the struggle for existence, having been lost in the process of evolution leading up to the plant world of to-day. Another striking feature of flowering and fruiting is that each species as a rule reaches these stages of development at certain definite periods of the year, so that the flowering of certain plants comes to be closely identified with each of the seasons. On the other hand, there is no single season in which plants as a whole flower and fruit. Some are in flower and maturing fruit during every month of the year, except possibly under extreme conditions of climate. Again, some plants flower and fruit within a few weeks after the seed germinate, while others may require 25 or 50 years or even longer to attain the flowering stage. Moreover, it is well known that the general type of vegetation, including various features of flowering and fruiting, undergoes marked changes as one proceeds northward or southward from the Equator. Finally, it often happens that transfer of a given species northward or southward leads to important changes in its usual flowering and fruiting habits.

It seems unnecessary to dwell upon the fact that the development of flower and fruit is of the greatest importance to the plant, for in many instances, particularly in the large group known as annuals,

propagation by seeds constitutes the sole method of perpetuating the species. Indeed, the typical course of development of these plants is such that it was formerly believed all other activities are merely preliminary or incidental to the successful accomplishment of seed development or sexual reproduction. This suggestion implies that flowering and fruit formation simply express inherent properties of the living protoplasm, without special intervention of the environment, provided only that conditions of temperature, moisture, light, and soil reasonably favorable to plant growth are supplied. The present-day plant physiologist, however, recognizes that the plant merely inherits capacity to respond in definite and specific manner to given conditions of its environment, rather than that development must be along fixed lines in spite of differences in environment. Still, it must be admitted that until recently little was known as to the factors of the environment which actually control flowering and fruiting.

In the light of the above-mentioned considerations one naturally would be led to conclude that although the internal changes involved in flower and fruit formation are very profound and complex in character, these processes can not be regarded as proceeding in a fixed course independently of environmental influences. It is apparent that any satisfactory explanation of underlying causes and the mechanism of the internal processes whereby the green shoot is transformed into flower and fruit must take into account a number of striking features of development which are associated with this change in activity. Among these are the multiplicity of forms evolved, the marked periodicity in occurrence of flowering and fruiting in the individual species, but decided diversity in the annual flowering seasons of different species, differences in time required for reaching these stages of development in different species and changes in the behavior of a particular species when transferred northward or southward. It is the purpose of this article to show that the relative length of day and night is an external factor which may largely determine whether a given plant is able to flower and develop fruit in any particular region and in any particular season of the year, and that, consequently, the prevailing seasonal length of day in any region may greatly influence the character of its vegetation, barring, of course, the effects of special and purely local conditions, such as absence of rainfall.

PECULIAR BEHAVIOR OF CERTAIN VARIETIES OF SOY BEAN AND TOBACCO WHEN GROWN AT DIFFERENT SEASONS OF THE YEAR.

The soy bean (*Soja max* (L) Piper) is a leguminous summer annual of great value as a farm crop for improving the soil, for the production of food for live stock, and as a source of vegetable oil.

There are numerous varieties of soy bean, some of which can be successfully grown only in southern latitudes, because in more northerly regions they are killed by frost before the seed can be matured. Thus the variety known as Biloxi when planted as early as April in the latitude of Washington, D. C., does not begin to flower till September, although certain other varieties under the same conditions will show open blossoms early in June. Experimental plantings of the Biloxi made at Washington in April have required 125 days to reach the flowering stage, while similar plantings of the Mandarin variety required less than 40 days. A peculiarity of the Biloxi is that as successive plantings are made through the spring and summer the number of days required to attain the flowering stage is markedly reduced, and plantings made as late as August 5 have required only 55 days to flower, while the Mandarin shows no such shortening of the vegetation or growing period. The Biloxi shows this peculiarity each year in spite of decided differences in temperature and rainfall which occur in the different years. Why this marked shortening in the growing period of the Biloxi as the season advances? The potential advantage of the response to the advancing season is readily seen, for curtailment of the growing period materially favors the ripening of seed before cold weather, and therefore tends to increase the northward range of the plant. A distinction must be made here, however, between advantage and cause. To assign the danger of destruction by cold as a cause of the speeding up of flower and seed formation would be to assume that the plant is able to anticipate the advent of cold weather and to modify its course of development accordingly. Before considering further this response of the Biloxi soy bean to the advance of the summer season it will be of interest to review briefly the somewhat similar behavior of a variety of tobacco (*Nicotiana tabacum* L.) known as Maryland Mammoth.

The Maryland Mammoth tobacco differs from its parent type, Maryland Narrowleaf, in that when grown in Maryland during the summer months the plant continues to increase in height without flowering till October or November or until killed by cold weather. The parent type produces about 25 leaves per plant while the Mammoth may produce more than 100 leaves. If the plant is transferred to the greenhouse in the fall, growth will continue till November, when flowering occurs. If seedlings are propagated during the winter months they invariably flower without growing larger than the ordinary varieties of tobacco. Finally, while the primary and axillary shoots developing during the winter and early spring invariably flower without delay, there comes a time in the spring when the new shoots of the plant assume the summer type of growth—that is, they continue to grow indefinitely without flowering. Thus,

we have in the Maryland Mammoth tobacco a plant which shows a nonflowering type of development during the summer months, attaining giant proportions, while during the winter months this tobacco invariably flowers and does not grow any larger than other tobaccos. Again, the question may well be raised as to the cause of this striking difference in behavior of the Maryland Mammoth tobacco when grown in the summer or in the winter, a difference not shown by most varieties of tobacco. Differences in temperature can not be regarded as a factor, for the greenhouse may be kept as warm during the winter as the outside air of the summer months, but this in no wise interferes with the flowering of the tobacco, so that one must seek elsewhere for the cause of the difference in the winter and summer behavior of the Mammoth tobacco.

There is really no fundamental difference between the Biloxi soy bean and the Maryland Mammoth tobacco as regards their behavior when grown at different seasons of the year. Normally, neither flowers during the summer months in the latitude of Washington, while both flower readily during the fall and winter months. Having excluded temperature difference as a possible cause of this behavior sunlight naturally presents itself for consideration. It has long been known that sunlight is one of the indispensable factors in plant growth, and it is obvious that outside the Tropics the light conditions change decidedly as the season advances. In midsummer when the path of the sun across the sky is at its highest the total intensity of the light to which the plant is exposed during the middle of the day may reach 10,000 foot-candles, but in the winter the mid-day light intensity is scarcely half as great. A series of experiments was carried out with soy bean, using specially constructed shades of cloth to reduce the intensity of the sunlight falling upon the plant. Two types of shade were used in the tests, as shown in plate 1. Loosely woven cotton netting of five different weaves was employed in shading the plants in order to secure suitably graduated reduction in light intensity. The five grades of netting, one of which was the standard cheesecloth extensively used for surgical dressings, are shown in natural size in plate 2. The degree of the shading effected varied, of course, with the changing angle of the sun at different hours of the day. The reduction in the intensity of the direct sunlight at noon ranged from about 30 per cent of the total for the most open-mesh cloth to more than 65 per cent of the total for the closer woven netting. These values do not take into account the diffuse light reaching the plants, but it is obvious that the total light intensity was greatly reduced where the denser grades of netting were used. Though the soy bean plants were affected in other particulars by the shades, the date of blooming as compared with that of plants grown without any shade was

neither advanced nor delayed by a single day. Similarly, it was observed that the Maryland Mammoth tobacco is not affected by shading so far as concerns date of flowering. We conclude, therefore, that change in the intensity of the sunlight as the season advances is not the factor which hastens flowering and fruiting in the Biloxi soy bean and the Mammoth tobacco. As a matter of fact, the intensity of the sunlight varies each day from zero just before the beginning of dawn to a maximum at noon, after which it again declines to zero at the end of twilight in the evening. Moreover, periods of relatively dark, cloudy weather of variable but considerable duration occur at irregular intervals during the growing season in many sections. It is hardly to be expected, then, that seasonal changes in light intensity would be a factor of importance in such features of plant development as the sharply defined annual periodicity in time of flowering and fruiting shown by soy bean and tobacco, as well as by most other plants when grown outside the Tropics.

EFFECT OF SHORTENING THE DAILY ILLUMINATION PERIOD ON THE DEVELOPMENT OF SOY BEAN AND TOBACCO.

Having seen that changes in temperature and in the intensity of the sunlight do not hasten flowering and fruiting of soy bean and tobacco as the season advances, we next turn to another feature of periodicity related to change of season, namely, the relative length of day and night. In the latitude of Washington, D. C., practically 15 hours elapse between sunrise and sunset during the longest days of the year, which occur, of course, during the latter part of June, while during the latter part of December there are only about nine and one-half hours between sunrise and sunset. Beginning with the first part of July the length of day decreases by slightly less than one minute daily. This rate of decrease becomes steadily larger until the end of September, when it is considerably more than two minutes per day, while from that time till the winter solstice the rate of decrease steadily declines. The change in the length of the day at Washington during the principal growing season for plants is shown in figure 1.

To ascertain whether the seasonal change in the length of the day is in any way responsible for the peculiar behavior of soy bean and tobacco under discussion it was decided late in the summer of 1918 to make a simple experiment with these plants. A small, ventilated, light-proof chamber was constructed into which boxes containing soy bean and tobacco plants could be placed for a time each day, so as to reduce the number of hours of sunlight received by the plants. This dark chamber is shown in plate 3. In practice the cultures of soy bean and tobacco were placed in the dark chamber

at 4 o'clock in the afternoon each day and again withdrawn at 9 o'clock the following morning. The plants thus received only seven hours of light daily, while, for comparison, other similar cultures were left exposed to the light throughout the day. In the first tests a variety of soy bean known as Peking, which flowers earlier than the Biloxi, was used and the plants were placed in the dark chamber for the first time on July 10, at which date they had just begun to blossom. The Maryland Mammoth tobacco plants, which had been planted April 14, also were first placed in the dark chamber on July

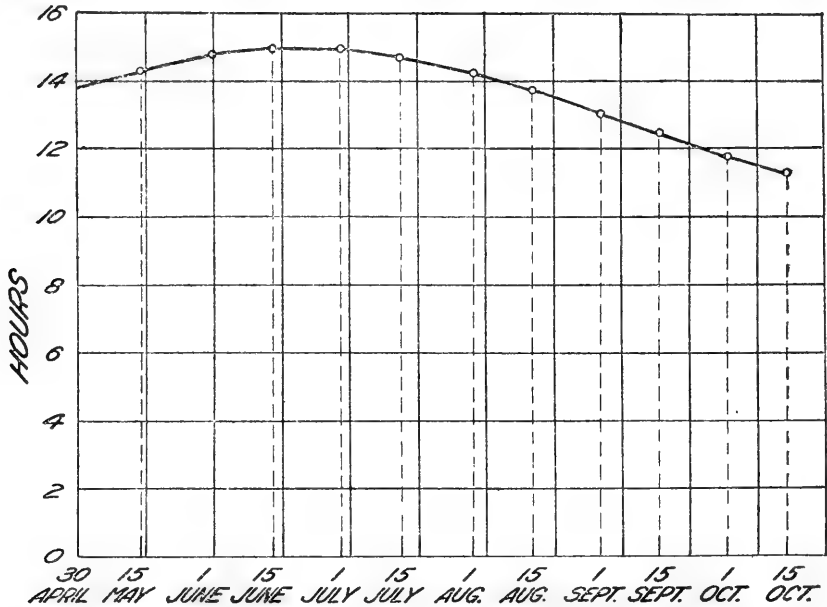

FIG. 1.—Graph showing changes in length of day during the growing season in the latitude of Washington, D. C. Ordinates indicate 2-hour intervals of the day and abscissae indicate 16-day periods of the growing season.

10. In a short time it became evident that both soy bean and tobacco were responding to the artificially shortened length of day. Before the end of July the seed pods of the soy bean were full grown, while on the control plants remaining out of doors none of the pods were more than half grown. By September 1 the leaves of the test plants had yellowed and were falling and many seed pods were fully matured, while both leaves and seed pods on the control plants were still green. The appearance of the two sets of soy bean are well shown in plate 4. The tobacco plants exposed to the shortened day length began to flower August 26, while the first blossoms appeared on the control plants remaining out of doors on October 7. These results were so striking that arrangements were made for much more extensive tests in 1919 with soy bean and tobacco, as well as with many other species.

For these experiments a much larger dark house was constructed, special provision being made for ventilation without admission of light. A series of steel tracks, each entering the dark house through a separate door, was provided; and on these tracks were placed a number of trucks arranged for supporting the test plants in their containers. In this way each series of plants could be conveniently transferred into the dark chamber and out again as often as desired. A general view of the dark house and the steel trucks bearing the test plants is afforded by plate 3. In these later tests four varieties of soybean differing in time of maturity were used, as follows: Mandarin, flowering and maturing early in the summer; Peking, somewhat later than Mandarin; Tokyo, rather late in flowering and maturing; Biloxi, a very late variety, as already pointed out. In addition to the Maryland Mammoth, another commercial variety of tobacco known as Connecticut Broadleaf and a variety of *Nicotiana rustica* were used in the experiments. The former results were fully confirmed and also were considerably extended. When allowed to receive only 12 hours of sunlight daily Biloxi soy bean planted in May and early June was in blossom within four weeks after germination, whereas the control planting out of doors did not begin to flower till about the second week in September or nearly four months after germination. Similarly, the Tokyo flowered in about 25 days when exposed to 12 hours of light daily, while the control plants began to bloom in August, about 65 days after germination. The Peking blossomed in about three weeks under the 12-hour exposure and the control plants blossomed during the latter part of July, about 50 days after germination. The Mandarin flowered in three weeks under the 12-hour light exposure and in four weeks under the full summer length of day. It is perfectly clear that the later the variety of soy bean in maturing the greater is the effect of the artificially shortened day-length in hastening the appearance of flowers. This, of course, is just what would be expected if the decrease in length of day as fall approaches is really responsible for the fact that the period between germination and flowering of late varieties is progressively shortened as plantings are made later and later through the summer. In other words, late varieties will not flower and fruit till exposed to shorter days than occur in midsummer.

The Maryland Mammoth tobacco when exposed to 12 hours or less of sunlight daily behaved just as it did in the earlier experiment. The Connecticut Broadleaf and the variety of *Nicotiana rustica* used in the test, however, did not show any decided response to the shortened length of day. It thus appears that the Mammoth tobacco, like the late varieties of soy bean, will not flower and fruit in midsummer, as a rule, because of the excessive length of the day. The effect of shortening the day-length is shown in plate 5.

In additional tests with the above-mentioned varieties of soy bean it was found that further decrease in the length of the day, even to as low as 5 hours, had practically no greater effect than the 12-hour day in forcing the plants into flowering and fruiting. On the other hand, the rate of growth was found to be directly proportional to the length of the day and, as a consequence, the size attained by the plants at the time of flowering was materially reduced by shortening the length of the daily light period below 12 hours. The action of the artificially shortened day in forcing early flowering and fruiting as well as in reducing the size attained by the plants is well shown in plates 6, 7, 8, and 9.

Another experiment with soy bean gave interesting and rather unexpected results. The length of the daily exposure to light was reduced by transferring the plants to the dark house at 10 a. m. and returning them to the sunlight at 2 p. m. The plants thus really received two periods of illumination daily, the total daily exposure to sunlight through the summer and autumn being 11 to 8½ hours. Under these conditions the plants behaved about the same as those remaining in sunlight throughout the day, or, in other words, the noon "siesta" was without effect in hastening the formation of flowers and seed. This is in striking contrast with the effect produced when the length of day is shortened by cutting off the sunlight in the morning and afternoon, as is clearly shown in plate 9, figure 2. The most likely explanation would seem to be that internal processes set up through the action of the morning sunlight continue in operation through the greater portion of the artificially darkened noon period, the effect thus being about the same as if the plants had remained in the light throughout the day.

RELATION BETWEEN EARLY-MATURING AND LATE-MATURING VARIETIES OF SOY BEAN.

To secure varieties of various useful plants adapted to the various regions of the country and to secure different varieties of many of these plants adapted to the different seasons of the year in any given region are among the chief problems of the plant breeder and the plant introducer. Hence it is important to arrive at a correct understanding of the relation between early and late maturing varieties in so far as difference in behavior is directly attributable to response to external conditions. The soy bean is admirably adapted to throw light on this subject. It has already been pointed out that of different varieties of this plant which, when planted in the spring, require all the way from a month up to more than 100 days to reach the flowering stage, all can be made to blossom within three or four weeks by properly shortening the length of the day. It is at once seen that if this behavior holds true under natural conditions in the field

it throws a great deal of light on the underlying cause of difference in varieties as to their adaptation to different latitudes. To test this point a series of plantings at approximately three-day intervals throughout the spring and summer were made of the Mandarin, Peking, Tokyo, and Biloxi varieties of soy bean, and careful watch for the first appearance of blossoms on each planting was maintained. It is obvious that as the summer advances the successive plantings will be exposed to shorter day-lengths and the time elapsing between germination and the arrival of a length of day of, say, 12 hours, will become progressively less. The fact that the duration of the vegetative period which precedes flowering is progressively shortened as the season advances has already been sufficiently emphasized in the case of the very late variety, Biloxi, but consideration of the comparative behavior of early and late varieties under different lengths of day leads to such important conclusions as to justify further discussion. The remarkable differences in the response of the Mandarin, Peking, Tokyo, and Biloxi varieties to external factors connected with advance of the season are graphically shown in figure 2. The outstanding feature is that the curves showing the number of days required by the different varieties to reach the flowering stage show a striking tendency to converge as the plantings are made later and later through the season. The time required by the Biloxi to reach the flowering stage is shortened most by advance of the season while the Mandarin is affected least. It appears from a study of figure 2 that if plantings could be made late enough in the season without interference by cold weather or other factors a point would be reached where all varieties would require the same length of time to reach the flowering stage, namely, about 25 days. Now, by referring back to page 575 it will be seen that this is exactly the result obtained in midsummer when temperature and light intensity are at their highest, simply by exposing all varieties to a day-length of 12 hours or less. Thus there seems to be no doubt but that speeding up of flower and fruit formation with advance of season is due to the decrease in length of day, and changes in temperature and the intensity of the light play only a subordinate rôle in this phenomenon. If earlier flowering and fruiting of the later plantings are to be considered as due to approach of cold weather, it must at least be admitted that the plants may be easily fooled in the matter.

Returning to the differences in behavior of early and late maturing varieties, we reach the important conclusion that if grown in the Tropics where the length of day is not far from 12 hours throughout the year these differences between early and late varieties would largely disappear. Conversely, varieties or strains which mature at the same time in the Tropics might readily show marked differ-

ences in time of maturity when carried into temperate regions where decided seasonal change in length of day occurs. This, in fact, has proved to be the case in a number of instances where seed of tropical plants have been brought into this country. Thus it may happen that a culture which seems to consist of a pure variety as grown in the Tropics, can be readily separated into two or more

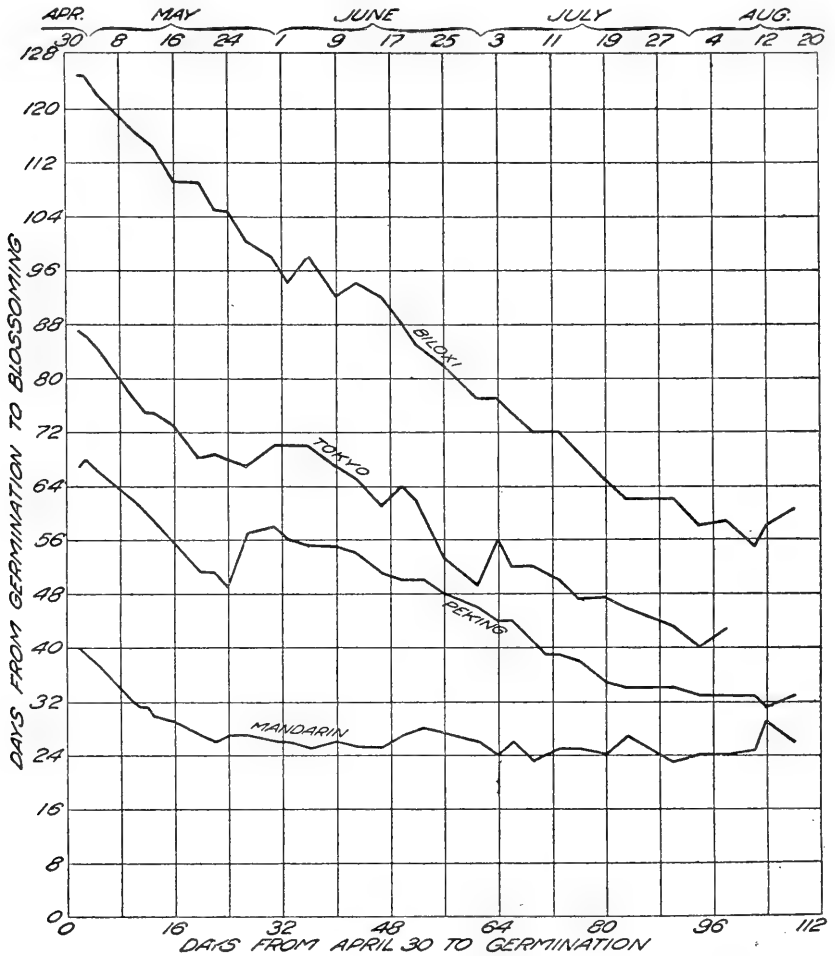

FIG. 2.—Graph showing the shortening of the vegetative period preceding flowering in soy bean which results from progressively later planting during the growing season.

distinct strains or varieties when grown in higher latitudes, these new forms showing marked differences in time of maturity. In high latitudes an early-maturing variety of soy bean is one which flowers and fruits under the influence of long days, while a late variety flowers and fruits in response to short-day influences. That these relationships have an important bearing on problems in plant breeding is evident.

RESPONSE OF OTHER PLANTS TO REGULATED LENGTH OF DAY.

Artificial control of the length of day has now been applied to a large number of flowering plants, and it has been found to be an important factor of very wide application in flowering and fruiting. It is not to be expected that all plants would respond in the same way or to any particular length of day. On the contrary, there is the greatest diversity of response in different species and varieties to seasonal change in day length. Additional examples of plants behaving like soy bean and the Maryland Mammoth tobacco, which flower as a result of decrease in length of day, may be first considered. The common wild aster, *Aster linariifolius* L., which normally begins to flower about September 1, may easily be made to blossom in June by artificially shortening the day to 12 hours or less, as shown in plate 6. Like the soy bean and tobacco, the aster is not forced into early flowering by interposing a period of darkness in the middle of the day, even though the total number of hours of sunlight daily is thereby reduced to as low as 10. A variety of bean (*Phaseolus vulgaris* L.) imported from the Tropics began to blossom October 11, 109 days after germination, when grown under the full length of day. When given only 7 hours of sunlight daily it began to flower in 28 days, and a month later some of its seed pods were mature. These differences in behavior are shown in plate 11. Coming from the Tropics, this plant, which is accustomed to a comparatively uniform length of day, with a maximum of about 12½ hours, flowers with equal readiness in our hottest July weather or in the cool weather of October, provided only that the day-length is favorable. The common ragweed (*Ambrosia artemisiifolia* L.), the date of flowering of which is so well known to sufferers from autumnal hay fever, was shedding pollen within 27 days when exposed to 7 hours of sunlight daily, beginning with June, but required 7 weeks to reach the same stage when exposed to the full day-length. (See pl. 12.) Specimens of one of the familiar wild violets of spring (*Viola fimbriatula* Sm.) which had already flowered in the field at the usual time in April were transplanted to boxes on June 9 and thereafter exposed to sunlight daily from 9 a. m. to 4 p. m. By July these plants were again displaying purple blossoms similar to the typical petaliferous blossoms of early spring, while control plants exposed to the sunlight throughout the day produced only the cleistogamous flowers which are characteristic of this species during the long days of summer. A very late variety of dahlia known as John Ehlich, which normally flowers about October 1st at Washington, was exposed to 10 hours of light daily from May 12, and under these conditions was in blossom as early as July 8, as shown in plate 13. A striking example of this response to decrease in length of day

is shown by the beautiful poinsettia, so highly prized as an ornamental plant during the Christmas season. Specimens exposed to 10 hours of sunlight daily from July 9 flowered and began to color in normal fashion. By the latter part of August the plants showed as fine coloration of the leaves subtending the inflorescence as can be obtained in winter.

Having shown that various plants which normally flower in autumn, fall, or winter are readily forced into bloom in midsummer simply by shortening the length of the daily exposure to light, it will be of interest next to consider plants which normally flower in midsummer when the days are longest. Some of our best known vegetables fall into this class. The behavior of radish (*Raphanus sativus* L.) is interesting and instructive. As is well known to all gardeners, the ordinary varieties such as Scarlet Globe when planted in spring first produce an edible root of moderate size, after which a flowering stem is sent up, seed are formed, and the plant perishes. The Scarlet Globe when planted in May and allowed to receive only seven hours of light daily continued to increase slowly in size throughout the summer and the succeeding winter without developing any flower stem (see pl. 12, fig. 2). The root finally reached a diameter of nearly 5 inches and the leaves attained a length of about 18 inches. (See pl. 13, fig. 2.) As the plant was allowed to receive the benefit of the lengthening days of the following spring the usual flowering stem appeared. It is well known that while spinach (*Spinacea oleracea* L.) may be easily grown as a garden vegetable in spring and fall, it is a "failure" when planted in the summer for the reason that the plants quickly "go to seed" instead of merely developing the desired rosette of edible leaves. This behavior of spinach in midsummer has been almost universally regarded as being due solely to high temperature. As a matter of fact, when exposed to a short day-length summer-grown spinach was found to behave essentially the same as when planted in spring or fall, except that the higher temperature undoubtedly hastens the general development of the plant. The Climbing Hempweed (*Mikania scandens* L.), which normally begins to flower in July, was given a daily light exposure of seven hours and under this treatment remained sterile throughout the summer. (See pl. 14.) It has been found, moreover, that this plant is unable to blossom when grown in the greenhouse through the winter months. Similarly, *Hibiscus moscheutos* L., a wild perennial which flowers in late summer, was unable to flower or to make any appreciable growth when exposed to seven hours of light daily, as is shown in plate 10. Without multiplying examples further, it is clear that there is a group of plants which are unable to flower except under the influence of comparatively long days, as contrasted with the group first dis-

cussed which require relatively short days in order to attain the flowering and fruit stages. The difference between the two groups, however, is primarily one of degree and not of kind. In fact, for some plants it is possible to have a day too long as well as one too short to permit normal flowering and fruiting.

USE OF ELECTRIC LIGHT TO INCREASE THE LENGTH OF DAY.

The experiments in forcing the flowering and fruiting of plants thus far considered have to do with shortening the daily illumination period during the comparatively long days of summer through the use of dark chambers into which the plants may be placed for a portion of the day. During the winter months the days, of course, are much shorter than in summer, and as a consequence many plants which normally flower in summer are unable to do so in winter, even though all other conditions be favorable. The question naturally arises whether these plants can be forced to flower out of season by using artificial light to extend the length of day so as to furnish an illumination period equal in length to that naturally prevailing in summer. If artificial light thus applied is effective, it should be possible in the winter to reverse the results obtained by use of dark chambers during the summer—that is, it should be possible both to prevent the flowering of those plants normally responding to a short day-length and to force flowering of those plants which normally respond to a long day. Tests were made along these lines in the usual type of greenhouse fitted with a series of ordinary 40-watt electric bulbs evenly distributed below the glass roof, a total of 34 such lights being contained in a greenhouse 50 feet long and 20 feet wide. The lights were turned on about sunset each day and turned off at midnight. A specimen of *Iris florentina* L., which normally flowers in May, was placed in the illuminated greenhouse late in October and soon began growing vigorously. By Christmas the plant was in bloom, while a similar specimen in a greenhouse without electric light remained dormant all winter. Spinach planted in the artificially lighted house on November 1 was in bloom by the middle of December, while a similar planting in the control house did not flower till late in the spring when the days had lengthened. Seed of Spanish Needles (*Bidens frondosa* L.) planted in the unlighted greenhouse began to flower when less than 2 inches in height, while under the influence of the electric light the plants continued to grow throughout the winter till the experiment was discontinued, having attained a height of some 5 feet without flowering. Plants transferred from the artificially lighted house to the control house when they had attained a height of about 9 inches promptly flowered. Seed of cosmos (*Cosmos bipinnata* Cav.) was sowed November 1 in the two

greenhouses, and by the latter part of December the plants in the control house were in full bloom, having attained a height of about 30 inches. In the lighted house the plants continued to grow throughout the winter without flowering and late in spring after long days had arrived they were placed out of doors. In the following fall when the days had shortened these plants finally flowered after reaching a height of 15 feet. Plate 15 illustrates the behavior of similar lots of plants in the two greenhouses. Varieties of lima bean (*Phaseolus lunatus* L.) imported from the Tropics, which had failed to flower in the field during the summer, promptly flowered and developed fruits abundantly when transferred to the unlighted greenhouse in October. In the house lighted with electricity the plants grew vigorously, but were sterile throughout the winter, a few blossoms finally appearing in April. Plates 16 and 17 bring out the contrast in behavior under the two sets of conditions. The Maryland Mammoth tobacco and the several varieties of soy bean previously discussed behaved just as would have been expected from the results obtained by shortening the day during the summer season—that is, the use of electric light to prolong the day inhibited or delayed the appearance of blossoms just as do the long days of summer. These examples will suffice to show that artificial light may be successfully used either in inducing or in inhibiting flowering and fruiting of many plants when it is so applied as to prolong the daily illumination period.

It is interesting to compare the intensity of the electric light used in these tests with that of sunlight. In summer the intensity of the sunlight at midday may reach as high as 10,000 foot-candles, while in winter the intensity will be something like half this value. The ordinary 40-watt electric light bulb is rated at about 39 foot-candles, which signifies that the indicated intensity applies at a distance of 1 foot from the filament. Since the intensity varies inversely as the square of the distance, the intensity of the light of one of these bulbs at a distance of 2 feet would be about 10 foot-candles and at a distance of 10 feet the intensity drops to less than one-half foot-candle. The plants used in the tests under discussion stood at varying distances from the bulbs, but in most cases the distance to the nearest lights probably averaged 4 to 6 feet. Few of the plants, therefore, received a higher intensity of electric light than 5 to 10 foot-candles and many of them considerably less. It is obvious that after the plants above mentioned have been exposed to natural sunlight during the day, artificial light of an intensity as low as one-thousandth that of the sunlight will suffice to bring about the same results with regard to flowering and fruiting as does continuous exposure to the sunlight for the same length of time. In other words, artificial light of very low intensity may be successfully used in lengthening the short

days of winter so far as concerns effect on flowering and fruiting. This does not mean, however, that artificial light of low intensity may be used to replace entirely the sunlight, for in this case most if not all of the plants would fail to develop normally and, in fact, many would soon perish.

CAUSE OF EVERBLOOMING AND EVERBEARING.

Numerous examples have been cited in preceding paragraphs which illustrate the fact that a certain day-length will cause prompt flowering and fruiting, the particular day-length required varying widely with the species. On the other hand, certain day-lengths may inhibit or greatly delay flowering and fruiting while greatly favoring vegetative development. Under these latter conditions the plant may continue to grow almost indefinitely without flowering, thus attaining abnormally large size. Profuse flowering and fruiting of plants usually arrests growth either temporarily or permanently, so that profuse flowering and rapid vegetative development are more or less incompatible. Seeing that in a given species a certain day-length may be conducive only to vegetative development while another day-length may favor only the flowering and fruiting phases of development, the question arises as to the behavior of the plant when exposed to an intermediate length of day. As a matter of fact, the intermediate day-length tends to favor both phases of plant development, and this situation whereby the plant divides its energies between growth on the one hand and flowering and fruiting on the other hand in reality constitutes the "everblooming" or "everbearing" condition. Instead of a short period of profuse flowering and fruiting, with resultant cessation of growth, there is a more or less extended period of relatively sparse flowering and fruiting, the plant all the while continuing to grow more or less. Naturally, there may be all gradations between the purely vegetative and the flowering and fruiting conditions, depending on the relative degree to which the prevailing length of day may favor these two alternative phases of plant activity. It follows that in a given latitude the duration and the rate of flowering and fruiting of a given species is likely to be controlled in large measure by the season of the year at which the plant is grown, and likewise the behavior in one latitude is likely to differ from that in another latitude because of difference in the prevailing length of day. For example, buckwheat (*Fagopyrum vulgare* Hill) sowed November 1 in the greenhouse under normal conditions began to flower during the first week in December and by February had ceased flowering and soon afterward died, having reached a height of about 24 inches. A similar planting in the greenhouse in which electric light was used for a part of the night

showed the typical everbearing behavior. These latter plants began flowering somewhat later; they continued to flower and fruit somewhat sparingly throughout the winter, continuing to grow all the while, the final height being about 10 feet. This is in line with the well-known fact that buckwheat succeeds best in northern latitudes, where the summer days are long. It has already been pointed out that by the use of electric lights to lengthen the short winter days spinach was promptly forced into flowering, and it may be added here that under the influence of the lengthened day, which was maintained at approximately constant duration, the spinach continued to flower for several weeks, thus approaching the everbearing condition. Again, by maintaining a constant day-length of about eight hours violets have been caused to produce purple, petaliferous blossoms continuously for several months. The fact is that under a suitable and approximately constant day-length the everblooming habit is the rule rather than the exception, but in nature everblooming is confined to comparatively few species and varieties growing outside the Tropics, because the proper length of day does not continue for the necessary length of time. Some species are able to grow and to flower simultaneously through a considerable range in day-length, but for most species the seasonal change in length of day in temperate regions is too rapid to allow this combined type of development to come into expression.

REJUVENESCENCE IN PLANTS.

To ascertain the cause of senility and resultant death, which always follows sooner or later, has long been one of the great problems of the biologist, and as yet no satisfactory solution of this problem has been offered. In plants as in animals the average length of life of different species differs enormously. Considering only the higher plants, there are many which spring up from the seed, attain their full growth, flower, ripen their seed, and perish within a period of a few weeks. Again, there are numerous species which live for hundreds of years and a few which continue to live even for thousands of years. One large and important group are known as annuals for the reason that they usually mature seed and perish within a year's time from germination, though the life cycle is not necessarily coincident with the calendar year. One of the most striking features of the autumn landscape which so clearly marks the approaching close of the principal growing season for plant life is furnished by the slowing down of growth, the development of seed, shedding or withering of leaves, and other indications of approaching death in the summer annuals and of transition into dormancy or the winter rest period on the part of the corresponding types of perennials. It is commonly considered that the death of these annuals in the

fall is as inevitable as is the death of the animal organism which has lived out its allotted period of time. Until the problem of the ultimate cause of senility is fully cleared up it may not be possible to rescue permanently these annual plants from death, but it is at least possible to prolong greatly their life period, thus causing them to behave as perennials. The relation of the length of day to the two alternative phases of plant activity, viz, vegetative development or growth and flowering and fruiting, has already been fully discussed, and it has been pointed out that a sufficiently wide change in day-length may redirect the activities of the plant to the extent that vegetative development is completely replaced by flowering and fruiting. In the typical annual this change of activity is soon followed by the death of the plant. On the other hand, it has been pointed out that with a more moderate change in length of day there may be only partial change from vegetative to flowering condition, as in the "everblooming" condition. In this case death does not necessarily follow, hence it appears that not only does relatively rapid shortening of the days in the autumn and fall cause change from the vegetative to the fruiting condition, but as a final result when this change in activity is complete, may cause the death of the plant. With no change in length of day these summer annuals would continue to grow more or less indefinitely, so that senility in the organism as a whole is deferred accordingly. If this be so, it seems possible that the annual, having passed over into the condition of rapid decline which follows flowering and fruiting as a result of the shortening of the days, could be rescued from approaching death by exposure to a sufficiently increased day-length. As a matter of fact, experiments in this direction have been entirely successful.

It will be recalled that the Biloxi soy bean, which normally does not begin to flower till September in the latitude of Washington, was caused to blossom as early as June 16 by shortening the day-length to only five hours. These same plants were restored to the full-day length on June 20. The seed pods ripened rapidly, the leaves turned yellow, and the plants at first appeared to be passing through the usual changes leading up to final death. Eventually, however, new shoots developed and the rejuvenated plants entered into a second period of growth. The new shoots began to flower at exactly the same time in September as did plants which had been growing all summer in the field. Wild aster which had been forced to flower as early as June 18 by shortening the day to only seven hours were restored to the natural day-length on June 20. By July 20 new shoots had appeared and the plants flowered the second time early in September, just as did control plants exposed throughout to the natural day-length. Thus, perennials as well as annuals may be rejuvenated through the influence of an increased day-length. Ragweed showed

the same behavior as the soy bean and aster. By using electric light to lengthen the short days of winter as already described Spanish needles (*Bidens frondosa* L.), which was in a dying condition after having fruited, was induced to send up new shoots and continued to grow all winter. Thus it seems that whether a plant behaves as an annual, dying soon after flowering and fruiting, may depend largely on the length of day to which it is exposed, and even after the plant has reached a dying condition it may be rejuvenated through the action of a favorable day-length. It is interesting to note, also, that in the above experiments the soy bean, ragweed, and aster were caused to complete two cycles of alternate vegetative and reproductive activity within a single season.

NATURAL DISTRIBUTION OF PLANTS IN RELATION TO DAY-LENGTH.

In the preceding pages evidence has been given that not only different species but also varieties of the same species show marked differences in their response to length of day. Some are able to flower and mature seed under the influence of relatively short days, while others are able to reproduce successfully only under the influence of relatively long days. At the Equator the length of the day remains 12 hours throughout the year, so that in the Tropics, with seasonal range in length of day reduced to a minimum, it might be expected that there would be less tendency toward the annual type of plant behavior in so far as an unfavorable day-length is responsible for early termination of growth, followed by fruiting and final death of the individual. In the case of plants which are adapted to a day-length of approximately 12 hours, the natural tendency in the Tropics would be toward the perennial type of development; and since such change in length of day as occurs must take place very gradually, the everblooming habit would be greatly favored. These deductions are in full accord with observation, for predominance of perennials and everblooming types are characteristic features of the tropical flora. It is to be expected that many of these tropical plants would not be successful in higher latitudes, for the increase in length of day during the growing season would tend to prevent successful ripening of seed before cold weather, while the more or less precipitate seasonal change would not find the plants prepared to withstand the cold of winter. In other words, these plants would hardly find favorable conditions in higher latitudes either for propagation by seed or for survival as hardy perennials.

On the other hand, some species behaving as fruiting perennials in the Tropics might successfully mature seed in considerably higher latitudes before the advent of cold weather, and hence might prove successful as annuals. The most essential condition is that the plant

be able to withstand the unfavorable conditions of winter (or of the summer) in some resistant form, whether simply as a typical evergreen, or in some resting condition, as deciduous woody perennial, herbaceous perennial, or as viable seed. In passing northward or southward from the Equator both the total annual range and the daily amplitude of change in the length of day must be considered in their relation to adaptation and natural distribution of plants.

It remains to consider briefly the manner in which a species adapted only to a given range in latitude because of its requirements as to length of day may eventually extend its range into new regions. For example, how could a species native to the Tropics successfully invade the temperate regions? The answer seems to be that new strains or varieties must appear which are better adapted to the changed length of day prevailing in temperate regions. That new strains and varieties are constantly coming into existence in nature is well known, and it is equally certain that some of these differ from the parental type in their light requirements, an example being found in the Maryland Mammoth tobacco, which has been fully discussed in the preceding pages. It may be well to recall in this connection the observation previously made to the effect that a mixture of early, medium, and late maturing varieties of soy bean as grown in northern latitudes would behave as a single early-maturing variety when grown in the Tropics. Plants which require a comparatively long day to attain the flowering and fruiting stage, such as the radish, apparently would need to produce strains capable of flowering under a shorter day-length in order to extend their natural range toward the Equator. That such strains, differing in their requirements as to duration of the daylight period, do actually exist in some species has been shown in this paper, and it seems reasonable to assume that appearance of new forms thus differing from their parental types has furnished the means for the species to extend its range northward or southward.

CONCLUSION.

In the light of the experiments which have been described in the foregoing paragraphs, it seems certain that the seasonal range in length of day exerts a profound influence on the flowering and fruiting habits of plants. This may seem less surprising, perhaps, when it is considered that temperature, rainfall, and intensity of sunlight as affected by cloudiness are subject to great variation in most localities independently of the normal seasonal change, while the length of the daylight period, on the other hand, follows with mathematical precision a definite seasonal change year after year. It is to be expected, therefore, that any feature of plant development which shows such sharply defined periodicity as does flowering and fruiting

would be more profoundly influenced by the fixed course of the annual cycle in day-length than by other climatic factors which are so variable and uncertain in their annual cycle. The wonder is that we have been so slow in recognizing the real significance of the relative length of day and night as a factor in plant development.

We may conclude that flowering and fruiting of many kinds of plants is induced by exposure to a specifically favorable length of day which varies widely with the species, some plants requiring relatively long days, others requiring comparatively short days. There are also definite day-lengths which are particularly favorable to purely vegetative development. Exposure to a daily illumination period which is favorable to vegetative development but unfavorable to flowering and fruiting tends to cause more or less indefinite continuation of growth, a phenomenon which is designated as gigantism. Exposure to daylight of a duration which is favorable to flowering and fruiting and relatively unfavorable to growth tends to produce heavy flowering and fruiting but dwarfed or restricted growth. A daylight period favorable alike to growth and to flowering and fruiting may induce the everblooming or everbearing type of development, the plant thus dividing its energies between growth and reproduction. It is a comparatively simple matter to hasten or to delay almost at will the flowering and fruiting of most plants by properly shortening or lengthening the daylight period. The natural daylight period may be shortened by use of dark houses and may be lengthened by use of artificial light.

The term *photoperiodism* has been adopted to designate the response of the organism to the relative length of day and night.¹

¹ For a more technical account of the work which has been discussed in this paper the reader is referred to an article by the authors which appeared in the *Journal of Agricultural Research*, Vol. XVIII, pp. 555-606, Mar. 1, 1920, under the title "Effect of the Relative Length of Day and Night and Other Factors of the Environment on Growth and Reproduction in Plants."

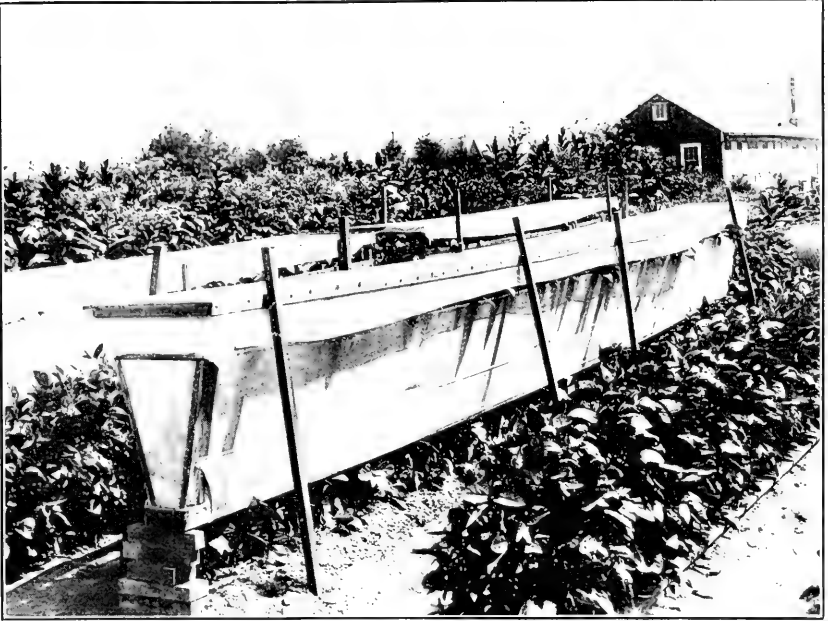

1. Triangular type of shade with cheesecloth covering, used in the 1916 test with soy bean.



2. Soy bean, shaded with 12 by 12 mesh netting.

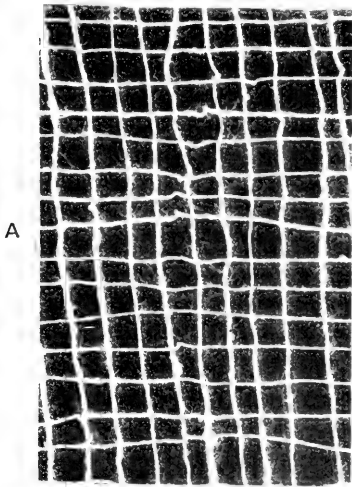

A

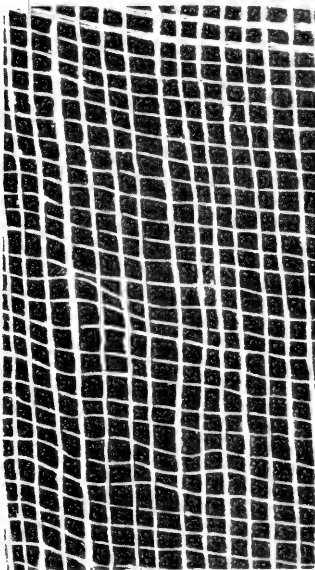

B

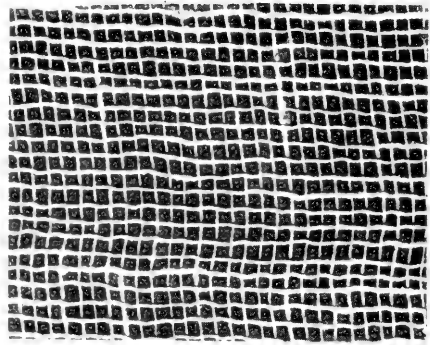

C

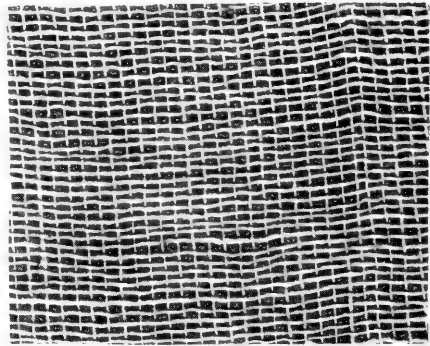

D

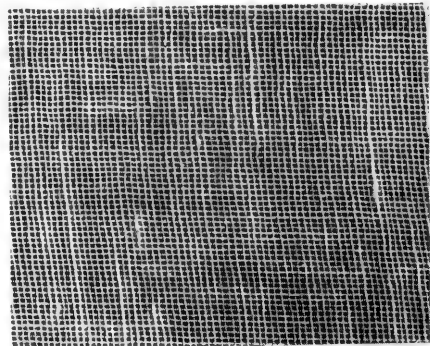

E

- A.—Shade cloth, 6 by 6 mesh. Natural size.
B.—Shade cloth, 8 by 10 mesh. Natural size.
C.—Shade cloth, 12 by 12 mesh. Natural size.
D.—Shade cloth, 12 by 20 mesh. Natural size.
E.—Standard cheesecloth used in 1916 experiments. Natural size.



1. Small dark chamber used in the 1918 experiments.

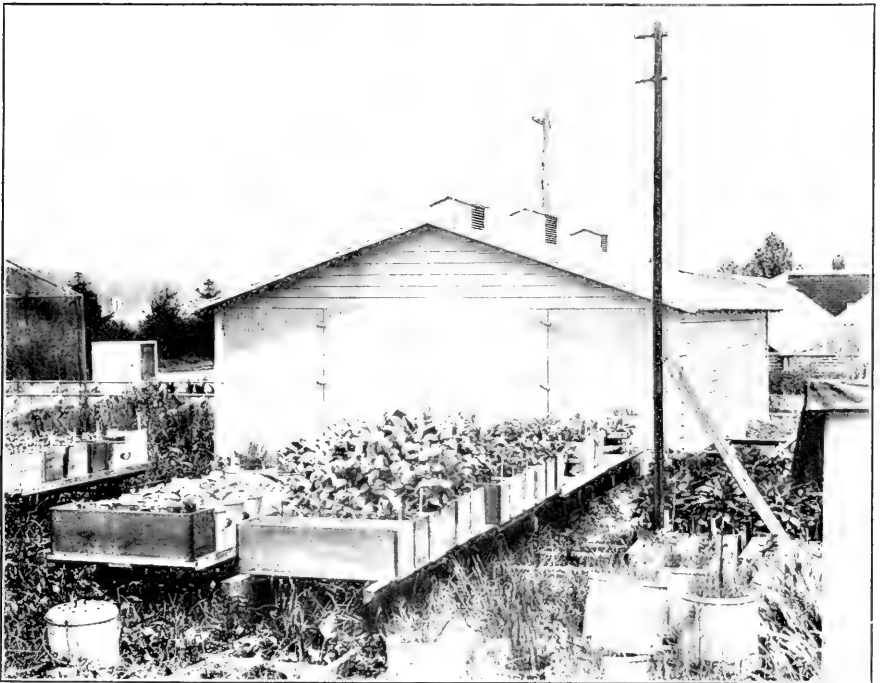

2. Larger dark house used in the 1919 tests. Trucks and steel tracks used in moving the test plants into and out of the dark house.

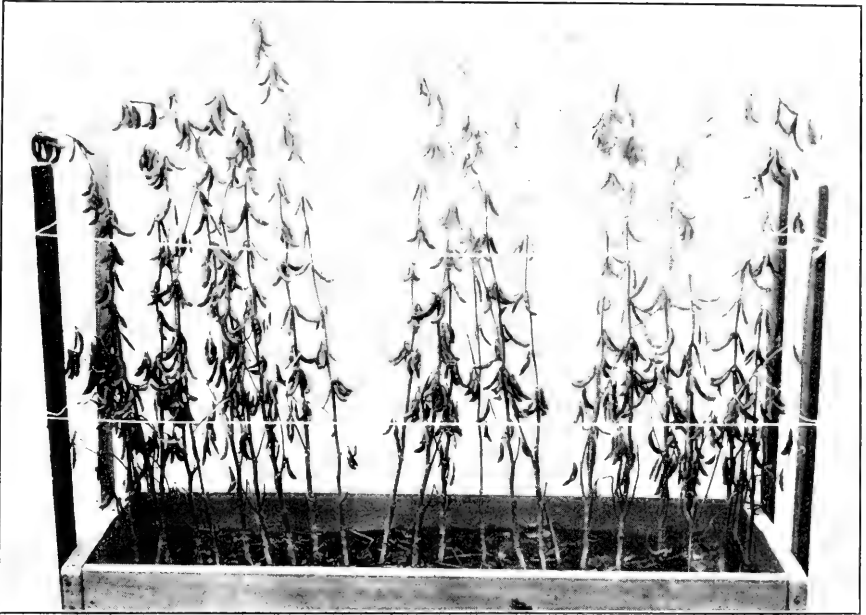

1. Peking soy bean exposed to the light for 7½ hours daily, beginning with the blossoming period. When photographed September 13, 1919, the seed pods had fully matured and were ready for harvest (compare figure 2).



2. Peking soy bean kept out of doors throughout the test. When photographed September 13 the seed pods were still green and the foliage was just beginning to yellow slightly (compare figure 1).



1. Maryland Mammoth tobacco in 12-quart buckets exposed to light from 9 a. m. to 4 p. m., or seven hours daily. Seed pods formed when photographed August 19 (compare figure 2).



2. Maryland Mammoth tobacco in 12-quart buckets left out of doors during the experiment. Flower heads just beginning to show when photographed August 19, 1919 (compare figure 1).



1. *Aster linariifolius* L. Plants in box on left exposed to light from 9 a. m. to 4 p. m. daily. In full bloom when photographed June 21. Plants in box on right left out of doors during the test. Showed no indications of flower heads when photographed June 21.



2. Biloxi soy bean exposed to the light for seven hours daily. When photographed August 15, 1919, all seed pods were mature and dry and the leaves were falling (compare plate 7).

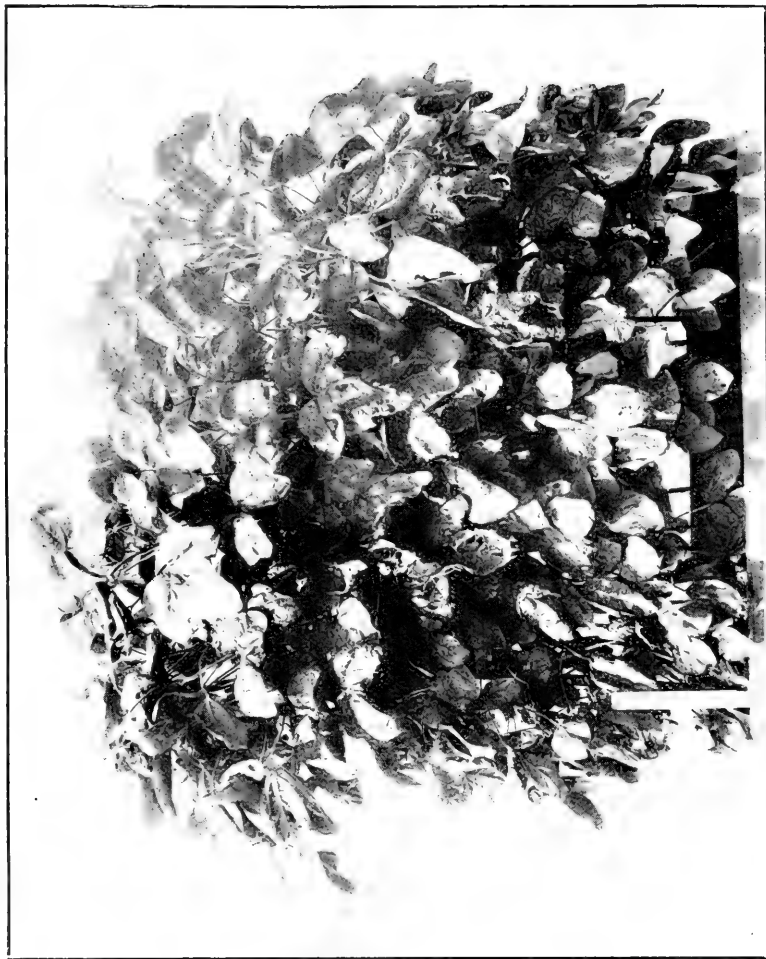

Biloxi soy bean kept out of doors during the test. When photographed August 15 there were no indications of blossoming (compare plate 6, figure 2).



Biloxi soy bean. Plants in box on left exposed to the light for five hours daily. Those in box on right kept out of doors throughout the experiment. When photographed August 15, 1919, the plants on left contained fully matured seed pods and leaves were yellowing, while plants on right had not blossomed.

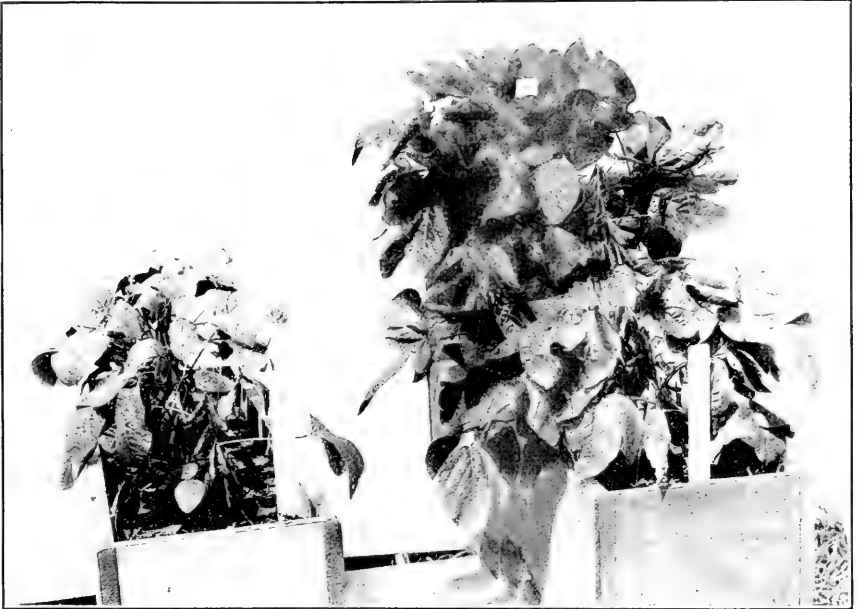

1. Biloxi soy bean. Plants in box on left exposed to light daily for 7 hours; those on right exposed 12 hours daily. While both lots blossomed and fruited promptly, the plants under the longer light exposure grew much larger than those under the shorter exposure. Photographed August 19.



2. Biloxi soy bean. Plants in box on right exposed to light from daylight to 10 a. m. and from 2 p. m. to dark, a total of 9 to 10 hours daily. Plants in box on left exposed to light from 6 a. m. to 6 p. m., or 12 hours daily. Note marked difference in effectiveness of the two exposures in hastening fruiting and maturation. Photographed September 8, 1919.



Hibiscus. Plant on left, exposed to light from 9 a. m. to 4 p. m. daily, was unable to flower or to make any appreciable growth. Plant on right, left out of doors throughout the test, which began June 7, grew rapidly and flowered August 22. Note seed pod at top of plant. Photographed September 8.



1. *Phaseolus vulgaris* from Peru and Bolivia, exposed to light from 9 a. m. to 4 p. m. Contained full-grown seed pods when photographed August 15, 1919.

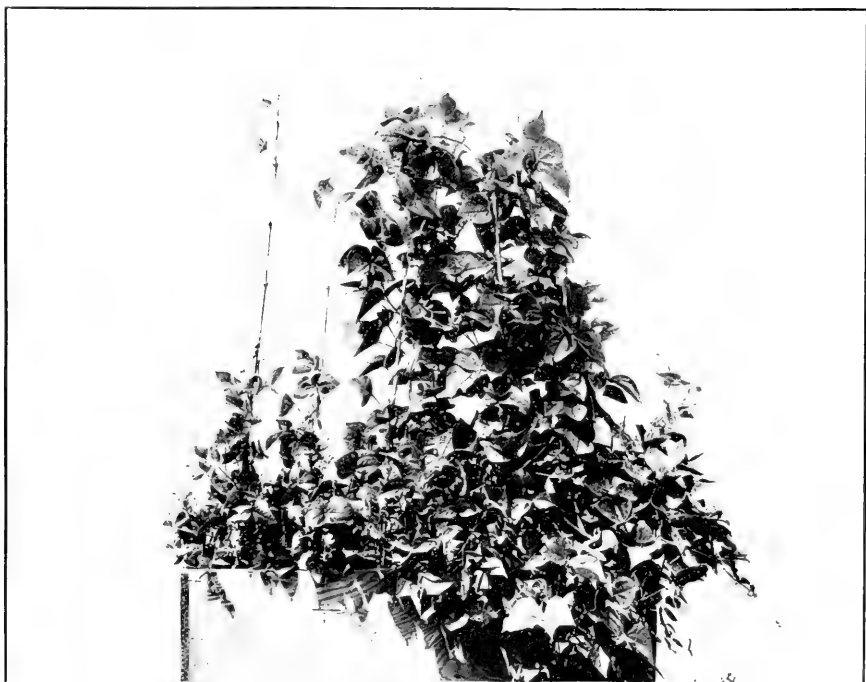

2. *Phaseolus vulgaris* from Peru and Bolivia, left out of doors during the experiment. Showed no indications of flowering when photographed August 15.



1. Ragweed. Plants on left exposed to light from 9 a. m. to 4 p. m. daily. Pollen shedding freely from the staminate spikes when photographed July 9, 1919. Plants on right left out of doors as controls. Showed no signs of flowering when photographed.

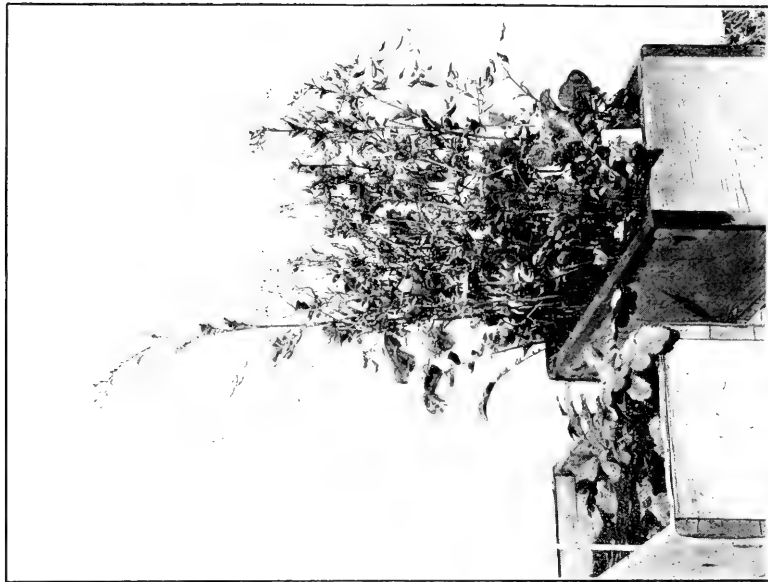

2. Radish. Plants in box on left exposed to light from 9 a. m. to 4 p. m. daily. No indications of flower stalks when photographed August 19. Plants in box on right left out of doors during the test. Bore an abundance of full-grown seed pods when photographed.



1. Dahlia. Plant on right exposed to sunlight for 10 hours daily, beginning May 20. First blossom opened July 8. Plant on left, which was exposed to sunlight for the whole day throughout the test, did not flower till September 27. Photographed July 8.



2. Radish. Planted May 15, 1919, and exposed to seven hours of sunlight daily till October, after which it was exposed to the sunlight for the whole day, in the greenhouse. When photographed, January 5, 1920, the root was nearly 5 inches in diameter and the leaves were 18 inches long. The radish requires a long day to attain the flowering stage.

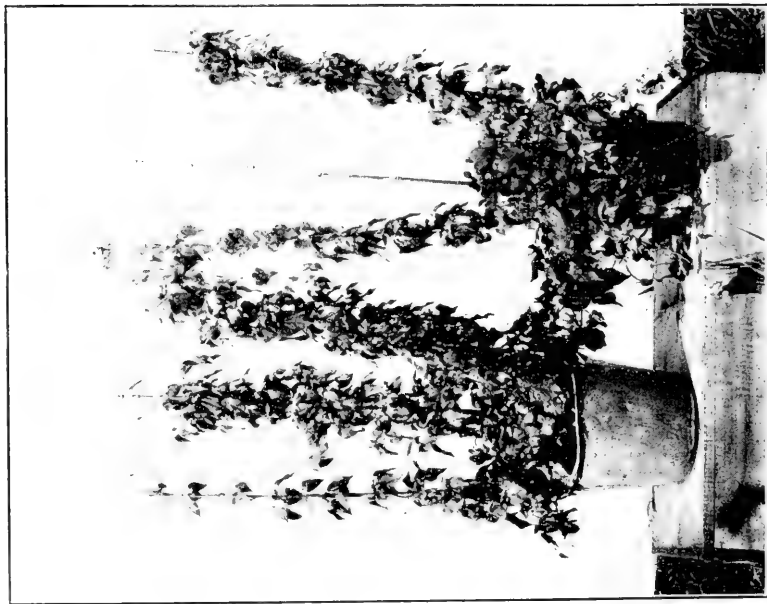

1. *Mikania scandens* L., exposed to light from 9 a. m. to 4 p. m. daily. Showed no indications of flowering when photographed August 15, 1919 (compare figure 2).

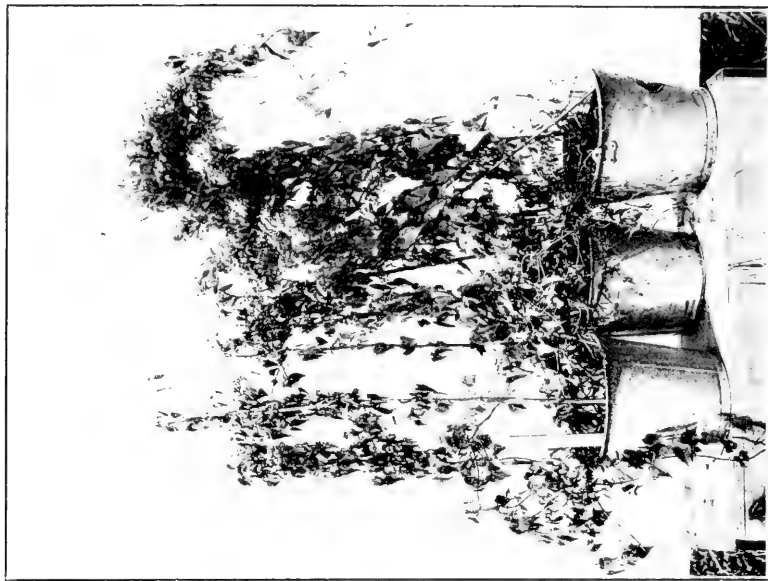

2. *Mikania scandens* L., left out of doors during the test. Blossoming profusely when photographed August 15 (compare figure 1).

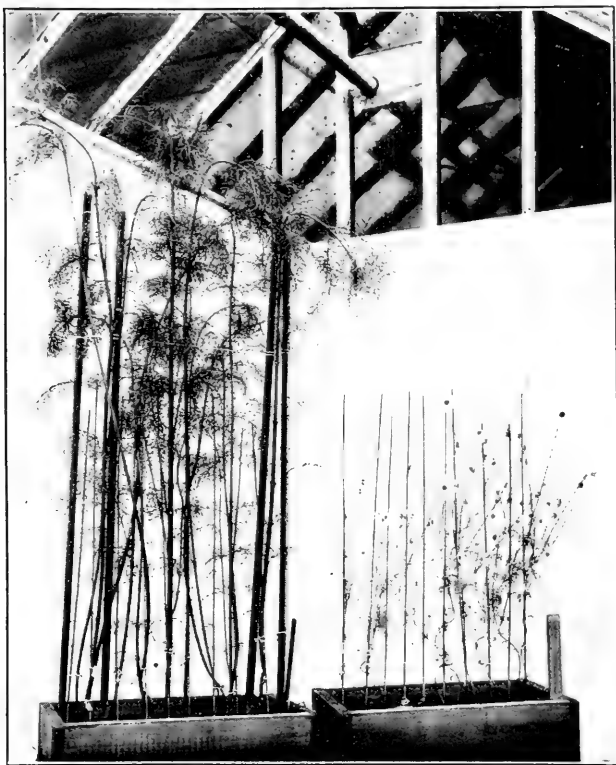

Cosmos. Planted in greenhouse January 5. Plants on left received electric light daily from sunset till midnight, in addition to the sunlight of the day. The artificially lengthened day prevented flowering. Plants on right, which received only sunlight and no artificial illumination, began to flower March 10. Photographed March 23.



Phascolus lanatus L. These plants had grown out of doors all summer without flowering, but soon after having been transferred to the greenhouse in October flowered and fruited freely under the influence of the shortening days (compare plate 17).



Phascolus lunatus L. These plants received the same treatment as those in plate 16, except that after having been transferred to the greenhouse they were daily exposed to electric light from sunset till midnight, in addition to the sunlight of the day. The plants grew rapidly, but were prevented from flowering and fruiting by the artificially lengthened daylight period.

FIRE WORSHIP OF THE HOPI INDIANS.

By J. WALTER FEWKES,
Chief, Bureau of American Ethnology.

[With 13 plates.]

As the soul of American ethnology is the story of Indian culture, its evolution is the most important problem before the ethnological student of our aborigines. Preliminary to the study of this evolution is the recognition that Indian culture history is practically the offspring of American environment and independent of foreign influence save in its beginning. The facts that determine the prehistoric phases of cultural development are discoverable by archeological researches dealing with ancient objective material and modern sociological, linguistic, and other survivals.

In early investigations the study of this material was largely descriptive and in efforts to interpret prehistoric specimens serious mistakes occurred by comparing them with similar material from the Old World or products of an environment that was not American. Our early archeologists often sought to explain American prehistoric objects and their symbolism by comparison with similar objects from other lands. It was a favorite method to emphasize the resemblances of Maya ruins and their artifacts to Egyptian antiquities and ascribe their similarities to derivation. This method yielded interesting results but not scientific certainties. Not so, however, the study of manners and customs or prehistoric objects of culture still used by living Indians. A knowledge of the material culture and cultural life of modern pueblos is now necessary for one who aspires to add much to our present information concerning the culture of the cliff dwellers and ancient pueblos, and yet up to 1885 this method of work was little cultivated. The ethnology of the historic Indians now furnishes a necessary preparation for an interpretation of prehistoric remains found in cliff dwellings and ancient pueblos, for there is much material in these ruins which is identical with that still in use or which was in use a few decades ago among living descendants. With some other areas north of Mexico we are not as fortunate as with the pueblos. Take, for instance, the Mississippi Valley. In an interpretation of archeological data as an index to the cultural history of the mound builders, we should know the manners and customs of the historic Indians living in the mound builders' country before

we can interpret early or prehistoric stages of the mound builders' culture. Unfortunately the area inhabited by them was settled so rapidly by the white man that these stocks disappeared before their culture was adequately recorded and our knowledge of them being correspondingly fragmentary, our interpretation of the relations of the mound builders is less precise. This is, of course, not universally true for all tribes. The Jesuit Relations abound with ethnological data. The busk or fire ceremonials of certain Mississippi tribes have been described with great completeness, although not in sufficient detail. Historians tell us of wooden idols and fire temples used in these rites, but neither pencil nor camera has transmitted to us a picture or photograph of them adequate for interpretation. There can hardly be a doubt that the mound builders performed fire ceremonials possibly as elaborate as the Hopi, but as no one has adequately described them, we are obliged to rely on objects to supplement our knowledge of them.

The mystery of life made a very strong impression on the minds of primitive men and efforts for its perpetuation are prominent in most ceremonies of the Hopi ritual. The nature and cause of life early became a subject of speculation and was ascribed to a supernatural origin. Life was recognized as characteristic of man, animals, plants, and all material objects and forces. The Hopi looked to objective manifestations for an interpretation of life, but regarded it chiefly as a manifestation of magic power.

Fire being to the primitive mind a form of vitality, it was interpreted by the Hopi as a living being; its continuance came to occupy a prominent place in their rituals. The mode of influencing supernatural beings for that end made up the major part of their religion. The relation of the sky god to universal life has already been discussed,¹ and in the present article an attempt will be made to show that fire rites among these Indians have somewhat the same meaning. Sun worship and fire worship have identical ends in view and many rites in common.

In Hopi fire rites we have one of several modifications of the fundamental purpose of their ritual—to perpetuate life—but the Hopi ritual is a mosaic of clan units, with individual differences, through which there runs a vein of similarity and certain common supernatural conceptions of elementary powers, among which is a personation or deification of the principle of life, but the names applied to it vary in different clan cults.

It can hardly be questioned that the worship of fire as well as of the sun² is fundamental among the Hopi, and extends back in history even to the time when the culture of the human race

¹ Ann. Rept. Smithsonian Inst., 1918.

² These studies were made twenty years ago and depict the aboriginal Hopi religious practices.

originated. A study of it is important to the culture historian on account of its archaic origin.

The primary object of Hopi ceremonies is shown by the prayers at the winter solstice ceremony when many sacred feathers or symbolic prayer offerings³ are tied to almost everything the Hopi desires—human beings, horses, donkeys, clay imitations of sheep, goats, rabbits, antelopes, deer, peach trees, imitations of eagle eggs, etc. The wish expressed when one of these stringed prayer feathers is presented to an individual is revealed in the following words of the giver: "May Katcinas grant you all blessings," and blessings among the Hopi always mean that crops may grow and that life may be perpetuated and increased. There is likewise a connection of morality with some of their prayers. I have often heard the priests halt as they droned over their ritualistic songs and exclaim, "Whose heart is bad? Whose words are leaving the straight path?" and then they sorrowfully resumed their songs, showing a connection of conduct to the efficacy of their prayers, but as a rule material good is the aim and ethical conduct is secondary. When they say, "Whose heart is bad?" they may mean, "Who is not doing his prescribed ceremonial duty and through this neglect is thereby rendering the whole ceremonial futile?"

As the Hopi regard fire as life there is naturally in their fire ceremonies a connection between the creation of fire and the procreation of life. Hence it is impossible to adequately understand the new fire rite without considering the symbols of fertilization and ceremonies connected with the perpetuation of life.

A supernatural being among the Hopi has several names which are recognized by some of the priests as attributive but which the ignorant regard as different gods, considering every attributive name as a distinct deity. This multiplicity of names tends to confuse the student of mythology in comparative studies. It imparts so great a complexity to legends in which they are mentioned that it is not possible to recognize in all cases the nature of the being of which they are designations. The cause of these many names for the same god may be traced to component clans which may have perpetuated in mythology ancient words that are otherwise extinct. The secret rites of one priesthood are carefully guarded and are generally unknown to another.⁴

³Thousands of these wish feathers are made during every winter solstice and every Hopi uses them in his prayers for blessings.

⁴The priests have repeatedly warned the author not to divulge the secrets of the Walpi kivas to the residents of the neighboring pueblo, Hano, and vice versa, nor do they look with favor on public exhibits of pictures of altars in one rite to priests in another, lest knowledge of secret things should become secularized. Kopeli, the former snake chief at Walpi, would not enter the Middle Mesa snake kivas and confessed that he knew little of the rites of the snake fraternities of any pueblo but his own. This secrecy may explain the erroneous information on Hopi snake dances that is often printed. No one but a snake priest knows anything about the snake altars, and some of them are unfamiliar with many details.

Accompanying fire worship, or more accurately speaking the worship of the magic power of life as exemplified in fire, is its curative power, claimed by those who maintain that since they are able to create fire they can likewise control it. Certain fire priests, as the Yaya, practice healing and claim they are able to cure diseases due to fire by this control. As fire and heat are both manifestations of life, certain skin diseases where the body shows more than normal heat belong to the category of those diseases that the Yaya claim to cure. Their method is simple. They offset the magic power of fire on the human body by the application of their power by means of charcoal or ashes applied to the part affected. These remedies being prophylactic are in some instances curative, but to their minds the cure is effected by sympathetic magic rather than by scientific medicine; the true explanation of the cure being, of course, the influence of the mind of the patient over his body.

The incredible stories told by these Yaya priests, in which they recount their mastery of fire, find a fertile soil for exaggeration in the imagination of the hearers. The demonstrations of the priests who make the fire are such that the wonderful stories that they can control fire are readily believed, and these stories lose none of their wonder in transmission from one age to another.

The weird nature of the dances that were formerly celebrated about the fire, after it was kindled in the open, may be judged from the accompanying figure (pl. 1) of the Navaho fire dance, reproduced from Doctor Washington Matthews' *Mountain Chant*. The Hopi and Tewa both say that in former days, in the performance of similar dances in the open, they even excelled the Navaho fire dance, which I can without difficulty believe.

Fire worship is intimately associated with sun worship, and the association of solar and fire worship is very natural in the untutored mind of primitive man, since the sun is the great source of fire and light, as well as the father of all life. Its relation to the generation of life leads to an examination of the elemental power of the earth. The earth is regarded as the mother of all, expressed in the term "Mother Earth." In their conception, the earth power existed in most ancient time, so ancient, in fact, that its creation figures little in Hopi legends. Myths of the origin of the earth deal with a personation of the Earth or Germ God, known under various names, as Muyinwu and Alosaka. These beings repeatedly occur in mythology and afford data worth examination.

The Hopi have two new fire ceremonies, one in November, the other at or near the summer solstice. The most elaborate, or November new fire ceremony, has an abbreviated and an extended



NAVAJO FIRE DANCE, FROM DR. WASHINGTON MATTHEWS.

From painting by Richard N. Brooke.

presentation,⁵ the former annual, the latter quadrennial, the great difference being mainly in the initiation of novices in the latter, while there are no initiations in the former. It is commonly said that the kindling of the new fire opens a new era, or a new round of festivals, and as it is abbreviated or elaborated the great nine days' ceremonials that follow throughout the year are simple or complex. The ceremony has the same relative importance for the Hopi as the kindling of the fire at the end of the Aztec cycle had to the more highly developed aborigines of Mexico.

The November fire rites and attendant festival at Walpi⁶ extend over nine active days and nights, and are performed by four sacerdotal fraternities, called the Kwakwantu, the Tataukyamu, the Aaltu, and the Wüwütcimtu. Each group of priests has certain specialized secret rites of its own and performs public dances. The new fire is kindled in only one kiva and all members of the societies are participants. The new fire is ignited by the frictional method and is transferred by means of torches to the other four kivas in the village.

Two of the fraternities, the Kwakwantu and the Aaltu, kindle the fire, the former using a stone (pl. 8, fig. 2) for the hearth. The chief of this society personates the Fire God, and we may regard the whole ceremony as under its direction. The second society, called the Aaltu or horned priests, are associated with the clans called Ala (horns), which are traditionally said to have formerly lived in cliff houses in the north. This priesthood wears imitation horns of mountain sheep, and in some of their public rites imitate the motions of the mountain sheep. Their supernatural is the Germ God, Alosaka, and they have a wooden image or idol of Talatumsi of the same nature.

The Ala, Flute, and Snake clans are closely associated and once inhabited cliff houses at Tokonabi, on the San Juan and its tributaries. They were among the ancestors of the Hopi, being the first to settle at the so-called East Mesa of the Hopi.

The Horn Society erected on the fifth day of the new fire ceremony an altar of simple construction on which were set two chieftain's badges. A layer of valley sand was sprinkled on the floor and at intervals on its western border at equal distances were heaped up four mounds of sand. A single prayer stick was set in the apex of two of these mounds and each Horn priest placed a stick with attached feathers in the same hillocks. Between the mounds of sand were placed ears of corn of many colors and on the floor before it a figure

⁵ These occur in the same month and are not like the abbreviated and elaborate snake dances that take place six months apart.

⁶ There were probably new fire ceremonies in other Hopi pueblos but none of them have ever been described.

of a rain cloud was made on the sand in meal. This altar, a view of which is here shown (pl. 2), is replaced in the elaborate new fire ceremony by one with an upright frame decorated with symbols, but the simplified form reveals its purpose. This is the altar of the God of Germination and the rites performed about it have a similar intent to those of the germ altar erected in the winter solstice ceremony at Oraibi which has only one sand mound and the ears of corn are replaced by "cones" representing the germ god.

In corroboration of the claim of the Horn priests that their fraternity originated in the north, we find many pictographs of the mountain sheep and men with horns on their heads playing flutes on cliffs near the cliff houses of the north.⁷ We likewise find objects made of basketry with two horns that may have been former head-dresses of the Horn priests. The Aaltu kindle the new fire with wooden fire sticks similar to those found in cliff dwellings.

The remaining two fraternities that observe the November fire ceremony serve as chorus while the fire is being kindled. The ancestors of the chief one of these, Tataukyamû, belonged to the tobacco clan and came from the historic pueblo, Awatobi, many of the inhabitants of which were massacred by the other Hopi in 1700 A. D.

A few uninitiated men and all women and children are debarred entrance into the kiva during the new fire rite, but almost every male in the village takes part in the ceremony.

The new fire ceremony is not only the most complicated among the Hopi but its many component rites are the most difficult to explain. The old chief once told me, "There are many things in this ceremony that I might explain to you if you could only understand them, but you can not." Alas, too true! The author believes the mind of the white man is unable to think along the lines of the untutored Indian and therefore it is most difficult for an Indian to explain esoteric things to an ethnologist.

There is probably no more complicated or solemn ceremony in the whole Hopi ritual than that of the new fire. On the day when this fire is kindled all other fires in the pueblo are extinguished, and the streets are dark and deserted. The women and children secrete themselves in the houses and most of the men of the place are in the kivas engaged in the rites. All the trails to the pueblo are symbolically closed; no living thing is suffered to enter the place. The symbolical closing of the trail is an ancient custom. When it is said to be opened prayer meal is sprinkled lengthwise along it but when closed a meal mark is drawn at right angles to the pathway. No one is allowed to cross this mark with impunity,

⁷ The author applies the name, *Tcamahia*, to the cliff dwellers of the San Juan. The same name is also given by the Hopi to celts characteristic of this valley, several of which are owned by the Ala and Snake families at Walpi.



ALTAR OF THE HORNED PRIESTS.

A representation in meal of a rain cloud laid on sand and six piles of sand in two of which are the badges of office (tiponi) of the Horned priests and ancients. In the outside mounds a prayer stick and twigs with prayer feathers which are also seen back of the tiponis.

a custom which is very old, having been described by Castañeda in his account of the events that took place when the Spaniards under Tobar approached Awatobi in 1540. Formerly anyone who passed a closed trail was liable to be killed, but now no knowing one enters or leaves a pueblo thus closed.

On the day the fire is made piles of fuel are deposited in all kivas and households to be lighted after the sacred flame has been ignited. The fire is sacred; it was not allowed to go out until the close of the festival, and no one might profane it by secular uses.

A brief description of the fire-making rite in the chief's kiva at Walpi is as follows, but all proceedings during the nine days of the ceremony having been elsewhere described need not be repeated:

As soon as the participants had entered the kiva the fire makers, squatting on the floor by the fireplace (pl. 8, fig. 7), fitted their fire drills into the depressions of the firestone or fireboard, and when all were ready the other priests stood while Hani recited a short prayer. Each chief held before him the badge of his office and there was a momentary silence, until it was broken by Hani, who gave the signal and the members of the chorus began to sing. The Kwakwantu accompanied the songs with the clanging of bells, and the Aaltu rattled deer hoofs on empty tortoise shells. They appeared to sing different songs antiphonally, some of which resembled those of the Snake priests at the washing of the reptiles in the Snake dance.

Almost simultaneously with the beginning of the singing the fire makers began to rotate their drills, corn pollen having been dropped into the slots of the fireboard or firestone before the drills were inserted. The drills were held vertically between the palms of the hands and in rotation were pressed downward. A second man relieved at intervals the one who twirled the drill and smoke was produced by the Aaltu in 20 seconds, followed by a spark of fire in about a minute. The Kwakwantu, whose fire hearth was a stone, produced smoke with their fire drill in 1 minute and 20 seconds and a spark in a minute and 50 seconds. The operation of twirling the fire drill was the same in both societies—a man held the board firmly in place to the floor while the fire makers, relieving each other every 15 seconds, rotated the drill. Soon there was a smudge in the cedar bark which was blown into a flame with the breath, the fire makers rising as they did so that all might see the new fire. The songs continued and the burning cedar bark was transported to the fireplace, where the flame caught the twigs placed there for fuel.

When a good blaze resulted each priest stood before the fire, raised a pine needle tied to a string to his lips, and having said an inaudible prayer, dropped the pine needle into the flame. The man

personating the Fire God responded and all indicated their satisfaction by the expression, "antcai."

A torch was lighted in the flame by a courier, who hurried away with it to all the other kivas and set on fire wood that had been collected in the fireplaces. This wood when ignited was from time to time renewed and burned until the close of the ceremony. No one was allowed to profane this flame for secular purposes, and on the last day of the ceremony the ashes were carried by the different societies, generally in watermelon rinds, to the west rim of the mesa, where they were thrown over the cliffs with pinches of prayer meal. The fire is not kept burning for any great length of time after the close of the new fire rites in Hopi kivas.

The events following that on the night the sacred fire is kindled illustrate its connection with a renewal of life. The Fire God, besides being a god of life, is likewise the Skeleton God or God of Death, because his realm, like that of the Sun God, is the underworld where live the breath bodies of the dead when they leave this earth. Offerings are carried to the shrine of the Fire God, which is situated in the plain west of the pueblo. Near it a fire is built in fire ceremonies and in it offerings are placed.

One rôle played by priests wearing imitation horns of the mountain sheep, on which account they are called the horned priests, is instructive. They are the guardians of an idol called Talatumsi, which is kept in a shrine among the rocks in the foothills near the stairway trail to Walpi. This idol (pl. 3, fig. 2) is brought into the pueblo by the chief of the Horn priests, and prayers are said to it during the elaborate new fire ceremonies by the members of this priesthood. This idol represents the same conception as the two idols, called Alosaka, that formerly had a shrine in the rocks at the base of the mesa on which the ruined pueblo Awatobi now stands. They were removed from their shrine about 1889 and are now used by the priests of the Middle Mesa, who claimed them as part of their religious paraphernalia, as is recorded in my account elsewhere⁸ published of the ruins in Tusayan.

The days following the kindling of the new fire are largely occupied by certain public dances which may be explained on the theory of sex worship or phallicism.

It is well not to give a realistic description or elaborate discussion of these public dances accompanying the new fire ceremony, but the reader who may have an interest in them is referred to my article on the new fire at Walpi,⁹ where he will find an account of the dance of the Tataukyamu (pl. 4), and notice of the phallic emblems painted on their bodies or similar objects borne in their

⁸ Archeological expedition in 1895, 17th Ann. Rept. Bur. Amer. Ethn., 1901.

⁹ New Fire Ceremony at Walpi, Amer. Anthrop., n. s. Vol. II, No. 1, 1900.

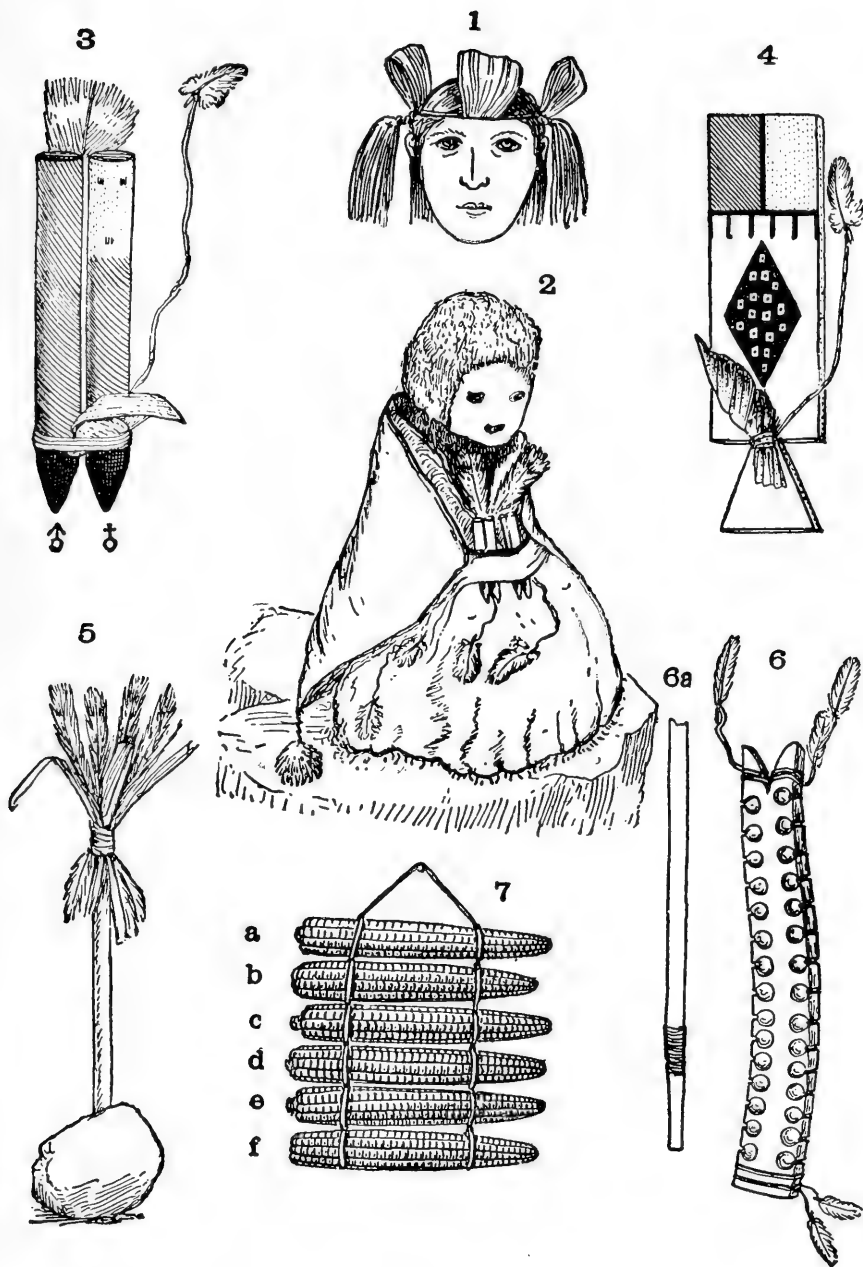

HOPÍ NEW FIRE PARAPHERNALIA.

1, head decoration of a *kete* or novice; 2, idol of the Horn priests; 3, prayer stick; 4, corn tablet; 5, standard put at hatch of kiva; 6, 6a, fire hearth and fire stick; 7, six ears of corn corresponding to the six cardinal points north, west, south, east, above, and below.



M. Wright, G. L. S.

PHALLIC DANCE OF THE TATAUKYAMU, ONE OF THE FOUR FRATERNITIES OF PRIESTS WHO CELEBRATE THE HOPI NEW FIRE RITE.

Phallic symbols are depicted on the backs, breasts, and thighs of the men. They hold imitation vulvae in their left hands; ears of corn in their right. The leader has kiva standard in right hand; all have cottontail rabbit tails in their ears.



THESE TWO MEN REPRESENT THE ALOSAKA OR PRIESTS WHO PERSONATE MOUNTAIN SHEEP IN THE WALPI NEW FIRE RITE.

They are begging meal with which they later make trails on the ground to certain shrines, or "open the trails."

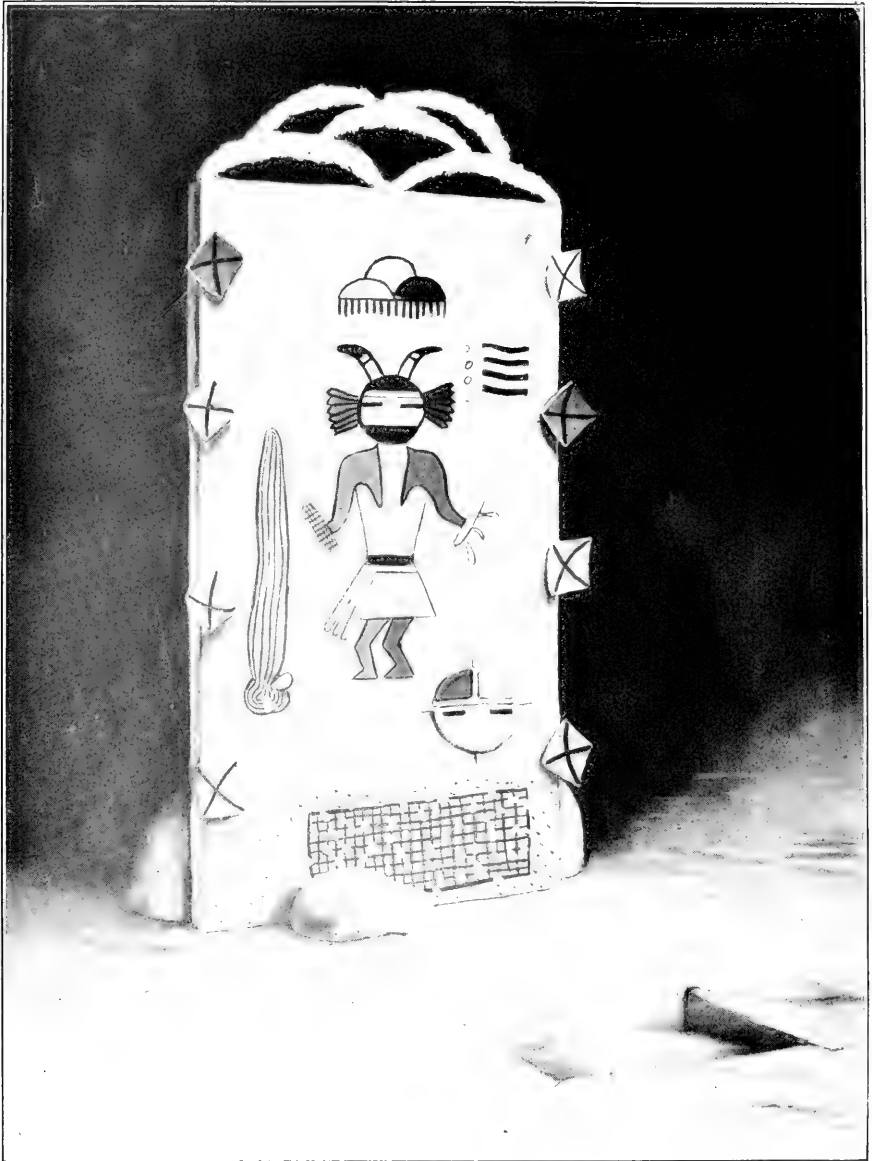

SCREEN USED IN THE WINTER SOLSTICE CEREMONY AT ORAIBI.

The main figure represents Alosaka, the supernatural of the Horn priests.

hands.¹⁰ The acts of this society and the nature of the symbolism leaves no doubt of the meaning of the rite, a counterpart of which occurs in the dances of the sister society performed in October in which decorated slabs are carried in their hands.

On the closing day of the new fire festival, before they dispose of the fire embers, an event occurs which embodies the explanation of the whole ceremony. Early in the morning six young men of the Horn Society, wearing their typical costume (pl. 5), took all the nakwakwoci or prayer feathers from their own kiva and went in pairs to all the other kivas, where they were given like prayer objects of the other societies. The disposition of these prayer objects is the significant point. Two of the couriers went to Dawapa or Sun Spring and left prayers for the Sun or Sky God, two went to the shrine of Tala-tumsi, the Walpi Alosaka or Germ God, and two went to her old shrine from which on account of its exposure to hostiles the Hopi removed her idol many years ago. The Sun or Sky God, the Fire God, and the Gods of Germination are those to whom the Hopi direct their devotions in their new fire ceremony, and in the shrine of these they deposit their prayer offering on the last day of the festival.

Idols representing the germ god known as Alosaka may be considered at this point. We know of two of these Alosaka idols from a shrine near the ruin, Awatobi, which have been removed from their ancient fane and are still in use at the Middle Mesa.

These idols are instructive as showing the antiquity of the Alosaka cult. Another evidence of the prevalence of erotic dances at Awatobi in honor of the creative power of nature is an Awatobi bowl, on the inner surface of which is depicted the dance of the Tataukyamu, a society still strong at Walpi. From the nature of these designs they are not here reproduced, but they support legendary evidence that this fraternity was introduced into Walpi by Awatobi clans, the female members of which were saved at the massacre of this pueblo in the autumn or winter of 1700. As corroborative also of the existence of this prominent priesthood in that ill-fated town is the legend that the Mamzrauti,¹¹ a society in whose ceremony personations of the Tataukyamu are also introduced, was also derived from Awatobi.

From drawings of Alosaka on cult objects (pl. 6) and the rites that are performed before altars in which these figures are the central objects there is little doubt that Alosaka worship is simply another name

¹⁰ Wooden phalli in a fire dance of the Pima-Maricopa Indians, near Casa Grande, are mentioned by Mr. Herbert Brown, *Amer. Anthropol.*, vol. 8, No. 4. Stone phalli are reported from ruins in the Gila Valley and were probably used in the fire dances of the builders of Casa Grande.

¹¹ The Mamzrauti: a Tusayan ceremony, *Amer. Anthropol.*, Vol. V, No. 3, 1892. This elaborate festival, formerly of nine days' duration, has become extinct in Walpi since my studies were made.

for worship of the Germ God. The figurine used in the November new fire ceremony is called Talatumsi, related to Alosaka, and is under the care of a group of priests called the Aaltu, who take the prominent part in that rite.¹² Of this there is linguistic evidence, the element ala, the first component in Alosaka and Aaltu, means horn, and the priesthood sometimes called the Alosaka wear mountain sheep horns (pl. 7) on their heads. Their idol, called Talatumsi, is without horns (pl. 3, fig. 2), and is ordinarily kept in a walled-up shrine situated at the base of the Walpi mesa and is one of the most important idols used in the new fire ceremony. Another idol used in this ceremony has no human form, but is simply a log of petrified wood (pl. 8, fig. 6) kept in an open shrine not far from the trail to the Middle Mesa. This idol, called Tuwapontumsi, is never removed from its shrine, but shortly after the making of the new fire is visited by the priests for prayers. While Talatumsi is related to the two wooden Alosaka images of Awatobi, the log of fossil wood (pl. 8, fig. 6) may represent the hideous sister of Masawu, God of Fire.

There remains one other personation which needs definition before we can understand the Hopi fire cult, and that is a being known as Masawu, who is sometimes called the Skeleton God or God of the Dead. This being is also called the God of Fire, which is equivalent to calling him a God of Life. The incongruity of calling the same being god of the living as well as of the dead may be explained when we point out that the living breath bodies inhabit his realm, the underworld, the future home of those whose bodies have died. The student of Hopi mythology finds several such incongruities in names of supernatural personages.

Among the Hopi, as among many people in primitive culture, the great elemental gods have many names referring to attributes. These are synonyms often descriptive of personations, and if these names were taken to indicate different gods, we would be led to believe that they have a pantheon far greater than they do. A study of the symbolism of idols shows that many of these names are eponyms. The knowing priests sometimes understand this and the comparative student may often equate these names by studies of cult objects, altars, and effigies. It thus happens that the Sky God may also be a god of life and have received a special designation as the dominant personality in a fire ceremony.

On account of the fact that the Hopi population has descended from increments that came from different directions, they have rites for the same purpose that differ in detail. There are two fire ceremonials—one already referred to, performed in November, introduced

¹² The elaborate new fire ceremony, known as Naacnaya, from the initiation of novices by head washing, is described in an article, *Journ. Am. Folk-Lore*, Vol. V, No. 18, 1892.

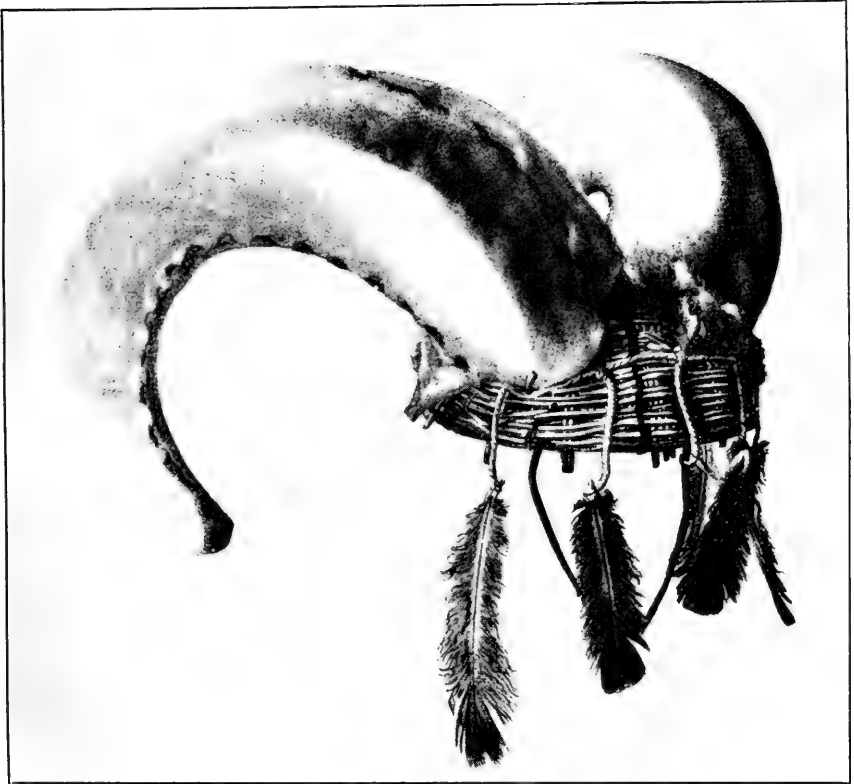

HELMET WORN BY A HORN PRIEST (AALTU) IN PERSONATION OF THE MOUNTAIN SHEEP.

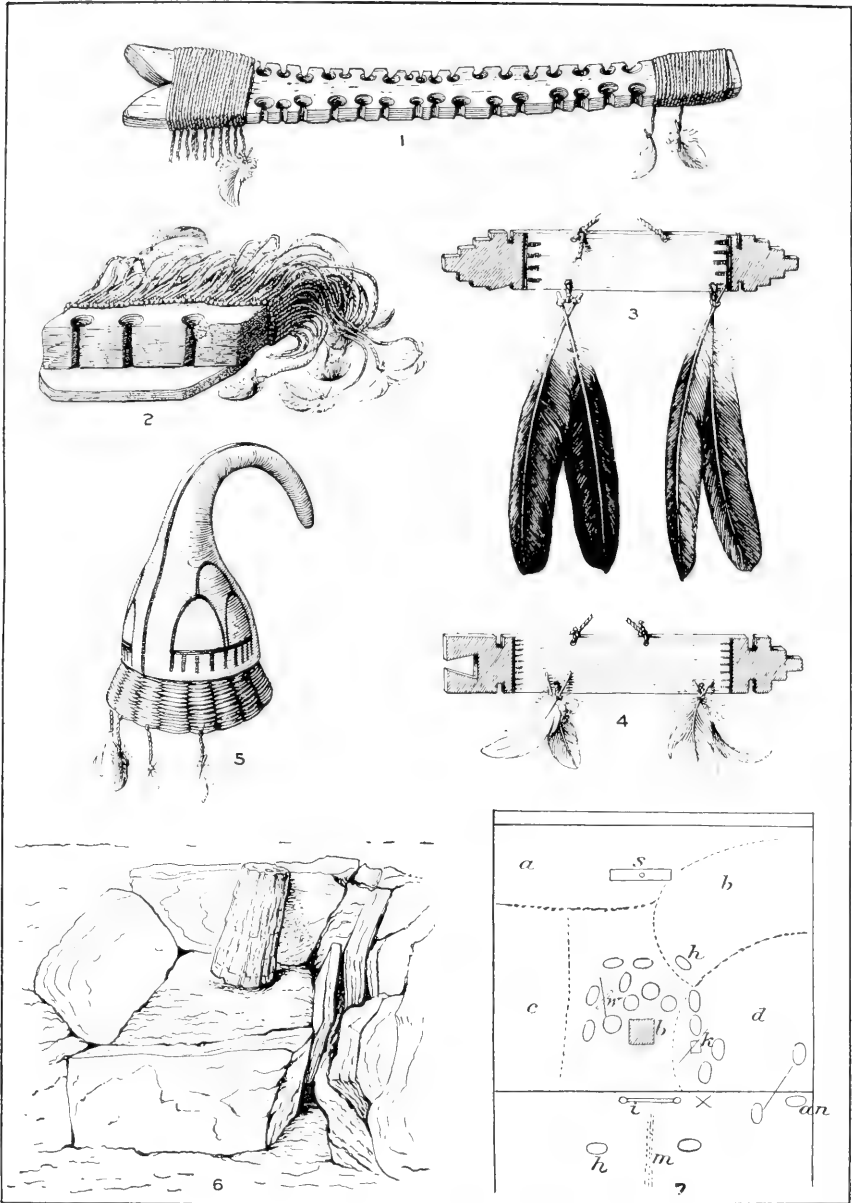

HOPÍ NEW FIRE PARAPHERNALIA.

1, fire hearth made of wood; 2, fire hearth made of stone; 3, moukoku or badge of the Tataukyamu; 4, moukoku of Aaltu or horn priests; 5, helmet of the Kwakwantu; has single horn and rain cloud symbol; 6, shrine of earth altar-elder-sister; 7, position of new fire celebrants; *a*, "Old" priests, *b*, Horn priests, *c*, Tataukyamu, *d*, Kwakwantu. *an*, Anawita (Fire god), *m*, line of meal; *s*, symbol of entrance to underworld; *h*, Alosaka; *k*, *w*, fire hearths; *i*, ladder.

by clans from Awatobi, and another, quite different in nature and origin, called the Sumaikoli, which was brought from the east and south. The dances following the act of making new fire in the latter are much simpler than those in the former. The Sumaikoli does not belong to the ancient Hopi ritual but is a later addition and is akin in name and nature to personations in the ritual of the Zuñi¹³ and pueblos of the Rio Grande. The masks worn by the personification of Sumaikoli fire rites indicate this relationship very plainly and are arranged in a row in the accompanying plate (pl. 11), forming a rude altar before which the rite of the new fire is performed. After the rite is performed in a secret room the fire is carried by means of

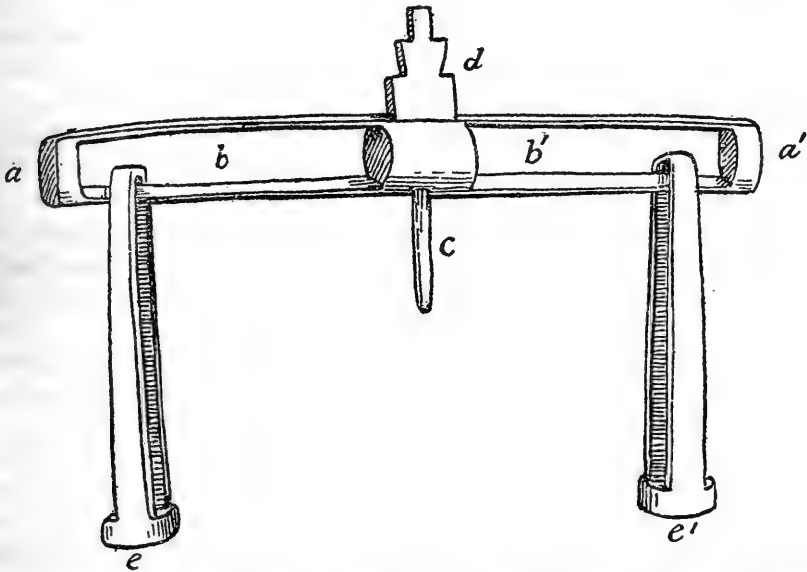

FIG. 1.—Framework rattle found in a cliff house in Chelly Canyon, N. Mex. A similar object is borne by the leader of the Yaya priesthood at Hopi in the summer new fire ceremony. *a*, Wooden frame; *c*, handle; *d*, rain-cloud symbol; *e*, *e'*, sliding weights.

torches to piles of firewood and bonfires are kindled in the pueblo around which exercises are performed by a priesthood called the Yaya, now practically extinct. The masked man who carries the fire is called Kawikoli, and the Yaya priest who accompanies him bears a unique wooden frame for a rattle (fig. 1).¹⁴

The Hopi method of kindling the ceremonial fire is by means of a wooden fire drill and hearth. The hearth has a series of pits near one edge, as shown in the accompanying figures. (Pl. 8, fig. 1.)

¹³ None of the new fire rites of any of the pueblos of the Rio Grande have been sufficiently well described for comparisons.

¹⁴ Two of these objects found in the cliff houses of the Chelly Canyon, now in the Brooklyn Museum, have been described in the *American Anthropologist*, n. s. Vol. VIII, No. 4, 1906.

Similar fireboards have often been figured without slots on the side of the pit. This slot is essential and is necessary to kindle the fire successfully, as through it the spark falls on the tinder placed under the board. The fire when kindled is sacred and must not be polluted by secular use; no one may light a pipe or cigarette from it; it is customary for the priests to deposit the ashes of the new fire in a special place, and when that is done prayer meal is sprinkled upon these. These ashes are carried in fragments of watermelon rind. The fuel used in the fireplace to feed the sacred flame is also prescribed. The sacred fire is borne from one sacred room to another or to the four shrines, north, west, south, and east, by means of a torch¹⁵ made of cedar bark.

Every man on the East Mesa belongs to one of four fraternities that take part in the ceremonial kindling of the fire. Two of these serve as chorus, while the other two rotate the drills. The same societies celebrate the sun serpent drama at the winter solstice at Walpi, which, of course, is significant and incidentally shows the southern origin of the rite.

The Fire God is the chief supernatural being personated at this time. It was my good fortune to study this personation in the winter ceremony, and a description of him and his acts at that festival is important in a revelation of his characteristics.

The advent of the Fire God to which I refer occurred at night and on the evening when this being appeared all fires in the pueblo were extinguished, doors of the houses were closed and everyone, especially children, retired to the rear rooms and not a person was seen on the street. Word was passed around the day before that all should keep indoors, as it was bad to look upon this personage as he passed through the pueblo. The priests gathered in the kivas to await his arrival. In the kiva two helmet masks made of a huge undecorated gourds painted black lay on the floor awaiting the advent of the men who were to wear them. The surface of these masks was undecorated but covered with glistening micaceous hematite.

The Fire God was represented (pl. 8, fig. 7, *an*) when the fire was kindled in the new fire ceremony in November. At that time he was unmasked and personated by a man concealed behind a blanket held by two assistants. When the new flame had been transferred to the fireplace the blanket that concealed him was dropped and he stepped forward and dropped his offering of pine needles into the sacred flame, an act followed by all the associated priests.

¹⁵ Similar torches have been repeatedly found in cliff dwellings. From a square room on the plaza above Kiva B in Square Tower House, Mesa Verde National Park, I dug out about a half dozen of these torches.

I have seen the Fire God personated in the winter solstice ceremony, when the assembled priests gathered about a low fire and greeted two representatives of this being with prayers. Each bore an archaic planting stick or dibble and wore black gourds on their heads; they knelt on the floor in the attitude assumed by the Hopi in planting, and went through the motions of a planter depositing seed corn. At the conclusion of this act all present prayed to them for abundant crops, after which they left the kiva. The new fire was not kindled at this time, but the fire gods assume the rôle of the planter, as the symbolism plainly indicates. The prayers to them were evidently for the same purpose as those to the sun for the growth of the crops and the fertilization of the seed corn.

Subsequent to the fire kindling I followed two of the societies which made a pilgrimage to the site of old Walpi, called Ash Hill Terrace, situated at the base of the mesa on a terrace at its west end. Mounds indicating a large ruin mark this site, and around these about midnight the procession groped its way in silence.

"Down there is the sipapu, where they dwell," said a priest, pointing to the earth; "there the ancients dwell. We are now paying reverence to them." Then they prayed and smoked, after which the cliffs resounded with loud shouts, cries, and calls of unknown meaning. The procession of priests then filed away to the neighboring shrine (pl. 8, fig. 6) containing the idol of the "Earth Altar Woman,"¹⁶ represented by a log of fossil wood surrounded by a low rude stone wall. These exercises took place at the dead of night, with only the stars to witness what occurred at these shrines.

On the east side of the mesa below Walpi, near the northern point, there descends a precipitous trail which is known as the ladder trail, from the fact that formerly a ladder stood on its steepest part. As that trail runs along the terrace of the mesa it passes to the right of a huge boulder in which is eroded a cave, walled in front. This is the shrine of a god of germs called Talatumsi,¹⁷ whose wooden idol, clothed in a white ceremonial blanket (pl. 3, fig. 2), sits there throughout the year. To it annually the new fire priests make offerings, but quadrennially it is taken from its home and carried to the mesa top by one of its priesthood named the Alosaka or Horned Society. The identity of the name of this priesthood at Walpi with that of the idols at Awatobi lead me to believe that the idols belong to this priesthood.

As this figurine plays an important rôle in the events following the making of the new fire, it may be well to consider somewhat specifically who it represents. It is in the special custody of the

¹⁶ Tuwa, earth; ponya, altar; tumsi, elder sister.

¹⁷ Tala, dawn; tumsi, elder sister.

horned priests, whose chief transports it to the kivas and returns it to the shrine on the days following the ceremonial fire making. The two idols with horns on their heads had a similar shrine under the ruin Awatobi. These idols, now at the Middle Mesa, are called the Alosaka, or the Gods of Germination. There is every probability that Talatumsi, like Alosaka, is the supernatural being connected with germination. In the winter solstice ceremony at Oraibi a screen (pl. 6) on which a figure of Alosaka is painted is introduced, and at Walpi figures of Alosaka frequently occur when the God of Germs is represented.

Many references to this supernatural occur in legends, and the cult is vigorous in all the Hopi pueblos, especially at the time of the new fire ceremony. Although their idol represents the Germ God, it is not the only objective representation of this being.

In many Hopi altars the Hopi have a "cone" made of wood or clay, the surface often inlaid with a mosaic of maize of different colors, remotely resembling a half ear of corn. The surface of these cones is sometimes painted to resemble corn, or they may have terraced representations of a rain cloud attached to their tops. They represent Mui-inwu, which appears to be another name for Alosaka, the Germ God. The significance is best shown in the winter solstice rites at Oraibi, where these cones are placed at the ends of lines of sacred meal on the kiva floor. A man personating a bird (the Sky God ?) struts around the room, encircles these objects, and leaps over them, while the priests sprinkle the cones with meal, symbolic of prayers for growth of crops and abundant rain. The many other rites that are performed with these objects indicate that they are regarded with great reverence. They are survivals of very ancient idols, as several similar objects made of stone found in cliff ruins on the Mesa Verde are so similar in form that they have been regarded as practically the same.

It may be said that this form of idol is the only one used in common by cliff dwellers and modern Hopi. The elaborately carved wooden images of anthropomorphic form that figure so conspicuously on Hopi altars are not recorded from the cliff dwellers, nor have we yet found examples of the complicated forms of altar uprights of the Walpi altars, which lead me to doubt whether the prehistoric pueblos used elaborately carved figurines. It is much more probable that the figurines were suggested by the santos introduced by Catholic missionaries. In the Walpi altars of the Snake and Antelope priesthoods introduced by clans from the north there are no anthropomorphic figurines, but the snake altar at Oraibi has two anthropomorphic images.¹⁸

The upright stone slab called the Butterfly Virgin that stands back of the antelope altar in the Walpi snake dance, appears to be typical

¹⁸ One of these wears a netted cap similar to one found by Doctor Kidder and Mr. Guernsey in the San Juan area north of the Hopi.

of primitive pueblos unaffected by white influence. Possibly the cliff dwellers formerly had elaborate altars, the stone idols of which they carried away when they deserted their eyrie dwellings. Sacred paraphernalia that could be moved would certainly be the last to be left behind, but the heavy stone idols (fig. 2) representing symbolically the Germ God could not be transported far by a people without domestic animals, and, falling in the débris, are now excavated by the archeologist. The Hopi ceremonies which have the most elaborate altars are ascribed to clans that came from the south and east, where the influence of the Catholic missions is most pronounced.

The student of the winter solstice sun ceremony at Walpi and of the new fire rite at the same pueblo is continually reminded of their connection, and at Oraibi it is even closer. The fact that the same societies take prominent parts in both shows the intimate connection of sun and fire worship among this people. It is perfectly logical from the point of view of primitive man that as the sun is the source of heat, sun rites should be connected with those of fire. The analogies that associate heat with life are equally obvious to him. The living human body is warm; the corpse is cold. Heat, life, light, and fire are directly associated and may be re-

garded as synonyms. The rite of kindling the new fire is connected with those for creation of heat. The worship of the sun shares with that of fire a common purpose, even if the rites of one or the other are more elaborate. Fundamentally, sun and fire worship are readily considered phases of a reverence for life and a desire for its production.

Fire worship of the Hopi, as shown by objective and other evidences, originated in the most remote past, long before several other specialized cultural features, and possibly before the cultural modifications which now designate this tribe had developed. It may be said that it had a prominent place in the dawn of religious customs and be-

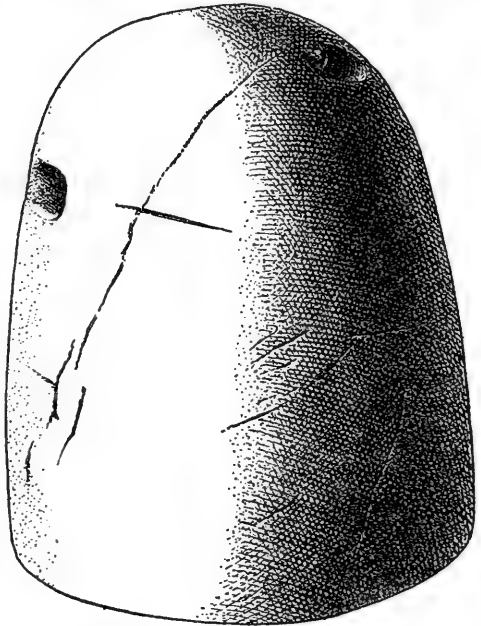

FIG. 2.—Stone idol from Mesa Verde pueblo, Far View House. Supposed to be an idol of the god of germs.

liefs. Earliest man was equipped with a knowledge of how to make fire when he came into the Rocky Mountains, and no doubt had the same idea of the magical power of this element. We see in the complexity of details in their present rites the result of many centuries of development under the influence of many environments, but throughout all superficial changes there is the initial idea that dates back to the time when fire was discovered and regarded as life. The modifications in details of the fire rite are secondary and may be regarded as a result of local conditions.

The culture of the Hopi Indians is wholly American. It is founded on the food supply, maize, a cereal that America gave to the world, and shows the result of centuries of modification by a strictly American environment. The Hopi myths and rituals recognize unmistakably the dependence of their culture on this plant. They designate corn as their mother; the baby when 20 days old is dedicated to the sun and has an ear of corn tied to its breast. A boy initiated into the tribe has an ear of corn for his mother. Every novice initiated into a religious fraternity has, as his symbolic mother, an ear of corn. The symbol of chieftainship of a religious fraternity is an ear of corn with appropriate wrapping which is said to have belonged to the society when it emerged from the underworld. That of the Flute chief has a wooden base on which are painted corn and rain cloud symbols like the germ fetish above mentioned. The chief calls it his mother, and regards it not only as his most precious heritage but also as his official badge.

The maids to whom myths ascribe the gift of corn are the superlative personages in the pantheon of the Hopi, and about them clusters an elaborate ritual in which they are personated. Idols of the corn maid appear on many altars, sometimes realistic, often conventional, always synonymous with the Hopi God of Germs, the symbolic personification of the earth. A fetish representing this supernatural is the Germ God and has the form of a gigantic ear of corn made of clay, stone, or wood, or painted with corn symbols.

The supernatural being called the corn maid or Calakomana is nowhere better personated than in the public dances of the Mamzrauti, sometimes called sister society of the Tataukyamu. This personation is shown in the accompanying plate (pl. 9). She is also known as the Palahikomana and has other eponyms, but Calakomana is the name generally used to designate this beneficent personage. The personification of this corn maid is one of the most striking in the rites of the sister society of the new fire fraternities of priests.

Fire is directly concerned in the sociology and the evolution of society among the Hopi. The most ancient social unit recognizable in primitive society is determined by the hearth and was composed of those who used the same fire. This family group may have been



THE TWO RIGHT-HAND FIGURES ARE THE CORN MAIDENS (PALAHIKOMANAS) OF THE TABLET DANCE.



THE ALTAR OF THE LESSER MAMZRAUTI OR WOMAN'S TABLET DANCE.

This elaborate ceremony of nine days' duration has been abandoned. The only description was published in *American Anthropologist*, Vol. IV, No. 3.

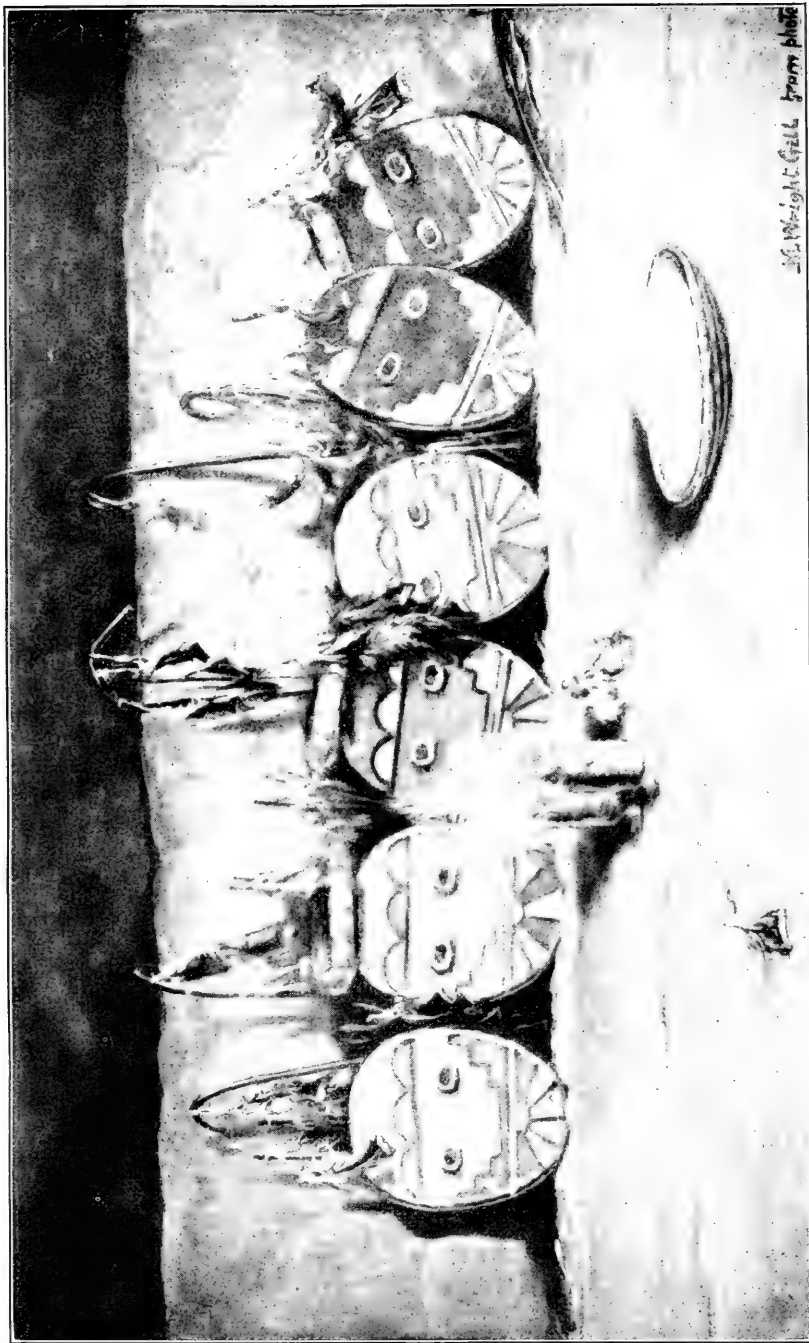

THE SIX MASKS WORN BY THE SUMAIKOLI.

In front of the third from the left is the ceremonial bundle or the palladium (tiponi) of the Yaya priests. From it is stretched along a line of meal a feathered string, pathway of blessings.

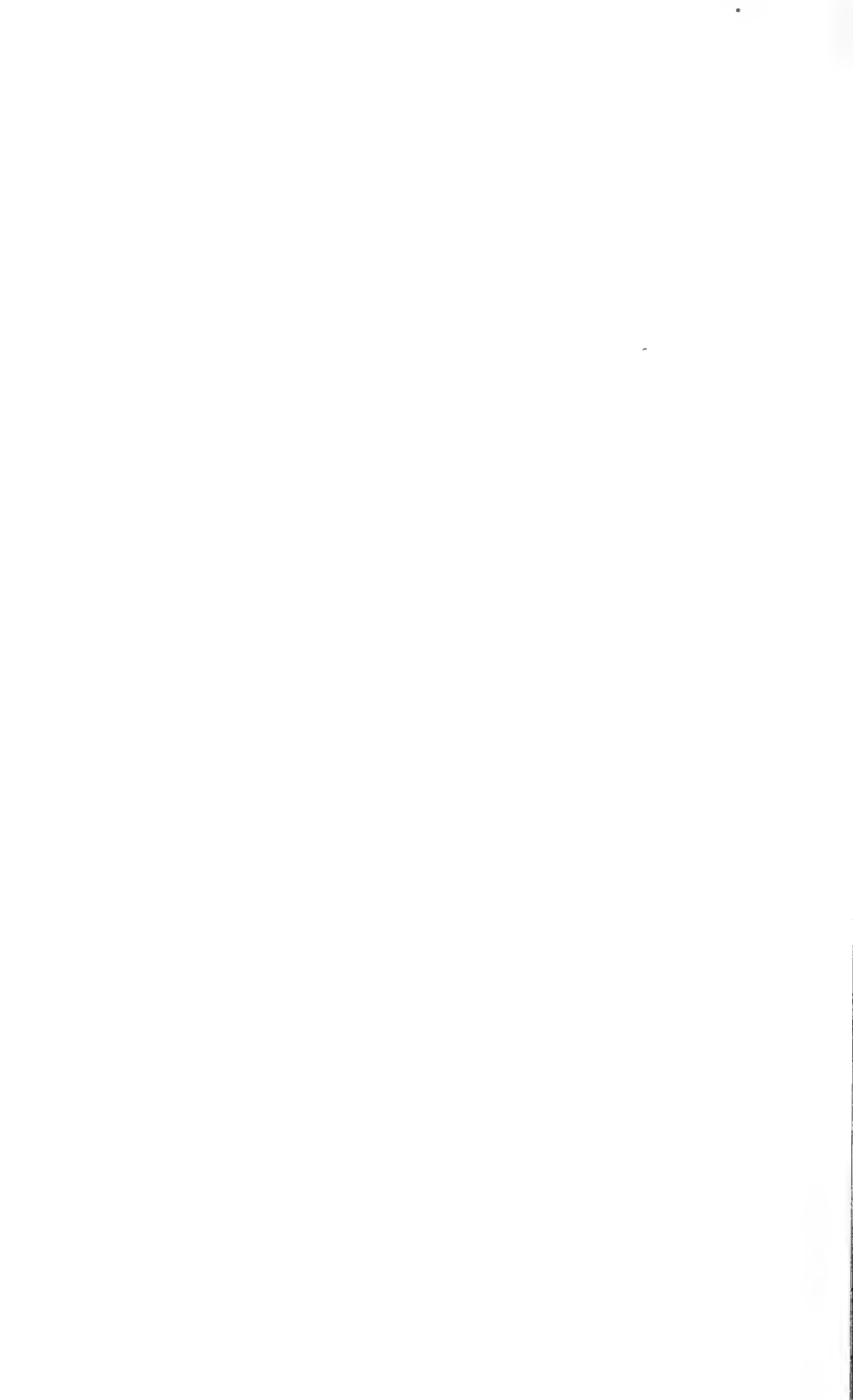

what is ordinarily called the clan, but whether the original unit was clan or gens, matriarchal or patriarchal, it was a group that used the same hearth. The common fire was the bond of social union, and it is natural to suppose that a religious rite should have arisen among relatives directly concerned with that fire. There would seem much to support the theory that the earliest house was constructed by man to shield his fire or a cave sought for protection or shelter of this fire as well as to store a food supply. We thus owe the beginnings of architecture to fire, and the social unit determined by a common hearth would probably date back to a time when the social units called clans and gens originated, if not earlier.

Among agricultural peoples the preparation of cereals for food, including the heat of fire for cooking them, need much care. The food protectors, or guardians of the fire, assume importance as an ancient features in the worship by a social unit determined by the fire. The lares and penates came to be specialized fetishes of the "hearth units" of society, and by analogies these penates were ancestral and, as connected with the life or fire of the "hearth units," were incipient fire gods.

A few references to the lesser new fire ceremony bring out certain aspects of the fire cult that are obscured by the more elaborate ceremonies. Save in the manner of kindling the fire, the lesser new fire ceremony, called Sumaikoli, is different from that performed in November. The following events were noticed at Walpi on the single day of the lesser new fire ceremony of the Hopi. The fire was kindled by frictional methods, using the customary fire drills, and was later carried by a being called Kawikoli and other couriers to the four shrines of the fire god. Previously to the act of kindling fire the priests occupied their time in the manufacture of prayer sticks and their consecration by prayer-song, and, what is significant, an invocation was made to Mother Earth called the Spider Woman,¹⁹ whose personality was symbolized by a bundle of black sticks. The tiponi or badge of the chief is regarded as the "mother of the priests." The most significant portion of the rites is accompanied with songs before the row of Sumaikoli masks shown in plate 11. During the songs the chief priest kneels on the floor by the side of his fetish, puts his mouth near the sipapu or ceremonial hole in the floor near by, and yells to the Spider Woman several times the, to us, meaningless syllables "Ta-a-he-he-he."

The prayer sticks and the prayer fire were carried to the four shrines of the Fire God, Masawu, by as many couriers, each one of whom was naked and carried a cedar bark torch lighted at the fire newly kindled in the kiva. With these lighted torches in one hand the carriers shouted as they ran through the pueblo and rushed

¹⁹ Kokyan-wügti, another name added to the long list of appellations of the earth being.

down the trail to the shrine, situated in the foothills west of the pueblo. When they arrived there they placed the prayer sticks in the shrine, and having hastily gathered a pile of such twigs and other bits of wood as were available, they ignited it and then hurriedly left the place, making a quarter circuit of the mesa to a second shrine, situated west of the village, where they made a second fire, and so on until they had made a circuit of the mesa.

As recorded above in the account of the greater rites, this fire is produced by friction, or, as commonly explained, by rubbing together two sticks. But sufficient heat to produce fire can not be produced by simply rubbing two sticks together. They must be placed in such a way that the friction is concentrated on the smallest possible surface. One may rub two sticks until the muscles refuse to respond and not even produce smoke. Consequently, the invention of fire making was practically how to produce heat by concentrating friction at a point. This was accomplished by primitive man in several ways, and among the majority of our Indians it was by rotation of a rod held upright in a depression in a hearth held horizontally. The twirling motion of the vertical stick is accomplished among the Hopi by the palms of the hands, the friction necessary for heat being produced by a downward pressure of the hands. The heat thus generated by friction is great enough to ignite some tinder, as corn pollen, and by this primitive method fire is made in a very short time by expert celebrants of the new fire rite.

The two fire implements or sticks by which fire is generated are supposed by the Hopi to have different sexes; the fire drill is male, the fireboard is female.²⁰ The fire, therefore, is generated by a union of male and female objects, and in this particular the analogy with life is preserved. In ceremonial fire rites corn pollen is added to the slot where friction is generated, which is highly significant. Fire, like life, is generated by the union of male and female elements, and the way of making fire is symbolic and directly concerned with the Hopi interpretation of fire as a living being. But this relationship comes out in the clearest light in the association of rites of procreation with those of fire, which appear in the summer fire ceremonies of the Hopi. In these rites we recognize a worship of the generation principles of nature similar to that which occurs in the worship of mother earth and father sun.

We have in addition objective symbolism and ceremonies that have been transmitted in the form of myths. These surviving explanations are preserved in linguistic and philological data by which to check up interpretations by living devotees. The conclusions arrived at by a study of the mythology as told by priests, although of great

²⁰ Although all things have sex in Hopi conceptions, this conception is a symbolic one and not realistic.

importance, is supplemented by interpretation of many things on which the legends are silent. Living priests often do not know why they perform certain rites, for they are not antiquarians and no sacred books exist among them; explanations that have survived have been transmitted by memory and have lost or have been modified much in transmitting. Individual priests have certain definite functions to perform in a great ceremony, and while they may know the meaning of these they are densely ignorant of other rites, and they often confess that the rites are meaningless to those who perform them. "We sing our songs, say our prayers, because they have been transmitted to us by our ancestors, and they knew more than we what is good." Rites practiced for a long time are looked upon as efficacious, and that to them is sufficient evidence that they are the best for the purpose.

The rite being conservative, it is less modified in transmission than the myth, and as the symbol is most tenacious we may look upon idols as of ancient provenance and practically unchanged from one generation to another. A change in their symbolism would greatly offend the conservative element in the priesthood, for many idols are heir-looms, and we may justly suppose that their form dates back to a very early cultural development, but it is undoubtedly true that more elaborate changes in form of idols and symbols have from time to time been introduced as ceremonials have become more and more complicated.

The discovery of how to create fire artificially dates so far back in the history of human culture that in the myths of many peoples fire is said to be the gift of the gods or stolen from them. In the course of transmittal from one generation to another these legends have often become very much modified by local and secondary characters. There has grown up a priesthood, male or female, as guardians of the new fire. The eternal fire has been associated with the perpetuity of the life of the state, and the necessity of keeping an eternal fire led to the Prytanean at Athens, the temple of Hestia at Rome, the national fires of the Natchez, Aztecs, and Incas, where the idea of the life of the state was closely bound up with the preservation of the sacred fire. This thought may have existed in ancient times among the cliff dwellers, but the maintenance of an eternal fire long ago died out in the Hopi kivas.

There is a large literature dealing with the new fire ceremony of the Aztecs, and pictures and descriptions of the God of Fire give a good idea of his symbolism. Among this people we have a fire serpent god, suggesting the connection of the worship of the sun serpent and that of fire. Like all primitive races where sun worship is dominant, the Aztecs held fire in great reverence, and the Fire God was

considered father of gods and men, one of the oldest supernatural conceptions in primitive culture.

As above described, the Hopi Fire God, Masawu, sometimes carries a dibble or planting stick, showing his intimate relation with planting; his personification in the sacred room goes through the act of planting, prayers being said to him for the successful germination of corn and other seeds.

It would make an interesting article to treat fire worship among our aborigines in a comparative manner and show the interrelations, resemblances, and differences as well as the distribution of this cult. Little can now be rescued as far as observation goes among certain tribes; in others there are still unrecorded survivals. That it was once as widespread as the American race seems a logical conclusion from what is known. What modifications have occurred and how many of these are due to environmental conditions is a chapter of culture history that can not now be written, but it would have been worthy of intensive investigation. From the time man emerged from the brutes he has possessed a knowledge of how to artificially create fire. This invention has aided him in his upward cultural growth more than any other, and yet few ethnologists have turned their attention to its influence on the history of the Indians.

We are able to trace the evolution of the fire cult from its earlier stage among the cliff dwellers to the modern pueblos. My archeological work last summer (1920) makes it possible as never before to present the evidences of its existence among the cliff dwellers of the Mesa Verde National Park, where the culture of certain modern pueblos originated.

There are many American cliff dwellings of magnitude, as those of the Canyon de Chelly and the Navaho National Monument, from which evidence of fire worship has been observed, but rarely except in the Mesa Verde do we find a specialized building for this cult that may be called a temple. There is evidence that the building in the Mesa Verde identified as a fire temple (pl. 12) was not a habitation; no household implements were found in the extensive excavation made in its court or rooms, and its architectural form is unique. There was no evidence of former grinding bins, no fragments of pottery, no domiciliary utensils. There was nothing in the débris to show that man ever inhabited it. This failure to find these and other utensils is negative evidence; but the identification is supported by architectural data. The existence in the court of a central fireplace full of ashes, and the character of paintings on the walls recalling symbols that have survived in the New Fire rite of the Hopi and other pueblo tribes, are the positive evidences of its former use. This building was a fire temple devoted to the fire cult, having a special room for kindling of the new fire and a fire pit in the court for public dances con-



EASTERN END OF THE COURT OF FIRE TEMPLE, MESA VERDE NATIONAL PARK.



WESTERN END OF THE COURT OF FIRE TEMPLE.

Mesa Verde National Park.

nected with fire. Whether fire was conserved in this pit is as yet in doubt, but the existence of a fire temple among the cliff dwellers implies an even more highly complicated fire ritual than among the Hopi, their more or less modified survivors. It might be added that several fire drills have been found in the débris of cliff dwellers' rooms and that one of the fire hearths was found in a cave near Fire Temple last summer. These implements are identical with those still used in the kindling of the new fire at Walpi. The discovery of this fire temple (pl. 13) opens a new page in cliff dweller culture, but we must await new explorations of our cliff house areas for varieties in architecture or other forms of new fire temples before we can determine the nature and extension of the new fire cult.

Mr. Frazer makes the following suggestions regarding the origin of the Aztec fire ceremonial that are pertinent. He rightly styles it "one of the most striking ceremonies the world has ever witnessed. That the fire worship of Mexico, for all its gorgeous and awful pageantry, sprang from the fire on the domestic hearth may be inferred from the Mexican custom, like the old Italian, Greek, Slavonic, and modern Hindu custom, of throwing food and drink into the fire before a meal. The same primitive offering to the fire was common among the savage redskins who never developed an elaborate religious ritual like that of barbarous Mexico." It was a custom among the Hopi up to 20 years ago, and maybe to-day, to make an offering of food and meal to the hearth before certain secular and religious feasts. One of the instances in which this custom has survived is in the feasts following the great ceremonies.

There are several of the great Hopi festivals in which we find traces of the fire cultus, but a consideration of these would extend this article to undue proportions. It is, however, instructive to call to mind that in the biennial snake dance at Walpi prayer-sticks are made and deposited in the shrine of the Fire God. These offerings to this supernatural show the ancient influence of this cult, for the snake dance is one of the most archaic rites of the Hopi. As there is in this startling festival an absence of worship of elemental powers, as the sky and earth, it may be that the reverence here given to the Fire God is simply another form of the widely diffused worship of the power of fertilization and growth of life, or life itself, which permeates the whole ritual. Fire worship is believed to be the oldest cult of the Hopi Indians, possibly antedating sun and earth worship, dating back to the dawn of culture, to an epoch long anterior to the time when their ancestors came to the deserts of northern Arizona.

The fire cult and that of the sun among the pueblos are survivals of two forms of element worship that we can trace back into the past and through archeology know something of their prehistoric charac-

ter. Fire rites are undoubtedly among the most ancient forms of ceremonies among the Hopi. Some of the objects used to-day have been inherited from a time when the Hopi lived in cliff houses. We have, as evidence that the ancient cliff dwellers associated the creation of fire with procreation of life, many symbols of vitality on the walls of cliff houses, but especially pictures of a fire god still personated at Walpi. At the present time the new fire at Walpi is kindled in a kiva or ceremonial room, but my last season's field work at the Mesa Verde has shown that the fire cult had reached so high a development on that plateau that the aborigines had erected a special temple for that purpose. A statement of the nature of the fire worship of the cliff dwellers as revealed by archeological data would make an article of considerable proportions that may not be here attempted.

Several buildings that may have been used as fire temples have been reported from the Southwest, among which may be mentioned the Hopi ruin called Fire House, the "Great Kiva" at Aztec, the Lower House at Yucca National Monument, numerous "great kivas" in the Chaco Canyon, and other ruins.

RACIAL GROUPS AND FIGURES IN THE NATURAL HISTORY BUILDING OF THE UNITED STATES NATIONAL MUSEUM.

By Dr. WALTER HOUGH,
Curator of Ethnology.

[With 87 plates.]

CONTENTS.

	Page.
Introduction.....	612
Tribes of the Arctic.....	614
Dwelling group of the western Eskimo.....	614
Family group of the western Eskimo.....	615
Dwelling group of the central Eskimo.....	615
Family group of the Smith Sound Eskimo.....	615
Group of eastern Eskimo.....	616
Group of western Eskimo.....	616
Tribes of Alaska, western and eastern Canada.....	616
Family group of Chilkat Indians.....	617
Dwelling group of Haida Indians.....	617
Family group of Loucheux Indians.....	618
Dwelling group of the Montagnais Indians.....	618
Tribes of the eastern and southern United States.....	618
Dwelling group of the Chippewa Indians, Lake Superior region.....	619
Chippewa warrior and family.....	620
Chippewa medicine man, Minnesota.....	620
Dwelling group of the Iroquois Indians, northern New York.....	620
Mary Jemison, Indian captive.....	621
The Virginia Indians.....	621
The manufacture of stone implements by the American aborigines.....	622
Dwelling group of the Seminole Indians, Florida.....	623
Statue of the Seminole chief, Osceola.....	623
Seminole man.....	623
Tribes of the Great Plains and Northern Rocky Mountains.....	624
Dwelling group of the Sioux Indians, Northern Plains.....	625
Family group of the Sioux Indians.....	625
Sioux women dressing hides.....	626
Sioux Indian warrior.....	626
Sioux Indian woman and child.....	627
Kau-ku-wash-to-win, the good road woman.....	627
Crow Indian (Siouan Stock) painting a skin.....	627
Nez Perce Indian chief.....	627
Plains Indian travois.....	628
Kiowa Indian children at play.....	628
Dwelling group of the Pawnee Indians.....	628
Dwelling group of the Wichita Indians.....	629
Tribes of the southwestern United States.....	629
Ancient cliff dwelling.....	630
Model of the Hopi Pueblo, Walpi, northeastern Arizona.....	630
Family group of the Hopi Indians, northeastern Arizona.....	631
The Snake Dance, an episode in a Hopi prayer for rain.....	631
Family group of the Zuni Indians.....	632
Zuni women making pottery.....	633
Dwelling group of the Navaho, New Mexico and Arizona.....	634
Navaho Indian blanket weavers.....	634
Navaho Indians making silver ornaments.....	634
Apache man and squaw.....	635
Tribes of the Mexican border and northern Mexico.....	635
Dwelling group of the Papago Indians.....	636
Mohave Indian chief.....	636
Family group of the Cocopa Indians.....	636
Tribes of California.....	637
Dwelling group of the Digger Indians.....	638
Family group of Hupa Indians, northern California.....	638

	Page.
Tribes of Mexico and Central America.....	639
Seri Indian hunter.....	639
Woman of Chiapas, southern Mexico.....	640
Family group of the Maya-Quiche Indians.....	640
Tribes of South America.....	640
Dwelling group of the Carib Indians, British Guiana.....	641
Family group of the Caribs.....	641
Dwelling group of the Goajiro Indians.....	642
Dwelling group of the Jamamadi Indians.....	642
Jivaro Indian chief.....	642
Dwelling group of the Tehuelche Indians.....	643
Family group of the Tehuelche Indians.....	643
Tribes of Africa.....	644
Dwelling group of the Zulu, South Africa.....	644
Family group of the Zulu-Kaffir, South Africa.....	645
Zulu chief.....	645
Berber man.....	645
Ghadames girl (Hamitic family).....	645
Somali man.....	646
Bambara man.....	646
Wachaga man.....	646
Wolof man.....	647
Tribes of Malaysia.....	647
Dwelling group of the Dyaks.....	647
Family group of the Dyaks.....	648
Dyak man.....	648
Family group of the Bontoc Igorot, Philippine Islands.....	648
Family group of the Filipinos, Luzon, Philippine Islands.....	649
Family group of the Negritos.....	649
Tribes of Polynesia.....	650
Dwelling group of the Samoans, Samoan Islands, South Pacific.....	651
Family group of the Samoan Islanders.....	651
Village group of the early Hawaiians.....	652
Maori man.....	652
Tribes of Papua, Australia, and other primitive types.....	653
Papuan man.....	653
Australian man, Clarence River, Australia.....	653
Veddah man and woman, Ceylon, India.....	654
Tribes of Asia.....	654
Mongol man, Mongolia.....	655
Tibetan man, Tibet.....	655
Dwelling group of the Aino, Island of Yezo, Japan.....	655
Aino man and woman.....	655
Korean man.....	656
Arab man, Arabia.....	656

INTRODUCTION.

During the early years of the development of lay-figure groups as a means of illustrating primitive peoples, single figures were constructed for the display of costumes and other belongings, and in time two or more of the figures were assembled in groups. These figures were often rather crudely executed, but were much approved by the public of the period. On the accession of Prof. W. H. Holmes to the head curatorship of the newly constituted department of anthropology in 1898, renewed interest was awakened in this branch of the work. Professor Holmes brought to this work exceptional artistic training, a keen appreciation of the requirements of exactitude, and the faculty of enlisting the interest of others in the tasks in hand. The family groups here illustrated are largely the product of his genius, and the later examples are regarded as serving well the purposes of science and at the same time as fulfilling the requirements of art.

The designing of these groups and directing their preparation and installation was a difficult and exacting task, but one in which Professor Holmes had the hearty cooperation of his associates. Able sculptors were enlisted in the work of modeling the figures, among

whom were U. S. J. Dunbar, Henry J. Ellicott, and Frank Lemon. Theodore Mills modeled some of the single-costumed figures; and certain individual works of sculpture are by John J. Boyle, H. K. Bush-Brown, Achille Collin, M. Herbert, and others. Skilled preparators were employed in the very important work of casting, setting up, and painting the figures, foremost among whom are H. W. Hendley and W. H. Egberts. In designing a lay-figure group the necessary studies of the peoples to be represented are made. Individuals are selected to illustrate the salient features of the people, their arts and industries, their costumes, and their physical characteristics; and such features of their environment as can be utilized within the available space are added. The end sought is to assemble the figures as in a picture, which will tell the story forcibly and at once.

The group when designed, together with drawings, photographs, and other necessary data are turned over to the sculptor and the living model is posed for him. The figure is modeled in clay and from this a cast is made in plaster of Paris. This cast is appropriately painted, costumes are added, and wigs are provided. The figures are then assembled under the eye of the artist and with necessary changes composed into the group. When this is done, the ground is put in, labels written, and the group is ready for exhibition. A group of entire plaster figures in a case 12' by 8' by 9', complete, costs about \$2,500. If the figures are to be clothed, the work is expedited and made cheaper by employing frame work of wood, which is filled out with tow, burlap, etc., and the exposed parts, as the head, hands, and feet, modeled, painted, and added to the figure. In some instances the hands are cast from the living model.

The dwelling groups are constructed from literary and from photographic data, and are not difficult to make. Their excellence depends upon the skill of the constructor and the amount of data secured. They cost, exclusive of case, about \$150. These groups were at first made in the Anthropological Laboratory of the Museum by C. R. Luscombe. Others were later made by contract and of especial note are the Iroquois and Hawaiian models by Mr. I. B. Millner, and the Dyak model by R. K. Middleton.

The simple figures, groups of manikins, and dwelling groups form an important part of the exhibit of ethnology. They are placed in company with the cases of specimens belonging to the arts and industries of different peoples, and thus furnish a unit of striking interest and value for visual instruction in science.

They are also made, so far as is possible, historically correct, and represent the races in the aboriginal state, or in the period before changes due to contact with civilization had modified them. A great majority of the groups depict native life as it can not be observed at

present and are thus valuable as records. The exhibit enables one to form an impression of the characteristics of the principal races of the earth, their village and family life and their arts and industries, with a minimum of effort.

The text of this article is composed of the labels which accompany the exhibits, and these labels strive to convey the necessary facts in clear and simple language.

TRIBES OF THE ARCTIC.

The tribes which are now found in the northern regions of both hemispheres have much in common in appearance and in the arts developed in this Frigid Zone. Since the food here is almost exclusively animal, hunting is as much developed as is agriculture among more southern tribes. In travel and transportation by land and water we find the snowshoe, dog sled, and the skin boat a shade more advanced than are these features in other more favored lands. In general we find the Eskimo and other Arctic tribes in perfect harmony with their surroundings, which is, no doubt, due to their long stay in the cold regions.

The Eskimo have really suffered more from contact with the white man than from the rigors of the Arctic winters. An isolated life of a tribe, while it tends to produce a uniform or recognizable type, is in reality a serious handicap when communication with other peoples opens up.

It is recorded by all visitors to the Arctic tribes of the Alaskan coast that some of their most noticeable qualities are good humor and cheerfulness.

Even in the Arctic the natural conditions of life are unequal. The western Eskimo are much more favorably situated as to food and climate than the central and Smith Sound tribes, or even those of Greenland. This is reflected in the variety and amount of the things which make up their material belongings, which may be noticed in comparing the groups.

DWELLING GROUPS OF THE WESTERN ESKIMO.

Western Alaska.

The western Eskimo live on the Alaskan coast from the Aleutian Islands to Point Barrow. They subsist by fishing and hunting, in which they are very skillful. Their houses are dome shaped, made of earth piled over a cobwork of timbers erected in an excavation in the ground. The entrance is through a tunnel in the winter and a passageway in the summer. Around the interior of the house is a bench on which the people sleep. The cooking is done in a pottery vessel suspended over the lamp. Meat is preserved in a log

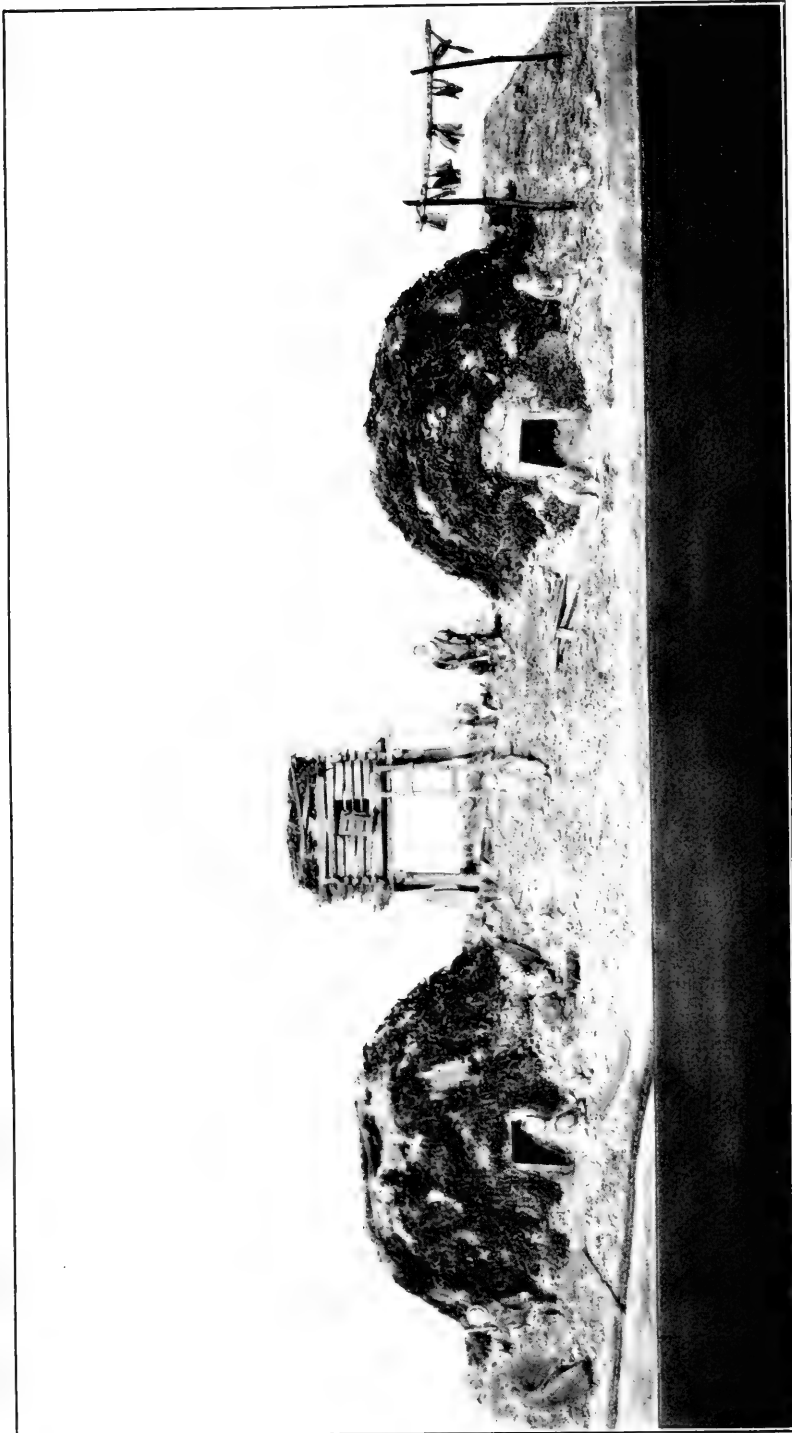

DWELLING GROUP OF THE WESTERN ESKIMO.



FAMILY GROUP OF THE WESTERN ESKIMO.

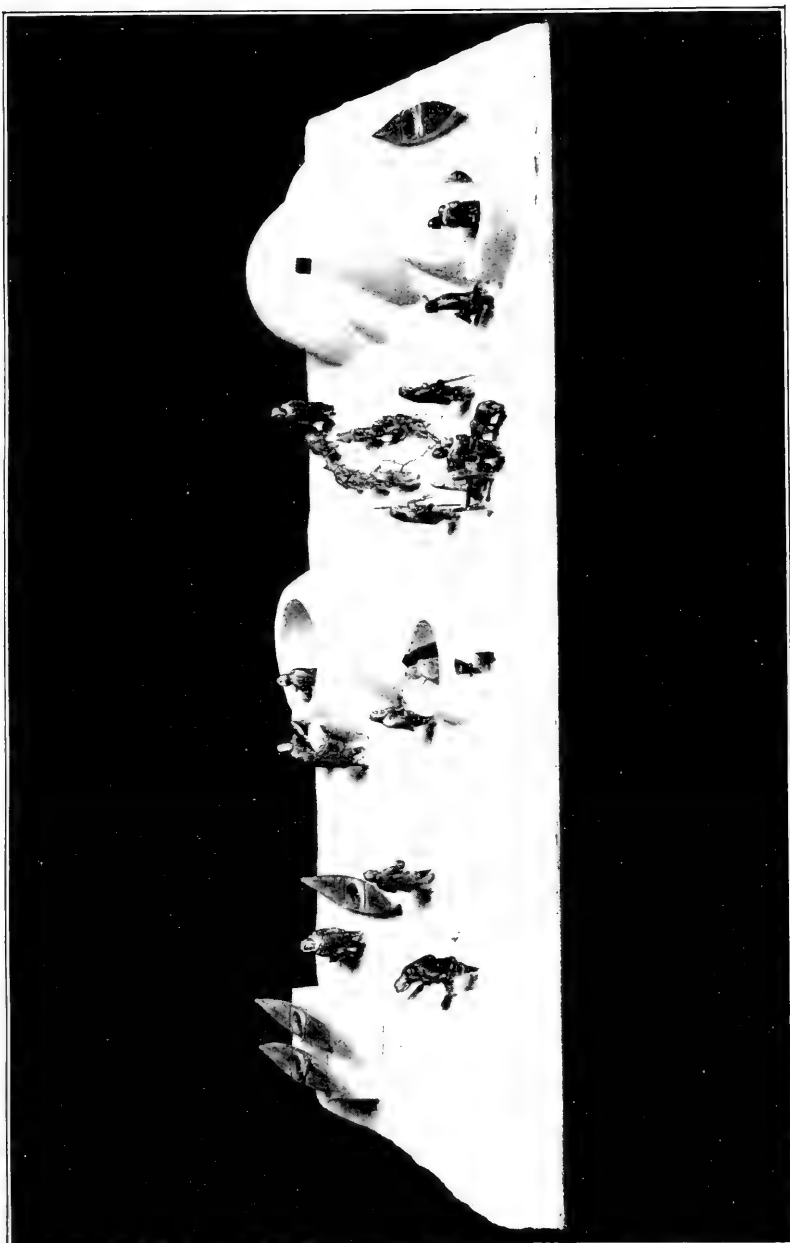

DWELLING GROUP OF THE CENTRAL ESKIMO.



FAMILY GROUP OF THE SMITH SOUND ESKIMO.

storehouse, fish are dried on wooden racks, and skin boats are put out of harm's way on a scaffold erected near the houses. (See pl. 1.)

FAMILY GROUP OF THE WESTERN ESKIMO.

On account of the better food supply and the mild climate the western Eskimo have advanced further than their relatives in the east. Also their arts have felt the stimulus of intercommunication and trade with Asia.

The group here shown illustrates the usual summer avocations and amusements of this people. At the left a woman is cooking meat in the primitive pottery cooking vessel, while another woman is placing dried fish in the storehouse. In the background a warrior with sinew-backed bow is watching a youth practice with the sling. On the right a man seated on the ground is excavating a wooden dish with the curved knife and two little girls are contentedly playing with their toys. The structure at the back of the case is a representation of the storehouse commonly used by the western Eskimo. (See pl. 2.)

DWELLING GROUP OF THE CENTRAL ESKIMO.

The central Eskimo live on the area between Hudson Strait and Baffin Bay. Their winter houses are built of blocks of snow laid up in a spiral manner, forming a dome. The blocks are about 3 feet long, 2 feet high, and 6 inches thick. The main chamber of the house varies from 5 to 12 feet in height, and from 7 to 15 feet in diameter. Over the entrance a square is cut out and covered with seal intestine for a window. The dome is connected by passageways with one or more outbuildings or packing rooms. In the summer the natives fish in the open water; in winter seals are taken by nets set under the ice. Dogs are attached to the sled by separate lines. The clothing of the men and women is made from skins of seal and deer, and consists of outside and inside trousers; jackets, those of the women having hoods; boots, and inside boots or socks made of light deerskin or birdskin. (See pl. 3.)

FAMILY GROUP OF THE SMITH SOUND ESKIMO.

This exhibit shows an Eskimo family of Smith Sound, in north-western Greenland. The Smith Sound Eskimo are called the Arctic Highlanders and are the most northern people in the known world. On account of the ice they abandoned the kaiak, or skin canoe, and use the dog sled for transportation. Their clothing is from skins of seal, reindeer, birds, and dogs, and their houses are of snow. All of their activities are associated with the struggle for existence, and they have little time for art work.

This group represents the family as it might appear in the spring, moving across the ice fields. The young man has succeeded in clubbing a small seal, and the others are having a laugh at his expense for calling out the dog team to haul so slight a load. It is remarkable that these farthest north people are exceptionally cheerful in disposition, notwithstanding the rigor of the climate and the hardships of their life. The woman, who carries a babe in her hood, is about to help attach the seal to the sledge; and the girl, who plays with the dogs, and the boy, who clings to the back of the sledge, are not insensible to the pleasantries of the elder man. (See pl. 4.)

GROUP OF EASTERN ESKIMO.

The eastern Eskimo inhabit Greenland, the shores of northern Labrador, and of Hudson Bay adjoining. In the group here shown will be seen a young woman from southwestern Greenland, her dress resembling that of a Lapp; a man from eastern Hudson Bay, with his harpoon; a woman with her babe, from Ungava Bay, Labrador; and a woman from northern Hudson Bay in garments of reindeer skin. In the first named the people have been under instruction of Moravian missionaries many years. The male figure represents the native right-hand man of the intrepid whalers who, before the discovery of coal oil, ransacked Hudson Bay for oil and baleen. The woman with the babe and the one on her right hand are dressed in aboriginal costumes of reindeer fur, little modified by outside influences. The loose, roomy garments correspond with those figured by the early voyagers. The eastern Eskimo are also interesting on account of their association with the exploring expeditions sent out in the last century to search for the northwest passage and the North Pole. (See pl. 5.)

GROUP OF WESTERN ESKIMO.

This group represents a woman from the Anderson River region, Canada, dressed in deerskin, with her child standing in front; a man and a woman from Point Barrow, also dressed in deerskin; a man from St. Michaels, Alaska; and a woman from Kadiak Island wearing a costume made of spermophile skin and ornamented with marmot and beaver's fur. (See pl. 6.)

TRIBES OF ALASKA, WESTERN AND EASTERN CANADA.

The groups represented here exhibit the principal races of Alaska and Canada in the vast stretch from the Pacific to the Atlantic. They are also of tribes which were most lately changed by the advance of the white man. Two of the four tribes are west-coast Indians. Here are numerous tribes speaking different languages, but having a marked similarity in customs and arts. The coast tribes strung along the coast lands from Puget Sound to Mount St. Elias



GROUP OF EASTERN ESKIMO.



GROUP OF WESTERN ESKIMO.



FAMILY GROUP OF THE CHILKAT INDIANS.

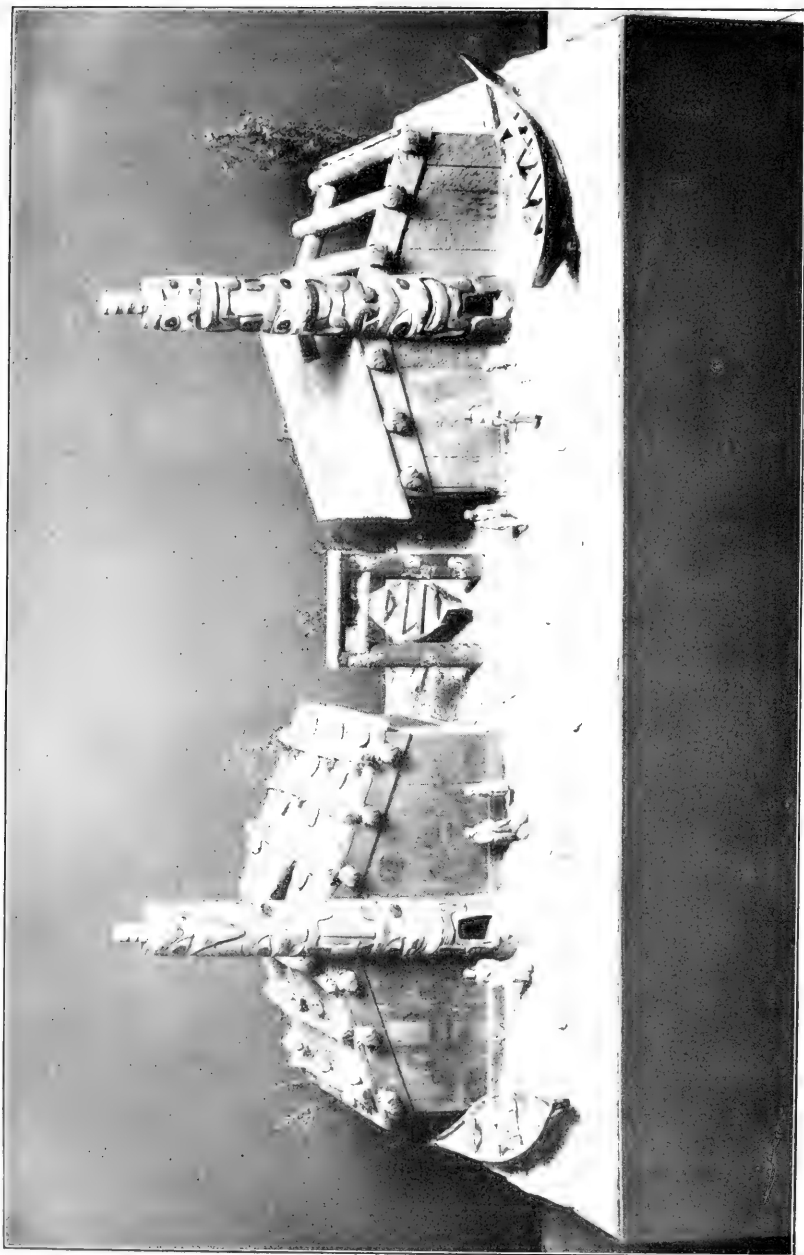

DWELLING GROUP OF THE HAIDA INDIANS.

seem to be examples of how a broken shore line and many islands with abundance of splendid timber tends to produce a hardy race of seafarers and a particular phase of material culture. Here was great development in shipbuilding, navigation, and in the primitive arts. The Alaskans possess a characteristic culture not to be confounded with any other in North America. On the other hand, the interior tribes in a region of lakes and rivers are less advanced, having been held back by natural circumstances. House building, navigation, and travel in general are more simple than among the coast tribes. The food supply is also more limited and the climate more severe than on the west coast. These tribes, however, have the necessary means to live in the home where they have settled. They demonstrate in many ways the usefulness of birch bark, which is a strong and attractive substitute for the skins of animals. They tanned deerskins for clothing and decorated their garments with porcupine quills and brilliant paints. They had no agriculture and consumed very little vegetal food.

FAMILY GROUP OF CHILKAT INDIANS.

The Chilkat live on Lynn Canal in southeastern Alaska, and belong, with the Tlinkits, to the Kuluschan family. They are in commercial contact with the Athapascan tribes across the mountains to the east, from whom they obtain horns and wool in barter, the latter being used in making the famous Chilkat blankets, which are woven, not in a loom, but the warp is suspended from a bar of wood. The designs are symbolical animal forms and are worked into the texture independently of one another, as in gobelin tapestry. The pattern, painted on wood, is suspended over the loom. The men are expert hunters and fishers, and carve utensils and ceremonial objects from wood and horn. In this group are to be seen the blanket weaver at work; a man carving a wooden mask; a woman engaged in making a basket, her babe lying in its cradle by her side; and a young woman offering food in a carved wooden dish to a man who wears one of the famous Chilkat blankets. Costumes of the Chilkat are more frequently made of deer skins, since they live on the mainland, and are in touch with the Athapascan tribes of the interior. Numerous articles pertaining to the household are scattered among the group. (See pl. 7.)

DWELLING GROUP OF THE HAIDA INDIANS.

The Haida Indians inhabit the Queen Charlotte Islands, lying in the Pacific Ocean, 75 miles north of Vancouver Island. They are a separate linguistic family. Their houses face the beach and are in the form of a regular parallelogram, averaging 50 feet in front and 35 feet in depth. Posts are planted in the ground, joined by means of timbers, and these were anciently covered on the roof and

sides with hewn planks. In front are planted trunks of trees, upon which are carved and painted animal totems representing the crests of the different clans inhabiting the house. Entrance is usually by means of a low doorway cut in the totem post. Over the front also are painted heraldic emblems connected with their family system. The dead are placed in boxes which are deposited on posts or in miniature houses. The Haidas tattoo their bodies with various designs and clothe themselves with furs and skins of animals. They are among the most skillful canoe builders on the Pacific coast. (See pl. 8.)

FAMILY GROUP OF LOUCHEUX INDIANS.

The Loucheux Indians live in northern Canada, east of the Mackenzie River, and belong to the great Athapaskan family. For many years they have been in contact with the Hudson Bay Co., who have used the men as hunters for catching fur-bearing animals. This has made them a thrifty people. In summer they dress in reindeer skins and ornament them with bird quills, dentalium shells from the Pacific coast, and trade beads and worsted from Europe. The birch tree is so common and useful that every utensil of their household life is made from that bark. Even their cooking vessels are of that material and their food is boiled by means of hot stones. Their canoes are of birch bark, which enables them to navigate the rivers to the headwaters and renders them so light that they are carried from one stream to another over portages. This group represents a hunter and his son returning from the chase while his wife and younger son anxiously await his coming. (See pl. 9.)

DWELLING GROUP OF THE MONTAGNAIS INDIANS.

The Montagnais Indians are of the Algonquian family, and occupy Labrador as far north as Ungava Bay. They live by hunting and fishing. Their dwellings are of skins, not sewed together, but laid on frameworks of poles and held down by trunks of small trees leaned against them outside and by stones piled around the base. The group includes finished tents, woodpile, staging filled with skins and robes, men painting a robe, women drying skins, and birch-bark canoe. The Montagnais dress in deerskin robes, quite like those of the Eskimo, their neighbors, but well made and decorated with paint rather than embroidery. Their canoes are of bark and not of skins, as are those of their neighbors in the north. (See pl. 10.)

TRIBES OF THE EASTERN AND SOUTHERN UNITED STATES.

The tribes of Algonquian and Iroquoian stock, whose home was in the territory between the Great Lakes and central New York, exhibit what is called woodland culture, a culture determined in a



FAMILY GROUP OF THE LOUCHEUX INDIANS.

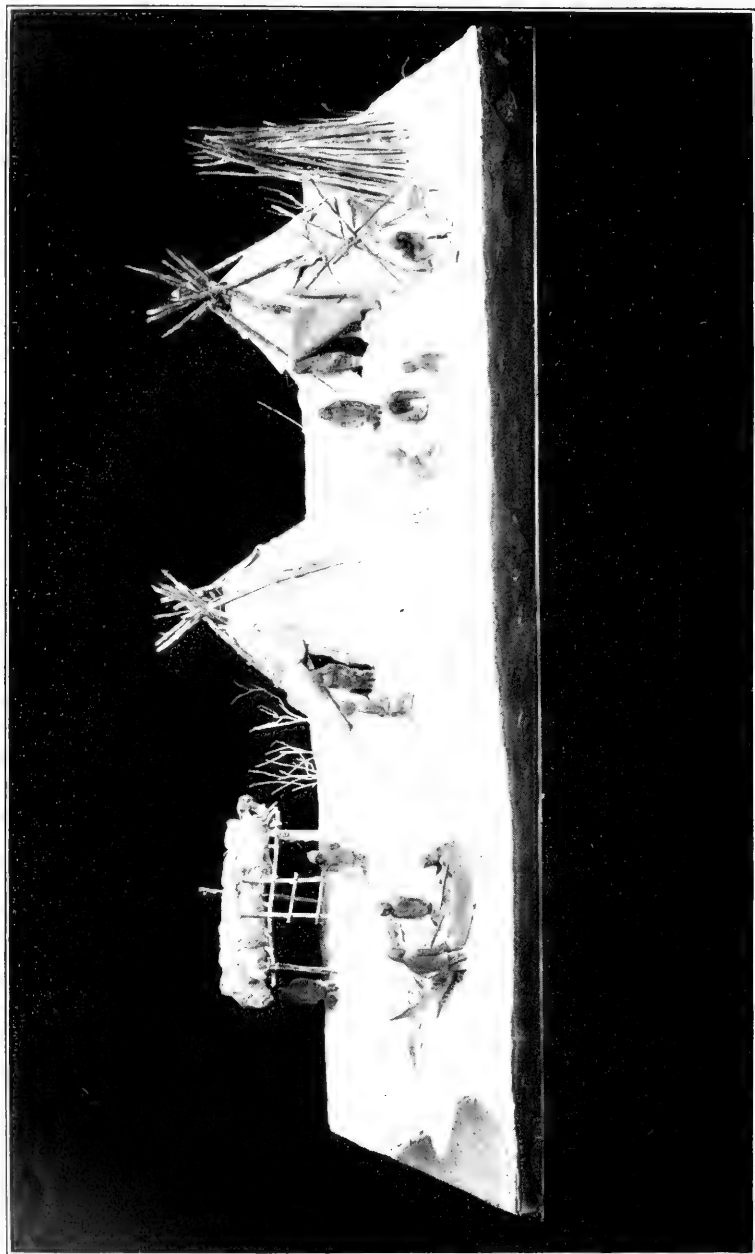

DWELLING GROUP OF THE MONTAGNAIS INDIANS.

great degree by forests, which have a restraining influence upon man's progress. These Indians are well known in song and story and many of the natives remain after centuries of more or less rough contact with white men. The arts which belonged to them in the old times have almost entirely disappeared, those remaining, such as the birch-bark canoe, the snowshoe, lacrosse stick, and moccasins, being preserved by adoption by the early white settlers. These tribes were agriculturists mainly and they performed great labors in clearing their fields and building their "long houses." Traces of these old fields in which corn was planted may still be found; for some time after the white settlement these fields remained treeless in the forested country, and were known to have been the farms of the Indians. The Iroquois, while rather crude in the arts, were skilled and fearless in war and had also developed ideas of political organization far in advance of their time, which were put in effect as a league or confederacy whose object was peace.

Little is known of the Algonquian tribes with whom the Pilgrims came in contact along the New England coast, and not until we come to Virginia is there adequate information as to their manners and customs furnished by Capt. John Smith and his artist, John White, of Sir Walter Raleigh's adventure. The Virginia Algonquians, called by the English Powhatans, with neighbors of other stocks such as Siouan and Iroquoian, form an interesting group of tribes which emerge into history at the beginning of the seventeenth century. Farming was the chief subsistence industry of these tribes, but they also utilized all of the vegetal and animal resources of their fruitful country, as well set forth by Capt. John Smith in his narrative.

The tribes of Muskoghean stock called Creeks, Choctaws, etc., inhabiting the Southern States were further advanced in the arts of life than the Virginia Indians. Their houses, pottery, stonework, shellwork, and other arts were indicative of a stage of culture comparable with that of the Pueblos. Illustrations are given of the Seminoles, a mixed Muskoghean tribe which wandered into Florida and with which the historic Seminole War was waged, terminating with the death of the chief, Osceola. In the subtropical environment of Florida Seminole life took on resemblances to the life of the Arawak settlers of the West Indies. It is thought that the Arawak planted a colony in Florida and that some aspects of Seminole arts were derived from these Indians.

DWELLING GROUP OF THE CHIPPEWA INDIANS.

Lake Superior Region.

The Chippewa live in the northern United States and Canada in a heavily forested region, which has had marked influence on their

material culture. Their houses are made of bent poles covered with birch bark and mats of rushes. The houses contain sometimes several families, each having its own fireplace, the smoke issuing through an opening in the roof. Canoes are made of birch bark, and both men and women are expert in managing them. They subsist on wild rice, game, and fish. They tan excellent buckskin, which formerly was used by them for clothing. They make also much maple sugar. (See p. 11.)

CHIPPEWA WARRIOR AND FAMILY.

This is the original plaster model of a bronze group by John J. Boyle, which was presented to the city of Chicago by Martin Ryerson, Esq., and erected in Lincoln Park. It was given to the National Museum by the sculptor in 1883. (See pl. 12.)

CHIPPEWA MEDICINE MAN.

Minnesota.

A shaman in his medicine lodge composing a mnemonic record and incising it upon a piece of birch bark. The outlines of the characters recall to the Indian the specific significance of each idea recorded, and frequently these interpretations are chanted to make them more impressive. Many of the Indian tribes of North America conveyed information and kept the record of events by picture writing. This is to written language what gesture speech is to spoken language and constitutes the first step toward syllabic writing and alphabetic characters.

The Chippewa preserve by the above means the order of songs and the traditions of the Indian cosmogony and genesis of mankind. Charts of birch bark relating to the ceremonies of initiation into the "Grand Medicine Society" are exceedingly rare and highly prized by the shaman; one in the collection of the National Museum measures about 9 feet in length and 20 inches in width, composed of various pieces neatly stitched together with strands of basswood bark. (See pl. 13.)

DWELLING GROUP OF THE IROQUOIS INDIANS.

Northern New York.

This model represents a stockaded village of the Iroquois Confederacy during the aboriginal period. Two "long houses," communal structures in which several families lived, are located near a spring on the shore of a lake, and the people are engaged at their customary occupations, such as housebuilding, mealing, pottery making, and the like. The pits covered with bark slabs near the houses are storage receptacles for food, which were in charge of the women.



DWELLING GROUP OF THE CHIPPEWA INDIANS.

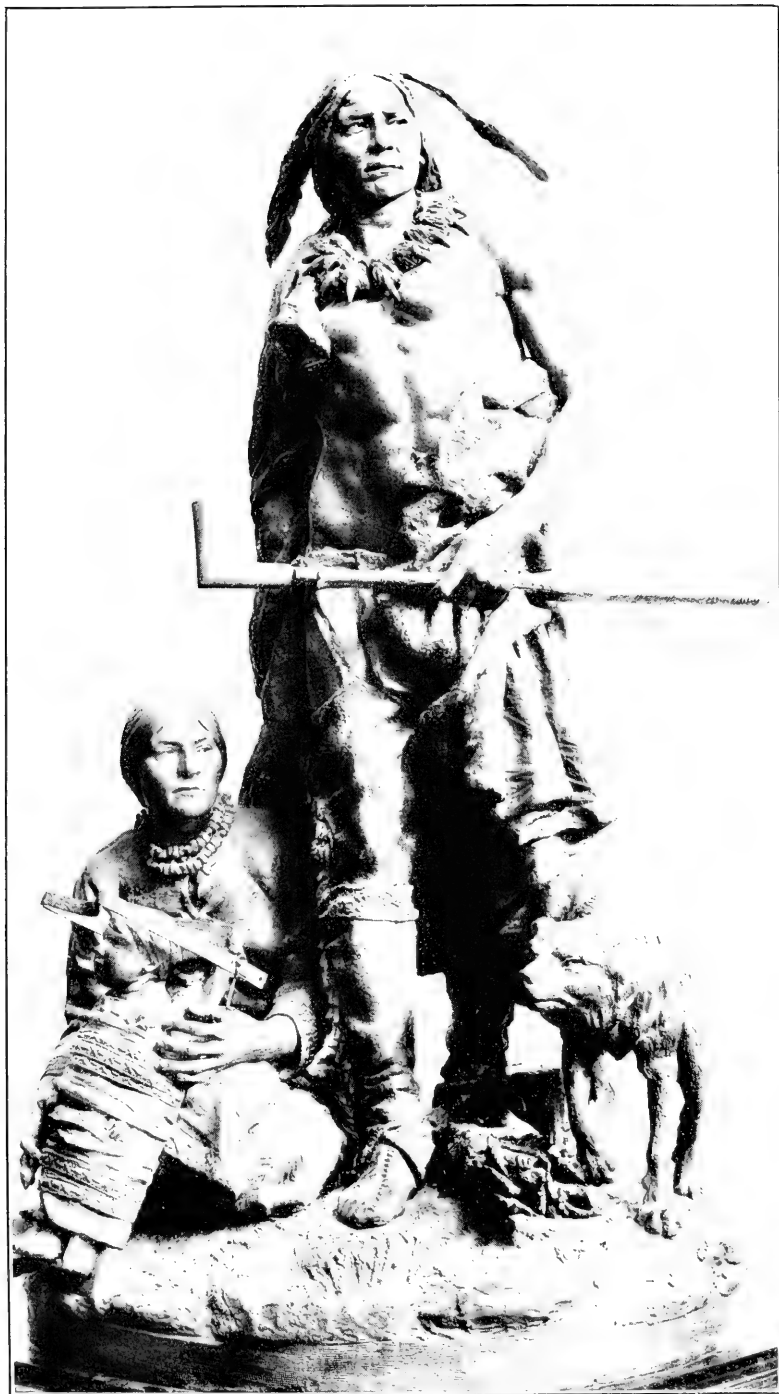

CHIPPEWA WARRIOR AND FAMILY.

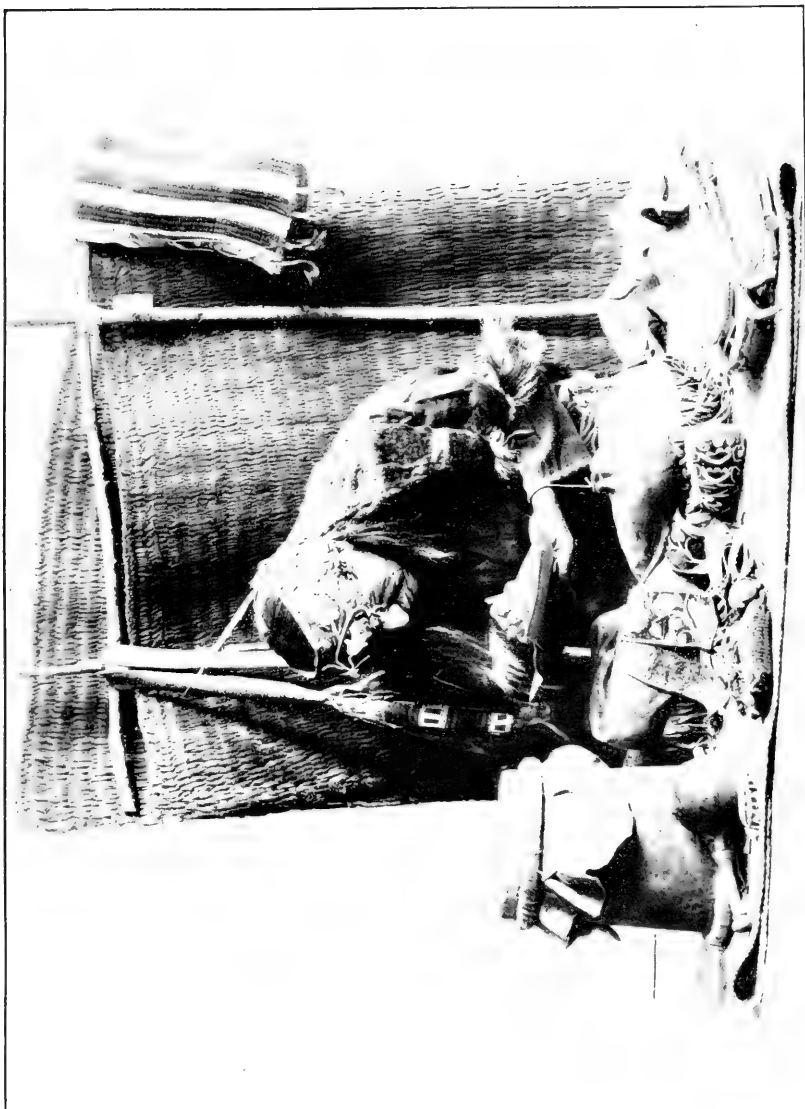

CHIPPEWA MEDICINE MAN.

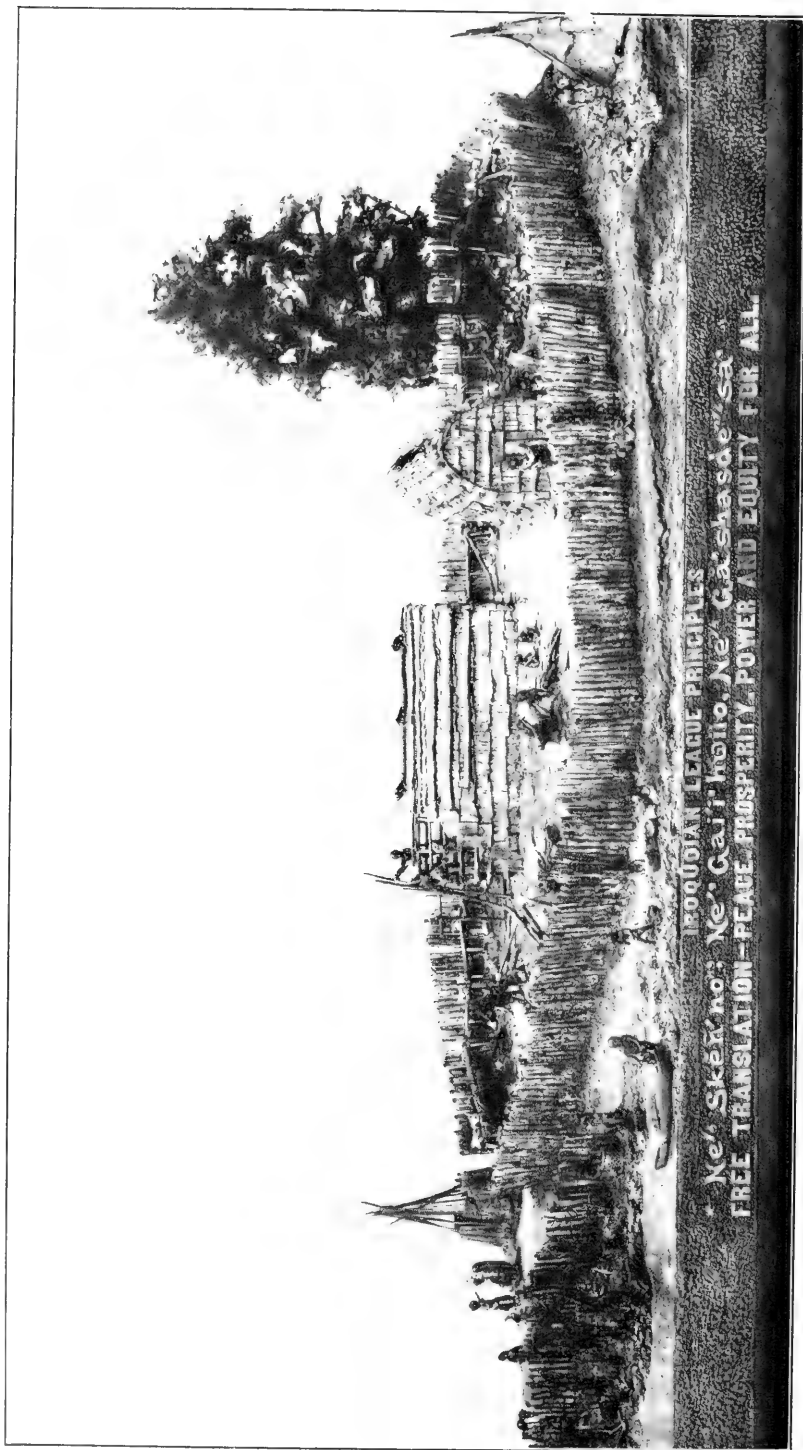

DWELLING GROUP OF THE IROQUOIS INDIANS.



MARY JEMISON.

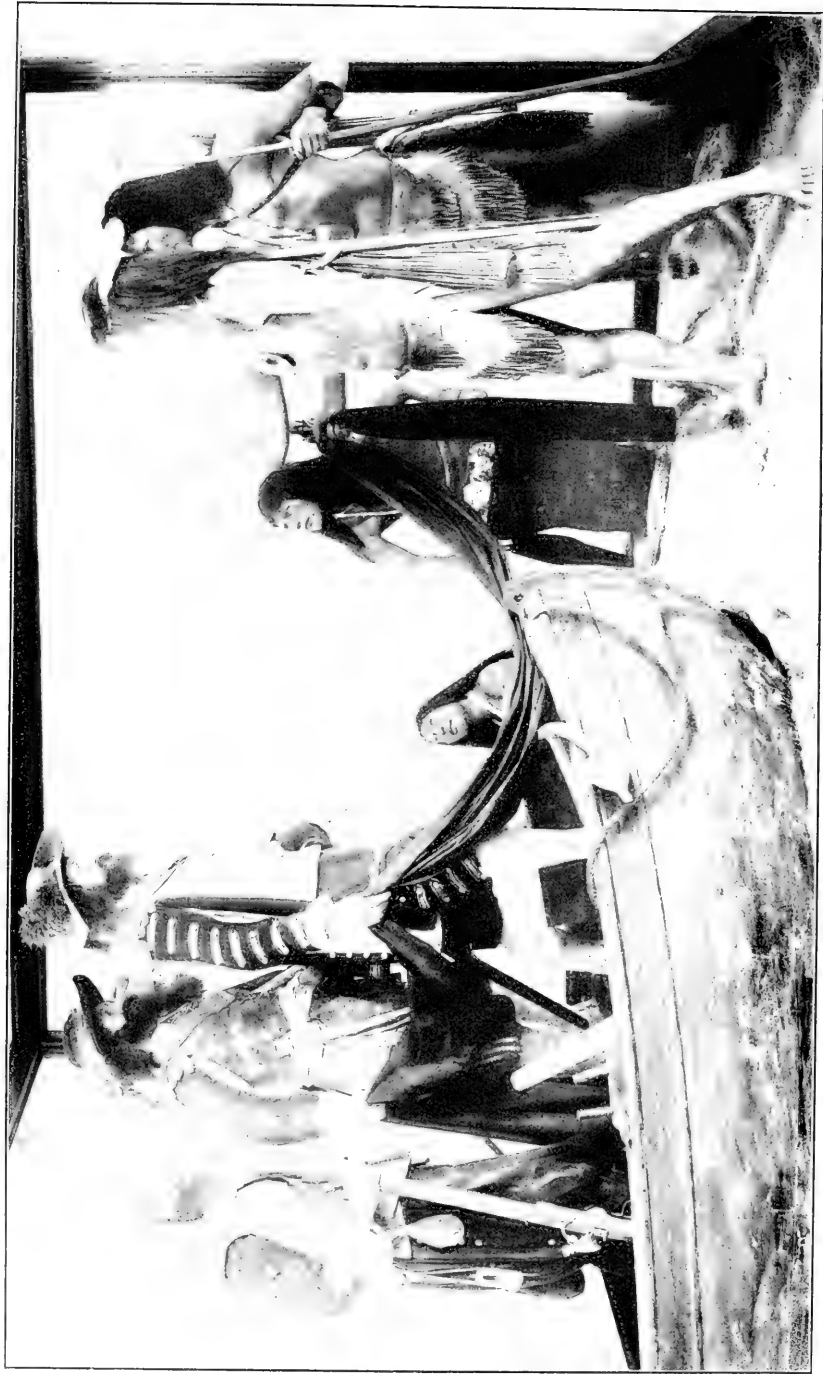

GROUP OF VIRGINIA INDIANS TRADING WITH CAPT. JOHN SMITH.

One of the smaller triangular houses is a guest house for the reception of envoys and the other is a shelter for a single family. The corn field is near the village and is surrounded with a fence for protection against wild animals, but sometimes the fields were inclosed by the general stockade. The legend in Iroquois on the frame is: "Great Commonwealth: peace—justice—power," the motto of the Confederacy. (See pl. 14.)

MARY JEMISON, INDIAN CAPTIVE.

Mary Jemison's story is that of an Indian captive who, after many years among her captors returned at last to "her own people," the Iroquois. She is represented here dressed in Indian costume and carrying a papoose on her back on her journey of 500 miles, returning from Ohio to New York.

When she was a few years old her family was massacred by Indians, but her life was spared and she was adopted, reared among the tribe, and given the name Degewanus, "beautiful object."

After many years of captivity she made her way back to the old log cabin home on the Genesee River, in New York, where she lived till her death in 1808(?). The ground surrounding this old frontier log cabin was purchased by Mr. William Pryor Letchworth, of Buffalo, and made a public park for the citizens of the State of New York. Mr. H. K. Bush-Brown was commissioned to execute the statue.

Plaster original gift of Mr. H. K. Bush-Brown. (See pl. 15.)

THE VIRGINIA INDIANS.

This group represents Capt. John Smith trading with the Powhatans in 1608, when the Jamestown colony was saved from grievous want by his energy and resourcefulness. Food having fallen low, Captain Smith organized an expedition to one of the Powhatan villages on the James River in which articles of European manufacture were exchanged for corn. It will be seen that the Indian chief drives a hard bargain, but Smith is master of the situation.

The group reproduces, as nearly as the available data will permit, the boats of the period and the costumes and other personal belongings of both peoples. Our knowledge of the costumes of the natives is quite limited, the only source of information being the meager descriptions left by Smith and a number of drawings, now preserved in the British Museum, made by the artist John White, of the Roanoke Colony. Aside from the simple buckskin garments here reproduced, dressed skins of animals and certain coarsely woven cloaks, sometimes tastefully embellished with feathers, were used in cold weather. The chief weapon was the bow and arrow. Hunt-

ing and fishing were important means of subsistence, and agriculture was very generally practiced, the principal staple being the native Indian corn. The corn shown in this group is native Indian corn obtained from the Iroquois Indians of Canada. (See pl. 16.)

THE MANUFACTURE OF STONE IMPLEMENTS BY THE AMERICAN
ABORIGINES.

The Indian tribes of the New World had not advanced beyond the "stone age" of culture, and the quarrying and shaping of stone implements were to them industries of vital importance. Suitable stone was gathered from the surface of the ground, or was obtained at the expense of great labor from the deposits in place. The quarrying of flint and other bedded minerals was carried on in many sections of the country, and the pittings may still be seen among the hills. In like manner, water-worn stones—boulders and pebbles—were quarried from the river bluffs and ancient beaches, and extensive workings of this class are found in the suburbs of Washington City.

This group is intended to illustrate the work carried on in the great quarries on Piney Branch and in the associated workshops not long before the arrival of the English, some 300 years ago, near the point where Eighteenth Street would cross that stream. The broken boulders and flakage left on the shop sites are in places 10 feet or more in depth.

The man at the left is represented as employing a heavy, wooden pike in prying up the larger boulders, while the second breaks them up preparatory to selecting fragments of suitable size and shape for implement making.

The third man roughs out the forms of the implements by means of quick, sharp blows, with a boulder hammer, using either the selected fragments or the smaller boulders for the purpose.

The fourth workman trims the edges and shapes up the thin blades with an implement of bone or antler set in a wooden shaft. The flaking is accomplished by setting the point of this implement against the edge of the roughed-out blade, and pressing it downward with a quick, strong movement, reenforced by the weight of the body. Flakes are thus removed from the under side, and the folded buckskin pad serves to prevent breakage of the blade under treatment. This work, however, was not completed at the quarry, the blades being usually carried away to be finished as the implements were needed.

The finishing touches are given, as indicated by the fifth workman, who chips out the notches and shapes the points by means of a small flaker of bone or like material, which is pressed down on the sharp edge of the blade until it "takes hold." Then, by a quick



THE ARROW MAKERS.

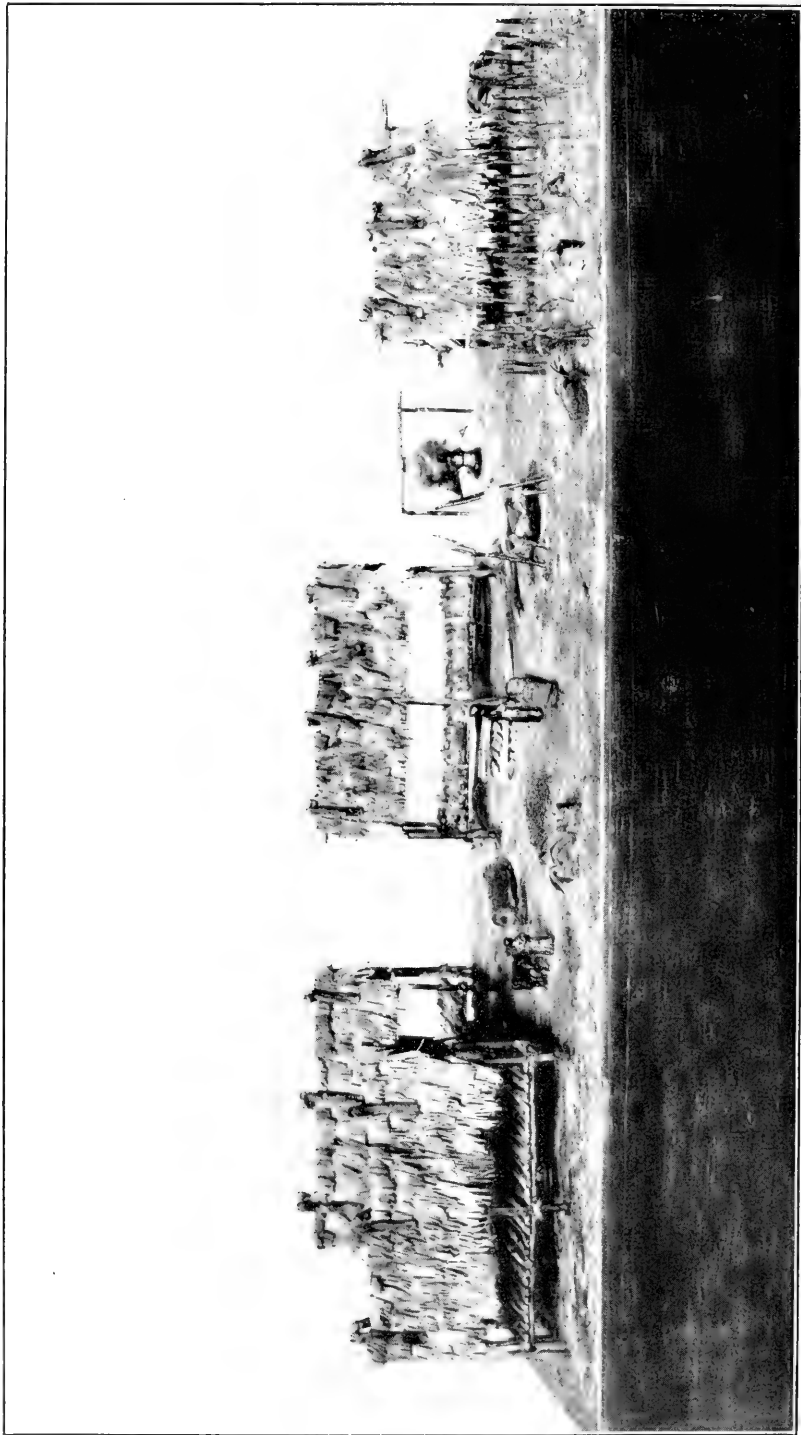

DWELLING GROUP OF THE SEMINOLE INDIANS.



OSCEOLA, SEMINOLE CHIEF.



SEMINOLE MAN.

push, the flake is driven off. John Smith, of the Jamestown colony, about 1608, says, speaking of a Powhatan hunter, that "His arrow-head he quickly maketh with a little bone which he ever weareth at his brasert (belt)."

The shaping processes here illustrated were formerly in general use among the tribes. The women doubtless aided in the work of transportation and in preparing food for the quarrymen. The costumes shown are modeled after the garments of the Virginia Indians at the period of discovery, as illustrated in the drawings of John White, artist of the Roanoke colony.

That the quarries of the region were worked by the Powhatans and adjacent tribes is amply proved by the discovery on their deserted village sites and in their shell heaps throughout the Potomac-Chesapeake region of countless numbers of implements identical with those produced in the local quarries. (See pl. 17.)

DWELLING GROUP OF THE SEMINOLE INDIANS.

Florida.

The Seminoles are made up of remnants of the Creek and other southern tribes forced into the Everglades. They live by hunting and fishing. Their houses are open sheds roofed with palm leaf, placed on the hammocks or elevated meadows. Several of these houses may occupy a hammock. In the center of the group is the house where all the cooking is done, the fire bed with logs shoved in when needed. The Seminoles manufacture flour from koonti root, somewhat as cassava is prepared in South America. The dugout canoe is generally used, and the Seminole is an expert boatman. (See pl. 18.)

STATUE OF THE SEMINOLE CHIEF, OSCEOLA.

The Florida Seminoles, now living in the Everglades, belong with the Creeks, Choctaws, and Chickasaws, to the Muskhogean family, who formerly occupied the Southern States east of the Mississippi River. The unremitting bloody conflicts with the white settlers were brought to an end in 1838, when the Seminoles and their kindred were forcibly removed to the Indian Territory, those that remained fleeing to the Everglades.

Osceola, the leader, made a determined resistance to the authority of the United States, and only after several expeditions against him, involving considerable loss of life, was he finally taken. He died at Fort Moultrie, Florida, in 1838. (See pl. 19.)

SEMINOLE MAN.

The figure here shown is dressed in a chief's costume of to-day, wearing leggins of buckskin, with shirt and coat of many-colored

calico. A girdle around his waist with long fringes, moccasins of buckskin, and the helmet-shaped cap with heron plumes preserve the ancient native forms of dress. The tomahawk is of European manufacture, and became very popular as an object of trade in colonial times. (See pl. 20.)

TRIBES OF THE GREAT PLAINS AND NORTHERN ROCKY MOUNTAINS.

From their connection with the settlement of the West with its stirring events, together with the impression of their free, wild life, the Plains Indians have been given first place in popular fancy. Especially is this true of the Sioux living in the Northern Plains, whose "seven fireplaces," representing the seven tribes of the stock, furnished powerful bands of warriors to obstruct the progress of land-hungry settlers.

The Sioux at some period, believed to have been shortly before the coming of the white man, entered the Plains and became hunters of buffalo. This animal profoundly modified the subsequent history of this tribe, and, together with the horse, which was acquired in due time, made the Sioux a strong nation. The life on the Plains was not conducive to material advancement, and the Sioux at the time he was pushed about by the white man had not made much progress, though having in agriculture and other arts the elements of such progress. It would seem that dependence on the buffalo acted as a handicap to progress. On the extermination of the buffalo the Sioux settled down and has made rapid strides toward becoming a valuable asset to American citizenship. As a representative tribe of the northern Rocky Mountains the Nez Perce have been selected. This warlike tribe forms a connecting link between the Sioux and Salish, who lived on the coast. It is interesting to trace the modifications in the Sioux arts due to contact with other tribes living in widely differing environments. The study of Siouan arts is rendered very difficult on this account. The Nez Perce in this way are credited with weaving, an art which, if they practiced it, they undoubtedly borrowed from the Salish. This tribe was prominent in the wars among the Plains Indians, and the celebrated Chief Joseph took an important part in these conflicts.

The Southern Plains Indians present familiar tribal names, such as the Kiowa, Comanche, Cheyenne, Arapaho, Pawnee, and Wichita. The Kiowa are taken as representative. This once powerful tribe contributed much to the history of Indian wars. They also form one of the connecting links between the Plains and Pueblo Indians.

The Pawnee and Wichita of the Caddoan stock represent intrusions from some other environment where the houses whose mode of construction they preserved in their migrations were necessary. Pic-

ture writing and the sign language had their highest development among the tribes of the Great Plains. This feature of Indian life which has always attracted general interest permitted communication of ideas among tribes speaking different languages.

DWELLING GROUP OF THE SIOUX INDIANS.

Northern Plains.

The Sioux Indians belong to the great Siouan family. Before they were disturbed by the whites their sustenance was derived from the flesh of the buffalo, and most of their industrial arts were associated with the same animal. Their tents were made in conical shape from the skins, and supported by poles. The draft from the fire in the center of the tent was regulated by a long pole attached to a fly on the top. They were not sedentary, but roving, moving the camp from place to place, so great burdens were carried on the backs of their women, but they had gotten so far as to use the dog for pack and for traction by means of two poles called a travois. They also moved their goods along the streams of water in a coracle of buffalo hide, built over a crate of small poles. The village group here shown represents the tents closed, opened, and in process of erection; the men in ceremonial and hunting costume; the women raising a tent, skinning a deer, dragging tent poles, and dressing a buffalo hide; the dog hauling a travois, and meat hanging up to dry. (See pl. 21.)

FAMILY GROUP OF THE SIOUX INDIANS.

A glimpse of the somewhat barren home life of the Sioux is afforded in this group. The father, skilled with the bow and arrow, returns with trophies of the chase. The wife, or wives, engage in the arduous duties of the household in the open. While one woman removes the hair from a buffalo hide stretched on a frame—the first step in the tanning process—the other prepares the jerked beef for future use by pounding it in a rawhide basin and mixing it with berries gathered from the neighboring bluffs. The two girls are interested in their beadwork and dolls. The small boy greets the father returning from the hunt, and the tightly swathed babe, hung up in his cradle frame, looks appreciatingly on.

Their principal subsistence was the buffalo, whose annual northern and southern migrations they followed. For this reason their habitations were light and easily transported, and their culture was limited in regard to the furnishings which commonly accumulate around fixed habitations. They crossed rivers in boats made of buffalo hide stretched over a framework of poles. At first they employed the dog for transporting their belongings, and later the introduction of the

horse facilitated longer journeys and a wider spread of the people over the plains.

On account of their wild, free, roving life, their splendid physical development, their skill as hunters of big game, and as warriors, the Sioux may be regarded as a type of the hunter tribes. The uncivilized branches of this tribe which took part in the Custer massacre in 1876 were reduced to subjection in the campaigns which followed that event.

The Plains tribes overran an enormous territory, including portions of Manitoba, the Dakotas, Nebraska, Kansas, Texas, and neighboring regions. The principal groups are as follows: Sioux, Nez Perce, Sac and Fox, Cheyenne, Arapaho, Kiowa, and Comanche, all of whom have assumed, or are on the point of assuming, the habits of civilization.

A lodge group, in miniature, of the Plains tribes may be seen in a case near at hand. (See pl. 22.)

SIoux WOMEN DRESSING HIDES.

Among the Plains Indians the buffalo hide was prepared for robes, with the hair on, by stretching on a frame and chipping away the flesh side by means of "beaming tools," which originally had stone blades. In this way the hide was reduced to about half its original thickness and rendered pliable by working. For making tents, shields, and packing cases the hair was removed by the sweating process and by chopping with the beaming adz, and the hide was rendered pliable, if necessary, by pounding with a stone hammer. In the group here shown one woman is removing hair, while the other is manipulating a hide in order to render it pliable. (See pl. 23.)

SIoux INDIAN WARRIORS.

Dressed in native costume, somewhat modified, including a war shirt trimmed with beadwork, cut fringe, and scalp trophies; plume of eagle feather; necklace of bear's claws; cincture of flannel; trousers of deerskin dyed green; and moccasins ornamented with porcupine quills. In his right hand he carries the old stone-head war club of the Sioux. The face is that of Kicking Bear, a Sioux medicine man who was prominent with Sitting Bull in the ghost-dance craze among the Sioux in 1890. A cast of his face was made when he visited the Museum in 1902, at which time the costume was also secured from him. The decoration painted in kaolin on his hair is a cross within a circle and is a heraldic device signifying an act of prowess in which he saved a friend under the fire of the enemy. (See pl. 24.) Another warrior wearing the typical eagle feather headdress and necklace of bear claws, clothed in beaded buckskin and carrying a pipe and pipe bag, is shown in plate 25.

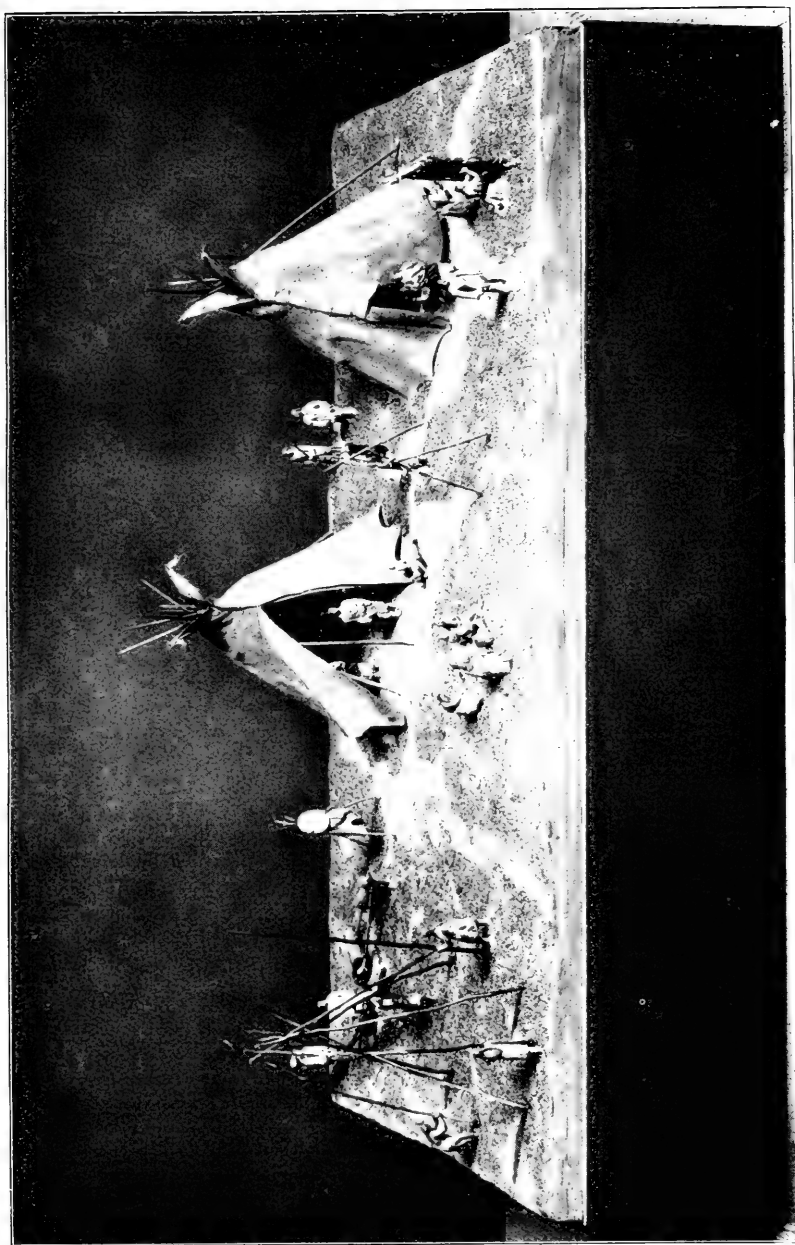

DWELLING GROUP OF THE SIOUX INDIANS.

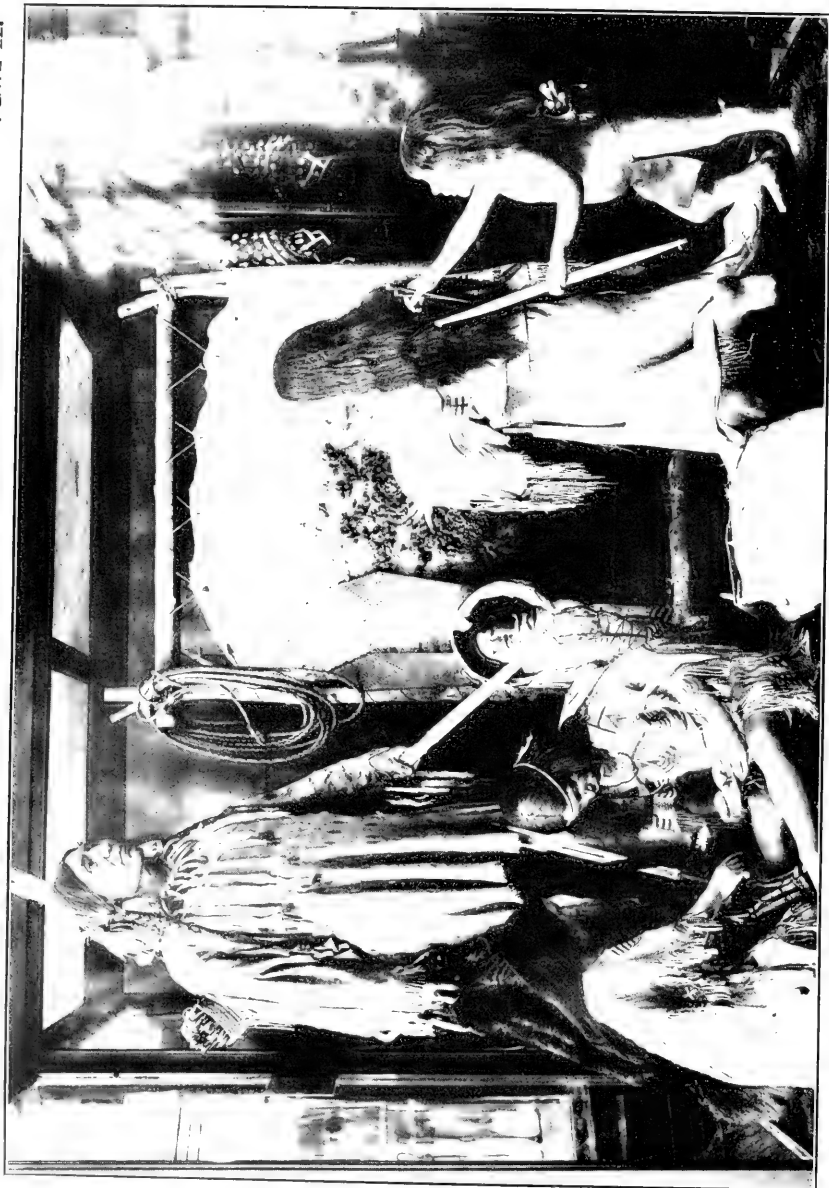

FAMILY GROUP OF THE SIOUX INDIANS.



SIUX WOMEN DRESSING BUFFALO HIDE.



SIoux WARRIOR.

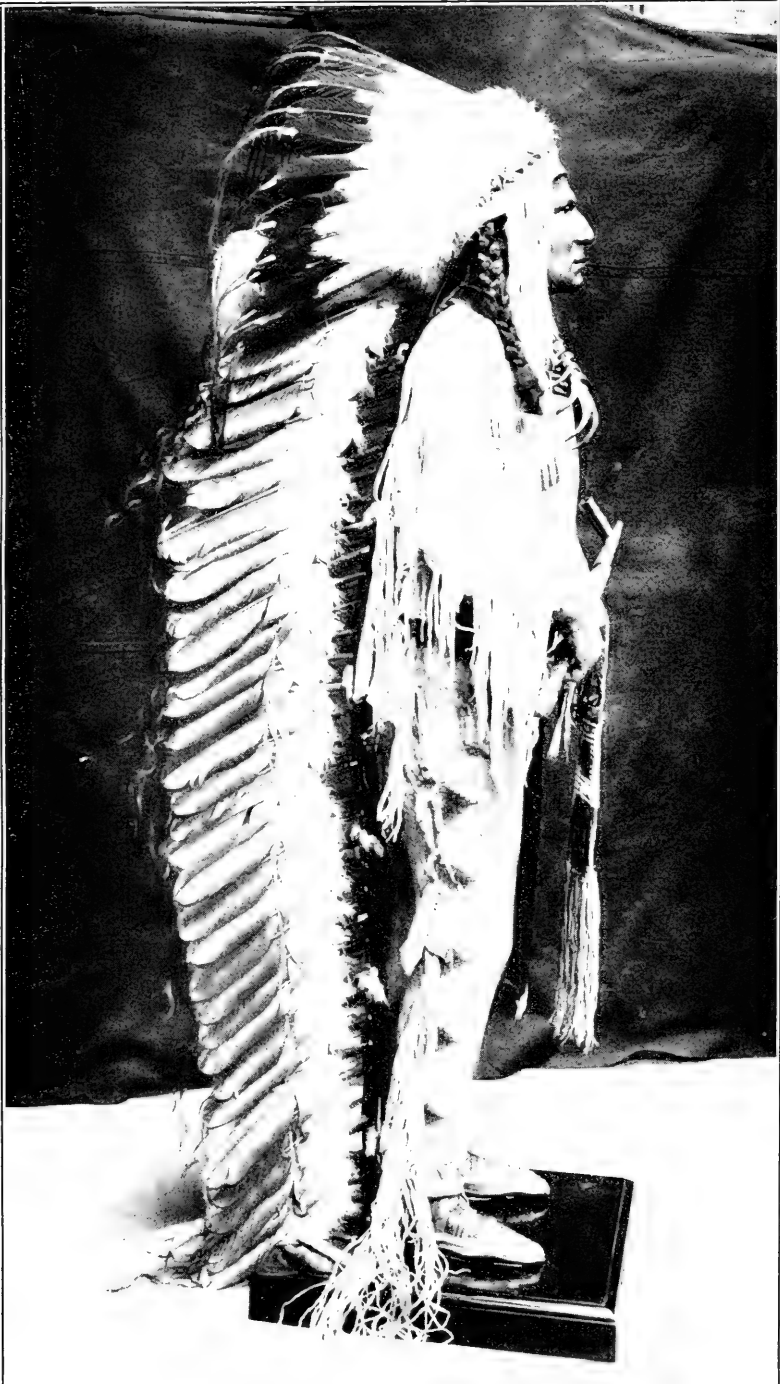

SIoux WARRIOR WITH HEADRESS.

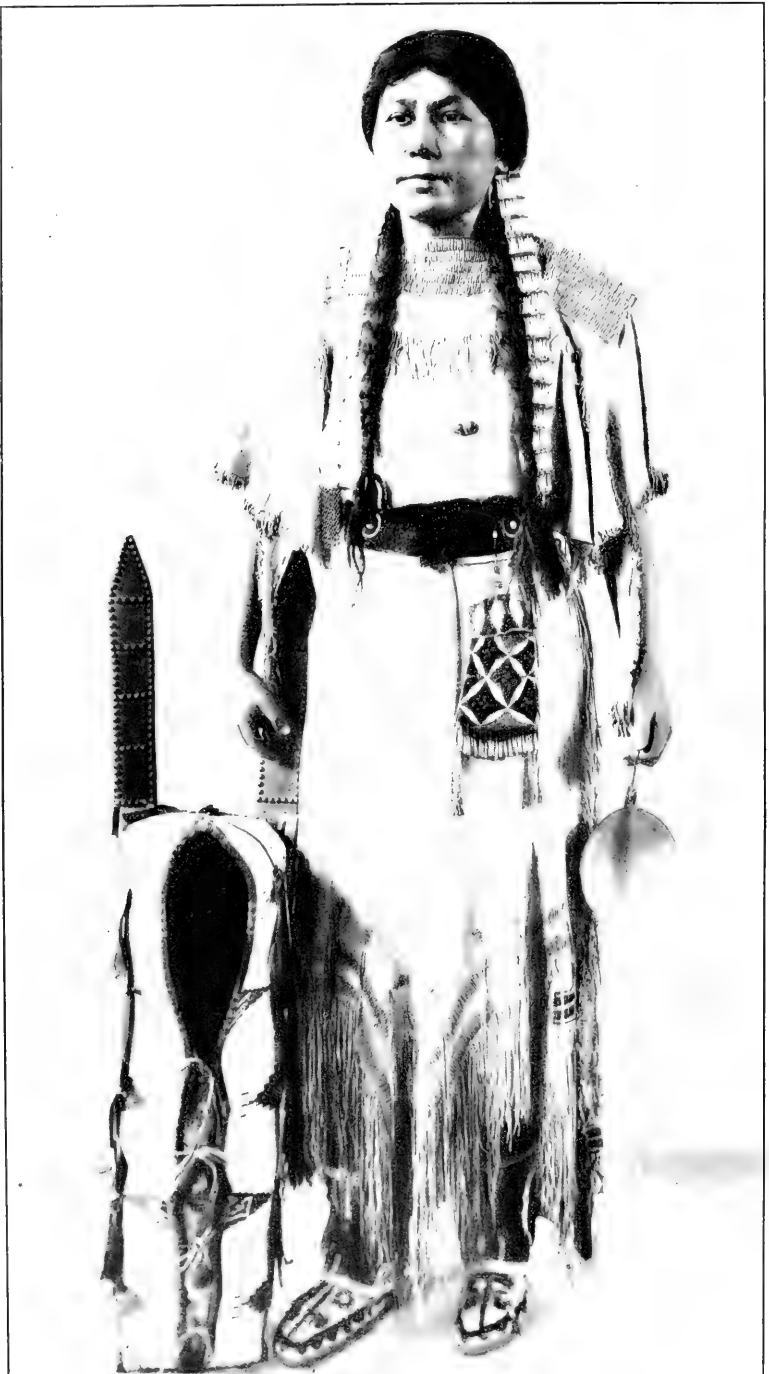

SIoux WOMAN.



YANKTON SIOUX WOMAN. (BUST.)



CROW INDIAN PAINTER.

The Sioux Indians belong to the Siouan family, formerly having a wide distribution west of the Mississippi Valley as far southward as the borders of Louisiana. Detached tribes were also living at the time of the discovery in the mountain regions of Virginia and North Carolina.

SIoux INDIAN WOMAN.

A Sioux Indian woman dressed in beaded buckskin frock with cut fringe, earrings of dentalium shells, and leggings and moccasins beaded. In her left hand she carries a spoon carved from cow's horn. The cradle with its peculiar frame and hood is a modification of the more ancient and simple form, made since the introduction of the horse into this area, and is adapted not only to the carrying of the child upon its mother's back, but also for attachment to the pommel of the saddle. The beadwork, in its material, is derived from the whites, but the style of the ornamentation is purely aboriginal.

The costume and cradle belonged to the Dakotas who came early in contact with the French explorers. Their clothing, their tents, and their utensils were made largely of skin. Formerly quills of birds and of porcupines were used in decoration, but trade beads have taken their place. (See pl. 26.)

KAU-KU-WASH-TO-WIN, THE GOOD ROAD WOMAN.

A Sioux woman of the Yankton tribe, South Dakota. In 1870 her portrait was painted by A. Z. Schindler for the Blackmore Museum at Salisbury, England. This bust was modeled by the sculptor Achille Collin, and is one of several works by that artist of Indian subjects in the Museum. She is regarded as an excellent type of Indian beauty. (See pl. 27.)

CROW INDIAN (SIOUAN STOCK) PAINTING A SKIN.

The paintings on skins by the Indians were not mere decorations, but were intended as records or presented an assemblage of symbols of religious meaning. Most of the paintings on skin robes recorded various exploits in which the owner had part. They are interesting examples of picture writing and often display skill in drawing, composition, and color. (See pl. 28.)

NEZ PERCE INDIAN CHIEF.

The Nez Perce Indians belong to the Shahaptian stock, living formerly on the headwaters of the Columbia River. This figure is dressed in buckskin and wears a mantle of native manufacture. The people of this region, especially the Salish, before the coming of the whites made yarn from shredded bark and the hair of the dog and the mountain goat, and wove it, by a process entirely aboriginal, into

mats, robes, and other useful articles. Indeed, the process could scarcely be called weaving, since the warp is not laid in by means of a shuttle, but with the fingers, after the fashion of twined basketry. (See pl. 29.)

PLAINS INDIAN TRAVOIS.

Before the coming of the horse, dogs were used to drag a vehicle consisting of a cage on two poles and on which the various possessions of migrating tribes were carried. These vehicles were called by the French voyageurs of that period travaux, and the word became corrupted to travois. They were very useful in transporting tents and other baggage when moving camp, and with them tired children and the women were insured of a ride. (See pl. 30.)

KIOWA INDIAN CHILDREN AT PLAY.

The Kiowa Indians formerly lived in Colorado and now are permanently located on the Washita River, Oklahoma. They retained their native customs later than any other tribe of Plains Indians, and the clothing and other articles used in this group were collected before the general disappearance of the native arts, which took place rather suddenly.

This group illustrates an interesting feature of the child life of the Plains tribes, the Kiowa being taken as representative.

A play tent, games, and amusements, of which these children have a variety, form the attractions. The girl and boy in the foreground are bantering as to a play in the wheel and dart game. Boys in the background are playing with whip tops. The girl and the little boy, the latter dressed in imitation of his warrior father, are in the act of surprising their sister, who is playing doll in the tent. The girl, laying aside her miniature papoose cradle, lifts the flap of the tent while the boy, joining in the sport, emphasizes the surprise by a war whoop. (See pl. 31.)

DWELLING GROUP OF THE PAWNEE INDIANS.

The Pawnee Indians formerly lived in Nebraska on the Platte River. They belong to the same family as the Arikarees in North Dakota and the Caddoes in Louisiana and eastern Texas. Although their home was in the country of the skin-tent dwellers, they preserved with great pains the ancient and northern type of underground abode. The frames consist of logs set on end; these are covered with smaller timber and brush, and then with earth and sod. From this structure a passageway several feet in length leads outward. This type of dwelling is also interesting in that it is suggestive of the possible origin of many smaller mounds in different parts of the Mississippi Valley. (See pl. 32.)



NEZ PERCE INDIAN CHIEF.



SIoux MIGRATING WITH TRAVOIS.



KIOWA CHILDREN AT PLAY.



DWELLING GROUP OF THE PAWNEE INDIANS.

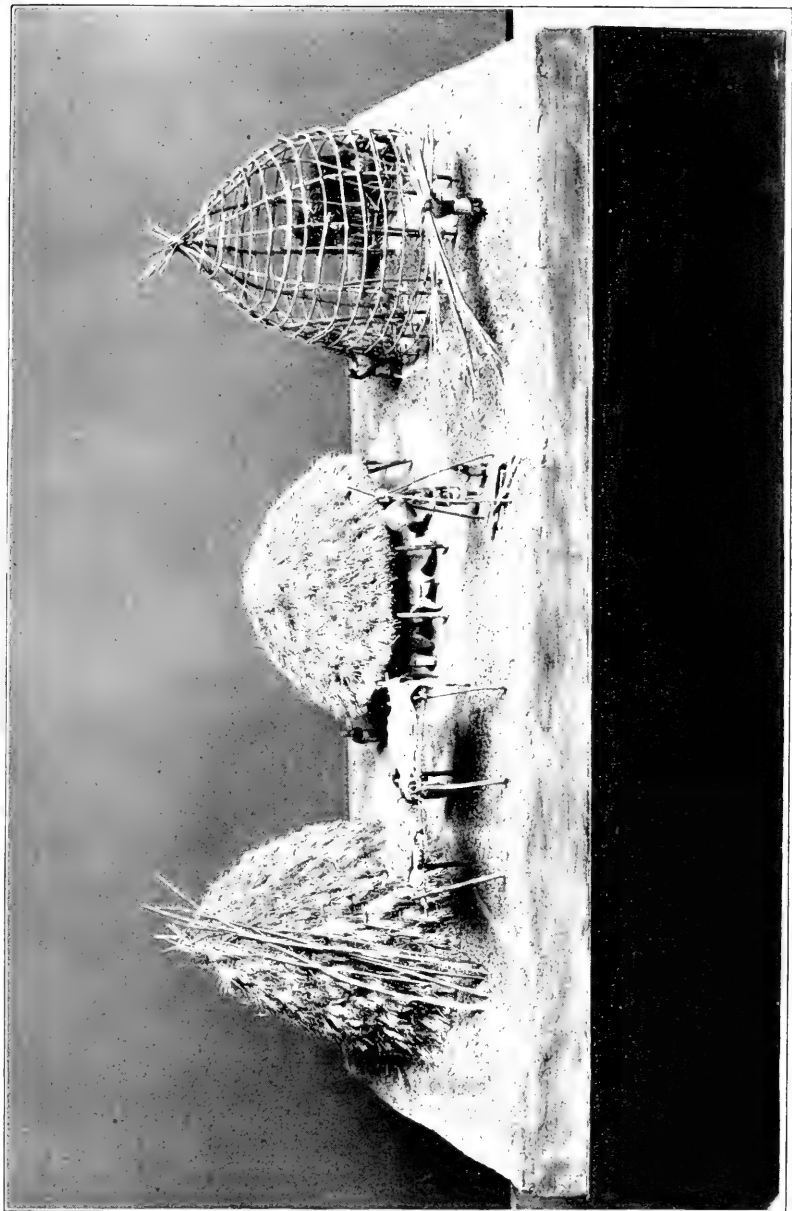

DWELLING GROUP OF THE WICHITA INDIANS.

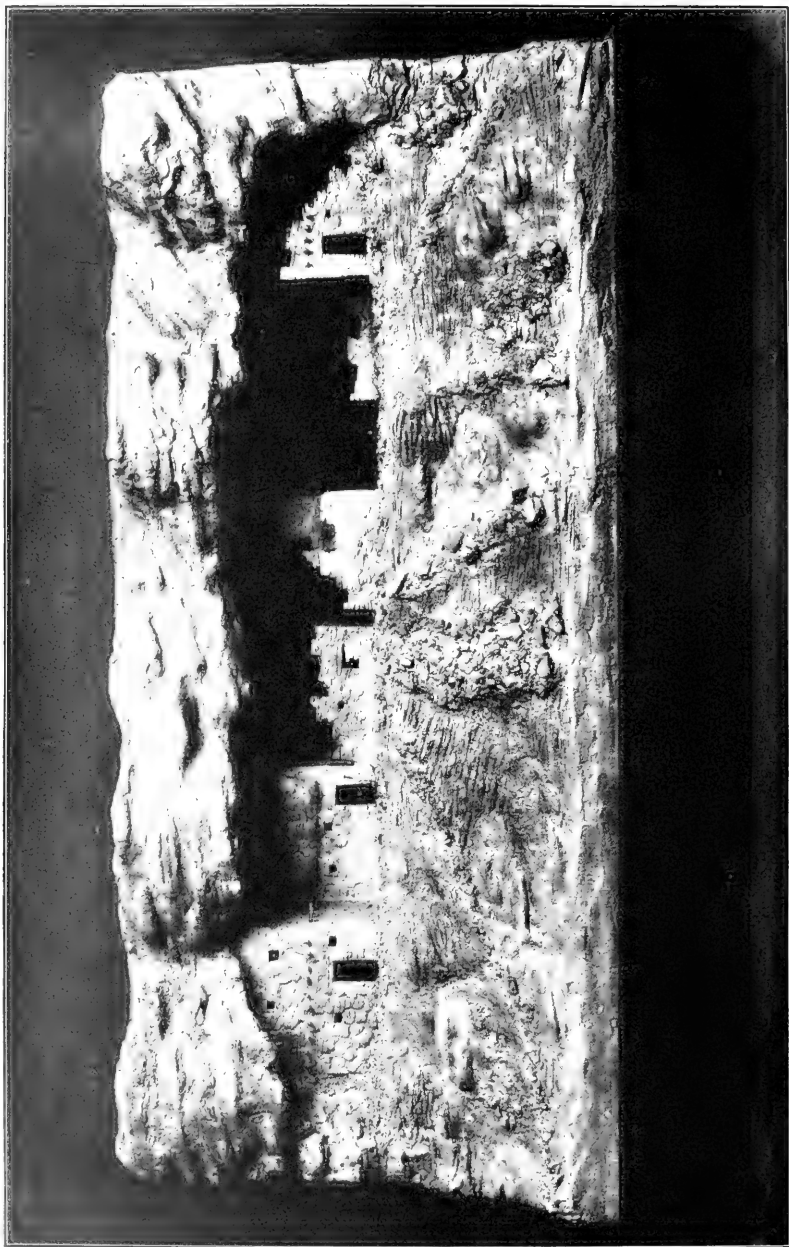

DWELLING GROUP OF THE CLIFF DWELLERS.

DWELLING GROUP OF THE WICHITA INDIANS.

The Wichita Indians are of the Caddoan family, and lived formerly in northern Texas, not far from their present home on the Kiowa Agency, Oklahoma. Their dwellings and other buildings are cone shaped and dome shaped. The framework is of poles, some laid perpendicular and others horizontal, and tied together like latticework. Into this frame bundles of grass are woven in rows, imbricated so as to shed the rain. The group shows a finished house, one in process of erection, and a communal shed, or town hall. The method of thatching is to be compared with that of the Papagos, in Sonora, Mexico. The Wichitas became agriculturists, and dried their corn on hides or frames. They also adopted the metal cooking vessels of the whites. (See p. 33.)

TRIBES OF THE SOUTHWESTERN UNITED STATES.

These tribes may be divided into two groups: Those tribes indigenous to the region, as the Pueblos, divided by language into four stocks, and the Apache and Navaho, who are recent immigrants into the Southwest, and belong to the great Athapascan family of Canada. Some of the ancient Pueblo tribes built their villages under the great sheltering cliffs in canyons, and on account of this are called cliff dwellers. The chief center of large cliff dwellings is in the Mesa Verde, a great mesa mountain in southwestern Colorado. One of the largest of these villages, called Cliff Palace, has been restored and rendered accessible to visitors by Dr. J. Walter Fewkes, Chief of the Bureau of American Ethnology, Smithsonian Institution.

There is no region similar to the Southwest in the United States. It consists chiefly of a great plateau with ranges of mountains, wide valleys, deep canyons, and extensive plains. Erosion has carved the richly colored rocks into the most varied forms. Great floods of lava issuing from volcanic centers have spread over parts and erosion has left the remains in the form of strangely contoured buttes.

It is a dry country averaging less than 10 inches of rainfall, and stream water is scanty, the main dependence being underground water from springs and wells. No other tribes of Indians have been subjected to such conditions as stated, and it is not strange that the Pueblos have developed a unique culture.

The most noticeable feature of this culture is the building of villages consisting of clusters of stone or adobe rooms of rectangular shape. For this reason the Pueblos are called the housebuilders. Some of the villages are built on the summit of high mesas difficult of access. Agriculture, the chief crop being maize, is the mainstay of Pueblo culture. The Pueblos are skillful potters and weavers. Their decorative art is excellent.

The Navaho settled in the open country in proximity to the Pueblos and are influenced by Pueblo culture, while the Apache settled in the forested mountains and rugged country and have remained in a low state of culture. The Navaho received the art of weaving, it is thought, from the Pueblos, though there is still a possibility that they may have brought it from the North. The possession of sheep has been a great blessing to the Navaho, affording them a supply of animal food, as these Indians are not farmers except in a limited way.

ANCIENT CLIFF DWELLING.

The semiarid region of Colorado, Utah, Arizona, and New Mexico abounds in canyons and plateaus; and the rocky walls have been carved by the elements into many fanciful shapes. Here also were left shelves, shelters, and caverns, and these were extensively utilized by the ancient tribes for dwelling purposes, from which circumstances they derive their name, "cliff dwellers." Along the face of the natural recesses, walls of stone were built up, behind which rooms of various sizes were formed by partitions of rude masonry. These were reached by natural pathways, by steps cut into the rock, and by wooden ladders, and they served for defense as well as for abodes. By the remains of industrial arts found in the cliff structures, their builders are shown to have been the ancestors of the Pueblo tribes. (See pl. 34.)

MODEL OF THE HOPI PUEBLO, WALPI.

Northeastern Arizona.

Walpi is a pueblo of the Hopi Indians who live in northeastern Arizona. It takes the name, "Place of the Gap," from a notch in the mesa upon which it is situated. The top of the Walpi mesa is about 500 feet above the level of the plain and is now totally destitute of vegetation. The sides of the mesa are in places precipitous, the approaches to the village upon it being by steep trails.

Walpi was settled on its present site shortly after the year 1680, having been previously established on the terrace a hundred feet below the top. The original settlers belonged to the Bear and Snake families, the former of whom came from Jemez, New Mexico, the latter from near Navaho Mountain, near the Colorado River. The first buildings erected by these families are situated at the ends of the space midway the east side of the pueblo. The increase of these clans and the addition of new rooms to the ancestral buildings finally joined them, forming a row of buildings on the front of the pueblo about midway in its length. The first house on the west side of Walpi was erected by the Flute people, a group of clans that originally came from southern Arizona. The line of rooms formed

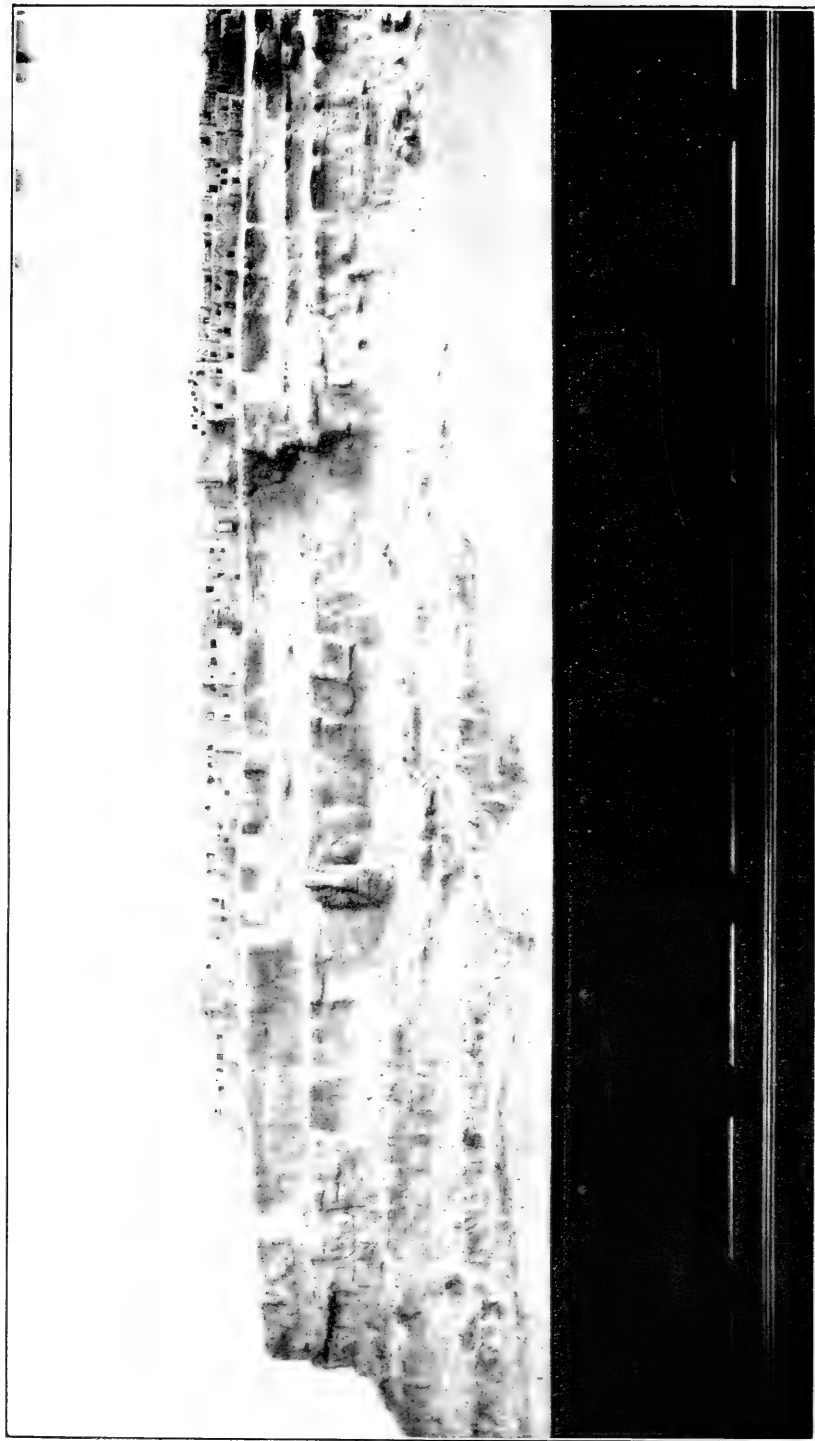

DWELLING GROUP OF THE HOPI INDIANS.



FAMILY GROUP OF THE HOPI INDIANS.

by the additions to this house is separated by a court from the main part of Walpi. The buildings in the southern portion of the pueblo were constructed by the Rain Cloud, Tobacco Land, and other clans, many of whom were subsequent additions to the population. The ancestors of a majority of these came from villages—now ruins—in southern Arizona.

Two kinds of rooms may be recognized in the model. There are many living rooms and five ceremonial rooms or kivas. The former are huddled into clusters; the latter are isolated in the plazas. At the highest point the main cluster of rooms is made up of four stories. There are two plazas, one of which, situated near the south end, is inclosed by buildings and contains two kivas; the other is open on the east side midway in its length. In the latter, indicated in the model by an eroded pinnacle called Antelope Rock, occurs biennially the celebrated Hopi Snake Dance. The secret rites of this dance are performed in the two kivas in the south plaza.

The model represents aboriginal Walpi in 1884, before the introduction of innovations due to contact with white men, and was modeled by Victor and Cosmos Mindeleff. (See pl. 35.)

FAMILY GROUP OF THE HOPI INDIANS.

Northeastern Arizona.

The Hopi Indians occupy stone-built villages in northeastern Arizona. They were first seen by white men in 1540, when Tobar and Padilla were dispatched by Coronado to visit them. On account of the isolation of their country they have preserved to a greater degree than other tribes the arts and customs of the Pueblos. They are farmers and depend mainly upon corn for their subsistence. Among the arts in which they are skillful are weaving, basket making, and wood carving, and in the minor art of cookery they are widely known among the Indians. The group represents the parching, grinding, and baking of maize, which goes on in every household. A woman and little girl grind on the slanting millstones the corn prepared by the parcher. The baker spreads with her hand the batter on the heated stone slab and the result is the paperlike bread called piki. Another woman is weaving a basket of yucca leaves. The man brings in from the field a backload of corn ears and the boy exhibits triumphantly a rabbit which he has killed with the curved boomerang club peculiar to the Hopi. (See pl. 36.)

THE SNAKE DANCE.

An Episode in a Hopi Prayer for Rain.

The Indians of the principal Hopi pueblos of northeastern Arizona celebrate in the month of August, at intervals of two years, a

remarkable ceremony of several days' duration, whose purpose is to beseech the gods to grant rain for their crops. The culmination of the ceremony is an open-air rite in which live snakes are carried, and the most striking episode of this dance is presented in this group, which shows a trio of Snake priests, respectively, the "carrier," the "sustainer," and the "collector," a line of priests of the Antelope Society, who act as chorus, and a maid and matron whose office is, along with others, to scatter sacred meal on the participants as a sacrifice to the gods.

The dance takes place in the plaza of the village, on one side of which is built a bower of cottonwood branches in which the keeper of the snakes sits with jars containing venomous species, which he hands out from time to time to the carriers. The dancers march in file around the plaza, each stamping on a small board set in the ground in front of the bower as he passes, as a notification to the gods of the underworld that a ceremony is in progress. They then assume their places in two files, facing each other, the Antelope chorus flanking the brush house, where they sway and chant for a few minutes, shaking their rattles. The file of Snake priests then breaks up into groups of three, and they dance around in a circle, receiving the snakes as they pass the brush house, the carrier holding one or more in his mouth, the sustainer diverting the attention of the snakes with a feather wand, while the collector attends to gathering the stray snakes. After dancing around for a while, they drop the snakes on the ground, to be seized by collectors, who keep them in their hands until the completion of the ceremony, when the priests carry the snakes swiftly to the country below the mesa on which the village stands, where they are released.

The ceremony originated and is kept up in accordance with the belief that the first children of the union between an ancestral culture hero and a mythical Snake princess were rattlesnakes, and hence the elder brothers of the later generations. Being sprung from a source in some respects supernatural, snakes are believed to be in close touch with the gods that control rain, which insures the crops and other blessings needed by the Hopi, whose country is arid and desolate.

None of these people would willingly kill a snake, poisonous or harmless, as they are regarded as sacred and imbued with some of the peculiar attributes and powers of the gods. Rattlesnakes are generally used in this ceremony, but, due to the care in handling them, accidents rarely or never occur. The ceremony, as practiced to-day, is usually witnessed by large numbers of strangers. (See pl. 37.)

FAMILY GROUP OF THE ZUÑI INDIANS.

These Indians occupy the most important of the adobe pueblos situated in western New Mexico. They are of medium height, strong,



GROUP OF SNAKE DANCERS.



FAMILY GROUP OF ZUNI INDIANS.

well built, and active. Their chief subsistence is Indian corn, which they cultivate in irrigated fields, and they raise, besides, some wheat and vegetables. To these are added great supplies of wild fruits in season, such as yucca and the prickly pear. They hunt deer in the neighboring mountains and capture rabbits and other small mammals in the open country about their village.

The Zuñi are skillful in pottery making, weaving, bead making, silverwork, and in the decoration of objects connected with their religious life.

The domestic life of the Zuñi is extremely well ordered, practically everything being regulated by a schedule which bears evidence of great antiquity. The men bring in the crops from the fields and give them over to the care of the women, who prepare them for the consumption of the family. The women are adept at making many kinds of bread with corn flour, the most familiar being a wafer-like bread baked by spreading a thin batter upon a heated slab of stone. The water supply of the family is kept in large pottery jars, which are filled by the women, who carry it from the river in vases borne upon the head.

The houses, which are built of stone and plastered with mud, are large and comfortable, are kept scrupulously clean, and in them most of the domestic industries are carried on, such as are illustrated in the group. The young woman in the foreground is engaged in weaving a belt of the kind in common use, the old man is in the act of drilling a turquoise bead with the primitive pump drill, the farmer brings in some of the products of the fields, and his wife, emerging from an inner room, gives an appreciative welcome; the strong young maiden of the family brings in a vase of water, offering a cup to the girl who is about to prepare flour for the baking, while the boy pounces upon the keenly appreciated watermelons. (See pl. 38.)

ZUÑI WOMEN MAKING POTTERY.

Zuñi Indian women of New Mexico make pottery by the coiling method. The clay is gathered from the deposit and carried on the backs of women to the place of manufacture, then thoroughly washed, cleansed, and mixed with the proper quantity of pulverized potshards. After shaping the prepared clay into long rolls from half to three-quarters of an inch thick, the woman builds up her vessel by coiling, as shown by the standing figure in the group. When the vessel is dried all the inequalities are carefully removed from the surface, as shown by the sitting figure. The vessel is then washed with fine white slip, dried, rubbed smooth, painted, as shown by the seated figure, and then baked in an open kiln made of chopped grass and shrubs. The colors used in painting are yellow ocher for red, iron ore for dark brown, and kaolin for white, the brushes being bits

of yucca leaf. This is a modern representation of an ancient industry quite widespread in the southwestern United States, and the processes employed at present are identical with those of ancient times. (See pl. 39.)

DWELLING GROUP OF THE NAVAHO INDIANS.

NEW MEXICO AND ARIZONA.

The Navaho live in the dry uplands of western New Mexico and northeastern Arizona, subsisting principally on their flocks of sheep, from the wool of which their well-known blankets are made. They are not village dwellers, and rarely more than a few houses are seen together. The framework of the house consists of three timbers lopped off to form forks at the top. These timbers are inclined and the forks interlocked and against them are laid other lesser timbers, branches, brush, etc., and covered with earth. The entrance is through a rude covered way or vestibule. The smoke hole is in the apex of the house. The group shows two winter hogans or houses, a summer hut, a sweat house, and a dance house. (See pl. 40.)

NAVAHO INDIAN BLANKET WEAVERS.

The Navaho women weave excellent blankets, rugs, and belts on hand looms, using wool derived from their numerous flocks of sheep. The Navaho blanket has become well known on account of the striking native designs in color with which it is decorated as well as its durability in service. Their sale brings to the tribe thousands of dollars yearly. The yarn is spun on a simple spindle, is dyed with vegetable substances or with dyes purchased from traders, and is woven on rude looms provided with heddles for separating the warp. The weft is wound on a stick and thrust through the shed and pounded down with a wooden sword or batten. The patterns, which are alike on both sides of the fabric, are produced by laying in a colored weft yarn between a counted number of warp threads, leaving it out, adding another color similarly, and so on across the weaving line. The warps are then crossed and the process continued. The weaving, being of short weft yarns, can not be duplicated on power looms, though imitations of the patterns and fabrics alleged to be Navaho work have been offered for sale. The woman spinning and the woman working at the loom wear dresses of their own weaving. The Navaho learned the art of weaving from the Pueblo Indians. (See pl. 41.)

NAVAHO INDIANS MAKING SILVER ORNAMENTS.

The Navaho Indians of Arizona and New Mexico were taught a rude sort of metal working by the Spanish conquerors, and they have become very adept in the use of their primitive tools and apparatus.



GROUP OF ZUNI POTTERS.



DWELLING GROUP OF THE NAVAHO INDIANS.

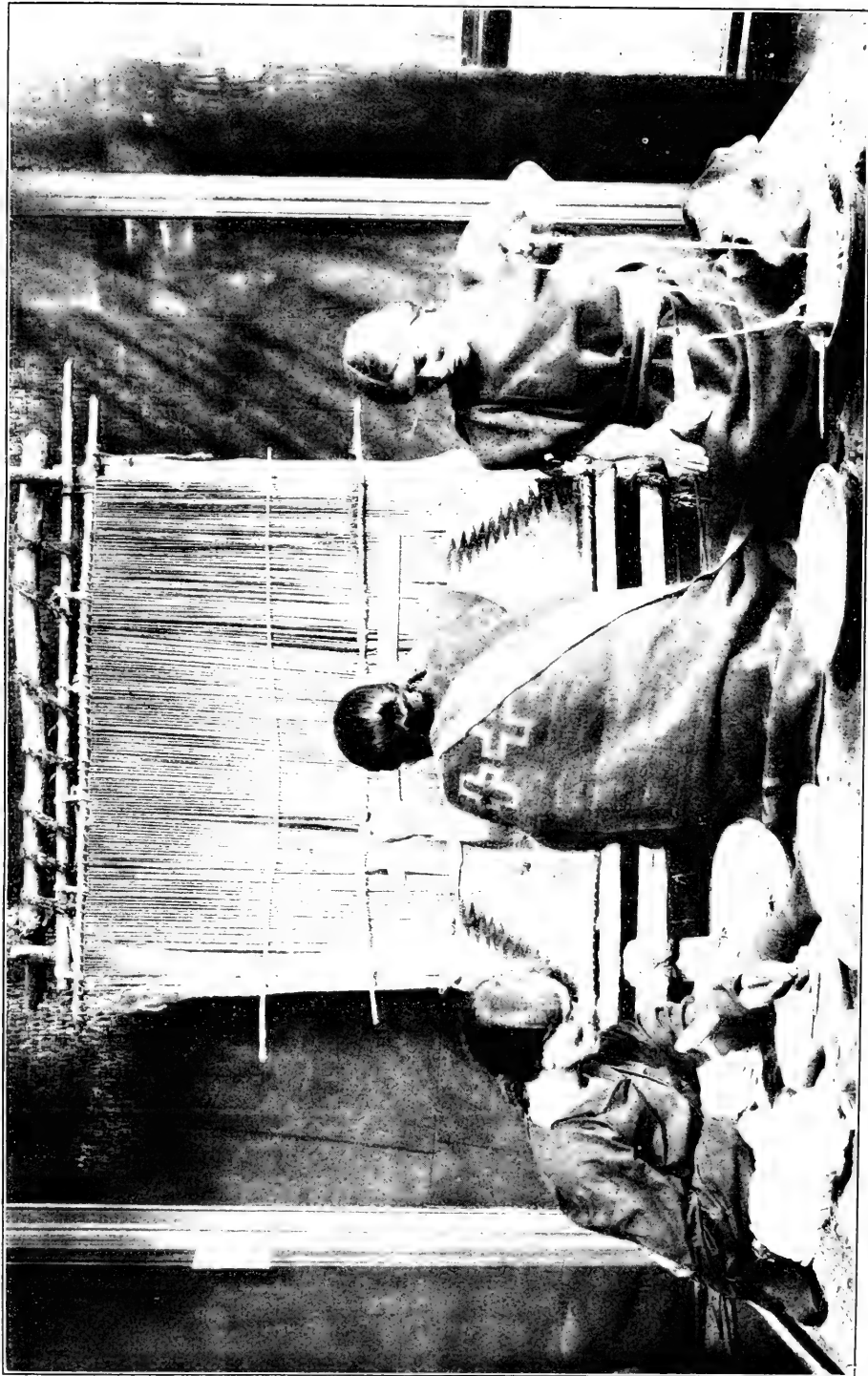

GROUP OF NAVAHO WEAVERS.

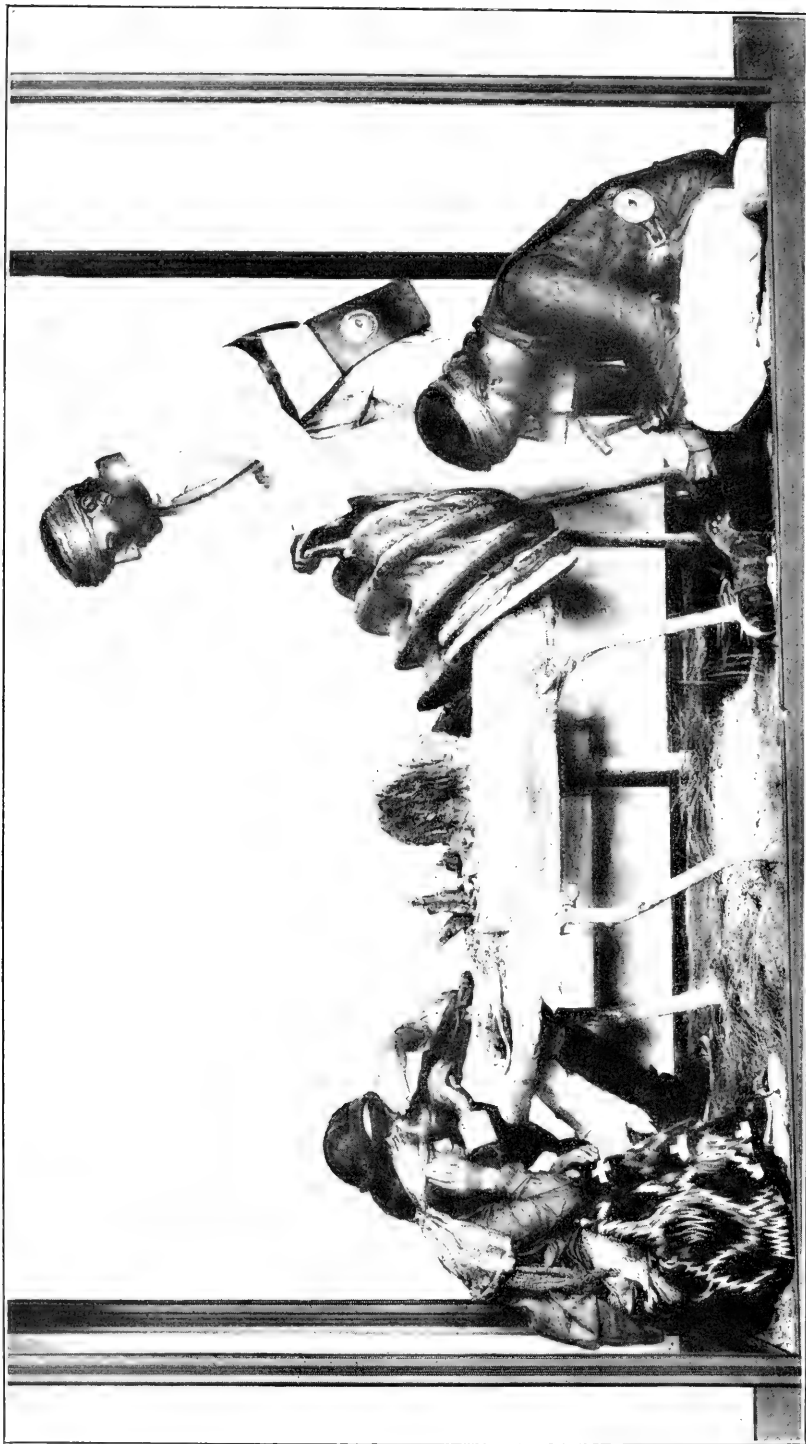

GROUP OF NAVAHO SILVERSMITHS.

It is known that they did not mine for silver, all of their products being made from Mexican and American coins. The silver is either cold-hammered or melted in open crucibles by the use of charcoal and flux, with blast produced by bellows having two air sacks of leather with valves, which appear to have been introduced from Spain by way of Mexico. Much metal is wasted in the operation. It is brought into final shape by hammering, punching, chasing, and engraving. The objects made are mainly personal ornaments, such as buttons, ear ornaments, beads, and bracelets; examples are placed with the figures.

The processes are fully described by Dr. Washington Matthews in the Annual Report of the Bureau of Ethnology, Washington, 1883, pages 167-178. (See pl. 42.)

APACHE MAN AND SQUAW.

The Apache Indians belong to the Athapascan family and now live in Arizona and New Mexico, but they originally dwelt in north-west Canada. For 350 years they have been in contact with white people, but have adopted with the greatest reluctance any of the ways of civilization. They dress in skins, build dome-shaped thatched brush houses for habitations, subsist principally on the chase, and the women make exquisite coiled basketry. The gradual destruction of game has compelled them to use materials obtained from the whites in their clothing, but they follow their ancient methods and patterns as much as possible. In strange contrast with the Apache and their kindred are the Navaho, who own vast flocks of sheep and are inclined to peace. (See pl. 43.)

TRIBES OF THE MEXICAN BORDER AND NORTHERN MEXICO.

The southern slope of the great table-land where the Pueblo Indians live is inhabited by the Pima-Papago Tribe whose language forms a separate stock called Piman, spoken by tribes whose limits reached formerly to central Mexico, and the Mohave, Yumas, Cocopa, Havasupai, Walapai, and others of the Yuman family. The Pimas who are affiliated with the Papago exhibit a desert culture and in spite of their seemingly unfavorable environment live comfortably by agriculture and by the native vegetal products of the region. Their country is hot and dry and irrigation is necessary. One of the greatest primitive irrigation systems was constructed in pre-historic times in the Salt River Valley presumably by the ancestors of the Pima. The Pimas wove native cotton and wool cloth up to a score of years ago. They make pottery and excellent baskets. Their architecture is crude, but as is shown by the ancient ruins of Casa Grande near Florence, Arizona, they were formerly great builders.

The Yuman tribes in general are the least advanced of any tribes in North America and fall below the Apache in this respect. The Yuman tribes are found in Arizona, southern California, and Lower California. They also may be characterized as having desert culture of a more complete type than the Pima.

DWELLING GROUP OF THE PAPAGO INDIANS.

Type of the Sonoran Province.

The Papago Indians are of the Piman family, inhabiting Pima County, Arizona, and portions of the State of Sonora, Mexico. They dwell in dome-shaped houses in which a frame of mesquite poles is fastened together with yucca twine and covered with grass. The top is overlaid with adobe, and the walls are protected with long, thorny, cactus stalks. Other outbuildings are the kitchen circle, the square shelter after Mexican model, and the round house showing structural features. The food of the Papago is chiefly vegetable, the staple being mush from the beans and pods of the mesquite tree. They are potters and use the paddle and hand stone in building up the work. The Papago wore little costume, the modern dress being modified after European pattern. The men formerly wrapped skins about their loins, and women were clad in fringed petticoats of shredded bark and leaves. (See pl. 44.)

MOHAVE INDIAN CHIEF.

The Mohave Indians belong to the Yuman stock and live in the hot desert region of southwest Arizona. The men wear only a cincture of the interior bark of the willow or the cottonwood tree. The women wear skirts of the same material reaching to the knees. For the purpose of comfort, as well as for ceremony, they paint their bodies with different colored clays, a custom quite widely dispersed over the warmer parts of the continent in pre-Columbian times. They subsist on vegetable food chiefly and the women make excellent pottery by malleating—that is, by working the clay into shape by beating it with a paddle. The men use a very long thick bow, without backing, and arrows of reed with three short feathers. The foreshafts of wood are rendered heavier by a coating of gum. (See pl. 45.)

FAMILY GROUP OF THE COCOPA INDIANS.

The group is intended to stand as a type of the tribes inhabiting the arid region of the far southwest of the United States and northwestern Mexico. The principal tribes of this region are the Pima, Papago, Mohave, Yuma, Kawia, and Seri, whose manner of life is largely determined by the character of the country, which is hot and

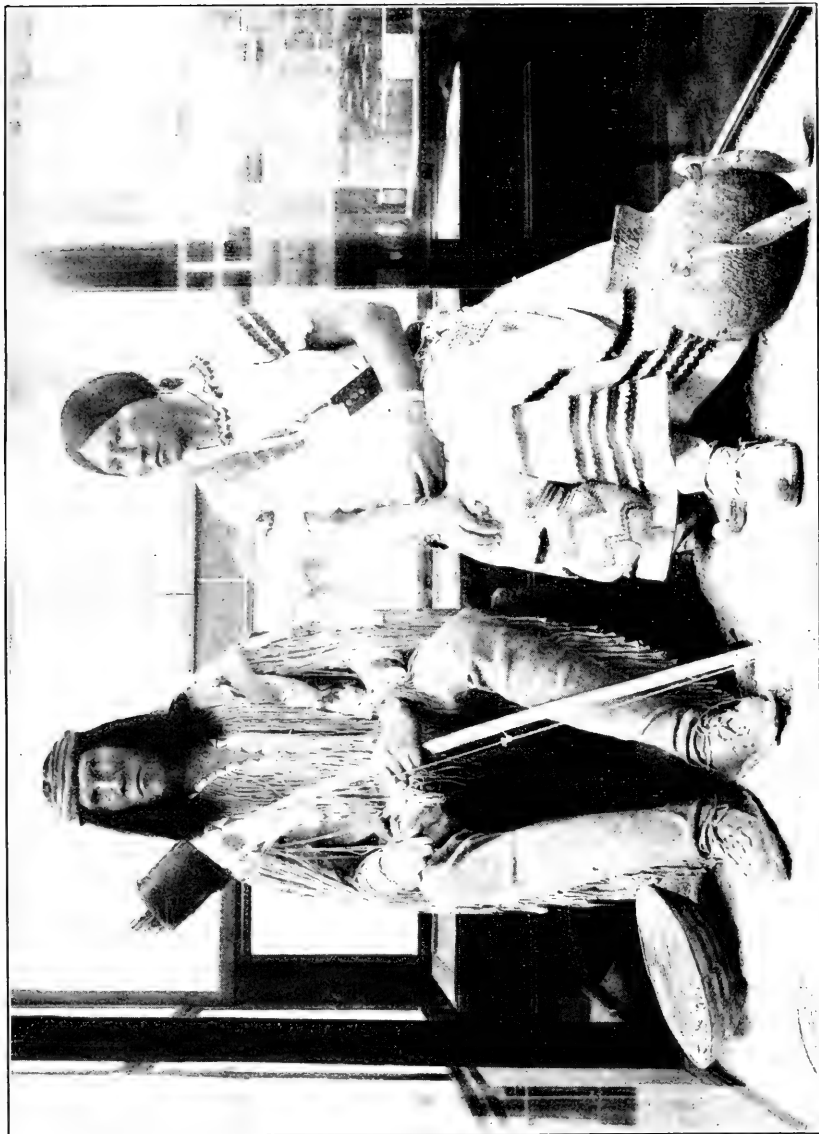

APACHE MAN AND WOMAN.





MOHAVE INDIAN CHIEF.

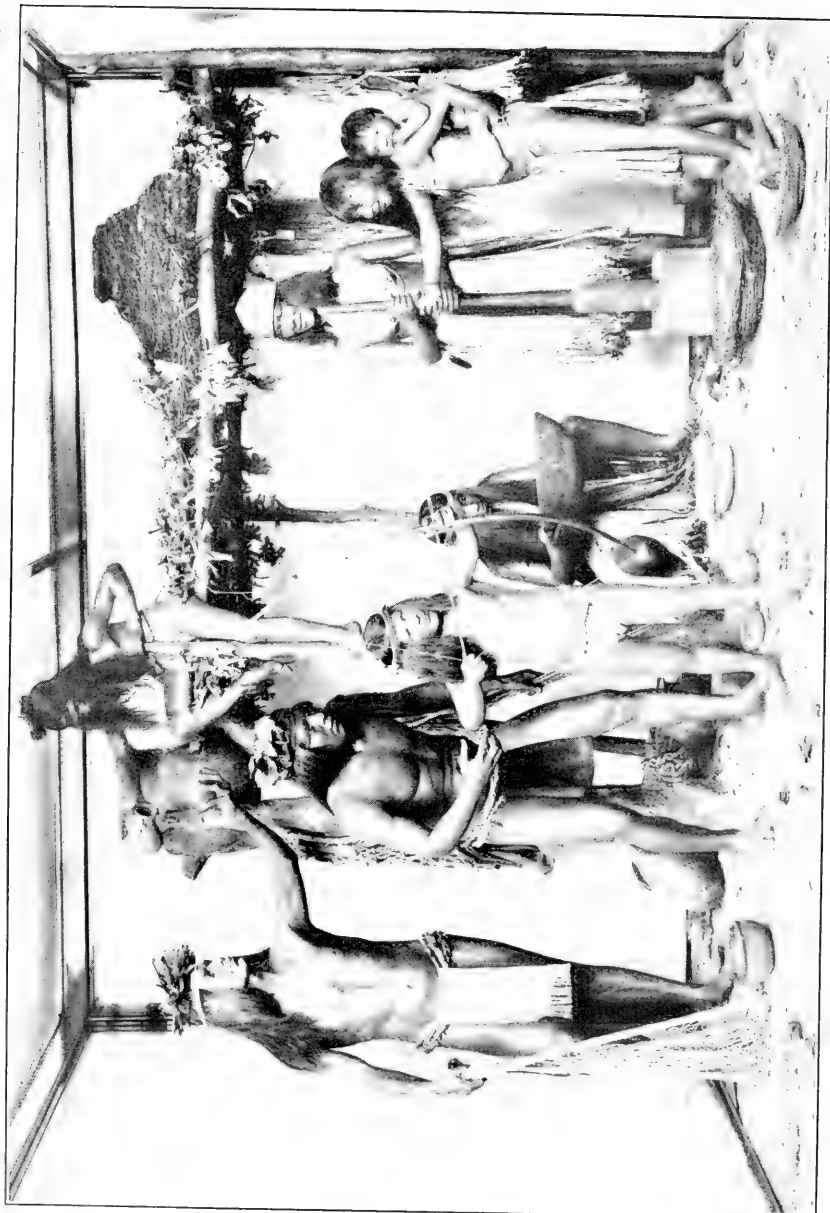

FAMILY GROUP OF THE COCOPA INDIANS.

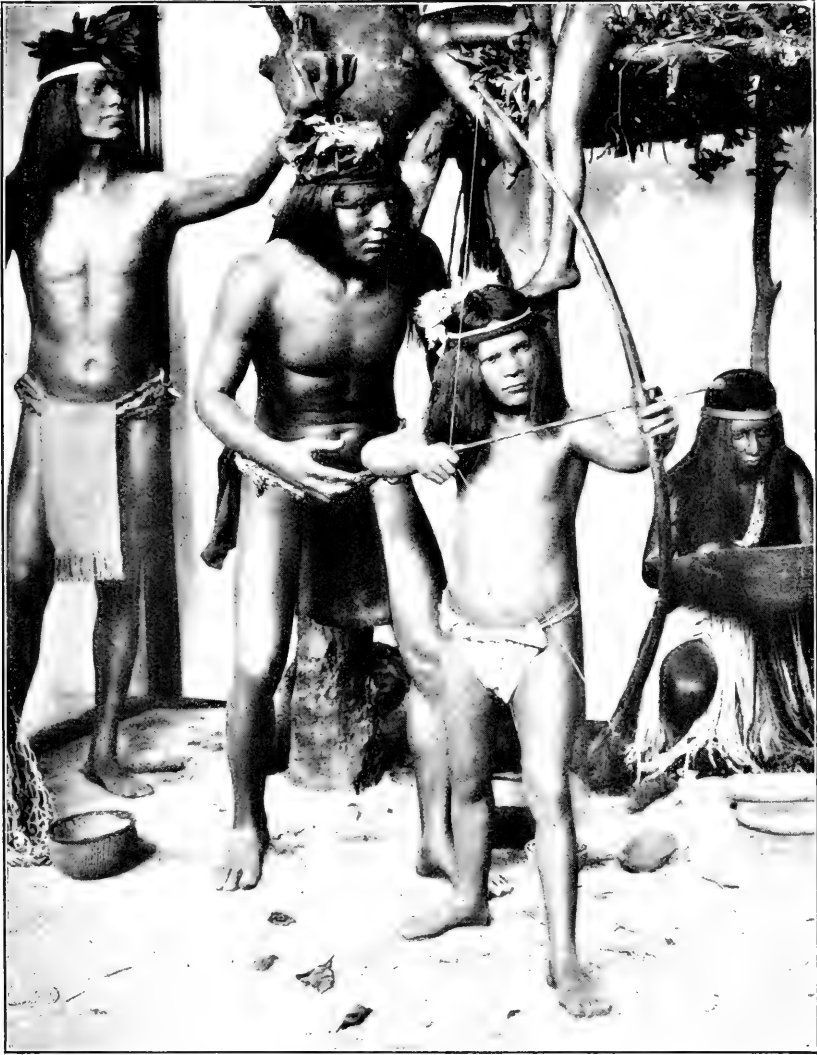

CLOSER VIEW OF SECTION OF COCOPA GROUP.

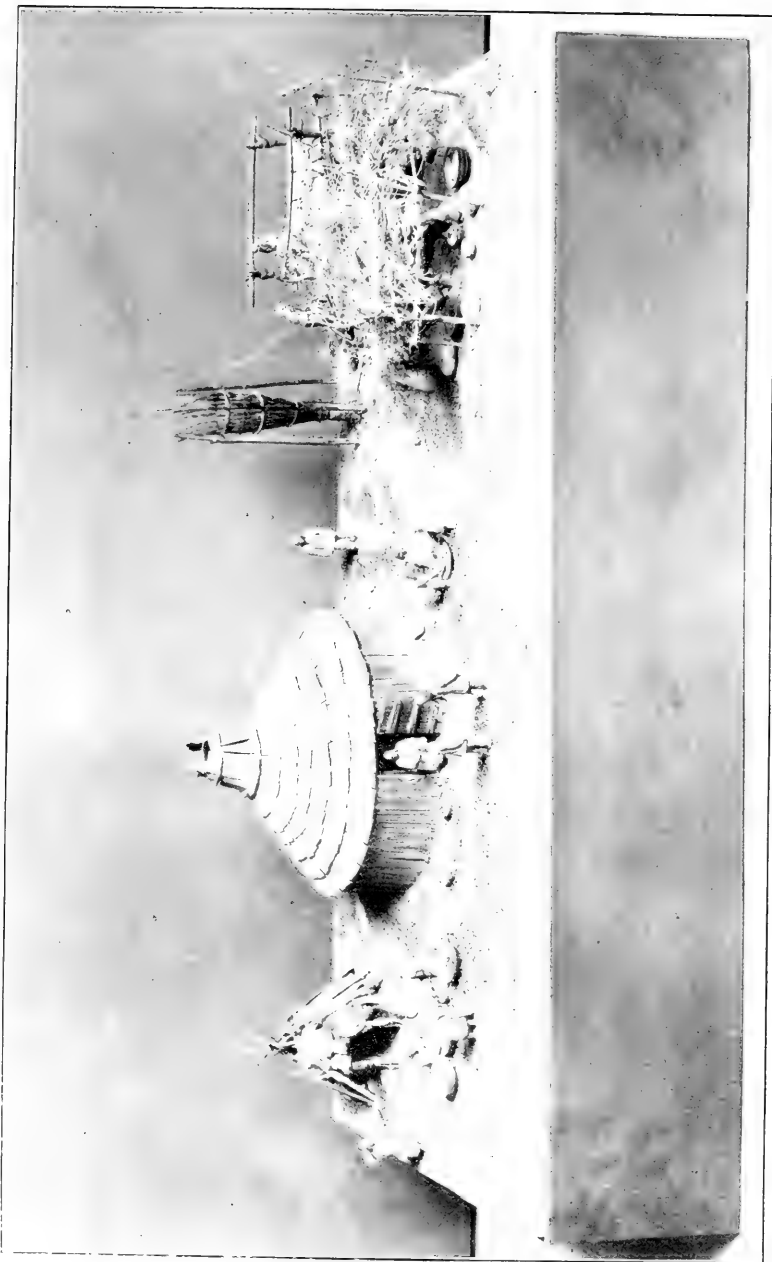

DIGGER INDIAN DWELLING GROUP.

dry, and characterized by sparse, thorny vegetation and restricted animal life.

The Cocopas are in a limited way agriculturists, raising corn on the flood plains of the Colorado, and besides, securing much food from grasses, the mesquite, agave, screw bean, and cactus. They also fish in the Colorado and in the sinks formed by overflows of the river, and hunt rabbits and other small animals.

Their manufactures are of the few articles required for their simple needs, such as water-cooling jars of porous pottery, cooking pots, etc.; simple cord work and weaving for nets and clothing; and ornaments in shell, feathers, etc., for the head and neck. Important household occupations are illustrated by the two women, the one cleaning seeds with a basket, and the other pounding grain in a wooden mortar. Water for drinking is cooled in a porous pottery jar set in the crotch of a tree where the air circulates freely, and the returning fisherman has his cup filled by the willing boy.

The pastimes of uncivilized peoples tend to some useful end like the instruction of the boy in archery, which also furnishes amusement to the whole family. The sun shelter at the back of the group, made of rude sticks, serves also for the safekeeping of the wicker grain storage basket, jars for seeds, digging sticks, and other implements of husbandry. (See pls. 46 and 47.)

TRIBES OF CALIFORNIA.

California possesses a considerable diversity of climate and topographical features and more different stocks of Indian languages than any other region of North America. As a group of ethnic provinces California is more isolated and isolating, in reference to human occupation during the Indian régime, than any other portion of the United States. There are really three ethnic provinces in California: Northern, central, and southern. The central and southern provinces are inhabited by tribes influenced by the desert culture of the Great Basin, the southern province by desert tribes along the Mexican boundary, while the northern province presents a diversity of tribes.

Agriculture was practically nonexistent among the California tribes. Maize was unknown except to the southeastern tribes. The abundant and varied natural food supply was more than sufficient for the native population. One of the more important food resources was acorns, which supplied the need for starchy food.

While there are various degrees of culture among the many tribes of California, in general the California Indians show considerable progress. The coast tribes were farthest advanced. Though architecture was not important, the California Indians excelled in the minor arts, evidencing great taste and skill in everything they made.

Nowhere in the world did the basketry maker's art attain such perfection or show such esthetic feeling in form, color, and decoration. Featherwork, shellwork, and stonework were also superior.

DWELLING GROUP OF THE DIGGER INDIANS.

The so-called Digger Indians are of the Pujunan and the Moquelumnan family, and occupy an extensive area in eastern California. They received the name of Digger Indians from the use of roots in their arts. Their dwellings are primitive, but modified through influence of the whites. This group includes the communal house, a framework covered with boards and shingles; the mill shelter; the summer house, where the household arts are carried on; the storage platform; and the granary. As these people subsist largely on acorns, a great part of the woman's life is spent in gathering the nuts, carrying them home in conical baskets suspended from the forehead, drying and hulling them, grinding them in stone mortars, sifting, leaching, cooking, and serving the meal in the form of mush. The men are hunters and fishers. (See pl. 48.)

FAMILY GROUP OF HUPA INDIANS.

Northern California.

The Hupa Indians of northern California belong to the Athapascan stock, the principal territory of which lies in northwestern Canada and the interior of Alaska. They subsist on the abundant salmon of the streams, the game of the mountains and the products of native vegetation, especially acorns, which are used for bread. The acorns are crushed with a pestle in basket mortars; the meal is leached out in sand basins, and cooked into mush in water-tight baskets by means of hot stones, or is baked on soapstone dishes over the coals. The men are valiant warriors and great hunters, wearing armor of thick skin and of woven rods in battle and possessing sinew-backed bows of extraordinary strength. The women excel in tanning skins, which are used for clothing, and in making baskets, the latter in the absence of pottery serving in a wide range of uses. The artistic inclination of the Hupa, which they possess in a special degree, is shown by their beadwork, featherwork, bows and arrows, baskets, the carving of stone pipes, knives, mortars and pestles, and in the shaping of boxes, daggers, and spoons from antler.

This group represents the family engaged in the varied occupations of the household and includes a woman bringing in from the oak groves a basket of acorns supported by means of a headstrap; another is pounding acorns into flour in the basket hopper set upon a stone mortar; a third is leaching the acorn meal in a basin of sand preparatory to cooking in a water-tight basket by means of hot stones,

and a little girl carries the baby, secure in its wicker cradle. The man of the family, just arrived from a hunting trip, is striking fire by rubbing two sticks one upon the other, an art in which the Hupa are very proficient. On the ground are baskets for sifting, for cooking, and for storing the acorns; wooden bowls and headrests, spoons, paddles and other domestic utensils, examples of which may be seen in detail in the neighboring case. (See pl. 49.)

TRIBES OF MEXICO AND CENTRAL AMERICA.

In the great territory covered by the political divisions of Mexico and Central America we find centers of high culture and organized civilization, while at the same time there were, as to-day, tribes very low in the scale. We may contrast the cultivated ancient Aztec with the ancient Chichimec named "filth-eaters," or the modern Mexican with the savage, reputed cannibal Seri, dressed in an apron of pelican skin. Many tribes in Mexico are in the aboriginal state, possessing the arts and industries of ancient times. Central America presents the same human contrasts. Some of the tribes of Central America likewise illustrate the decadence which has taken place since the grand periods of the Maya civilization whose art and architectural remains astonish the world. The connection of the Maya civilization with those of South America is perhaps not close and, with Old World civilization, is as yet a matter of conjecture. The present Maya culture presents few features of interest.

SERI INDIAN HUNTER.

The Seri Indians, who occupy Tiburon Island in the Gulf of California and the adjacent mainland of Sonora, Mexico, subsist largely on fish, mollusks, turtles, etc., from the waters of the Gulf, and the flesh of pelicans, cormorants and other water fowls, usually taken at night on islands adjacent to Tiburon. During autumn and winter, and sometimes at other seasons, they repair to the mainland, where they subsist chiefly on the flesh of rabbits, wild turkeys, peccaries, deer, etc. Their diet is varied in autumn by the addition of fruits of cacti, with berries, mesquite beans, etc. They neither plant nor cultivate, and have no domestic animals except dogs. Most of their food is eaten raw. They have been constantly at war with the whites and other native tribes for three and a half centuries. Their chief weapon is the bow and arrow, and they claim that their arrows are poisoned. They are remarkably swift of foot; three or four hunters frequently take large game by surrounding the animal, tiring it out and slaying it with clubs and stones. The costume is a skirt of pelican skin, short for the men, longer for the women. They paint their faces with elaborate designs, using mineral pigments of

various colors. In physique the Seri Indians are notable for slenderness, especially the lower limbs; for depth and breadth of chest; for large stature, and for the dark color of the skin. (See pl. 50.)

WOMAN OF CHIAPAS, SOUTHERN MEXICO.

The costume consists of a woven skirt; an overgarment in damask pattern called huipille, with embroidered collar; a head handkerchief, and jewelry. Sandals are rarely worn. She carries the vessels of gourd and pottery in common use. (See pl. 51.)

FAMILY GROUP OF THE MAYA-QUICHE INDIANS.

The Maya Indians (Mayan family) inhabit Yucatan and Guatemala, including also some parts of Chiapas and a small area in western Honduras. At one time they were the most highly cultured of all the native peoples of the Western Hemisphere. They had an artificial basis of food supply, dressed in delicate fabrics, and were capable of erecting sacred edifices in dressed and garnished stone, also vast terraces, plazas, and stepped pyramids surmounted with buildings adorned with sculptures and paintings. They were of moderate stature, not warlike, but industrial, and the sculptures and paintings revealing their religion are remarkably free from bloody scenes. They number in Central America, at present, several hundreds of thousands. The family group here presented includes a man with his staff bearing a net filled with fruit, one woman working at the mill, a second woman carrying a basket of fruit in her right hand and a gourd in her left, while the girl walks by her mother and holds a decorated gourd vessel. (See pl. 52.)

TRIBES OF SOUTH AMERICA.

The South American Continent presents a similar diversity of Indian tribes and culture as North America, but as most of the tribes live in a tropical environment clothing and shelter and some other arts are not as prominent as in the north. In the vast basin of the Amazons and the heavily forested north, the Indian in perpetual contest with an exuberant vegetation made little progress toward civilization. In the Andes and on the west coast one of the greatest aboriginal civilizations grew up in an arid country offering few inducements for settlement as in the Pueblo region of the United States. These ancient people of Peru and Bolivia subsisted mainly on maize, potatoes, and quinoa, and had domesticated llamas which were used as beasts of burden and for wool. They were expert weavers, metal workers, potters, and wood carvers. They constructed roads over the mountains and built massive buildings of stone. At the time of the conquest the ruling tribe, called

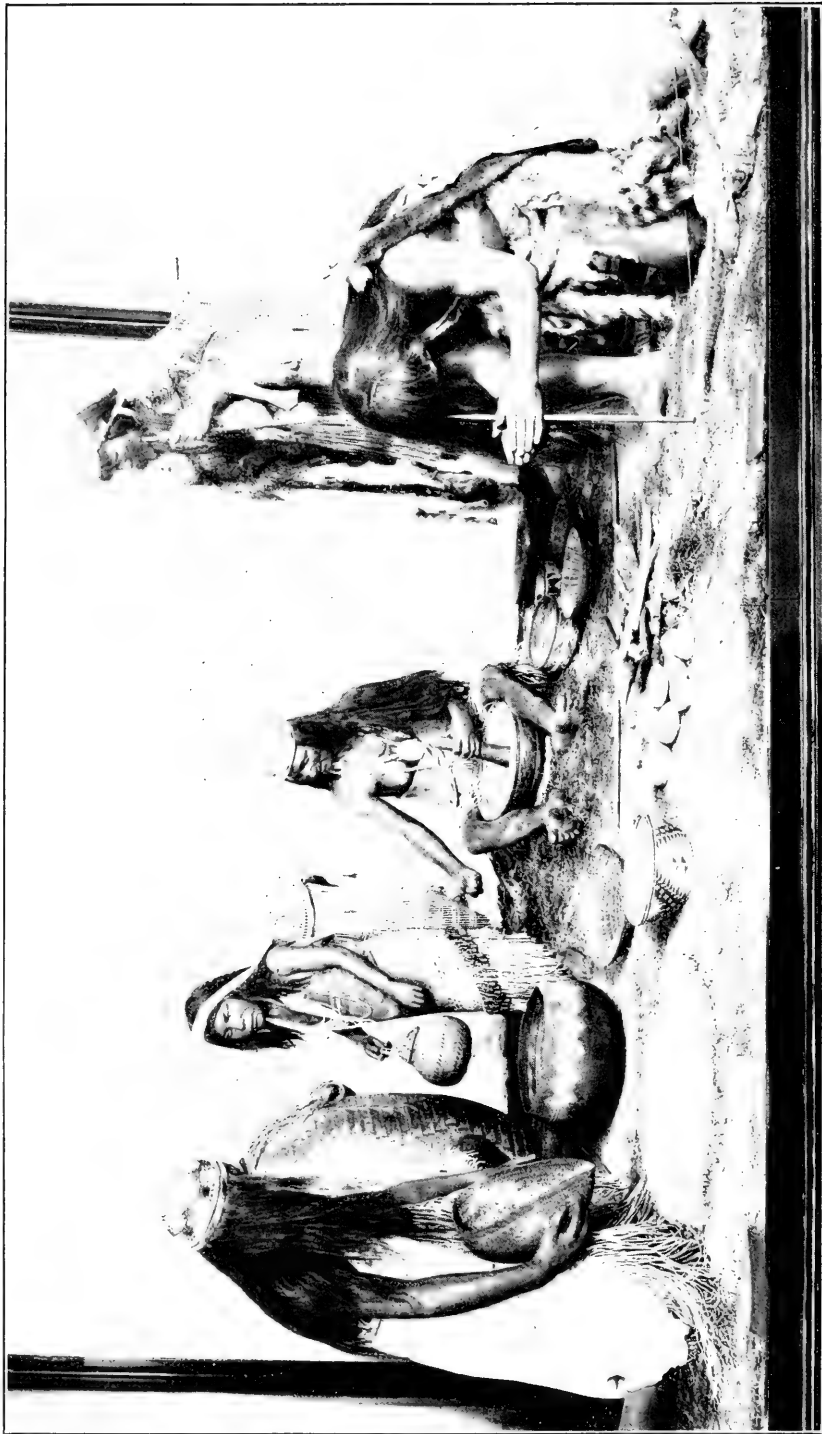

FAMILY GROUP OF THE HUPA INDIANS.



SERI INDIAN HUNTER.



WOMAN OF CHIAPAS, MEXICO.



FAMILY GROUP OF THE MAYA-QUICHE INDIANS.

the Incas, had perfected the most complete political and military organization known to have been formed among the American aborigines.

The Indians of the Amazons were somewhat further advanced than those of the north. The stimulus of communication over the extensive water system of the Amazons was felt by these tribes. Along these highways of travel there was also felt, though slightly, the influence of the distant civilization of Peru, growing more evident among the tribes on the upper affluents of the Amazons.

In the South Temperate Zone of South America are found conditions approaching those observed on the Plains in North America. The tribes of Indians also exhibit characteristics due to this environment. On the great open grassy plains game was abundant and herds of wild guanacos took the place of buffalo. The introduction of the horse also produced the phase of migration of freer movement seen on the North American Plains. The Fuegian and other tribes on the southern extremity of South America were rude in culture and correspond in this respect with some of the sub-Arctic tribes.

DWELLING GROUP OF THE CARIB INDIANS.

BRITISH GUIANA.

Tribes of the Carib and Arawak stocks having a similar culture live in the forests along the streams in the Guianas. They build large rectangular houses roofed with palm leaf and with one or more sides covered with the same leaf. Within the house hammocks are swung from post to post. Outdoor work consists of the grating, pressing, sifting, and cooking of cassava, which is an important food resource of these Indians, pottery making, wood carving, canoe making, etc. Sometimes the Arawak build a conical cook house. The tapir and other large animals are roasted on a wooden grid. (See pl. 53.)

FAMILY GROUP OF THE CARIBS.

Various tribes of the Carib-Arawak stock live in the interior of British Guiana, where they have only recently been visited by white men. The country is densely forested and tropical and the products and climate are like that of much of northern South America. The tribes of a vast region therefore are in about the same degree of advancement, which is not very high, but is interesting as a type of tropical culture, showing the great degree of repression exerted by exuberance of vegetal growth.

The group shows a warrior with blowgun; a woman and child squeezing cassava, which we know as tapioca, in a primitive lever press, the pressure being exerted on a tubular basket and the liquid

portion collected in a vessel set beneath; a woman decorating a tree gourd bowl with characteristic interlocking designs, and a child holding a pet bird and flowers. A hammock swinging from two house posts represents the bed in general use in Mexico, and Central and South America. (See pl. 54.)

DWELLING GROUP OF THE GOAJIROS INDIANS.

The discoverers of the northern coast of South America were astonished to find tribes living in huts built out over the water, and so they gave to this region the name of Venezuela, or Little Venice. These huts, only a few feet square, stood among the trees, on platforms constructed by interlacing the stems. These structures were afterwards supported on piles driven into the mud and stood 5 or 6 feet above the water. In the center of each platform was a pile of earth, and on this the fire was built and kept continually burning. Over the platform was suspended a low roof, thatched with palm leaves. Access to the house was had by means of a notched tree trunk. The natives moved about in dugout canoes, and, when the water was high, one of these could be seen tied to every notched ladder. Little clothing was worn, but there was much decoration of the person with feathers and seeds, and with the bones and teeth of small animals. (See pl. 55.)

DWELLING GROUP OF THE JAMAMADI INDIANS.

The Jamamadi live on the upper Purus River in western Brazil. Their houses, which contain many families, are sometimes 130 feet in diameter and 70 feet high, and consist of an elaborate framework thatched with palm leaf. There are also small shelters with floors raised from the ground for special uses in preparing food, or as poorer dwellings. These houses are always built near the banks of navigable streams. Canoes are made by folding up at the ends strips of bark taken from a large tree. The principal subsistence is cassava and maize. The cassava roots are grated on a board set with sharp pieces of stone, the poisonous juice pressed out in a tubular basket, and the starchy residue ground into flour. Basket making, wood carving, and other minor arts are similar to those of tropical South America. (See pl. 56.)

JIVARO INDIAN CHIEF.

The Jivaros are an independent stock of aborigines living on the headwaters of the Pastaza, Santiago, and other affluents of the Marañon River, Peru. They hunt and fish with the sarbacán or blowtube, the spear, and with bows and arrows. They also practice a primitive agriculture. Their houses, as well as their tools, are of wood. They use for signaling huge wooden drums and pre-

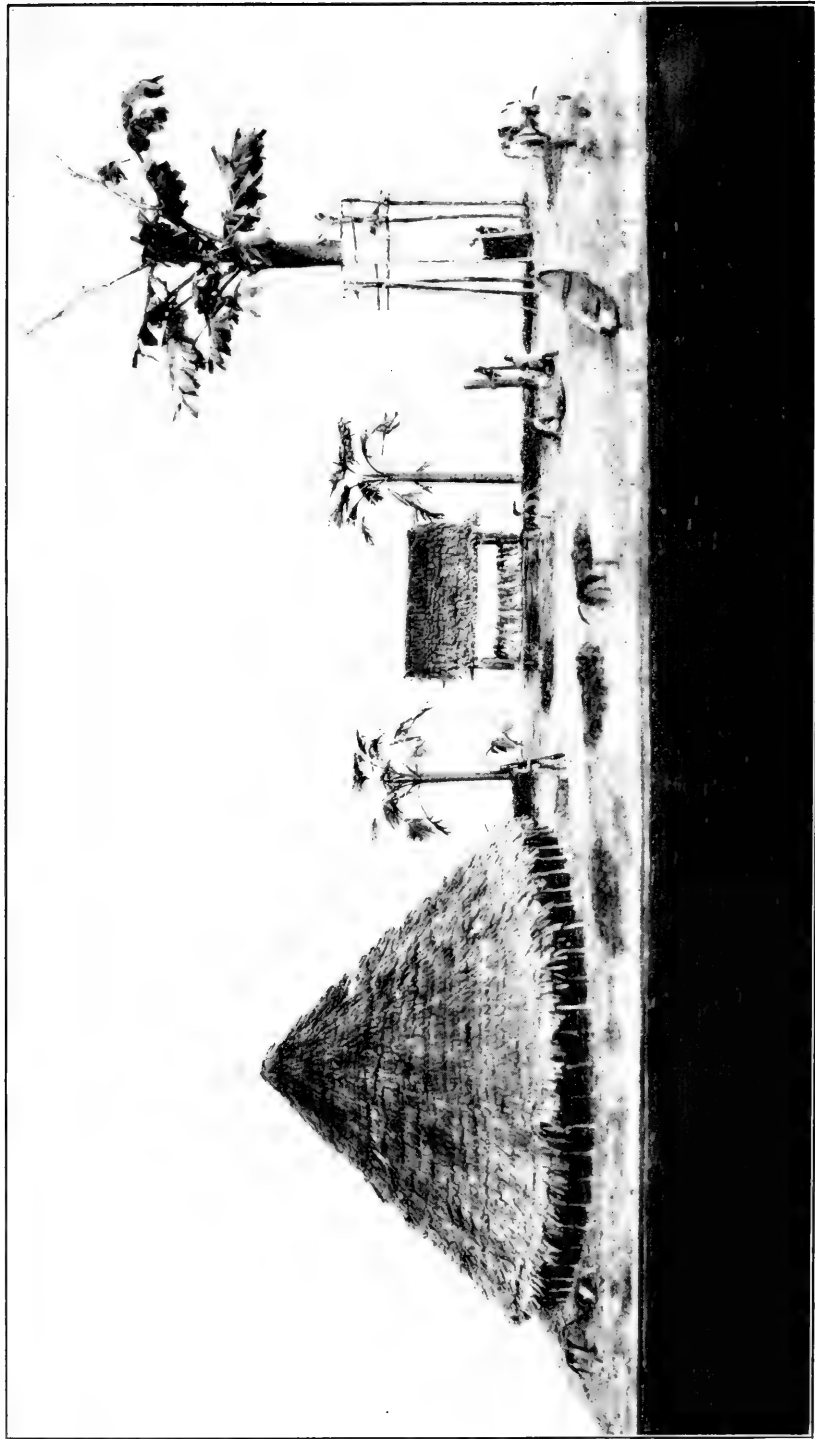

DWELLING GROUP OF THE CARIB INDIANS.

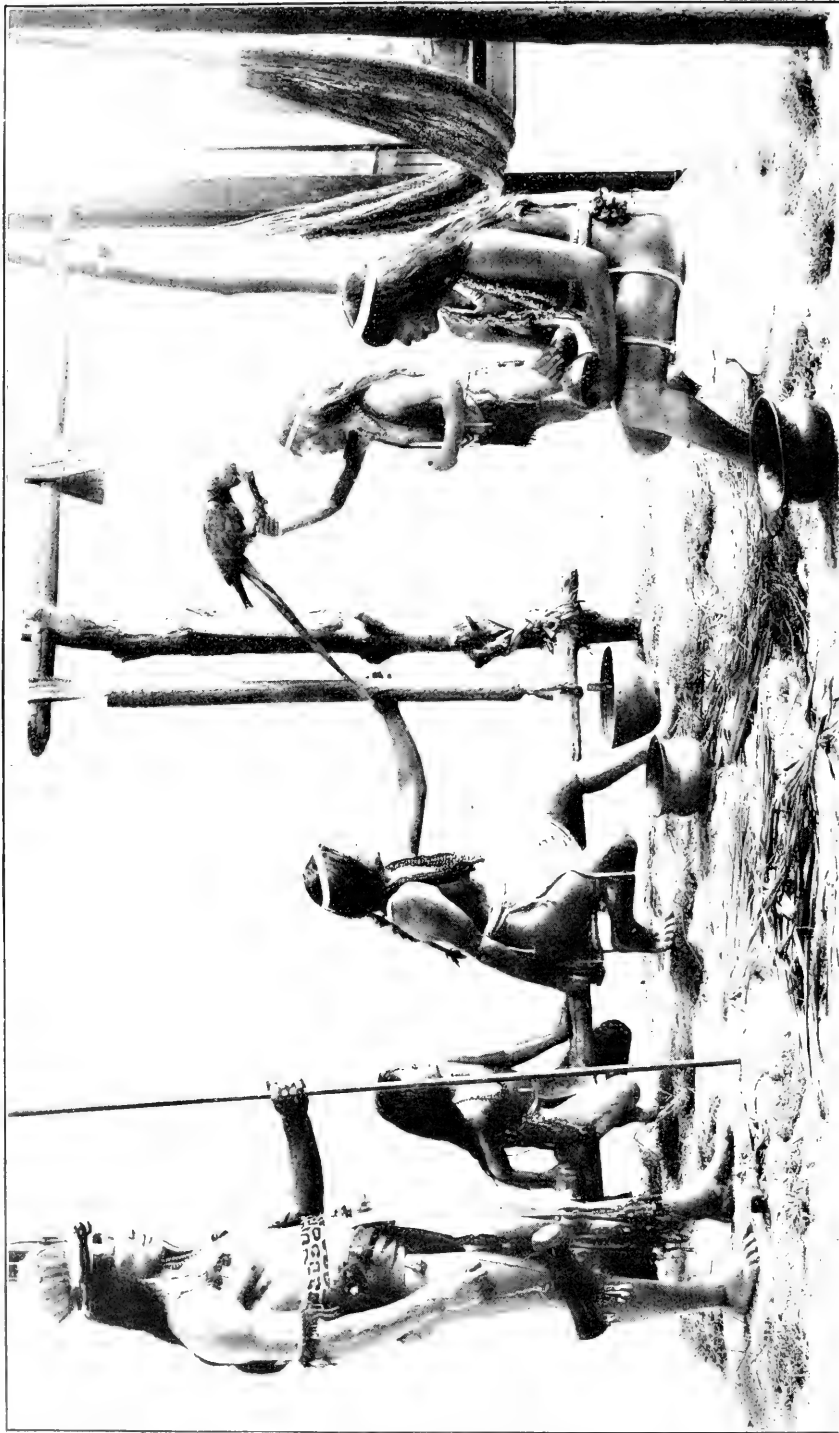

FAMILY GROUP OF THE CARIB INDIANS.

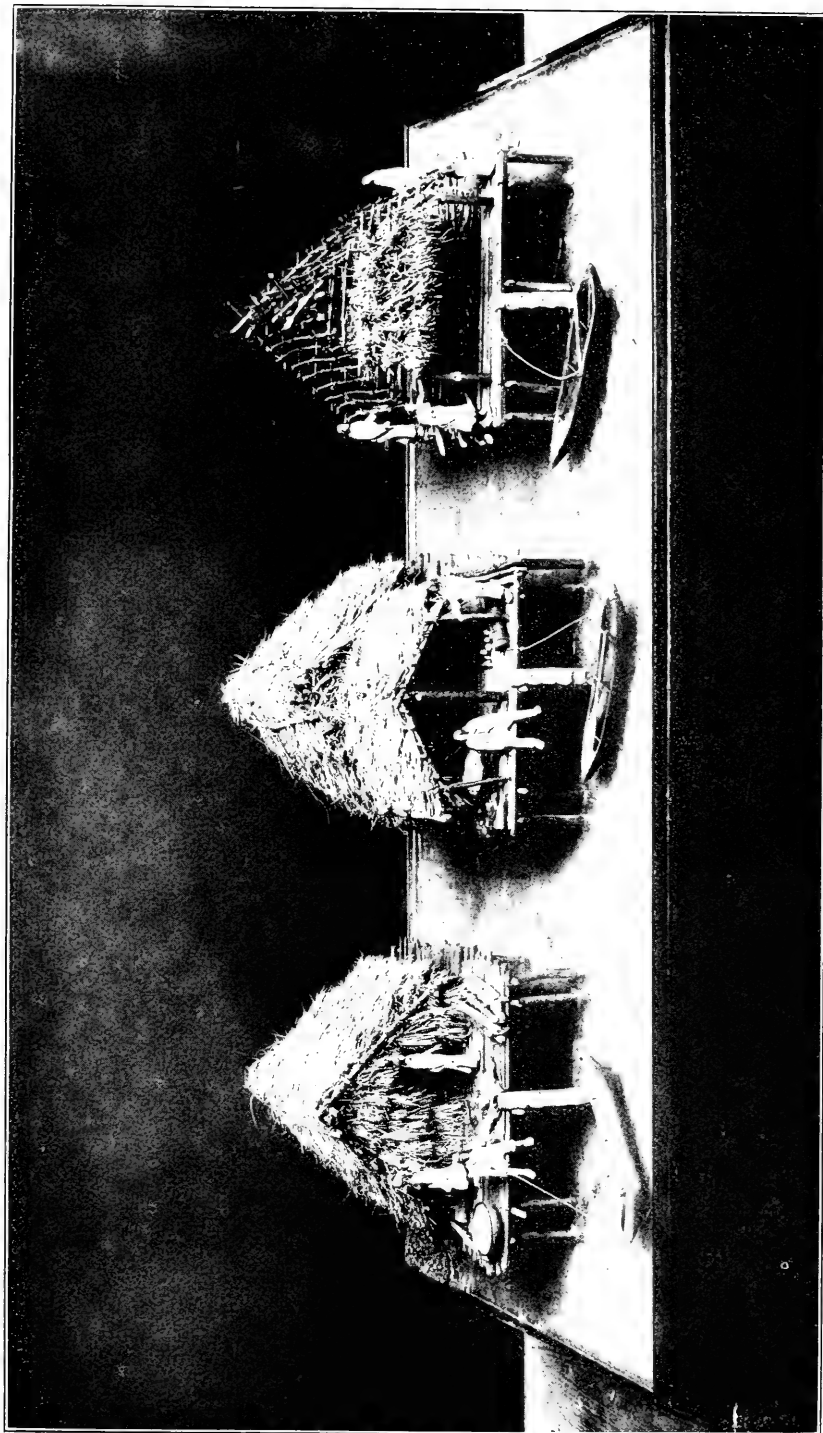

DWELLING GROUP OF THE GOAJIROS INDIANS.

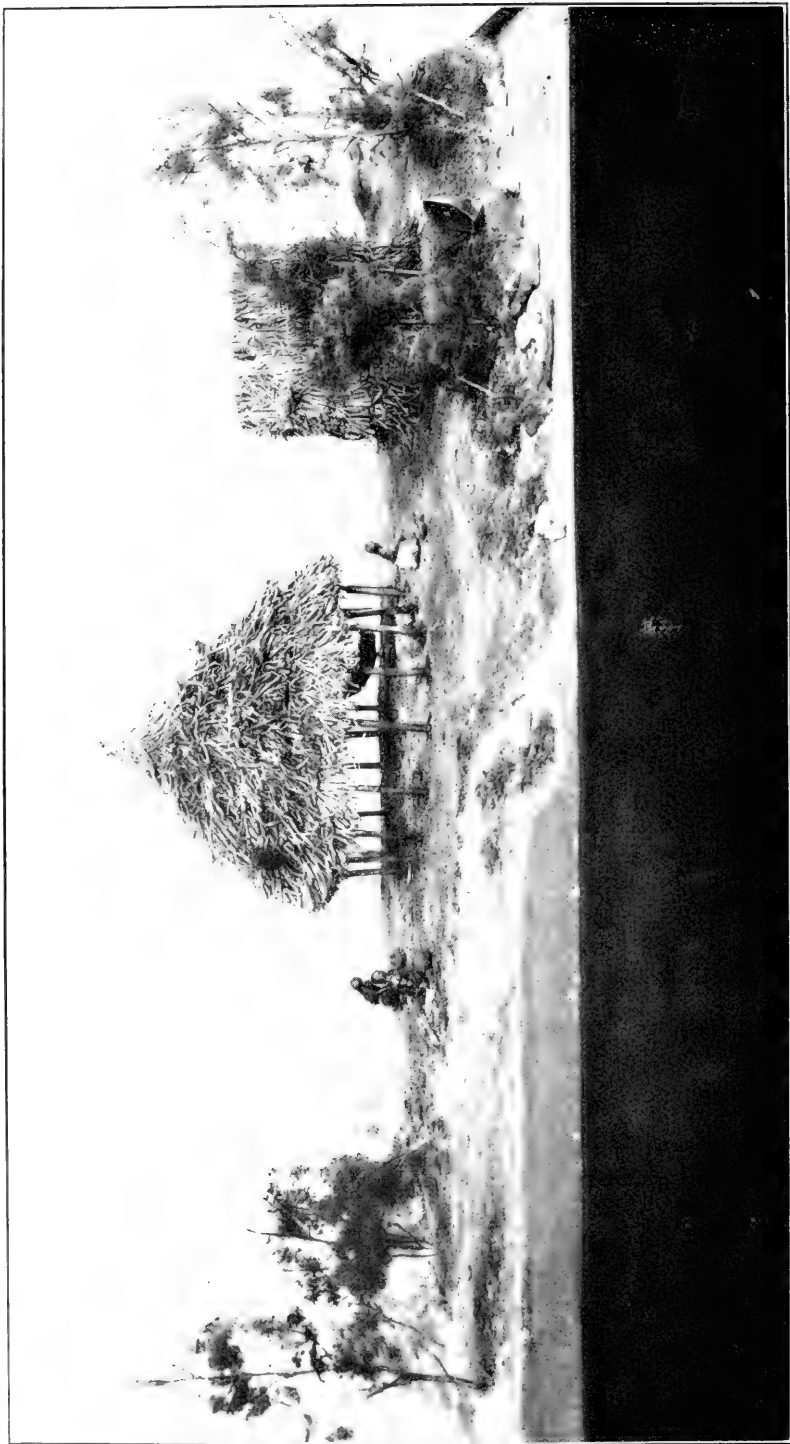

DWELLING GROUP OF THE JAMAMADI INDIANS.

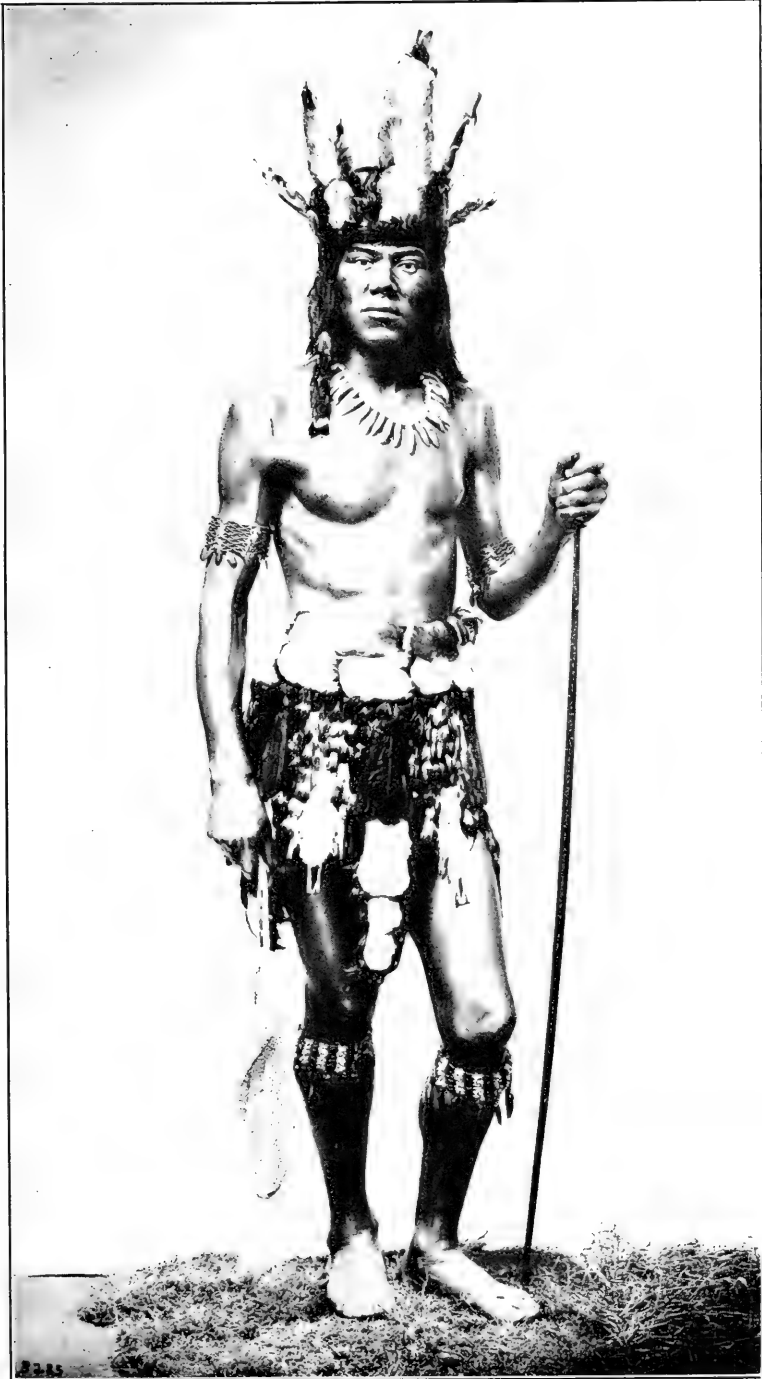

JIVARO INDIAN CHIEF.

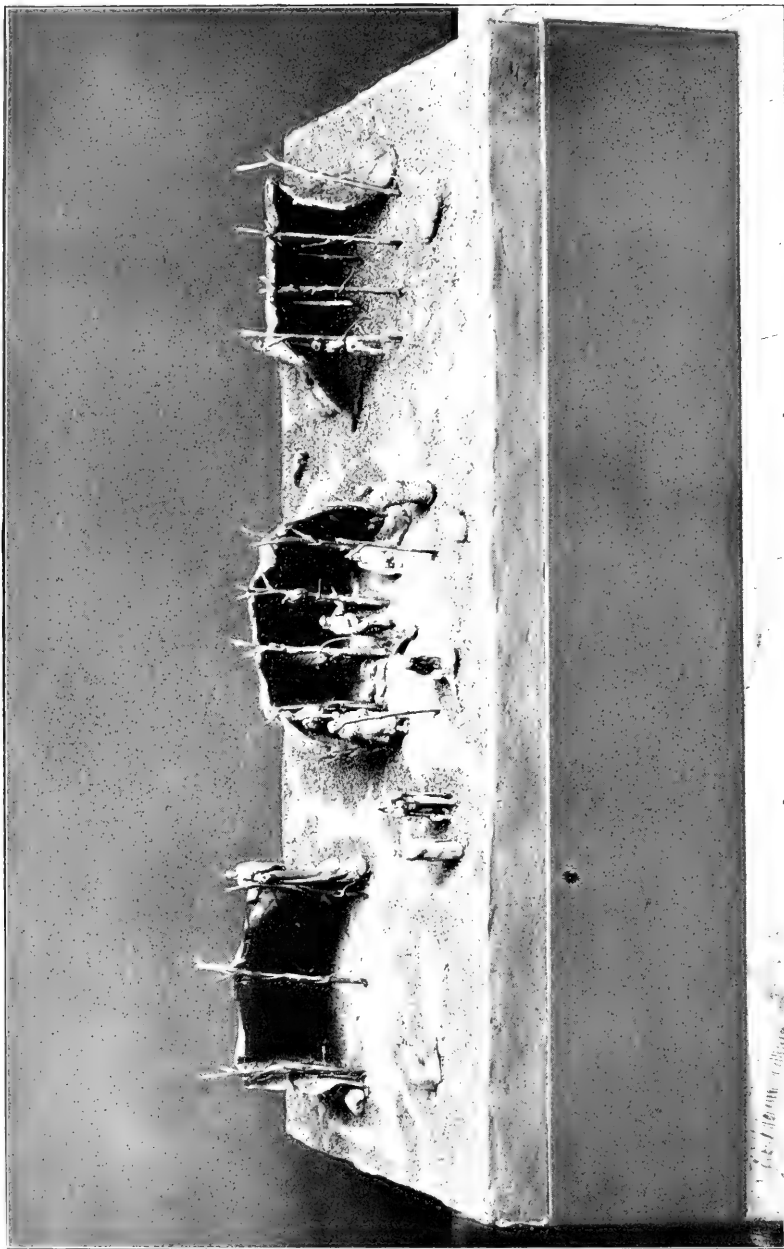

DWELLING GROUP OF THE TEHUELCHÉ INDIANS.

pare the heads of their enemies by removing the skulls and shrinking the skins with hot sand. The costume of this figure consists of a headdress and cincture made of bark cloth beaten out and covered with feathers of the toucan and blue chatterer. The necklace, armlets, and leglets are of seeds, beetle wings, monkey teeth, and teeth of the puma. (See pl. 57.)

DWELLING GROUP OF THE TEHUELCHÉ INDIANS.

The Tehuelche Indians live in Patagonia, south of the Rio Negro. Fabulous stories are told of their stature; they are, in fact, among the tallest people in the world. Their food is derived mainly from the chase. They clothe themselves in the skins of animals and their women are expert, not only in dressing hides, but also in sewing them and decorating them with patterns in various colors.

For a house the Tehuelches cover a framework of sticks with a number of skins sewed together. These shelters, generally open in front, are called toldos, and the furniture consists of only a few rude appliances.

In this exhibit are shown a tent in process of construction, a finished tent, and a temporary shelter. Men and women are engaged in the various industrial activities of the tribe—dressing hides, curing meat, and erecting the tent. (See pl. 58.)

FAMILY GROUP OF THE TEHUELCHÉ INDIANS.

The Patagonians apply to themselves the name Tzoneca, but their neighbors call them Tehuelche, or Southerners. They live on the plains and desert area of southern Patagonia, and all their arts belong to that region. Their rude tents, or toldos, are made from the hides of animals, and for this purpose the pelts of the guanaco, or small American camel, is especially valuable. These hides are also made into robes by piecing and sewing, the fleshy side being often decorated with patterns in colored earths. Robes are also made from skunk, horse, and rhea skins. Weaving is not practiced, but various fabrics are obtained from tribes to the north. On account of a similar environment, which furnishes almost exclusively animal food, the Tehuelche resembles the Plains Indians of the United States, and like them, are tall, athletic, and most courageous warriors. The group of tribes to which the Tehuelche belong is now on the verge of extinction. The horse, introduced by the Spaniards into America, took kindly to the grassy plains of Patagonia, and the Indians thereupon changed their activities to adapt them to this new domestic animal. On horseback they hunt the guanaco, the rhea, or American ostrich, and even the cougar, using the bolas with much skill.

In this group, the family is on the point of breaking camp. The man, wearing a skunk-skin robe, is ready to mount his horse, holding

in hand a bolas, the principal weapon of the tribe. One woman has already mounted, and the boy assists in completing her outfit. The second woman is rolling up the skin robes of the household, while the child halts the pet rhea. The curious bowed cradle containing the sleeping infant stands on the ground near by ready to be fastened crosswise over the bundles on the back of the horse. (See pl. 59.)

TRIBES OF AFRICA.

The Museum has as yet prepared only one group representing the varied and numerous African peoples and environments, namely, the Zulu, who are the best representatives of the widespread Bantu stock. The Bantu are not as dark and do not possess the pronounced characteristics of the Negro. The Bantu also have developed further than the Negro in social organization, though not in arts. Some idea of the extent of the area covered by the Bantu is conveyed when it is said that almost the whole of the peninsula-shaped southern part of the continent is Bantu. The exception are the Hottentot and Bushmen of the southwest tip of the continent, peoples of yellowish skin and whose relationship or origin is conjectural.

The northern half of Africa is divided among Negroes and Dwarf Negroes, Hamites, Berbers, and Semites. The geographical conditions here embrace the greatest desert in the world, the Sahara, and semidesert and semiarid territory. There is little cultivation here without irrigation. In this grand division of the continent, following in the first place the law of the stimulating of progress by environment and in the second place the introductions from other centers of culture by migration, commerce, and such happenings, we find several centers of great civilization and a number of minor centers. The southern half shows no likeness in this respect to the northern.

DWELLING GROUP OF THE ZULU.

South Africa.

The Zulu are representative of the populous and powerful Bantu family. They live in a semiarid country and subsist on maize, wild fruits, domestic animals, and game. They inhabit well-planned villages under the rule of a chief. Their villages are circular and surrounded by a fence. The houses have dome-shaped frames thatched with grass. The family occupations are carried on outside the houses. Storehouses, small houses for animals and other purposes are scattered among the dwellings. The Zulu make pottery, baskets, wooden vessels, brew beer, and work iron into weapons and agricultural implements. (See pl. 60.)



FAMILY GROUP OF THE TEHUELCHÉ INDIANS.

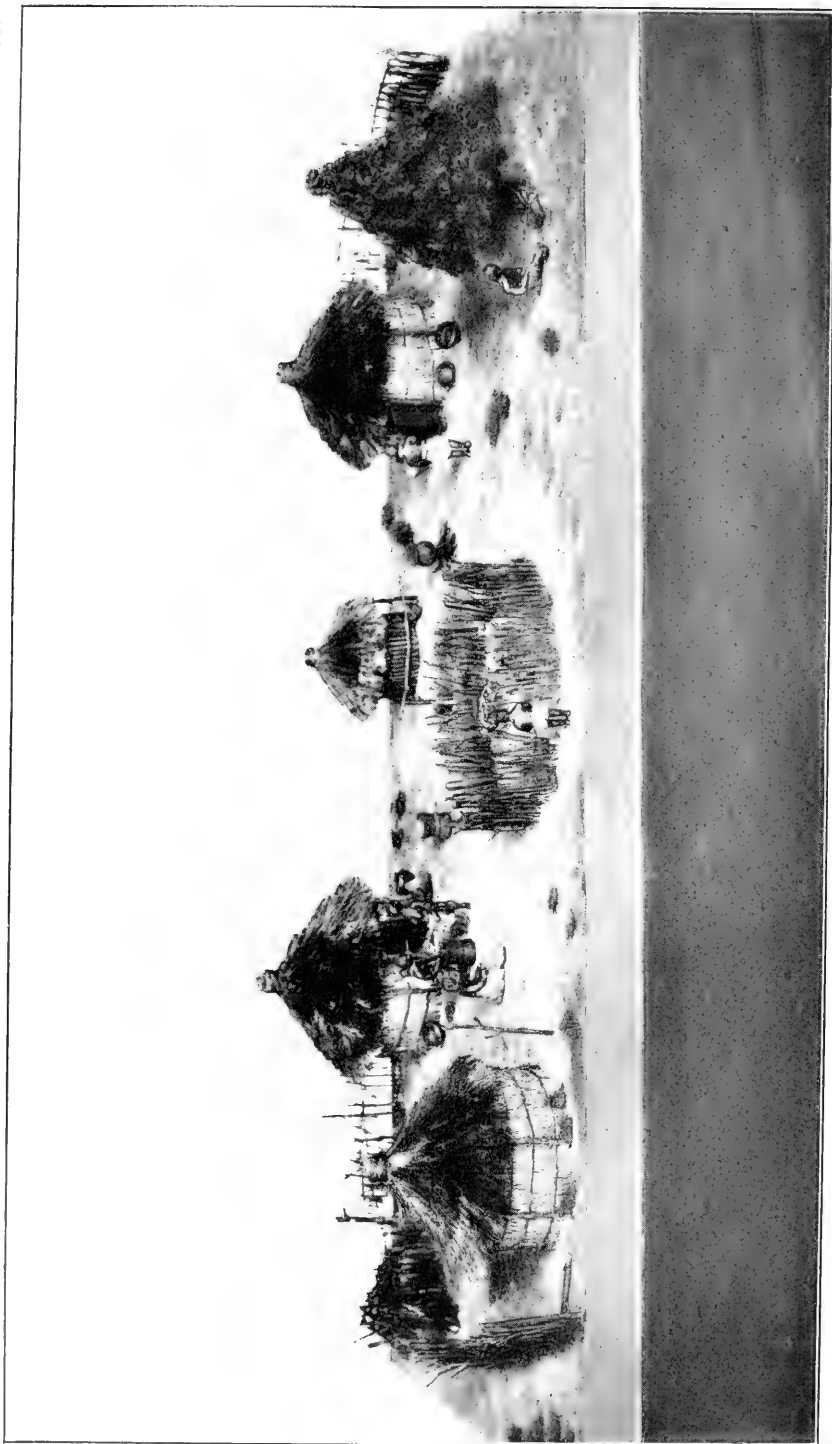

DWELLING GROUP OF THE ZULU.

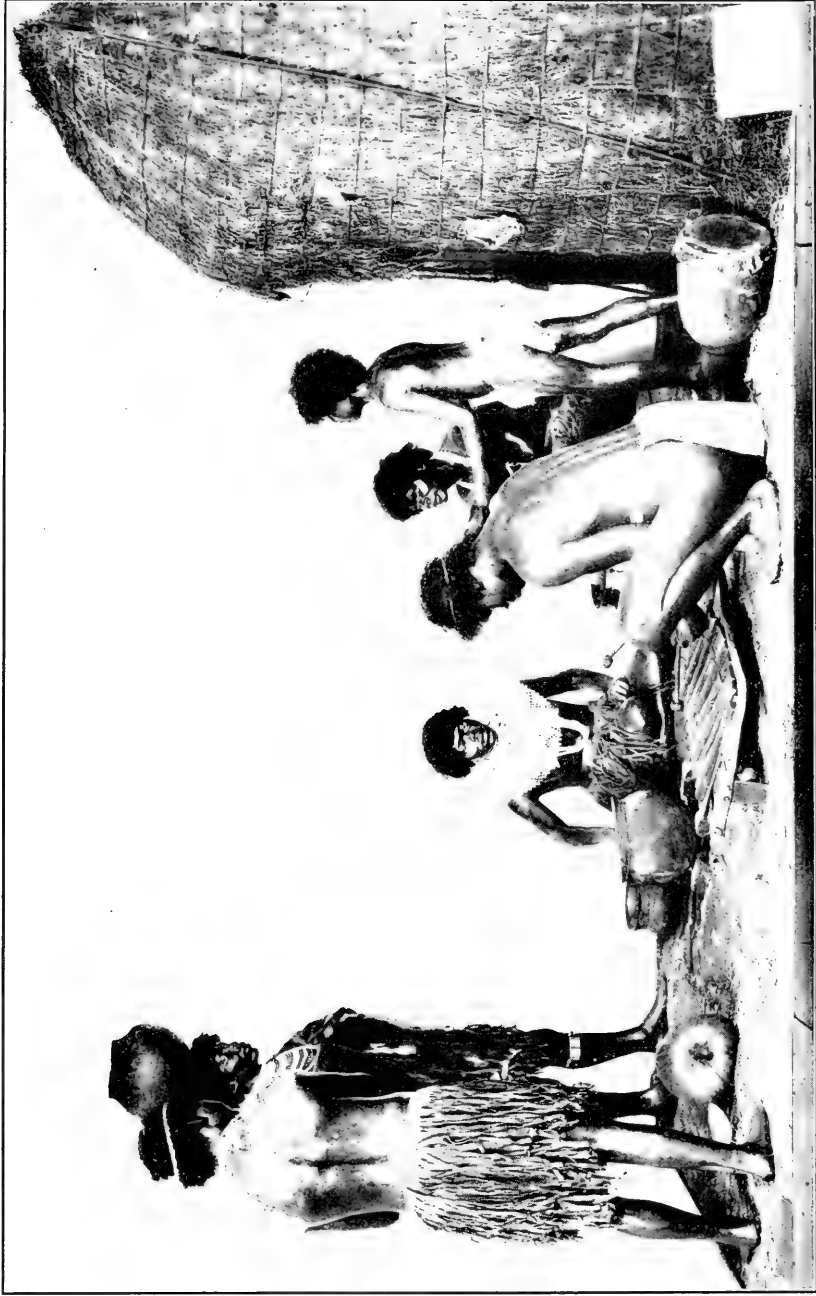

FAMILY GROUP OF THE ZULU-KAFFIR.



ZULU CHIEF.



BERBER MAN.



GHADAMES GIRL.

FAMILY GROUP OF THE ZULU-KAFFIR.

South Africa.

The Zulu-Kaffir and related Bantu tribes are physically strong and energetic and not so dark as the true negro. The Zulus are tall, dark brown, with woolly hair of elliptical section and have long skulls. In respect to military and social organization they are superior, and in arts and industries compare favorably with other Africans. They are unclothed except the apron or isenene, and their weapons are the spear, shield, and club. They depend upon maize and wild fruit principally for their vegetal food supply and on cattle, goats, chickens, and wild game for their animal food. The group shows a section of a house with doorway; a fireplace on which a woman is cooking mush; a woman dipping beer from a large pottery jar; a woman from the field with hoe; a water carrier poising her jar on her head; a man playing the marimba or xylophone; and a boy bearing ostrich eggs. The group represents these people as they existed some years ago, before they were affected by contact with white men. (See pl. 61.)

ZULU CHIEF.

The chiefs of the Zulus were selected for their mental and physical qualifications. They are therefore usually fine specimens of men among a people whose physical development has often been remarked by travelers. Among the prominent men the hair is made into a roll, cemented with gum and kept highly polished. The apron is of ox-tails, and a large fur cape called "kaross" is sometimes worn over the shoulders. (See pl. 62.)

BERBER MAN.

The Berbers belong to the Hamitic stock of the white race scattered throughout North Africa. They are tall, well proportioned, and more muscular than the Arab. They have bronzed skin, brown eyes, and black, straight hair.

This ancient stock once occupied southern Europe, the Spanish Peninsula, the Canary Islands, and the islands of the Mediterranean. They are characterized by a strong feeling of equality, benevolence, dignity, and individual freedom; and on the other hand, a want of activity, of economy, love of work, and fondness for home.

The costume, which is scarcely distinctive of the Berber, consists of a flowing outer garment of cotton, long inner garment of fine muslin, cotton trousers, yellow leather slippers, and a fez. The long gun is of native manufacture. (See pl. 63.)

GHADAMES GIRL (HAMITIC FAMILY).

Life-size figure of a girl 12 years of age, made in colored terra cotta, by Pagano, a Sicilian sculptor living in Rome. Ghadames, or Rha-

dames, is a walled town in western Tripoli, North Africa, about a mile in diameter. The principal portion of the population belong to the Berber race. These live in a part of the town specially inclosed. Outside of this place is a mixed population of Arabs and Negroes. The streets are narrow, dark, and nearly covered over with projecting upper stories of houses. The flat roofs furnish a continuous pathway. The inclosing wall protects the town from the drifting desert sands. Gardens of dates, figs, apricots, and melons are watered from wells. Ghadames is a stopping place between the coast towns and the Lybian Desert. (See pl. 64.)

SOMALI MAN.

The Somali live in East Africa, their country being known as Somaliland. They are related to the old and modern Egyptians, the Abyssinians, the Masai, and other African peoples of the eastern branch of the Hamitic stock. They are dark in color, of fine physique, and have straight noses, and ringlety, though sometimes quite straight hair. Herding is the chief occupation, and milk is their staple food. The Somali are valiant warriors, but in time of peace are noted for their hospitality. (See pl. 65.)

BAMBARA MAN.

The Bambara are Sudanese Negroes living on the Niger and belonging to a branch of the Mandingan family. Their food is rice, millet, cassava, and dates. In art the Bambaras have been advanced by their position as middlemen between the coast and the interior. Their costume consists of a long, brown, cotton shirt, to which are tied numerous charms, consisting of verses from the Koran wrapped in oiled cotton. On the forehead they wear a fetich made of antelope horn filled with medicine and wrapped with red cloth. Their weapons are bows and short reed arrows. (See pl. 66.)

WACHAGA MAN.

The Wachaga, who are Africans of Bantu stock, live on the southern slopes of Mount Kilimanjaro, East Africa. They are an interesting people, friendly, but exceedingly superstitious; much harassed by the Masai and in turn raiding the Wa Gueno and other tribes. The Wachaga possess considerable skill in ironworking, their assagais being the largest and finest in Africa. Their hide shields are large, oval, decorated with totemic symbols and they employ knot clubs and poisoned arrows. As farmers they are industrious, and they have semidomesticated the wild bee. They hunt the abundant game on the slopes of the mountain of Kilimanjaro, but do not ascend very high on the mountain. The face ruff of ostrich plumes is worn in imitation of their enemies, the Masai. (See pl. 67.)



SOMALI MAN.



BAMBARA MAN.



WACHAGA MAN.



WOLOF MAN.

WOLOF MAN.

The Wolof are Negroes of the western Sudan, living between the lower Senegal and the Gambia Rivers. They are tall, intensely black in color, but have regular features. Their language is Negro in type and is the medium of communication throughout Senegambia. In religion they are Mohammedan, but retain some of their old fetichism. They pay great attention to dress and personal adornment. Tilling and trading are their chief occupations, and they act as middlemen between the tribes of the coast and the interior. (See pl. 68.)

TRIBES OF MALAYSIA.

This complex aggregation of peninsula, islands, and sea has been the scene of extensive migration of peoples and interchange of customs. Perhaps no other section of the world has been a like swarming place of peoples. The ethnic groups show the diversity of Malay peoples and include also the aboriginal Negritos of the Philippines. Taking the last first, the Negritos have been discussed pro and con as intruders in the oceanic area or as remnants of the aborigines once inhabiting sundry islands. This difficult problem has not reached solution. Included in the groups of the Philippines is one case exhibiting the highly developed textile art of the islands.

The Dyaks of Borneo have been taken as typical of the Malay and the Igorot as a divergent branch. The Dyaks are evidently a much-mixed race, and pure types are therefore difficult to obtain. No important culture centers are to be observed in this area, but in Java, Sumatra, and some other areas interesting development has been in progress, influenced in all probability from India.

The Malaysian tribes are in all stages of moderate culture. Some of them subsist on jungle products and others cultivate principally rice. The arts of Malaysia are profoundly influenced by the bamboo and rattan, ranking among the highly useful plants of the world.

DWELLING GROUP OF THE DYAKS.

The Dyaks are of Malayan stock chiefly and live mainly in the heavily forested interior of Borneo, subsisting on rice, sago, native fruits, and game. They are expert in the use of the blowgun, in which they employ poison-tipped darts. In many respects the culture of the Dyaks is similar to that of the forest tribes of South America. Dyak houses are communal—long structures erected on high posts with a wide bamboo-floored porch where the household activities are carried on. These houses are built along the rivers. Rice storehouses and other smaller sheds are also built. The Dyaks are good boatmen and make large dugout canoes. (See pl. 69.)

FAMILY GROUP OF THE DYAKS.

The Dyaks are expert house and boat builders. Rice, sago, tropical fruits, monkeys, wild pigs, and other game yield them subsistence. The Dyaks are warlike and are still to some extent head-hunters. Their weapons are spears, short swords, blowguns with poison-tipped darts, and rarely bows and arrows.

The group here shown represents a Dyak family on the porch of the communal house carrying on their various occupations. Two women pound rice in wooden mortars; another woman carries rice in a back basket by means of a head strap; a man armed with a blowgun brings in from the forest a red monkey which he has killed; and two children play a game of cat's cradle, which is a familiar form of amusement in this part of the world. (See pls. 70 and 71.)

DYAK MAN.

The skin of the Dyaks is light brown; the hair jet black, straight, or wavy; the nose short, wide, and flat. Their height is about 5 feet 3 inches. While skillful in ironworking and other arts, they are stationary in development.

The costume consists of a chawat worn about the loins, and a turban made by wrapping a scarf of cloth or bark around the head. Several large rings adorn the ears. The Malay weapons borne by this figure are the spear; the shield, with tufts of human hair; and the curious serpentine dagger called kris. (See pl. 72.)

FAMILY GROUP OF THE BONTOC IGOROT.

Philippine Islands.

The Igorot are of Malayan stock and live in the higher central portion of Luzon, principally in the Province of Bontoc. They cultivate rice in terraces on the hills, and also plant maize, bananas, sweet potatoes, and other crops; weave cloth; make pottery; and mine and smelt ore. Their houses are lightly constructed, and are gathered together into villages, ruled over by clan councils. The population of each group is, as a rule, at enmity with all others, and because the Igorot are the least modified of the Philippine tribes they were until recently addicted to the practice of head-hunting, which they held in common with many Malayan groups of the East Indies.

At the time of the War with Spain, Igorot levies, equipped with armor, spears, bolos, and knives, were pushed forward by the Spanish to engage American troops, and it is said that they displayed much courage during the slaughter that followed.

The Igorot is of a cheerful disposition, strong, a good worker, and inclined to peaceful pursuits. He is of a medium stature, has

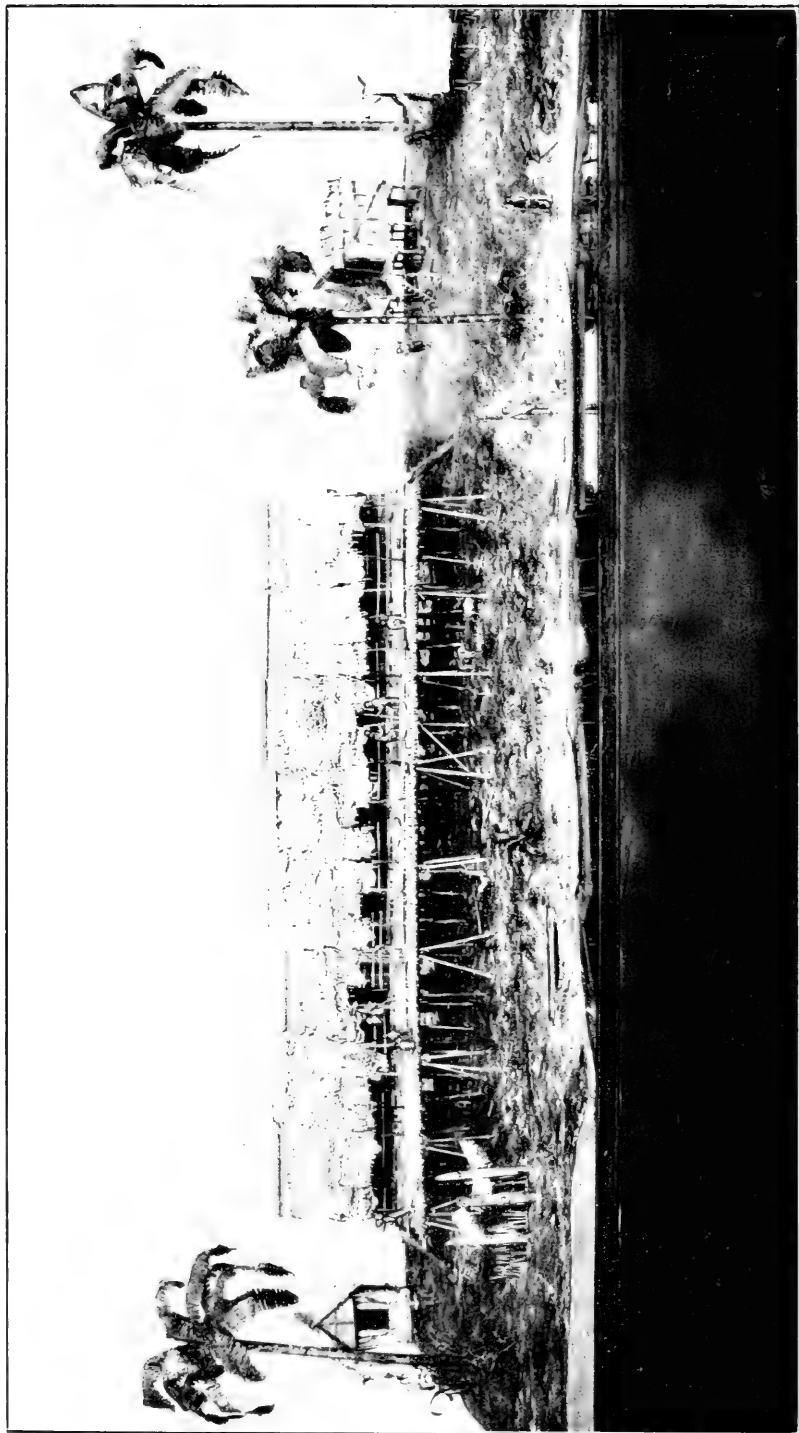

DWELLING GROUP OF THE DYAKS.

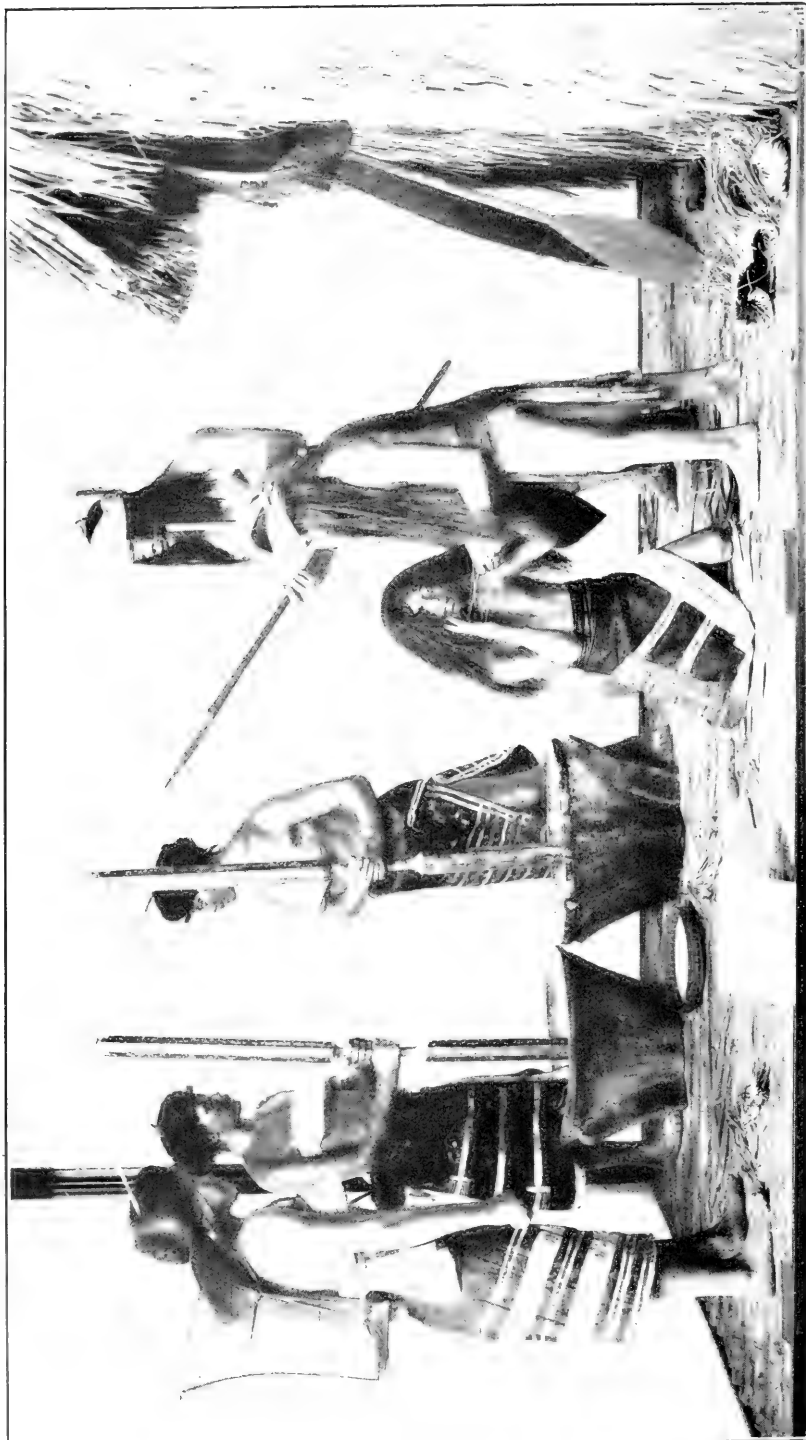

FAMILY GROUP OF THE DYAKS.



CLOSER VIEW OF SECTION OF DYAK GROUP.

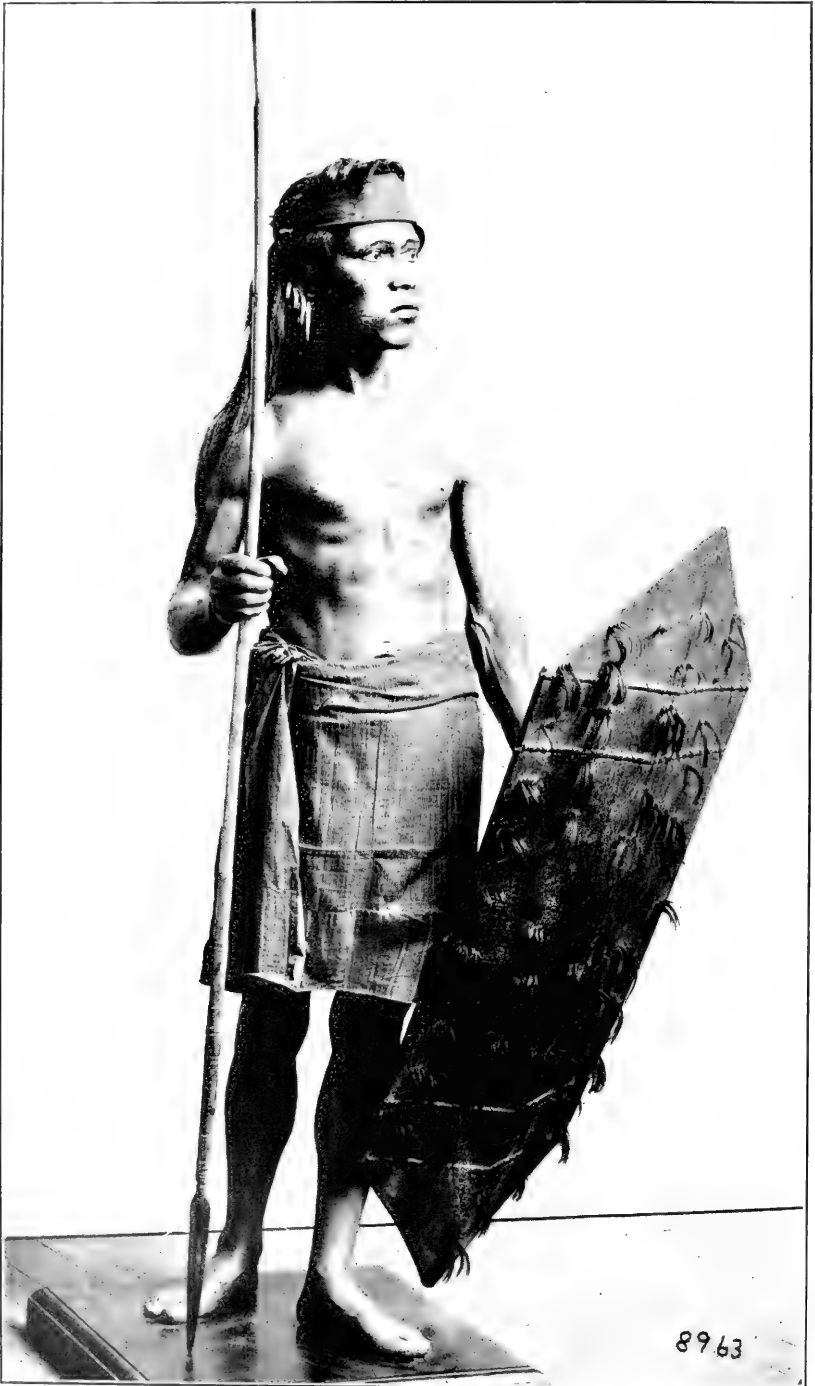

DYAK MAN.

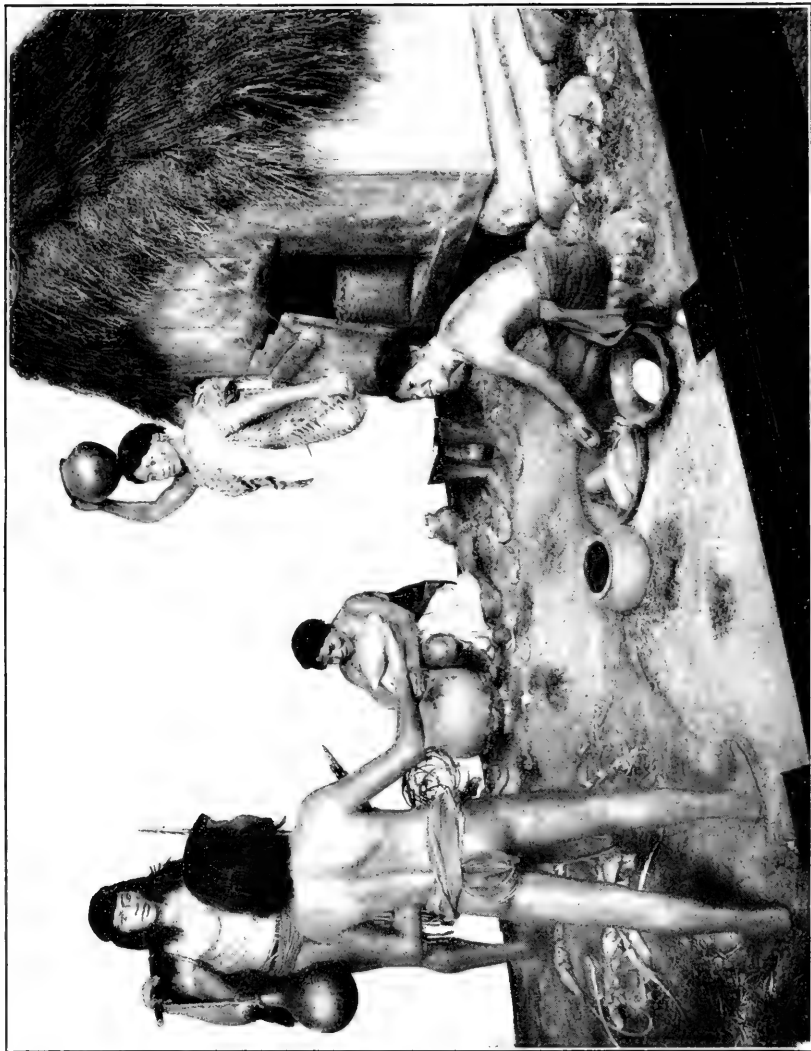

FAMILY GROUP OF THE BONTOC IGOROT.



FAMILY GROUP OF THE FILIPINOS.

fine muscular development, black eyes and hair, smooth skin, and differs little from the Dyak of Borneo, to whom he is related. Occasionally there is seen among the Igorot traces of an admixture with the Negrito, whom they supplanted, and on the borders of their habitat they merge into other uncivilized tribes.

The section of a house at the back of the case is a granary for rice and underneath it are stored billets of firewood. The older woman is engaged in making pottery in the primitive fashion and is surrounded with the material and tools of her art. The younger woman, carrying a child on her back, has just returned from the spring with a jar of water on her head and a basket at her waist. The man carries supplies with the balance pole. He also has a spear and a head-hunter's basket. The girl is peeling camotes or sweet potatoes and greets with a smile of approval the boy who is starting out to snare a wild jungle fowl. (See pl. 73.)

FAMILY GROUP OF THE FILIPINOS.

Luzon, Philippine Islands.

The Filipinos are of Malayo-Polynesian race whose blood has become somewhat composite through contact with foreigners. They represent the class of islanders who have been longest under civilizing influences from without, and especially under the Spanish régime. Their arts and industries, in consequence, have been modified greatly, though preserving the basis derived from racial inheritance. The Filipinos are skillful workers in wood, metal, and textiles and have also made considerable advancement in the fine arts. They are widely known through the products of the loom and needle, which are delicate fabrics enriched by color, embroidery, and drawnwork.

This group represents especially the several processes connected with the making of cloth which are carried on in many Filipino households. The man brings in, by means of the carrying pole and baskets, raw material of cotton and fiber, together with tempting fruit, for which the girl winding bobbins reaches out her hand. Near by, crouched on the mats, is a woman ginning cotton in a simple machine, and back of her is a spinner employing a primitive wheel. The weaver in the corner is absorbed in her work, which requires patience and concentration. The furniture is of the simple character found in Filipino habitations. (See pl. 74.)

FAMILY GROUP OF THE NEGRITOS.

The Negritos are small, black, woolly-haired natives inhabiting out-of-the-way places in several islands of the Philippines, but mostly living in the great island of Luzon. They call themselves Aeta, and,

because they are very shy, make their home in the mountain forests. Their houses are rude shelters scattered through the country and never gathered into villages like those of the Igorot. Little was known in America concerning them until the acquisition of the Philippines by the United States.

They cultivate a little, but depend for food principally on the fruits of the chase and forest products, a few of which they exchange with the lowland people for cloth, rice, or iron sufficient for their small needs. They are keen hunters of wild animals, and their traps are quite ingenious.

Their only weapons are bows and arrows, and in the use and manufacture of them they are very skillful. Among them is found a primitive method of fire making by sawing a knife of bamboo across another piece, as shown in the kneeling figures, the fire rising in the ground-off dust which falls beneath when the lower bamboo is cut through by the friction.

The Negritos are cheerful, intelligent, peaceable, and moral; they love music, and one of their chief amusements is dancing; they are born pantomimists, and, like children, dramatize the events they wish to relate. While physically the Negrito seems inferior, in reality he is strong, marvelously agile, and his black, wizened, dwarfish frame is capable of incredible endurance. Though nothing definite is known of his origin, the Negrito is thought to be a remnant of a once widespread population related to the Papuans, the Andamanese, and other black, woolly-haired peoples of Oceanica.

The group represents a Negrito family before their rude shelter habitation in the mountains, the women occupied in nursing the baby and in pounding rice, while the men are making a fire with the bamboo saw to cook a jungle fowl, which one of them has brought in. (See pl. 75.)

TRIBES OF POLYNESIA.

The settlement of the multitude of islands which make up Polynesia is the result of the most extensive migration known. This migration is estimated to have begun from some focus in the East Indies about 1,500 years ago. These emigrants did not know any metal, and had no domestic animals except possibly the pig. They had developed the art of boat building for deep-sea navigation and had perfected the drying and packing in small compass of nourishing vegetal food for long voyages. All this implies a considerable advance in the arts and a long preliminary course of preparation. The Polynesians have carried their arts all over the Pacific, and as a practical uniformity is observed throughout the area, the whole migration may reasonably be considered to have taken place within a comparatively short period.



FAMILY GROUP OF THE NEGritos.

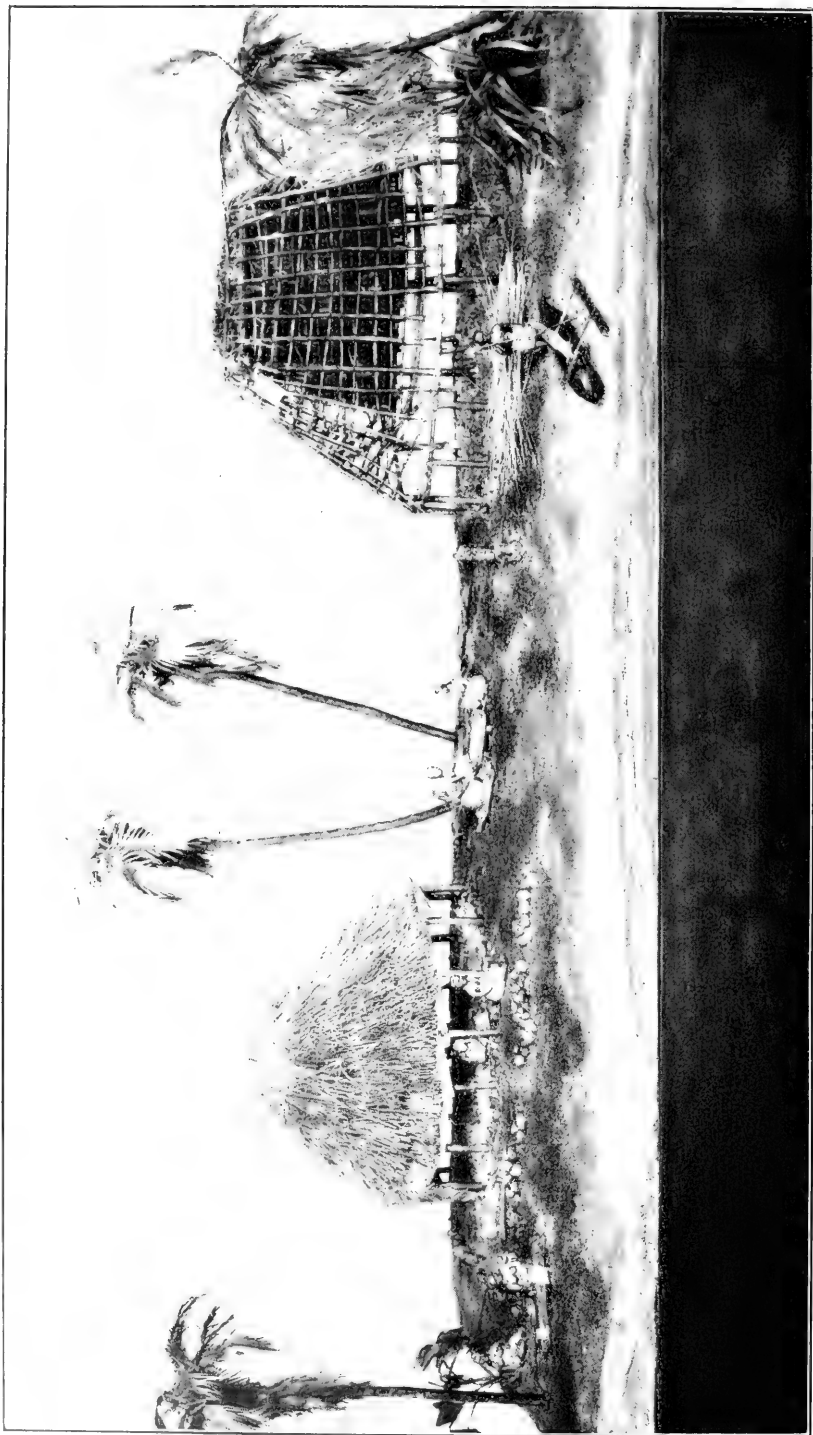

DWELLING GROUP OF THE SAMOANS.

The Polynesian language, it has been affirmed by William Churchill, is of primitive type as though in the process of formation. The subsistence of the Polynesians was also primitive in character, derived from the sea and from tree and uncultivated plant products. They were thus in the preagricultural stage. From whatever focus the Polynesians departed, in this original place there existed no rice or other grain, no domestic animals, no metal, and no weapons except clubs and spears. We infer also that there the houses were not erected on posts and that weaving was unknown. The Polynesians are not only one of the most interesting races, but they present some of the most difficult problems.

DWELLING GROUP OF THE SAMOANS.

Samoan Islands, South Pacific.

The Samoan houses are elaborately constructed frameworks tied together with coir cord set on platforms of bowlders. They are thatched with palm leaf and are provided with palm leaf screens and partitions. The Samoans have no woven textiles but make a light strong fabric from beaten bark which answers for clothing and bedding. They also make fine mats, canoes, bowls, pillows, etc., which are carved from the hard, red-brown Samoan chestnut wood. (See pl. 76.)

FAMILY GROUP OF THE SAMOAN ISLANDERS.

The Samoans are of the brown Polynesian race which at some early period spread over the Pacific to numerous widely separated islands and reached to within 1,800 miles of the South American continent. The Samoan Islands were visited by the Dutch navigator Roggoveen in 1722, and named by Bougainville in 1768. Like the Hawaiians, the Samoans live in villages which are scattered along the coasts of their tropical islands. They were formerly ruled by hereditary chiefs, but as the islands now belong to the United States and to Australia their governments are accordingly administered by these countries.

Breadfruit, bananas, taro, potatoes, and coconuts furnish the principal food supply, and fish are eaten. The only domesticated animal is the pig. The Samoans are robust and active, their warlike exercises with club and spear, and their constant practice with the canoe paddle developing a fine physique. They are cleanly, and delight in flowers and perfumes. The men excel in woodworking, in building elaborate houses, in making large canoes, and in carving out bowls, dishes, clubs, and spears from native woods. The women weave mats of the finest texture, and beat out bark cloth of strong fiber with corrugated clubs, decorating the fabric with native designs in color.

The central figure of the group is a maiden preparing kava, a ceremonial drink, by straining out from the liquid the pulp of the

pounded root. The young woman standing on the right welcomes the man, offering a fine wedding mat bordered with parrot feathers for his inspection, and the child arrives with arms loaded with more mats, showing the wealth of the household. The women seated in the foreground are engaged in the manufacture and ornamentation of tapa which serves for textile in the Samoan and other Pacific islands. It is made from strips of the soaked bark of the paper mulberry, beaten with a grooved mallet on an elastic log. During this process it stretches to many times its former width, and by joining other pieces, sheets of any desired extent can be made. In its decoration, several methods are used: That of printing from pattern boards with raised ornamentation; striping with brushes; and by free-hand painting. The young woman seated at the right has printed a piece of cloth and is about to draw the border designs with a pandanus brush. (See p. 77.)

VILLAGE GROUP OF THE EARLY HAWAIIANS.

Formerly the Hawaiians lived in grass thatch houses of several kinds grouped into villages, which were the home of a clan ruled over by a chief and a priest. The houses shown in the model, which is a restoration of Hawaiian social life before contact with Europeans, are, beginning from the left, the *mua*, eating house for the young men; the *lanai*, or bower, often attached to the house; the *alii*, or chief's house; the *noa*, or house of the chief's wife; the *aina*, where women eat, and the *pea*, or tabu house of the women. On the front row is the *heiau*, or temple, with image and skulls on posts; the *kua*, or workshop, with *lanai*, or shed, and on the extreme right, a *pupupu*, or fisherman's temporary shed, back of which a laborer is cultivating taro in artificially irrigated ponds. On the shore are natives bathing, a canoe being unloaded, and a fisherman hauling his net in a fish pond. In the open space in front of the village is an oven from which a roast pig is being taken; two men hauling a log; a man making wooden *umekes*, or bowls; two women pounding taro root to make *poi*; a woman beating bark to make *tapa* cloth; a woman painting *tapa* cloth; a group of women feasting, and a woman bearing *leis*, or wreaths of flowers; a nurse with children; the chief's wife and son; the chief standing on a platform in front of his house, and the chief's *poi*, or food-bearer, with calabashes. "Such," as Malo finishes his quaint chronicle, "were the possessions of the old-time people who lived on the ancient Hawaii. Great pity for them." (Legend on frame of model.) (See pl. 78.)

MAORI MAN.

The Maori's are of the Polynesian family and inhabit the island of New Zealand. Keane places them in the Caucasian race, but Brinton makes the Polynesians a separate group of the Malay stock.



FAMILY GROUP OF THE SAMOANS.

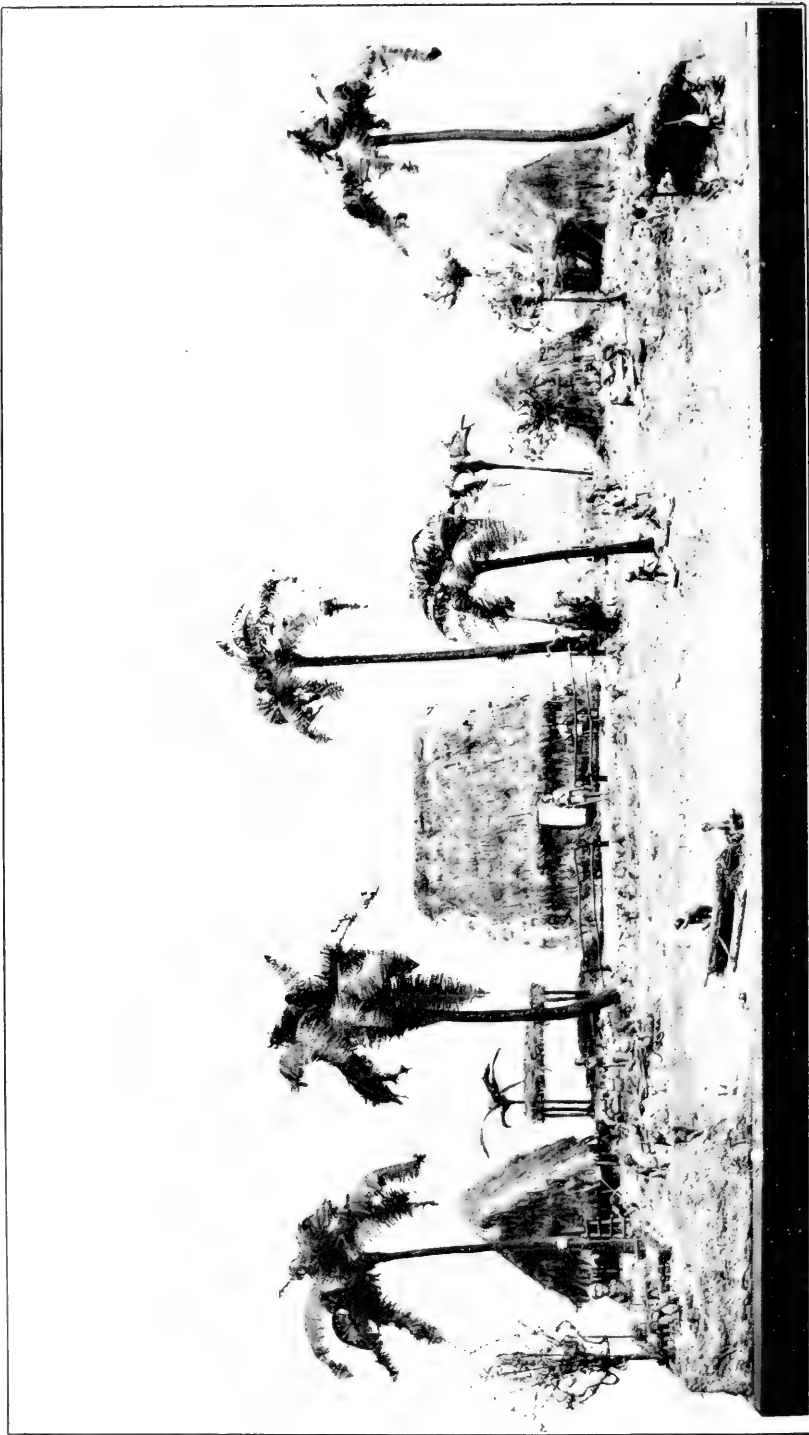

DWELLING GROUP OF THE HAWAIIANS.



MAORI MAN.

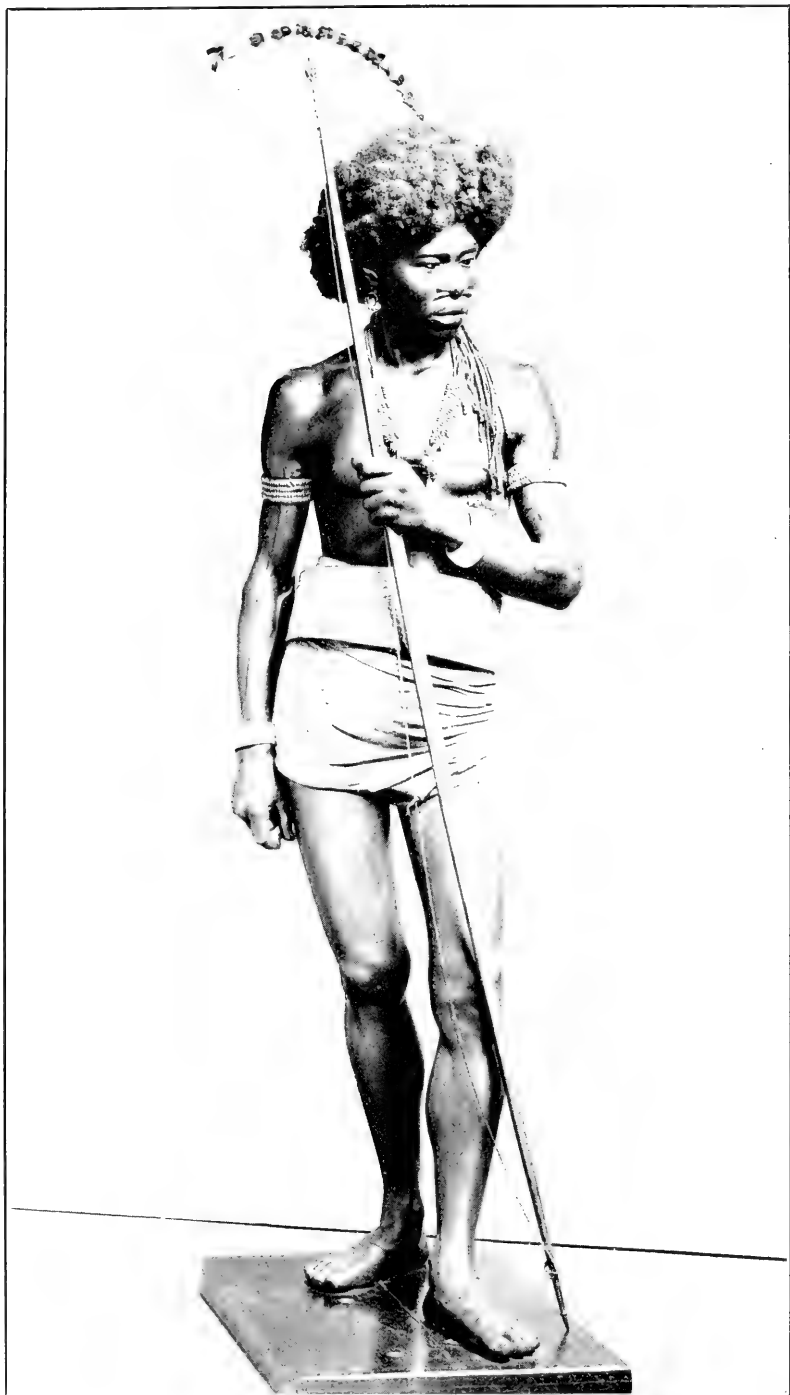

PAPUAN MAN.

They are tall, very well formed, and have straight, black hair and good features. They are among the most perfect specimens of mankind. The Maori are at present upon the verge of extinction.

Their clothing consisted of robes of New Zealand flax (*Phormium tenax*) thrown over the shoulders or folded around the hips. The face was tattooed in scrolls, deeply incised. The weapons were clubs and spears, the shield not being used. (See pl. 79.)

TRIBES OF PAPUA, AUSTRALIA, AND OTHER PRIMITIVE TYPES.

In southeastern Asia, in Malaysia, the Andaman and Nicobar Islands, Melanesia, Micronesia, and Australia, there exist blacks, in some localities miserable groups on the point of extinction and in others, numerous, dominant, and aggressive. These blacks in the main possess negroid characteristics, but whether they have a common origin or are dissimilar remnants of diverse origin is a moot question. Among them are found the lowest specimens of mankind, lacking in arts and near to nature; others are fine examples of physical development and advanced in the arts, the difference probably due to several causes such as environment, repressive contacts with other races, degradation, and continuance in a primitive state. Many theories have been advanced as to their origin, but no answers to this interesting problem are satisfactory.

PAPUAN MAN.

The Papuans form a separate group of the Indo-Oceanic negroes and number about 2,000,000. They inhabit New Guinea, the Fiji, and other islands in the area called Papua. They are (in the most pronounced type) black, tall, and well formed, having bushy hair, thick lips, and a salient nose, thick at the base. The Papuans have made considerable advancement in the arts, but their present state of development appears to be retrograde.

Clothing among the Papuans is purely for personal adornment. This figure displays a featherhead plume, earrings, and nose pin, a necklace of shell disks with a boar's tusk pendant, armlets of shell, wristlets worked from a large shell, and a broad waist belt of bark, carved on the exterior. The long palm-wood bow has a hempen string. (See pl. 80.)

AUSTRALIAN MAN.

Clarence River, Australia.

The Australians, according to Huxley, form a separate race and by all ethnologists are classed among the lowest races of mankind, both physically and from the limited progress they have made in the arts. They are black, tall, sparely built, with bushy, but not woolly,

hair, having an oval section. The skull is long, the nose very flat and deeply inserted under the brow, and the lips thick.

The figure is represented carrying the boomerang and wearing an apron of kangaroo skin. (See pl. 81.)

VEDDAH MAN AND WOMAN.

Ceylon, India.

The Veddahs are the true aborigines of Ceylon, and one of the primitive types of the human race. They live on the thickly wooded flatlands and in hills and on the east coast of Ceylon, being known as the Coast, Village, and Rock Veddahs. They are expert bowmen. They subsist on whatever the jungle affords and live either among the rocks or in A-shaped thatched huts. The women prepare the food and work at a few domestic arts. (See pl. 82.)

TRIBES OF ASIA.

The Continent of Asia is complex geographically, furnishing every type of environment as to elevation and temperature. It is also very complex as to its population, possessing practically all varieties of mankind. The shape and position of the continent puts it in touch with all the earth, and from it probably all the tribes of men issued. As an example, there is no doubt that the Western Hemisphere was populated from Asia.

In northern Asia we find tribes living in an Arctic or sub-Arctic environment in western and eastern Siberia and in the extreme northeast, where Chukchi, Koriaks, and Eskimo live and the reindeer is the chief dependence.

Asia is known more generally as the home of the Mongols, who occupy mainly the central and eastern portion and the East Indies. The Mongolian race is so diversified beyond that of the other races in physical character and appearance that the term "yellow race" is hardly applicable. The term "Mongoloid" is used to designate divisions or subraces which differ from the preconceived Mongol type. The pure type is believed to be found in the Kalmucks of Russia. Indo-China also has interesting groups of aboriginal tribes of primitive culture. The cultivated peoples here are the Siamese, Burmese, and Annamese.

India with its immense population and numerous tribes forms another Asiatic geographical group of extreme interest. The chief divisions are the dark-skinned Dravidians and the Indo-Aryans. The white race has important representatives in Asia, notably in India, Persia, Syria, Arabia, and Asia Minor. In Asia the white type has suffered its greatest changes.

Western Asia, in which great culture centers have arisen and passed away, is peopled by Iranians, Persians, Afghans, Kurds, Ar-



AUSTRALIAN MAN.



VEDDAH MAN AND WOMAN.



MONGOL MAN.



TIBETAN MAN.

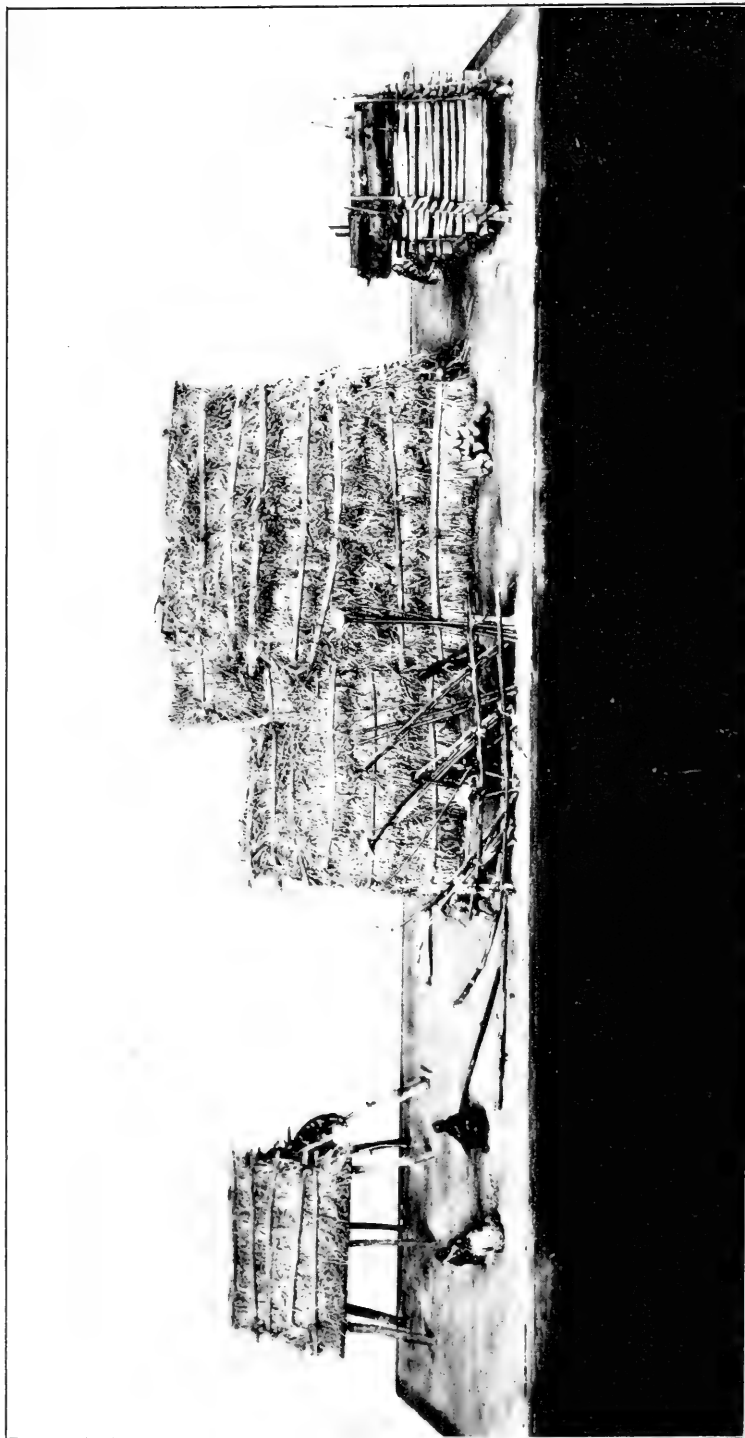

DWELLING GROUP OF THE AINO.

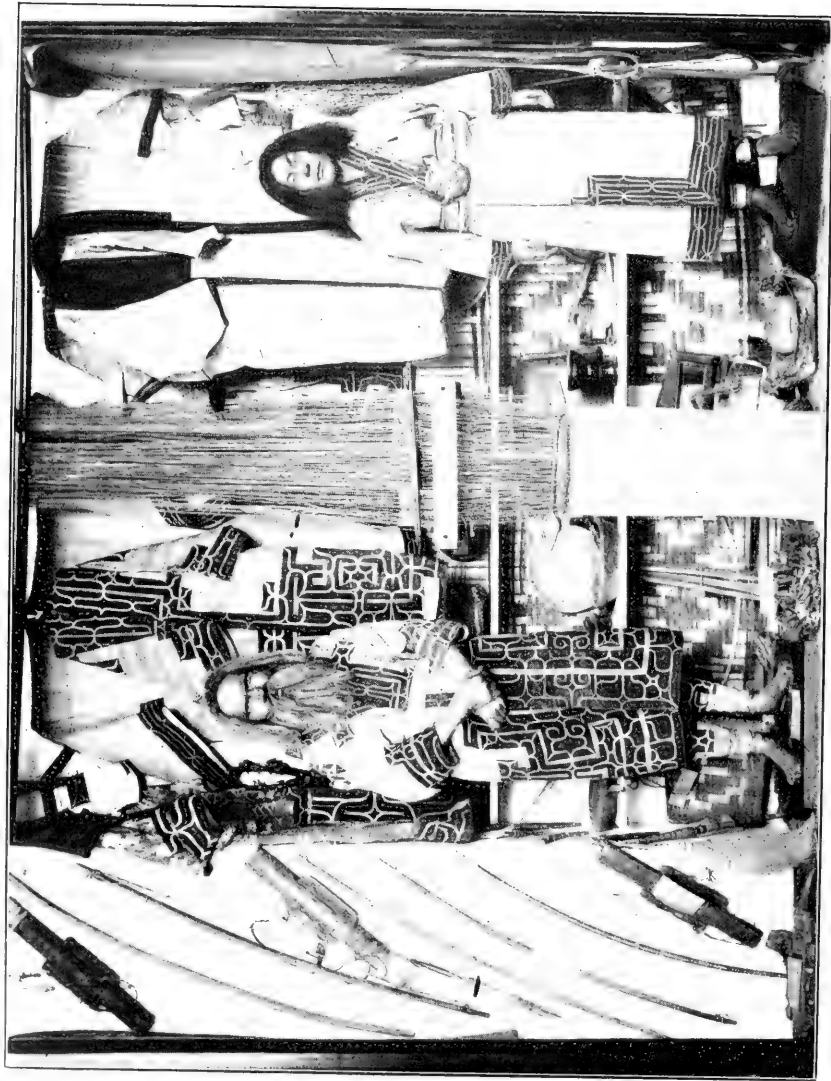

AINO MAN AND WOMAN.



ARAB MAN.

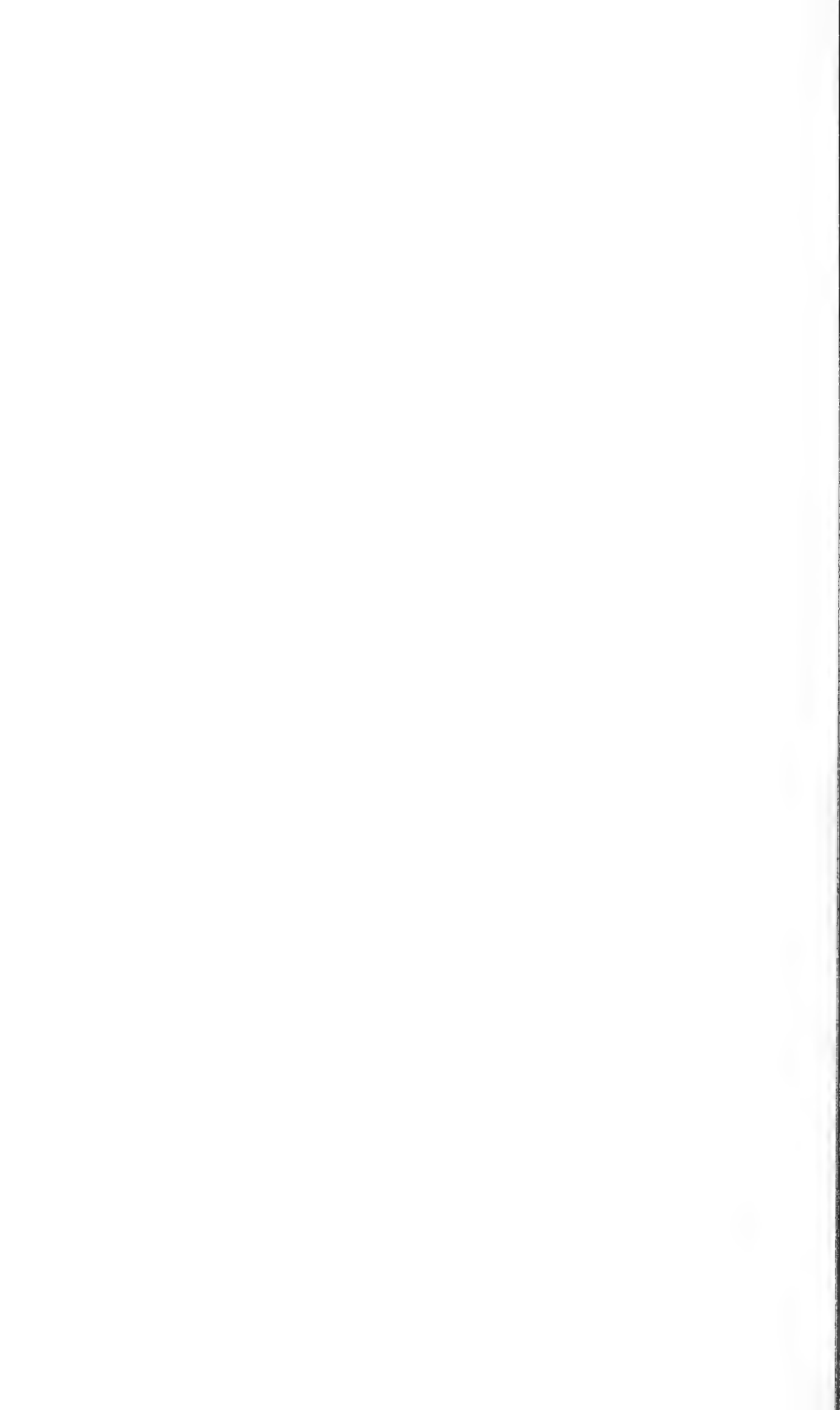

menians, Arabs, mixed Semites, and Jews. This section of Asia is mountainous and semiarid. The people are cultivated in the arts, but not in the mechanic arts. This remark is true for all Asia. The study of the Continent of Asia is one of the most pressing needs confronting all scientific lines of research.

MONGOL MAN.

Mongolia.

The Mongols occupy central Asia, mainly in the eastern half of the Desert of Gobi, and form the Atlantic division of Friedrich Muller's Mongoloid Asiatics. They are pale yellowish in color, rather short in stature, with coarse straight hair of round section. They subsist upon their herds of sheep and camels, of which they have numbers. (See pl. 83.)

TIBETAN MAN.

Tibet.

The Tibetans belong primarily to the Tibeto-Burmese subdivision of the yellow race. They live in the great central high plateau of Asia. Their country is sterile, mountainous, without roads; the climate very severe. They are of medium stature, of yellowish color, and have coarse black hair, somewhat wavy. The obliquity of the eye is much less marked than in the typical yellow race.

The costume consists of heavy boots, trousers of felt, a shirt of raw silk, and a very large wide-sleeved gown of red woolen cloth, lined with sheepskin. Hats are rarely worn. (See pl. 84.)

DWELLING GROUP OF THE AINO.

Island of Yezo, Japan.

The Aino are aboriginal inhabitants of Yezo, the remnants of an extensive habitation of the islands. They are noted for their hairiness. Their houses are thatched frameworks, one portion of the structure corresponding to doorway or antechamber of northern houses. Storehouses are set on posts like the Eskimo storehouses. Connected with their customs and beliefs are the bear cage and the sacred hedge on which are placed the skulls of bears sacrificed. The Aino weave cloth of elm bark, carve wood, and make mats, the ornamentation of which is characteristic. The group shows a mat weaver, two old men whittling prayer-sticks and a group sacrificing a bear. (See pl. 85.)

AINO MAN AND WOMAN.

The Aino are an especially interesting tribe of undetermined relationship, but are thought to show traces of Aryan blood. They

are of short stature, very strong and active. The women tattoo a mustache-like figure around the mouth. Their art is that of peoples of western Asia, a type of which would be that of the Amur tribes. They subsist by hunting and fishing. (See pl. 86.)

KOREAN MAN.

The Koreans belong to the northern Mongols, but have been mixed from ancient times with the Chinese, Japanese, and Manchurians. The Empire formerly had reached a considerable degree of civilization, which has declined since the Ming dynasty in China. They are agriculturists and weavers. The costume is of nettle cloth and is the customary dress worn by Korean gentlemen.

ARAB MAN.

Arabia.

The Arabs are Semites closely allied with the ancient Arameans and Assyrians inhabiting the desert country of Arabia and widely spread in Africa. The Arabian type is one of the finest in the world, and as a nation the Arabs are highly gifted intellectually. They are of medium height, with oval head and face, refined features, black hair, and fair skin, soon bronzed by the sun. The Arab is wiry and nervous, and gifted with great energy and endurance. The figure here shown is dressed in a robe of white woolen cloth and wears a large turban. (See pl. 87.)

NOTES ON THE DANCES, MUSIC, AND SONGS OF THE ANCIENT AND MODERN MEXICANS.¹

By AUGUSTE GENIN.

[With 10 plates.]

INTRODUCTION.

All authors who have written on ancient Mexico are agreed in telling us that music, song, and dance were in vogue among the earliest inhabitants of that which was later New Spain, and that not only did they have a kind of conservatory to perpetuate traditions, but also families of a certain standing engaged singing and dancing masters to educate their children.

Among the modern Mexicans the situation is the same. There is a conservatory at Mexico City; the European masters are known and appreciated by the public; people dance a little everywhere as they dance in Paris, London, and New York; and the cakewalk, the maxixe, the (chaloupee) waltz, and other rhythmical contortions are practiced in the Mexican salons, with the same enthusiasm as in other countries, which proves that there are but few eccentricities which fashion does not cause to spread. But in these notes I do not wish to take up the modern dances, songs, or music, which, as stated in the preceding sentence, are the same everywhere; but only that which presents an ethnic character, traditional or peculiar to Mexico.

Before reviewing the present situation among the Mexicans, it is not without interest to cast a glance into the past. As is well known, ancient Mexico was inhabited by several races, although certain ones among them, as the Toltecs, the Aztecs, and the Mayas are especially well known. If we look at the catalogue of Mexican languages, so carefully prepared by Orozco y Berra, we shall see that at the epoch of the conquest, more than 60 dialects, belonging to as many tribes, divided the country which extended from the Mississippi to the Isthmus of Panama. All these tribes did not belong to different races; many had a common head, and they can be divided into a dozen large

¹ Translated by permission from the *Revue d'Ethnographie et de sociologie*, 1913. Ernest Leroux, editeur, Paris.

groups: the various Nahoas tribes, which occupied the central plateau of Mexico; the Otomis who lived and still live in the mountains surrounding the valley of Mexico; the Tarascs of Michoacan; the Tzapotecs, the Mixtecs, and the Mijes, inhabiting more particularly the present States of Oaxaca and of Vera Cruz; the Lacandons, who still live in the almost impenetrable forest of Chiapas; the Mayas, whose domain is Yucatan; the Hauxtecs, dwelling on the shores of the Gulf of Mexico, including a part of the States of Vera Cruz, Tamaulipas, and San Luis Potosi; the Redskins of Chihuahua and of Sonora, probably descendants of the ancient Chichimecs; and finally Huicholes and the Tapahumares, who inhabit the Sierras parallel to the Pacific Ocean, in the former Territory of Tepic, to-day the State of Nayarit.

The purpose of that which precedes is to show that it is not necessary to believe that the usages and customs of one or another of these ethnic clans or tribes had a general character.

For example, the Mayas, eminently civilized, devoted themselves to religious practices, full of ritual and reverential fear, which were unknown to the Redskins and the Indians of the Pacific Sierras, who were developing from the pre-Cortezian civilization, for they shut themselves off almost entirely from modern influence.

The Aztecs who dominated over the Anahuac—that is, the valley of Mexico, and who fought their way to the borders of the present Mexico—had different customs from the people whom they overcame, and these they imposed upon them, with their gods and their religious practices, respecting, nevertheless, the local gods, in such a manner that while increasing the range of their own myths they augmented the number of them by adopting the gods of the conquered countries as a whole or in part, perhaps through fear of these gods or, more probably, for political reasons, in order to draw the sympathy of the conquered.

In view of what precedes, we will describe in the course of these notes certain special dances in certain regions of Mexico, without in any way implying that they were in use anywhere else, although in the course of events they often passed from one tribe into another for various reasons.

ANCIENT MUSIC AND DANCES.

Torquemada, who gives special attention to the Aztecs, tells us that the Mexicans were not musicians, that their songs were very monotonous, although they varied the tone of them without abandoning certain very marked rhythms. The musical instruments which they used were rudimentary. I will give a description of them later on. As for the dances, or balls, they varied greatly. Orozco y Berra, in commenting on Torquemada, describes them thus:

"At private affairs the dancers were few in number. They increased according to circumstances and numbered thousands on occasions of formal fêtes. When they were in small numbers they arranged themselves in rows which advanced and moved back with measured steps, or placed themselves opposite each other, joining and mingling. If the dancers were in large numbers, the musicians, seated or standing on small mats, occupied the center of the place where the ball was held, while all around them the dancers moved in concentric circles and eddied about with more or less rapidity according to whether they were more or less distant from the musicians. The leaders of the ball, two or four in number, were all near the musicians, the other dancers being in a formation like the radii of a circle." (It was probably the style of the master of ceremonies or of the ballet which regulated the step or the measure.)

"At a signal, the music commenced, and the art consisted in dancing, so as to make the rhythmic movements coincide with the music and the songs which accompanied it." (Knowing that the Mexican instruments produced a rather discordant music, it may be supposed that the songs were for the purpose of giving it some harmony by blending the deep sounds of the drums with the shrill notes of the flutes and pipes.)

"The movements were carefully indicated and the dancers," says Orozco y Berra, "as though moved by springs, were supposed to raise simultaneously the same hand, the same arm, or move the same foot. Naturally," he adds, "those in the first circle moved relatively slowly, but in proportion as they were distant from the center, the dancers had to cover a greater distance in the same length of time, and consequently the speed kept increasing. At the end of each strophe, they started over again. Then the time changed, constantly increasing the rapidity of movement, in such a manner that at the end the dancers in the last circles acquired a giddy speed. Between the concentric circles the little children followed the dance, together with buffoons and a kind of clowns, who wore ridiculous disguises, and now and then spoke or sang jokes or clever remarks to amuse the spectators."

These chorographic spectacles lasted for several hours. The tired dancers were replaced by others and the first withdrew to refresh themselves or take some rest. All came dressed in their most beautiful clothing, and covered with ornaments and jewels, carrying in their hands bouquets of flowers, branches, or fans made of bright-colored plumes. Others were crowned with garlands, "and it was a spectacle worthy of admiration," declares Torquemada.²

² Monarquía Indiana, vol. 14, Chap. XI.

In an excellent work, *Indumentaria Mexicana*,³ the eminent Americanist, Dr. Antonio Peñafiel, gives some very interesting details on the balls of the ancient Mexicans. The following passages are quoted from it:

"The ball was almost always accompanied by songs, two singers intoning a verse and all responding in chorus. The music began on a deep note, and the singers in a bass voice. Progressively they increased the time or raised the voice at the same time that the movement of the dancers became quicker and the song gayer * * *.

"One of the balls, called the *Macehualiztli* or *Areito* 'ball' or 'fashion,' was accompanied by drums. *Macehualiztli* is derived from the Aztec verb *maceahua*, a dancer, and *areito* is a word from the Antilles having the same meaning. It is synonymous with *Mitote*, which is derived from the Mexican *Mitotiani*, a dancer."

"According to Sahagun," says Doctor Peñafiel, "those who directed the ball were luxuriously dressed. The principal leader wore bound around the top of his head a tuft of feathers or of gold, an ornament of gold or a precious stone in the lower lip (*le tentetl*), and golden ornaments in the ear. A collar of precious stones encircled his neck, and at his wrists shone bracelets of emeralds and turquoises. He held in his hands bunches of feathers or flowers, a rich cloak covered his shoulders, and around his loins he wore the *maxtlatl* (a cotton loin cloth worn by the Mexicans). All the other dancers, gentlemen, warriors, and various people who were supposed to take part in the festival, were dressed in the same manner, although less luxuriously.

"The distinctive mark of the kings at the balls was a kind of banner (the *quetzalpatzactli*) which constituted also a war standard.⁴

"The *tlamanime*, warriors who had captured enemy prisoners, wore during the balls a frontal ornament called *tottotlamanalli*. This ornament consists of the head of a bird surrounded by a crown of eagle feathers.

"Besides the religious and the war dances, there was one which they called *cucicoyan*, meaning, according to Tezozomoc, 'the great delight of ladies. The word comes from *cucicuatl*, song, and the ball took place in a sort of convent, which they called the *cihuacalli*, 'house of women.' The drinks which they used to intoxicate themselves during these balls contained several venomous, active principles, which caused visions, luminous, fantastic, and sometimes also veritable delirium. Such were the *Itzcuiatl* and the *Piasteromatl*,

³ Mexico, 1903.

⁴ The *quetzalpatzactli* was a sort of shield bearing the hieroglyphics of the chief whose duty it was to carry it in battle, and surmounted with a tuft of green and blue feathers of the quetzal bird.

which they drank during the ball of the dead, and also another beverage which had for a base a fungus named *cucuhnanacatl*, of which they made use during certain religious ceremonies."

On the subject of the Mexican balls, Father Acosta tells us the following (it is translated almost word for word respecting the unaffected simplicity of the text):

"The recreative exercise the most in use among the Mexicans is the solemn *mitote*, which is a kind of ball, considered so noble and so honorable that the king himself deigned at times to take part. This ball took place generally in the spacious halls of temples or of the royal residences. They placed in the center of the hall the *teponaztli* and a drum (the *huehuetl*), like a barrel made of a single piece of wood and hollow inside, which they put upon a support bearing the figure of a man or of an animal, or simply on a column. These two instruments were so tuned that together they gave quite good harmony, and they accompanied the noise of the other instruments and of the many and diversified kinds of chants and songs. All sang and danced to the sound and in the cadence of these instruments, with such good order and such good time, both in the songs and the foot movements, that it was an agreeable thing to watch. They formed two circles or rows, one of which was around the center of the hall near the instruments. The old people and the lords—constituting one circle—sang and danced almost without moving from their places. The other circle was for the rest of the crowd and was quite distant from the first. The dancers forming it moved lightly two by two, executing a kind of step together with leaps in cadence. The crowd adorned themselves for these dances with their finest clothes, each according to his means and his taste. They considered it very honorable to take part in these dances, and there they prepared themselves to learn dancing from childhood on. And, although the majority of the dances were in honor of the gods, nevertheless there were those which constituted a form of recreation and pastime for the people."

Regarding the true war dances, not only did the warriors take part in them, but also the greatest personages of the court and the king himself, for whom a special place was reserved. For sacred dances the dancers were dressed in the image of the deities whom they worshiped on that day, or wore exclusively his emblems and his symbols. The music was the same—that is, it was not very harmonious, but the songs, the movements, and the actions had a more reserved, more solemn character, and mingling was not permitted. The men danced alone with the exception of certain days in the year when the vestals were admitted, as were also the students from the seminaries and even the priests, and it was no longer

a matter merely of reverence, of respect; arms were raised in cadence toward the sky to thank the gods; actions made allusion to their qualities, or to the occupation over which they preside, fighting, hunting, as we shall describe later on. Many of the dancers carried in their hands a kind of rattle which the modern Mexicans call *sonajas* and which the ancient Mexicans named *ayacaxtli*. These are sometimes little elongated gourds, dried in the sun, having the seeds left inside, which produced when shaken a noise resembling the singing of locusts. Sometimes balls of baked clay or of wood were used, pierced with numerous small holes, provided with a handle for shaking them, and containing pebbles to take the place of the seeds in the gourds. Generally the dancers marched in two or four lines from the entrance of the temple to near the altar of the gods, retreating without turning around, then advancing again.

Let us note in passing that they never kneeled. This custom appears to be absolutely unknown to the ancient Mexicans. To prostrate themselves or to humble themselves they assumed a squatting posture (*de cuclillas*, writes Torquemada). That was their reverential position, both in worshiping the gods and in paying homage to priests, to kings, and to great noblemen.

One of these dances, called *tocotin*, was so beautiful, so fitting, and so solemn, says Torquemada, that it was admitted into the Christian temples.

The dances in honor of the gods and in costumes recalling their special character or their symbols, bring to mind the balls held in honor of the ox Apis—ancestor of our Boeuf Gras—notably at Memphis, by the disguised actors who represented scenes from the life of Osiris. Father Salvatierra writes that he has counted among the ancient Mexicans as many as 30 different dances; some were sacred, others war dances, and yet others simply profane, and that each "had for its aim the imitating of occupations or customs of life." He mentions in particular a ball which he witnessed in California, in the course of which each dancer—and there were more than 300 of them—leaped about having in his mouth an adder.

As regards war dances, besides the festivals accompanied by balls held on certain days of the year in honor of *Huitzilipochtli*, there should be mentioned the dance of victory, which varied according to the greater or less degree of civilization of the peoples or tribes who practiced it. As for the dances which we will call civil or profane, Father Salvatierra adds that in leaping about "the dancers imitated the operations and the efforts of hunting, of fishing, of war, of the harvesting of roots and of fruits, and of other ordinary occupations. One of these dances is called the *Nimbus*." It should be noted that this name has nothing to do with the sense that we attach to the vocable "nimbus," which could very well be applied to the kind of

dance of Loie Fuller, which, in fact, takes place in a nimbus of colors and of gauze.

I consider that Father Salvatierra is in error when he speaks of "the imitation of ordinary occupations by the dancers." It seems to me, after what I have seen in the writings of Torquemada, Sahagun, Mendieta, Ixtlixochitl, and other early authors, that these balls were appropriate to circumstances: For example, on the day of the festival of the goddess of the chase, *Micoatl*, they imitated activities of the hunt; those of fishing when they fêted *Apochtli*. When it came to *Centeotl*, the Mexican Ceres, they simulated in pantomime the gathering of fruits and roots, they organized a battle of flowers, they adorned themselves with garlands; in the same way that in fêting *Hwitzilipochtli*, the god of war, they gave representations of combats.

In short, they dedicated to the god the occupation over which he presided through his special character. As in our calendar, each day of the year had its god, its goddess, its myth, its distinctive emblem. They celebrated these anniversaries: A child born, for example, on the day of the festival of *Apochtli*, god of the fishers; a woman who was married on that day; any event which happened on that date, justified the presentation or the representation of something recalling the fête of the day. No doubt they offered up fish, and in the dances which took place in the course of the jubilation they did not fail to introduce people dressed as fishers; they adorned the hall with nets, harpoons, small boats, aquatic flowers and plants; in short, everything which belonged to the domain of the god, patron of the day, or which recalled his functions, attributes, or character. This seems to me very probable, but I confess that I am not able to determine it definitely from the texts of ancient authors. It is simply a deduction.

The dances in honor of the god of war, which they would have held in cases like those which I have just mentioned, are not connected in any way with the famous dance of victory, to which I now come.

This ball was celebrated, as its name indicates, after a victory won over their enemies. The conquerors forced the vanquished to dance to exhaustion; that is, they killed them through dancing. They themselves mixed from time to time with the captives, uttering loud cries in honor of their god of war—who was not the same throughout Mexico—and gave themselves up to the excesses devised by the soldiers of all times and of all peoples after a triumph.

It is to be noted, however, that they did not become intoxicated, at least in the ordinary sense, for although the ancient Mexicans knew several alcoholic drinks, among others (besides those which we have already mentioned) the fermented sap of the agave (now known as pulque, formerly as *octli*); a brandy also extracted from the agave;

a kind of beer, which is still used among the Indians of the *sierra* of Tepic, and other fermented drinks made of maize, figs of Barbary (*tuna*), or flowers of the elder tree; drunkenness was prosecuted and punished among them in a very severe manner, except in exceptional cases, as evidently that of a victory won over their enemies. But still it must not be thought that drunkenness was general and exposed the conquerors to the danger of being the victims of a successful return of the conquered. That is, all the men did not indulge in drinking. Chosen men kept their senses and guarded the approaches to the camp or to the city where they celebrated the victory.

I have said above that the dance of victory varied according to the degree of civilization of the tribes which practiced it. The word civilization does not really express my thought, for civilization is entirely conventional. I should have said, "according to the more or less sanguinary character of the tribes."

In fact, the Opates who lived in the Sonora celebrated their victories by the ball of the scalps—that is, that in dancing they bore in their hands the scalps torn from the enemies killed by them. They also made the prisoners dance without allowing them to rest, but they included among them the children, the old people, and the women, and during the figures they burned them cruelly with torches and firebrands.

Other tribes more savage still—the fact is reported by the eminent Mexicanist Alfredo Chavero⁵—cut off the hands of their enemies and used them to stir the *pinole*⁶ which they distributed to the conquerors. The human blood was mixed with the drink, but the dancers delighted in it, "the sentiment of vengeance," says Chavero, "effacing the sensation of disgust."

In speaking of the dance of victory the missionaries and the commentators exaggerate the cruelty of the Mexicans, their barbarous traits, which, however, have some foundation of fact. But if we recall the revolutionary dances, to the accents of "Ça ira," around the unfortunate victims of Robespierre, of Marat, and of Couthon, without taking account of still more recent events during certain strikes in France and elsewhere, without mentioning the lynchings of Negroes in the United States, we shall see that several centuries after the conquest of Mexico, there are found in the most civilized countries people who can at times rival in cruelty the barbarous tribes.

When in the seventeenth century several cities of New Mexico were reconstructed, the first thing that the natives would do would be to

⁵ Mexico a través de los Siglos, Vol. I, p. 125.

⁶ The *pinole* is a kind of chocolate. It is known that we owe to the ancient Mexicans the invention of this foodstuff. To make the *pinole* they mixed coffee meal with sugar of agave, and added to it either cocoa or pimento. In our day cinnamon is also added to it.

build up the hearth and to dance around it the ball of the "Cachina," for which they would make expressly masks many of which represented the faces of their ancient gods. It is still Chavero who makes this statement.⁷ After all, it was a general custom in all ancient Mexico to dance around a sacred fire, around the central hearth of a newly constructed house, or of a habitation which they had just rebuilt, and for this ball the natives wore masks, or simply painted their faces to imitate tattooing, and adorned themselves with flowers, leaves, and plumage, with which they then paid homage to the household gods.

In Yucatan, one special dance was in favor, and later it spread, with some modifications, into different parts of Mexico, then remaining under another form. In the center of a room they raised a pole from 15 to 20 feet high which bore at the top transverse bars, fastened on a common center which formed a pivot. From the ends of the crossbars hung cords of different colors much longer than the distance between the bar and the ground. The dancers, from 12 to 20 in number, each took the end of a cord, and at a signal commenced to move in cadence, advancing, retreating, turning, and crossing their respective cords in such a way as to form a kind of web, presenting symmetrical designs determined beforehand.

When, on account of this interweaving, the cords were so shortened that the dancers could scarcely hold them, even by stretching their arms and by standing on their toes, a new signal was given by the music, and the dancers, always in time and according to a prescribed rhythm, unwove the design which they had plaited, finding themselves at the end in the places which they had occupied in the beginning.

This kind of dance admitted of a variation: The cords were not so long, the dancers of both sexes were disguised as birds, and they were supposed to run, to pursue each other, to dance, to leap, even to imitate the flight of birds by moving the wings which they wore fastened to their shoulders; all without losing the cadence. This play, minus the costumes, however, is still preserved in Mexico, where it is called *volador*. It is, as will have been noticed, an exercise quite like that known in Europe under the name of *Pas de Géants*.

One of the most curious of the balls which may be mentioned was that of the animals and flowers: Men and women dressed like birds (Rostand has found nothing new in this connection) danced and whistled while turning in time, leaping up onto the trees, throwing themselves into the water when they simulated aquatic birds, throw-

⁷ Mexico a través de los Siglos, Vol. I, p. 116.

ing themselves on the grass; trying in every way to imitate the inhabitants of the air whose plumage they wore or which they pretended to represent.

For the dance of the flowers, the dancers dressed themselves in different leaves and flowers; for the ball of the animals, they covered themselves with skins of stags, pumas, ocelots, bears, of all the animals known to them; they ran, leaped, uttered cries, and pursued the women disguised as hinds and followed by their offspring.

It is certain that these kinds of dances should lend much to the imagination, and without pretending that they could rival the ballets of the opera, nevertheless in the open air under the beautiful Mexican skies, with the setting of palm trees, liquid ambers, the hibiscus and convolvulus of the Tropics, the magnolias, passion flowers, mimosas, and orchids of the temperate regions; cedars, oleanders, and cactuses of the cool regions; it must have produced a marvelous effect, especially if we remember the precious stones, the pearls, the gold and silver ornaments with which the dancers adorned themselves, the many-colored flowers with which their garments were studded, and especially the enormous glowworms and the luminous beetles with which the women adorned their hair.⁸

It will be noted that, except the *Cuicoyan*, none of the dances of which we have spoken have the licentious character of similar ceremonies in ancient Egypt, in Greece, in Rome, and in India. At heart the ancient Mexicans were chaste, and this is seen as well in the subject we are discussing as in their monuments, their sculpture, their hieroglyphic paintings which time has respected, and in which are met very rarely phallic symbols and other obscene images.

MUSICAL INSTRUMENTS.

We have mentioned above the *ayacastli*, in Spanish *sonajas*, a kind of bell with a handle, which the Mexicans shook while dancing. The other musical instruments were:

The *huchuetl*, a cylindrical drum 2 feet in diameter and 5 or 6 feet high, quite like the elongated drums of the Middle Ages. Generally it was made of a single piece, hollowed out with great care. They placed it vertically and beat it on the upper part with a wooden stick bearing at the end a ball of wood, of rubber, or of clay in a leather sheath.⁹

⁸ Some of these beetles, as the "cocuyos" of the Tropics, are sufficiently brilliant and cast enough light around them so that, when held under a glass, they enable one on a dark night to easily read a newspaper.

⁹ I say that the *huchuetl* were beaten with mallets, and I differ in this from the opinion of my excellent teacher and friend, Eugene Boban, who in his *Documents pour servir a l'Histoire du Mexique*, Vol. II, p. 132, tells us that the *huchuetl* of the temples or *teocalli* were only beaten with the back of the hand and never with drumsticks.

There were smaller instruments which the warriors wore suspended about their necks, and which they used to transmit the orders of the chiefs by means of adequate rolls. They called them *tlapahuehueltl*.¹⁰

The *teponaztli* was also a drum, but horizontal, and which they beat not on the end but at the center, on two strips made for that purpose forming an H in the direction of the length. They beat on these strips with mallets like those mentioned above, but smaller. The tone was more or less deep according to the location of the strip which the musician struck, sometimes with one hand, sometimes using both, the same as for the *huehueltl*. These instruments were carefully sculptured or embellished with designs. Some affected the form of a crouching animal: puma, ocelot, or alligator.

There were still other *teponaztli*, which quite resembled kettle-drums, and which were formed of the hollowed-out trunk of an agave, over which a skin was tightly stretched; for example, the celebrated *teponaztli* of the Great Temple of Mexico, which was made of a hollow piece of wood covered with a snake skin. The sound of it was mournful and carried a great distance. It signalized generally great ceremonies, and there will be recalled the mention made of it by Cortez and Bernal Diaz del Castillo, as also the "Conquistador Anonimo," who heard its terrible call at the time of the revolution of Tenochtitlan, on the night of the 30th of June or the 1st of July, 1520 (La noche triste).¹¹

I have also seen *teponaztli* made of a tortoise shell covered with the skin of a sea cow, whose tone resembled quite closely that of our modern drums. These were called *ayotl*. It is worth while adding

¹⁰ The etymology of *tlapahuehueltl* is not easy to determine, at least opinions are very different:

To begin with, *huehueltl* means incontestably "tree hollowed by time," or, by analogy, "piece of wood hollowed out." This caused no difficulty, and, in fact, the instrument is a piece of wood hollowed out.

But what does *tlapa* signify? In all the geographical names in which this radical is found, the hieroglyphic shows a lavatory, a place where one washes, a wash cloth, a hand playing in the water. (See the remarkable Nomenclatura de Nombres geograficos de Mexico, by Dr. Antonio Peñafiel, Mexico, 1895.) But this translation applied to a drum to me has no meaning.

On the other hand, in Mexico they designate by the name *tlapalerias* all places where they sell paints and varnishes; evidently this name is derived from the Aztec *tlapalli*, color, *tlapani*, to dye. It can then be admitted that the *tlapahuehueltl*, differing from other drums of this kind, was painted, adorned in colors, which would be easily explained, since indeed it was a drum reserved for warriors, and there would be nothing extraordinary in their carrying certain colors, or rather certain signs, certain hieroglyphics belonging to one certain tribe or army corps. Besides, there have been found *tlapahuehueltl* which still show fragments of red and black lacquered painting.

But I go further. I believe that *tlapahuehueltl* means not only "drum with colors" or "painted drum," but, by extension, "signal drum"; and if it is admitted that this drum was carried particularly by the aide-de-camp, who, by beating it in a certain way, transmitted the orders of the leaders, my explanation will seem admissible: *Tlapahuehueltl* means, then, signal drum, order drum, or drum of command, as you wish.

Several authors write, not *tlapahuehueltl*, but *tlapanhuehueltl*. *Tlapan* in Aztec means place where they dye, dye works; *tlapani*, to dye. *Tlapanhuehueltl*, then, still signifies "dyed or painted drum."

¹¹ The tragic night.

that whenever these instruments were covered with any skin whatever, they were provided with straps to stretch them and tune them. The pitch for all kinds comprised only three notes, do, re, and si.

The *teponaztli* in general were placed on tripods, not only to bring them more easily within reach of the standing musicians, but especially to avoid contact with the earth, which would deaden the sound and prevent it from carrying so far.

Besides these various kinds of drum, the ancient Mexicans used whistles, many of which had at the mouthpiece three or even four holes, permitting them to give as many different notes. These whistles were generally of earthenware and affected different forms. Many of them represented flowers, birds, and sometimes even fish and snakes. Some had inside a small round stone or ball of clay, which produced a rolling when they were blown. A special whistle permitted of the imitation of the song of a bird, which, it is true, should not be compared with the Mexican nightingale, the *zentzontli* (bird-mocker, or more exactly, the bird of the four hundred voices). This whistle was called *quauhtotopotli*.

The ancient Mexicans had also flutes or rather a sort of fife, with three, four, and even five holes, sometimes made of terra cotta, sometimes of wood, and quite often of bone. Some have been found made from a humerus. The Museum of Mexico has one of this last kind, which has six holes. This kind of instrument is at present known by the name of *chirimia*.

They had also war trumpets, *tepusquiquiztli*. These consisted of large shells, one end of which had been cut off to form the mouthpiece. These were also made of terra cotta, imitating the shape of a shell and ending with the head of a tiger or a snake.

There should be mentioned, besides, the bells of all kinds of metal; copper, gold, and silver, more or less mixed, and bearing designs in relief, like those which are sometimes found in our time in Chiapas and Yucatan, and which vary in dimensions from the size of a plum to that of a cherry. They made them also of wood. I have collected many of them among the ruins of "La Quemada" (State of Zacatecas); others, finally, were of terra cotta. They used these bells somewhat as the Spaniards use castanets.

All these instruments still exist among the modern Mexicans, and the Indians use them in their characteristic dances. But other materials are introduced into their manufacture. For example, they have whistles, flutes, and bells not only of terra cotta and of wood but even of tin.

They have also increased the number of them by perfecting the flute of Pan, and adding little trumpets of terra cotta, which recall our pistons; and little bells also of terra cotta affecting the form of the

bust of a woman surmounting an enormous crinoline, quite like the table bells that we have in Europe and in the United States. I have several specimens of them which produce a silvery tone, not at all dead as one would suppose. This evidently results from the composition of the special clay which the makers used. Sometimes these little bells were doubled, that is, coupled together, giving two quite different tones.

In the balls of the Indians of our time there are frequently introduced entirely modern orchestras with wind and stringed instruments, but in that case the ball was not slow in degenerating, although keeping its ancient character in movements and rhythms, as we shall see later on, in the ball of the Antiguos, the Matachines, or buffoons; the polka, the danza, and the boleros made their entrance; the couples were mixed, and it resembled any popular ball, with the usual accompaniment of cries, libations, disputes, and knife cuts.

MODERN DANCES.

Fray Bernardino de Sahagun¹² and Father Acosta¹³ mention the theatrical representations and the balls which the ancient Mexicans gave at Cholula in honor of *Quetzalcoatl*. "The Aztecs," they say, "cultivated not only lyric poetry but also the dramatic. Their theater was a platform, square and uncovered, situated ordinarily in the center of the market place or at the foot of some pavilion. This platform was sufficiently raised to enable it to be seen from all sides by the spectators."

"The theater of Tlaltelolco," writes Cortez in his *Relaciones*, "was made of stones and lime, 30 feet high and 30 paces on a side."

They carefully adorned this kind of stage with branches, plants, and flowers. Stuffed birds were placed in the foliage. The actors, ludicrously painted, simulated being deaf, blind, or afflicted with some infirmity, which gave rise to much blundering and jeering. They went to ask of some idol the cure for their ills, and thanked them for hearkening to their prayer.

Other actors disguised as animals of every kind recounted stories, expressing in pantomime scenes in which the vices and faults of men were ridiculed by the animals, serving as lessons of high morality like the admirable fables of our *La Fontaine*. They gave also representations of historic facts, of battles, and the actors put so much feeling into them that often a man was killed. The representation always finished with a ball, in which the different actors took part in the costume of the rôles which they had filled, and this did not take place without leading to comic scenes.

¹² *Historia general de las cosas de Nueva Espana.*

¹³ *Historia natural y moral de las Indias.*

When the Spanish missionaries began to catechize the ancient Mexicans they took advantage of their taste for singing and for the theater, and organized representations closely resembling the *Mystères des Enfants Sans Souci* and the *Confrères de la Passion*, which were executed in our churches in the Middle Ages. These mysteries were accompanied by sacred songs which made easier the teaching of the Christian doctrine.

It is thus Sahagun composed in the Aztec tongue 365 "canticos," one for each day of the year. It would be more correct to say not "canticles" but farces, for the songs, although of a religious character, were often accompanied by gestures and intermingled with dialogues. He had numerous imitators among the Mexicans themselves, and the memory has not been lost of a great mystery in honor of the Mother of God, due to Don Francisco Placido, governor of Atzacapotzalco. This mystery was successfully represented in one of the celebrated ceremonies in the basilica of Notre Dame de Guadalupe.

There should not be forgotten either the Final Judgment of Father Andres de Olmos, represented in the church of Tlatelolco, in the presence of the first viceroy, Don Antonio de Mendoza, and of Fray Zumarraga, the first archbishop of Mexico (1540).

These festivals have still another origin besides that which has just been mentioned. In the time immediately following the Spanish conquest, the conquerors and the monks held dances for their Indian vassals—for the abbey had vassals, like the seignorial fiefs given to the conquistadors by the kings of Spain—dances recalling more or less exactly those of the ancient Mexicans.

For the rest, there were religious festivals, and even profane ones—I will speak of them later on—in which the Indians, remembering their conversion to Christianity, came to make honorable amends in some church. To do this, they dressed up in imitation of their ancestors, danced and sang in accordance with what they had retained or knew of the past; and all was accompanied by alms for the priests who perceived in this the most indisputable gain for the natives. Later still, when the Indians saw the Spaniards celebrating the carnival, this old custom came to life, and what was formerly a kind of affirmation, of acknowledgment of vassalage, then a religious festival, became only a vague *mardi gras* or a day of *mi-careme*.

These representations, in use until the last day of the Spanish domination, disappeared at the beginning of the nineteenth century, during the political disorders. During the 10 years of the War of Emancipation of New Spain the Indians, like the middle class of people, had other preoccupations than the theater and dances. The Spanish clergy had lost all influence, and the native clergy was only beginning to be organized.

In all that we say in the following we refer, of course, only to the Indians properly so called and to the lower classes. We will concern ourselves only with these two classes of Mexican society, because they are the only ones who have kept anything characteristic; the higher classes, as we have already said, model themselves as much as possible on the uses and customs of France and Spain and follow the modes of Paris, of London, and of New York with more or less delay.

After the proclamation of independence, as during the wars to gain it, the Indians and the common people continued to go to their services, but certain ceremonies were lost, among them the dances, whether in the church, in the court, or in the neighboring square. Nevertheless, in many Indian villages on certain dates, in particular for St. John, and for the invention or exaltation of the holy cross, the natives organized balls which they called "Bailes de los Antiguos" (dances of the ancestors).

They disguised themselves with all sorts of tinsel and ornaments, to resemble more or less vaguely the Mexicans of other times, even to the Redskins, whom some have still been able to see in the exercise of their functions; and thus accoutered, they sang, danced, and drank all one day and most of the night. The half-breeds willingly mix with them in this kind of celebration, which has, however, almost no ethnic character—nor esthetic. One of the figures, however, recalls vaguely the song and dance to the sun, of the Comanches and the Apaches. This ceremony generally took place around a victim, white prisoner or Indian warrior of another tribe, after some combat. The Redskins danced in the same manner around the stake where they burned the body of their chief. My friend, the worthy archeologist, M. Eugene Boban, who has told me the story of it, was present about 40 years ago at one of these weird ceremonies in the Sierra Madre of Chihuahua.

The savages, first taking each others hands, danced in a circle for a certain length of time, their eyes fixed on the stake; then separating, they continued to circle in the same order, uttering prolonged exclamations, while striking themselves on the chest with their hands, which produced a series of Ah! Ah! Ah! stopping only to breathe. At present, victim and stake are replaced by some barrels of "pulque" or by a jar of brandy and the howlings which the dancers utter are far from harmonious.

The Indians in general are sad—they do not know how to laugh. They sing but little, and when they do the melodies have little expression or are melancholy and without much charm. However, according to Miss Fletcher, collaborator of the Bureau of American Ethnology, their voices are remarkably accurate. She claims that she has had melodies sung by Indians of every age and of different

extractions, in solo and in chorus, and she has never found among the various performers the least alteration in rhythm or in melody. Miss Fletcher has collected with the aid of a phonograph different Indian melodies which she has transcribed with the usual notations and submitted for study to several expert musicians. Not only have they not been able to find the dissonance which might be expected in music coming from races uncultured and relatively little civilized, but they have even found in it, it is said, striking resemblances to "themes of Beethoven, of Schubert, of Schumann, and especially of Wagner." I confess that all of this astonishes me greatly, except that concerning Wagner; I have always wondered whether the music of this composer did not have something of barbarity, but it has been necessary for Miss Fletcher to open my ears in order that I might know to what to attribute my opinion.

As far as I am concerned, all the music I have heard among the Indians—that is, of course, original music and not imitations or recollections of things more or less modern—recalled nothing of Beethoven nor of Schumann, but rather brought to mind liturgical chants roared by drunken singers which could be heard a long way off. I will add, to justify my comparison, that generally when the Indians sing, except in church during services, they are drunk.

Several months ago I was able to be present at Dinamita¹⁴ at the balls, semiprofane, semireligious, of the ancients or ancestors celebrated by the natives. These are divided into two groups—the Antiguos (ancients, ancestors) properly so called, disguised as Redskins at a carnival, and the Matachines (matachins, clowns), wearing fantastic costumes. It is to be noted that these dances—as droll as are the costumes—are very seriously conducted. The dancers do not dance for pleasure; they are observing a rite, a kind of religious ceremony. They dance to a monotonous rhythm which has more of the liturgical chant than of profane music.

They throw themselves about for hours and hours, day and night, almost without stopping, for about nine days, until completely exhausted. None of them dance in couples, no one touches anyone else; each dances on his own account, all following the general lines of a known program. No obscene motions; brief words to indicate the movements; and from time to time a great collective cry: Ah! Ah! Ah! Ah! which all modulate and prolong interminably. This recalls at times the "sun dance" of the Sioux and the Apaches, from whom the cry is certainly borrowed. We have already alluded to this above.

¹⁴ Dinamita, where are located the acid and explosive factories of the Mexican National Dynamite and Industrial Explosives Co. (French capital), is situated in the State of Durango in a region called "La Tinaja" (the basin), which was formerly—and up to 50 years ago—a retreat of the Redskins, particularly the Apaches and Kickapoos. I have dug up numerous traces of them—bones, ornaments, and different implements.

Every day the festival and the ball are begun by a march toward the consecrated altars, one to the Holy Cross, the other to St. Joseph.¹⁵ It must be noticed that among the dancers five or six personages are specially distinguished; the king; the queen, who is generally a little girl and the only person of her sex allowed to take part in the ball; the grand master of ceremonies, called simply the master, who seems to fill the rôle of an outsider to the company, a kind of master charged with calling to order and punishing, for very often he is furnished with a whip of several thongs, which he uses sometimes to mark the step, sometimes to beat time, and at other times to lash the dancers' legs. Besides him there frisked about the fool, who, dressed in a fool's cap, carried an empty bottle surmounted by a potato rudely carved to represent a human head, or perhaps more often a carved coconut provided with a handle or a little doll. The clown is for the purpose of amusing the public with his buffoonery, his jokes, his grimaces, his ridiculous antics, but he never makes his companions laugh. Sometimes the devil is also portrayed.

All these figures were well represented at Dinamita, but one was lacking which I have seen at other places—death! At Dinamita death was replaced by the old man, who after all symbolized the same thing, since old age is the beginning of the end, the preparation for the grave. The person who represents death or the old man often gives his hand to the fool, but pays no attention to his grimaces.

It is certain that all this constitutes an ensemble which formerly pointed a moral, as in all of the ancient mysteries. All men, rich or poor, kings or plebeians, are subjects of the empire of the senses; they make us all more or less foolish, more or less ridiculous; but always death lies in wait for us, and always we have a master:

Over the humble are the powerful; over the powerful, the king;
 Over the king, the emperor; over the emperor, the fear
 Of a plot born among his escort;
 And over all the infinite, the future, God, death;
 Death, which for each, be he weak or strong,
 Suddenly opens the same door * * *

In the morning the dancers, led by the queen, move to the altar, dancing in two ranks, flanked by the fool, the devil, and the master, who to some extent play the part of clown. These are, I may repeat, the only persons whom one sees laughing at times. The others display only religious activity and ritualistic or hieratic poses and signs. After a series of dances and prayers before the rustic altar, other ensemble figures are danced outside, but always at determined intervals they return toward the altar.

¹⁵ Elsewhere than at Dinamita, the altar is consecrated most often to Notre Dame de Guadeloupe, the patron saint of Mexico, or to the saint, patron of the village in which the festival takes place.

One fact will give an idea of the distinctly religious character of these celebrations, in no way carnivalesque in spite of the costumes and the burlesque aspect of the whole at the first glance. On the 5th of May, 1912, the "ball" was at its height in Dinamita when, toward 4 o'clock in the afternoon, the priest asked me whether the time seemed to me suitable for the benediction of the graveyard, which was supposed to take place on that day. I agreed that it was, and with the priest, preceded by the sexton and followed by about 50 people, we took the road to the cemetery, about 3 kilometers away. While passing near the native village of Dinamita, where the dances took place, our passage was noted and immediately the dancers of the two troupes "Matachines" and "Antiguos" joined with us, together with their musicians, and followed, dancing and gesticulating as usual. The priest accepted their company, naturally and without the least notice, or, I should rather say, as something fitting, as a pious act. At the cemetery they made him sit on one of their two thrones; these consisted of rustic armchairs garlanded with ribbons, flowers, and leaves made of colored paper, and they bent devout knees during the benediction of the tombs and of the ground destined for future burials. They accompanied mutely the litanies, the rosary, then they returned with us without stopping their dancing and without their presence causing the least scandal.

This seems to me to demonstrate that these dances had a distinctly religious side. Traditionally, something of their freshness and of their early simplicity has undoubtedly been lost at obstacles on the journey traveled during four centuries. But they have nevertheless preserved a pagan element borrowed from the ancient myths of Mexico, together with the skillful grafting-on done by the Catholic missionaries. It is a mixture of the Cross of the Saviour of the World, the basis, bond, and symbol of the Christian religion, with the cross of Quetzalcoatl, which represents the four winds or the four cosmogonic suns of the Aztecs. But it is also, alas, the reflection of a considerable part of the population of Mexico, Indian or half-breed, semipagan, semi-Catholic, ignorant and fanatical among whom the thin veneer of civilization, the very superficial civil instruction and the religious education consisting almost entirely of affectations and outward practices of a cult, scarcely conceal the ferocity of the Redskin. Besides the war dances or the semi-religious, semiprofane dances of which I have just spoken and which have a character more or less archaic, there are several others, wholly modern, which are popular in Mexico: In the cool regions the *Jarabe*, the *Danson*, the *Boleros*, the *Jotas*, and in the tropical zone the *Zapateo*.

The *Jarabe* consists of a series of steps made by a man and woman, sometimes several couples, without touching each other, the man

dressed as a Mexican cavalier, the woman as a peasant of Puebla (*China Poblana*) or of Jalapa (*Jalapena*). The costume of the man is generally of deerskin adorned with silver buttons, or black trousers with a decoration of little pieces or figures of metal on the outer seam, a leather vest, white shirt, red cravat, a wide felt sombrero embroidered in gold and silver, and often spurs with rowels as large as saucers, weighing half a kilogram each. The woman wore a white waist adorned with lace and edging, showing her throat and the upper part of her breast, arms bare, a woolen skirt red at the top and green below, *rebozo* (scarf) of silk or cotton, according to the means of the dancer, silk stockings, little shoes, and in her hair, a wide tortoise-shell comb enriched with ornaments of gilded copper and artificial gems.

The orchestra is composed of the most diversified elements. We see in it the *chirimias* in imitation of the Aztecs, as well as drums which have no reason to envy the ancient *teponaztli* or the *huehuetl*, and all the stringed and wind instruments invented by human genius, with the exception of the binou and the bagpipe, unknown to the Indians or the Creoles.

Of course, when they did not have such a complete orchestra, the dancers contented themselves with a simple flute or with a poor violin. But the spectators always accompanied the music by clapping their hands and singing more or less harmoniously.

As for the dancers they moved clumsily opposite one another, sometimes changing places, sometimes turning in their own places, body rigid and arms behind them.

Sometimes the cavalier throws his sombrero between him and his companion, and both gesticulate around it. After all, their dance is reduced to keeping the step in time.

The *boleros*, imitating the Spanish dance of that name, are danced especially at Oaxaca. They are charming when executed by the Spaniards, who have the rhythm of it in their blood, and who put into their play all the feeling, the lightness, and the grace of which they are capable; in Mexico, it is confined, as with the *Jarabe*, to marking the step, but this time with an accompaniment of castanets.

The *Jota* is another dance imported from Spain, accompanied by gestures and poses which are far from being in good taste, and seem to me more indecent than artistic.

The *danza* is a kind of polka, which is interrupted at fixed intervals during which two couples join hands and make a turn in time, then each man takes his partner again or the partner of the second man, and begins again.

The *Zapateo* is more interesting. It is truly a national dance, and consists of the following: Under a shed, they place a small movable floor, *la tarima*, around which the men group themselves; a guitar

player tunes his instrument, and soon there skip onto the boards four, six, or eight girls, wearing a flower in their hair. They dance together, striking their heels strongly and in time to the music on the boards of *la tarima*. One of the men begins a song, a kind of chant, or each improvises and sings his own verse, always to the same tune and with the drawling tone which is heard everywhere in warm climates. These verses do not demand great efforts of the imagination, as may be judged from the following lines. One of the singers says, for example:

Ma novia, in the midst of these girls,
Appears to me like a star, a flower, a jewel,
But how sad she is on this beautiful summer night.
Her heart is warm, her eyes are the sun.

And one of the bystanders responds:

My two horses are sick to-day,
But the tobacco produces fine crops;
My friend Jose drinks all of the brandy;
It is indeed not very kind of him.

And so together, the bystanders repeat the last verse, and another singer begins again. No need of rhyme nor of assonance; the time suffices and that is required to be only approximately exact. The bystanders applaud the best dancers and the most amusing singers; if anyone wishes to let one of the girls know that she pleases him while she dances, he takes off his hat and puts it on her head. Often a dancer thus balances a whole pyramid of sombreros to the great vexation of her less popular companions.

The *Zapateo* ended, she returns them to their respective owners and receives a piece of money or some trinket. Certain dancers dance the *Zapateo* in time to the music at the same time untying with the points of their shoes the knots in a scarf placed on the ground. The dance is called the *Rebozo*. The feat is difficult but if the dancer succeeds, she is enthusiastically applauded.

When the people from the coast (*Jarrochos*) joined with the Indian singers, their verses were full of obscenities and words of double meaning. In the warm region, however, they are very free with words, and without the women being in the least offended, enormities may be said before them.

I have tried to retrace as accurately as possible the ancient balls and the present dances of Mexico. I believe that it will be interesting to go more deeply into the subject; at first by reconstituting these ancient dances in Mexico itself, amidst characteristic landscapes, with the people of the country who have preserved the type of their ancestors. This applies to that which relates to the past. As for the modern dances, it may be said that there are about as many of them as there are provinces, not geographic, but climatic, in the

Mexican Republic. To give an exact idea of them, as well as to represent the reconstitutions of the ancient dances, it would be necessary not only to take numerous motion pictures, but also to be supplied with a phonographic apparatus, to record the songs and the musical rhythms. This evidently requires time and patience but it has been tried elsewhere.

My friend, Louis Ganne, the author of "Pere la Victoire" and of "La Tzarine," has done it or at least was planning to do it several years ago for certain of the French colonies. It would be extremely interesting for a country so rich from an ethnographical and archeological point of view as Mexico, and I hope that this study may encourage some one to try it.





I. MUSICIANS WITH DRUMS, CLACKERS, WHISTLES, BELLS, ETC.

All of these statuettes, remarkable for their ear ornaments (*yacaca-tli*) and nose ornaments (*trpeyaca-tli*), were collected by the author in the territory of Tepic, near Ixtlan.



2. ANCIENT MUSICAL INSTRUMENTS.

1. Terra-cotta whistles in the form of birds, with two or three holes giving as many tones.
2. Sea shell with the end cut off to produce various calls and different tones.
3. Flutes and flageolets.
4. A kind of ocarina in the shape of a turtle giving four notes.
5. Whistles in the form of idols.
6. Whistles with one, two, and three holes.
7. Various whistles.
8. Terra-cotta bells.
9. Whistles in the shape of animals' heads.
10. Bell or clacker with three small bells serving as feet.

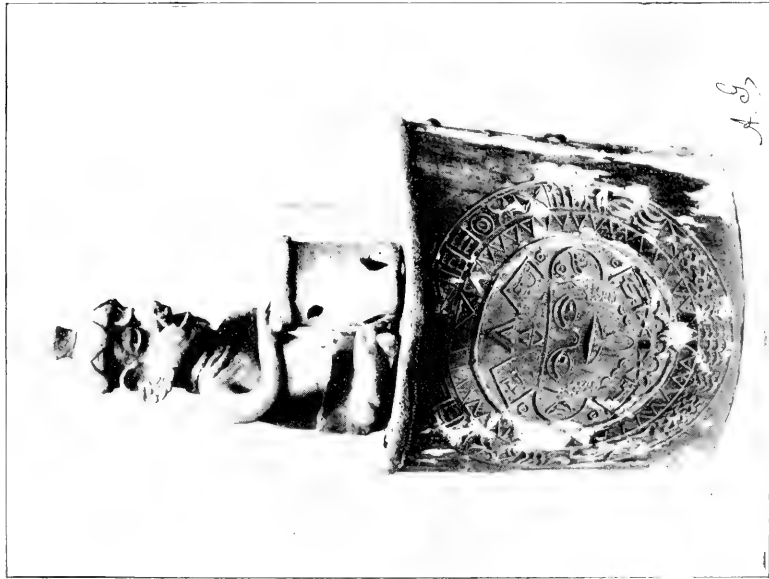

1. DRUM PLAYER FROM THE SIERRA NAYARIT. NOTE THE EAR AND NOSE ORNAMENTS, AND THE TATTOOING ON THE CHEEKS AND CHEST.



2. ACTORS DRESSED AS AZTECS, WHO TOOK PART IN THE FESTIVAL OF FLOWERS AND THE HARVEST HELD SOME YEARS AGO AT XOCHIMILEO.

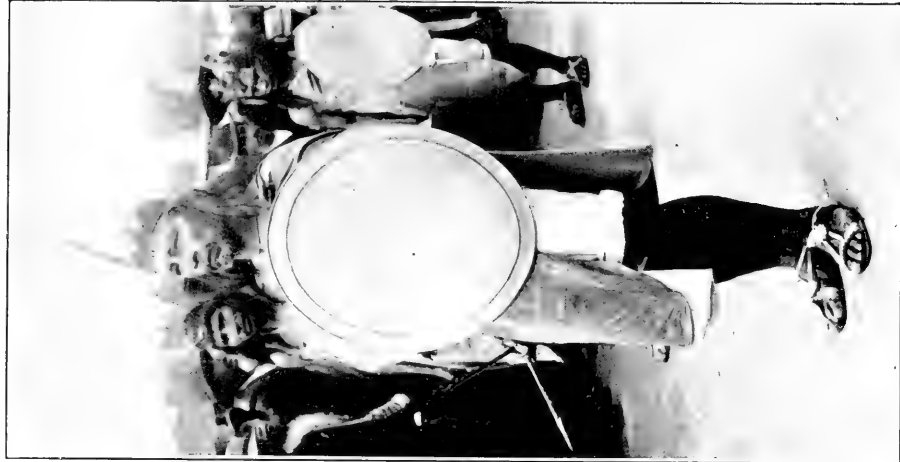
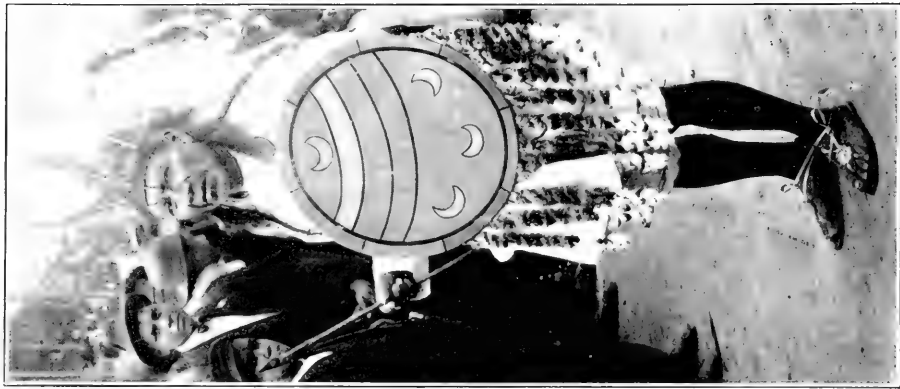

ACTORS DRESSED AS AZTECS, WHO TOOK PART IN THE FESTIVAL OF FLOWERS AND THE HARVEST HELD SOME YEARS AGO AT XOCHIMILCO.



ACTORS DRESSED AS AZTECS, WHO TOOK PART IN THE FESTIVAL OF FLOWERS AND THE HARVEST HELD SOME YEARS AGO AT XOCHIMILEO.

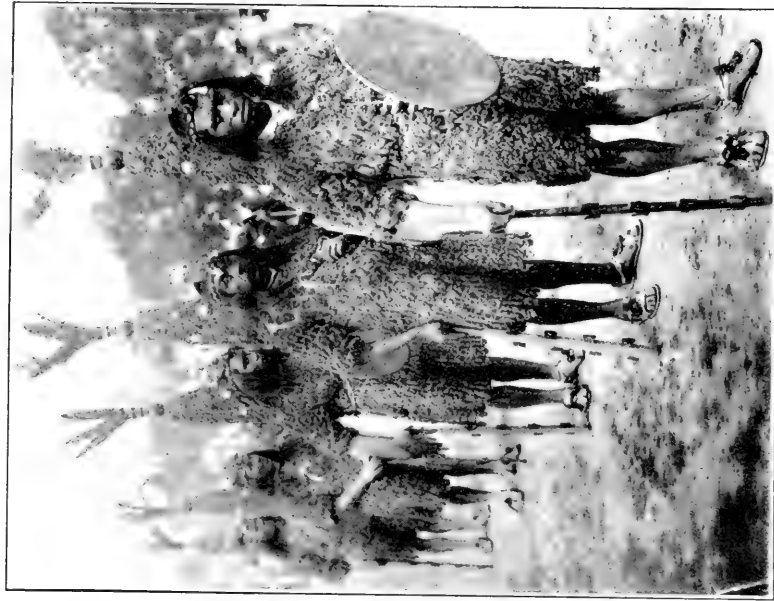
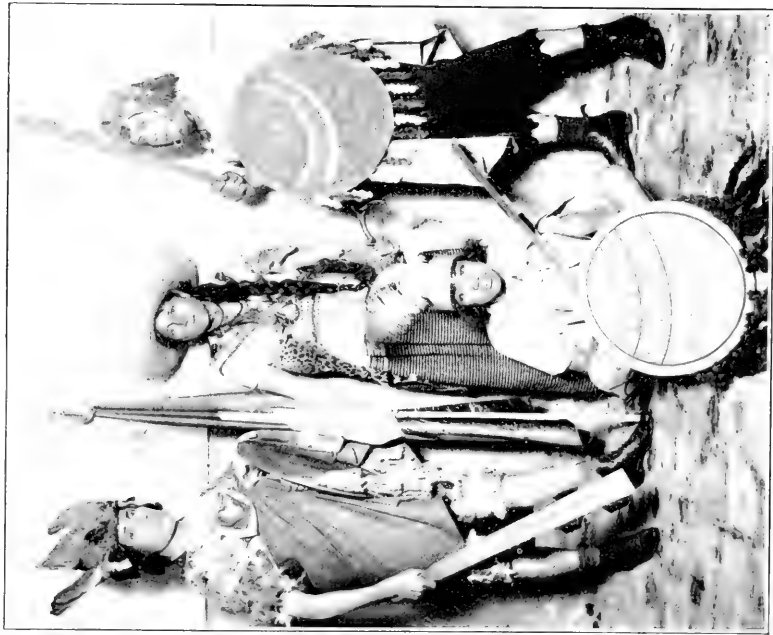

ACTORS DRESSED AS AZTECS, WHO TOOK PART IN THE FESTIVAL OF FLOWERS AND THE HARVEST HELD SOME YEARS AGO AT XOCHIMILEO.



1. ACTORS DRESSED AS AZTECS, WHO TOOK PART IN THE FESTIVAL OF FLOWERS AND THE HARVEST HELD SOME YEARS AGO AT XOCHIMILEO.

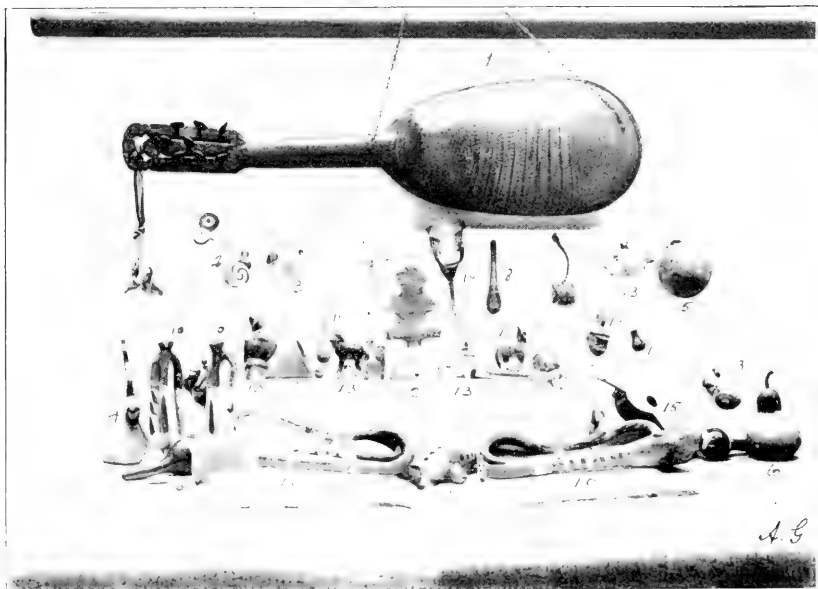

2. MODERN MUSICAL INSTRUMENTS.

(Author's collection.)

- | | |
|--|--|
| <p>1. Mandolin made from the shell of an armadillo.
 2-4. Terra-cotta bells from Oaxaca, producing a very marked silvery tone.
 5. Terra-cotta bells.
 6. Gourd containing dry seeds for producing noise and for accompanying dances in the same manner as with castanets.
 7. Terra-cotta flutes.</p> | <p>8. Terra-cotta bells.
 9. Ocarina made by the natives of Oaxaca.
 10. Terra-cotta trumpets.
 11. Bells.
 12. Bells and whistles of tin.
 13. Whistles of various kinds.
 14. Pasteboard whistle.
 15. "Jarana," a kind of guitar.</p> |
|--|--|



DANCE OF THE ANTIGUOS; THE QUEEN AND THE OLD MAN IN THE CENTER.



DANCE OF THE ANTIGUOS; IN THE CENTER, THE QUEEN; ON THE LEFT, THE OLD MAN; ON THE RIGHT, THE FOOL.



THE PARTICIPANTS IN THE DANCE OF THE MATACHINES (BUFFOONS).



DANCE OF THE WARRIORS AROUND THE QUEEN.



FROM LEFT TO RIGHT: THE LEADER (A MUSICIAN), THE QUEEN, THE FOOL, THE OLD MAN.



THE DEVIL (WEARING ON HIS HEAD REAL GOAT HORNS); THE SIMPLETON OR FOOL; AND THE WHIPPER, REDRESSER OF WRONGS.



THE OLD MAN. HE CARRIES A DOLL TO SHOW THAT HE HAS ENTERED HIS SECOND CHILDHOOD.



DANCE OF THE WARRIORS AROUND THE QUEEN.



THE JARABE IN 1868, AFTER AN ILLUSTRATION OF THAT PERIOD.



A PHASE OF THE DANCE OF THE SOMBRERO.

THE RALPH CROSS JOHNSON COLLECTION IN THE NATIONAL GALLERY AT WASHINGTON, D. C.¹

By GEORGE B. ROSE.

[With 24 plates.]

It is easy for a man to leave his pictures to a public gallery after his death. He knows that he is thus erecting to his memory one of the noblest and most enduring of monuments, and that he is insuring the beloved objects against destruction. But for the living art lover to part with his treasures is hard indeed. A thing of beauty is a joy forever, and the longer we own it the closer it twines itself about our hearts. We all remember the story of Cardinal Mazarin taking leave of his pictures. He was a passionate and discriminating lover of art, and his great collection is still the chief glory of the Louvre. When told that he must die, he had himself borne to his gallery, and there he took a last, long, fond, lingering view of each cherished possession, parting from them all with an agonizing regret. He could surrender earthly power and splendor with no great repining; but to part with the pictures that he loved so much tore his heart.

And so it is with every true lover of art. He is willing to lend his pictures to the public, that others may share his joy for a time. Occasionally, out of a large number he will give one to some public gallery. But rarely indeed does he do more until forced by the hand of death to yield them up. The gift by Mr. Ralph Cross Johnson of 24 choice old masters, to our National Gallery, has been but seldom paralleled.

These pictures have been hung together in one room, and they must be forever kept together as a memorial of such unexampled generosity. It is a collection rare for its even excellence. Each picture is a good and, indeed, a notable specimen of the master's style. Too often in our public galleries we see works of the great masters that are unworthy of their brush, and which tend rather to prejudice the public against these great men, than to incite admiration.

In speaking of these pictures I do not write as an expert on attributions. Mr. Johnson's collection has long been one of the most notable in the country, and has been sufficiently expertized. To be

¹ Reprinted by permission from *Art and Archaeology*, Vol. X, No. 3, September, 1920.

an expert in attributions one must have a knowledge of the weaving of canvas in different ages and countries, of the growth and structure of woods in various lands, of the idiosyncrasies of artists in the painting of ears and fingers and other nonessentials, in short, of a thousand details which I do not possess. It is a science demanding the study of a lifetime, and not a very exact one if we may judge by the incessant controversies among its greatest exponents; and too often the experts seem to lose all feeling for the beauty of the pictures, and to consider them as coldly as if they were insects to be classified. I shall accept the attributions given; and, after all, they are not so important, for the work of art is the thing, regardless of its origin.

First in time, and to my heart always first in importance, is the Italian school.

A few years ago our people had scant appreciation of the Italian primitives. When Jarvis brought over his extensive collection he found no purchaser, and what would to-day make his fortune proved his ruin. The larger part is now the pride of Yale University, while the remainder draws visitors from distant lands to the Cleveland Museum; but Jarvis had to let them go for debt. Now, thanks chiefly to the influence and example of the late John G. Johnson, of Philadelphia, Italian primitives are eagerly sought, and single pictures in the Jarvis collection would probably bring as much as he received for the whole.

One of the most delicious of the Italian primitives is Bastiano Mainardi, best known by his beautiful and gracious fresco of the Madonna della Cintola in the Baroncelli Chapel in Santa Croce at Florence, depicting the Madonna dropping her girdle to the adoring disciples as she is borne to heaven by choring angels.

Mainardi continued to paint until 1513, and witnessed the revolution in art wrought by the genius of Leonardo, Michelangelo, and Raphael; but the achievements of those supreme masters affected him not at all, and to the last he continued to paint in the old sweet primitive way of the early Florentines.

Mr. Johnson has given us one of his most delightful and characteristic pictures. It is a charming work in a marvelous state of preservation, fresh as when it came from the master's easel. The beautiful Mother, clothed in a robe of brilliant red with dark blue embroidered mantle, holds the infant Christ on her lap, while with the other hand she caresses the infant John the Baptist, whose hands are clasped in adoration as he gazes upon the divine child. Jesus lifts his little hands in blessing, while an angel bearing annunciation lilies is looking on. To the left there is a Florentine landscape.

This picture is probably the original from which the larger and more pretentious work in the Louvre was evolved. In repeating a

composition, artists usually add to it other figures. Seldom do they proceed by way of subtraction. Therefore the simpler composition is usually the first. Certainly this is the finer of the two, better preserved, richer in color, more united in composition.

The school of the Marches produced no painter of the very first rank, though some of the works of Francesco Francia, such as the *Pietà* in London, the *Deposition from the Cross* at Parma, the *Annunciation* in the Brera, and the *Madonna of the Rose Garden* at Munich, are among the most precious things in all the range of art. The dry-as-dust critic who can not appreciate their ineffable charm is surely to be pitied.

Francesco had several sons who devoted themselves to painting, chief of whom was Giacomo Francia. The *Marriage of St. Catherine* in the Johnson collection is one of his most delightful works. Both the *Madonna* and the *St. Catherine* are beautiful, especially the latter, a highborn maiden with features of Grecian regularity and wearing a royal diadem upon her queenly head. She lifts up her exquisite hand to the Christ Child, who is stretching forth the betrothal ring, while behind the group is St. Joseph and a landscape background.

The Venetian is the most glorious of all the schools of painting. In that branch of art it maintains the incontestable supremacy that Athens holds in sculpture; and among its masters there is none possessed of a more compelling charm than Lorenzo Lotto. There is scarcely anything on earth more beautiful than his *Holy Family* at Vienna, certainly nothing more exquisite and refined. And hundreds of years before Gainsborough painted his *Blue Boy*, Lotto in this picture refuted still more triumphantly the dictum of Sir Joshua Reynolds that blue was a cold color that should be relegated to the less important parts of the canvas, and used only to enhance the effect of the warmer hues. If it is ever admissible in speaking of one art to use the language of another, this must be called the incomparable symphony in blue.

But, while Lotto painted many lovely religious pictures, he was perhaps even more distinguished in the art of portraiture. When men have achieved success and have become rich and prosperous a pardonable pride leads to a desire to transmit their lineaments to posterity; and the Venetian nobles had every reason to be proud. They had raised upon the mud banks of the Adriatic a dream of imperishable beauty; they had attained the hegemony in the world's commerce, so that the wealth of the Orient was poured into their city's lap; and in a thousand desperate struggles on land and sea, they had built up a splendid empire. Their favorite painter was Titian, who depicted them as they loved to appear, calm, serene, far-

seeing, their brows crowned with the aureole of success, masters of themselves and of their fate.

With this grand official style the portraits of Lorenzo Lotto have little in common. As Van Dyck gave to all his sitters an aristocratic elegance, so Lotto gives to his a romantic sadness. One of the most haunting of all portraits is the Man with the Claw at Vienna. There is perhaps in no other male face so much refinement and delicacy combined with so wistful a melancholy. It is not surprising that in the rearrangement of the Brera a whole room is given up to portraits by Lotto; and there are few rooms that are so haunting.

The Lotto in the Ralph Cross Johnson collection represents a Venetian senator, a man in middle life, clothed in the black garments which Spanish fanaticism had forced upon the color-loving Italians, and with a black hat. You can see that he was born to great position, that he is calm, self-possessed, yet a little weary of it all; that the lesson of Solomon that all is vanity has not been lost upon his soul. Lotto has tried to paint one of the official portraits in the style of Titian, and has made a splendid masterpiece; but despite himself, something of his own romantic sadness has crept in.

The most striking of the Italian pictures is the large portrait of a cardinal by Titian. Here we have a man somewhat past middle life, seated at a table on which is a cover of rich damask. Before him lies an open book, from which he has just looked up. His face, with its hollow cheeks and deeply sunken eyes, is that of a man accustomed to rule, a man of affairs and yet a scholar; and it is apparent that greatness has brought no joy. The dark crimson robe which he wears and the cap of that color, are so deep in their rich tones, that only on a bright day can we realize their full splendor. This is one of the grandest portraits in America, equally remarkable for the force of characterization and the consummate technique.

It is a far cry from the great age of Titian and Lotto to the days of Francesco Guardi. Venetian art had flowered and died, and was enjoying a brief revival at the hands of Tiepolo and Canaletto. Two masters could not be further removed than these; Tiepolo with his sketchy, impressionistic treatment, his vague outlines, his brilliant colors, and his exuberant imagination; Canaletto with his photographic accuracy, his clear-cut lines, his gray tones and his unflinching realism. Guardi was the pupil of the latter, and in most of his works closely adhered to his master's style, though with somewhat more of freedom and with somewhat richer tints.

In this collection there are two large and notable pictures by Guardi. One represents the church of Ara Coeli and the Capitol at Rome. This is very like a Canaletto, and is a characteristic example of Guardi's usual style at its best. In the other, a landscape showing ruins with figures, he surpasses himself, and borrows from

his contemporary Tiepolo something of his sketchy treatment and brilliant color. It is the most delightful work by this master that I have ever seen. Evidently he was proud of it himself and conscious that from its unusual style it might be attributed to another; for upon one of the stones he has inscribed his full name, Francesco Guardi, in large letters in the form of a high relief.

Passing now to the northern schools, we find that Mr. Johnson has had the good taste to love those Dutchmen who went to Italy, and got there the preference for beautiful forms and faces while preserving their admirable Dutch technique. I have never been able to understand the prejudice that exists against these men. When the painters of other countries go to Italy and learn there the secret of eternal beauty, as did Poussin and Claude Lorraine, everybody commends them. But let a Dutchman or a Fleming before Reubens go to Italy and learn the same secret, he is treated as a renegade and a traitor, and no language is strong enough to voice the critics' condemnation. To me these Italianate Dutchmen and Flemings, with their marvelous skill and care in painting and their beautiful Italian types, are among the most delightful of painters.

Foremost among these were Bernard van Orley and Govaert Flinck.

In Mr. Johnson's collection is a Madonna and Child by van Orley. Both are beautiful. The child holds an apple in his hand. The background is a lovely and highly varied landscape with mountains in the distance. On the left we see soldiers sacking a large mansion, murdering the men and pursuing the fleeing women, who have no chance of escape. It is war. On the right is peace. Peasants are at work in the fields, while soldiers march by in the splendor of their accoutrements.

It seems to me that in these days when it is the fashion to sacrifice all details to the general effect, we lose more than we gain. One sees at a glance all that there is in a picture, and unless it has a compelling charm, it soon wearies us. But these early masters with their wealth of detail are inexhaustible. No matter how often we return to them, we find something new, and so our interest never flags.

Govaert Flinck's picture is simpler. It presents only a beautiful Madonna holding the divine infant, who stops nursing for a moment to look at the spectator. The types are Italian, the admirable execution is Dutch.

It seems to me that as a technician Rembrandt is the supreme master. He can paint in more styles than any other, and he is equally proficient in all, from the most photographic precision of infinite detail to the broadest effects. He is equally skilled in the manipulation of glowing color and of richest monochrome that yet gives the impression of splendid color. And his pigments have suffered

no apparent deterioration. We have seen Whistler in his nocturnes and other painters reproduce for a time the luminous shadows of Rembrandt; but we have also seen these works grow opaque and muddy, mocked by the changeless perfection of the incomparable master. Had Rembrandt possessed the sense of beautiful form that characterized the Greeks and Raphael and Titian, he would have been the greatest of painters. Even with this limitation, he remains without a superior.

In smart circles these days it is the fashion to exalt Velasquez above Rembrandt. The Spaniard is undoubtedly a mighty master of the brush; but his cold and apparently contemptuous aloofness, presenting the outward lineaments of his sitters with unsurpassable veracity while almost ignoring their souls, ranks him far below the sympathetic and deep-seeing Rembrandt, who comprehends and depicts every emotion from the gentlest and sweetest to the fiercest and most turbulent.

The element in a portrait that most interests the ordinary beholder is the character portrayed. Ordinarily the young have little character in their faces; but with advancing years the result of all the good and evil that men have done and thought becomes etched upon their lineaments in lines which the discerning eye can read as in an open book. Therefore, Rembrandt, the supreme master in the depicting of character, loved particularly the faces of the aged, and he makes them tell us all their secrets. Raphael and Titian and Velasquez were wonderful painters of portraits; but to my mind Rembrandt was the greatest of them all.

In Mr. Johnson's collection there is the splendid portrait of a rather young and handsome man, clothed in black with a broad-brimmed black felt hat and a broad white collar fringed with lace. He is evidently a gentleman of wealth and refinement, and he is painted with the admirable precision of Rembrandt's earlier style before he became absorbed in the study of light, and when his figures emerge mysteriously from luminous shadows. A truer or more vital portrait it would be hard to find.

While Rembrandt is *facile princeps* among the painters of Holland, the school had so many splendid masters of portraiture that it is hard to choose among them. But it seems to me that after Rembrandt none surpasses Nicolaas Maes. He never indulges in any of the dizzy flights of genius that so mystified Rembrandt's contemporaries. His feet are always planted firmly upon the solid earth; but his absolute fidelity to nature and his impeccable technique rank him among the great painters of portraits.

One of the finest collections of pictures in private ownership is that of Mr. Charles P. Taft, of Cincinnati. His dining room is adorned with a number of portraits of the English school of the

eighteenth century, marvels of style, dignity, and aristocratic bearing. But he has made the mistake of placing in their midst a magnificent Dutch portrait—by Nicolaas Maes, if I remember rightly—and when we turn from that living presentation of the actual man to the English portraits, they seem to lose all vitality, and to be not men, but pictures of men.

By Nicolaas Maes there is in the Johnson collection a wonderful portrait called *The Burgomaster*. Whether he is a burgomaster or one of the dominating clergy of the time, I can not say. Certainly he is a man used to command and quite satisfied with himself. Large, stout, florid, with the top of his head bald, but with long, gray hair growing out at the side and falling to his shoulders, with slight mustache and imperial, he is the ideal of the successful elderly gentleman, who looks with entire satisfaction on his past and with serene confidence to the future. But how unstable is human fortune! At London in the National Gallery, there is another portrait of the same man, signed and dated just one year later, haggard, with flabby cheeks, broken in body and soul. Sometime in that brief year the heavy hand of Fate was laid upon him with crushing force.

It is strange how indifferent our American collectors have been to Rubens. It is impossible to make any list of the world's half dozen greatest painters that would not include his name. He is as great as Rembrandt. Yet, while we have upon our shores more than a fourth of the masterpieces of the mighty Dutchman, the worthy examples of Rubens in our country could probably be counted upon the fingers of a single hand.

Yet one would think that Rubens would particularly appeal to our generation. In the old days genius was defined as an infinite capacity for taking pains. Leonardo worked four years on the *Mona Lisa*, and still deemed it unfinished. Titian kept his pictures in his studio for an average of five years. These days, however, the supreme desideratum of the artist is economy of labor. The man who can paint a picture with the fewest strokes of the brush is hailed by artists as their chief, and proclaimed by critics as the worthy disciple of Velasquez.

In point of fact, these slap-dash masters of our day find no justification in the practice of the great Spaniard. He was a slow and careful workman, who produced comparatively few pictures, less than one fourth as many as Rembrandt, not one tenth as many as Rubens. He painted usually with such perfection of finish that no brush mark remains, and we have no idea how the marvel was wrought. His pictures are equally satisfying whether we look at them from a distance or close at hand. We do not have to cross the room to see them, as with our modern artists who exalt themselves in his name.

When it comes to true economy of labor, no other painter can approach Rubens. The primitives and many moderns put into a picture numerous details which can be seen only on close inspection, and which are lost when we stand far enough away to grasp the picture as a whole. Many of our contemporaries, perhaps a majority, including all of those who are most praised by the smart critics, omit countless details which would be clearly apparent to one standing at the point of sight. Rubens alone never falls into either of these errors. He wastes no time in depicting things which we should not see when far enough away to view the picture in its entirety, and he omits nothing that could be seen at that distance.

He is the lord of life. His pictures are sometimes gross and sensual, but they possess an exuberant vitality unequalled in the realm of art, or, for that matter, in nature, for his men and women seem more alive than the living beings who stand before them. In depicting the satiny sheen of palpitating flesh he knows no rival. He is the most brilliant of all colorists, and time seems to have no power to dim the immortal luster of his hues.

That so supreme a master should be so inadequately represented in America is greatly to be regretted. We are therefore peculiarly fortunate in possessing Mr. Johnson's splendid Rubens. It is a beautiful Madonna nursing the infant Christ, whom St. Elizabeth watches with rapt devotion, while behind, St. Joseph lifts his hand with a protecting gesture. The St. Elizabeth is a portrait of Rubens's splendid mother, one of the grandest of women. The Madonna is full but not gross, and her neck and bosom are painted with the glowing flesh tints that Rubens alone knew how to render. Apparently it was painted about the same time as the Descent from the Cross at Antwerp.

But it is the English school that is most fully represented in this remarkable collection, particularly the great portrait painters of the eighteenth and early nineteenth centuries.

This is one of the noblest of all the schools of portraiture, and it was fortunate in the subjects which it had to depict. No one can doubt that the aristocracy of England is the finest aristocracy in the world. Their vigorous life in the open air has made them strong and tall and graceful. The respect and loyalty with which the common people have generally treated them lends to their countenances a serene nobility of expression. Of course, there are exceptions, but taken as a whole they are a splendid body of men and women. No wonder that Sir Joshua and his contemporaries loved to paint them.

And with what dignity and elegance were they portrayed by those great masters! No doubt the style of Van Dyck had much to do with this. Sir Anthony had painted all the greatest lords and ladies of the England of his day. His masterpieces were to be seen in many

an English mansion. The painter who came after him knew that his works would be hung beside Van Dyck's portraits, so aristocratic, so elegant, so full of style; and he felt that he must not derogate from their high standard.

By general consent Sir Joshua Reynolds is placed at the head of the English school. Probably he deserved it, but his colors have so often faded and dulled that as matters really stand to-day his pre-eminence is no longer incontestable.

When he pronounced the eulogy on Gainsborough, after the latter's death, he said that Gainsborough was the greatest of all English landscape painters; and Richard Wilson, piqued, perhaps, that he himself should have been assigned to an inferior rank in his chosen field, exclaimed "And the greatest portrait painter, too."

I confess that I am inclined to Wilson's opinion. Certainly when we compare Reynolds's theatrical Mrs. Siddons as the Tragic Muse with the wonderful portrait of that marvelous woman by Gainsborough, so refined, so keenly intelligent, so vitally alive, that hangs in the London National Gallery, Sir Joshua appears indeed a poor second. But Reynolds is not often so insincere, and Gainsborough perhaps never again reached to such a height, so that the question of pre-eminence is not easy to decide.

In the Johnson collection Sir Joshua is represented by two fine examples, the Duchess of Ancaster and Viscount Hill, both handsome young aristocrats, painted with admirable skill and showing none of that deterioration too common in his pictures.

Gainsborough is still better represented.

The portrait of Lord Mulgrave, dressed as a naval officer, is one of his most important works. A large, distinguished-looking man in blue coat and white waistcoat, he stands out with intense vitality against a red curtain, while to the left we see a far-reaching and delightful English landscape.

Though he made his living painting portraits, Gainsborough was, at heart, a painter of landscapes; and whenever he could escape from the drudgery of portraiture, he sallied forth into the woods and fields, to depict the beauties of nature. Here he is a supreme master, as he is in portraiture. Unhappily he was compelled to paint these truant masterpieces rapidly, putting on one coat before its predecessor was entirely dry, so that they have cracked more than his portraits; but they are very beautiful and supremely attractive. In this one we have fine trees, between which is a splendid view of an extensive prospect bathed in the glow of sunset, the whole redolent with the charm of the English countryside. At the door of an humble thatched cottage stands a most beautiful and aristocratic woman evidently one of Gainsborough's most distinguished sitters. She is supposed to be the mother of the four children about her, who, how-

ever, are evidently drawn from peasant models. Gainsborough painted no more notable landscape, few larger, certainly none finer, none superior in composition or richer in color.

One of the best of the English landscape painters was the elder David Cox. He loved the gracious landscapes of his native land with all his heart, and reproduced them with the greatest care, usually in water color. He is here represented by a very characteristic work, *The Outskirts of a Wood in Autumn*. The trees are studied with admirable fidelity to nature, and with such attention to detail that each leaf can be counted.

It is the fashion these days rather to depreciate Sir Thomas Lawrence, but I am unable to share that view. He was the spoiled child of fortune, courted alike by men and women. Sometimes, overwhelmed by commissions and distracted by social pleasures, his work is superficial and insincere; but at his best he is worthy to stand beside the great masters of portraiture, and he is so often at his best that his failures may be ignored.

It is doubtful whether anyone save Lord Byron ever had a more intense appreciation of the beauty of women. They loved Sir Thomas, and he loved them perhaps overmuch; but to this intense feeling for woman's charms we owe some of the most delightful portraits ever painted.

Of Sir Thomas we have two splendid examples. Lord Abercorn, a high-born gentleman of refined and commanding presence, somewhat past middle life, stands out alive against a red curtain, while Mrs. Towry is the ideal of English beauty, with perfect and high-bred features that would be faultless in a cameo, but whose loveliness is enhanced by brilliant color, large blue eyes and rich chestnut hair. She represents the English aristocracy in its supreme perfection.

Romney was one of the most elegant and refined of English painters, though his infatuation for Lady Hamilton, of whom he painted innumerable portraits, was perhaps as injurious to his art as to his morals. He is shown in a faultless portrait of Sir Sampson Wright, a stout squire in a red coat.

But the gem of the British portraits is the work of the Scotchman Raeburn. He has given us the living presentment of his friend Archibald Skirving, who was a painter and a poet. In neither capacity did he attain distinction, but the pursuit of high ideals gave to his face a rare refinement and intelligence. He is growing old, and the gray locks are thin, but age has brought only a sweeter and a saner outlook on life. A more delightful portrait of an elderly and scholarly gentleman was never made, and we can see that affection guided the brush to this admirable result.

We should have begun our notice of the British painters of this group with Hogarth, the first and one of the greatest of them all. He was among the notable revolutionists. At a time when art had become over-refined and sugarsweet, when Watteau and Boucher ruled the hour, he turned from their exquisite but unreal creations to a strong, sane realism. He wrought in England a revolution as great as that which David wrought in France, but on a more enduring basis. David sought to turn back the hands of time, and to make Romans of us all; and by the force of his powerful genius he succeeded for a while. But a conception so fundamentally false could not long endure, and though David can never be forgotten, his influence is now negligible.

Hogarth, on the other hand, is the strong rock on which modern art has been built. In painting he is like Bach in music, the somewhat austere master at whose feet all have sat. In his own days it was his satires on the vices of society to which he owed his greatest fame. Now it is his admirable portraits, so realistic, so vitally alive, that interest us most.

One of his finest portraits is here; Mrs. Price, an alert, intelligent, high-bred woman, with head proudly erect, sure of herself and of her position, dressed in blue, and painted with a marvelous realism.

Among the greatest of the painters of classic landscape is Richard Wilson. To the sense of distance and the ineffable peace of Claude Lorraine, he adds the mellow afternoon light of Albert Cuyp or the splendid sunset glow of Jan Both. His pictures are poems in color. There are two of them here. The smaller and less important is in his more usual style. It depicts a landscape through which flows a river spanned by a bridge of five graceful arches, the whole bathed in the sunlight of a serene afternoon. The other is an unusual picture, and one of the most notable that Wilson ever painted. It is one of his largest landscapes. It presents a far-reaching prospect suffused by a splendid sunset glow. It is truly a symphony in gold and golden brown.

To my mind the greatest of all painters of landscape is Turner. Others may equal him in various aspects of his art, but none can compare with him in his variety. He comes nearer the universality of Shakespeare than any other landscape painter. He began with a painstaking realism equal to Constable's. Then he dared to rival Claude Lorraine, and in his *Crossing the Brook*, *Child Harold's Pilgrimage*, and the works inspired by the glories and decline of Carthage, he became a worthy competitor of that supreme master of classic landscape where over scenes of ideal beauty and illimitable spaciousness there broods a celestial peace. Then light and air fas-

minated Turner, and he presented their glories and their mystery with a splendor that makes the best of the impressionists seem cheap, and, as was fitting, he passed into another world when in this he had ceased to see anything save the blinding glory of light. In each aspect of his art he is without a superior, and in the breadth of his achievement he is without a rival. Compared with him, how pitifully narrow seem the great landscapists of France! When we have seen one Rousseau, one Daubigny, one Diaz, one Corot, we recognize the others at a glance; but Turner is limited only by nature's infinite variety.

The last painting in date in this remarkable collection is a view of Edinboro by Turner, one of his latest works, when his pictures had become dreams of light and air. The castle is there and the palace; but what we see is a dream of golden light.

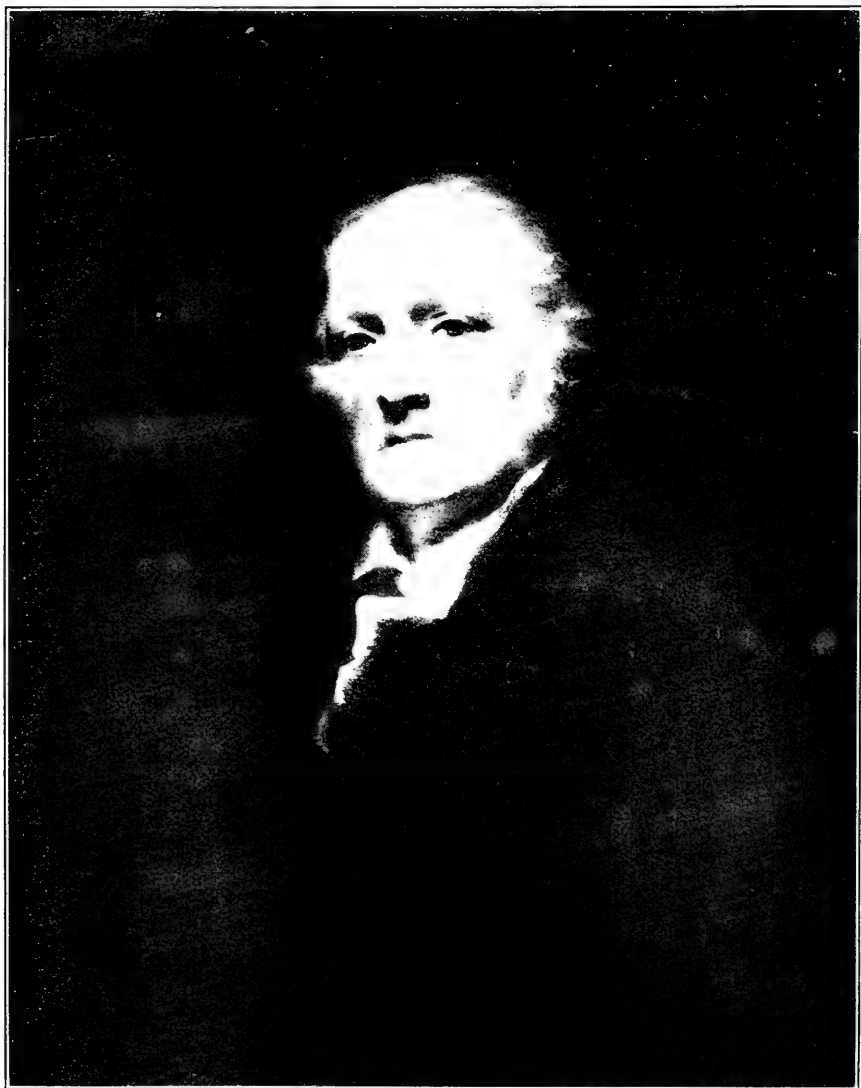

PORTRAIT OF ARCHIBALD SKIRVING, ESQ., BY SIR HENRY RAEBURN, R. A., 1756-1833,
BRITISH SCHOOL.



MADONNA AND CHILD, WITH ST. JOHN AND AN ANGEL, BY SEBASTIANO MAINARDI,
DIED 1513, FLORENTINE SCHOOL.



THE MYSTIC MARRIAGE OF ST. CATHERINE OF ALEXANDRIA, BY GIACOMO FRANCA, 1486-1557.
BOLOGNESE SCHOOL.

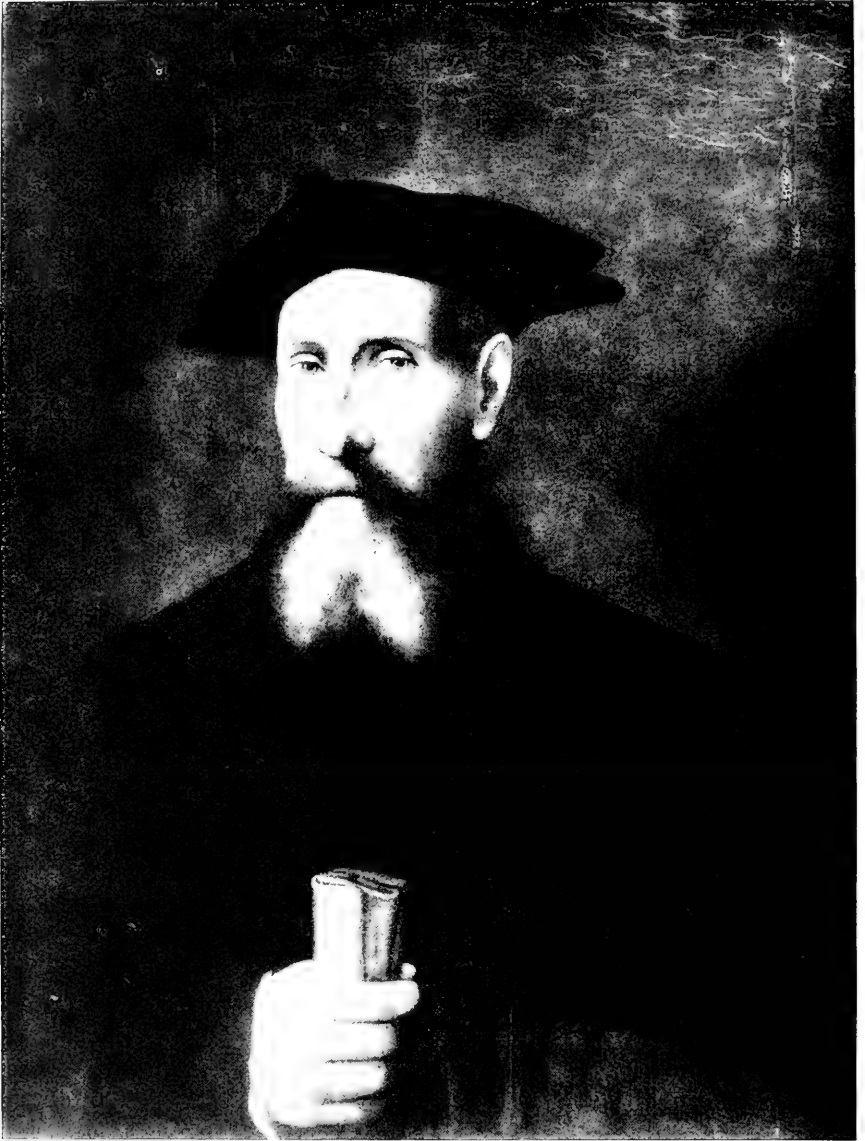

A VENETIAN SENATOR, BY LORENZO LOTTO, 1480-1554, VENETIAN SCHOOL.



PORTRAIT OF A CARDINAL, BY TITIAN, 1477-1576, VENETIAN SCHOOL.



LORD MULGRAVE, IN NAVAL UNIFORM, BY THOMAS GAINSBOROUGH, R. A., 1727-1788,
BRITISH SCHOOL.

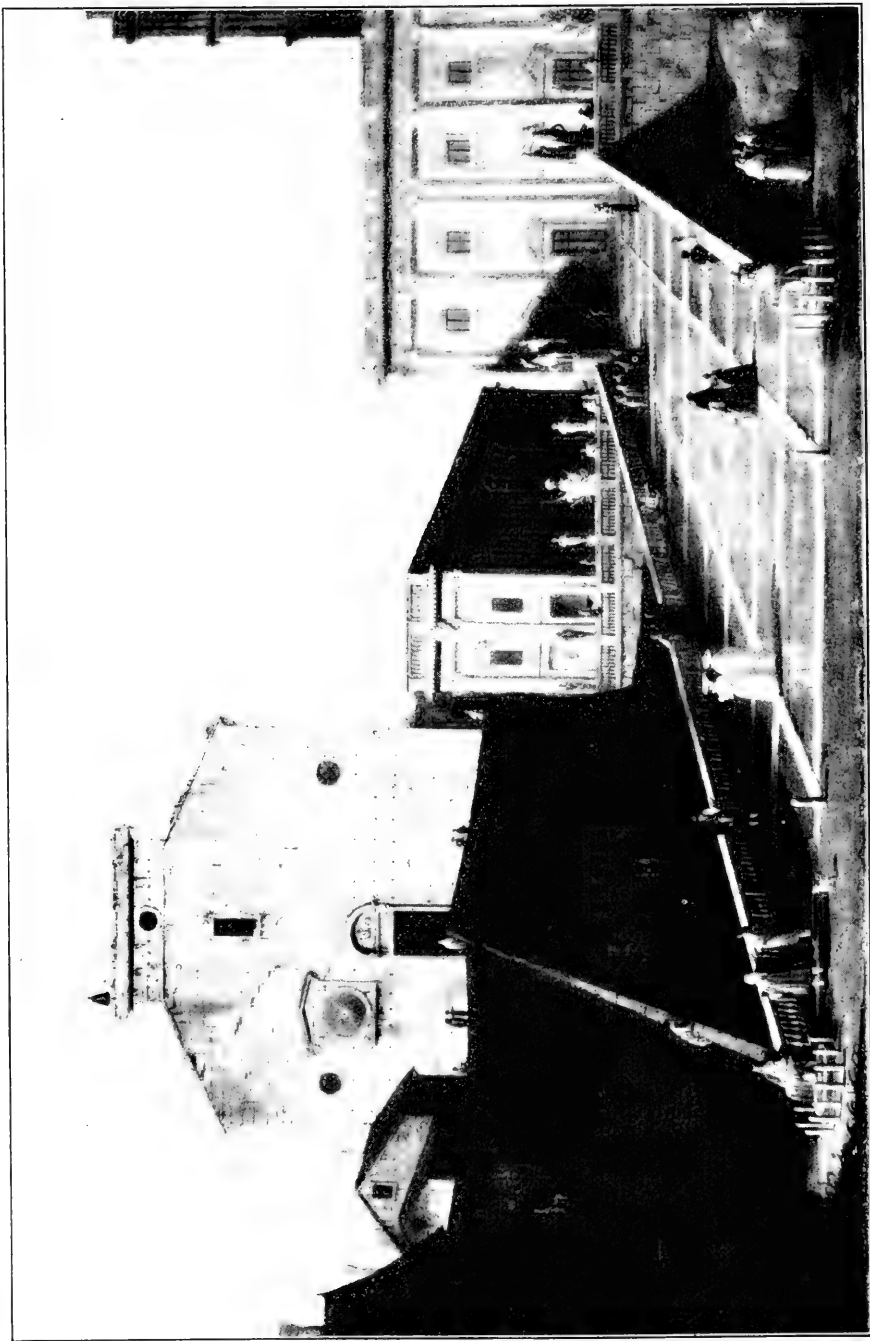

VIEW IN ROME, WITH THE CHURCH OF ARA COELI, BY FRANCESCO GUARDI, 1712-1793, VENETIAN SCHOOL.

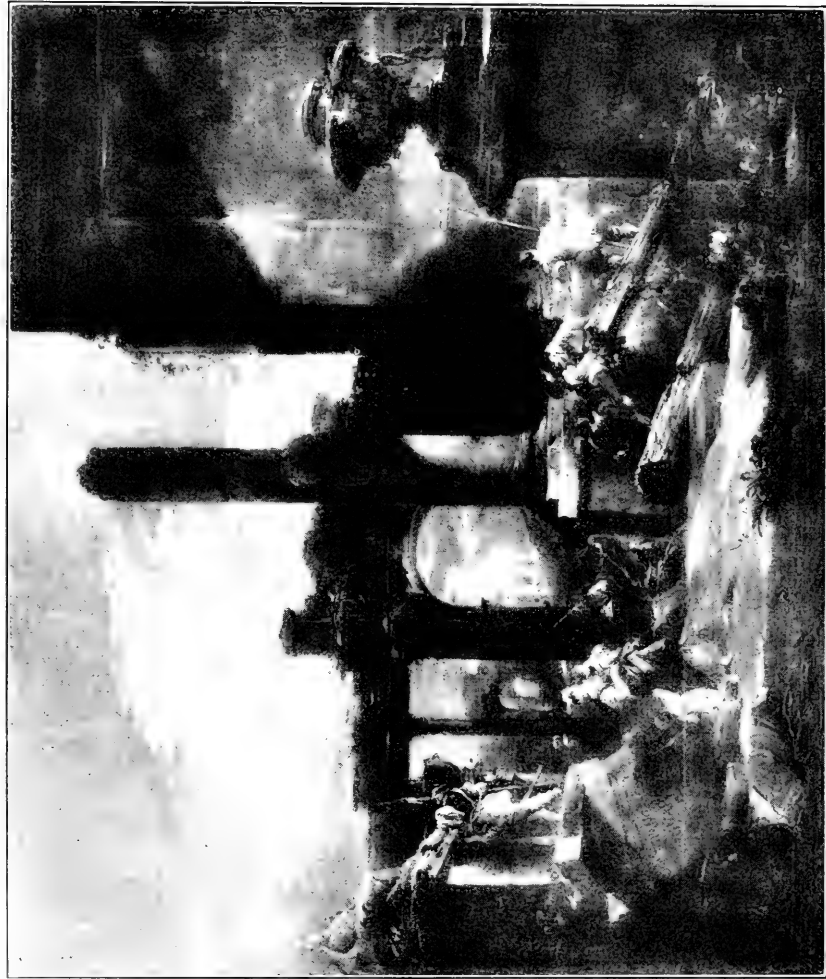

RUINS AND FIGURES, BY FRANCESCO GUARDI, 1712-1793, VENETIAN SCHOOL.



THE VIRGIN AND CHILD, BY BERNARD VAN ORLEY, 1493-1542, FLEMISH SCHOOL.



MADONNA AND CHILD, BY GOVAERT FLINCK, 1615-1660, DUTCH SCHOOL.



THE HOLY FAMILY, WITH ST. ELIZABETH, BY PETER PAUL RUBENS, 1577-1640,
FLEMISH SCHOOL.



PORTRAIT OF A MAN WEARING A LARGE HAT, BY REMBRANDT VAN RIJN, 1606-1669,
DUTCH SCHOOL.



A BURGOMASTER, BY NICHOLAAS MAES, 1632-1693, DUTCH SCHOOL.

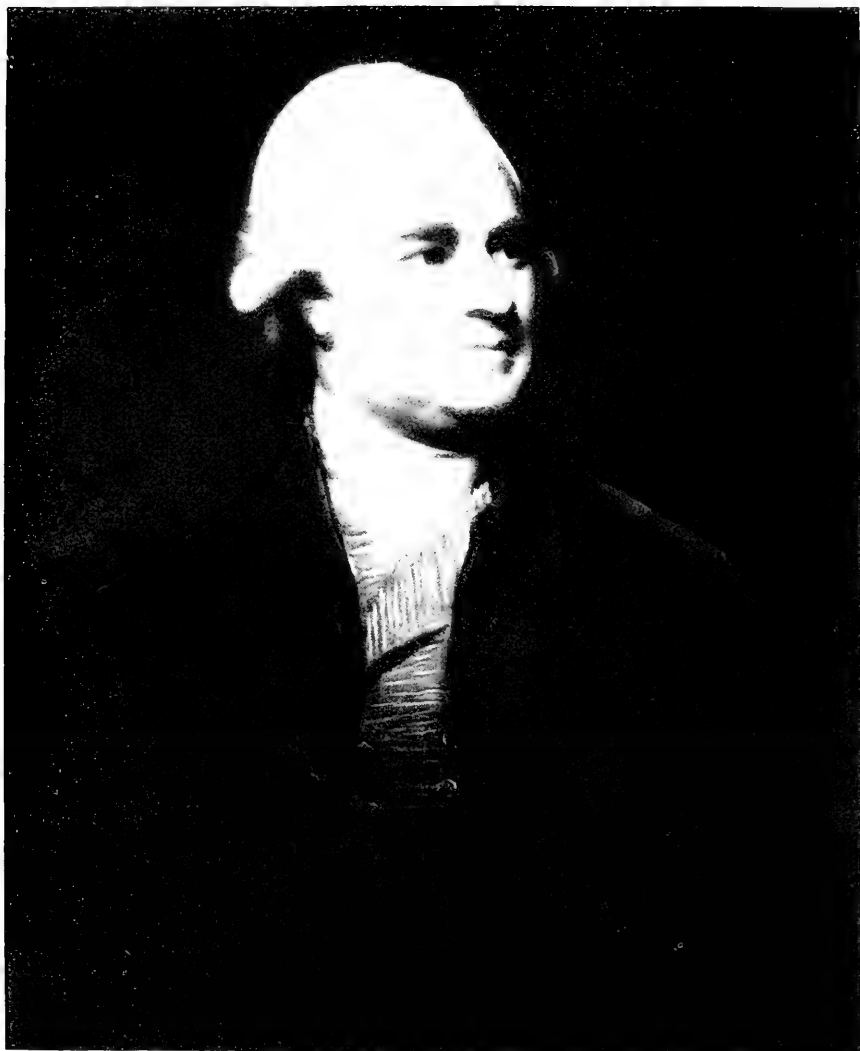

PORTRAIT OF SIR SAMPSON WRIGHT, BY GEORGE ROMNEY, 1734-1802, BRITISH SCHOOL.



THE DUCHESS OF ANCASTER, BY SIR JOSHUA REYNOLDS, P. R. A., 1723-1792,
BRITISH SCHOOL.



PORTRAIT OF VISCOUNT HILL, BY SIR JOSHUA REYNOLDS, P. R. A., 1723-1792,
BRITISH SCHOOL.



A FAMILY AT THE COTTAGE DOOR, BY THOMAS GAINSBOROUGH, R. A., 1727-1788,
BRITISH SCHOOL.

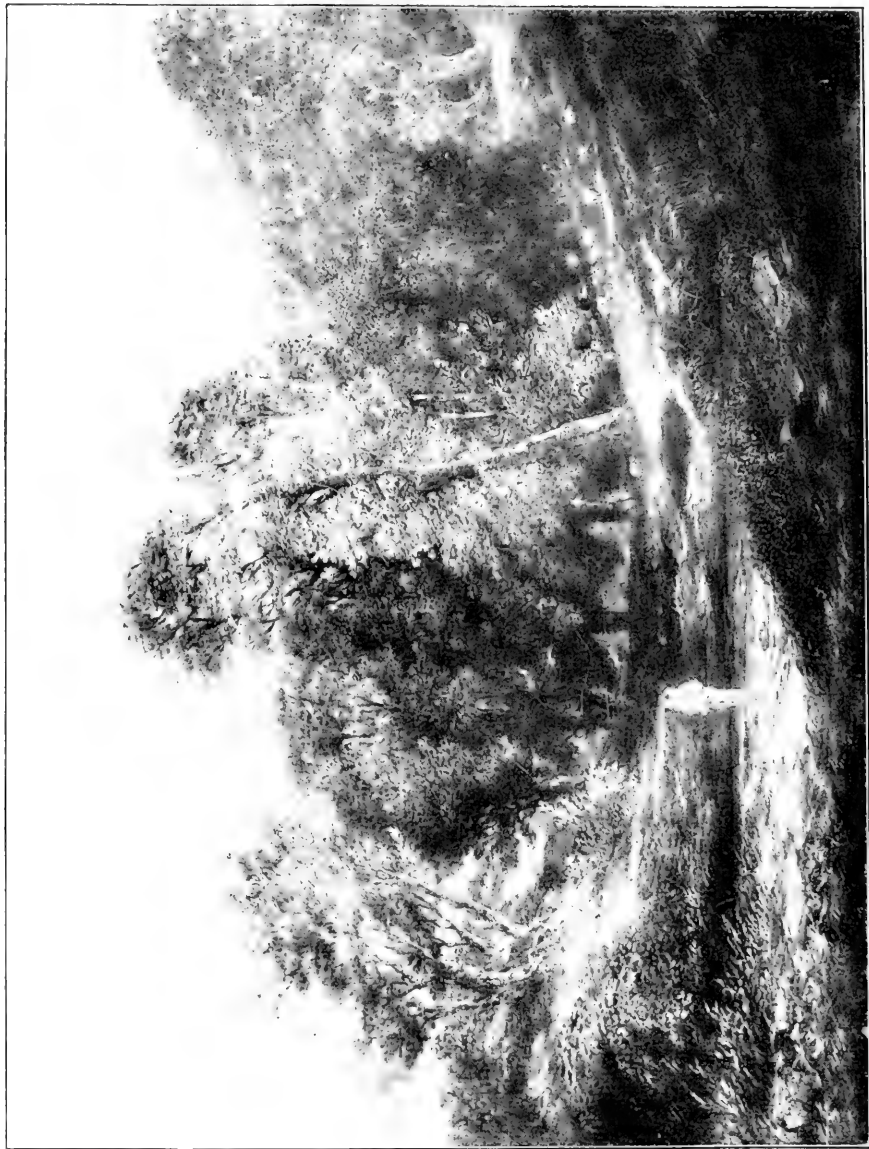

LANDSCAPE: OUTSKIRTS OF A WOOD, BY DAVID COX, 1783-1859, BRITISH SCHOOL.



SUMMER AFTERNOON ABOUT 4 P. M., BY RICHARD WILSON, R. A., 1714-1782, BRITISH SCHOOL.

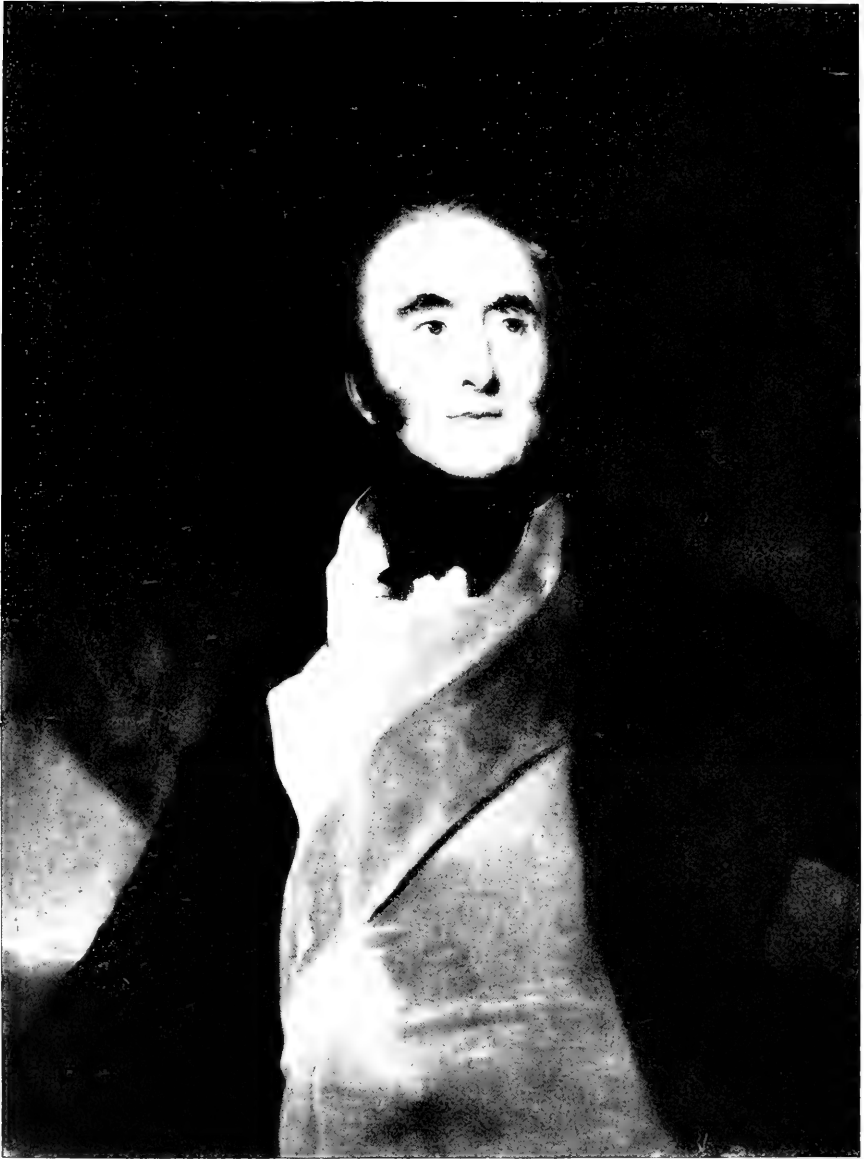

PORTRAIT OF LORD ABERCORN, BY SIR THOMAS LAWRENCE, P. R. A., 1769-1830,
BRITISH SCHOOL.



PORTRAIT OF MRS. TOWRY, BY SIR THOMAS LAWRENCE, P. R. A., 1769-1830,
BRITISH SCHOOL.



PORTRAIT OF MRS. PRICE, BY WILLIAM HOGARTH, 1697-1764, BRITISH SCHOOL.



GRAND ITALIAN LANDSCAPE; SUNSET GLOW, BY RICHARD WILSON, R. A., 1714-1782,
BRITISH SCHOOL.

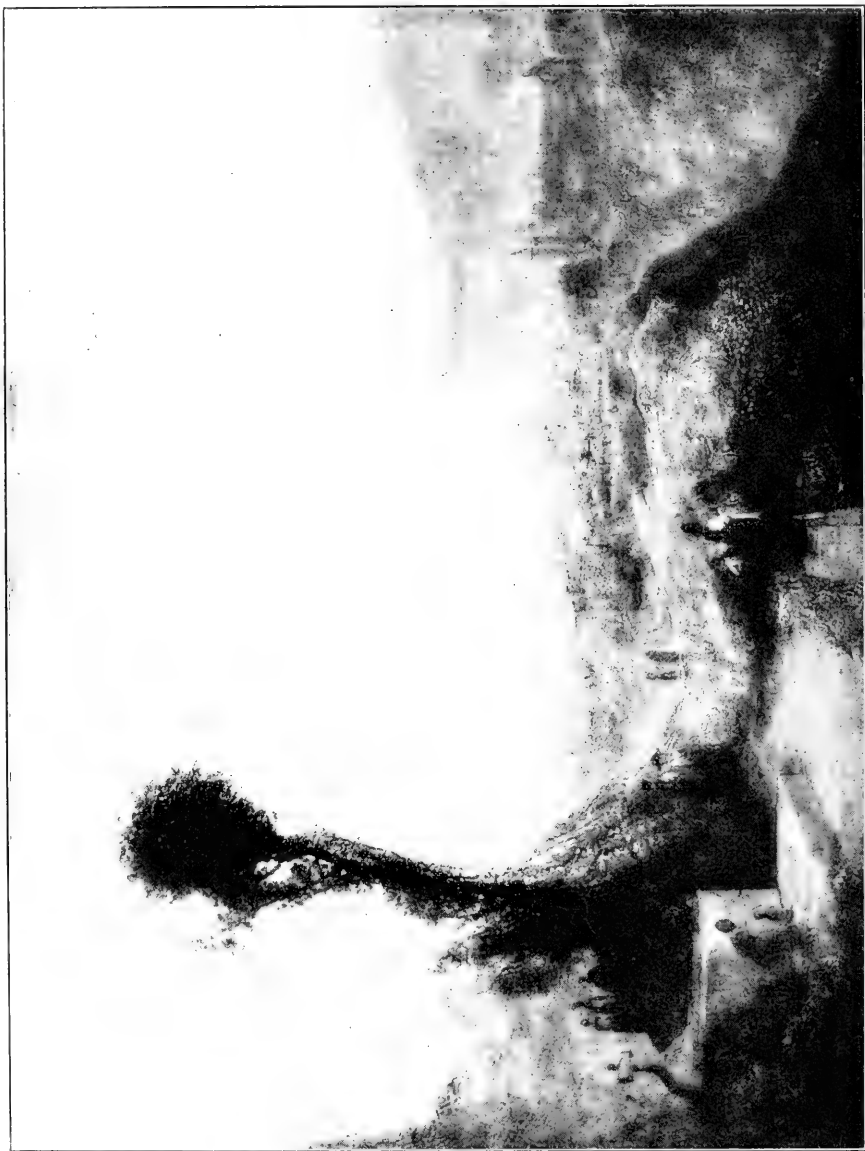

EDINBURGH; A PAINTING OF SUNLIGHT AND AIR, BY J. M. W. TURNER, R. A., 1775-1851, BRITISH SCHOOL.

INDEX.

	Page.
Abbot, Dr. C. G., Assistant Secretary of the Institution -----	11.
12, 26, 35, 84, 101, 103, 104, 105, 107, 128, 133, 134, 139, 145, 165, 223	223
(Studying the sun's heat on mountain peaks in desert lands)-----	145
(The habitability of Venus, Mars, and other worlds)-----	165
Abbott, Dr. W. L. -----	17, 21, 22, 23, 25, 31, 44, 134
Adams, W. I. -----	11, 12
Administrative assistant to the Secretary -----	12, 56
African expedition, Smithsonian -----	20
Agriculture, Secretary of (member of the Institution) -----	11
Agricultural pests, The local suppression of, by birds (McAttee) -----	411
Alburtis, Mrs. Susan Sipe -----	54
Aldrich, Dr. J. M. -----	12, 114
Aldrich, L. B. -----	12, 35, 101, 103, 104
Alexander, Joshua Willis, Secretary of Commerce (member of the Institution) -----	11
Allard, H. A.; Garner, W. W., and (Effect of the relative length of day and night on flowering and fruiting of plants) -----	569
Allotments for printing -----	28
American Chemical Society -----	50
American Historical Association, reports of the -----	27, 28, 117, 122
American Museum of Natural History -----	50
Ames, Oakes -----	25
Ångström, A. -----	103
Animal and vegetable products, collections of, National Museum -----	47
Annals of the Astrophysical Observatory -----	27, 34, 106, 117
Anthony, Susan B. -----	42
Anthropological collections, National Museum -----	43
Anthropological researches in the Far East -----	22
Appropriations, Smithsonian Institution and branches -----	18
Armstrong, Prof. Henry E. -----	109
Arnold Arboretum of Harvard University -----	25
Arts Club of Washington -----	55
Aschemeier, C. R. W. -----	20, 134
Assistant Secretary of the Institution -----	11,
12, 26, 35, 84, 101, 103, 104, 105, 107, 128, 133, 134, 139, 145, 165, 223	223
Aston, Dr. F. W. (Doctor Aston's experiments on the mass spectra of the chemical elements, with introduction by C. G. Abbot) -----	223
Astrophysical Observatory -----	12, 13, 18, 28, 34, 123
annals of the-----	27, 34, 106, 117
Director-----	12, 107
library-----	29, 115

Astrophysical Observatory—Continued.		Page.
personnel	-----	101, 106
report	-----	101
research work of the	-----	132
work of the year	-----	101
at Mount Wilson	-----	102, 104
at Washington	-----	101
in Arizona	-----	104
in Chile	-----	102, 105
the honeycomb pyranometer	-----	103
Attorney General (member of the Institution)	-----	11
Australian expedition	-----	21
Austrian Meteorological Association	-----	15
Avery bequest	-----	128
Avery fund	-----	17, 123

B.

Baines, Ernest Harold	-----	54
Baird fund, Lucy H	-----	17, 123
Baker, A. B., assistant superintendent of the National Zoological Park	-----	12
Baker, Newton Diehl, Secretary of War (member of the Institution)	-----	11
Barnes, Dr. William	-----	45
Bartsch, Dr. Paul	-----	12, 54
Bassler, Dr. R. S	-----	12, 19, 20, 26
(The Bryozoa, or moss animals)	-----	339
Bates, Mrs. Lindon W	-----	89, 135
Beck, Herbert H. (The occult senses in birds)	-----	439
Bell, Dr. Alexander Graham (Regent)	-----	11, 14, 127, 139
Belote, T. T	-----	12
Benjamin, Dr. Marcus, editor of the National Museum	-----	12, 120
Bigelow, Dr. H. B	-----	45
Biological collections, National Museum	-----	44
Birds, The local suppression of agricultural pests by (McAtee)	-----	411
Birds, The occult senses in (Beck)	-----	439
Board of Regents of the Institution	-----	11, 13
annual meeting	-----	127
executive committee, report	-----	123
permanent committee, report	-----	128
proceedings of	-----	127
Boas, Franz	-----	72
Botanical expedition to British Guiana	-----	23
Botanical exploration—		
in Glacier National Park, Mont	-----	24
in Haiti	-----	22
in Jamaica	-----	25
Botanical gardens of Jamaica, the (Maxon)	-----	523
Botanical Museum of the University at Copenhagen	-----	45
Boughton, Frederick	-----	27
Boving, Dr. A. J	-----	114
Breckenridge, Gen. Joseph C	-----	43
Brigham, Edward M	-----	69
British Guiana, botanical expedition to	-----	23
Brockett, Paul, assistant librarian of the Institution	-----	11, 116

	Page.
Brooke, Maj. Gen. John R.....	30, 42, 114
Brookings, Robert S. (Regent).....	11, 14, 127
Brown, Stephen C., Registrar of the National Museum.....	36, 37
Brush, George de Forest.....	136
Bryant, H. S., chief of correspondence and documents, National Museum.....	12
Bryozoa, or moss animals, the (Bassler).....	339
Buck, Joshua.....	62
Buildings and equipment, National Museum.....	51
Burleson, Albert Sidney, Postmaster General (member of the Institution).....	11
Burt, William Austin.....	48
Bushnell, David I., jr.....	61, 67

C.

Canadian Rockies, geological exploration in the.....	19
Capital Audit Co.....	125
Carnegie Corporation of New York.....	108
Carnegie Foundation.....	139
Carty, Dr. John J.....	54
Casanowicz, Dr. I. M.....	26
Caudell, A. N.....	114
Caullely, Maurice (Parasitism and symbiosis in their relation to the problem of evolution).....	399
Chamberlain fund.....	17, 123
Chancellor of the Institution.....	11, 14, 127
Charles, Abram.....	62
Chemistry Bureau, Department of Agriculture.....	51
Chemistry of the earth's crust, the (Washington).....	269
Chemist's Club of New York.....	50, 51
Chief, Bureau of American Ethnology.....	12, 26, 29, 43, 68, 71, 72
Chief Clerk of the Institution.....	11
Chief Justice of the United States (member of the Institution).....	11, 13, 14
Chief of correspondence and documents, National Museum.....	12
China Museum of Natural History.....	22
Choate, Charles F., jr. (Regent).....	11, 14
Cinchona Botanical Station.....	25, 26
Clapp, William F.....	45
Clark, Austin H.....	12, 26, 38, 114
Clark, B. Preston.....	45
Clarke, F. W.....	12
Clayton, H. H.....	103, 133
Clements, J. Morgan.....	46
Cohen, Bertha.....	43
Colby, Bainbridge, Secretary of State (member of the Institution).....	11
Collections:	
Bureau of American Ethnology.....	71
National Museum.....	38
Collins-Garner French Congo expedition.....	20, 31
Colonial Dames, National Society of the.....	41
Colver, Hon. William B.....	54
Commerce, Secretary of (member of the Institution).....	11
Commercial Museum of Philadelphia.....	44
Committee on printing and publication.....	28, 122

	Page.
Consolidated fund.....	16, 128
Copenhagen University, Botanical Museum of the.....	45
Corbacho, Señor Don Jorge M.....	27
Costello, J. E.....	42
Coville, Dr. F. V.....	12
Crane Lithograph Co.....	44
Crystals, The determination of the structure of (Wyckoff).....	199
Curator of the National Gallery of Art.....	12
Curators of the National Museum.....	12
Curtis, Dr. Heber D.....	53
Curtis, Lieut. E.....	40
Cushing, Capt. Otho.....	55

D.

Dall, Dr. William H.....	12, 43, 114
Dances, music, and songs of the ancient and modern Mexicans, Notes on the (Genin).....	657
Danforth, Prof. R. E.....	27
Daturas of the old world and new: An account of their narcotic properties and their use in oracular and initiatory ceremonies (Safford).....	537
Daughters of the American Revolution, National Society of the, report.....	122
Denmark, C. R.....	12
Densmore, Frances.....	66
De Peyster collection, Smithsonian library.....	29, 114
Devereux, Mrs. J. Ryan.....	44
De Vries, Dr. S. G.....	76
Dewing, T. W.....	136
Dinosaurs, the horned (Gilmore).....	381
Disbursing agent of the National Museum.....	12
Dorsey, Harry W., chief clerk of the Institution.....	11
Duchess of Marlborough.....	49
Dwyer, Mrs. Thomas F.....	43

E.

Earl of Chatham (William Pitt).....	49
Earth's crust, The chemistry of the (Washington).....	269
Editors of the Institution and its branches.....	11, 12, 69, 121, 122
Elliott, Lieut. Col. Duncan.....	43
Ellman, Lieut. T. N.....	42
Elston, Representative John A. (Regent).....	11, 14
Establishment, The Smithsonian.....	13
Ethnology, Bureau of American.....	12, 13, 18, 28, 30, 31, 121, 123, 135
collections.....	71
library.....	32, 70, 115
manuscripts.....	68
publications.....	27, 28, 32, 69, 70, 117
report.....	57
special researches.....	65
staff.....	12
Evans, Admiral Robley D.....	89
Evolution, Parasitism and symbiosis in their relation to the problem of (Caullery).....	399
Exchanges, international.....	12, 13, 18, 28, 32, 123
report.....	73

	Page.
Executive committee of the Board of Regents of the Institution-----	11
report-----	123
Exhibition of South American historical documents-----	27
Expeditions, Smithsonian-----	134
African-----	20, 134
Borneo—Celebes—Australian-----	21, 134
Collins-Garner French Congo-----	20, 134
Saskatchewan-----	19, 134
Explorations in Santo Domingo-----	25

F.

Fairbanks, Hon. Charles Warren (Regent)-----	127
Far East, anthropological researches in the-----	22
Fenollosa, Prof-----	137
Ferris, Representative Scott (Regent)-----	14
Fewkes, Dr. J. Walter, Chief, Bureau of American Ethnology-----	12,
26, 29, 43, 68, 71, 72	
(Fire worship of the Hopi Indians)-----	589
Fiddler crab, Adventures in the life of a (Hyman)-----	443
Field, Cyrus W.-----	42
Field Museum of Natural History-----	25
Finances of the Institution-----	16, 139
Finley, Dr. William L-----	54
Fire worship of the Hopi Indians (Fewkes)-----	589
Fisher, Anna-----	49
Fisher, Prof. Irving-----	55
Flattely, F. W. (Rhythm in nature)-----	389
Flowering and fruiting of plants, Effect of the relative length of day and night on (Garner and Allard)-----	569
Foerste, Dr. August F.-----	20
Fonch, M-----	40
Foreign depositories of United States governmental documents-----	78
Foreign exchange agencies-----	82
Forestry commission of the Mexican State of Sinaloa-----	45
Fowke, Gerard-----	43, 68, 71
Fowle, F. E., jr-----	12, 101
Freer, Charles Lang-----	30, 49, 50, 135, 138
collections-----	15, 49, 135
Gallery of Art-----	30, 137
fund-----	128
will-----	137
French Congo expedition, Collins-Garner-----	20

G.

Garfield, Mrs. James A-----	42
Garner, W. W., and Allard, H. A. (Effect of the relative length of day and night on flowering and fruiting of plants)-----	569
Gay, Abbé Jo. Pedro-----	68
General considerations, Secretary's report-----	14
Genin, Auguste (Notes on the dances, music, and songs of the ancient and modern Mexicans)-----	657
Geological collections, National Museum-----	45
Geological exploration in the Canadian Rockies-----	19

	Page.
Geological Survey, United States.....	31, 46
Giant suns (Turner).....	173
Gibson, John Arthur.....	62
Gidley, J. W.....	26
Gilbert, C. G.....	48
Gill, De Lancey.....	12, 70
Gilmore, C. W.....	12, 26
(The horned dinosaurs).....	381
Glacier National Park, botanical exploration in.....	24
Goddard, Prof. Robert H.....	15, 128
Goldsmith, J. S., superintendent of buildings and labor, National Museum.....	12
Grants from Hodgkins fund.....	15, 16
Granville-Smith, W., N. A.....	49
Gray, Hon. George (Regent).....	11, 14, 126, 127, 128
Gray Herbarium of Harvard University.....	23, 25
Greene, Representative Frank L. (Regent).....	11, 14, 127
Gregory, Alexander.....	86
Gunnell, Leonard C., assistant in charge, United States Regional Bureau, International catalogue of scientific literature.....	12, 111
Guthnick, Dr. Paul.....	34, 102
Guynemer, M.....	40

H.

Habel fund.....	17
Habitability of Venus, Mars, and other worlds, The (Abbot).....	165
Haiti, botanical exploration in.....	23
Hale lecture, William Ellery.....	53
Halliburton, W. D. (Vitamins).....	241
Hamilton fund.....	17, 123
lecture.....	26, 54
Hamilton, Rev. James.....	26
Harrington Alaska expedition, reports on the.....	27, 117
Harrington, John P.....	12, 64, 65
Harrison, Prof. J. B.....	24
Hassam, Childe.....	136
Hathaway, George A.....	44
Hay, Dr. O. P.....	46, 114
Heller, Edmund.....	20, 134
Henderson, John B. (Regent).....	11, 45, 127
Henry, Miss Caroline.....	30, 42
Henry, Joseph, first Secretary of the Institution.....	30, 42
Hess, Frank L.....	46
Hewitt, J. N. B.....	12, 62, 63
Heyermans, Dr. H. H. R. Roelofs.....	76
Hibbs, J. G.....	46
Hill, Asa R.....	64
Hill, J. H., property clerk of the Institution.....	11
Hitchcock, Dr. A. S.....	23
Hittinger, Capt. J. J.....	42
Hodgkins fund—	
general.....	15, 17, 123, 128, 133
specific.....	17
Hollis, Senator Henry French (Regent).....	14, 127

	Page.
Hollister, Ned, superintendent of the National Zoological Park	12, 29, 100
Holman, George E	89
Holmes, Dr. William H	12, 16, 29, 49, 114
Homer, Winslow	136
Homestake Mining Co	46
Hopi Indians, Fire worship of the (Fewkes)	589
Hore, A. T. S	86
Horned dinosaurs, The (Gilmore)	381
Hough, Dr. Walter	12, 26, 37, 43, 72, 114
(Racial groups and figures in the Natural History Building of the United States National Museum)	611
Houston, David F., Secretary of the Treasury (member of the Institution)	11
Howard, Dr. L. O	12
Howe, Dr. H. E	55
Hoy, Charles M	21, 31, 44, 134
Hrdlička, Dr. Aleš	12, 15, 22, 43
Hubby, Ella F	43
Huckel, Earle W	44
Hughes Alcove	128
Hughes, Bruce, bequest	128
Hughes, Bruce, fund	17, 123
Humphreys, W. J. (A bundle of meteorological paradoxes)	183
Hyman, O. W. (Adventures in the life of a fiddler crab)	443

I.

Iddings, Dr. J. P	46
Insect societies, The origin of (Lameere)	511
Insects, the senses of (McIndoo)	461
Interior, Secretary of the (member of the Institution)	11
International catalogue of scientific literature, Regional bureau for the United States	12, 13, 18, 28, 35, 36, 123
assistant in charge	12, 111
report	108
International exchanges	12, 13, 18, 28, 32, 123
report	73
Interparliamentary exchange of official journals	81

J.

Jamaica, botanical exploration in	25
Jamaica, botanical gardens of, The (Maxon)	523
Jamaica, Government of	26
Jeancon, J. A	68, 72
Jefferson, Rev. Charles E., D. D	26, 54
Jefferson, Thomas	43
Jepson, Capt. E. W	42
Johnson, Ralph Cross, collection in the National Gallery at Washington, D. C., The (Rose)	679
Jones, Stockton W	44
Jones, Senator Wesley L	48
Joseph, E. S	89
Judd, Neil M	12, 26, 43, 65, 71

K.

	Page.
Kelly, Mrs. Florence	54
Kent, William	43
Killip, E. P.	25, 27
Kirk, Edward B	86, 135
Kline, Miss	43
Knab estate	114
Knowles, W. A	12
Knowlton, Dr. F. H	114
Kroeber, Dr. A. L	63
Kurz, Friedrich	61

L.

Labor, Secretary of (member of the Institution)	11
La Flesche, Francis	12, 64
Lameere, Auguste (The origin of insect societies)	511
Land and sea oscillations, Major causes of (Ulrich)	321
Langford, J. B	45
Langley, S. P., third secretary of the Institution	36
La Varre, W. J. jr	85
Leary, Ella	12, 70
Lectures	26
for the Y. M. C. A	26
Length of day and night, Effect of the relative, on flowering and fruiting of plants (Garner and Allard)	569
Leonard, Emery C	22, 23
Lewton, F. L	12, 37, 41
Library of Congress	29, 112, 113, 114, 116
Smithsonian deposit in	29, 112, 116
Libraries of the Smithsonian Institution and branches	13, 29, 31, 32, 112
accessions	116
aeronautical collection	114
Astrophysical Observatory library	29, 115
De Peyster collection	29, 114
employees' library	114
Ethnology, Bureau of American, library	32, 70, 115
Museum library	55, 114
National Zoological Park library	116
reading room, Smithsonian building	114
report	112
Smithsonian main library	112
Smithsonian office library	112
Lincoln Motor Co	48
Linton, Ralph	59
Little, Dr. W. C	26
Lodge, Senator Henry Cabot (Regent)	11, 14, 127, 128, 129
Loeb, Prof. Morris	50
bequest	50
collection of chemical types	51
fund	51
Lowe, E. B	44

M.

	Page.
Mallery, Otto T.....	43, 68, 72
Mann, Dr. W. M.....	45, 86
Marlborough, Duchess of.....	49
Mars, Venus, and other worlds, The habitability of (Abbot).....	165
Marshall, Thomas R., Vice President of the United States (Regent and member of the Institution).....	11, 13, 14, 127
Marvin, Charles F., Chief, Weather Bureau.....	104, 105
Maryland Geological Survey.....	46
Mass spectra of the chemical elements, Doctor Aston's experiments on (Introduction by C. G. Abbot).....	223
Maxon, W. R.....	12, 25, 27, 114
(The botanical gardens of Jamaica).....	523
McAtee, W. L. (Local suppression of agricultural pests by birds).....	411
McClellan, Maj. Gen. George B.....	30
McClung, Dr. C. E.....	55
McCormick, Senator Medill (Regent).....	11, 14, 127
McIndoo, N. E. (The senses of insects).....	461
McLanahan, Capt. H.....	40
McLaren, Maj. John.....	42
Mechanical technology, collections in the division of, National Museum.....	48
Medicine, collections in the division of, National Museum.....	47
Meetings, congresses, and lectures, National Museum.....	31, 53
Melchers, Gari.....	136
Members of the Institution.....	11
Mendenhall, Dr. C. E.....	104
Menelik, Emperor.....	90
Meredith, Edwin Thomas, Secretary of Agriculture (member of the Institution).....	11
Merrill, Dr. George P.....	12, 29
Metcalf, Willard L.....	136
Meteorological paradoxes, A bundle of (Humphreys).....	183
Mexicans, ancient and modern, Notes on the dances, music, and songs of (Genin).....	657
Michelson, Dr. Truman.....	12, 65
Miller, Dr. Gerrit S., jr.....	12
Mineral technology, collections in the division of, National Museum.....	48
Mitchell, Capt. J.....	40
Mitman, Carl W.....	12, 26
Molybdenum Mines Co.....	46
Mooney, James.....	12, 61
Mooradian, Capt. A. P.....	42
Morgan, Arthur E.....	20
Muir, John M.....	71
Munroe, Helen.....	70
Murphy, J. Francis.....	136
Muybridge, Edward.....	44
Myer, W. E.....	43, 68, 69

N.

National Academy of Sciences—	
annual meeting.....	53
building.....	139

	Page.
National Art Commission.....	138
National Gallery of Art..... 12, 16, 29, 80, 36, 49, 50, 129, 130,	137
National Lead Co.....	48
National Museum..... 12, 13, 18, 28, 29	30, 38
accessions.....	38
collections.....	38
library..... 29, 31, 56, 114, 115	115
meetings, congresses, and lectures.....	31, 53
needs.....	56, 129
publications..... 27, 28, 31, 56, 117, 120	120
report.....	37
visitors.....	31, 56
war collections.....	130
National Park Service..... 24, 32, 58, 59	59
National Research Council.....	27
National Society of the Colonial Dames.....	41
National Zoological Park..... 12, 13, 18, 28, 33, 123, 135	135
accessions.....	85, 135
animals in the collection.....	91
attendance.....	135
important needs.....	99
improvements.....	98
library..... 29, 115	115
removals.....	89
report.....	85
visitors.....	97
Navy Department..... 30, 38, 39	39
Navy, Secretary of the (member of the Institution).....	11
Necrology.....	36
Newhouse, Seth.....	64
New York Botanical Garden..... 23, 25, 45	45

O.

Occult senses in birds, The (Beck).....	439
Oersted, Dr.....	45
Olmsted, Arthur J.....	12
Other worlds, The habitability of Venus, Mars, and (Abbot).....	165

P.

Padgett, Representative Lemuel P. (Regent)..... 11, 14, 127	127
Paleontological field work.....	19
Palmer, A. Mitchell, Attorney General (member of the Institution).....	11
Pan American Congress.....	27
Pan American Financial Conference, Bolivian delegates to.....	46
Parasitism and symbiosis in their relation to the problem of evolution (Caullery).....	399
Patterson, M. L.....	46
Payne, John Barton, Secretary of the Interior (member of the Institu- tion).....	11
Pearce, Prof. J. E..... 43, 67, 71	71
Peking Union Medical College.....	22
Pell, Rev. Alfred Duane.....	49

	Page.
Pennell, Dr. Francis W.....	45
Philips Academy, Andover, Mass.....	46
Pikler, Dr. Julius.....	82
Poore bequest.....	128
Poore, Lucy T. and George W., fund.....	17, 123
Postmaster General (member of the Institution).....	11
Potomac Electric Power Co.....	52
Poweshiek, Horace.....	65
Pratt, Herbert.....	138
President of the United States (member of the Institution).....	11, 13, 129
Printing, allotments for.....	28
Printing and publication under the Smithsonian Institution, advisory committee on.....	28, 122
Proceedings of the Board of Regents of the Institution.....	127
Publications of the Institution and branches.....	13, 27, 28, 31, 32, 55, 69
distribution of.....	117
report.....	117
Purinton, C. W.....	46
Putnam, Dr. Herbert.....	77

R.

R. & S. Molybdenum Co.....	46
Racial groups and figures in the Natural History Building of the National Museum (Hough).....	611
Raezer, Lieut. John J.....	131
Ralph Cross Johnson collection in the National Gallery at Washington, D. C. (Rose).....	679
Ranger, Henry W., fund.....	49
Rathbun, Dr. Mary J.....	114
Rathbun, Dr. Richard.....	49
Raven, H. C.....	20, 21, 134
Ravenel, W. de C., administrative assistant to the Secretary.....	12, 56
Reed, R. Luther.....	36
Regents of the Institution, Board of.....	11, 13
annual meeting.....	127
executive committee, report.....	123
permanent committee, report.....	128
proceedings of the.....	127
Reid fund, Addison T.....	17, 123
Report of the Secretary of the Institution.....	13
Research in tropical America.....	27
Researches and explorations.....	18
Resplendent shield-bearer and the ribbed-cocoon-maker: two insect inhabitants of the orchard, The (Snodgrass).....	485
Rhees fund.....	17, 123
Rhoades, Katherine N.....	15, 137
Rhythm in nature (Flattely).....	389
Ribbed-cocoon-maker, The resplendent shield-bearer and: two insect inhabitants of the orchard (Snodgrass).....	485
Richmond, Dr. Charles W.....	12, 114
Rickenbacker, Edward Vernon.....	40
Ridgway, Dr. Robert.....	12

	Page.
Ritschel, William, N. A.....	49
Rivers, Dr. W. H. R.....	54
Roebing, John A.....	17, 35, 105, 106
Rogers, Maj. Gen. H. L.....	42, 131
Roosevelt, Col. Theodore.....	20, 90
Rose, George B. (The Ralph Cross Johnson collection in the National Gallery at Washington, D. C.).....	679
Rose, Dr. J. N.....	12
Royal Society of London.....	108, 111
Rusby, Prof. Henry H.....	45

S.

Safford, W. E. (Daturas of the old world and new: an account of their narcotic properties and their use in oracular and initiatory ceremonies).....	537
Saint Gaudens, Augustus.....	136
Sanford fund, George K.....	17, 123
Santo Domingo, explorations in.....	25
Sargent, John S.....	136
Sasaki, Mr.....	45
Schaus, William.....	114
Schmitt, Waldo L.....	12
Schofield, W. E., N. A.....	49
Schwartz, Dr. E. A.....	45
Scidmore, Eliza Rubamah.....	44
Scudder, N. P.....	12
Searles, Stanley, editor, Bureau of American Ethnology.....	12, 69, 121
Secretary of the Institution.....	3,
11, 12, 36, 55, 56, 72, 84, 100, 107, 111, 113, 114, 116, 122, 127, 134, 135	
report.....	129
supplemental statement.....	129
Senses of insects, The (McIndoo).....	461
Seton, Ernest Thompson.....	89
Sewall, S.....	40
Shantz, Dr. H. L.....	20
Shapley, Dr. Harlow.....	53
Shoemaker, C. W., chief clerk, international exchanges.....	12, 84
Sinaloa, Mexican State of, Forestry Commission.....	45
Smith, Joseph S.....	136
Smithson fund.....	17, 123
Smithson, James.....	13
Smithsonian advisory committee on printing and publication.....	28, 122
Smithsonian African expedition.....	20, 134
Smithsonian annual reports.....	27, 28, 117, 118
Smithsonian Contributions to Knowledge.....	27
Smithsonian expeditions.....	134
African.....	20, 134
Borneo—Celebes—Australian.....	21, 134
Collins-Garner, Congo.....	20, 134
Saskatchewan.....	19, 134
Smithsonian library.....	13, 29
report.....	112
Smithsonian meteorological tables.....	28
Smithsonian Miscellaneous Collections.....	27, 28, 117

	Page.
Smithsonian solar observing station:	
Calama, Chile.....	15, 35
Mount Harqua Hala, Ariz.....	35
Snodgrass, R. E. (The resplendent shield-bearer and the ribbed-cocoon-maker: two insect inhabitants of the orchard).....	485
Soil acidity—its nature, measurement, and relation to plant distribution (Wherry).....	247
Solar observing station, Smithsonian:	
Calama, Chile.....	15, 35
Mount Harqua Hala, Ariz.....	35
South American historical documents, exhibit of.....	27
Special researches, Bureau of American Ethnology.....	65
Speck, Frank S.....	68
Spence, Dr. George.....	68
Spencer, Mrs. Samuel.....	86
Spier, George W.....	48
Standley, Paul C.....	24
State, Secretary of (member of the Institution).....	11
Stejneger, Dr. Leonhard.....	12, 29
Stevens, Elizabeth S.....	43
Structure of crystals, The determination of the (Wyckoff).....	199
Stubbs, Sergt. Burns A.....	42
Studying the sun's heat on mountain peaks in desert lands (Abbot).....	145
Sun's heat on mountain peaks in desert lands, studying the (Abbot).....	145
Suns, giant (Turner).....	173
Superintendent of the National Zoological Park.....	12, 29, 100
Suppression of agricultural pests by birds, Local (McAtee).....	411
Swales, B. H.....	17, 31, 44
Swanton, Dr. John R.....	12, 61, 62
T.	
Textiles, collections in the division of, National Museum.....	47
Thaanum, D.....	45
Thayer, Abbott H.....	136
Thomas, Senator Charles S. (Regent).....	11, 14
Thompson, Dr. J. M.....	27
Treasury Department, United States.....	52
Treadwell, Dr. A. L.....	45
Treasury, Secretary of the (member of the Institution).....	11
Tropical America, research in.....	27
True, W. P. editor of the Institution.....	11, 29, 122
Tryon, Dwight W.....	136
Turner, Prof. H. H. (Giant suns).....	173
Twachtman, J. H.....	136
U.	
Ulrich, E. O. (Major causes of land and sea oscillations).....	321
Universal Film Manufacturing Co.....	20, 44, 134
University at Copenhagen, Botanical Museum of the.....	45
University of Illinois.....	25
V.	
Venus, Mars, and other worlds, The habitability of (Abbot).....	165
Verwyst, Father Chrysostom.....	63, 69

	Page.
Vice President of the United States (Regent and member of the Institution)-----	11, 13, 14, 127
Vitamins (Halliburton)-----	241

W.

Walcott, Dr. Charles D., Secretary of the Institution-----	3,
11, 12, 36, 55, 56, 72, 84, 100, 107, 111, 113, 114, 116, 122, 127, 134, 135	
report-----	13
supplemental statement-----	129
War collections, National Museum-----	39, 130
War Department, United States-----	30, 38, 39, 47, 52, 61
War Risk Insurance, Bureau of-----	51, 129
War, Secretary of (member of the Institution)-----	11, 52
Warren, Lieut. Commander L. P.-----	39
Washington, Dr. Henry S. (The chemistry of the earth's crust)-----	269
Wetmore, Alexander-----	15
Wherry, Dr. Edgar T. (Soil acidity—its nature, measurement, and relation to plant distribution)-----	247
Whistler, James McNeill-----	136
White, David-----	12
White, Edward Douglass, Chief Justice of the United States (Chancellor and member of the Institution)-----	11, 13, 14, 127
White, Henry (Regent)-----	11, 14, 126, 128, 138
Wiener, Capt. Clarence L.-----	43
Williams, Mrs. Talcott-----	43
Wilson, William Bauchop, Secretary of Labor (member of the Institution)-----	11
Wilson, Woodrow, President of the United States (member of the Institution)-----	11, 13, 129
Wilson, Mrs. Woodrow-----	42
Windle, Sir Bertram-----	54
Wood, Francis Derwent-----	49
Wood technology, collections of the section of, National Museum-----	47
Worcester Salt Co.-----	48
Worch, Hugo-----	44
Wyckoff, Ralph W. G. (The determination of the structure of crystals)---	199

Y.

Yaeger, William L.-----	125
Young Men's Christian Association, lectures for the-----	26

Z.

Zoological Park, National-----	12, 13, 18, 28, 33, 123, 135
accessions-----	85, 135
animals in the collection-----	91
attendance-----	135
important needs-----	99
improvements-----	98
library-----	29, 115
report-----	85
removals-----	89
visitors-----	97



SMITHSONIAN INSTITUTION LIBRARIES



3 9088 01421 7186