



presented to the
LIBRARY
UNIVERSITY OF CALIFORNIA · SAN DIEGO
by
FRIENDS OF THE LIBRARY

Mrs. A. Richard Stern

donor



a
11.00

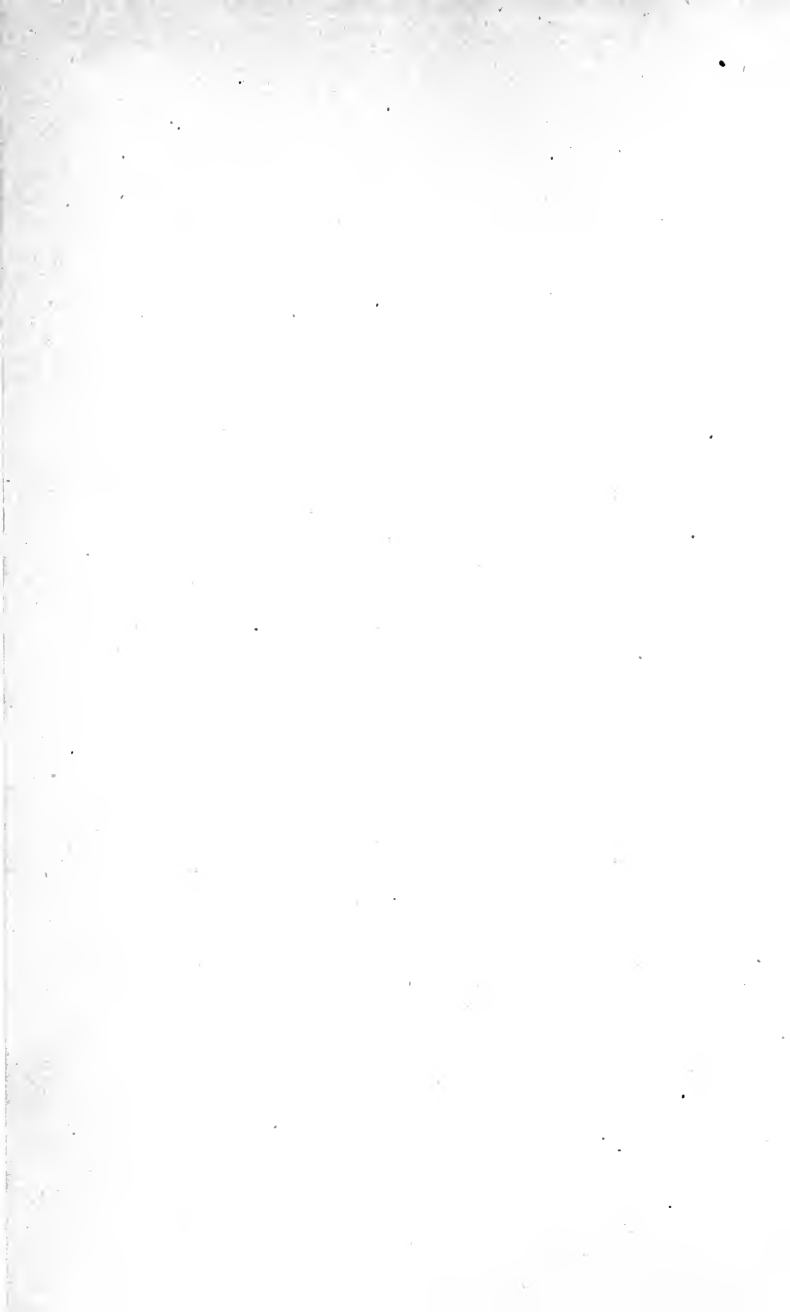

WORKS OF

The Late J. MERRITT MATTHEWS

PUBLISHED BY

JOHN WILEY & SONS, Inc.

**Application of Dyestuffs to Textiles, Paper,
Leather and Other Materials**

768 pages, 6 by 9, 303 figures.

The Textile Fibers

**Their Physical, Microscopical, and Chemical
Properties. Fourth Edition, Rewritten and
Enlarged. 1053 pages, 6 by 9, 411 figures.**

APPLICATION *of* DYE STUFFS

TO TEXTILES, PAPER, LEATHER
AND OTHER MATERIALS

BY

THE LATE J. MERRITT MATTHEWS, Ph.D.

NEW YORK

JOHN WILEY & SONS, Inc.

LONDON: CHAPMAN & HALL, LIMITED

COPYRIGHT, 1920, BY
J. MERRITT MATHEWS

ALL RIGHTS RESERVED

SIXTH PRINTING, MAY, 1947

PRINTED IN U. S. A.

PREFACE

THE present volume has been the result of a comprehensive and more extended development of the author's earlier book entitled "*Laboratory Manual of Dyeing and Textile Chemistry.*" The latter was designed principally as a text-book for students, and necessarily omitted a great deal of matter of more general and practical interest. The present book, while still retaining many of the text-book features in order to adapt it to the needs of the student, has been greatly broadened in its scope so as to appeal to the interest of all those concerned in the application of dyestuffs.

Dyestuffs are most largely used in the textile industries, and naturally this field has received the greatest attention at the hands of the author, but there has also been included a discussion of the use of dyes in other lines of industry; though the limitations of space, as well as the necessity of maintaining a proper balance in the subjects considered, has precluded more than a brief survey of these interesting fields.

The method of presentation, as well as the subject matter herein contained, have been the outcome of a number of years of teaching on the part of the author, supplemented by a larger number of years of active professional practice in this field of applied chemistry. Care has been taken to avoid a too purely scientific generalization, else the volume would lose much of its value for purposes of instruction and information. The subject treated is a technical one, and an endeavor has been made to present it in a technical manner; that is to say, definite facts have been presented in a definite form. To this end an experimental outline has been distributed through the different chapters, both to act as a laboratory guide for the teacher and student and also to furnish concrete examples to the general reader.

The author has endeavored as far as his limitations permit to incorporate in this book the latest knowledge of the subject. In the case of dyestuffs, this has been rather difficult at the present time, owing to the tremendous impetus the manufacture of dyestuffs has received in both America and England during the last few years, together with the shutting off from the world of the long-used and well-known German dyes. This condition has created considerable chaos in the dyestuff world, and there

has also been a great readjustment in the naming of dyestuffs. In order to prevent undue confusion as well as the risk of recording products that may subsequently prove to be only of a temporary significance, the author has deemed it advisable to retain the names and the dyestuffs that were well known before the war and which would be easily and intelligently recognized in the industry all over the world. The dyestuff industry in this country is already well established and the author has great faith in its permanence and eventual success; but at the present time this entire industry is in a state of rapid development and constant flux; its products and their nomenclature are constantly undergoing radical changes, and there still persists in the entire trade a tendency to retain the long-established and familiar names of the more general dye-products. On this account the author has been obliged to maintain a considerable degree of conservatism in the selection of the various dye-products mentioned in the course of the book.

NEW YORK, February, 1920.

J. MERRITT MATTHEWS.

TABLE - OF CONTENTS

INTRODUCTION

	PAGE
1. General Definitions.....	1
2. Historical.....	7
3. Dyes of Antiquity Compared with Modern Dyes.....	14
4. Apparatus and Equipment for Dye-testing.....	16
5. Practical Process of Dyeing.....	20
6. Water and Steam in the Dyehouse.....	26
7. Forms in which Textiles are Dyed.....	31
8. Hydro-extracting and Drying.....	33
9. After-treatment of Dyed Material.....	34

CHAPTER I

CHEMICAL STUDY OF THE FIBERS

1. Action of Acids on Textile Fibers.....	36
2. Action of Alkalies.....	40
3. Mercerizing of Cotton.....	41
4. Action of Metallic Salts on Fibers.....	53
5. Action of Chlorine Compounds and Oxidizing Agents.....	54
6. Effect of Moisture on Textile Fibers.....	57
7. Action of Heat on Textile Fibers.....	61
8. Action of Hot Water on Wool.....	63
9. Experimental (1-16).....	66

CHAPTER II

SCOURING THE TEXTILE FIBERS

1. Impurities in Raw Wool.....	71
2. The Emulsion Process of Scouring.....	72
3. Use of Alkali in Scouring.....	74
4. Carbonizing.....	74
5. The Scouring of Woolen Yarn.....	75
6. The Scouring of Yarns Containing Iron.....	80
7. Scouring Tops.....	86
8. Scouring Woolen Piece-goods.....	82
9. Soaps for Scouring Wool.....	87

	PAGE
10. Boiling-out of Cotton	89
11. The Impurities in Raw Silk	91
12. The Boiling-off of Silk	96
13. The Relation of Water to Wool Scouring	100
14. Experimental (17-27)	105

CHAPTER III

BLEACHING OF WOOL AND SILK

1. Bleaching Wool	107
2. Use of Sodium Bisulphite	108
3. Bleaching Wool with Peroxides	110
4. Bleaching Wool with Potassium Permanganate	112
5. Bleaching Silk	113
6. Experimental (28-32)	114

CHAPTER IV

BLEACHING OF COTTON

1. General Methods of Cotton Bleaching	116
2. The Operations in Cotton Bleaching	117
3. Boiling-out	117
4. Bleaching with Hypochlorites	122
5. Bleaching Powder and its Use	125
6. The Acid Treatment	128
7. Washing	128
8. Soaping and Tinting	129
9. Use of "Anti-chlor"	131
10. Use of Acetic Acid	133
11. Bleaching with Sodium Hypochlorite	134
12. Bleaching with Liquid Chlorine	136
13. Electrolytic Bleach Liquors	139
14. Bleaching Loose Cotton	143
15. Bleaching Cotton Skein Yarn	144
16. Bleaching Cotton Warps	144
17. Bleaching Knit Goods	146
18. Experimental (33-44)	150

CHAPTER V

CLASSIFICATION OF DYES

1. General Classification of Dyes	154
2. Action of Dyestuffs on the Textile Fiber	158
3. Action of Dyestuffs on Wool	159
4. Action of Dyestuffs on Silk	163
5. Action of Dyestuffs on Cotton	164
6. Use of Mordants	166
7. The Pigment Dyes	169

	PAGE
8. Relation between Color and Chemical Constitution.....	169
9. General Relations between the Fibers and the Methods of Dyeing.....	170
10. Experimental (45-49).....	175

CHAPTER VI

APPLICATION OF ACID DYES TO WOOL

1. General Characteristics of the Acid Dyes.....	177
2. Preparation of the Dyebath.....	180
3. Function of the Chemicals Employed in Dyeing Acid Colors.....	184
4. Exhaustion and Leveling Properties.....	186
5. Calculations Used in Dyeing.....	187
6. General Remarks on the Dyeing of Wool.....	188
7. Dyeing Wool in the Loose Stock.....	188
8. Dyeing Tops and Slubbing.....	190
9. Dyeing Woolen Yarns.....	190
10. Dyeing Piece-goods.....	191
11. Experimental (50-58).....	193

CHAPTER VII

APPLICATION OF ACID DYES TO SILK, COTTON, ETC.

1. Dyeing of Silk with Acid Colors.....	197
2. Notes on the Weighting of Silk.....	200
3. Dyeing Cotton with the Acid Colors.....	202
4. The After-chromed Acid Dyes.....	206
5. On the Proper Storage of Dyestuffs.....	207
6. Dissolving of Dyestuffs.....	208
7. Action of Metals on Dyestuff Solutions.....	210
8. Apparatus for Dyeing.....	211
9. Apparatus for Dyeing Cotton Yarn.....	212
10. Apparatus for Dyeing Woolen Yarn.....	213
11. Apparatus for Dyeing Silk Yarn.....	214
12. Influence of the Water Employed in Dyeing.....	215
13. Experimental (59-67).....	219

CHAPTER VIII

REPRESENTATIVE ACID DYES

1. Nomenclature of Dyestuffs.....	222
2. Dyestuff Manufacturers.....	230
3. List of the Principal Acid Dyes.....	232
4. Experimental (68-70).....	236

CHAPTER IX

STRIPPING OF COLORS; TESTING FASTNESS OF DYES

1. Stripping of Dyed Fabrics.....	237
2. Experimental (71-75).....	238

	PAGE
3. Fastness of Dyes.....	239
4. Experimental (74-83).....	240

CHAPTER X

APPLICATION OF BASIC DYES

1. Characteristics of the Basic Dyes.....	247
2. Use of Basic Dyes on Silk.....	249
3. Use of Basic Dyes for Wool.....	251
4. Experimental (84-90).....	252

CHAPTER XI

BASIC DYES ON COTTON

1. The Use of Basic Colors on Cotton.....	255
2. Substances Employed for Mordanting Cotton.....	263
3. Tartar Emetic and Antimony Salts.....	265
4. Experimental (91-96).....	267

CHAPTER XII

PRINCIPAL BASIC DYES

1. List of the Principal Basic Dyes.....	270
2. Notes on the Practical Dyeing of the Basic Colors.....	273
3. Experimental (97-98).....	274

CHAPTER XIII

APPLICATION OF SUBSTANTIVE DYES TO COTTON

1. The Substantive Dyestuffs.....	275
2. Use of Substantive Dyes on Cotton.....	276
3. After-treatment of Substantive Dyes.....	281
4. Topping Substantive Colors with Basic Dyes.....	284
5. Dyeing Cotton Warps in the Size.....	285
6. Experimental (99-113).....	286
7. List of Principal Substantive Dyes.....	290
8. Substantive Dyes for After-treatment with Bluestone.....	296
9. Substantive Dyes for After-treatment with Chrome and Bluestone.....	296

CHAPTER XIV

SUBSTANTIVE DYES ON WOOL AND SILK

1. The Substantive Colors on Wool.....	298
2. The Substantive Colors on Silk.....	300
3. Experimental (114-122).....	302
4. Principal Substantive Dyes for Wool.....	306
5. Principal Substantive Dyes for Silk.....	307

CHAPTER XV

DEVELOPED DYES ON COTTON AND SILK

	PAGE
1. The Production of Developed Colors on Cotton.....	308
2. Developers.....	311
3. Methods of Shading Developed Dyes.....	314
4. Application of Developed Dyes to Silk.....	316
5. Coupled Dyes.....	317
6. The Naphthol Colors.....	320
7. Paranitraniline Red.....	322
8. Notes Respecting Developing.....	329
9. Other Naphthol Dyes.....	331
10. List of Principal Developed Dyes.....	333
11. List of Dyes for Shading.....	334
12. List of Dyes for Coupling.....	334
13. Experimental (123-132).....	335

CHAPTER XVI

APPLICATION OF MORDANT DYES

1. The Mordant Dyes.....	340
2. The Mordanting of Wool.....	341
3. Mordanting with Chrome.....	344
4. Mordanting with Other Metallic Salts.....	347
5. Description of Mordanting Methods.....	349
6. Single Bath Methods of Mordanting.....	351
7. Dyeing with Mordant Colors.....	352
8. Top-chrome Method.....	354
9. Mono-Chrome and Meta-Chrome Methods.....	356
10. Dyeing on Various Mordants.....	358
11. Experimental (133-139).....	360
12. Use of Mordant Dyes on Silk.....	365
13. Mordant Dyes on Cotton.....	365
14. Experimental (140-141).....	366
15. List of Principal Mordant Dyes.....	373

CHAPTER XVII

SULPHUR DYES

1. Nature of the Sulphur Dyes.....	374
2. Dissolving the Sulphur Dyes.....	376
3. Method of Dyeing.....	377
4. After-treatment of Sulphur Colors.....	386
5. Topping of Sulphur Dyes.....	388
6. Fastness of Sulphur Colors.....	389
7. Apparatus Used in Dyeing Sulphur Colors.....	393
8. List of Principal Sulphur Dyes.....	401
9. Experimental (142-149).....	403

CHAPTER XVIII

THE VAT DYES

	PAGE
1. Classes of Vat Dyes	405
2. Indigo	410
3. Methods of Dyeing Indigo	413
4. The Fermentation Vat	417
5. The Copperas Vat	422
6. The Zinc Vat	426
7. The Hydrosulphite Vat	427
8. Indigo Extract	431
9. Synthetic Indigo	431
10. Testing Indigo in the Fiber	435
11. Indigo Derivatives; Thio-Indigo Dyes	436
12. Substituted Indigo Derivatives	439
13. Anthraquinone Vat Dyes	441
14. The Carbazol Vat Dyes	444
15. Experimental (150-158)	445

CHAPTER XIX

ANILINE BLACK

1. Chemistry of Aniline Black	451
2. Dyeing of Aniline Black; One-bath Method	453
3. Aged or Oxidized Black	455
4. Steam Black with Aniline	459
5. Aniline Black on Other Fibers	460
6. Diphenyl Black	461
7. Paramine Brown	462
8. Experimental (159-165)	463

CHAPTER XX

USE OF LOGWOOD IN DYEING

1. General Use of Natural Dyes	470
2. Logwood	471
3. Dyeing on Wool	476
4. Dyeing on Cotton	479
5. Dyeing on Silk	481
6. Reactions of Logwood	482
7. Detection of Logwood in the Fiber	482
8. Experimental (163-187)	484

CHAPTER XXI

THE MINOR NATURAL DYES

1. Fustic	492
2. Osage Orange	495
3. Madder	496
4. Archil	498

	PAGE
5. Ouercitron.....	500
6. C tch.....	501
7. Cochineal.....	505
8. Weld.....	507
9. Persian Berries.....	508
10. Turmeric.....	508
11. Kermes.....	509
12. Lac Dye.....	509
13. Experimental (188-193).....	510

CHAPTER XXII

THE MINERAL DYESTUFFS

1. General Use of Mineral Dyes.....	513
2. Mineral Khaki on Cotton.....	515
3. The Minor Pigment Colors.....	515
4. Experimental (194-207).....	516

CHAPTER XXIII

DYEING OF FABRICS CONTAINING MIXED FIBERS

1. Character of Material.....	524
2. Fabrics of Wool and Cotton on Union Goods.....	524
3. Detection and Estimation of Cotton and Wool in Mixed Goods.....	528
4. Properties of Union Goods.....	530
5. Bleaching of Union Goods.....	530
6. Action of Dyestuffs on Union Goods.....	531
7. Preparation of Union Fabrics for Dyeing.....	533
8. The Dyeing of Union Fabrics.....	534
9. Dyeing Process for Union Goods.....	537
10. Two Color Effects.....	541
11. Classification of Dyes for Union Goods.....	541
12. After-treatment of Union Goods.....	546
13. The Dyeing of Wool Plush.....	547
14. Experimental (208-227).....	548
15. Dyeing of Wool-Silk Materials.....	553
13. Classification of Dyes for Wool-Silk Fabrics.....	556
17. Silk-Cotton Materials.....	560
13. Dyeing of Silk-Cotton Fabrics.....	561
19. Dyeing Processes.....	562
20. Classification of Dyes for Silk-Cotton Materials.....	564
21. Experimental (228-233).....	567

CHAPTER XXIV

APPLICATION OF DYES TO MINOR VEGETABLE FIBERS; LINEN,
RAMIE, HEMP, JUTE, AND ARTIFICIAL SILK.

1. The Minor Vegetable Fibers.....	570
2. The Dyeing of Linen.....	571

	PAGE
3. The Dyeing of Ramie.....	575
4. The Dyeing of Jute.....	575
5. The Dyeing of Coir.....	577
6. The Dyeing of Hemp.....	578
7. Dyeing of Artificial Silk.....	578

CHAPTER XXV

THEORY OF DYEING

1. General Theory of Dyeing.....	582
2. Theory of Dyeing in Relation to Pigment Colors.....	596
3. Theory of Dyeing in Relation to Compound Shades.....	598
4. Theory of Dyeing in Relation to Mixed Fibers.....	599
5. Different Factors in Theory of Dyeing.....	600
6. Theory of the Mordanting Process.....	601
7. Experimental (235-238).....	604

CHAPTER XXVI

TESTING THE FASTNESS OF COLORS

1. Fastness of Dyes.....	607
2. Testing Fastness of Colors Dyed on Wool.....	608
3. Testing Fastness of Colors Dyed on Cotton.....	616
4. Testing Fastness of Colors Dyed on Silk.....	618
5. Tabulation of Fastness Required on Various Classes of Material.....	619

CHAPTER XXVII

APPLICATION OF DYES TO VARIOUS MATERIALS

1. The Dyeing of Leather.....	624
2. The Dyeing of Paper.....	630
3. The Dyeing of Furs.....	632
4. The Dyeing of Feathers.....	635
5. The Dyeing of Straw.....	636
6. The Dyeing of Wood Chip and Plait.....	638
7. The Dyeing of Horse-hair and Bristles.....	639
8. The Dyeing of Human Hair.....	639
9. The Dyeing of Artificial Flowers.....	641
10. The Dyeing of Wood.....	643
11. The Dyeing of Celluloid.....	644
12. The Dyeing of Button Material.....	645

CHAPTER XXVIII

APPLICATION OF DYESTUFFS IN THE PREPARATION OF LAKES,
INKS, ETC.

1. Preparation of Color-Lakes.....	648
2. Preparation of Spirit Lakes.....	658

	PAGE
3. The Dyeing of Soap.....	659
4. Dyestuffs for Inks.....	660
5. Dyestuffs for Typewriter Ribbons.....	663
6. Dyeing of Perfumes.....	663
7. Dyeing of Candles, Oils and Waxes.....	663
8. Use of Dyestuffs for Coloring Food Products.....	664
9. Use of Dyestuffs as Indicators.....	665
10. Use of Dyestuffs in Medicine.....	665

CHAPTER XXIX

TESTING OF DYESTUFFS

1. To Obtain the Money Value of a Dyestuff Sample.....	666
2. To Determine if a Dyestuff is Simple or Mixed.....	668
3. To Determine the Class to which a Dyestuff Belongs.....	669
4. Chemical Method of Distinguishing between Acid and Basic Dyes.....	672
5. Detection of Adulterations in Dyestuffs.....	672
6. Determination of the Capillary Speed of Dyestuffs.....	676

CHAPTER XXX

MISCELLANEOUS TESTS IN DYEING

1. The Amount of Dyestuff Necessary for a Full Shade.....	678
2. To Determine the Degree of Exhaustion of the Dyebath.....	678
3. To Determine the Correct Amount of Mordant to Use.....	679
4. To Determine the Degree of Exhaustion of the Mordant Bath.....	679
5. To Show the Dichroic Property of a Dyestuff.....	680
6. Effect of Dichroism in the Compounding of Shades.....	681

CHAPTER XXXI

CHEMICAL REACTIONS OF DYESTUFFS

1. Identification of Dyes.....	682
2. Solubility Tests.....	682
3. Reaction with Sulphuric Acid.....	682
4. Reaction with Hydrochloric Acid.....	683
5. Reaction with Nitric Acid.....	683
6. Reaction with Sodium Hydrate.....	683
7. Reaction with Ammonia.....	683
8. Reaction with Sodium Carbonate.....	684
9. Reaction with Tannin Reagent.....	684
10. Reaction with Alum.....	684
11. Reaction with Potassium Bichromate.....	684
12. Reaction with Ferric Chloride.....	684
13. Reaction with Stannous Chloride.....	684

	PAGE
14. Reaction with Bleaching Powder.....	684
15. Reaction with Zinc Dust.....	685
16. Reaction with Zinc Dust and Acetic Acid.....	685

CHAPTER XXXII

ANALYSIS OF TEXTILE FABRICS

1. To Determine the Amount of Wool and Cotton in a Fabric.....	687
2. Analysis of Fabric Containing Silk and Cotton.....	687
3. Analysis of Fabric Containing Wool and Silk.....	688
4. Analysis of Fabric Containing Wool, Silk and Cotton.....	688
5. Distinction between True Silk and Artificial Silk.....	688
6. To Distinguish between Cotton and Linen.....	689
7. To Distinguish between True Silk and Tussah Silk.....	689
8. To Test if Cotton Has Been Mercerized.....	690
9. To Test if Silk Has Been Weighted with Tin Salts.....	690
10. Estimation of Sizing and Dressing Materials in a Fabric.....	691
11. Conditioning of Textile Materials.....	691
12. Estimation of Oil and Grease in Fabrics.....	692
13. Detection of Mineral Oil in Textile Fabrics.....	692
14. Detection of Rosin Oil in Textile Fabrics.....	692
15. Estimation of Mineral Matter in a Fabric.....	692
16. Determination of the Nature of Sizing on a Fabric.....	692
17. Determination of the Nature of Mordants on Woolen Fabrics.....	694
18. Determination of the Nature of Mordants on Cotton Fabrics.....	696
19. Analysis of Black Dyed Cotton.....	697

CHAPTER XXXIII

USEFUL DATA FOR DYERS AND TEXTILE CHEMISTS

1. Hydrometers.....	701
2. Equivalent of Common Use in Measuring.....	703
3. Conversion Tables.....	704
4. Thermometry.....	706
5. Comparison of Relative Strengths of Chemicals.....	706
6. Tables of the Strengths and Densities of Various Solutions.....	707
7. Useful Data for Calculations in Dyeing.....	712
8. Tables for Calculations in Dyeing.....	715

BIBLIOGRAPHY

Literature of Dyeing, Bleaching, and Textile Chemistry.....	733
---	-----

INDICES

Experiment Index.....	751
Subject Index.....	755

APPLICATION OF DYESTUFFS

INTRODUCTION

1. General Definitions—The term dyeing is used almost exclusively with reference to the textile industry, and it is in this sense alone that it shall here be employed. Dyeing means to impart to the fibrous substances, fabric, yarn, or other textile material, a color which shall possess certain qualities, among which may be mentioned uniformity and stability towards washing, exposure, etc. As textile materials are composed of various fibers, dyeing really refers more especially to the coloring of the fibers of which the textile consists. The chief fibers which find an extensive application in the manufacture of textiles are wool, silk, and cotton, and as the methods of dyeing these fibers are radically different, it becomes necessary to classify the study of the phenomena of dyeing under the separate subjects of wool dyeing, silk dyeing, and cotton dyeing.

Dyeing, in the proper sense of the word, has a deeper meaning than that of merely imparting a color to the fibers; the color must be uniformly distributed throughout the substance of the fiber, and not merely be a coating on its surface. The latter would be classified under the term of painting and not dyeing.*

In order that the color shall penetrate into the substance of the fiber, the coloring matter must be applied in the form of a solution. Herein lies the difference between dyestuffs and pigments; the former are colored bodies of a soluble nature, usually complex derivatives of carbon, whereas the latter are insoluble and mostly of mineral origin. But all soluble colored substances are not dyestuffs; a solution of copper sulphate, for

*The distinction between painting and dyeing is that the former is the application of an adhesive pigment to the surface of a body of almost any nature, whereas dyeing consists in coloring the actual substance of a body by the use of certain materials possessing tinctorial properties and known as dyestuffs. When a very slight amount of dyestuff is applied to the material, the process is usually known as tinting, as when a bleached white is tinted with a blue coloring matter to give it a slight bluish tone, or when white cotton is given a very pale shade of brown in order to simulate the particular tint of Egyptian cotton. Staining is a special term given to the coloring of certain substances with dyestuff solutions, as in the coloring of paper, marble, ivory, etc.

Dyeing in the batik style of applying the color to design has been undertaken by a number of color artists, and very laudable and excellent work has been turned out. It is also true that a number of amateurs and half-baked artists have entered this field with little or no knowledge of the possibilities of dyeing and with little or no skill in technique or ability in design, and as a result they have turned out some horrible examples of bad taste both in form of design and in combinations of color. Originality of idea and highly developed skill in technique are just as

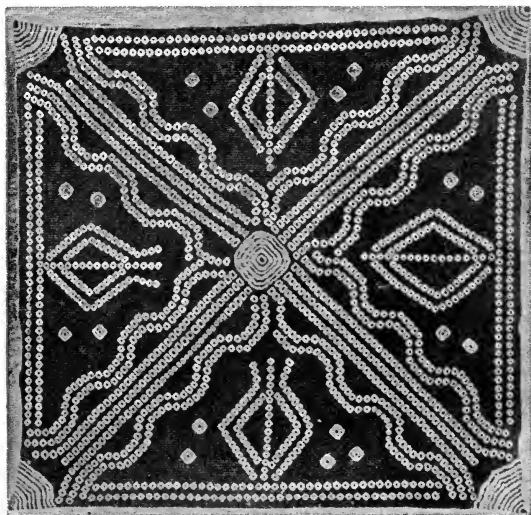

FIG. 2.—Tied-and-Dyed Work. (Courtesy of C. E. Pellew.)

essential in producing good results in this form of color art as in painting or other form of art expression.

The batik style is generally applied to cloth for a specific use in a special garment or decorative fabric, and the design and color effects are adjusted to meet the requirements of the particular piece. For example, this method of dyeing is applied largely to silk goods used in making ladies' waists or gowns; in scarfs, draperies, and hangings for purposes of interior decoration, etc.

The tie-dyeing style is also employed both by itself and in connection with batik for the same purposes. Like batik, tie-dyeing also requires a skillfully developed technique of handling in order to obtain

proper results, otherwise very crude designs will be produced. As both of these styles often require the dyeing of one color over another, the operator must have an intimate knowledge of such color combinations in order to obtain the proper artistic effects. Also in tie-dyeing considerable ingenuity has to be exercised in forming ties in the cloth which will yield harmonious and properly balanced designs; this requires an originality of handiwork which usually takes considerable experience to develop. The mistake is often made by the amateur that any odd effect is artistic, but this is far from being the case. Just what constitutes an artistic effect is perhaps very difficult to describe, and no doubt the difference between good taste and bad taste is instinctive and can be cultivated only through experience.

Application of dyes by means of stencils is in reality a form of printing by hand, using the stencil to obtain the pattern and the brush to apply the color instead of printing blocks. Stencil work is susceptible of very artistic effects and originality of designs, as are witnessed in the celebrated Japanese stencils to be found among the many art collections of our country. Stencil work is especially adaptable to craft dyeing where personal talent and handwork are the distinguishing features. The application of color in stencil work which is fast requires special methods of dyeing and treatment, however, that necessitate an intimate knowledge of the properties of dyestuffs and mordants. Without this knowledge and its proper practical application, the colors obtained in stencil work will be little more than surface paints and not real dyeings of a satisfactory degree of fastness to light and washing.

The field for craft dyeing in this country is a broad one, and there is a large and appreciative public ready to absorb real artistic productions at a price which is helpful in developing and encouraging the art. On the other hand, this form of craft has a strong appeal to the dilettante and egregious amateur, with the result that there is danger of a flood of poorly executed and badly designed productions submerging the really good things in this line. As a rule, textile and color chemists, as well as the expert colorists of the dyestuff factories, have given little or no consideration to these possibilities in craft dyeing, believing it to be too small and unimportant a line on which to waste time and labor. This may be somewhat true if the quantity of dyestuffs consumed is taken as a measure of its importance, for in this respect craft dyeing uses a very small proportion of dyestuffs in comparison with the regular lines of dyeing. It deals more with the dyeing of goods by the square foot than by the thousands of yards, and probably the country's entire consumption of dyestuff in craft dyeing would not equal that of one moderately sized dyehouse or mill. But, on the other hand, the color chemist as well as the dyestuff manufacturer should realize that in craft dyeing we have

the possibility of reaching into realms of color art that is not present in ordinary trade dyeing. There is also the germ of originality and creative purpose that may lead to yet undiscovered fields in dyeing, that may eventually widen out the application and use of dyestuffs in general.

As a background to the main province of dyeing, it is well to develop and encourage this matter of craft dyeing as far as possible, and the color



FIG. 3.—Japanese Stencil. (Courtesy of H. Steigner.)

chemist and dyestuff producer should give it their serious attention. To the chemist it should prove an attractive field in the devising of ingenious methods of applying dyestuffs and mordants to produce effects by hand treatment that are hardly thought of by the ordinary dyer. And there is always the possibility that many of these processes may be adapted subsequently to a large-scale production that will give results of a higher degree of quality and taste.

2. Historical.—Considered from an historical point of view, dyeing is as old as the textile industry itself, and this antedates the written documents of human history. Closely connected with the utilitarian desire of human beings to clothe themselves from the inclemencies of the weather is the desire for artistic effects to be obtained in coloring the materials of which these protective coverings are made. From Greek mythology we learn that Ariadne, the goddess of spinning and weaving, was the daughter of Idon the dyer of wool, a truly interesting chronological comparison, and one showing how intimately the art of dyeing was connected with its sister arts.

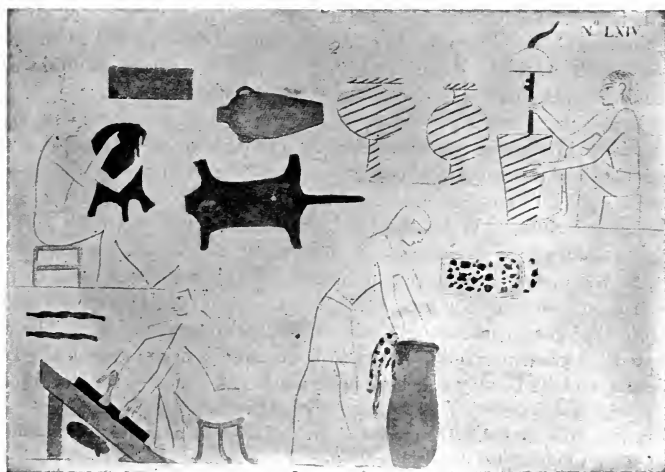

FIG. 4.—Dyeing in Ancient Egypt.

Perhaps the earliest authentic records we have concerning the industrial life of the ancient nations are those contained in the historical classics of the Chinese; in these we find mention of the dyeing of silk in various colors as far back as 2600 B.C. The dyestuffs employed were those obtained from various plants. Dyeing, together with its related industry, printing, appears to have been practised at very early times by the various East Indian nations, long before their migrations led to the settlement of Asia Minor and Europe.* Remnants of dyed

* The ancient Hindoos were evidently acquainted with a large number of vegetable coloring matters; of the nature and properties of these, however, we know little or nothing, for even the native dyes which are employed in India at the present time have

fabrics of great antiquity have also been recovered from Egyptian tombs.*

As to the coloring matters employed by the ancient peoples in dyeing, nearly all were of vegetable or mineral origin, and many were more or less of merely local occurrence. The dyer went out into the forest and collected the plants which had been found to possess tinctorial properties, extracted the coloring matter by boiling these in water, and employed this liquid decoction as the dye-bath. The use of mordants was also known, for the majority of the vegetable coloring matters required the previous application of a suitable mordant in order subsequently to develop and render permanent the color obtained in the dye-bath. In fact, it was known that by using mordants of different metals different colors could be produced with the same dyestuff, and in Pliny we find a description of how the Egyptians obtained variegated colors on a fabric by dyeing it in one operation with a single dyestuff, having previously applied metallic compounds in such manner as to obtain the desired effect.

Indigo was known in very early times and was extensively employed, especially in Asiatic countries, for the production of blue colors. Red was obtained from various vegetable extracts and also from the kermes insect, which somewhat resembles cochineal; Madder was also used. † Safflower, ‡ Saffron, Weld, Persian Berries, and other vegetable products were employed for dyeing scarlet and yellow.

At the opening of European history the Phœnicians appear to have been most renowned for their skill in dyeing, and their beautifully colored fabrics became articles of extensive trade with other nations. The celebrated "Tyrian purple" appears to have had its origin among the Phœnicians, and its beauty and high price made it a badge of royalty. § This

been very little studied. The process of dyeing Indigo by means of the fermentation vat appears to have had its origin in India.

* A garment dyed with Indigo has been found in Thebes dating from 3500 B.C., and archeological researches have shown that the Egyptians dyed iron buff and used the yellow coloring matter of the safflower in dyeing as early as 2500 B.C.

† The scarlet color of the Tabernacle curtains of the Bible was no doubt produced with Kermes. This material was known to the ancients as "kermes berries" and was thought to be a vegetable product, and it was not until the eighteenth century that it was recognized as an insect similar to cochineal. Kermes was known to the Egyptians before the days of Moses, and was said to have been discovered by the Phœnicians. By the Hebrews it was called *Tola*, and by the Egyptians *worm dye*. In Persia its color was more sought after even than the Tyrian purple.

‡ Safflower was used by the Egyptians to dye silk a brilliant but rather fugitive scarlet. The Greeks in early times used it as a royal color and even in ancient Ireland (in fact up to the seventeenth century) the king's mantle was dyed with it.

§ A very complete description is given by Pliny in various parts of his "History of Nature" concerning the nature of the Tyrian purple and the methods employed for obtaining it from the shell-fish, as well as the means of applying the color to fabrics.

coloring matter was obtained from certain shell-fish which were collected along the coast, and recent research has shown that this dyestuff was dibromindigo, a coloring matter which has now been prepared synthetically, as one of the modern "vat" dyestuffs.* According to Pliny, the Greeks, at the time of Alexander the Great, were acquainted with the art of dyeing wool in purple and other colors, and also of dyeing linen in black, yellow, blue and green colors which were fast to washing. Plutarch tells us that in Rome dyeing was carried on as a handicraft, which Numa Pompilius endeavored to encourage and foster by establishing a college in the interest of this art. This "collegium tinctorum" is interesting to us as being probably the first school of dyeing ever established.

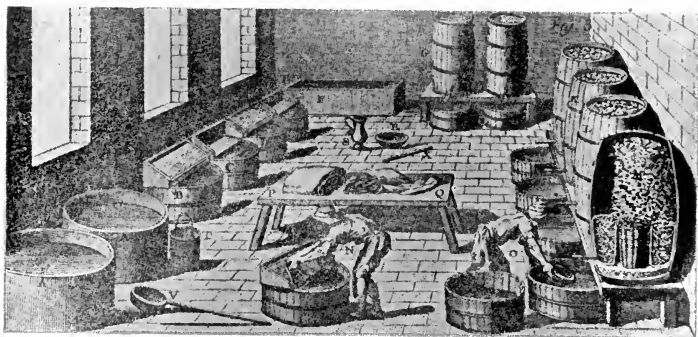

FIG. 5.—Dyeing Cotton Black. (Eighteenth Century.)

The Romans were acquainted with a number of different coloring matters, and divided them into major dyes and minor dyes; the first were used for dyeing garments for both sexes, whereas the second were employed solely for either men or women as the case might be. Yellow, for instance, was only used for dyeing bridal garments. This was truly a remarkable sociological classification of dyestuffs. Pliny gives us a description of the following materials used in dyeing by the people of his time. He describes alum, and classifies it into white and black varieties; from his description, however, this term must be taken to include not only the ordinary alum which we recognize, but also soda, which occurred in natural deposits in various localities, and probably several other such salts. We understand from Pliny, however, that the Romans were acquainted with the art of applying metallic mordants to wool; they

* See Friedländer, *Berichte der deutschen Chem. Gesellschaft*, 1909, p. 765. The dyestuff was obtained directly from the shell-fish, 12,000 being used in the research, with a total yield of 1.4 grams of pure color.

appeared to have employed a decoction of sea-grass for fixing the alum mordant, much after the manner that cow dung was employed by dyers up to even rather recent times. The Romans were also acquainted with the use of tannin as a mordant in dyeing black, using a decoction of oak bark for this purpose. Among the various dyewoods mentioned by Pliny are *genista* (probably corresponding to our Flavine) for yellow, elderberry and walnut shells for brown, Woad for blue. The latter was applied in a vat somewhat like Indigo; the dye *indicum* is also mentioned, but whether this was identical with true Indigo or not is a disputed point.

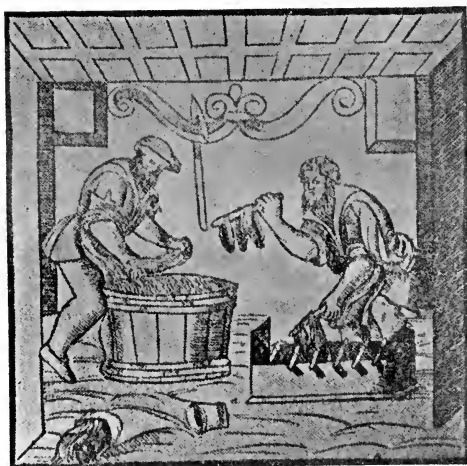

FIG. 6.—Skein Dyer. (Middle Ages.)

Red colors were obtained from madder root; from the root of the red cabbage—the latter, in fact, is employed in Russia even to the present time, and is known in trade under the name of *alkanna*; while *Kermes* was used for dyeing a purplish red. Purple was dyed after the manner of the Tyrian purple, from the coloring matter extracted from a certain shell-fish.

The Venetians appear to have been the first of the more modern European nations* to acquire skill in the art of dyeing, or in fact of any

* Benjamin of Tudelo informs us that a number of dyehouses existed in and around Jerusalem during the twelfth century, and that dyeing was entirely in the hands of the Jews.

of the textile branches.* From Venice the art of dyeing was gradually developed throughout the other European countries and soon reached a high stage of excellence in Holland, France, England, and Germany. Though Indigo was not generally introduced into Europe until the fourteenth century, Woad, a somewhat similar dyestuff, was used in its place, and when Indigo was imported in large quantities through trade with India, it had to overcome serious obstacles in its competition with Woad



FIG. 7.—Cloth Dyer. (Middle Ages.)

for dyeing blue. There appears to have been a kind of Woad syndicate in existence at that time with sufficient political influence to obtain severe

* We find a reference in the historical records of Venice in 1194 concerning the importation of Indigo and Brazil-wood from India. This latter named dyestuff subsequently gave its name to the well-known South American country. Although Indigo was employed in Venice at this time, it does not seem to have extended over the rest of Europe when the subsequent decadence of Venice and its industries led to the widespread dissemination of the art of dyeing over entire Europe. This was probably due to a cessation more or less of the trade with India, which was not resumed until the sea route to Asia was discovered.

laws against the use of Indigo in many of the principal countries, and this dye had to overcome tremendous opposition before it finally replaced the much inferior Woad.*

The discovery of America gave a great impetus to the art of dyeing, by making a large number of new coloring matters available for use. Logwood, and the various red woods of Central and South America were introduced, and were soon extensively employed;† Fustic was also an American product, and so was cochineal. All of these new materials were exceedingly valuable additions to the dyestuffs employed at that time, and soon came into extensive use. The Netherlands and Belgium became the great centers of wool dyeing, a position which they maintained for a long period of time, but the art gradually perfected itself in England and Germany, as well as in France. The variety of vegetable coloring matters which were employed was very numerous, and some were rather peculiar and interesting. In England, for instance, a yellow coloring matter was extracted from onion skins, and was quite extensively employed.

Up to the middle of the last century dyeing had a rather gradual and even development, though but little attempt was made towards a scientific study of the subject; but the year 1856 brings us to a period of revolutionary development. It was in this year that Perkin, an English student working under Hofmann in Germany, discovered (during a research which had for its object the synthesis of quinine) that the oxidation of aniline yielded a beautiful violet coloring matter of great tinctorial power. This was the beginning of the era of artificial dyestuffs prepared from the various products of coal-tar, and proved to be an important landmark in the industrial development of chemistry. Not only did this discovery soon bring about a complete revolution in the methods of dyeing through the preparation of numerous artificial dyestuffs, but it also brought the art of dyeing into a more intimate and direct connection with the science of chemistry, which was then growing with rapidity.

* A law of the Diet of 1577 prohibited the use of Indigo in Germany, it being described as a "pernicious and corrosive dye." The first mention of Indigo in England is in the year 1581, in connection with black dyeing, but it does not seem to have been used for dyeing blues. In a document of 1243 reference is made to the duties payable on Woad, and in 1268 an agreement was recorded between the citizens of Norwich and the Woad merchants of Amiens, in France. Coventry was famous for its blue-dyed woolen cloths as early as 1415, the color being known as "Coventry true blue." The first guild of dyers is mentioned in 1188, but the first charter of incorporation was granted to the Worshipful Company of Dyers in 1471.

† Even Logwood appears to have aroused considerable opposition when first employed, as we find an edict of Queen Elizabeth prohibiting the use of Logwood, and directing that all of this material found should be burnt. James I, in 1620, prohibited the import of Logwood, but dyers apparently employed it under other names.

Previous to that time the methods of dyeing were eminently unscientific, crude, and more or less surrounded with mystery and supposed secrecy of skill. The chemist had been too intently occupied in other fields to become interested in the working out of the scientific principles of dyeing, and only a very few scientists had engaged themselves in its investigation. But the discovery of the coal-tar colors opened up a wide and most lucrative field for chemical research, and this soon led to a close association of dyeing and chemistry to the mutual benefit of both subjects. From the dyestuffs themselves, the chemist was led to an investigation of the processes and methods of dyeing, and a chemical study of the fibers and mordants, and the action of the various drugs employed. The result was that order and system and knowledge of underlying principles in dyeing were soon introduced, where before everything had been more or less obscure and chaotic and dependent upon rule of thumb methods. From that time on, dyeing became incorporated in the general science of chemistry, and has since drawn its sustenance from and reached its highest development under the guidance of that comprehensive parent of so many industries. The old, crude methods of dyeing have been relegated more or less to the mysteries of antiquity, and have given way to concise, clearly understood, and scientific processes. The majority of vegetable coloring matters, whose use necessitated usually cumbersome and lengthy methods of application, have been replaced almost exclusively by the various coal-tar colors, which are easily and quickly applied.

The colors obtainable with the old dyes were also subject to many limitations; brilliancy of hue in many instances was impossible, and the range of shades ordinarily obtained was rather narrow, and not capable of much extension without seriously complicating the dyeing process. The introduction of the coal-tar dyes made it possible to obtain colors which had hitherto been the despair of the dyer; and the latter has now at his command the most varied shades, and the most delicate and brilliant hues. But very few of the natural dyes have left even a vestige of their former selves in trade; some still retain their prestige on account of their good qualities and cheapness. Indigo has heretofore been the principal dyestuff of trade, and was a natural vegetable product which withstood all the competition of artificial substitutes; but the last few decades have seen the successful synthesis of this very dyestuff from coal-tar products, and it will only be a question of time before the vegetable dye will be driven entirely from the market. A similar result was witnessed in the case of Madder, which formerly ranked almost equal to Indigo in commercial importance; it was prepared by chemical means from coal-tar under the name of Alizarine, and soon displaced the natural dyestuff entirely. Logwood still retains its importance among

dyestuffs, principally on account of the good, cheap blacks which can be obtained with it. It is surpassed, however, in fastness by several of the coal-tar blacks, and for many purposes has been replaced by these colors. Cochineal is still used to some extent for the dyeing of scarlets and reds, but its use is fast decreasing, giving way to the various coal-tar red dyes, many of which surpass it in fastness. Fustic is employed somewhat at the present time, but chiefly in combination with Logwood for the production of blacks. It is rarely used as a self-color for dyeing yellow, for many of the coal-tar colors surpass it in purity and brilliancy of hue, as well as in permanence of color.

3. Dyes of Antiquity Compared with Modern Dyes.—At this point it is of interest to discuss briefly the comparative permanence and color values of the old natural dyes* and the more recent coal-tar dyes; for much is said (especially by those more or less unacquainted with the properties of dyestuffs) of a derogatory nature concerning the modern colors, while the fastness of the old dyes is highly extolled. If we examine in review the former vegetable dyes we will find that perhaps the fastest one of all is Indigo (used for obtaining blue shades and for mixed shades containing blue); as this identical dyestuff is now prepared from coal-tar, we need not proceed further with the comparison in regard to it. There are also other blue dyestuffs of artificial origin which are eminently fast and more easily applied than Indigo (Alizarine Blues, etc.), and though recently introduced, vat colors are even much faster than Indigo. Red was formerly dyed almost exclusively (where fast colors were in question) with Madder on previously mordanted wool; as the coloring principle of Madder is made at the present time from a derivative of coal-tar, and is identical in every respect with that occurring naturally in the vegetable dyestuff, we have at our command the same conditions of fastness as the people of antiquity; we have also far extended our range of fast colors in this respect by the preparation of blue, yellow, brown, green, and black dyestuffs belonging to the same class as Alizarine Red (Madder) and pos-

* In the sixteenth, seventeenth, and eighteenth centuries the dyes that were principally employed for the production of fast colors were as follows:

1. Blue—Indigo and Woad.
2. Scarlet red—Cochineal and Kermes.
3. Crimson red—Madder.
4. Brown—Walnut husks.
5. Yellow—Weld.
6. Black—Iron tannate on Indigo bottom.

Many other vegetable dyes were used for the production of colors, but these were known as "false" colors and were not fast. In the eighteenth century the practice of dyeing was regulated by very strict rules under the "Regulations" of Colbert, and a dyer was not allowed to dye "true" colors with any of the "false" dyes. This close government regulation had the beneficial effect of bringing into use the best and fastest colors available, as the dyer was not allowed to misrepresent his goods.

sessing similar dyeing qualities. Weld and Persian Berries appear to have been the fastest yellow dyes possessed by the ancient dyers, and these do not compare to our Alizarine Yellow (and some other coal-tar yellows) in respect to fastness and clearness of shade. The other yellow dyewoods which were extensively used were all rather fugitive, which accounts for the fact that most of the solid yellows in the old fabrics are found to be much faded, and also the compound shades of which yellow was a component exhibit a faded appearance. Dull russet yellow and orange shades were sometimes obtained by the use of a metallic pigment, and these, of course, being mineral bodies, were extremely fast, but they lacked brilliancy and clearness of tone. This color was obtained by steeping the material to be dyed in iron liquor, prepared by dissolving iron filings in vinegar (acetate of iron), and then drying in the sun. Green colors were obtained by the use of the mineral pigment verdigris; there do not appear to be any green vegetable dyes of importance, though it is said the Chinese were acquainted with a green dyewood called Lo-kao which possessed great beauty and fastness. It was probably derived from the leaves of certain species of *Rhamnus*; it was, however, exclusively employed in China and was unknown outside of that country. Green colors in modern methods of dyeing, where fastness is desired, are obtained by compounding fast yellow and blue dyestuffs to the desired shade of green. Black was formerly dyed by two methods. The first employed Logwood or a similar dyewood capable of yielding a black color on mordanted wool, in which case the black was not extremely fast, especially to light and exposure; we still employ Logwood for dyeing cheap blacks on wool, but we have many other coal-tar colors which possess superior fastness. In the second case, black was dyed by forming a heavy deposit of tannate of iron in the fiber. A decoction of iron filings and oak bark was made with water and this was spread over the cloth to be dyed, which was then rolled up and allowed to remain for about a month; by that time the iron rust had permeated the cloth, and it was then dyed black by steeping in a decoction of gallnuts. This was a rather crude and lengthy process, to say the least, and not at all adapted for modern times. Brown shades were usually obtained by steeping the cloth in a decoction of walnut husks and lime water.*

* A valuable source of information concerning the dyeing processes of antiquity is a book published in Venice in 1548 by Plichto. This person was an officer in the Venetian army and his real name was Giovanni Ventura Rossetti. It was one of the first books of its kind ever published, and contains numerous recipes and processes for dyeing which the author had personally collected in his extensive travels through Europe and the Levant. A German book on dyeing had already appeared at Strassburg in 1514, and contained a description of various dyeing processes used in Germany at that time. From the descriptions given in this book it appears that a mordant of alum was the basis of nearly all the colors dyed in Germany. The first book dealing

At the present time the great demand placed on the dyer is cheapness and volume of production, which must often be attained at a considerable sacrifice of fastness of color. If time and expense were not so carefully economized, there is no reason why the modern dyer (if he be well acquainted with the principles of his profession) should not turn out colors of equal fastness, if not superior in many cases, to the colors of antiquity, and the range of shades at his command would be far more extensive. We must bear in mind that the old dyeing processes were usually long and tedious methods, and time was little or no factor in the operation. If greater brilliancy of hue is desired, as is frequently the case in modern times, it is obtainable only by the use of certain colors, the majority of which are not characterized by any special degree of fastness. These modern dyes far surpass the old ones in this quality of brilliancy and purity of tone, but if such quality is demanded, a high degree of fastness must at the same time be sacrificed.

4. Apparatus and Equipment for Dye-Testing.—In carrying out the dye-tests to be described in this book, it will be found convenient to employ skeins of wool and silk weighing 5 grams and of cotton 10 grams. The dyebaths should conveniently contain about 300 to 400 cc. of water, and should be of porcelain, glass, or enameled iron-ware. A good form of experimental dyebath is that shown in the illustration (Fig. 8). It consists of a round copper or sheet-iron vessel lined inside with asbestos, and provided with a perforated iron bottom and top. Its top contains four openings through which the dyepots are inserted. This airbath is placed on an iron stand provided with a gas burner. The dyepots are porcelain and are held by beveled copper collars with wooden handles. The airbath is so arranged that when the dyepots are in position they are raised about an inch above the bottom plate. Such a dyebath allows of a uniform heating of the four pots, and the temperature may be raised rapidly or slowly at will, by regulation of the gas flames, and it is an easy matter to bring the liquid in the pots to an active boil.

Instead of using a gas burner to supply the heat, it will be found convenient, where electricity is available, to employ a round electric stove plate, in which case the body of the airbath may be placed directly on the electric stove, and the perforated bottom may be dispensed with. This method of heating gives a very uniform temperature in all four dyepots, and as the heat is easily regulated it may be maintained at a constant point, and so avoid overheating of the dyepots.

There are other forms of experimental dyebaths in use where solutions of calcium chloride, common salt, glycerin, etc., are used for heating the dyepots. Strong solutions of calcium chloride are capable of being with the subject of dyeing printed in English appeared in London in 1583, and was a translation.

heated far above the boiling-point of water, and consequently in such a bath it is easy to bring the dypots to the boil. But calcium chloride solutions attack the baths in which they are contained. In case of copper vessels with soldered seams the solder is rapidly eaten out and leaks frequently occur. In a dye-bath using a solution of calcium chloride the seams should be brazed, which makes the apparatus rather expensive, and even then the copper itself is soon attacked.

In large dye laboratories to be met with in dyestuff factories or dyehouses and mills, and where a dyebath is required to take care of a large number of dypots at once, a good form of apparatus is a cast-iron or wooden trough 1 to 1½ ft.

wide, 3 to 4 ft. long and about 10 ins. deep. This is lined with a good quality of sheet lead. The top consists of sheet lead properly braced, and containing openings for the dypots. In this form of bath several dozen

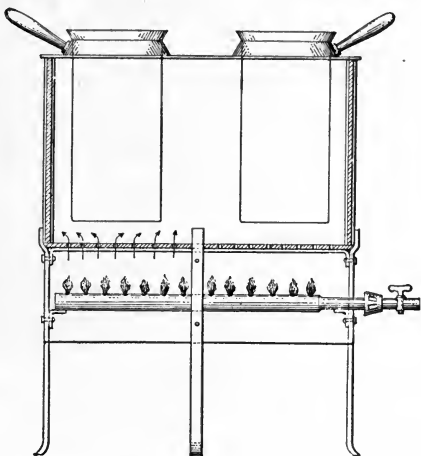

FIG. 8.—Dye-Test Bath; Gas Heated.

pots may be heated at once. The solution used in the bath should be calcium chloride of such strength that a temperature of 220° F. may be obtained. This will be sufficient to allow of the dyebaths in the pots to be brought to the boil. The heating of the bath is effected by a lead steam coil. With solutions of common salt it is difficult to obtain a temperature

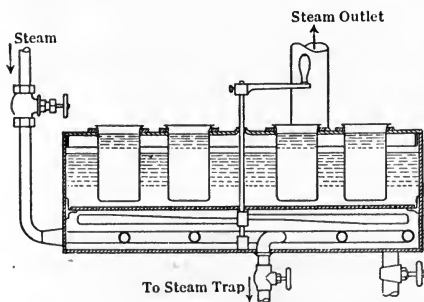

FIG. 9.—Dye-Test Bath; Steam Heated.

of 212° F. in the dypots; that is, to bring them to a state of active boiling. A temperature of 210° F., however, can be maintained, and probably this is nearer the actual temperature of the open

dyevat in practice, and gives as good results as if the liquid was in an actual state of ebullition. Solutions of common salt are perhaps to be preferred to those of calcium chloride where a copper dyebath is used, as they do not have a corroding action. By the use of glycerin in the bath a boiling temperature can readily be obtained in the dyepots, but glycerin baths continually emit disagreeable vapors. Whenever possible, baths containing such solutions should be heated by a steam-coil (with steam under pressure) rather than by direct gas flames. The great disadvantage of all baths using solutions, and one from which the airbath is free, is that the water is constantly being evaporated from the solution and has to be as constantly replaced.

When dyeing the test skeins they should be systematically "worked" or turned in the dye solution. This is best accomplished by suspending the skein in the bath from two glass rods, and using these from time to time for the purpose of turning the skeins. These glass rods should be $\frac{1}{4}$ to $\frac{3}{8}$ in. in diameter, and 8 to 10 ins. in length. The skeins should be turned sufficiently to insure even penetration of the solution through the entire portion of the material.

The dye solution employed in the baths will usually cause discolorations on the porcelain or glass beakers used, as well as on the glass rods and other vessels with which they come in contact. In starting a new dye-test it is essential that all of the apparatus be clean and free from previous dye stains. As many of these stains cannot be removed readily by water or soap solutions, stronger chemical treatment is generally necessary. For this purpose, it is well to have on hand a strong solution of chromic and sulphuric acid. This is prepared by using about 1 part of solid sodium bichromate with 10 parts of strong sulphuric acid (sp. gr. 1.84). This mixture should be kept in a stout glass or porcelain container. It will remove almost all color stains on apparatus and can be used over and over again if care is taken not to dilute it unduly. As the solution is very corrosive it should not get on the hands or clothing or on metal ware.

The skeins of yarn for use in the test experiments may conveniently be made on a small yarn reel, such as is used in most yarn mills for making test skeins to determine the size of the yarn (see Fig. 10). In the case of wool and silk yarns the material will generally be obtained in the form of large hanks or skeins. These will have to be put on a suitably sized "swift" (or frame for holding the skein) and run therefrom to the reeling machine. In the case of cotton, this can usually be obtained in the form of cones, which are far more convenient to reel from. There is wide variation possible in the selection of the yarn to be used. It is well not to use too fine a yarn, as this consumes considerable time in the preparation of the test skeins; also finer yarns are more expensive than coarser ones, and are more liable to break and tangle up. In the case

of wool dyeing, two-ply, soft worsted yarns will yield better looking tests than carded woollen yarns. With silk it is best to have twisted thread silk yarns, as these will break and tangle less and may be easily

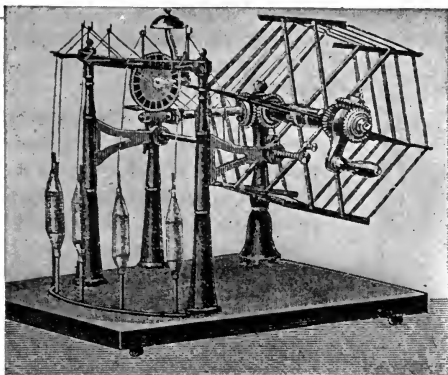

FIG. 10. Yarn Reel.

rewound if required. If this form of silk yarn is too expensive, however, spun silk yarn may be used. With cotton it is well to use a good quality two-ply combed peeler yarn (in size about 2/20's or 2/16's).



FIG. 11.—Porcelain Dye pots.

As already mentioned, the wool and silk should be made up into skeins weighing 5 grams, while the cotton is used in skeins of 10 grams.

The dyestuffs and various chemicals employed in carrying out the dye-tests should be used in the form of solutions of such strength that

small quantities of the products may be measured out in convenient volumes. As the amount of material being dyed (5 or 10 grams) is relatively small, and as small amounts of the dyestuffs, etc., are used, it would be both inconvenient and inaccurate (unless very precise weighings were made on expensive and accurate balances) to weigh the chemicals employed in each test; but by preparing solutions of definite strengths the required amounts may be readily and accurately measured off. The proper preparation of these solutions will be taken up as demanded by the course of the experiments. For the measurement of the solutions a glass cylinder graduated into 100 cc. is very convenient; this readily permits of the rather accurate measurement of such quantities as 5 cc., 10 cc., etc. Volumetric measuring flasks of 100, 500, and 1000 cc. capacity are also convenient for the preparation of standard solutions of dyestuffs and chemicals. In cases where very minute quantities are desired, and it is necessary to measure to an accuracy of $\frac{1}{10}$ cc., a small glass tube (known as Mohr's pipette) accurately graduated to $\frac{1}{10}$ cc. is very useful.

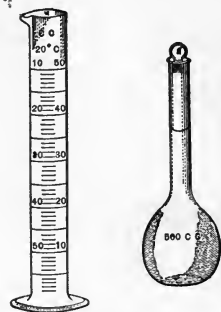

FIG. 12.—Glass Cylinder and Graduate.

These pipettes may be obtained in sizes holding 5, 10, 25, or 50 cc., and by their use volumes accurate to $\frac{1}{10}$ cc. may be readily measured out. A thermometer is also necessary for use in the dye-tests. A good, practical and inexpensive form is the so-called "dairy" thermometer with a paper scale and reading to 220° F. By the use of this thermometer the temperatures of the dye solutions or other liquids employed in the tests may be ascertained. An agate cup



FIG. 13.—Mohr's Pipette.

(pint or quart size) is a useful adjunct for the preparation and mixing of the various solutions needed. A bunch of small tags should also be available so that every skein with which a test has been made may be properly labeled for identification and reference.

5. Practical Process of Dyeing.—In carrying out the methods of dyeing on a practical scale, the object is usually to impregnate the material to be dyed with the various solutions of coloring matter or other materials

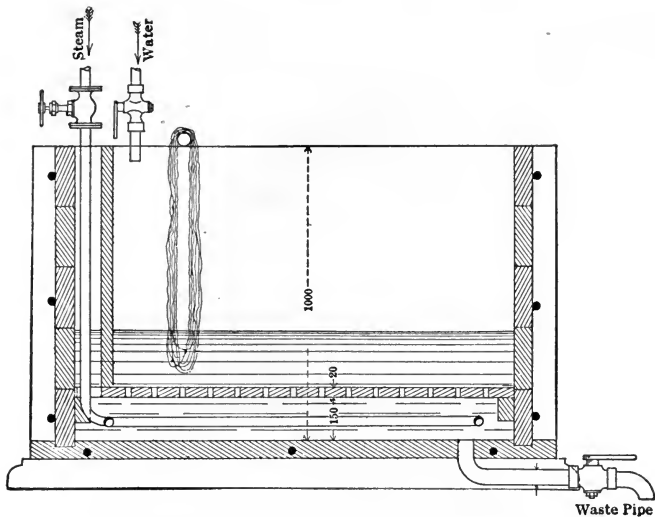

FIG. 14.—Dyevat for Yarn. (Direct Steam.)

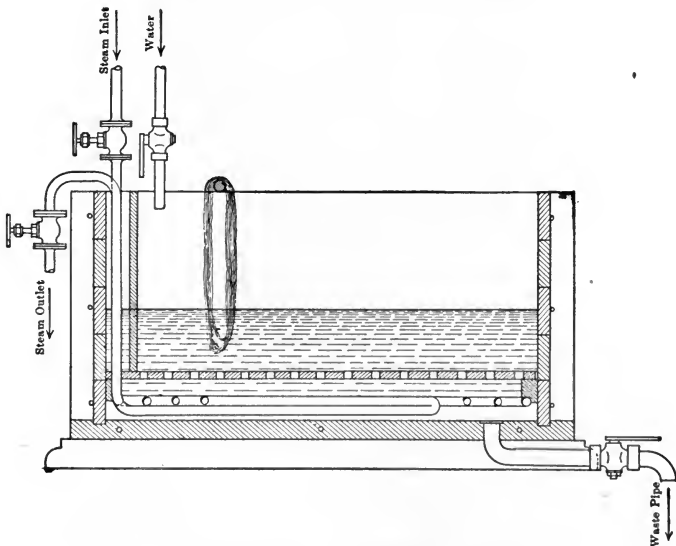

FIG. 15.—Dyevat for Yarn. (Indirect Steam.)

which may be employed. There are two general methods of procedure for this purpose:

(1) The textile material is simply immersed in the dye liquor, and moved about or "worked" in such a manner as to promote an even distribution of the color. The form of the material being dyed will, of course, necessitate modifications in the method of handling. In the case of loose wool or cotton, the material is immersed in a suitable vat or tank containing the dye liquor, and is stirred about from time to time by means of poles. When

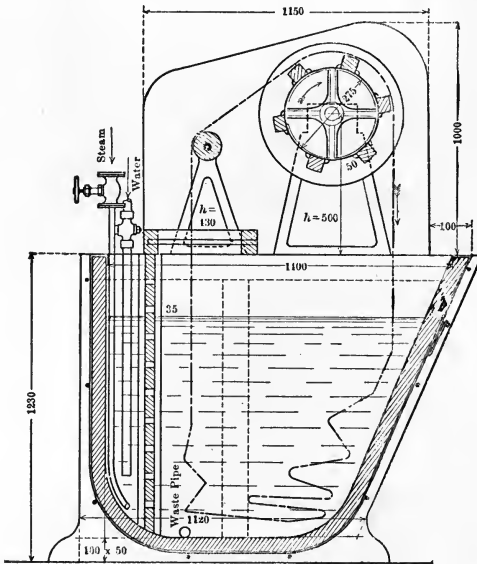

FIG. 16.—Winch for Dyeing Cloth.

yarn is to be dyed, the skeins are placed on sticks and hung in the dye liquor contained in a tank of suitable dimensions and usually of rectangular form, the sides of the tank supporting the dye sticks. The position of the hanging skeins is changed from time to time by turning so that every part will be equally exposed to the action of the dye liquor. In the case of cloth (or woven fabrics in general), the ends are joined together, thus forming an endless string which is run continuously through the dye liquor over a rotating "winch." Of course various mechanical devices have been introduced for the purpose of economizing labor and for auto-

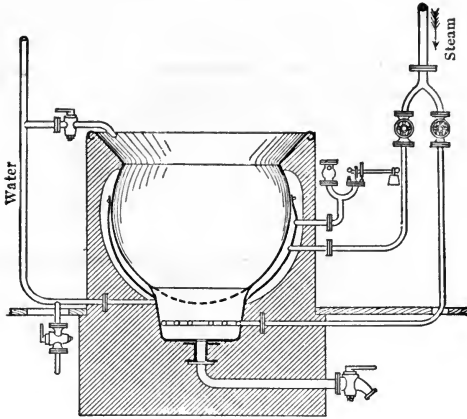

FIG. 17.—Hand Vat for Dyeing Loose Stock. (Both Direct and Indirect Steam.)

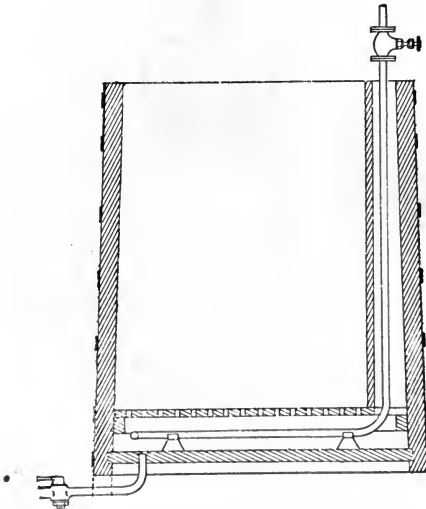

FIG. 18.—Round Wooden Dyevat, Vertical Section.

matically moving the material with a minimum amount of injury to the fiber. Although a considerable quantity of loose wool and cotton is still dyed in the primitive fashion by hand poling, the more approved method is to employ machines for stock-dyeing. These usually consist of a large basket divided into several interior compartments. The stock is loaded into the basket which is then made to rotate in the dye liquor contained in an outer tank into which the basket fits. Yarn may be dyed by placing it on sticks held in a revolving frame which moves slowly through the dye liquor. Cloth may be automatically run through the

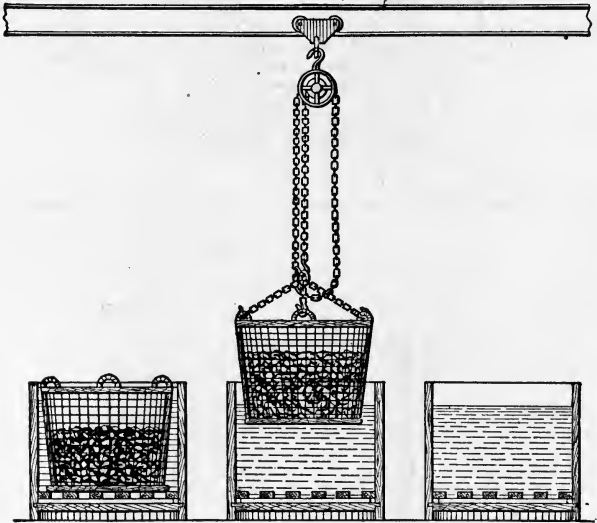

FIG. 19.—Series of Vats for Dyeing Loose Stock.

dye liquor in string form by means of moving rollers, or it may be moved back and forth in open width by passing from one roll to another (as in the jigger).

(2) The material to be dyed may be held stationary in a compact form and the dye liquor is circulated through it by means of pumps or steam or air pressure. Machines of this type are coming into vogue very largely at the present time, as they possess the advantage of being able to handle large quantities of material in a small space, and furthermore they do not injure the goods by the mechanical straining and fric-

tion necessitated in the older methods. Large economies in dyestuff, steam, and water are also possible.

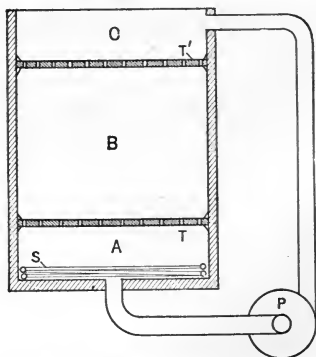

FIG. 20.—Showing General Principle of Pack System of Dyeing.

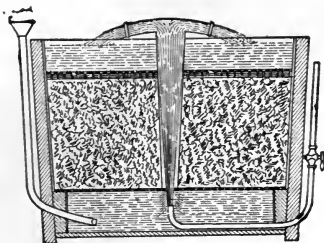

FIG. 21.—The Dreze Dyeing Machine. (Showing Pack System.)



FIG. 22.—Revolving Cylinder Type Raw Stock Dyeing and Bleaching Machine. (Delahunty Dyeing Machine Co.)

The construction and methods of operations of the various types of dyeing machines will be taken up in detail in their proper connection.

The practical operation of dyeing usually necessitates several consecutive processes, as follows:

- (1) Scouring (or wetting-out);
- (2) Dyeing (which may also include a mordanting operation);
- (3) Rinsing;
- (4) Hydro-extraction (or removal of the excess of water by squeezing, centrifugal action, or wringing);
- (5) Drying.

The exact nature of these processes and the appliances employed in carrying them out will depend very largely on the character and form of the material being dyed.

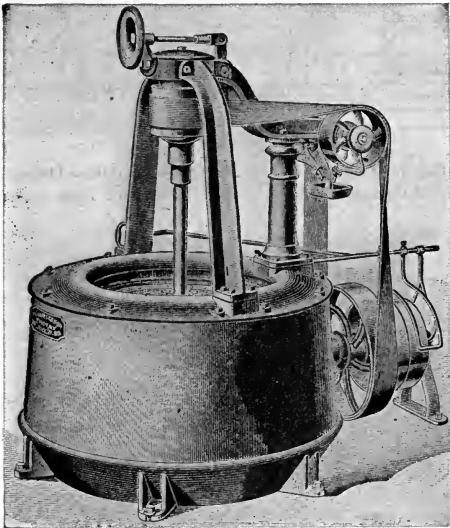

FIG. 23.—Hydro-Extractor. (Tolhurst.)

6. Water and Steam in the Dyehouse.—As water is used in relatively large quantities in nearly all the operations of dyeing, it becomes an essential feature to be considered carefully in the practical dyehouse. It is not only necessary that water be available in large quantities and at a low cost, but also that it be comparatively pure in quality, of a low degree of hardness, and contain a minimum amount of iron. Owing to the importance of the water in dyeing, it will receive a special consideration in the course of this work.

The amount of water required in dyeing operations depends both on the nature and character of the fiber as well as the construction

and form of the machine in which the dyeing takes place. When the material is dyed in the open—that is to say, not packed tightly in the machine, but where the goods are required to be worked in the solution—there will be required a sufficient volume of water to properly manipulate the goods. Cotton takes less water than wool or silk, being a more compact fiber and yielding denser yarns and woven goods. It requires about twenty times its weight of water for the dyebath; that is to say, 1 lb.

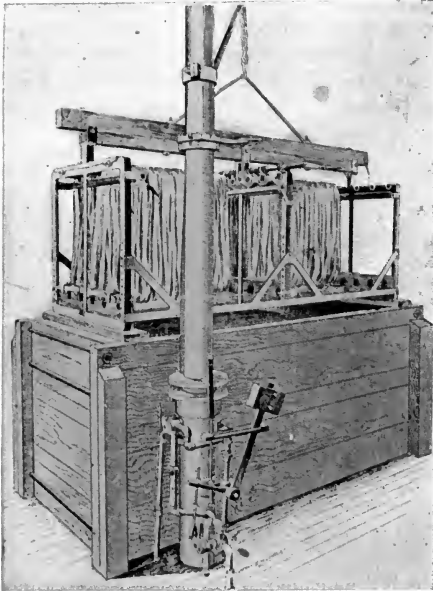

FIG. 24.—Yarn and Slubbing Dyeing Machine. (Lorimer Machinery Co.)

of cotton yarn, for example, will require about $2\frac{1}{2}$ gallons of dye liquor in which to dye it, and a vat for dyeing 100 lbs. of cotton is usually figured so as to contain 225 to 250 gallons of liquor. Wool and silk will require about twice the proportion of dyebath as cotton; that is to say, 1:40 or 1:50, or 1 lb. of wool (or silk) in skein yarn form will require about 5 gallons of dye liquor; less than this will be found impracticable, as it will not be possible to work the material satisfactorily in order to obtain uniform penetration. Where dyeing machines are used of such a character that only a portion of the material is in the dye liquor at any one time,

or where the material is tightly packed and the dye liquor is circulated through it, a much smaller proportion of liquor will be needed than that mentioned above. Under these conditions the relative proportions of water and fiber may drop down to as low as 1:15 or even 1:10.

For purposes of rinsing after dyeing it will require at least as much water as originally employed for dyeing, the purpose being to replace the residual dye liquors held in the interstices of the yarns and fibers with clear fresh water so as to wash away the color which would otherwise be superficially deposited on the goods. In general it may be stated that each pound of dyed yarn will require from 2 to 5 gallons of water for proper rinsing. Of course, there may be cases where a much more thorough rinsing is necessary, and in consequence, a greater proportion of water will be needed.

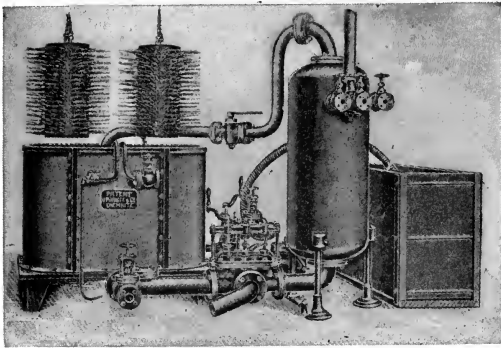

FIG. 25.—Cop Dyeing Machine.

As most of the liquors employed in dyeing, scouring, etc., are heated and often require to be raised to the temperature of boiling, it is manifest that large quantities of steam are used in the dyehouse. In the old days, dyevats were heated by direct fire, but at the present time steam heating is universally employed. Heating by steam may be done either by the use of a closed coil of pipe, or by the use of a perforated pipe, and thus blowing the live steam directly into the liquor. The former method is preferable, as it does not introduce into the dyebath any of the impurities (such as oil) which may be carried along by the steam. Also the dyebath does not become continually diluted by water from the condensed steam. Another bad feature of having live steam blowing directly into the bath is that it causes excessive agitation in the liquor which may result in the tangling and felting of the goods, and also the goods directly

in contact with the live steam are in danger of becoming overheated and injury to the color or to the fiber itself may result. Economy in the use of steam has an important bearing on the actual cost of dyeing. As steam for the dyehouse is usually obtained in connection with steam for the power plant, it is often possible to employ the exhaust steam from the engine for the purpose of heating the dyevats. This, however, is not possible where a condenser type of engine is used, though arrangement may be made whereby the hot water from the condenser may be utilized. Steam for heating dyevats should not be employed at a very high

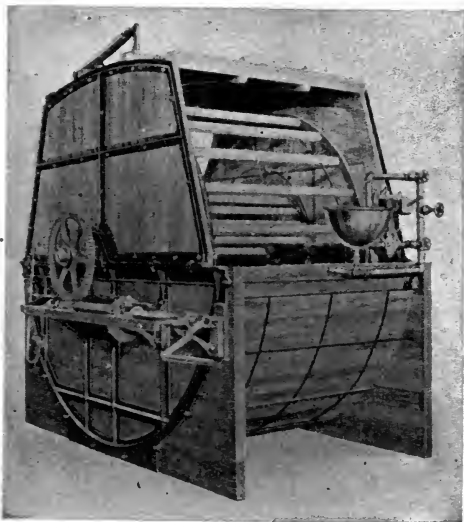

FIG. 26.—Skein Dyeing Machine. (Giles Dye Machinery Co.)

pressure (such as employed for engines), but a reducing valve should be introduced into the steam-main coming into the dyehouse so that the pressure may not be over 40 lbs.

The problem of removing the dense vapors usually encountered in a dyehouse is an important one, both on account of the health of the operatives, and for the production of good work. These vapors may be removed either by the use of a suction fan or by the natural ventilation obtained by a suitable arrangement of the dyehouse roof. In cold weather satisfactory results in the removal of fog cannot be obtained unless heated air be introduced into the dyehouse in case suction fans are employed,

for as the fan expels the air from the dyehouse, if fresh cold air is drawn in from the outside it will help to increase the fog by lowering the temperature inside. A good plan is to draw the entering air from the heated drying rooms or the boiler house, and this will be found to expel rapidly any fog produced in cold weather. In case the dyehouse is located in a separate building of a single-story construction, it is possible to arrange

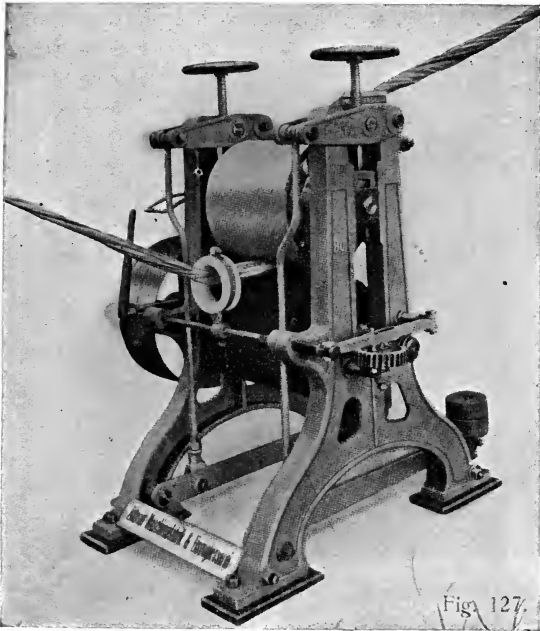

FIG. 27.—Squeezing Machine for Cloth or Yarn.

the roof in such a manner as to give excellent ventilation which will effectually remove all fog in both warm and cold weather.

As proper light has an important bearing on the problems of color matching, a dyehouse well lighted from a northern exposure would be the most suitable. This, however, cannot always be practically realized; although under the conditions prevailing the best light possible should be given the dyehouse, and the usual practice of placing this department of the mill in a dark basement should be condemned.

7. Forms in Which Textiles are Dyed.—With respect to the form in which textile materials are dyed, this varies greatly with the circumstances of manufacture. Wool is extensively dyed in the loose state, and also in the form of slubbing and tops. Yarns of both wool and worsted are also largely dyed. In cases where woven fabrics are to be finished in solid colors, the dyeing is generally done in the piece. Cotton is also largely dyed in the loose state, though both yarns and piece-goods are extensively colored. Silk is dyed chiefly in the form of skeins of yarn, and to a much less degree in the piece. Loose silk, of course, can only be dyed in the case of waste silk. In the case of both cotton and wool, it is

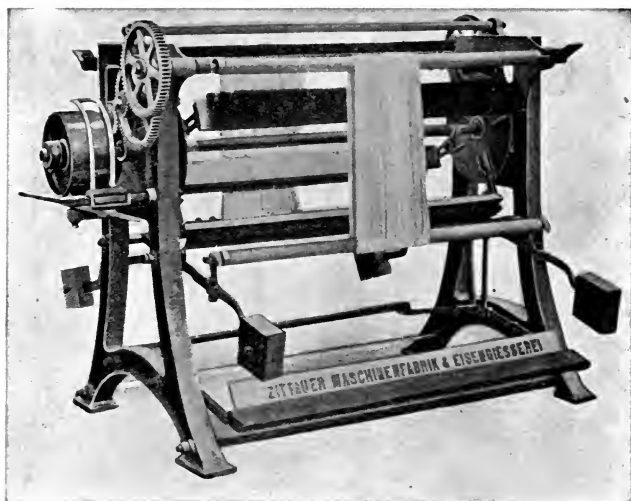

FIG. 28.—Machine for Brushing and Lustering Skein Yarns.

cheaper to dye in the loose state than in the form of yarn, and there is but little trouble experienced in getting the resultant yarn even in color, as the carding, drawing, and spinning processes will even up any irregularities which may have been formed in the dyed color of the loose stock. The color also has better penetration and in some cases is faster. There is also a considerable saving in the manufacturing costs, for when yarn is dyed it is necessary to reel the yarn from the cops or bobbins (on which it is spun) into the form of skeins; these latter are then dyed, and must again be wound back into the desired package, such as bobbin (for weaving), cone, or tube. Whereas, if the material is dyed in the loose stock, the cop

or bobbin obtained by spinning is used directly for weaving, or is wound directly into tube or cheese, if desired for other purposes. There are some drawbacks, however, to dyeing in the loose state. In the first place, there is always more or less of the colored material left over in the manufacturing in the form of card waste, slubbing, roving, etc., which has a lower value, as it is much harder to utilize than if the fiber were undyed. In the

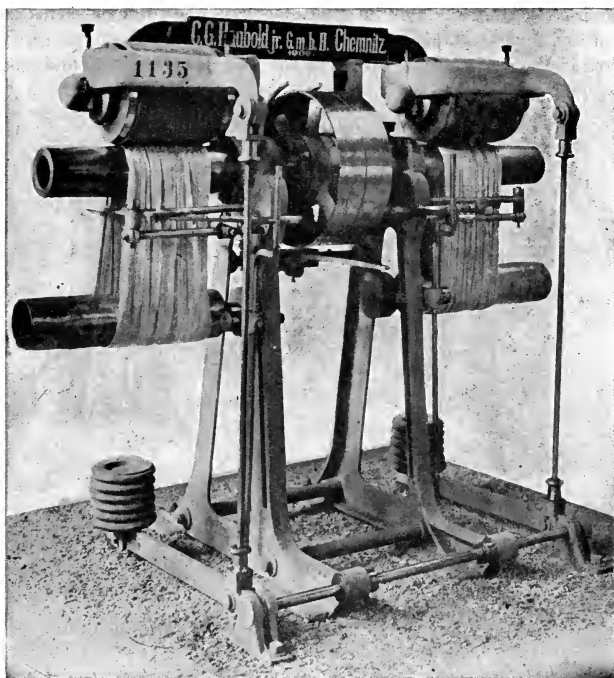

FIG. 29.—Yarn Glazing and Softening Machine.

second place, the dyed stock is generally somewhat more difficult to manufacture and spin than the undyed, the fibers becoming more or less matted together, and lose considerable of their elasticity and good spinning qualities. In the case of cotton, most of the natural wax on the fiber is removed so that the stock is difficult to card and spin. On this account it is not always feasible to dye cotton in the stock, as the fiber may be left in a condition impracticable for spinning. Furthermore, stock dyeings, as

a rule, do not have the brilliancy or purity of hue, which is obtainable in skein dyeing, for the manufacturing processes through which the stock must pass deteriorate, more or less, the quality of the color. Dyeing in the piece is of course the cheapest form of handling textile materials, as in this case there is no after-waste of dyed material; but, of course, piece dyeing is limited to the production of solid colors—that is, a single color over the entire piece. There are, however, certain methods by which two color effects may be obtained, such as using mixed fibers (wool and

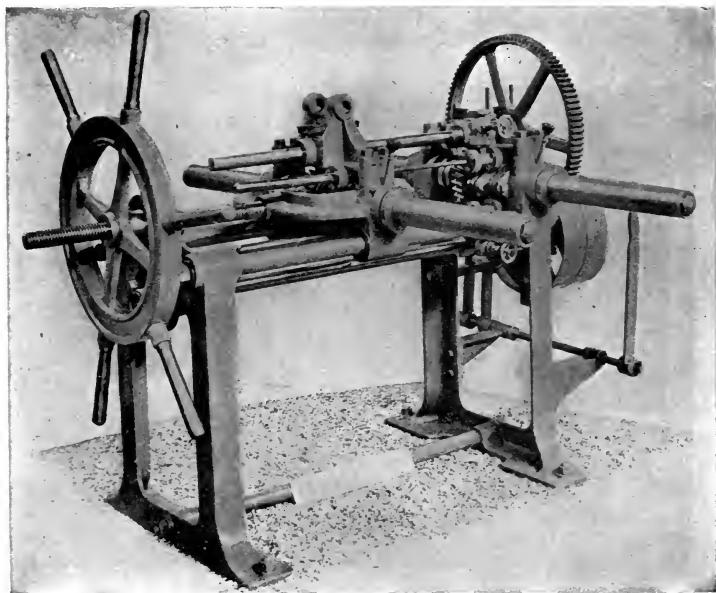

FIG. 30.—Stretching and Glazing Machine for Yarns.

cotton, silk and cotton, etc.) or by employing yarns especially treated so as to take a deeper color or not to take the color at all (resist yarns).

8. Hydro-extracting and Drying.—The purpose of hydro-extracting (or squeezing) is to remove the large amount of water which is mechanically held in the interstices of the fibers so as to permit of better and more rapid drying. Yarns, cloth, etc., even after thorough squeezing will still retain from 1 to $1\frac{1}{2}$ times their weight of water. By hydro-extracting in an efficient form of centrifugal machine the proportion of water left in the goods is about 65 to 100 per cent of their weight; that is to say, 100 lbs.

of dyed and rinsed yarn, for instance, after being properly centrifuged will still contain about 65 to 100 lbs. of water.

The drying of dyed material is a process which has to be carried out carefully, and in many cases with proper respect to the dyestuff employed. The apparent color of the material at times alters considerably on drying; this is especially true of cotton, which always appears much darker in color when wet. Nearly always some form of artificial drying is resorted to, as drying in the air is generally inconvenient and also takes too long.

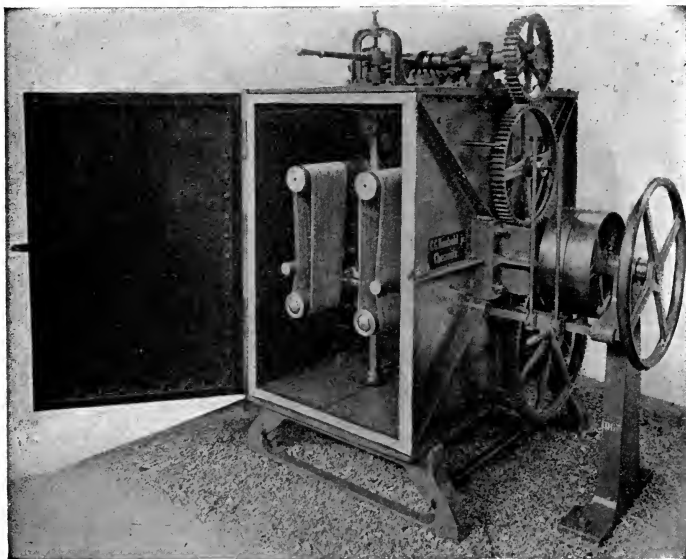

FIG. 31.—Silk Skein Stretching and Lustering Machine.

Generally suitably heated rooms are used, or machines specially constructed to take care of the material being dried. It is never well to dry at a very high temperature, as this will usually affect both the fiber and the coloring matter, though there is not much chance of danger if the temperature is kept at 180° F. or lower.

9. After-treatment of Dyed Material.—It is frequently necessary after dyeing to subject the dyed goods to further operations which may properly be considered as merely a continuation or finishing off of the dyeing process. Woolen material, for example, is sometimes soaped in order to remove

excess of coloring matter. Cotton dyeings are frequently passed through a softening bath containing usually an oil emulsified with soap or alkali. A small amount of oil is thus left in the fiber which has the effect of softening the goods as well as of brightening the color. Many operations of dyeing tend to make cotton harsh and stiff, as when mordanting with tannin and metallic salts or with sulphur dyes. The oil treatment much improves the appearance and handle of the dyed goods. Silk is very often "brightened" and "scrooped" after dyeing; this is usually accomplished by passing the dyed goods through a bath containing acetic or tartaric acid,

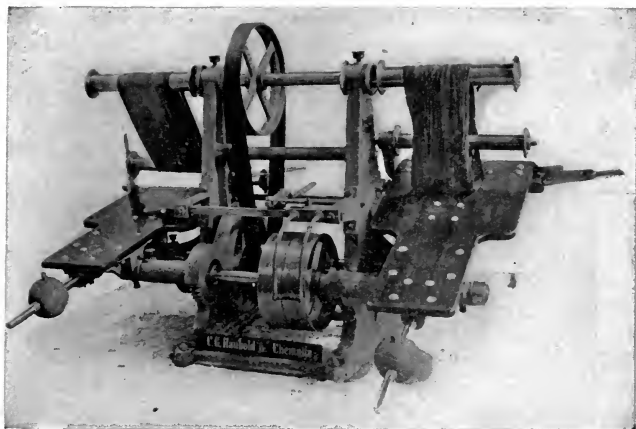

FIG. 32.—Yarn Stretching and Beating Machine.

squeezing, drying, or steaming and stretching in a special machine. The effect of the acid is to give the fiber a crackling or crunching sound when squeezed in the hand, which is the so-called "scroop"; while the steaming and stretching serves to straighten out the fiber and give it a high luster. In old methods of dyeing woolen goods the dyed color was frequently "saddened" by passing the goods through a bath containing copperas (sulphate of iron). The effect of this was to form an iron lake with the dyestuff (usually a vegetable mordant coloring matter), which was always darker and duller than the other lakes, and thus dulled or "saddened" the color.

CHAPTER I

CHEMICAL STUDY OF THE FIBERS*

1. Action of Acids on Textile Fibers.—The animal and vegetable fibers show a marked contrast in their behavior with acids. Wool absorbs mineral acids (sulphuric, hydrochloric, and nitric) from solution and, unless the acid is quite concentrated, the fiber is not decomposed. The acid, in this case no doubt combines chemically with the wool on account of the *basic* nature of this fiber. This is evidenced by the fact that wool which has been treated with acid will dye with acid coloring matters much better than ordinary wool. Also, when wool is treated with a solution containing sulphuric acid and then washed until the wash waters are neutral, there will still be some of the acid remaining in the wool. Nitric acid, unless very dilute, gives wool a yellow color, especially if the acid is heated. Below a strength of 5° Tw., however, the yellow color is formed very slowly, and therefore nitric acid of this strength may be used for stripping many dyed colors from woollen rags and shoddy. Cotton, on the other hand, is rather easily affected by solutions of the mineral acids, especially when such a solution is allowed to dry into the fiber. Cotton does not possess any basic qualities, and therefore does not combine chemically with the acid, thereby neutralizing it, as in the case of wool. Unless employed in very weak solutions, all the mineral acids have a tendering action on cotton, causing a disintegration of the fiber through a breaking down of the cellulose molecule of which the cotton is composed. † The compound of cellulose so formed is known as *hydrated cellulose* and is brittle in nature. On this difference in the reaction of wool and cotton with acids is based the process of “carbonizing” or separating vegetable

* A very exhaustive consideration of the microscopical, physical, and chemical properties of the various textile fibers is to be found in the author's “Textile Fibers.” For the present purpose only those chemical properties of the fibers will be considered which possess a direct bearing on the processes of dyeing.

† With strong nitric acid, especially if mixed with sulphuric acid, cotton reacts in a very specific manner, giving rise to nitrated cotton, or gun-cotton. This is used as an explosive and as a basis for cellulose and pyroxylin products. When steeped for several hours in strong nitric acid (84° Tw.) cotton acquires the property of combining directly with acid dyestuffs, and is said to be “animalized.” Such a process, however, has never received commercial application, as it is impossible to avoid injury to the fiber.

fibers from wool in woven fabrics or in shoddy where it is desired to recover the wool and eliminate the cotton.

Organic acids (such as formic, acetic, oxalic, and tartaric) do not have the same tendering action on cotton as the mineral acids; formic and acetic acids, being both volatile, are removed from the fiber on drying and hence do not injure cotton; oxalic and tartaric acids, on the other hand, are not volatile, and if strong solutions are used somewhat tender the cotton when drying. From these facts it may readily be understood that when

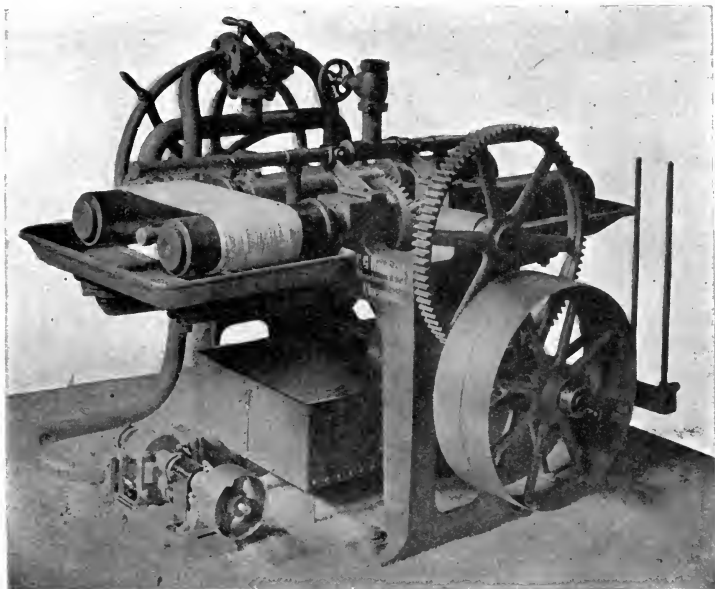

FIG. 33.—Skein Mercerizing Machine. (German Type.)

it is necessary to employ acid solutions in connection with cotton, it is always preferable to use acetic or formic acid for this purpose.

It will be obvious that in all processes of dyeing or bleaching where cotton (or other vegetable fibers) comes in contact with solutions containing mineral acids, or salts of an acid character, it is always necessary to remove completely the acid by thorough washing or by neutralizing with an alkali before the cotton is allowed to dry; otherwise the fiber will become weakened. This is frequently the source of much trouble in bleaching and dyeing.

What has been said with reference to the action of acids on cotton is also true of other vegetable fibers, such as linen, hemp, jute, etc., as well as artificial silk.

Silk behaves towards acid solutions much in the same manner as wool, and may be dyed in acid dyebaths without special injury. It is also extensively weighted by the use of stannic chloride, a salt of a strongly acid character. Silk, however, is not as resistant as wool to the effect of mineral acid solutions drying into the fiber, as the luster is liable to be affected, therefore all such acid should be thoroughly washed out of the

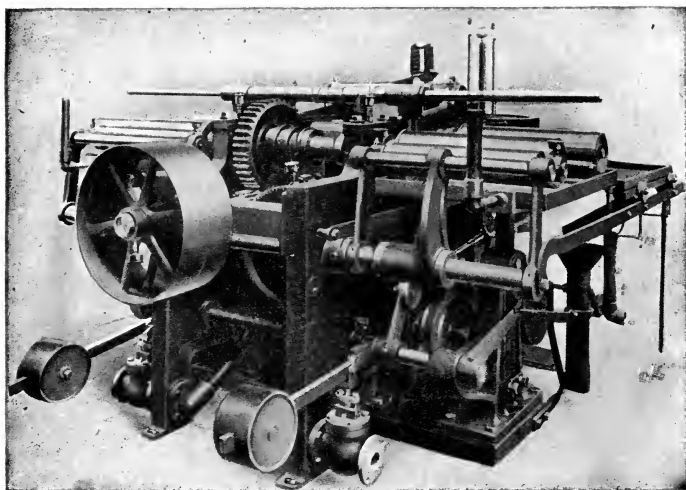

FIG. 34.—Yarn Mercerizing Machine with Hydraulic Tension: Automatic Type.
(J. Kleinwefer's Sons.)

silk before drying. In the case of hydrochloric acid the silk fiber is liable to become much weakened if the acid is allowed to concentrate in the fiber by drying. Weakened silk may frequently be traced back to this source of injury, especially with weighted silk.* Organic acids do not have a tendering effect on silk, and are generally to be recommended for use where an acid is required in a treatment of this fiber. If an organic acid is allowed to dry into the fiber the silk acquires a "scroop"; that is to say, it gives out a crunching sound when squeezed. Acetic and tartaric acids

* Sometimes the weakening effect does not become apparent until after the lapse of considerable time.

are particularly used in this connection. The luster is also increased, especially if the fiber (generally in the form of skein yarn) is stretched and steamed after drying. This acid and steaming treatment is known as "brightening" the silk.

Tannic acid (and the vegetable astringent extracts broadly classified under the general name of "tannins") has a rather special action on the textile fibers, differing quite radically in this respect from the other organic acids. Cotton readily absorbs tannic acid from solution in considerable

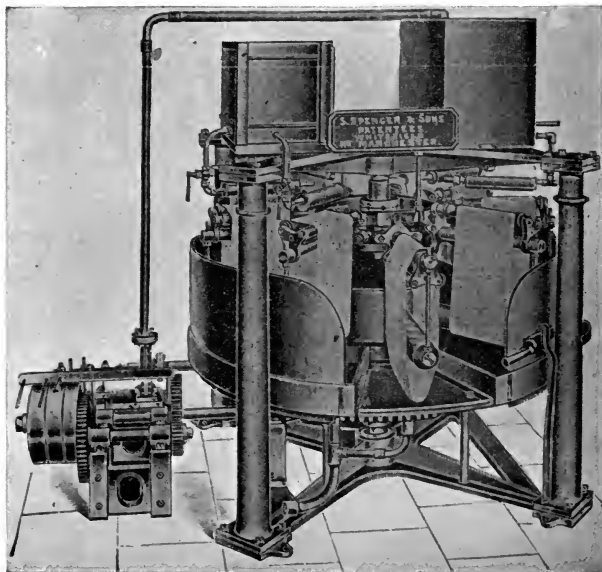

FIG. 35.—Skein Mercerizing Machine. (English Form.)

proportion, and though most of the acid may be removed from the cotton by washing in fresh water, nevertheless it may be permanently fixed in the fiber by treatment with a solution of a metallic salt with which it forms an insoluble tannate, such as tartar emetic (antimony potassium tartrate) and iron salts (copperas). On this process is based the general method of mordanting cotton for dyeing with the basic dyes, and the method is also used extensively in calico printing. Silk also absorbs tannic acid very readily, and the treatment of this fiber with tannin solutions is utilized in the weighting of silk for black dyeing, the tannin being fixed in this case

with an iron salt. Wool also combines with tannic acid, and the tannin may be fixed with tartar emetic or tin salts (stannous chloride). Wool treated in this manner develops the peculiar property of being quite inert towards many dyestuffs. The process is utilized in dyeing in what is known as the "resist" method.

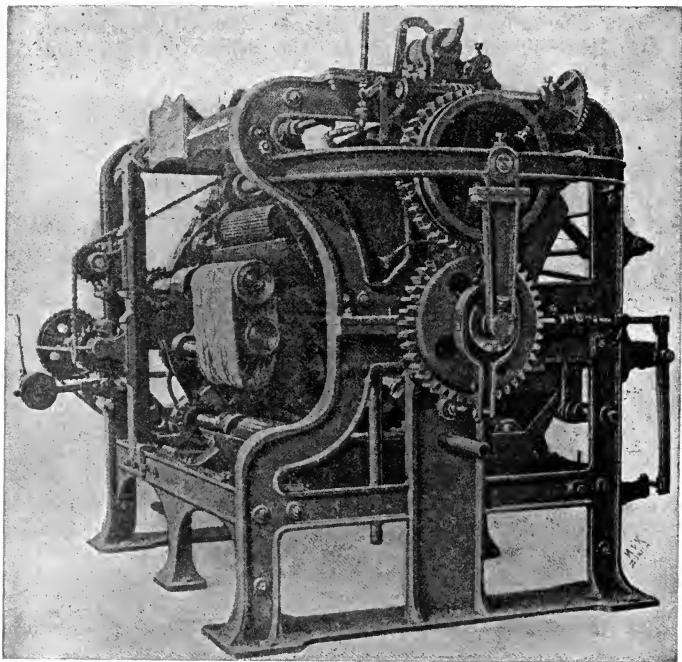

FIG. 36.—Skein Mercerizing Machine. (Swiss Type.)

2. Action of Alkalies.—Alkalies react with the animal and vegetable fibers in just the opposite manner to acids. Caustic soda, even in very dilute solutions and at not very high temperatures, will completely disintegrate and dissolve the wool fiber; whereas cotton is not affected. Even with solutions of sodium carbonate (soda ash) the wool fiber will be seriously weakened and injured in appearance unless such solutions are comparatively weak and employed at rather low temperatures. Due to these facts caustic soda cannot be used for the scouring of wool, nor should

it be used in any connection with wool.* Soda ash when employed in scouring or any other process in contact with wool, must be carefully handled in order that the solution of the same does not become too concentrated nor heated too high. Cotton, on the other hand, is not weakened by alkalies, and is scoured by the use of boiling caustic soda or soda ash without fear of being injured. Ammonium carbonate and ammonia water are much milder in their alkaline action and do not have any injurious effect on wool at ordinary concentrations, on which account they make very good scouring compounds, although too expensive for the majority of materials.

Concentrated solutions of caustic soda (50° Tw. or over) when used cold have a peculiar effect on wool; the fiber is not dissolved, but the luster is greatly increased and the fiber is hardened and loses its felting property to a considerable degree. The strong alkali must be used cold and must be washed out of the fiber quickly, and finally completely neutralized by washing in dilute acid. This process is made use of in the so-called "washing" of Oriental rugs; the rug is laid out and swabbed over with a strong caustic soda solution, which is then washed out with plenty of fresh water. The effect is to reduce the high colors somewhat, but mostly it is to give the woolen nap of the rug a good luster. The process is to be condemned, as it injures the fiber, and making it brittle, much reduces its life, and the result is that the rug rapidly wears out.

Silk is injuriously affected by alkalies in a manner similar to wool, only the fiber does not dissolve as readily in solutions of caustic soda; the luster and strength, however, are badly impaired. As raw silk is scoured in very strong boiling soap solutions, care should be had that the soaps employed should be free from uncombined alkali in order that the good qualities of the silk may be preserved.

3. Mercerizing of Cotton.—When cotton is treated with concentrated solutions of caustic soda it undergoes a peculiar change, known as "mercerization," derived from John Mercer, the discoverer of the process. If cotton (yarn or cloth) is steeped in a cold solution of caustic soda of 50 to 55° Tw. for several minutes and then thoroughly washed free from the alkali, it will be found to have shrunk very considerably (from 10 to 25 per cent of its length) and to have greatly increased in strength (from 10 to 40 per cent). If the yarn or cloth be maintained in a stretched condition so that it cannot shrink when treated with the caustic soda solution, and then washed free from alkali, still in the stretched condition, the fiber will be found to have developed a high degree of luster. This is especially noticeable in cotton goods made from Egyptian or Sea Island long-stapled fiber. This process is extensively used in practice for the production of mercerized or lustered cotton.

* Soaps, for instance, used in scouring or washing wool or woolen goods should not contain any free alkali (caustic soda or caustic potash).

There are two general methods in use for the mercerization of cotton yarns at the present time. The first and older method is that

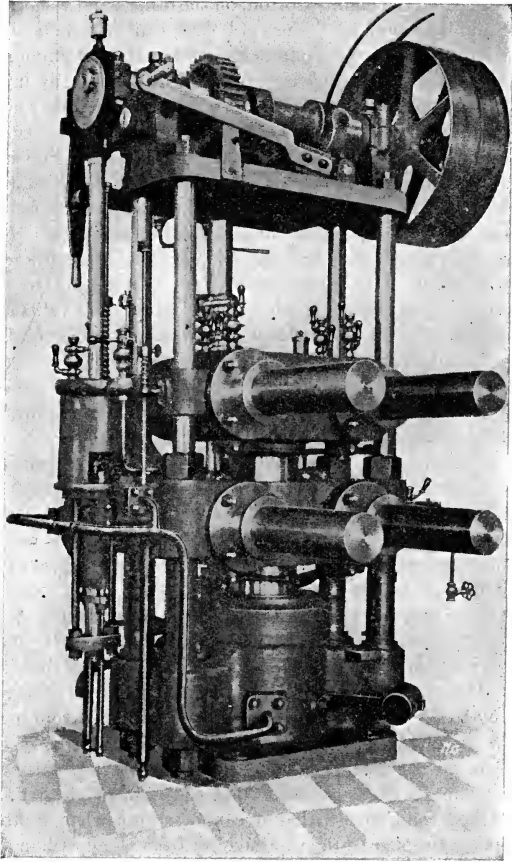

FIG. 37.—Lustering Machine for Mercerized Yarn.

of mercerizing the yarn in the form of skeins, and this requires the use of a skein mercerizing machine. This method of mercerizing was that first employed in the early days of the industry in Europe, both on the Conti-

ment and in England, and it is still the method which is almost exclusively used in the former, and even to a very large extent in England to the present day. The second method, and one which has been an American development, is known as the warp process, in which the yarn is operated on in the form of a long chain or warp in a continuous manner. The greater part of yarn mercerized in America at the present time is made according

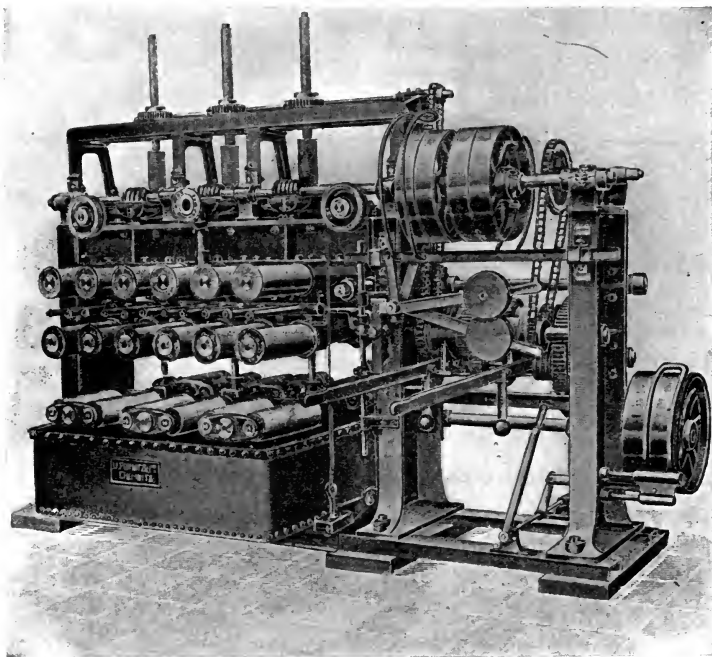

FIG. 38.—Skein Mercerizer; Vertical Type. (Pornitz.)

to the warp method, there being but a comparatively small amount of skein mercerizing done in the United States.

The skein method of mercerizing is more or less of a discontinuous process; that is to say, the various operations through which the yarn is required to pass do not take place in an unbroken sequence on the same machine. The yarn, for instance, is first boiled out in the ordinary manner in the kier or tank, as is customary for yarn in the form of skeins to be used for bleaching or dyeing. The hanks are then put on the mercerizing

machine, where they are subjected to tension and treated with a solution of caustic soda. The partial operation of washing is also carried out on

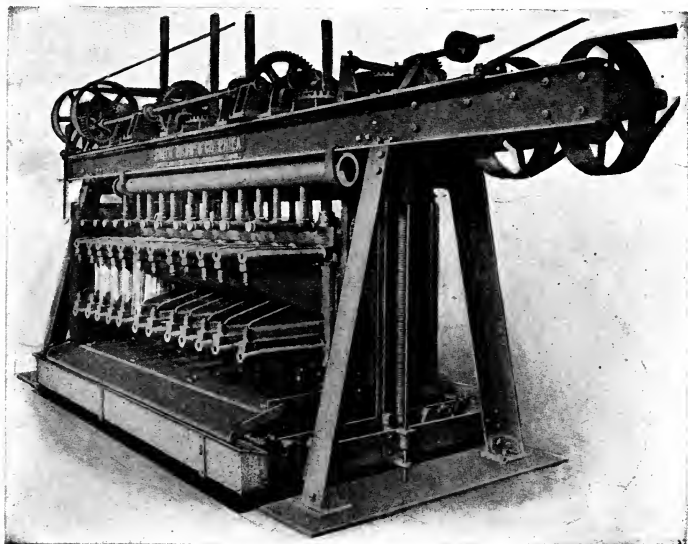

FIG. 39.—Skein Mercerizer. (Smith, Drum & Co.)

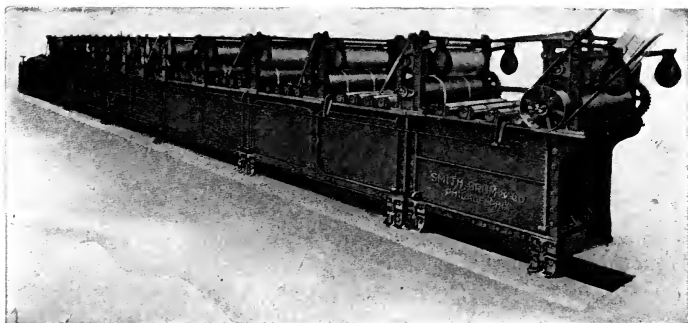

FIG. 40.—Warp Mercerizer. (Smith, Drum & Co.)

the machine without removal of the skeins, for the reason that the first step in the washing or removal of the strong solution of caustic soda from

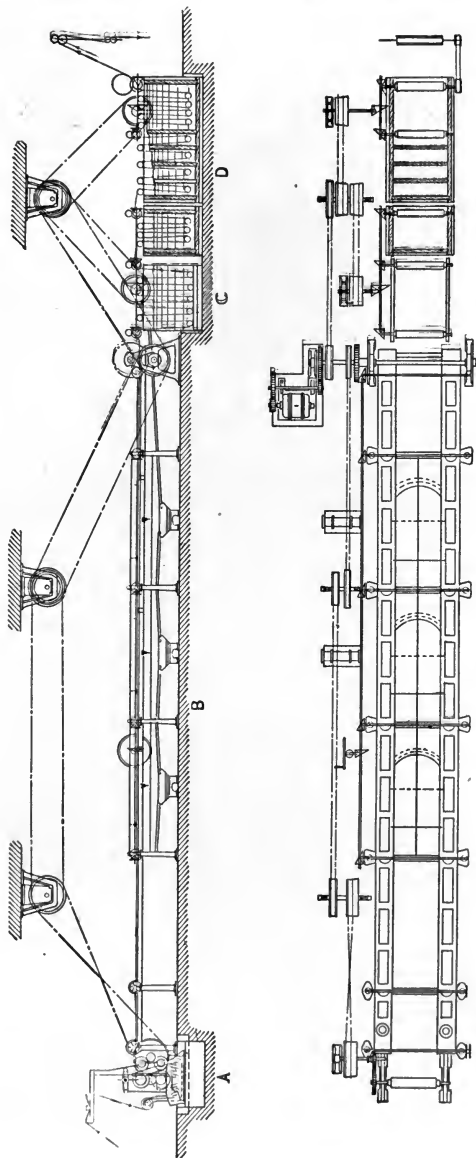

FIG. 41.—Mercerizing Range for Cloth Showing (A) Caustic Soda Padding Box; (B) Tentar Frame for Tension; (C) Sour Box; (D) Wash Boxes. (Mather & Platt.)

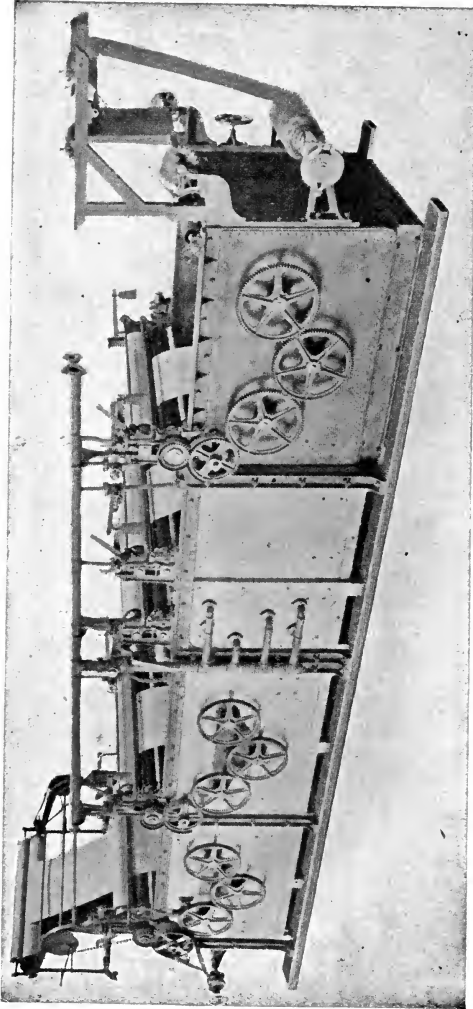

FIG. 42.—Machine for Souring and Washing Mercerized Cotton Cloth.

the fiber must be accomplished while the yarn is still under a state of tension. The skeins are then removed from the mercerizing machine and given a further washing, usually in an ordinary tank, though this process may also be effectually conducted in a skein washing machine. After the caustic soda solution has been removed from the fiber as far as practicable by washing, the yarn is next soured or treated in a bath of dilute sulphuric acid, usually in the ordinary form of tank. This is for the purpose of completely neutralizing the residue of caustic soda which is still left in the yarn even after thorough washing. A further washing operation has to be given in order to remove any excess of acid from the fiber, and also to take out the sulphate of soda which is produced by the reaction of the acid with caustic soda. Finally a finishing bath is given the yarn for the purpose of softening the fiber.*

In the warp process the yarn is first made up into long warps in a manner suitable for subsequent quilling if the yarn is to be converted back into packages such as cones, tubes, or skeins, or for beaming if it is to be employed directly for weaving warps. These warps are then run through the warp mercerizing machine, which is so constructed as to permit of the continuous treatment of the yarn in successive compartments to the operation of boiling-out, impregnation with the strong caustic soda solution, washing, souring, washing and finishing. In some cases, for special reasons, the boiling-out compartments are separated in sequence from the rest of the machine, so as to permit of the ageing of the yarn between the operations of boiling-out and treatment with the caustic soda solution. But even in this case the remaining operations are conducted continuously and *in seriatim*.†

* From this brief outline it may be seen that there are quite a number of different operations through which the yarn must pass in the process of mercerizing, and in the skein process this entails considerable handling and rehandling of the yarn back and forth between the different baths required. To the American idea this appears as an unwieldy and laborious method, entailing far too much hand labor to be economical in practice. It was natural to seek for a more continuous process in which the yarn could be handled economically and without breaking the sequence of the various operations. This naturally led to the development of the warp method. The skein method also gave but a comparatively small production on each mercerizing machine, and there was a considerable lapse of time in which the machine itself was not actually performing its special work; that is to say, the machine was practically "dead" during the time required for loading and unloading the skeins, and there was also considerable time consumed when the machine was putting on and taking off the tension on the skeins.

† From the standpoint of mill economy, the warp process has many marked advantages over the skein method of treatment. With respect to economical conservation of labor, automatic and continuous operation, as well as daily output of product, the skein method falls far behind in comparison with the warp process. But besides all this, there is another consideration which has proved to be important, especially in American practice, and this is evenness of the product with respect to its degree of

Cotton is also extensively mercerized in the form of cloth, for which purpose special machines are used. The goods (after singeing and preparing) are padded with the strong caustic soda solution and then carried on to a tenter frame which keeps the cloth in a state of tension while it is washed and soured. The cloth is then well washed and finished in the usual machines.

Cotton cloth is mercerized to a great extent not only for the purpose of giving the fiber a high luster, but also for the purpose of increasing the dyeing qualities of the goods and for the purpose of obtaining a translucent finish on such goods as cotton lawns, voiles, etc.

The mercerizing of cotton cloth in the piece, as far as the principles of the treatment are concerned, is exactly similar to that of mercerizing cotton in the form of yarn. There is, however, a radical difference in the method of treatment, necessitated, of course, by the form of the material to be handled.

mercerization. In the skein process we must bear in mind that the individual unit is the single hank or skein, and consequently the process deals with a large number of small units as compared with the warp process, where the whole warp itself forms the unit on which to operate. The sub-division of the yarn into small units, of course, allows of great possibility in the matter of uneven treatment of the separate skeins; whereas this is minimized in the case of warps where only a few large units are dealt with at a time. Furthermore, the frequent interruption in the continuity of the process and rehandling of the yarn in the skein method may also permit uneven treatment to creep in. But besides all this we have to consider the difference in the makeup of the yarn in the two cases. The skein consists of a single strand wound round and round and overlapping. The laps of the yarn around the skein are approximately equal in length, especially when carefully wound, as would necessarily be the case when the skein has been prepared with a view to mercerizing and when the skein is kept rather small in size. But this "approximate equality" in length allows of sufficient deviation to give an unequal tension on the individual strands when the skein as a whole is stretched over the rolls of the mercerizing machine. Furthermore, the skein is generally wound in such a manner that the laps are laid spirally back and forth the width of the skein, and this diagonal position across the line of tension must necessarily cause a slippage of the strands when they are revolving in a stretched condition around the rollers of the mercerizing machine in the caustic soda solution. Consequently, it may be seen from the very makeup of the skein there is a condition permitting of uneven tension, and hence uneven mercerizing. This condition is reduced to a minimum when the yarn is straight-wound in the skein, rather than cross-wound, and when the skein is kept to a small bulk so that there is not much overlapping of the strands on one another. This also supposes, of course, that during the reeling of the skein an even tension has been maintained on the yarn.

In the makeup of the warp the condition of the yarn is very different. In the first place the several strands of the yarn run through the warp in a fairly parallel manner, so that the direction of the yarn is in the line of tension as applied to the warp. In the second place, each strand in the warp is a separate and distinct thread, so that the thread, even in passing over the rollers of the machine, does not overlap on itself as is the case in the skein, so there is no chance of binding and uneven tension by the take-up of one lap on another.

From what has been stated on the mercerizing of cotton yarns, it will be readily understood that the mercerizing of cotton cloth in the piece requires the following processes:

(1) Treatment of the cloth to a preliminary boiling-out process whereby the fiber is brought into such a condition as to be readily absorbent of the mercerizing liquors. In the case of the heavier weaves of cloth, this boiling-out process must be especially thorough, otherwise the mercerizing liquors will not penetrate uniformly and completely through the mass of the fabric and this will lead to bad work.

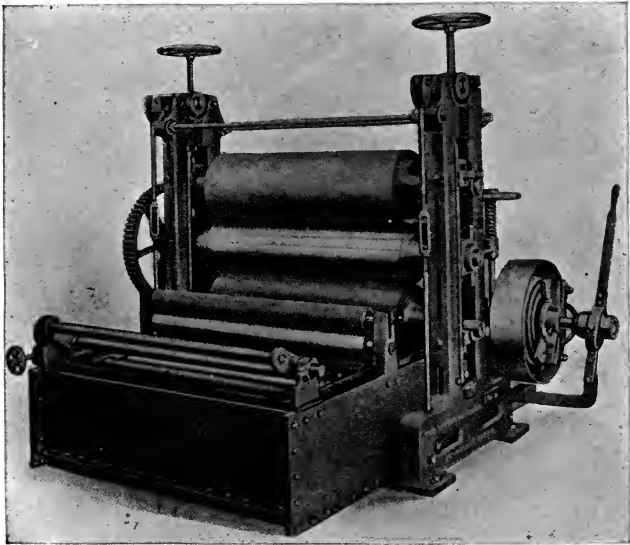

FIG. 43.—Mercerizing Paddle, 3-Roll. (Textile-Finishing Machinery Co.)

(2) Saturation of the cloth with a caustic soda solution of 55 to 60° Tw. This treatment is usually accomplished in a special form of padding machine provided with suitable squeeze rolls so as to force the caustic liquor well into the fiber of the goods. This solution is the mercerizing bath, and the temperature must be maintained below 70° F., and the density or strength of the liquor must be kept at a constant point by proper circulation and additions of stronger solutions to make up for the caustic soda which is taken up in combination with the cotton.

(3) Application of tension to the cloth immediately after it has become saturated with the caustic soda. This tension must also be applied in

both the direction of the warp as well as that of the filling, for both threads must be kept under proper tension to prevent shrinkage in either length or width. It is only in this manner that a proper degree of mercerizing can be brought about; for if tension is applied in the warp direction alone, these threads will be mercerized and lustered, whereas the filling threads will shrink considerably, causing the cloth to pucker, and furthermore these threads will not receive any luster, and the mercerizing of the cloth as a whole will be sadly defective.

(4) Treatment of the cloth with wash waters for the purpose of completing the mercerizing action and removing the majority of the caustic

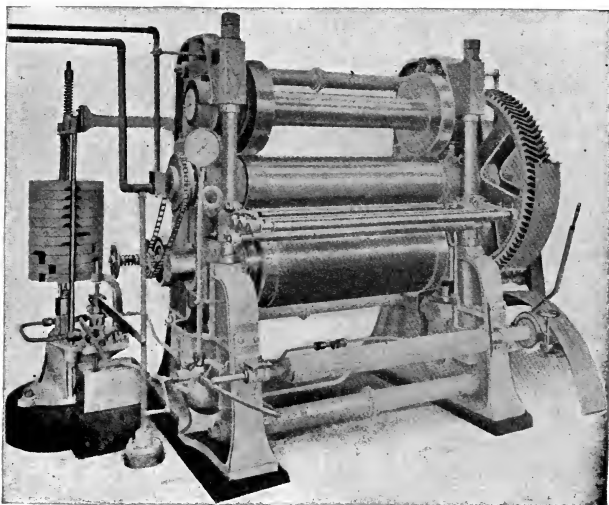

FIG. 44.—Machine for Lustering by Schreiner Process. (German Type.)

soda liquors from the goods. This washing, or at least the first portion of the washing, must be carried out while the cloth is still maintained in a state of tension, otherwise the goods will shrink up and the mercerizing effect will be lost.

(5) Treatment of the cloth with a dilute solution of acid for the purpose of removing the last traces of the caustic soda from the cloth. This treatment is not carried out with the cloth in a state of tension, as after the majority of the caustic soda has been removed by the washing with water, the mercerizing reaction is completed and the fiber is set in its permanently mercerized form; consequently the tension is no longer necessary.

In fact, the cloth at this point, that is to say, when the treatment with acid is carried out, shows a tendency to stretch out somewhat, rather than contract.

(6) A final finishing operation, usually employing a softening compound for the purpose of neutralizing any excess of acid, and also for the purpose of softening the fiber, which is rendered rather harsh by the treatment with the caustic soda as well as the acid baths. This operation may be considered as completing the mercerizing process proper. The

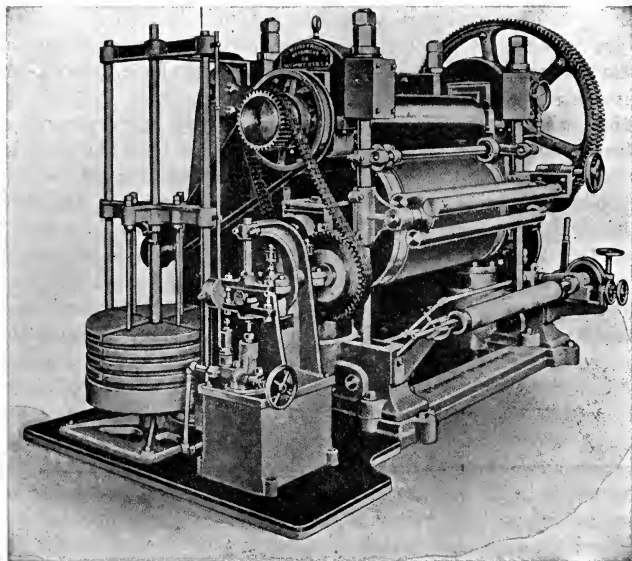

FIG. 45.—Hydraulic Schreiner Calender. (Textile-Finishing Machinery Co.)

processes of calendering, stiffening, embossing, etc., which may follow after the mercerizing, are to be considered further processes of finishing, and cannot be included within the scope of the mercerizing itself.

The boiling-out of cloth for mercerizing has to be done with more care and thoroughness than is the case with yarn. This is on account of the fact that the impurities in cloth are of a different character and of much greater amount than with yarn. While yarn has only the natural impurities of the fiber, cloth contains a quantity of sizing used for facilitating the weaving operations. This size consists of various mixtures of starch, fats, and gums, and is somewhat difficult to remove thoroughly. There-

fore, as a rule, a simple boiling of the cloth in soap solution, or soluble oil, or a dilute solution of alkali is not sufficient as is the case with yarns. The cloth must be subjected to a very thorough kier boiling in a manner similar to that used previous to bleaching cloth. A good soda boil in a high pressure kier for six to eight hours is required. This will decompose the starchy matter and saponify the fats and oils which may have been used in the size. After the boiling, a good washing must be given in order to remove all the decomposed matters. The boiling of cotton cloth previous to mercerizing should be always carried out with the purpose of obtaining as clean and pure a cloth as possible; impurities of any kind will act in a detrimental manner in the mercerizing process, and cause defects to arise in the cloth as well as giving deficient luster, the real object of the mercerizing process.

The saturation of the cloth with the mercerizing or caustic soda solution must be carried out with care and intelligence, for if the cloth is not evenly and thoroughly saturated the mercerizing or luster will not be produced with uniformity and defective cloth will be the result. The machine employed for saturation is of a special type built for this immediate purpose. It is a mangle usually with three bowls, the middle roll consisting of iron and the other two of hard rubber. Care must be had that the rolls are very even across their width, as otherwise the cloth would become unevenly saturated. The running of the cloth through the mangle should be so arranged that the piece gets two to three dips in the caustic soda solution with heavy squeezes between each dip. The caustic soda solution in the mangle must be maintained at a constant strength and cooled by means of circulation through a large reservoir of caustic soda, as was explained in the case of yarn mercerizing. Artificial cooling of the liquor in the mangle box is not necessary if this circulation is properly conducted.

In the case of light-weight fabrics like muslins, lawns, and shirtings, it will only be necessary to take the cloth through the saturating mangle once, so these goods can then be taken straight away from the mangle to the tenter frame for the purpose of putting on the required degree of tension. But with heavy goods, it will often be necessary to pass the cloth through the mangle twice before being fed into the tenter.

The tenter frame should be provided with special clips for mercerizing being made entirely of iron, as the usual brass clips would be rapidly attacked by the strong caustic soda liquors. These clips must also be especially strong and so adapted that a very considerable tension can be put on the cloth. The usual form of tenter employed for mercerizing ranges is of the self-feeding type; but even with this, it is necessary that great care be had that the clips take up the cloth evenly and tightly, and it is necessary to have a careful workman give this point his constant attention. If this is neglected there will be streaks across the cloth owing to irregular

mercerizing; a defect which will be emphasized if the cloth is subsequently dyed in light colors. The tenter frame is usually about 40 feet in length and will get off about 10,000 to 15,000 yards of cloth per day. As the cloth passes along the tenter frame under tension, it is first stretched out to its required width, then travels along at an even tension for some time. After traveling about half the length of the frame, the cloth is then subjected to the action of water through spray pipes above and below. The first washing of this kind is usually done with warm water, and the wash waters are caught in a basin below the machine.

When the cloth comes off the tenter the most of the caustic soda should have been removed from the cloth, after which the mercerizing action proper is finished, and the tension can be removed. Coming from the tenter frame, the cloth is next passed into a washing box where it receives a further good washing with cold water, the cloth of course being kept in the open width in all these operations after leaving the tenter frame. From the washing box, the cloth is carried through a similar box containing a solution of dilute sulphuric acid for the purpose of neutralizing the final trace of alkali which is practically impossible totally to remove by washing in water alone. The strength of the acid should be so adjusted as to leave but a slight excess of acid in the cloth after the alkali is neutralized. A further washing with cold water is now required to remove the excess of acid, and the process may then be considered as finished as far as the mercerizing process is concerned.

Frequently a further lustering operation is given the mercerized cloth by a special method of calendering, known as "Schreinerer." This consists essentially of calendering the cloth with a hot steel roll which is engraved with very fine lines running about 250 per inch. The direction of the lines usually runs at an angle to the length of the cloth, and is more or less conditioned by the direction of the twist in the yarn to get the best results. This operation is practically embossing the cloth in a pattern made up of fine diagonal lines so close together as to be invisible to the eye. The effect is greatly to enhance the luster, as it causes a peculiar reflection of the light rays. The Schreinerer process can be carried out on cloth independently of mercerizing, and is used to a great extent, for it produces a fabric which has a luster and appearance very closely resembling a silk fabric, and therefore it has come into great demand.

4. Action of Metallic Salts on Fibers.—Wool is quite reactive towards solutions of most metallic salts, absorbing many of them from solution and fixing the oxide of the metal in chemical combination with the fiber. For instance, when wool is boiled with a dilute solution of potassium or sodium bichromate (chrome), the latter salt becomes decomposed to a considerable extent and quite a proportion of chromium oxide becomes chemically combined with the fiber. This fact is evidenced by the wool

showing the presence of the metallic compound by its color and by being able to form a color-lake with certain dyestuffs which will not combine directly with ordinary wool.

Solutions of neutral salts such as sodium chloride (common salt), sodium sulphate (glaubersalt), magnesium sulphate, etc., have no apparent action on wool; only traces of these salts are absorbed by wool from solution, and they are readily washed out with water. Salts of the heavy metals, such as aluminium, iron, copper, tin, lead, manganese, zinc, etc., act in much the same manner as chrome, in that the wool absorbs the metallic base in the form of a mordant. Some of these salts tend to make the wool harsh, as is the case with stannous chloride, which makes the wool fiber rather harsh and brittle unless used in small amounts.

Cotton, on the other hand, has but very slight affinity for metallic salts, being very inert in this connection, as the fiber does not appear to be able to absorb and fix the metallic oxide as in the case of wool. Cotton is rather easily dissolved by a solution of copper oxide in ammonia (cuprammonium solution, or Schweitzer's reagent), from which it is precipitated in a gelatinous state by addition of acids. On this reaction is based the method of preparing artificial silk by the cuprammonium method (the so-called "glanzstoff" silk); also the method of waterproofing canvas by the Willesden process whereby the cloth is given a superficial treatment with the cuprammonium solution.

The reaction of wool with metallic salts forms the basis of the operations of mordanting wool preliminary to the dyeing with the alizarine and other mordant colors which require a base of some metallic oxide with which to form a color-lake; and also due to the inert character of cotton, this fiber cannot be readily dyed with these colors.

Silk, in its behavior towards metallic salts, is very similar to wool; that is to say, it absorbs the salt from solution and the metallic base is permanently fixed in the fiber. This reaction is the basis of the methods of mordanting and weighting silk. The so-called "nitrate of iron" (really a basic ferric sulphate) in conjunction with tannic acid is largely used for weighting black-dyed silk; while stannic chloride ("dynamite") is generally employed for weighting white or light-colored silk. A very concentrated solution of zinc chloride (140° Tw.) rapidly dissolves silk and may be used for estimating this fiber in the presence of wool and cotton.

5. Action of Chlorine Compounds and Oxidizing Agents.—Bleaching powder has a peculiar action on wool; this chemical is a strong oxidizing agent and in hot solutions of any considerable concentration will rapidly disintegrate the wool fiber. In cold and dilute solutions, however, a chemical reaction apparently takes place between the wool and the chlorine evolved by the bleaching powder, giving a product known as "chlored"

or "chlorinated" wool without much physical alteration of the fiber.* Wool so treated exhibits a much stronger affinity towards many coloring matters, and almost completely loses its felting properties, and acquires a higher luster. The process of chlorinating wool is extensively employed at the present time for producing unshrinkable woollen garments (chiefly underwear). For this purpose a solution of hypochlorite of soda is generally used, to which hydrochloric acid is added. The yellow color produced on the goods by this treatment is removed by sodium bisulphite solution, and the fabric is finally softened by a scouring with soap. The solution of sodium hypochlorite may be prepared in the following manner: First prepare a solution of 160 lbs. bleaching powder at 14° Tw. and add to this 100 lbs. of soda ash, gradually and with constant stirring. Then allow to settle and decant the clear liquor for use. It is not well to use a solution of bleaching powder of greater strength as there is then likelihood of sodium chlorate being formed, which is very objectionable by reason of its yellowing action on the wool. The solution of sodium hypochlorite prepared as indicated will contain about 4 per cent of available chlorine and show a density of 18° Tw. In the treatment of the wool about $\frac{1}{2}$ to 1 pint of this solution will be required for each pound of fabric. Hydrochloric acid is also added gradually in amount equal to about two-thirds of the hypochlorite used. It is best to add both the hypochlorite and the acid in several portions. The goods are treated for five to six minutes, cold. They are then well washed and treated in a bath containing 1 gallon sodium bisulphite solution (32° Tw.) per 100 lbs. of wool. A pint of sulphuric acid diluted with water is also added slowly to this bath. The goods are well washed again, and finally scoured in a warm bath containing soap and a little soda ash, and rinsed.† The chlorination of wool under

* This treatment of wool is perhaps not really a "chlorination" process, but rather one of oxidation; that is to say, the chlorine, as such, probably does not combine with the wool, but simply oxidizes it. This treatment causes the surface scales of the wool fiber to fuse together more or less and thus lose their sharp serrated edges. This would account for the increased luster and the loss of felting property. Chlorinated wool can readily be distinguished from ordinary wool by the use of the following simple tests: (1) If a single drop of water be placed on a fabric of chlorinated wool, it is quickly absorbed and the wet-out part is circular in form; with ordinary wool the water is absorbed very slowly and the wet-out part is irregular in outline. (2) If a fabric of chlorinated wool is wet-out and two surfaces of it are rubbed between the finger and the thumb a characteristic "scroop" is felt. (3) If chlorinated and ordinary wool are dyed together a very marked difference in color is noted. (4) If dry chlorinated and dry ordinary wool are rubbed together a sufficient charge of electricity will be developed violently to disturb an electroscope. Two pieces of ordinary wool when thus rubbed show no charge.

† Another method given for the preparation of chlorinated wool is as follows: Treat the wool first in a bath containing 1½ lbs. of hydrochloric acid (conc.) for every 10 gallons of water. Squeeze and work in a bath containing, for 100 lbs. hard-fibered wool, 15 to

the best conditions, however, materially injures the wearing qualities of the garment. This is not so much due, perhaps, to an actual rotting of the fiber, as it is to the removal of the felting property, so that the mechanical action of weaving and washing tends to detach the fibers from one another. Owing to the strong reaction of chlorine compounds with wool, materials like bleaching powder and sodium hypochlorite cannot be employed for purposes of bleaching this fiber; in fact hypochlorites do not bleach the wool fiber at all, but give it a deeper yellow tinge.

Chlorine compounds (like bleaching powder, etc.), also attack silk, and do not bleach it.

Cotton does not combine with the chlorine of the bleaching powder, but shows the strong oxidizing action of the latter in becoming bleached. This reaction is the basis of the method of bleaching cotton materials as well as all the other vegetable fibers.

Oxidizing agents, such as sodium and hydrogen peroxide and potassium permanganate, when employed in moderately dilute solutions, have no especially injurious action on any of the textile fibers, though they have the effect of destroying or bleaching out the natural coloring matter that tints the raw fiber a yellowish or brownish tone. On this account the peroxides of both sodium and hydrogen are extensively employed for the bleaching of wool and silk materials; they could also be employed for the bleaching of cotton (and the vegetable fibers in general) but they are not as efficient or as cheap in this respect as hypochlorites. Potassium permanganate may also be utilized for bleaching wool and silk, though in this case the manganese oxide left in the fiber must be removed by a treatment with oxalic acid or a solution of sodium bisulphite. The oxidizing action of permanganate is also too severe to give a safe bleaching, as the fiber is liable to be made harsh and tendered. This is also true with regard to the action of permanganate on cotton and the vegetable fibers, especially the bast fibers that are composed of several cells. In this case the strong oxidizing action of the permanganate together with the action

20 lbs. of bleaching powder to 350 gallons of water, or for soft-fibered wools, 20 to 25 lbs. of bleaching powder to 475 gallons of water. The bleaching powder solution should have a strength of 0.6 to 1.0° Tw. Work in this bath for one-half hour, then add 3 ozs. of hydrochloric acid per 10 gallons of bath and run for ten minutes longer. Next re-enter the first acid bath to which has been added 8 ozs. of hydrochloric acid per 10 gallons of water. Work for fifteen minutes then wash well in cold water. If the odor of chlorine is still perceptible in the wool it is advisable to treat it for fifteen minutes in a bath containing 2 per cent (on the weight of the wool) of sodium bisulphite (36° Bé.), then rinse well again. If wool yarn chlorinated in this manner is woven with ordinary wool yarn and then dyed in the piece, a two-color effect will be obtained, owing to the chlorinated wool taking on a much heavier shade than the untreated wool. Also if the piece is suitably woven in pattern effect and fullled, the chlorinated wool will not felt together like the other wool, but will stand out sharply in the woven pattern. In this manner many novel effects in dyeing and finishing may be produced.

of the sodium bisulphite is liable to break down the intercellular matter between the separate cells and cause a disintegration of the fiber.

6. Effect of Moisture on Textile Fibers.—Wool, cotton, and silk will all absorb considerable quantities of moisture from the air. This

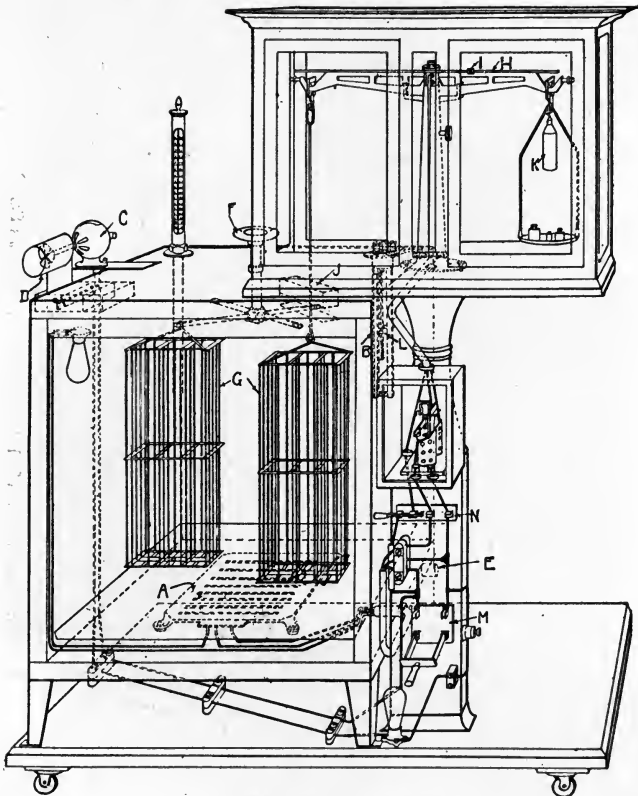

FIG. 46.—Emerson Textile Conditioning Oven.

ability to absorb moisture is known as their *hygroscopic* property, and it has an important influence on the various operations to which textile materials are subjected. As the quantity of moisture the fibers will contain varies with the atmospheric conditions, this hygroscopic quality also has considerable influence on the true weight or any given amount of

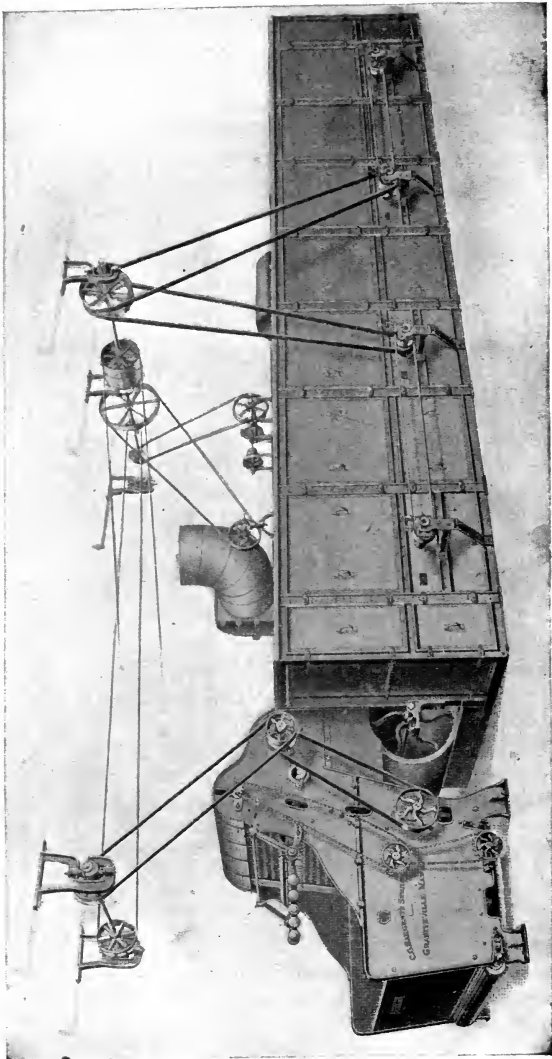

Fig. 47.—Raw Stock Wool Dryer. (C. G. Sargent's Sons.)

material, consequently it has an important bearing on the proper valuation of these fibers in commercial transactions where they are bought and sold by weight. Under normal atmospheric conditions (about 70° F. temperature and 70 per cent humidity), wool will contain about 12 per cent of moisture, cotton about 5 to 6 per cent, and silk about 12 per cent. In trading in wool and silk it is usual to have a certain standard of moisture allowed (known as *regain*). The determination of this is known as conditioning, and is carried out by drying the material in a suitable oven so that all the moisture is driven off. To the dry weight thus obtained there

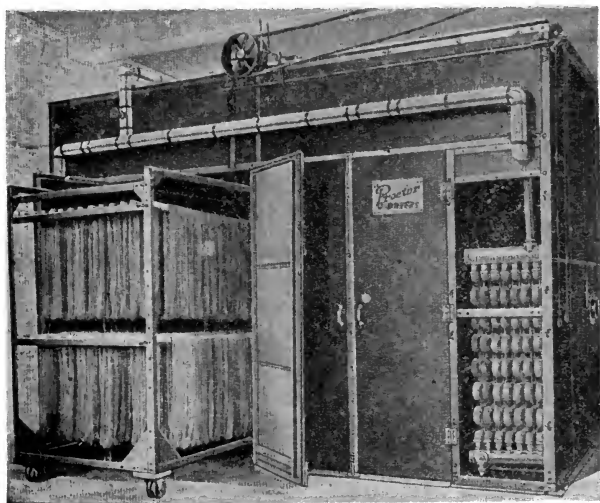

FIG. 48.—Yarn Truck Dryer for Cotton, Wool, Worsted and Silk Yarns, Tapes, etc. (Philadelphia Textile Machinery Co.)

is added the regain allowed and this is known as the conditioned weight. In this country the standard regain for silk is 11 per cent, and for wool 12 per cent, though the latter varies according to circumstances.

In the manufacturing operations the working qualities of the fibers are largely affected by moisture. In the spinning of fine cotton yarns it is necessary to have very humid conditions so that the fiber may be kept moist and plastic. In the processing of wool and silk also especial attention must be paid to this feature. So important is this for the production of uniform and good quality material that at the present time all well-organized textile mills are equipped with suitable conditioning systems

whereby a proper and uniform moisture condition can be maintained, otherwise the quality of the product would vary from day to day with variations in the humidity of the air.

In the carding, spinning, and twisting of cotton and woolen yarns a considerable amount of heat is developed by the friction of the fibers. This causes the fibers to become dry; in the case of cotton the amount of moisture may run as low as 3 to 4 per cent and with wool 6 to 8 per cent. This is a needless loss in weight if the yarn is to be sold immediately, for the

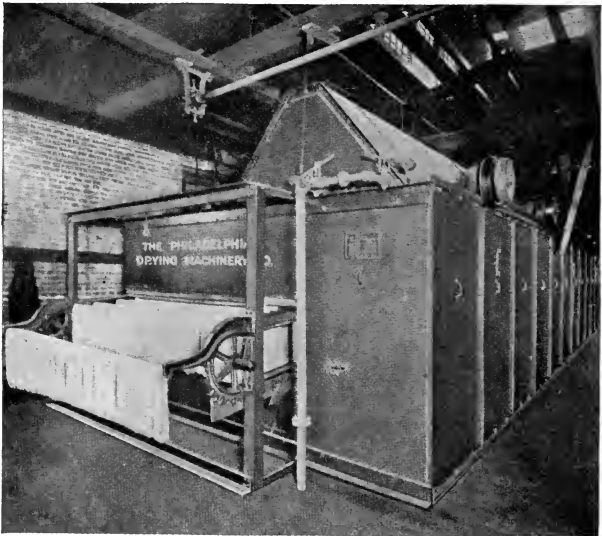

FIG. 49.—Automatic Yarn Dryer with Thermostatic Temperature Control.
(Philadelphia Drying Machinery Co.)

normal amount should be about 6 per cent for the cotton and 12 per cent for the wool. This lack of moisture also makes the yarns harsh and more brittle, thus reducing their good wearing qualities and softness of handle and texture. It is beneficial in such cases to *condition* the yarn. This is usually done by placing the yarn (on cops or tubs or in hanks) in a moist atmosphere until they regain the proper weight in moisture.

In the finishing and drying of textile fabrics of all kinds this matter of moisture in the fiber has always an important bearing. If the fiber is dried down to a bone-dry condition it is very liable to become perma-

nently deteriorated in quality and sometimes (especially with wool and silk) discolorations will be produced. It is not proper in drying operations to carry the moisture content much below that which would be normal under atmospheric conditions.

The electrical condition of the textile fibers is also greatly influenced by their hygroscopic conditions. When the fibers are very dry they easily become highly electrified and are difficult to handle in carding and spinning and winding. This electrification is especially noticeable in the

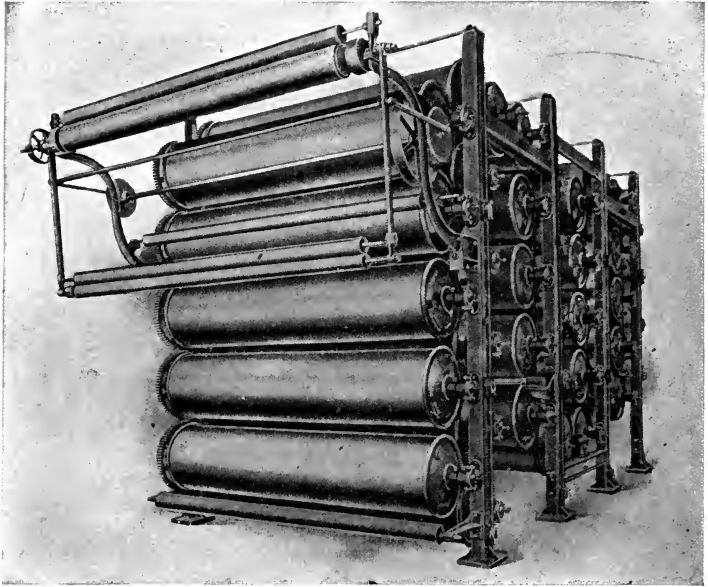

FIG. 50.—Upright Drying Cans for Cloth and Warps.
(Textile-Finishing Machinery Co.)

case of silk, and in reeling and winding this material it is necessary to keep it somewhat moist in order to have it run properly.

7. Action of Heat on Textile Fibers.—In the various operations of dyeing and finishing frequently relatively high temperatures are employed. Of course, in cases where the treatment is with solutions the temperature practically never exceeds 212° F. (100° C.), the boiling point of water. But in drying, pressing and dry steaming, the fibers may come in contact with much higher temperatures. Wool is rather easily injured

when subjected for any length of time to a dry heat exceeding 220° F. (105° C.), a gradual decomposition of the fiber taking place, while it soon acquires a yellow-brown color, and ammoniacal fumes are given off. At temperatures above 250° F. the decomposition is rather rapid. Silk is affected by high temperatures much in the same manner as wool. Cotton, however, is more resistant and can stand a prolonged exposure to a temperature which would soon discolor wool. At temperatures beyond 250° F. (120° C.), however, cotton will soon begin to show deterioration, and if exposed to higher temperatures a discoloration of the fiber will soon

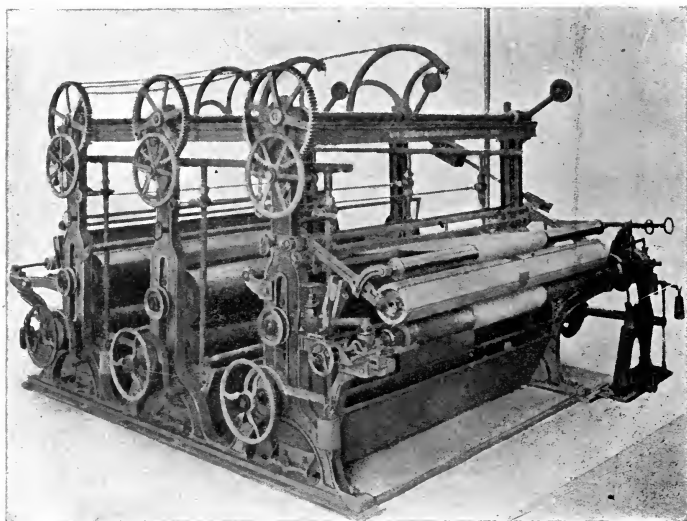

Fig. 51.—Crabbing Machine. (German Type.)

indicate gradual decomposition. All the fibers can withstand a much higher temperature of moist heat (steam) than of dry heat.

In cases where metallic salts (such as mordants, weighting agents, and fillers) are held in the fibers the effect of heat is generally much more injurious. Silk, for example, which is heavily weighted with tin, shows rapid deterioration when exposed to high temperatures. In the sizing and finishing of cotton goods magnesium chloride or zinc chloride is frequently added to the fibers; as these salts become strongly acid at high temperatures, the effect is to weaken seriously or tender the cotton. So

under such conditions, exposures to too high a temperature in drying or finishing should be carefully avoided.

Under the ordinary conditions of boiling the fibers are not injured by the heat, but occasionally conditions arise where high-pressure steam may come in contact with the goods in the boiling and this may result in damage to the material. In the kier boiling of cotton, for instance, where a closed pressure kier is used, and the precaution has not been taken to allow all of the air to escape, it is possible to have the highly heated steam come in direct contact with the goods not covered with the solution owing to displacement by the air, and the result will be burnt and tendered material.

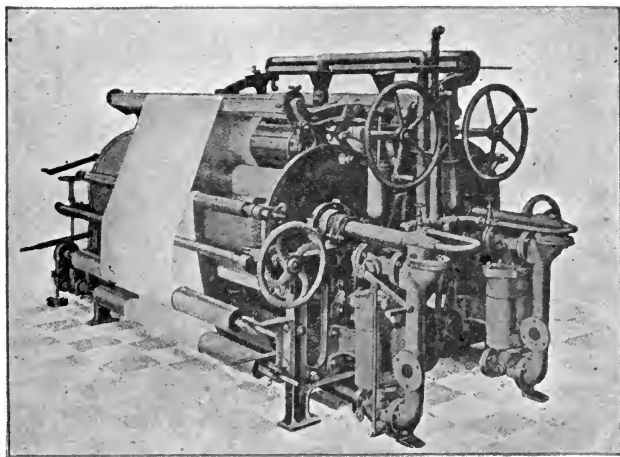

FIG. 52.—Crabbing and Lustering Machine.

8. Action of Hot Water on Wool.—When wool is saturated with hot water or moist steam, the fiber becomes soft and plastic; that is to say, it can be made to assume almost any form by suitable pressure. If the fiber is then cooled it becomes set in the form thus given it and will continue to retain the same in the dried condition. This property of wool (and other animal hair fibers) is made use of in many manufacturing and finishing operations for the production of certain effects. As good examples may be noted the formation of woolen (or fur) felt hats and the production of imitation fur effects on woolen pile plushes.

This effect of hot water or steam in making the wool fiber plastic is also the basis of the **crabbing process** for the removing of creases and wrinkles in fabrics containing woolen and cotton yarns. Such fab-

rics cockle up when taken from the loom owing to the difference in the elasticity of the wool and cotton threads; the wool being much more curly and elastic will take up or shrink more than the cotton when the loom tension is removed. The same effect also takes place in such goods when scoured and finished owing, in this case, to the more or less degree of felting together of the wool fibers, causing the wool yarn to shrink up more than the cotton and thus producing a cockled appearance.

The crabbing operation consists in passing the cloth in full width and under tension through boiling water, stretching and cooling and drying

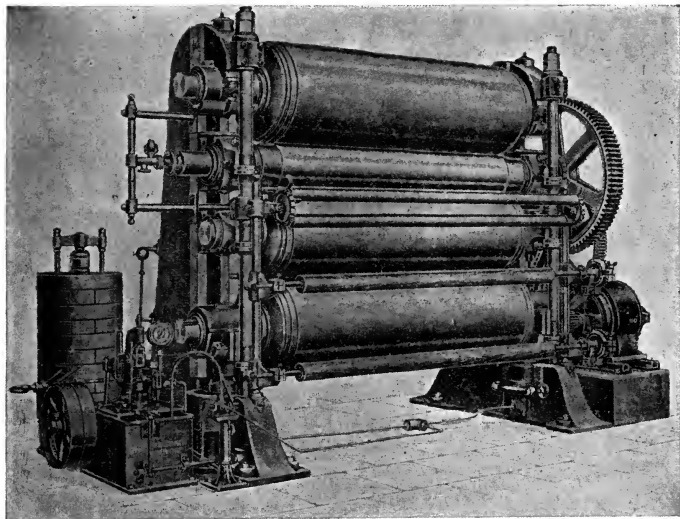

FIG. 53.—Hydraulic Calendar. (German Type.)

in the stretched condition. Or the cloth may be wound up tightly on perforated cylinders and placed in an apparatus so that steam may be blown directly through the goods. This treatment is then followed by forcing cold water or cold air through the cloth.* By arranging the proc-

* Fine qualities of wool which must have a soft and full handle are crabbed without pressure and the temperature of the water should be only 120 to 140° F. But cloth of very hard wool must be crabbed in boiling water so that the fiber may be sufficiently stretched. Crabbing with low pressure may be satisfactorily done by rolling on special beams, but when high pressure and tension are used the crabbing machine must be employed. After crabbing the pieces should be beamed on a wooden roller and allowed to cool down, then the pieces may be washed, either in the rope form or in full width,

ess so that the treatment with steam can be given under considerable pressure, the wool fiber also acquires a considerable degree of luster. This process then becomes known as "decatizing," and is extensively used on all-wool and worsted goods for the production of a high-luster finish and irrespective of any connection with a crabbing operation.

In the **decatizing process** the cloth is tightly wound on a perforated beam which is placed in a suitably constructed pressure cylinder provided with the requisite connections. The air is first exhausted from the cloth

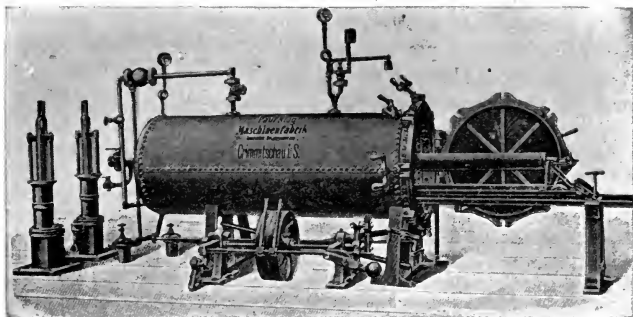

FIG. 54.—Apparatus for Decatizing.

by means of a vacuum, then high-pressure steam is forced through the goods for a brief time, followed by cold air or cold water.* The lustering using soap and soda or ammonia at 90 to 100° F. Material which is to have a soft, full handle is then generally crabbed once more, while hard material (like chevots) has to be steamed in order to avoid cockling and to impart a soft handle and fine luster.

* In the decatizing process a perforated iron or copper cylinder is used. This is first wrapped with several layers of cotton cloth, then three to six pieces are beamed on this cylinder and enveloped in canvas, the ends of which are tied up tightly. Steam at 10 to 30 lbs. pressure is then admitted through the axis of the cylinder until it has well traversed all the layers of the cloth, which usually takes from five to eight minutes. After the first steaming the pieces are allowed to cool in the beamed state (the cooling frequently being hastened by air suction), the object of which is to give the goods a more pronounced luster. The pieces are then drawn under tension on to another perforated cylinder and steamed again. This is for the purpose of making the process more uniform, as in this manner the portions furthest from the center where the temperature is greatest, are brought nearest the center in the second operation. After each steaming (especially when vertical rollers are employed) it is very necessary to place the rollers horizontally on a couple of supports and on no account vertically or slanting, and to turn the rollers every now and then for about half an hour in order to induce a uniform cooling action. It is always advisable to steam the goods before dyeing, and then after dyeing to steam again, but only slightly, as in this way the best results are obtained. Steaming before dyeing also has the effect of producing more level shades.

effect is doubtless due to the fact that under the action of the highly heated steam the outer scaly portion of the wool fiber is softened and as the fiber is held in a state of tension, the surface tends to assume a smooth rod-like appearance, whereby the serrations or joints of the individual scales become more or less fused together. This condition becomes fixed and permanent by the subsequent chilling and drying of the fiber still maintained in its set state of tension. This decatizing process is chiefly carried out on close-napped goods such as broadcloths and the like.

An operation very similar to that of decatizing is known as **potting**.^{*} This is a treatment of woollen goods with steam and hot water for the purpose of producing a particular character of finish. It is chiefly used on heavy suitings and broadcloth and the process and apparatus employed is much the same as in decatizing.

9. Experimental. Exp. 1. Action of Acids on Wool and Cotton.—Place about 300 cc. of water in one of the porcelain beakers employed for the dye-tests, and add 2 cc. of concentrated sulphuric acid. In this "bath" boil a test skein of woollen yarn together with one of cotton yarn for twenty minutes; then remove the skeins, squeeze out the excess of liquid, and dry without washing. After drying test the strength of the two skeins, and it will be found that the cotton has been very much weakened and may be easily pulled apart, whereas the wool does not appear to have been much affected. Boil a second set of woollen and cotton skeins in the same acid bath for twenty minutes, then wash well in several changes of fresh water. Take the woollen skein and, together with another one of untreated wool, dye by boiling for twenty minutes in a beaker containing 300 cc. of water and 10 cc. of Acid Magenta solution (containing 5 grams of the dissolved dyestuff per liter); then wash well and dry. It will be noticed that the

If the steaming has not been carried out properly, and especially when the second steaming is omitted and vertical cylinders have been used, the pieces are liable to become "ended"; that is to say, large patches unnoticed before dyeing will show up. These are caused by uneven condensation of the steam in the goods. These defects are indiscernible previous to the dyeing and are usually attributed to the dyer. This is particularly true in the case of cheviots which often contain two different kinds of yarn, such as hard tightly twisted worsted warp and a soft loose weft. Goods of this character are very much inclined to show uneven penetration.

^{*} In the potting process the pieces are wound on a perforated steam cylinder which is placed within a machine with a reversible driving gear, and through the hollow shaft of the cylinder steam or water or both can be drawn through the goods. After washing and brushing the goods are beamed on the cylinder in the usual manner and inserted into the potting machine. Cold water is first forced through the goods, and then steam. Admission of the steam to the water takes place before it enters the cylinder so that the temperature of the water is gradually increased and is finally brought almost to boiling. The hot water is thus pumped through for two to three minutes, then the steam is turned off, and the goods are cooled down with cold water. For broadcloth which has to receive a fine gloss and a soft finish the following process is often used: Steam is first forced through the goods for fifteen to twenty minutes, then the steam is turned off and water is pumped through. This produces a fine gloss. Next, hot water is pumped through the cloth to give a soft handle, then air is sucked through and the goods unrolled.

skain which has been treated with acid will be dyed a heavier color than the second skain. This is due to the wool having combined chemically with the acid in its first treatment, thus allowing it to react more readily with the acid dyestuff employed. Take the second cotton skain and pass it through a cold solution of 1 gram of soda ash in 300 cc. of water for ten minutes; then rinse in fresh water and dry. It will be found that this skain has not become weakened by the treatment with the acid solution, as the latter has been neutralized by the alkali before drying.

Exp. 2. Action of Organic Acids on Cotton.—Work a test skain of cotton yarn in a bath containing 300 cc. of water and 5 cc. of acetic acid for twenty minutes at a temperature of 160° F. Squeeze and dry without washing. Test the strength of the dried skain and it will be found not to have become much weakened. Acetic acid is a volatile organic acid and on drying is volatilized from the fiber.

Exp. 3. Action of Concentrated Sulphuric Acid on Cotton.—Place about 50 cc. of concentrated sulphuric acid in a beaker and rapidly pass through it a small skain of cotton yarn, then immediately wash it in a large amount of water until all of the acid is removed. It will be found that the strong acid has caused the fibers to swell and form a rather gelatinous mass. On drying it will give a parchment-like substance. This treatment, in fact, is employed for the preparation of vegetable parchment paper from ordinary paper. The substance of the paper is cellulose, which is the same as the substance of the cotton fiber. Take a second small skain of cotton yarn (or some loose cotton) and steep it for some time in the concentrated sulphuric acid. A gelatinous mass is first formed, which soon dissolves completely. If this solution is carefully diluted with water and boiled for some time, the dissolved cellulose (which may be regarded as existing as cellulose sulphate) will be converted into glucose.

Exp. 4. Illustrating the Carbonizing Process.—Take a small piece of cloth containing wool and cotton yarns (known as "union" goods, made up with a cotton warp and a wool filling) and steep it in a solution of 100 cc. of water and 2 cc. of concentrated hydrochloric acid until thoroughly saturated. Then squeeze and dry in an oven at 220 to 240° F. for two hours. The sample should then be rubbed and beaten vigorously, and it will be found that the cotton portion will be easily broken up and dusted out, leaving only the wool in a practically pure condition.

Exp. 5. Action of Hydrochloric Acid on Silk.—Steep a test skain of silk yarn in a bath containing 300 cc. of water and 5 cc. of hydrochloric acid at 160° F. Squeeze and dry without washing. Test the strength of the dried skain and notice that it is somewhat weakened. The tendering effect will become much more apparent after the skain has been left for several weeks.

Exp. 6. Scrooping Effect of Organic Acids on Silk.—Work a test skain of silk yarn in a bath containing 300 cc. of water and 5 grams of tartaric acid for twenty minutes at 140° F. Squeeze and dry without washing. Notice that the dried skain when squeezed emits a peculiar crunching sound. Also note the increased luster of the fiber. The latter will become more apparent if the skain is stretched and steamed with dry steam.

Exp. 7. Action of Alkalies.—Boil a skain of woollen yarn together with one of cotton in a bath containing 300 cc. of water and 10 cc. of caustic soda solution (60° Tw.). The wool will be disintegrated and dissolved. Wash and dry the cotton skain and it will be found not to be appreciably altered. Repeat the test, using 10 cc. of a solution of sodium carbonate instead of caustic soda. Boil for twenty minutes, then wash and dry. It will be found that the wool has become much weakened and is lifeless and dull in appearance, while the cotton is not changed. Repeat this test, using 10 cc. of a solution of ammonium carbonate; boil for twenty minutes, then wash and dry. It will be noticed that in this case neither the wool nor the cotton is affected in strength.

Exp. 8. Mercerization of Cotton.—Take a piece of ordinary cotton cloth (calico) measuring 4×4 ins. in size, steep it for a few minutes in a cold solution of caustic soda of 55° Tw. strength, then rinse well in fresh water until the alkali is all removed, and allow to dry. Now remeasure the sample and record the amount of shrinkage; also note the increase in strength. Wind a small skein of Sea Island 2-ply cotton yarn tightly on a small iron frame (this may be constructed as in Fig. 55); dip this into a cold caustic soda solution as above for five minutes; without removing from the frame rinse in fresh water well, then in water slightly acidulated with sulphuric acid to neutralize all the alkali, and finally rinse in water containing a little ammonia to avoid danger of leaving any excess of acid in fiber. Remove the yarn from the frame and note the increase in luster.

Treat a skein of cotton yarn, without stretching, in the caustic soda solution (55° Tw.) cold for ten minutes, then wash well and neutralize with a very dilute solution of sulphuric acid. Cut the skein in half and together with a half skein of ordinary cotton yarn boil for twenty minutes in beaker of water containing 10 cc. of Diamine Blue solution; then wash well and dry. It will be found that the skein treated with the caustic soda takes on a darker color, which shows that mercerized cotton has a greater affinity for substantive dyestuffs, of which the color given is representative. Boil the second

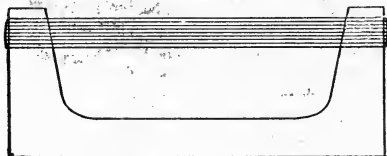

FIG. 55.—Mercerizing Test Frame.

half of the mercerized skein together with a half skein of ordinary cotton yarn for twenty minutes in a beaker of water containing 5 cc. of Methylene Blue solution, and afterwards wash well and dry. It will be found that the "mercerized" skein becomes tinted to quite an extent with the basic dye used, whereas the other skein is scarcely tinted at all. Caustic soda effects a chemical change in the substance of the cotton fiber which gives it an increased affinity towards basic dyes.

Exp. 9. Action of Metallic Salts (Mordants).—Boil a skein of wool together with one of cotton for twenty minutes in a bath containing 300 cc. of water, and 10 cc. of chrome solution. Rinse with fresh water. Then boil the woolen skein together with another of untreated wool in a bath containing 300 cc. of water and 20 cc. of a solution of Madder. Finally wash well and dry. It will be found that the untreated skein has not become dyed, whereas that treated with the chrome has become colored. Take the cotton skein which has been treated with the chrome and boil it also in a solution containing 300 cc. of water and 20 cc. of Madder solution, then wash well and dry. It will be found that the cotton skein has taken up but very little dyestuff, as this fiber absorbs but a small amount of the mordant. Madder is a dye which has no direct affinity for the fibers, but it forms a color-lake with metallic salts such as chrome; hence the unmordanted wool did not become dyed. Due to the fact that wool has a much greater affinity for metallic salts than cotton, it will be noticed that the former fiber is dyed much deeper than the latter.

Exp. 10. Action of Metallic Salts on Cotton.—Steep a skein of cotton yarn in a beaker of water containing 5 grams of calcium chloride, squeeze and dry without washing. After drying, test the strength of the skein and it will be found to have become

considerably weakened. Calcium chloride represents a salt of an acid nature and causes a decomposition of the cotton fiber. Steep another skein of cotton yarn in a beaker of water containing 5 grams of sodium sulphate (glaubersalt), squeeze and dry without washing. On testing this skein it will be found that its strength is not materially affected. This second salt represents a neutral metallic salt and has little action on cotton. Steep another skein in a beaker of water containing 5 grams of copperas (ferrous sulphate); squeeze, and pass through a second beaker of water containing 5 grams of soda ash dissolved; then wash. It will be found that the skein has become a light buff color, due to the fact that the fiber has absorbed from solution some of the iron salt which by afterwards coming in contact with the alkali formed a precipitate of oxide of iron. On this reaction is based the methods of dyeing cotton with the mineral pigments. Take this skein together with one of ordinary cotton, and boil them in a beaker of water containing 1 gram of ground Madder, and wash and dry. It will be found that the skein containing the metallic salt will become dyed with the Madder, while the other skein will not. On this reaction is based the principle of mordanting cotton for the use of certain dyestuffs which require a metallic mordant to yield a color-lake.

Exp. 11. Action of Zinc Chloride Solution on Cotton.—Place about 50 cc. of a concentrated solution of zinc chloride in a beaker and add about 2 grams of loose bleached cotton and heat. The cotton will be found to dissolve. Pour a portion of the solution into water, and a precipitate of cellulose will be formed. This solution of cotton in zinc chloride solution is used for the preparation of cellulose filaments which are carbonized and used for the filaments in incandescent electric lamps. The use of this solution of cotton has also been tried for the preparation of artificial silk.

Exp. 12. Action of Ammoniacal Solution of Copper Oxide on Cotton.—This solution is a blue liquid prepared by dissolving freshly precipitated copper hydrate in ammonia water. Take about 50 cc. of the solution in a beaker and dip a piece of bleached calico in the liquid, remove and dry without washing. It will be found that the cloth has become coated with a film of gelatinized cellulose mixed with copper hydroxide, and is of a green color. On this reaction is based the preparation of the Willesden waterproof canvas. Test the dried sample of calico with water, and it will be found to be waterproof. Now add to the ammoniacal copper hydrate solution about 2 grams of bleached loose cotton and stir well. The cotton will soon dissolve. Pour a portion of the solution into water and a precipitate of cellulose will separate out. This solution of cotton is employed for the preparation of artificial silk.

Exp. 13. Action of Bleaching Powder.—Steep a skein of woolen yarn together with one of cotton in a cold solution of bleaching powder of about 2° Tw. strength for thirty minutes. Then pass into a cold bath containing 300 cc. of water and 10 cc. of a dilute solution of hydrochloric acid (the odor of what gas is noticed here?) and work for ten minutes. Then wash well in fresh water. It will be found that the cotton has become bleached, but that the wool has acquired a deeper yellow tint and is harsh in feel after drying. The wool has combined with the chlorine of the bleaching powder in a chemical manner while the cotton has not; the only effect in the latter case being that the bleaching liquor destroys the coloring matter naturally present in the cotton. Next, take this skein of "chlorinated" wool together with a skein of untreated wool and dye them for twenty minutes at 160° F. in a bath containing 300 cc. of water and 5 cc. of a solution of Diamine Sky Blue; wash and dry. It will be found that the "chlorinated" skein takes up much more dyestuff than the other skein and is dyed a darker shade. Next, take portions of these two skeins and plait them together and steep in a small quantity of warm soap solution and rub vigorously between the hands to imitate the action of fulling or milling. It will be found that the ordinary wool will readily felt together, while the chlorinated wool does not.

Exp. 14. Action of Oxidizing Agents on Cotton.—Take a strip of calico and spot it in several places with a paste made from some chloride of lime and a little water. Allow to remain for one-half hour then wash off the paste with water acidulated with hydrochloric acid, and then wash with water made slightly alkaline with ammonia. Next boil the strip of calico in a beaker of water containing 1 cc. of Methylene Blue solution (a basic dyestuff), then wash and dry. It will be found that where the cloth was spotted with the chloride of lime the color is taken up to a considerable extent, whereas the rest of the calico is scarcely tinted. The chloride of lime has caused an oxidation of the cotton with the formation of oxycellulose, and this substance has a much stronger affinity for basic dyes than ordinary cotton. Cut a portion of the strip off so as to include one of the spots, and test its strength; it will be found that the oxidation of the fiber has caused a considerable tendering in strength. Take a second similar strip of calico and spot it in the same manner with a mixture of potassium bichromate and sulphuric acid, and after standing for one-quarter hour, wash it off with water, and finally with water slightly alkaline with ammonia. Then treat it in the same manner as above with the solution of Methylene Blue, and also test the strength of the fiber. This mixture of chrome and acid is a strong oxidizing agent and also converts cotton into oxycellulose.

Exp. 15. Moisture in Textile Fibers.—Take a test skein of woolen yarn, weigh it accurately; heat in an oven for two hours at 220° F., then quickly reweigh, and calculate the percentage of loss as moisture. Care should be taken not to allow the temperature to go over 220° F. as the wool would otherwise be injured. Now expose the skein to the air for several hours (or overnight), and reweigh. Calculate the percentage of regain on the dry weight of the wool. Note if the dried wool returns to its original weight. Repeat these tests, using a skein of cotton and also one of silk. Note the different percentages of moisture in each case, and also the percentage of regain.

Exp. 16. Effect of High Temperatures.—Heat a skein of wool in an oven at a temperature of 225° F. for one hour, and then observe if any discoloration is evident and if the fiber is weakened. Then raise the temperature to 250° F. for one hour longer and note the effects produced. Also subject a skein of cotton and one of silk to the same conditions and note the effects produced in both cases.

CHAPTER II

SCOURING THE TEXTILE FIBERS

1. Impurities in Raw Wool.—The raw wool fiber as it exists in the fleece contains a large amount of natural impurities. These are as follows:

- a. Grease, or wool-fat.
- b. Suint, or dried-up perspiration.
- c. Dirt, consisting of dust, sand, burrs, etc.

It is the object of scouring to remove these impurities and leave the fiber pure and clean without material injury to its good qualities. The *greasy matters* in the fleece, known as *wool-fat*, are insoluble in water, but are readily emulsified by solutions of soaps or alkalies. Wool-fat differs from most other animal fats in chemical constitution in that the latter are compounds of various fatty acids with glycerin (and hence are called *glycerides*). These rather easily react with caustic alkalies to form soluble *soaps*, a reaction which is termed *saponification*. Wool-fat, however, is not a glyceride, but contains a substance known as *cholesterol* (a body belonging to the general class of alcohols) and does not form soaps with the caustic alkalies. It does, however, form emulsions with more ease than do the other animal fats, and on this account it is rather easily removed from the fiber. The *suint* (a French word for sweat) consists of various metallic salts of organic acids, such, for instance, as potassium acetate. These salts are soluble in water and hence are easily removed in the scouring. The miscellaneous *dirt* in the wool is not soluble in water and is simply mechanically removed by the agitation of the wool in the process of scouring.

The amount of impurities in raw wool varies quite largely with the character of the sheep and the locality in which they are grown. Generally speaking, the total impurities may be said to vary from 50 to 80 per cent of the weight of the fleece, with a general average of about 65 per cent. As a rule, the finer the staple of the wool, the greater amount of grease it will contain, whereas in coarse wools the amount of grease is usually relatively much less. The loss in weight that wool undergoes on scouring is termed its *shrinkage*, and forms an important item in judging the value of raw wools.

The chemicals chiefly employed in the usual method of scouring wool are soda ash (sodium carbonate) and soaps. Potash (potassium carbonate) is sometimes used, but as it is much more expensive than soda ash its use is more restricted. Most frequently a mixture of soda ash and soap is used, the relative amounts depending on the quality of the wool to be scoured and the amount and nature of the impurities present. As the wool fiber is rapidly injured by solutions of alkalis at high temperatures, the scouring of wool should be carried out at as low a temperature as permissible with perfect removal of the impurities.

The temperature of the scouring bath under ordinary conditions should not exceed 140° F., and in the case of fine luster-wools the lower temperature of 100 to 120° F. is used. Attention has already been drawn to the fact that wool is easily injured by even quite dilute solutions of caustic alkalis, consequently the presence of such is especially deleterious. On this account, the soaps and other ingredients used in the scouring solu-

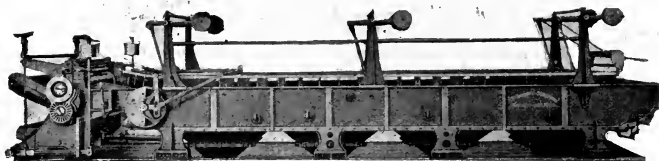

FIG. 56.—Wool Washer. (C. G. Sargent's Sons.)

tions should be free from any very appreciable amount of caustic alkali.

After removal from the soap solution, the scoured wool should be thoroughly cleansed from alkali and soap by washing in water. If this is not done the soap will dry into the fiber, and subsequently be very difficult to remove properly. The presence of soapy matters in the wool leads to many bad effects; it causes the product to have a sticky and greasy feel, produces unevenness in dyeing, and when brought into an acid solution (as is generally the case in the application of most dyestuffs to wool), the soap is decomposed with the liberation of free fatty matter in the fiber, which is a very objectionable result.

2. The Emulsion Process of Scouring.—The ordinary process of scouring wool by the use of solutions of soaps and alkalis is called an “emulsion” process on account of the fact that the soapy and alkaline liquors form an emulsion with the greasy matters in the wool. A distinction must be made between an *emulsion* and a *solution*. An emulsion is an intimate mixture of greasy or oily matters with water (or solution of soap or alkali) in which the grease exists disseminated throughout the mixture in a very

finely divided state, usually in the form of minute globules. The emulsion is considered as permanent when the greasy matters do not readily separate from the liquid in a distinct layer. In a solution, on the other

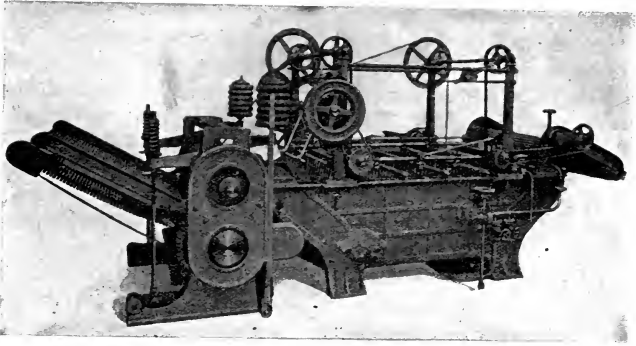

FIG. 57.—Wool-washing Machine. (English Type.)

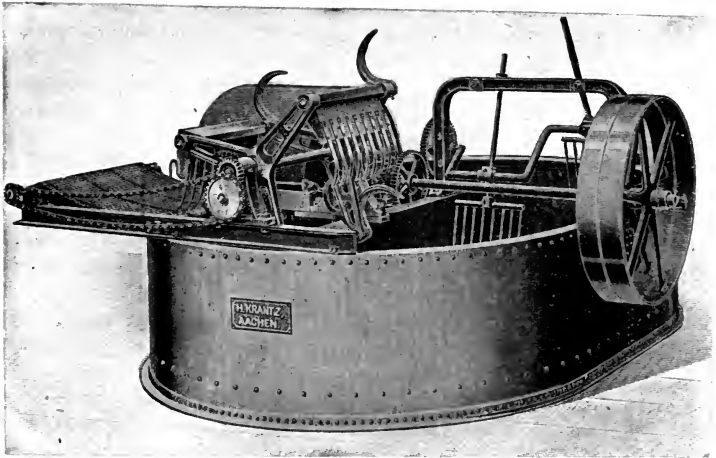

FIG. 58.—Wool-scouring Machine. (Oval Type.)

hand, the dissolved substance is not merely broken up into small particles and held in suspension, but its identity becomes merged with that of the liquid solvent. It is to be noted that the greasy matters of the wool do not actually pass into solution but remain finely suspended as an emulsion.

and in consequence of this may be separated from the scouring liquor by suitable mechanical treatment. The suint, on the other hand, passes into solution.

3. Use of Alkali in Scouring.—In adjusting the amount of *alkali* (soda ash) to be used in scouring, reference must be had to the quality and quantity of impurity in the wool, and also to the quality of the fiber. An excessive amount of alkali must be guarded against, as it is liable to injure the luster and strength of the fiber, and also tends to discolor it. The finer the quality of the fiber, as a rule, the less the amount of alkali that should be employed, and this is especially true of luster-wools and fine merinos. Coarser and lower grade wools are scoured with a relatively larger amount of alkali. It is a mistake to presume that the more dirty and greasy the wool, the more alkaline should be the scouring liquors; this may be true when reference is had to wools of about the same quality, but a very dirty and greasy fine merino wool should be scoured with less alkali than a comparatively clean but low-grade Territory wool, on account of the greater liability to injure the fiber in the former case.

4. Carbonizing.—A great amount of the raw wool coming into trade (especially that from South American countries) is contaminated with vegetable substances such as burrs, spike-grass, etc. These are usually not completely removed by scouring or by the mechanical processes through which the wool subsequently passes, with the result that these vegetable fibers continue to be present even in the finished cloth or fabric. This causes specky dyeing, for, as a rule, the vegetable fiber is not dyed by the coloring matters employed for the dyeing of the wool. Also the presence of the vegetable material considerably lowers the quality of the finished goods.

In order to clear the wool of these vegetable impurities the process known as "carbonizing" is resorted to. This process depends on the difference in the action of acids on wool and vegetable tissue (such as pointed out on page 66). If dilute solutions of acids are allowed to dry into wool, the wool is not materially affected or weakened; but cotton, or other vegetable fiber, under such conditions becomes totally destroyed and reduced to a friable powder which may easily be removed by beating and washing.

There are several methods of carbonizing, and the process selected will depend on the character of the goods and the circumstances of the particular case. Treatment with dilute solutions of sulphuric acid and subsequent drying is the principal and favorite method of carbonizing. The material to be treated is impregnated with a solution of sulphuric acid * of 2 to 6° Tw. (2 to 5 per cent strength) at a temperature of 210 to 212°

* This treatment must be carried out in wooden, cement, or better yet, lead-lined vats; and care must be had to avoid iron fittings or iron spots may get on the goods.

F. The goods are then squeezed or hydro-extracted * and dried first at a temperature of about 140 to 160° F., then the temperature is raised for a while to 220° F. in order to complete the decomposition of the vegetable matter.

Instead of using sulphuric acid the goods to be carbonized may be subjected to the action of moist hydrochloric acid gas. This process is generally employed for carbonizing woven cloth, as it may be used as a continuous operation. The cloth, in a slightly moist condition, is passed through the carbonizing chamber, where it is acted on by the hydrochloric acid gas at a temperature of 210 to 230° F. It then passes through a beating operation and is finally washed to remove the decomposed and disintegrated vegetable matter.

Solutions of aluminium chloride have also been used for purposes of carbonizing woolen fabrics, the goods being saturated with a dilute solution of this salt and then dried. Aluminium chloride is a salt which is easily hydrolyzed, especially when heated, with the liberation of hydrochloric acid *in situ*, and this latter affects the carbonization of the vegetable matter.

Loose wool is carbonized, of course, after scouring, as the treatment would not be practicable on the raw greasy wool. Carbonizing of loose wool is usually necessary when dealing with low-grade burry wools. The sulphuric acid treatment is mostly employed as indicated above. The drying is usually carried out in special drying machines so constructed as to withstand the action of the acid, or the treated wool is spread out on racks and dried in a hot room. The heat employed in either case should not go over 220° F. After drying the wool is passed through a form of "willow" or "wolf" suitable for the disintegration of the decomposed vegetable matter. A washing operation is generally necessary after this, for though the broken-up vegetable tissue is easily removed and dusted out by the various mechanical operations through which the wool passes in carding and spinning, nevertheless it is well to neutralize the wool by washing in a solution of soda ash, of 3 to 6° Tw. at 140° F. and then rinsing. If this is not done trouble is liable to be experienced in the subsequent dyeing of the wool.

5. The Scouring of Woolen Yarn.—As the impurities in woolen yarn differ very materially from those present in raw wool, we would naturally expect a difference in the manner of scouring. The impurities in yarn, in the first place, are much less in amount, varying from 10 to 20 per cent in ordinary woolen yarns, and from 2 to 5 per cent with most worsted yarns. The character of these impurities is also different; they consist of the oil which has been added during the spinning of the wool, together with the

* The centrifugal hydro-extractor used for this purpose should be specially lined with lead or enamel, so that it may resist the corroding action of the acid.

miscellaneous dust and dirt it may have collected passing through the various machines in carding and spinning. Oil is added to wool for spinning in order to make the fibers more plastic and to preserve them from mechanical injury. Such oil should be capable of easy removal from the spun yarn and should not add any deleterious substance to the wool. For instance, the oil should not be of a drying character, as it will form resinous products in the wool, the presence of which would be very disadvantageous; further, the oil should be capable of ready emulsion so that no difficulty may be experienced in scouring the yarn. Again, the oil should be free from acidity, as otherwise it would attack the card clothing

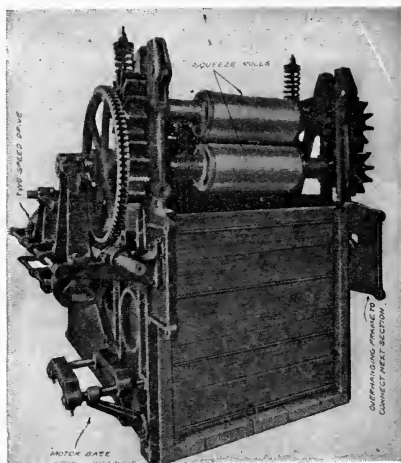

FIG. 59.—Yarn Scouring Machine. (Klauder-Weldon Dye. Machine Co.)

and other metallic surfaces with which the wool may come in contact, not only causing injury to the machines, but also causing the wool to become impregnated with iron compounds, which leads to many defects in subsequent scouring, bleaching, and dyeing. Owing to the fact that the impurities in yarn are of less amount and also more easily removed, it is customary to employ relatively less alkali in scouring than is the case with raw wool. Whereas, in scouring the latter substance the proportion of alkali is greater than that of soap, with yarn scouring the proportion is just reversed, and more soap than alkali is used; and furthermore the strength of the scouring liquors is much diminished. The exact composition of the scouring bath, also, in the case of yarn, must be regulated with

reference to the amount of impurities in the fiber as well as the quality of the fiber itself. Worsted (and high-class yarns in general) containing but little oil and dirt are scoured in comparatively weak solutions containing a good quality soap and a minimum amount of alkali (or in some cases none at all). With lower grade and dirtier woolen yarns the proportion of alkali is increased. The temperature of the scouring bath for yarn, as with that for raw wool, is generally about 140° F., though with fine luster-wools even this temperature is considerably reduced. Occasionally, with very low-grade yarns, such as coarse carpet yarns (containing a

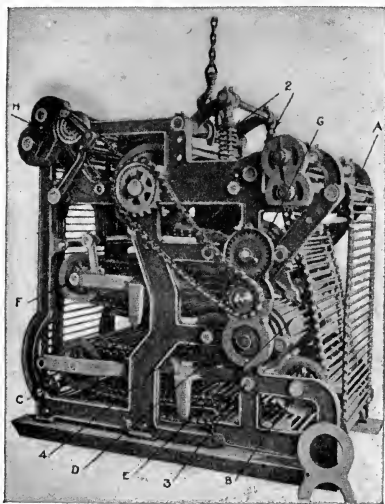

FIG. 60.—Yarn Scouring Machine, showing Apron and Mechanism.
(Klauder-Weldon Dye. Machine Co.)

variety of crude hair fibers, such as goat and cow hair, coarse camel hair, mixed with jute and other vegetable fibers, as well as large quantities of inferior grease used in spinning), the temperature of the scouring liquor may be much increased, in some cases even as high as the boiling point.

The composition of the wool oil employed in the spinning of the yarn will have much to do with the proper composition of the scouring liquors. In the case of worsteds and high-class yarns it is customary to use only vegetable or animal oils in oiling the stock; but in the case of low-grade yarns, such as shoddies and carpet yarns, there is usually incorporated in the wool oil a greater or less proportion of mineral oil. The latter differs

from the other oils mentioned above in not being saponifiable, nor is it as readily emulsifiable. Where mineral oils are used it is necessary, as a rule, to employ a higher percentage of soap in scouring, as the oil is more

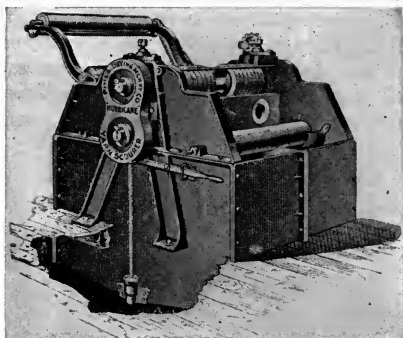

FIG. 61.—Double Bowi Yarn Scouring Machine.

easily emulsified with soap than it is with alkali. To remove all of the mineral oil it is sometimes necessary to repeat the scouring operation.

Woolen and worsted yarns are usually scoured by hand by hanging from sticks in a rectangular wooden tank containing the scouring liquor.

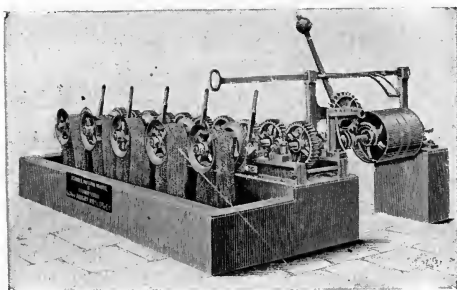

FIG. 62.—Yarn Scouring Machine. (German Type.)

Several forms of machines have also been devised in order to economize hand labor. These are usually of two types: (a) consisting of a revolving spider or frame containing the sticks on which the yarn is held and systematically turned while passing through a semi-cylindrical tub containing

the scouring liquor;* and (b) consisting of a traveling apron of wooden slats which carries the yarn (headed up in bundles) through the soap liquor and thence through squeeze rolls (so-called "nips"). Several pas-

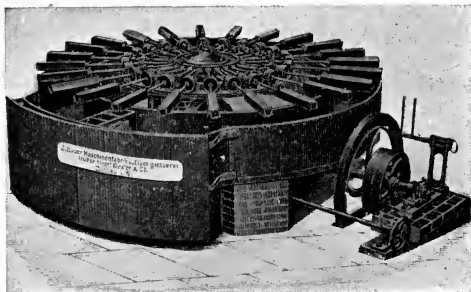

FIG. 63.—Scouring and Washing Machine for Yarn.

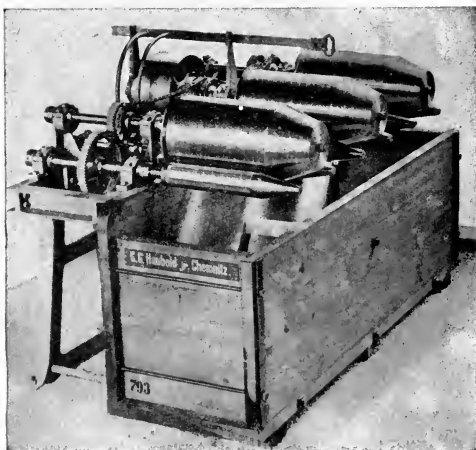

FIG. 64.—Hank Yarn Washing Machine.

sages through such a machine are generally required to effect a perfect scouring, depending upon how dirty or oily the yarn may be.

* This is the same character of machine used for dyeing skein yarn like the Klaunder-Weldon apparatus shown in Fig. 141 on page

6. The Scouring of Yarns Containing Iron.—In some cases woollen yarns are liable to contain quite appreciable quantities of iron, which may have been derived in a variety of ways, such as rusty cards, the use of an acid oil in spinning, contamination with the lubricating oil on the machines, etc. Such yarns are usually of a deep grayish color, and if scoured in solutions containing soda ash (or potash) will usually come from the scouring bath badly discolored by a yellowish brown stain. This is due to the iron becoming fixed in the fiber in the form of iron oxide (iron rust)

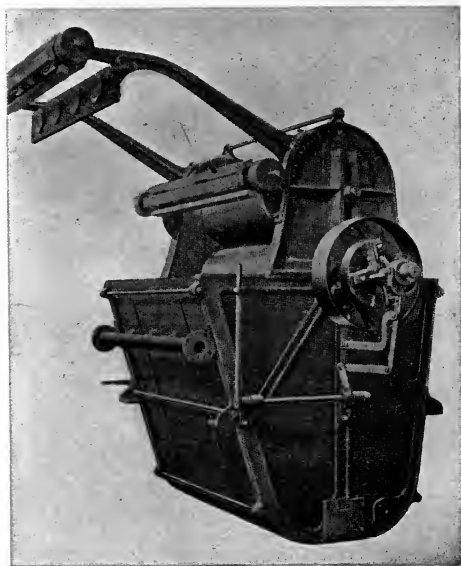

FIG. 65.—Dolly Washer. (Textile-Finishing Machinery Co.)

by reaction with the alkali. Such yarn will exhibit serious defects in subsequent dyeing, as the iron will act as a "mordant" for many coloring matters and tend to dull or "sadden" the color. Yarn of this character should be scoured in solutions containing only soap without the addition of any alkali, so as to permit of the proper removal of the iron rather than its fixation in the fiber.

7. Scouring Tops.—Wool is sometimes scoured and dyed in the form of *tops* (an intermediate stage between the combed wool and the spun yarn, consisting of a loosely coherent rope of fibers with very little or no twist).

As tops are used for spinning into worsted yarns, they contain but little oil, and this generally of a good quality and free from mineral oil; also tops

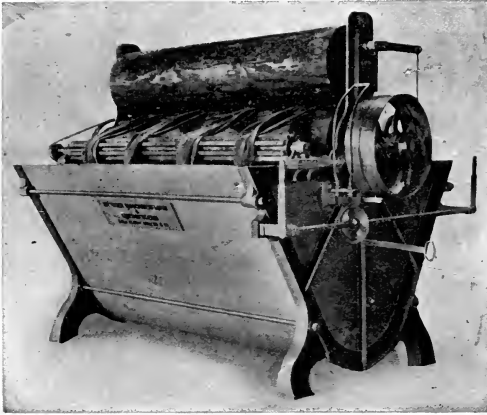

FIG. 66.—Piece Scouring Machine.

are very clean in their general character. It is usual to scour tops with ammonia salts or with weak soap solutions. Owing to the delicacy of their structure, tops cannot be handled in the same manner as yarn or

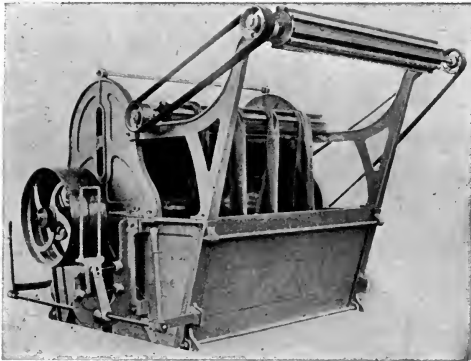

FIG. 67.—Washer for Piece-Goods.

loose stock, but must be scoured (and also dyed) in special machines with a view to disturbing the fiber as little as possible. Attempts have been made

to make the tops up in the form of large skeins and then to process them somewhat after the manner of skein yarn, using either hand sticks or sticks in machines with revolving spiders. Such treatment, however, causes

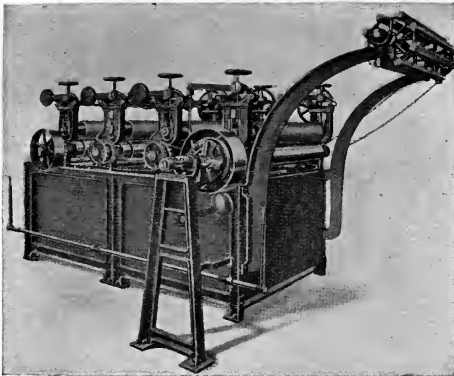

FIG. 68.—Open Washer for Piece-Goods. (Textile-Finishing Machinery Co.)

much breakage of the tops and also pulls them out and causes distortion. Tops have been successfully scoured and dyed, however, in machines involving the pack system, where the tops are either packed into suitable compartments through which the liquors are circulated, or wound on large

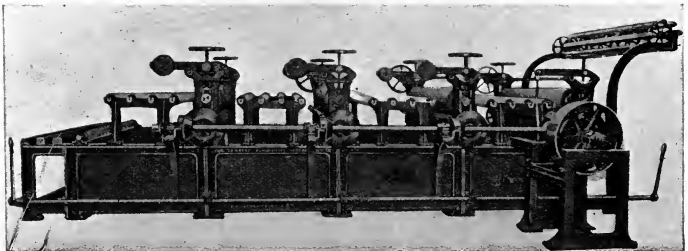

FIG. 69.—Four Compartment Open Soaper. (Textile-Finishing Machinery Co.)

perforated spools through which the liquors are circulated by pumping or by suction.

8. Scouring Woolen Piece-Goods.—A large amount of woolen material is dyed in the form of the woven piece, and this generally requires to be

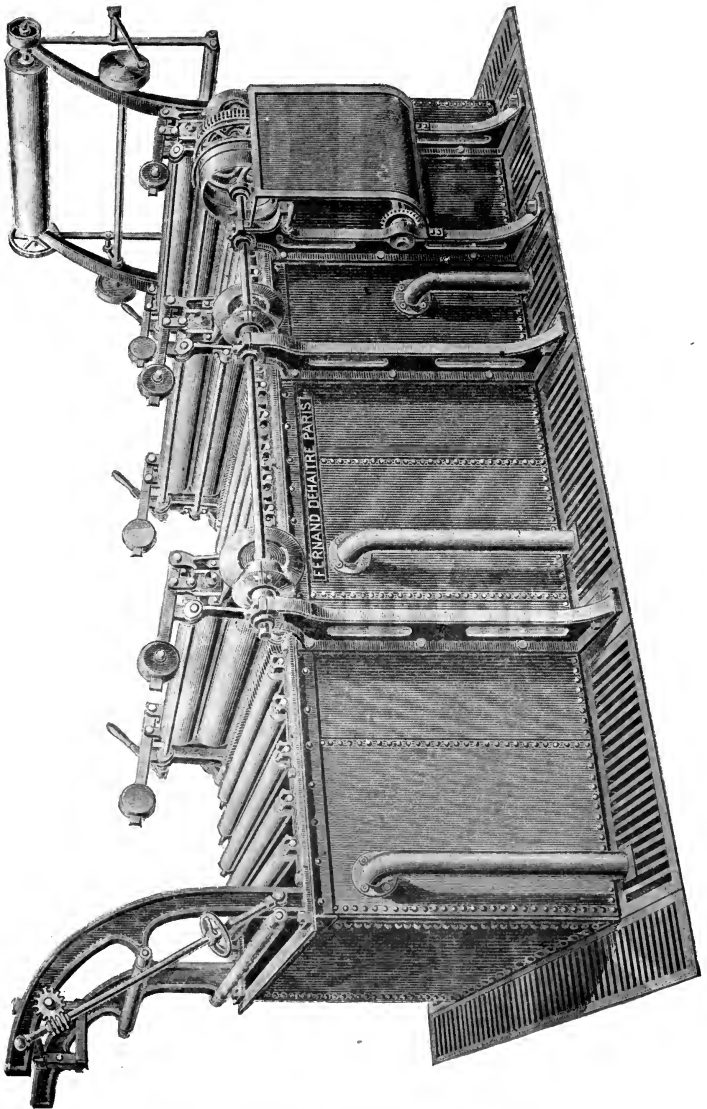

FIG. 70.—Washer for Piece-Goods. (Dehaitre.)

scoured before dyeing. Even if not dyed, the piece of goods coming from the loom nearly always requires a more or less thorough scouring operation before it can be finished and marketed. Since piece-goods are mostly

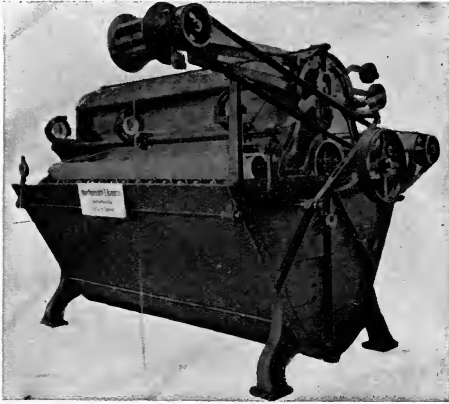

FIG. 71.—String Tub Washer.

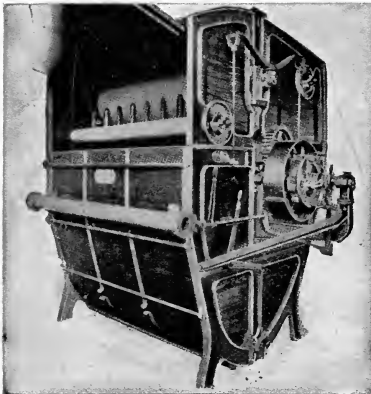

FIG. 72.—Cloth Washer. (Rodney Hunt Machine Co.)

woven from unscoured yarns they will naturally contain the oils and other impurities present in these together with additional grease and miscellaneous dirt acquired through the various manufacturing processes leading

up to and including the weaving. Furthermore, the warp yarns are nearly always sized so as to give them greater strength and smoothness in order

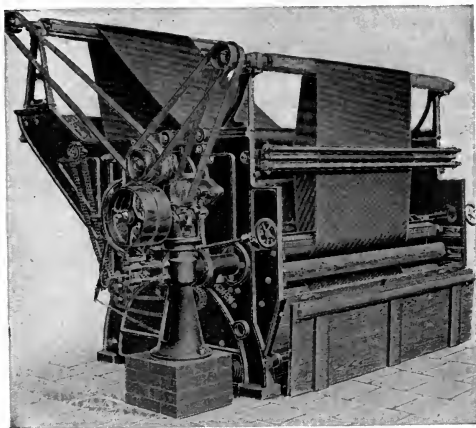

FIG. 73.—Open Width Cloth Washer.

better to resist the strain weaving and the abrasive action of the rapidly moving shuttle. The size usually consists of starch and vegetable gums with sometimes added waxes or fats. All of this material, of course, has to be removed in the scouring and washing operations. In the case of low-grade shoddy yarns of short stapled fiber, even the filling is sometimes sized on the cops in order to furnish added strength in the weaving.

The same general principles apply to the scouring of pieces as to that of yarns, the chief difference being in the method of handling the material. There are three general types of apparatus in use for this purpose: (a) A simple tub with a revolving winch to keep the cloth in motion; (b) a continuous string-tub machine through which the cloth passes in rope form, entering at one side of the machine and passing out at the other; (c) an open-width machine in which the cloth is maintained stretched

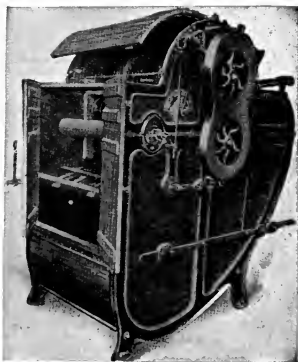

FIG. 74.—Fulling Machine. (Rodney Hunt Machine Co.)

out in the open width. The latter form of machine, however, is only used for rather special purposes, the one almost universally employed for this class of work being the string washer. In scouring and washing woolen piece-goods care must be had to conduct the operations so as to avoid felting as far as possible; that is to say, where a simple cleaning of the material is the end in view. Where the scouring process is also used as one of the finishing operations, it is frequently required to have a certain degree of felting (or "fulling" as it is called), so as to give the fabric a fuller body and bring the yarns closer up to one another. In the case of worsted fabrics this fulling is carried to only a slight degree, but in the

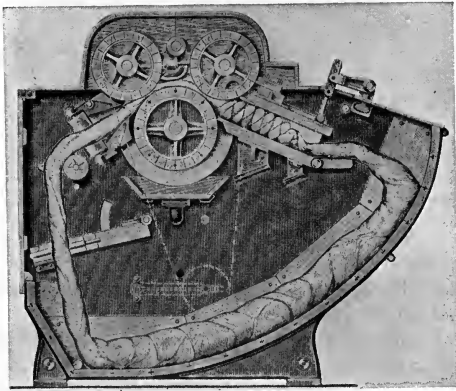

FIG. 75.—Showing Action in Fulling Mill.

case of many fabrics of woolen yarns, the felting action required is much more pronounced. These operations, however, relate more specifically to the province of finishing, and their more detailed consideration would be out of place at this point.

Woven fabrics are often made up of variously colored yarns together with those that are undyed. In the scouring of such goods special precautions must be taken in order to prevent undue bleeding of the colors. Of course, in such cases it is essential that colors should be used having a suitable fastness to washing. It is generally necessary to avoid the use of alkali as far as possible; frequently a mild ammonia (or ammonium carbonate) bath will serve the purpose of scouring.

In dealing with woolen or worsted pieces woven on a cotton warp it will be found on scouring that the cloth will cockle or wrinkle up owing to

the uneven contraction of the cotton and woolen yarns. In order to eliminate the defect the cloth must be *crabbed*, an operation in which the piece is subjected to the action of steam or boiling water and then cooled quickly in a stretched condition. This has the effect of rendering the wool fibers more plastic so they can be "set" in such a condition that the wool yarns will have the same length as the cotton yarns (see page 63).

9. Soaps for Scouring Wool.—A soap is a combination between an alkali and a fatty acid, and is produced by the action of a caustic alkali on an oil or fat. The latter substances (whether of vegetable or animal origin) are compounds of glycerin with various fatty acids, and by

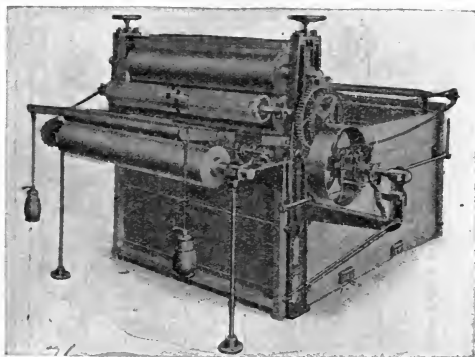

FIG. 76.—Crabbing Machine for Cloth. (Rodney Hunt Machine Co.)

proper treatment with caustic soda or caustic potash are decomposed with the liberation of glycerin and the formation of a soap. Caustic soda yields *hard* soaps, whereas caustic potash gives *soft* soaps. The different oils and fats, naturally, furnish soaps of different characteristics, and some soaps are more suitable for scouring than others. A good scouring soap should be readily soluble in water and possess high emulsifying powers towards greasy matters; it should contain no fats which would act deleteriously on the fiber or leave it with an objectionable odor or color. The soap should furthermore be capable of easy removal from the wool after scouring, and not leave behind any resinous or fatty matters of an insoluble character. As already mentioned, it should also not contain any appreciable quantity of free caustic alkali; nor, on the other hand, should it contain unsaponified fat. Soaps made from olive oil are usually considered of the highest grade and the most desirable for wool scouring; although soaps made from cotton-seed oil, maize oil, tallow, oleine

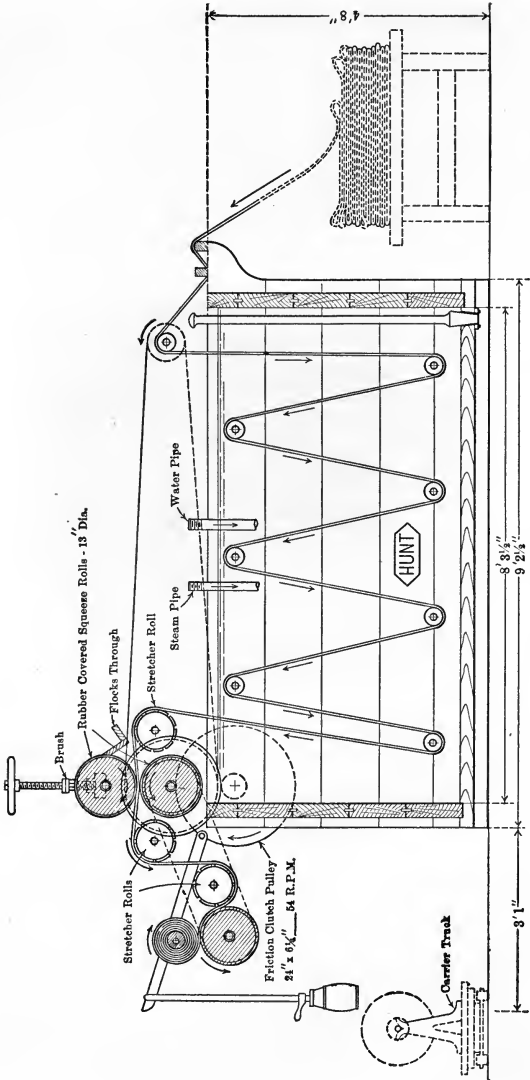

Fig. 77.—Grabbing Machine. Sectional View. (Rodney Hunt Machine Co.)

(the liquid fat obtained as a by-product in candle-making), and palm oil are also extensively employed. Often mixed soaps are used, such as olive or cotton-seed oil soap in combination with a tallow soap. Both hard and soft soaps are used, though the latter are generally preferred for scouring raw wool as well as yarn.

10. Boiling-out of Cotton.—Raw cotton is unlike wool in that it contains a relatively small amount of natural impurities and for many purposes cotton is not scoured at all. Whereas raw wool cannot be manufactured into yarn without a previous removal of its greasy and dirty matters, cotton is spun without any such preliminary cleansing being required;

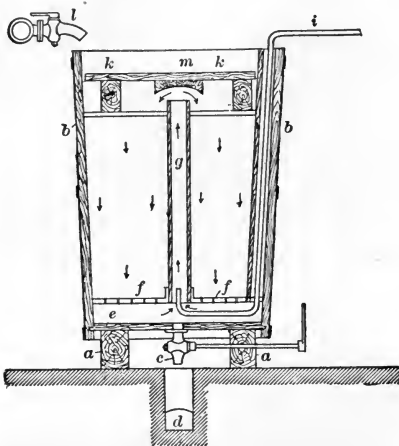

FIG. 78.—Early Type Open Kier with Injector.

in fact the impurities that are present in raw cotton are an aid rather than a hindrance to the proper spinning of this fiber. In many cases of dyeing, also, a previous scouring of cotton is not required. The impurities in raw cotton consist for the most part of waxy and resinous matters, which are classified under the general term of *pectin* substances. These amount to about 5 per cent on the weight of the fiber. By reason of its coating of waxy matters, the cotton fiber is more or less waterproof, or rather water-repellent, and will not readily “wet-out” when placed in water. This property is frequently a drawback in dyeing, as the dye solution will not penetrate perfectly and evenly. To overcome this defect it is necessary to remove the waxy coating on the cotton, and this is best done by boiling in a solution of caustic soda, soda ash, or soap, or with some oil

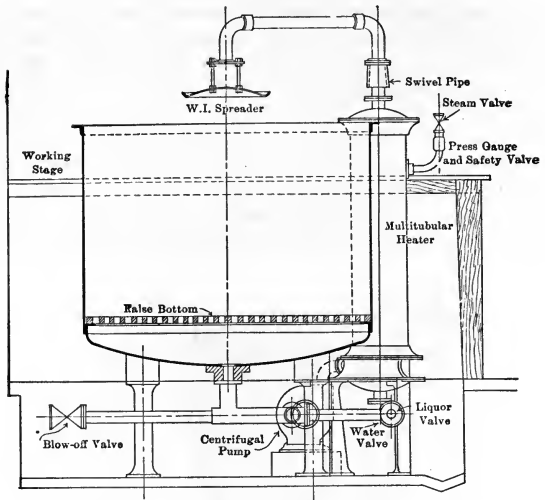

FIG. 79.—Modern Type Open Kier. (Hübner.)

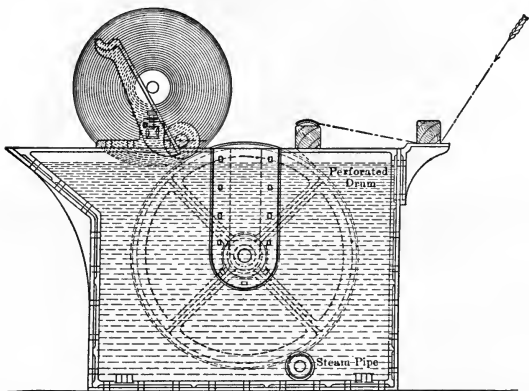

FIG. 80.—Open Kier for Treating Cloth with Caustic.
(H. W. Butterworth & Sons Co.)

which has the property of dissolving the cotton-wax. This "wetting-out" of cotton for the purposes of dyeing or mordanting is simply with a view of allowing it to become quickly and thoroughly saturated with the solutions in which it may be placed. When cotton is to be bleached, however, it is not only necessary to scour the fiber so that it will readily wet-out,

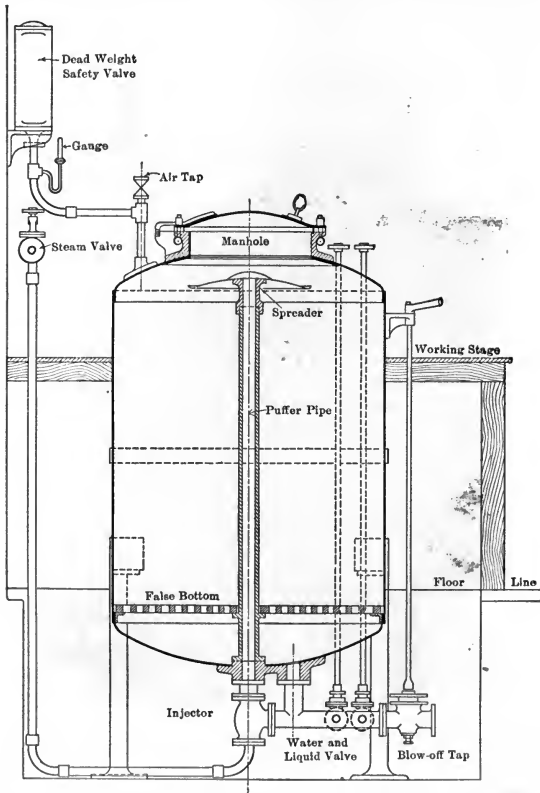

FIG. 81.—Closed Kier with Plain Injector Circulation. (Hübner.)

but also to completely remove all resinous substances, otherwise a good clear white will not be obtained in the bleaching. For this purpose, it is generally necessary to boil the cotton with a solution of caustic soda (or other alkalis) for a number of hours and usually under more or less pressure. This operation is termed "boiling-out" to distinguish from

mere "wetting-out." In the scouring of cotton it is probable that the waxy and resinous substances in the fiber are emulsified or dissolved. Caustic soda is probably the most generally employed chemical for the scouring of cotton, though soda ash and sodium silicate are also extensively used. Often mixtures of these three are employed. Soap is also an efficient medium for wetting-out cotton, though it appears that when a very thorough boiling-out process is required a more strongly alkaline

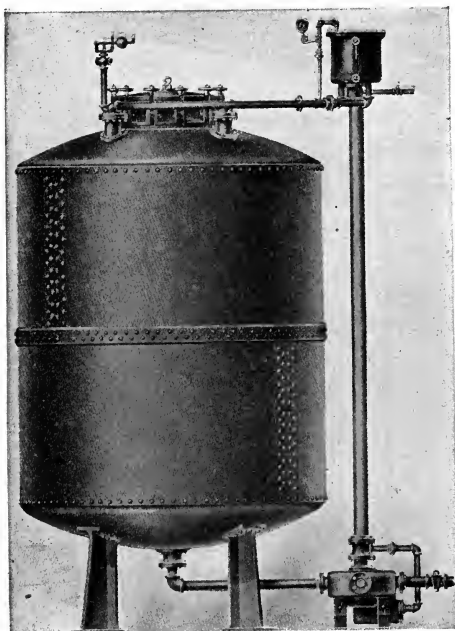

FIG. 82.—Pressure Kier with Rusden Circulator. (Textile-Finishing Machinery Co.)

agent is desirable. Formerly lime (slaked in water) was extensively employed for boiling-out cotton preliminary to bleaching but its use is rapidly giving way to that of caustic soda. Certain so-called "soluble oils" (prepared by treating castor oil, cotton-seed oil, etc., with strong sulphuric acid; and hence also called "sulphated" oils) appear to possess the property of quickly dissolving the waxy matters from cotton, and these are sometimes used for the purpose of wetting-out of cotton for dyeing. They are also at times used in the process of boiling-out. Fank-

hausine, Solvine, Monopol Oil, etc., are compounds of this character, and consist, for the most part, of sulphonated vegetable oils. For the purpose of merely wetting-out it is probably better to use either a solution of soap or a soluble oil, rather than the alkalies, as the former method leaves the cotton somewhat whiter in appearance and softer in feel. It is probable that when boiled with solutions of caustic soda or soda ash the resinous matters in the fiber are decomposed with the formation of brown coloring



FIG. 83.—Pressure Kier with Vacuum Circulation. (Jefferson Patent.)

matters, and as a result the cotton has a darker color than when treated with soap or oil.

The pectin matters in cotton may also be removed, or rather solubilized, by the action of diastatic ferments or extracts, such as are obtained from malt and bran. The diastase preparations for this purpose are known under various names, such as Diamalt, Diastofor Polyzime, etc. They are used in the form of a weak solution (2 to 4 per cent) and at a lukewarm temperature (110 to 120° F.) The cotton goods are generally steeped in the solution overnight, or saturated with the liquor, squeezed, and

laid down in bins in the moist state overnight. The diastase acts on the pectin matters in the cotton, converting them into readily soluble materials, with the result that the cotton becomes very absorbent and is easily wet-out. This method of removing the pectin matters from cotton is frequently resorted to in cases where it is not desirable to employ a kier boil with an alkali, as in the case of bleaching cotton cloth with colored stripes. By using the diastase method a good bleach may be obtained without injury to the color.

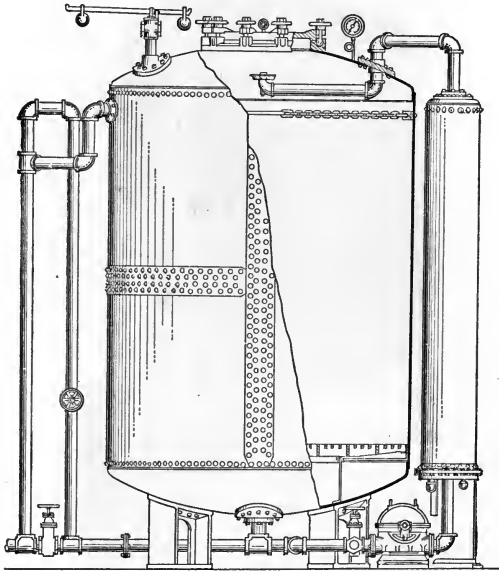

FIG. 84.—Pressure Kier with Outside Heater and Pump Circulation.
(W. Allen & Sons Co.).

11. The Impurities in Raw Silk.—Raw silk as it appears in trade does not much resemble the brilliant and lustrous fiber seen in manufactured silk fabrics. Raw silk consists not only of the fiber proper, but also of a large amount of a glue-like substance which heavily coats the fiber and gives it a harsh, brittle feel and hides the luster and whiteness of the true fiber. This substance is known as *silk-glu*e or *sericin*, and it amounts to about 25 per cent of the weight of the raw silk. It is soluble in water, and may indeed be completely removed from the fiber by prolonged boiling.

It is, however, more readily removed by strong solutions of soap, and this is the usual method employed. The fiber proper of silk is known as *fibroin*, and though very similar in chemical composition to sericin, it is insoluble in water or soap solutions. The most of the coloring

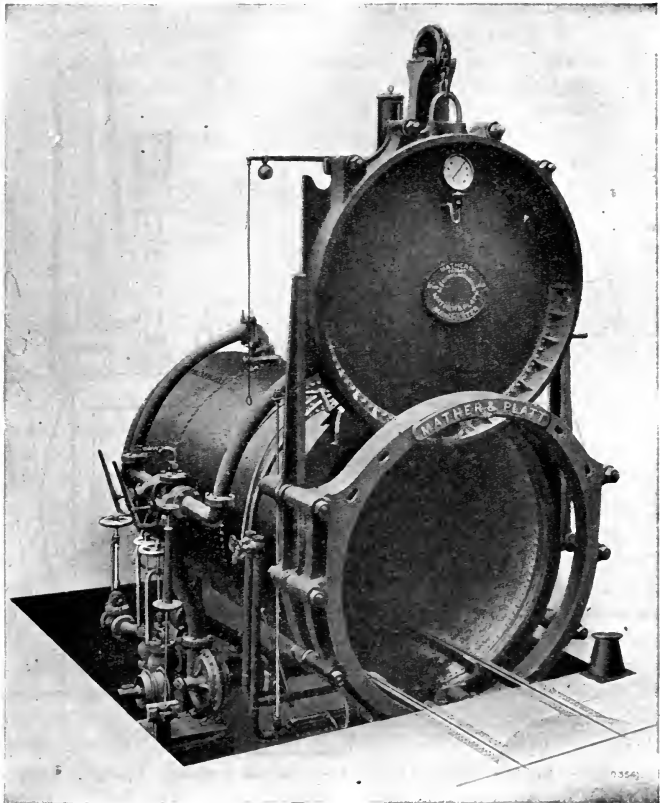

FIG. 85.—Mather Kier. (Mather & Platt).

matter in raw silk is also contained in the silk-glue and is removed along with this latter substance. Certain raw silks (yellow-gum Italian for instance) are of a deep yellow color, but when completely stripped of silk-glue they become as white as other silks.

12. The Boiling-off of Silk.—The fiber proper of raw silk is covered with a glue-like material known as sericin. The presence of this latter substance makes raw silk harsh and stiff and without luster. Boiling soap solutions remove the sericin without affecting the fiber proper of the silk. The scouring of raw silk, or the removal from it of the silk-glue, is usually termed “boiling-off” though the expressions “degumming”

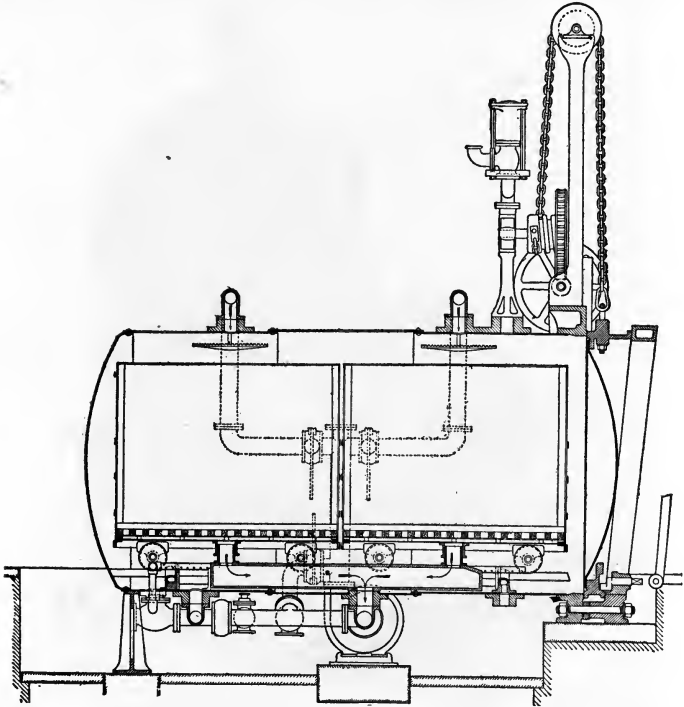

FIG. 86.—“Mather” Patent Kier. Longitudinal Section. (Mather & Platt).

and “stripping” are also used. When completely boiled-off silk will lose in weight from 22 to 28 per cent and is known in the trade as boiled-off or *cuit* silk. Frequently, however, all of the silk-glue is not removed, but only sufficient to make the silk soft and lustrous and workable in dyeing or bleaching. Under these circumstances, the scouring of silk is termed *soupling*, and only from 10 to 15 per cent in weight is lost. Soupled silk is also known in trade as *micuit*. It is usually prepared

by steeping the raw silk in a lukewarm dilute soap bath for several hours, then rinsing off in fresh water. After soupling the silk may be bleached, or weighted and dyed. After bleaching the soupled silk is frequently given a treatment with a hot (200° F.) solution of tartar (using 3 to 4 per cent of the cream of tartar on the weight of the silk); this causes the silk-gum remaining on the fiber to soften and to remain in that condition permanently. Soupled silk is used where a thick full fiber is required as filling yarn (especially for moiréd goods); it is also largely used for warps. Furthermore, raw silk is sometimes given only a very slight scouring for the purpose of softening the fiber; this gives what is called *écru* silk, and only 2 to 5 per cent in weight of the silk-glue is removed.

Écru silk is frequently prepared by simply washing the raw silk in lukewarm or hot water without the use of any soap at all. As only a small amount of the gum is removed this fiber is hard and without luster, in fact very closely resembles raw silk in appearance. It is used principally as warp threads and the gum is therefore left on purposely to act as a size. The scouring of silk is almost invariably accomplished by the use of boiling solutions of soap. The length of time and the number of soapings given will determine how much of the sericin will be removed. For a complete boiling-off a strong soap solution is necessary (from 4 ozs. to 1 lb. of soap per gallon), and the time required is from 1 to 2 hours, and this treatment is usually repeated with a second soap solution. Unless a very soft water is employed it is also necessary to add a small amount of soda ash to the scouring bath in order to correct the hardness of the water, otherwise a sticky lime soap will be formed which will adhere to the fiber and is very difficult to remove. The soap employed for the scouring of silk should be of the very best quality, and should be as neutral as possible. The presence of any appreciable free alkali in the scouring bath will rapidly injure the silk fiber, causing it to become weakened, discolored and lusterless. Generally, the best grade of hard olive oil soap is used;* soft soaps are not employed because these are nearly always liable to contain small quantities of free alkali. The spent scouring baths left after the boiling-off of silk (usually repeated lots of raw silk are scoured in the same soap solution) contain a large quantity of silk-glue together with the soap employed. These residual baths are known as *boiled-off liquors* and are extensively used as an adjunct in the dyeing of silk, being added in considerable amount to the dyebath for the purpose of softening the dyed silk and promoting the even distribution of the color. After the silk has been scoured or boiled-off it should be thoroughly washed with water in order to remove all trace of soapy liquor, otherwise the soap will dry into

* One of the chief faults in the use of a cheap soap, or of a soap other than that made from olive oil, is the objectionable odor which such soaps are liable to impart to the silk.

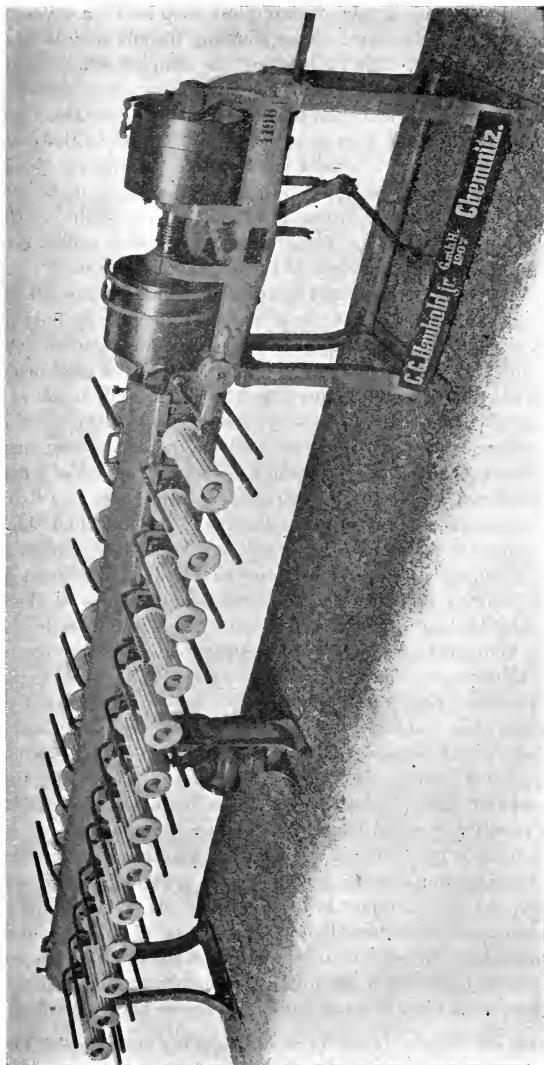

FIG. 87.—Scouring and Washing Machine for Silk Skeins (With Porcelain Rollers.)

the fiber and cause discolorations and imperfections. After the scoured silk is dried, in order to soften the fiber and to give it increased luster, it is stretched or steamed. This is merely a mechanical treatment which loosens up the fine and delicate filaments of the silk fiber which have become more or less matted together in the scouring and dyeing.

Soupled silk is produced by boiling in a weaker soap solution than when boiled-off silk is desired; also only one treatment is given and the time of boiling is reduced. The amount of silk-gum removed may also be regulated by scouring at temperatures lower than the boiling point. For yellow-gum souple silk it will also be necessary to supplement the

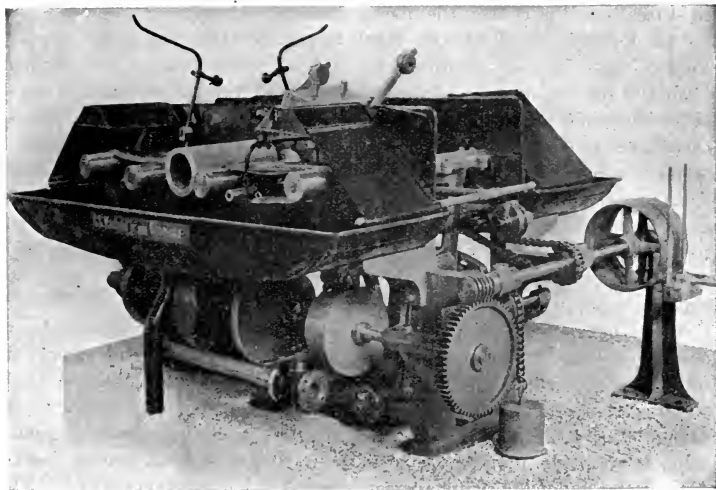

FIG. 88.—Yarn Washing Machine.

scouring with a bleaching operation. This may be done by steeping the scoured and rinsed silk in a cold bath of *aqua regia* (consisting of 1 part nitric acid and 2 parts hydrochloric acid) at 4 to 5° Tw. until the fiber acquires a greenish tinge. It is then thoroughly washed and should lose the greenish color and become pure white. If, instead of the green tint the silk acquires a yellow tint in the *aqua regia* bath, it indicates that the action is too strong or has proceeded too far. Or the bleaching may be done with sulphurous acid, as in the case of wool (see p. 108). In both cases the acid must be completely removed from the silk by a thorough rinsing. For the production of *écru* silk the raw fiber is merely softened and wet-out by working in a lukewarm dilute soap solution,

and then rinsing. Spun silk (or schappe silk) contains but a small proportion of silk-glue as most of this has been removed in the operations previous to the spinning of the waste silk. Before dyeing spun silk, however, it is customary to wet it out by boiling it in a bath containing a small amount of soda ash and soap. Tussah (or wild silk) is more difficult to boil-off than cultivated silk, as it contains a considerable amount of lime compounds. On this account it is scoured by boiling in a solution containing $\frac{1}{2}$ to 1 lb. of soda ash per 10 gallons of water. Then after rinsing well it is treated in a lukewarm bath containing 3 to 5 ozs. of hydrochloric acid per 10 gallons of water. This latter treatment is to dissolve the lime compounds and thus soften the fiber. After the acid treatment, of course, the fiber is thoroughly rinsed.

13. Relation of Water to Wool Scouring.—The use of the proper kind of water in wool scouring, both for the preparation of the scouring bath and for the washing of the wool after scouring, is a matter of considerable importance. The use of *hard* water, as such, should be interdicted, on account of its bad action with soap solutions. By a “hard” water is meant one containing considerable amounts of dissolved mineral substances, usually compounds of calcium (lime), magnesium, and sometimes iron. These mineral substances in solution combine with soap to form insoluble and sticky precipitates, which cause not only a loss of soap and a consequent decrease in the scouring power of the bath, but also these precipitates adhere to the fiber and are difficult of removal. Water having a hardness of 100 parts per million (10°) will render useless about one-third ounce of soap per gallon. As this represents water of only a fair degree of hardness, it may be seen that the loss in soap through hard water may become a very considerable item of expense. One pound of calcium carbonate, or its equivalent in calcium sulphate or magnesium salts, in solution in water destroys about 10 lbs. of good average soap. A thousand gallons of water for each degree of hardness (parts of CaCO_3 per 100,000) destroy about 1 lb. 4 ozs. of soap. Sometimes the “hardness” of water is removable by simply boiling; it is then termed *temporary hardness*, and is principally due to the presence of carbonic acid gas holding calcium carbonate (limestone) in solution. On boiling, the carbonic acid gas is driven off and in consequence the calcium carbonate is precipitated. *Permanent hardness*, on the other hand, is not removable by boiling, and is chiefly due to the presence of calcium sulphate (gypsum). To remove hardness of this character soda ash is usually added sufficient to precipitate the calcium compound as the highly insoluble carbonate. Or, small quantities of oxalic acid and ammonia may be added, which causes the precipitation of the lime as calcium oxalate. Before hard water is used in connection with wool scouring it should be “corrected” in one of the ways here indicated. Water containing any appreciable

amount of iron is especially objectionable for use in scouring, as the iron readily becomes firmly fixed in the fiber, leading to many bad defects. Iron may be best removed from water by proper aëration and filtration. Should the water contain sediment in any appreciable amount it should be properly filtered before use. River or pond water is liable to contain a larger amount of sediment than spring or well water, but, on the other hand, as a rule, its hardness is not so great, nor is it as liable to contain iron.

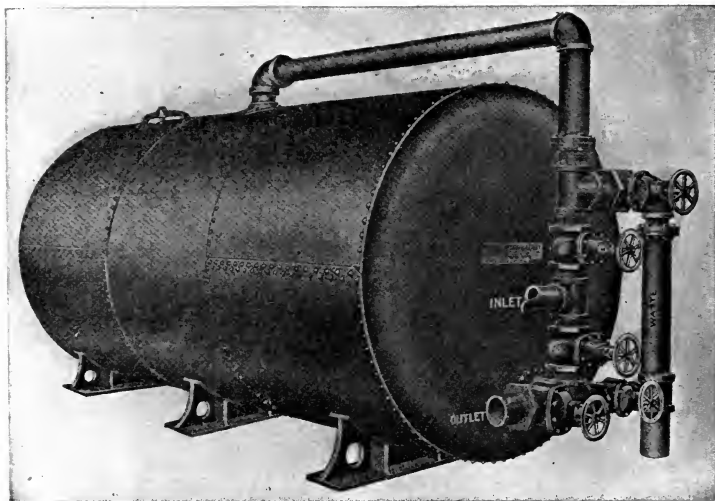

FIG. 89.—Horizontal Pressure Filter. (Hungerford System).

Water containing organic matter in solution will often carry with it considerable iron also held in solution.* These impurities, together with finely suspended matters and color bearing substances, may best be removed by treating the water with a small amount of alum and filtering. The action of the alum is to cause a coagulation of the organic matters, which in their precipitation carry down with them all other impurities including the iron and coloring matters, thus yielding a clear filtered water which is pure and free from iron. Care must be taken to see that an excess of alum is not added, otherwise it would introduce an objectionable feature into the water. If the water is also hard and it is

* Iron is a very objectionable impurity in water, especially for bleaching as even small traces of this metal tend to give a yellowish appearance to the bleach.

desired to soften as well as clarify it, soda ash may be fed into the water in addition to the alum and before filtering. A good test to show if there is an excess of alum in the filtered water, is to place a sample, about 50 cc. of the water, in a porcelain dish, add a few drops of acetic acid and then a few drops of a solution of hematoxylin; if a pinkish or violet color persists after stirring, it indicates the presence of alum, but if the color is simply brown and free from a violet tinge, the water is free from alum.

In filtering water for dyehouses and bleacheries it is probably more efficient to use closed mechanical pressure filters rather than the open

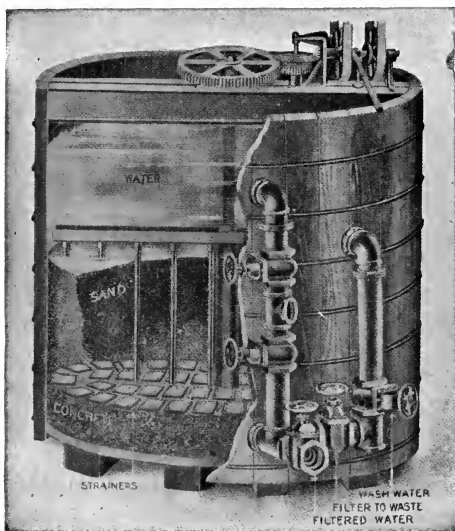

FIG. 90.—Gravity Filter. (Hungerford)

type of gravity filter. Both use sand as the filtering medium, but the pressure filter is more easily regulated and adjusted to the needs at hand; also it occupies much less space, and if of the proper type is very readily cleaned by simply reversing the flow of water for a short time.

Another form of water treatment for the purpose of obtaining a very soft water is known as the "Permutit" process. This process is only for the softening of the water and presupposes a filtering at first through a suitable sand filter for the purpose of removing suspended and organic matters. In the Permutit process a form of pressure filter is used employ-

ing an artificial zeolite as the filtering mechanism. This mineral has the peculiar property of exchanging its sodium content for calcium or magnesium when brought into contact with water containing compounds of these latter metals. Thus a hard water containing calcium sulphate when filtered through a layer of this zeolite gives up its calcium to the

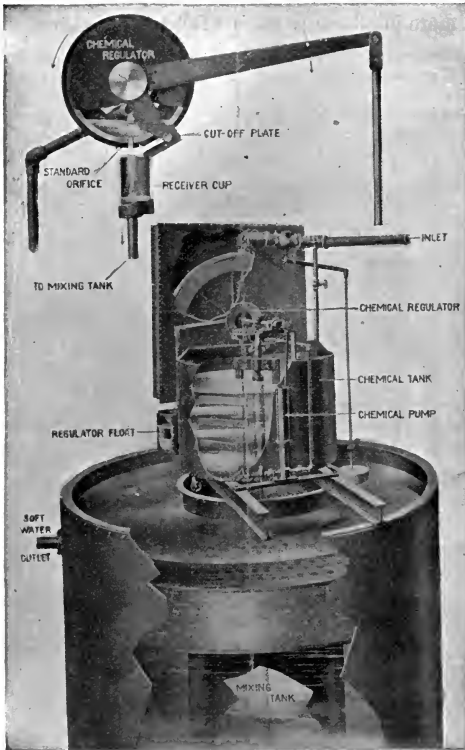

FIG. 91.—Water Softener. (Booth System).

zeolite and receives in exchange a corresponding quantity of sodium, so that in place of calcium sulphate the water will come from the filter containing an equivalent amount of sodium sulphate. By this process water of zero hardness may readily be obtained. The zeolite filtering medium is regenerated by passing through it a solution of common salt, which takes out the lime and replaces it with sodium again.

Pure water is just as necessary for bleaching, dyeing, and washing as it is for scouring. Many of the defects in these processes can be traced back to the use of impure or hard water, as the metallic salts present in such water may cause stains, streaks, and discolorations. The special features in these cases will be discussed in their appropriate place when these subjects come up for consideration, as the matter may then be dealt with more intelligently when a fuller knowledge of the conditions is acquired.

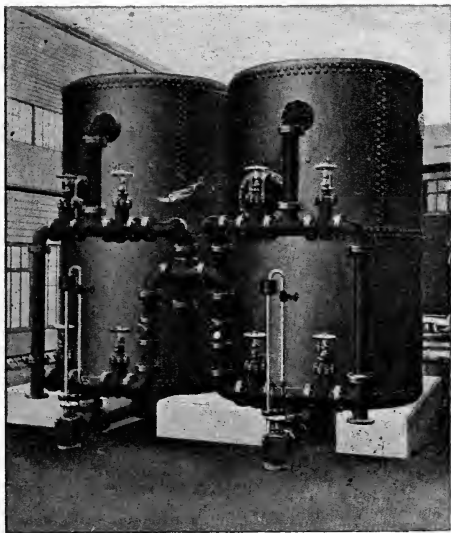

FIG. 92.—Water Softener. (Permutit System).

In some dyehouses the water obtained from condensed steam is often employed where a very pure water is desired. In such cases care should be had that the water is free from oil or grease which may frequently be present if the exhaust steam from an engine is used. This condensed water is practically pure distilled water and in this condition very readily dissolves iron from iron pipes or tanks in which it may be stored; therefore either wooden pipes should be used, or if of iron they should be coated inside with pitch. The same is also true of storage tanks, which should be of wood wherever possible. If these precautions are not used, the

use of condense water may result in serious defects by reason of the large amount of iron with which it may become contaminated.

The proper chemical treatment necessary for any given water in order to obtain a pure soft water can be determined only by a careful chemical analysis of the water by those experienced in the problems dealing with water purification.

14. Experimental. Exp. 17. Scouring Raw Wool by the Emulsion Process.—Weigh out 10 grams of raw wool and scour it in a bath containing 300 cc. of water, 5 grams of soda ash, and 2 grams of soap. Have the soap thoroughly dissolved before adding it to the bath. Work the wool gently at 140° F. for one-half hour, or until it seems thoroughly cleansed. Wash well in fresh warm water to remove all soapy liquor. Dry and reweigh. Calculate the percentage of loss or "shrinkage." In working the wool in the scouring bath care should be taken not to agitate the fibers too vigorously or the wool will become matted or felted together.

Exp. 18. Use of Potash in Scouring Wool.—Prepare a scouring bath containing 300 cc. of water, 5 grams of pearl ash (potassium carbonate or potash), and 2 grams of soap. Scour a 10-gram sample of the same wool as used above and proceed in the same manner. Wash well in warm water, allow to dry and reweigh. Compare the two samples thus scoured by the use of the two alkalies.

Exp. 19. Effect of High Temperatures in Scouring.—Use the same bath as employed in Exp. 17 and scour another 10-gram sample of the same kind of raw wool, but bring the bath to the boil for one-half hour. Rinse as before in warm water, and allow to dry. Reweigh and calculate the percentage of loss, and also compare the general appearance and "feel" of the wool with that scoured in the first experiment.

Exp. 20. Effect of Using Excessive Alkali in Scouring Raw Wool.—Scour a 10-gram sample of raw wool in a bath containing 300 cc. of water and 20 grams of soda ash. Work for one-half hour at a temperature of 140° F.; then wash well in warm water and allow to dry. Calculate the percentage of loss, and compare the general appearance and feel with the samples scoured by the use of less alkali.

Exp. 21. Scouring Woolen Yarn by the Usual Method.—Prepare a bath containing 300 cc. of water, 10 grams of soap, and 2 grams of soda ash. Scour a weighed test skein of woolen yarn in this bath for one-half hour at a temperature of 140° F., then wash in fresh water and allow to dry. Reweigh after drying and calculate the percentage of loss due to scouring.

Exp. 22. Scouring Woolen Yarn Containing Iron.—Yarn of this nature is best scoured in baths containing only soap, as soda ash or potash will form an insoluble compound with the iron in the fiber which cannot be removed, and which will cause the yarn to dye up dull. Scour a test skein of woolen yarn containing iron in the same bath as employed for the previous experiment and in the same manner; wash well and dry. Scour a second skein of similar yarn in a bath containing 300 cc. of water and 10 grams of soap for one-half hour at 140° F.; wash well and dry. Compare the appearance of the two scoured skeins.

Exp. 23. Scouring Cotton with Caustic Soda.—Prepare a bath containing 5 grams of caustic soda to 300 cc. of water, and boil a skein of cotton yarn therein for one-half hour; then wash in fresh water until all trace of the caustic soda has been removed from the cotton and dry. Weigh the skein before and after the scouring and calculate the percentage of loss.

Exp. 24. Scouring Cotton with Soda Ash.—Prepare a bath containing 5 grams of soda ash and 300 cc. of water, and boil a skein of cotton yarn therein for one hour. Wash well in fresh water and dry. Weigh the skein before and after scouring and cal-

culate the percentage of loss. Compare this skein with that in the preceding test as to amount of loss, color, softness, etc.

Exp. 25. Scouring Cotton with Soap.—Prepare a bath containing 5 grams of soap and 300 cc. of water, and boil a weighed skein of cotton yarn therein for one-half hour. Wash in fresh water and dry. Reweigh and calculate the percentage of loss. Compare this skein with the others of the above experiments.

Exp. 26. Scouring Cotton with Soluble Oil.—Prepare a bath containing 2 cc. of Monopol Oil (50 per cent solution) and 300 cc. of water. Work a skein of cotton yarn in this bath for one-half hour at 180° F.; then wash and dry. Weigh the skein before and after scouring and calculate the percentage of loss. Compare the skein with others in the previous experiments as to color, softness of feel, etc.

Exp. 27. Scouring of Raw Silk.—Take a weighed skein of raw silk yarn and boil it for one hour in a solution containing 250 cc. of water and 25 grams of olive oil hard soap; then wash well in fresh warm water and dry. Reweigh and calculate the percentage of loss. As a rule, to completely degum the silk it is necessary to boil in several soap baths. Notice the difference in the appearance and "handle" of the boiled-off silk. Stretch and squeeze the dried boiled-off skein so as to soften up the fiber and luster it. It will be found that most of the coloring matter of the raw silk is in the sericin and is removed in the boiling-off.

CHAPTER III

BLEACHING OF WOOL AND SILK

1. Bleaching Wool.—The wool fiber in its natural condition always contains some pigment matter; even the usual so-called "white" wool contains a small amount of a yellowish brown color which it is necessary to remove in order to have a fiber possessing a clear white color. In some grades of wool the amount of pigment matter may be comparatively large, giving the brown or black wools. These wools, however, are small in amount compared with the white wools and are seldom, if ever, bleached. The method of bleaching wool by the tinting process depends on the neutralization of the slight yellow tint of the natural wool by dyeing the fiber with a delicate tint of blue or violet coloring matter. It is not really a removal or destruction of the natural pigment, but simply a change of the yellow tint to one of a grayish tone. The latter being less susceptible to the eye causes the wool to appear white. The color relations in the case are based on the fact that yellow and violet are complementary colors, so that when mixed in small amount they produce gray. For the tinting color it is best to use a blue dyestuff with a slight violet tone, such as a very blue tone of Acid Violet. Oxalic acid is used with the dyestuff to render the solution slightly acid and thus develop the color. The actual amount of color required is very small and care must be exercised not to overtint the wool, or a bluish tone will be obtained. Wool bleached in this manner, of course, will not possess as clear a white color as that in which the natural pigment is actually destroyed; it will only give a dull, cloudy-looking white.

Sulphurous acid, or one of its compounds, is the agent mostly employed for the true bleaching of wool. Sulphurous acid is a strong reducing agent; that is to say, it has a strong "affinity" for oxygen. When acting on many organic coloring matters (such as the natural pigment in wool) it "reduces" them, thus causing them to be converted into colorless substances. Many coloring matters, however, after being thus reduced, are capable of becoming oxidized on exposure to air so as to yield again the original color; this appears to be the case with the coloring matter in wool, for when bleached with sulphurous acid the yellow tint becomes gradually restored on exposure to the air.

Bleaching by the use of sulphurous acid gas is the method mostly practiced for the bleaching of wool. The process is rather simple; the wool (either in loose state, yarn, or cloth) is moistened and spread out or hung in a room where it is subjected to the action of the sulphurous acid gas for ten to twenty hours. The gas is produced generally by the burning of sulphur in an iron or earthenware pot, sometimes in the bleaching room itself, though it is considered better to burn the sulphur in an apparatus outside of the bleaching room and to lead the gas into the latter. From the use of the so-called "stove" for burning the sulphur, this process of bleaching has received the name of "stoving." The wool (in whatever form) must be thoroughly scoured for bleaching and should be in a moist (though not *wet*) condition, as the gas acts but slowly on the dry wool. The material should also be so distributed in the bleaching room that the gas may easily come in contact with all parts of the fiber. Usually the gas is allowed to pass from one end of the room to the other and thence out through a flue. The bleaching chamber must be so constructed that the condensed vapors (which consist of rather concentrated sulphuric acid) cannot drop on the wool, else spotting will result, or the fiber may even be seriously injured. Also the room should not contain exposed iron parts which may come in contact with the sulphur gas, as the metal will rapidly be attacked and the condensed drops that may fall on the wool will cause bad spotting.

2. Use of Sodium Bisulphite.—The use of this chemical for the bleaching of wool is merely a convenient method for the application of sulphurous acid in the form of a solution. The bleaching agent, in fact, is exactly the same as when sulphurous acid gas is employed, and the character of the bleach obtained in the two cases is practically identical. Sodium bisulphite has the chemical formula NaHSO_3 , and when dissolved in water its solution practically consists of sodium sulphite and sulphurous acid:



When wool is steeped in this solution the sulphurous acid acts directly upon the fiber as a bleaching agent, and moreover, the wool also becomes saturated with the sodium sulphite. Hence the wool is subsequently treated with a solution of sulphuric acid, which reacts with the sodium sulphite, forming sodium sulphate and liberating another portion of sulphurous acid:

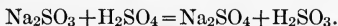

This second portion of sulphurous acid also aids materially in the bleaching of the wool.

Bleached wool is usually tinted with a blue or bluish violet coloring matter in order to give to the fiber a bluish white tone which is more pleas-

ing to the eye than the flat bleach. A minute quantity of a blue shade of Acid Violet is useful for this purpose, and it is generally applied in the rinsing bath after the bleaching, adding a small quantity of oxalic acid to the water for the purpose of developing the color and also for the purpose of removing any trace of brownish stain due to the presence of iron compounds.

The bleaching bath when using sodium bisulphite is prepared as follows:

- 500 gallons cold water,
- 12 gallons sodium bisulphite solution of 32° Tw.,
- 2½ pints oil of vitriol.

This bath will be of sufficient size to bleach 100 lbs. of scoured wool. The tanks employed should be of wood, and may be either round or rectangular in form. The wool is worked in the liquor until thoroughly saturated, and then allowed to steep overnight underneath the solution. It is then taken out and drained and tinted in a second bath containing 500 gallons of water and about $\frac{1}{3}$ oz. of Alkali Violet 6B at a temperature of 100° F. for fifteen minutes. The wool is finally rinsed and dried. The water employed for both the bleaching and tinting baths should be as pure as possible, and more especially free from iron. A variety of dyestuffs besides the one mentioned may be used for tinting, such as Alkali Violet 4BN, Acid Violet 6BN, etc. In order to prevent streaks in the tint the dyestuff employed should first be dissolved in 2 gallons of hot pure water and before being added to the bath the solution should be filtered through a cotton cloth. To obtain a tint which shall be very fast to fulling a little Indigo reduced with hydrosulphite may be used as the coloring matter.

Mention has already been made of the fact that the bleach obtained on wool by means of sulphurous acid is not a permanent one, but the yellow tint reappears after prolonged exposure to the air. Furthermore, it appears to be practically impossible to remove every trace of sulphurous acid from the fiber, however thorough the washing may be after the bleaching. The wool apparently combines in a chemical manner with the sulphurous acid, and this leads to two defects in the bleached wool; in the first place, the presence of the sulphurous acid apparently holds the pigment in the fiber in a reduced state so that the bleach lacks permanency of character, as already noted; secondly, the presence of the sulphurous acid is liable to act injuriously on other dyed colors with which the bleached wool may subsequently come in contact when woven into cloth. This effect is illustrated experimentally by the action of the bleached wool in contact with wool dyed with Magenta. For these reasons it has long been recognized as desirable to remove from the bleached wool all trace of sulphurous acid. This may readily be accomplished by

treating the bleached material with a solution containing a suitable oxidizing agent. Potassium permanganate has been quite extensively employed for this purpose. By its action the sulphurous acid is converted into sulphuric acid, which is harmless as far as the effects outlined above are concerned. In the use of this agent, however, great care must be exercised not to employ an excess beyond that needed to react with the sulphurous acid, otherwise a brown deposit of an oxide (or hydrate) of manganese will be left on the wool, and a subsequent treatment with a solution of sodium bisulphite will have to be given to remove this deposit. Instead of using potassium permanganate in this connection it would probably be better to employ a small quantity of sodium peroxide, which would have the same effect on the trace of sulphurous acid without the attendant defect of discoloration through the addition of an excess of the reagent. The presence of traces of sulphurous acid in wool may be conveniently detected by wetting the wool in a small quantity of water and adding a few drops of a mixture of iodic acid and starch solutions; if sulphurous acid is present a violet or blue color will be formed.

3. Bleaching Wool with Peroxides.—The use of sodium peroxide as a bleaching agent for wool is fast becoming of considerable practical importance. Hydrogen peroxide (in solution) is also employed for this purpose, but its cost is generally considered to be somewhat higher. The bleaching action of these two substances, however, is identical, and is due to the nascent oxygen which they are capable of liberating. Hydrogen peroxide has the chemical formula H_2O_2 , and is prepared by the action of sulphuric acid on barium peroxide. As employed in the arts it consists of a comparatively dilute solution (about 3 per cent) of hydrogen peroxide in water* though solutions containing as high as 10 per cent are now available. The chemical formula of sodium peroxide is Na_2O_2 ; it is prepared by heating metallic sodium in air or oxygen. It occurs as a yellowish white powder and may be obtained of a high degree of purity. Some care must be taken in the handling and using of sodium peroxide, as it is easily decomposed in the presence of moisture and organic matter with the evolution of large volumes of oxygen which may lead to explosions or fires. When handled with intelligent precaution, however, it is by no means a dangerous chemical. It should be stored in a cool, dry place in comparatively small tins (the usual commercial size is that containing 10 lbs.), and should be kept from contact with water or from organic matter such as paper, excelsior, etc. As the reaction which occurs between sodium peroxide and water is a very violent one, its solution

* In order to prevent the decomposition of the peroxide and the consequent loss in strength, it is customary to add a small quantity of acetanilide to the solution as a preservative. Sometimes phosphoric acid is also added for the same purpose, but it is not as efficient. The addition of uric acid or barbituric acid is also very effective.

should be carefully undertaken. *Large quantities or lumps of sodium peroxide should never be added to water*, as an explosion or fire is liable to result. The peroxide should be sifted gradually into the water with constant stirring. When sodium peroxide is dissolved in water caustic soda and hydrogen peroxide are formed:

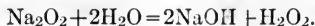

Its bleaching effect is due to the ready decomposition of the hydrogen peroxide in contact with organic matter (such as wool):



The oxygen, at the moment of its liberation in such a manner, is especially reactive (so-called *nascent oxygen*), and easily destroys the organic coloring matters of which the pigment of the wool consists. It is necessary to neutralize the caustic soda in the solution by the addition of sulphuric acid, as the presence of the caustic alkali in the bleaching bath would rapidly destroy the wool fiber. On this account the bath is usually prepared by first adding the requisite amount of sulphuric acid to the water, and then slowly adding the sodium peroxide. Under these circumstances the peroxide reacts with the sulphuric acid to form sodium sulphate (glaubersalt) and hydrogen peroxide:

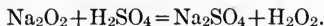

In order to insure the fact that there is no free caustic soda in the solution it is best to use a slight excess of acid, which may be indicated by testing the bath with a piece of blue litmus paper. This will be turned red in the presence of an excess of acid. The bleaching effect of the dissolved hydrogen peroxide, however, is stronger in an alkaline solution than in an acid one; this is due to the fact that the peroxide more readily decomposes in the former solution. Therefore where the bleaching bath is in actual use it should be made slightly alkaline with a reagent which will not be injurious to the wool. Sodium silicate has been found to be most suitable for this purpose, though ammonia or borax may also be used. In this connection it must be remarked that a large excess of sulphuric acid must be avoided, otherwise when the silicate is added it may separate in a jelly-like mass and ruin the bath. During the bleaching of the wool the bath should be maintained at a temperature of about 100° F. If the temperature is much higher than this the hydrogen peroxide will be too rapidly decomposed and loss of oxygen will be occasioned; if the bath is too strongly alkaline a similar condition will result.

The sodium peroxide bleaching bath must be contained in a wooden vat and the pipes used for connections and heating should be of lead. The presence of all other metals, especially iron, should be rigidly excluded;

even the sulphuric acid and the water employed in the bath should be perfectly free from iron, otherwise very inferior results will be obtained. A suitable strength for the bleaching bath is 5 lbs. 5 ozs. of sulphuric acid (168° Tw.) and 4 lbs. of sodium peroxide (98 per cent) per 100 gallons of water. The character of the wool or the nature of the material to be bleached may necessitate a somewhat stronger bath than this, in which case the same relative proportions of acid and peroxide should be used.

Wool bleached with sodium peroxide does not exhibit the same defects as noted under the bleaching with sulphurous acid. It does not retain any substance deleterious to dyed colors, nor does the yellow tint of the natural pigment return on exposure to the air, for this pigment appears to be permanently destroyed by the peroxide. Attention may here be drawn to the radical difference in the principle of bleaching with sulphurous acid and with sodium peroxide. In the former case the bleaching takes place through the *reducing* action of the sulphur dioxide, whereas in the latter case the bleaching is brought about by the strong *oxidizing* action of the peroxide.

In order to ascertain if the bleaching bath of sodium peroxide after use still contains active oxygen for further use in bleaching, the following test may be carried out: A small quantity of the residual liquor is placed in a test tube and a few drops of a dilute solution of potassium permanganate are added. If the bath still possesses an oxidizing action, the violet color of the permanganate solution will be quickly destroyed.

4. Bleaching Wool with Potassium Permanganate.—This compound is also a strong oxidizing agent, and its solution will rapidly destroy the natural pigment of wool. In the decomposition of the permanganate, however, whereby it liberates oxygen, there is also formed an insoluble hydrated oxide of manganese, which is precipitated in the wool and imparts to it a brown color. The decomposition (or oxidizing action) of the permanganate is facilitated by the presence of sulphuric acid, and the bleaching effect is completed in a relatively short space of time. In order to remove the insoluble brown compound of manganese from the fiber it is best to treat the material in a cold dilute solution of sodium bisulphite. The sulphurous acid present in the latter solution reacts with the manganese compound to form a colorless soluble product, and the fiber is left in a clear white condition. Care must be taken in this connection not to employ an excess of sodium bisulphite solution, otherwise sulphurous acid will be left in the wool, and will exhibit the defect already noted under the consideration of the sulphurous acid bleach. If this latter defect is avoided, the permanganate bleach on wool is probably as satisfactory as the peroxide bleach. It can also be carried out in much less time. Too strong a solution of permanganate must be avoided, otherwise the wool will acquire a harsh feel, due to the oxidation of the fiber.

The bleaching bath of potassium permanganate may be prepared as follows: For 100 lbs. of material use

300 gallons of pure water,
2 lbs. of potassium permanganate crystals.

Steep in the cold bath for one hour, then squeeze and pass into a fresh bath containing

300 gallons of water,
7 gallons of sodium bisulphite sol. (32° Tw.),
6 pints of oil of vitriol.

Steep in the cold bath for two hours, then squeeze and rinse. The tinting is conducted in the same manner as for the other methods of bleaching. The permanganate bath, as a rule, cannot be used over again by replenishing, as the permanganate salt becomes decomposed and loses its bleaching efficiency.

With regard to the comparative cost of the several methods of bleaching wool, it may be stated, in general, that the sulphurous acid bleach is the cheapest, while the peroxide method is the highest. An approximation to the comparative cost of the three methods (for yarn) is as follows:

Sulphur bleach (gas)	1 $\frac{3}{4}$ cts. per lb.
Permanganate bleach	2 $\frac{1}{2}$ cts. per lb.
Peroxide bleach	4 $\frac{1}{2}$ cts. per lb.

The permanganate method has not come into favor as yet, apparently on account of it being more difficult to regulate.

5. Bleaching Silk.—The pure fiber of silk is remarkably white in appearance, and will only require bleaching in special cases, as when a snow-white fabric is desired. Soupled and *écru* silk, not having all of the silk-glue removed will contain more or less coloring matter, and especially if of the yellow-gum variety. Such silk is frequently bleached as an operation in scouring, dilute solutions of *aqua regia* often being used (see p. 99). Tussah silk is of a rather dark brown color which it does not altogether lose even after complete boiling-off. Owing to the difficulty, however, of bleaching this silk satisfactorily it is usually left in its natural color, which thus becomes a distinctive characteristic of this class of silk.

Silk may be bleached in practically the same manner as wool. The sulphur or stoving process may be used as described on page 108, the dampened silk being hung in the sulphur chamber overnight. This method, however, has all the objections already referred to under the bleaching of wool; that is to say, it is not permanent, and the retention of even traces of the sulphurous acid by the fiber causes difficulties in

dyeing subsequently. On this account the most approved method of bleaching silk at the present time is by the use of either hydrogen peroxide or sodium peroxide. The action in both cases is practically the same, though the latter is considerably cheaper. Sometimes the use of hydrogen peroxide is preferred as no metallic salts are then introduced into the bath, as would be the case when sodium peroxide is used. When hydrogen peroxide is employed the silk is steeped for eight to ten hours (generally overnight) in a solution containing 2 to 3 gallons of hydrogen peroxide (12 vols.), $\frac{3}{4}$ to $1\frac{1}{4}$ pints of sodium silicate, and 1 lb. white soap (previously dissolved), and 10 gallons water. The bath is maintained at about 120° F. during the bleaching. After coming from the bleaching bath the silk is rinsed first in a bath containing a small amount of sulphuric acid, and then with fresh water. When bleaching with sodium peroxide the bath is prepared and used in the same manner as described for wool (see p. 110).

6. Experimental. Exp. 28. Bleaching Wool by Tinting.—Take a well-scoured test skein of woollen yarn and work in a lukewarm bath (containing a trace of oxalic acid and a trace of Acid Violet 2 B (about $\frac{1}{300}$ per cent on the weight of the wool will, as a rule, be ample dyestuff). Take great care not to add too much of the coloring matter, otherwise too distinct a color will be imparted to the wool. After tinting, squeeze and dry. It will be found that the violet coloring matter has neutralized the yellowish tint of the wool, so that the material seems whiter than before. To show the same operation on cotton, take a test skein of cotton yarn which has been well scoured out with 2 per cent of Monopol oil, and work it in a dilute lukewarm soap bath containing a trace (about $\frac{1}{100}$ per cent on the weight of the cotton) of Methyl Violet 5 B. Then squeeze and dry. It will be found that, as with the wool, the skein of cotton will appear whiter after tinting, owing to the fact that the violet-blue color has destroyed the yellowish color of the natural fiber.

Exp. 29. Bleaching Wool with Sulphurous Acid Gas.—Take a skein of well-scoured woollen yarn, wet it out in water, then squeeze it so that the wool is left only moist; place it in a compartment filled with sulphurous acid gas for twelve to twenty-four hours. Then wash well in water, and then in a bath containing a trace of oxalic acid and Acid Violet for tinting.

Exp. 30. Bleaching Wool with Sodium Bisulphite.—Prepare a bath containing 300 cc. of water and 10 cc. of sodium bisulphite solution (32° Tw.). Immerse two well-scoured skeins of woollen yarn in this bath, work well for about fifteen minutes, then allow to soak for twelve to twenty-four hours. Then squeeze and work in a bath containing 5 per cent of sulphuric acid (on the weight of the wool). Then wash the first skein well in water, and finally in a bath containing a trace of oxalic acid and Acid Violet for tinting. Then squeeze and dry. Take the second skein so bleached and pass through a cold bath containing a couple of drops of a dilute solution of potassium permanganate (just sufficient to give the water a violet color), and then wash again. If too strong a solution of the potassium permanganate is used the wool will acquire a brownish color, and will have to be passed through a dilute bath of sodium bisulphite in order to remove the brown hydrate of manganese which will be precipitated on the fiber. Cut about 6 ins. from each of the two bleached skeins and plait with portions of a skein of woollen yarn which has been dyed with Magenta (a dyestuff quite susceptible to the action of sulphurous acid), and allow the samples thus prepared to remain for several days. The

skein of dyed yarn may easily be prepared by working a skein of woollen yarn in a bath containing 300 cc. of water and about 5 cc. of a solution of Magenta for one-half hour at a temperature of 180° F. On examination after a time it will be found that the bleached skein which was not treated with the potassium permanganate solution has caused a discoloration of the dyed sample with which it was plaited, whereas the other bleached skein has not. This test shows the presence of sulphurous acid in the former and the absence of it in the latter.

Exp. 31. Bleaching Wool with Sodium Peroxide.—Prepare a bath containing 300 cc. of water and 3 cc. of concentrated sulphuric acid; then carefully add with constant stirring 4 grams of sodium peroxide. Test with litmus paper, and if not acid in reaction, add sufficient dilute sulphuric acid to turn the paper red. This will neutralize all of the caustic soda formed in the decomposition of the sodium peroxide with the water. Now add sufficient sodium silicate solution to make the bath slightly alkaline; that is, until it turns the litmus paper blue again. Heat the bath to 120° F., when it is ready for bleaching. Take a well-scoured skein of woollen yarn and work it in this bath for fifteen minutes, and then allow it to steep under the liquor for twelve to fifteen hours, maintaining the temperature as nearly as possible at about 100° F. during that time. Then wash well and squeeze, and finally tint in a bath containing a trace of oxalic acid and Acid Violet. Then squeeze and dry.

Exp. 32. Bleaching Wool with Potassium Permanganate.—Prepare a bath containing 300 cc. of water and 0.2 gram of potassium permanganate and 5 per cent (on the weight of the wool) of sulphuric acid. Warm the bath to 100° F., and steep a well-scoured skein of woollen yarn therein for about five minutes, working during that time. Then rinse, and it will be found that the wool has become brown in color (this is due to the precipitation of hydrated oxide of manganese on the fiber, resulting from the decomposition of the potassium permanganate). Next work the skein in a cold bath containing 300 cc. of water and 2 cc. of sodium bisulphite solution (of 32° Tw.). The wool will rapidly turn white as the brown deposit of manganese oxide is dissolved by the bisulphite of soda.

CHAPTER IV

BLEACHING OF COTTON

1. General Method of Cotton Bleaching.—Ordinary American cotton is of a comparatively white color when in the natural raw state; but, nevertheless, it contains a small amount of natural pigment matter of a yellowish brown color. This pigment is so small in amount that it does not interfere in the general dyeing of cotton; but when light, delicate shades are desired in dyeing, or when the cotton material is to be left in the white condition for sale, it is usually necessary to bleach it. Cotton in the loose state is seldom bleached, since the bleaching processes considerably deteriorate the spinning qualities of the fiber by removing its waxy coating; the fiber is also made more brittle by the bleaching, which causes a largely increased amount of waste in carding and spinning; furthermore, after bleached cotton is passed through the numerous mechanical operations of carding and spinning it will become more or less discolored and will have acquired considerable dirt, so that the final yarn or cloth would be unsatisfactory as a bleached product. Yarn is sometimes spun from bleached stock for the manufacture of knit goods, thus giving a half-bleached product; it is also used for half-bleached filling yarns. Cotton yarn is frequently bleached both for the purpose of being dyed in delicate shades and of being manufactured into white goods—more especially knitted fabrics, lace, etc. The chief form, however, in which cotton is bleached is that of cloth; in which case it may be used (a) as a *bleached bottom* for the dyeing of delicate shades or for colors such as Turkey Red, (b) for *print cloth* in the many processes of calico-printing, and (c) for the purpose of being sold in the white state, or as a *market-bleach*.

Though a number of chemical agents have been suggested for the bleaching of cotton, those which have been most successfully and extensively employed are *chloride of lime (bleaching powder)* and *liquid chlorine*. The effective bleaching agent in the chloride of lime is chlorine in a loosely combined condition. But the chlorine itself does not accomplish the bleaching in a direct manner. In the process the chlorine is liberated in the nascent condition in the presence of water; the latter is decomposed by the chlorine yielding hydrochloric acid and nascent oxygen, and it is

this oxygen which causes the bleaching action. The chemical reactions may be thus represented:

Chloride of lime \rightarrow chlorine.

Chlorine + water \rightarrow hydrochloric acid + oxygen.

Chlorine of itself is without any bleaching action, a fact which has been demonstrated by allowing *dry* chlorine to act on sensitive colors, the result being that the colors were not destroyed. Liquid chlorine as a bleaching agent is used by dissolving the gas in an alkaline solution (soda ash, caustic soda, or a mixture of the two) in order to form sodium hypochlorite. This solution is then employed in practically the same manner as that of bleaching powder.

2. The Operations in Cotton Bleaching.—There are five distinct operations in the proper bleaching of cotton:

(1) *Boiling-out*; this is really a scouring operation, the object of which is to remove all the waxy and resinous matters in the fiber.

(2) *Treatment with bleaching powder solution*; this is for the purpose of destroying the natural coloring matter in the fiber, and also for the breaking down of various non-cellulosic matters associated with the cellulose of the cotton.

(3) *Treatment with a dilute solution of acid*; this is generally termed "souring," and is for the purpose of dissolving the lime compounds in the fiber left from the bleaching powder and to decompose any chlorine compounds which may have been formed.

(4) *Washing*; this is for the purpose of removing all soluble matters resulting from the action of the bleaching powder and the acid; also for the removal of the acid from the fiber.

(5) *Soaping and tinting*; this is for the purpose of neutralizing the last traces of acid, and also for softening the cotton. The tinting is to give a slight bluish tone to the white.

3. Boiling-out.—The scouring of cotton intended for bleaching must be carried out much more thoroughly than when the operation is merely for the purpose of wetting-out the cotton previous to dyeing. In the latter case it is only necessary that the external waxy coating on the fiber be removed or softened in order that water may easily impregnate the cotton. But in boiling-out for bleaching it is required to remove very completely all the impurities in the fiber, including the waxy coating, the miscellaneous resinous matters, the albuminous substances, and in fact all matters of a non-cellulosic character. It is the object in bleaching to obtain a practically pure cellulose for the bleached cotton. For the wetting-out of cotton, a dilute solution of soap, soda ash, or soluble oil only is required, but for the proper boiling-out of the cotton a rather strong solution of caustic alkali or soda ash is required; the time of boiling is much prolonged (usually seven to ten hours), and it is generally conducted under pressure in a closed kier.

A variety of methods of kier boiling may be employed. An open kier system may be used; in which case the kier consists merely of a round

upright tank of suitable dimensions. In the bottom is provided a perforated false structure on which the cotton material is placed, a clear space of 6 to 8 ins. being allowed between this false and true bottom for the accumulation of liquor and the placing of steam pipes. The cotton goods (in the form of skeins, warps, woven or knit cloth as the case may be) are packed into this kier systematically so as to avoid possibility of tangling when running out. The packing must be as even as possible so as to prevent uneven distribution and channeling of the liquor through the goods during the boiling. The goods should be packed into the kier until it is about five-sixths filled to the top, then a perforated wooden cover is clamped down on the material so as to hold it in place. To facilitate the wetting-out of the cotton in the kier when first starting to boil, it is best to pass the goods through a tank of hot water and between squeeze rolls before they are run into the kier.* The liquor employed for boiling-out in this kier is usually a caustic soda solution, containing 3 to 5 per cent of caustic soda on the weight of the goods. A mixture of caustic soda and soda ash may be employed, in which case about 3 per cent of each ingredient is used. Silicate of soda is also a suitable compound to use in the boiling process, 4 to 6 per cent of silicate being used with 3 per cent of caustic soda. There are a number of bleach assistants on the market which form very good boiling-out agents, and these as a rule consist of various mixtures of caustic soda, soda ash, and silicate of soda. For the handling of small quantities of material it is sometimes advantageous for the bleacher to buy these "assistants," as they are compounded in a convenient form for ready use.†

An all-important point in the proper boiling-out of cotton materials is the circulation of the liquors through the goods. In an open kier this

* In the case of skein yarn, the goods are usually headed up in the form of small bundles or linked together in a continuous chain. Warp yarn is usually doubled several times or chained and then run in the same manner as cloth.

† There has been a tendency among some dealers in chemicals to put forward the claim that the presence of neutral salts in the alkalis used in boiling-out cotton were not detrimental to the soda boil. This claim is chiefly for the purpose of covering up the impurities which may be found in their caustic soda and soda ash, and these impurities consist principally of sodium chloride (common salt) and sodium sulphate (glaubersalt). There are even to be found bleachers, who believe that the addition of certain small amounts of these salts to the boiling-out mixture is beneficial. To arrive at the truth in the case, the matter has been carefully investigated, and the results have shown that the addition of common salt or glaubersalt, even in very small quantities, produces an inhibitory effect on the action of the caustic soda in properly removing the impurities from the cotton fiber, and this effect is furthermore a very notable one. The color of the boiled cotton is also detrimentally affected by the presence of these neutral salts. The effect of the addition of sodium phosphate to the soda boil has also been investigated, and its use appears to be almost as detrimental as that of the other two salts above mentioned.

is usually effected by an injector, the liquor being drawn from the bottom of the kier and forced around to the top, where it is distributed over the goods by the perforated cover. The liquor is raised to the boiling point by steam blown through a perforated pipe in the bottom compartment of the kier. In the open kier it will require boiling for ten to twelve hours to bring the cotton to the proper condition. It also requires the use of a large amount of steam both for the heating and the circulation of the liquor, and of this steam a vast amount goes to waste in the open air. On this account open kier boiling cannot be recommended as an economical process. The prolonged treatment which is necessary is also liable to bring damage to the goods in many ways.

Another method for the boiling-out of cotton goods is to use a closed or pressure kier. There are a number of types of these kiers on the market. In one form of kier the circulation is maintained by a steam injector. A pressure of 12 to 16 lbs. is usually maintained in the kier during the boiling. The time required to complete the boiling-out is eight to ten hours, and the usual chemicals already mentioned as being used in the open kier are employed, about 3 per cent of caustic soda or its equivalent in other compounds being used. In another form the circulation is brought about by a vacuum chest operated by high pressure steam. The pressure in the kier is maintained at 10 to 12 lbs., and the time of boiling is reduced under usual conditions to about four hours. The amount of chemicals required for this form of kier is said to be less than for other types, a good boiling-out combination being 2 per cent of caustic soda and 1 per cent of solvine or other soluble sulphated oil. The use of the oil leaves the goods much softer and cleaner in appearance than when alkalies alone are employed. This is due to the fact that the resinous matters in the fiber are readily soluble in the oil and are thus easily removed from the fiber.*

* As to the physical changes brought about in the cotton yarn by reason of the boiling-out process, carefully conducted experiments have shown that the loss in weight (allowing for the same "condition" of the yarn before and after boiling-out) is from 4 to 5 per cent, depending somewhat on the count of the yarn and the nature of the cotton. The shrinkage in length of the yarn due to the boiling-out varies considerably with the conditions, but an average loss calculated from the large series of observations, amounts to 2.6 per cent. In commercial bleaching operations it is customary to allow about 5 per cent shrinkage, but this is seldom actually reached. Both the loss in weight and loss in length affect the true count of boiled-off yarn; a large number of tests have been made on this subject, and the following table exhibits the results. The "true" count of the yarn is given in each case:

Count before Boiling.	Count after Boiling.	Count before Boiling.	Count after Boiling.
24	25.7	80	83.9
32	33.7	100	104.6
40	42.0	120	125.6
70	72.6	150	167.5

Whatever system of boiling-out is employed, it is necessary to wash out the goods thoroughly after the kier treatment with the alkaline liquors. This is usually accomplished by circulating wash waters through the goods while they are still in the kier. The washing is a necessary process, and its purpose is to remove all the dirty alkaline liquor from the cotton together with all the associated impurities contained in these liquors. If the washing is imperfect, kier stains will be left on the goods.

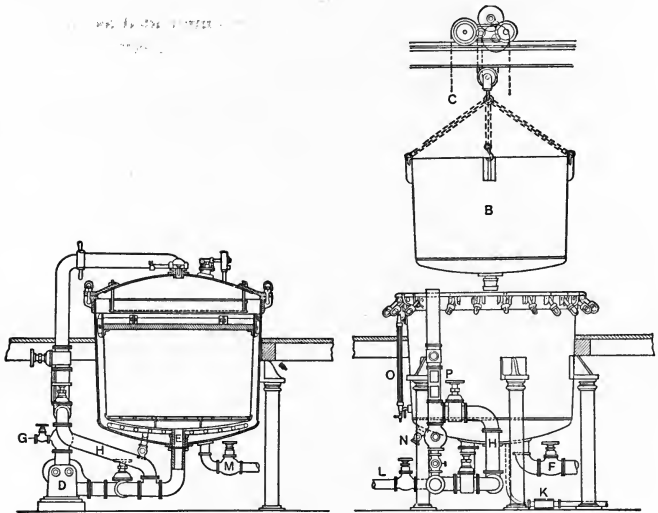

FIG. 93.—Bleaching Kier. (Dehaitre System.)

This very thorough boiling-out of the cotton previous to bleaching is necessitated by the fact that if any resinous matters (or so-called *pectin*)

If the boiling-out process has been properly conducted there should be a slight increase in the tensile strength of the yarn; this rather anomalous condition is caused by the felting and thickening of the fibers. It may be stated as a general rule that any difference in the breaking strength between unbleached and bleached yarn is due to the bleaching process, and is not caused by the boiling-out, provided, of course, that this latter operation has been properly conducted.

Another physical property of the yarn which is affected by the boiling-out process is the twist. The boiling of the yarn causes an increase in the number of turns per inch in the twist; this, of course, is due to the combined effect of shrinkage and tightening of the yarn. From actual data on this subject the average increase in the twist is shown to amount to about 15 per cent.

are left in the fiber, the bleached material will gradually become yellow on exposure to light and air. Formerly *lime* was very generally used for the boiling-out of cotton, in which case it was necessary to pass the material afterwards through an acid bath (so-called *gray sour*) to remove particles of lime which might otherwise "burn" the fiber. It was thought that

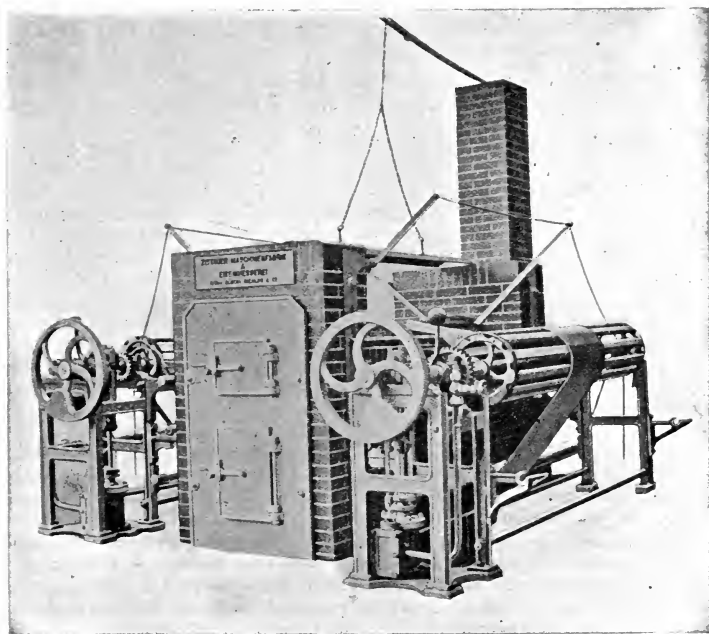

FIG. 94.—Plate Singeing Machine.

boiling with lime caused a more perfect decomposition and removal of the resinous substances in the cotton.* Lime, however, is not so much

* In treating with lime the process in brief was as follows: Freshly slaked quicklime was made up with water into milk-of-lime, through which the cloth was passed, so that it became well saturated with the liquor. From the lining machine the goods were run into the kier for boiling. Though the amount of lime used varied in different works and with different kinds of goods, on the average about 5 to 7 lbs. of dry lime were used per 100 lbs. of cotton cloth. The necessity for the gray sour after a lime boil is due to the fact that insoluble lime soaps are formed in the cloth from the fatty and pectin matters of the cotton. These would not be removed by subsequent washing, but require to be first decomposed by acid into soluble compounds, or rather into compounds that

used at the present time, it being replaced by caustic soda, the action of which is more efficient and requires less time. When the lime boil is used (chiefly with piece-goods) a previous boiling with *resin soap* is usually given. *Silicate of soda* is a very good alkali for boiling-out cotton for bleaching. Many popular "bleach assistants" consist of varying proportions of silicate of soda, soda ash, and caustic soda.* Silicate of soda does not give the cotton such a harsh feel as when caustic soda is used.†

4. Bleaching with Hypochlorites.—After the goods have been boiled-out and washed the next process is treatment with the bleaching liquor. The method of handling the goods in this process will determine the strength

are readily removed by washing. It is claimed by some that lime boiling is less liable to give kier stains on the cloth than when the soda boil is used, but by the use of proper care and the addition of soluble oil to the soda boil, kier stains may usually be prevented. The use of soft clean water is also an aid in this respect. Furthermore, in washing the goods in the kier after the soda boil hot water should be used, as if cold water is brought into contact with the freshly boiled goods the pectin matters will be thrown out of solution and possibly stain the goods. These stains may usually be cleared up by running the goods through a dilute acid bath (hydrochloric or sulphuric acid of 1° Tw. at 100° F.) and then straightway into the bleach.

* Some bleach assistants contain Glaubersalt and other neutral salts added to the caustic alkali, and it is even claimed that the presence of these neutral salts increases the efficiency of the alkali. This, however, has been disproved, for it has been shown (Trotman, *Jour. Soc. Chem. Ind.*, 1910, p. 249), that the addition of such salts in all cases produced a decreased effect in the action of the caustic soda on the cotton.

† Investigations have been made into some of the conditions of the boiling-out of cotton yarns. Thoroughly boiled-off cotton yarn has been shown to contain less than 0.15 per cent of fatty matters and less than 0.10 per cent of nitrogen; yarn showing the presence of greater amounts of these constituents indicate a faulty boiling-off. As to the alkaline agents employed for the boiling-out process it has been found that caustic potash removes the greatest amount of impurities and in the shortest time; from a series of experiments on this matter it has been demonstrated that when employed in equivalent quantities, caustic potash will remove about 20 per cent more impurities from the cotton in the same time. The relative values of the different alkalies employed are given in the following table, which represents the amount of impurities removed from the fiber in what is supposed to be a complete boiling-out operation:

	Per Cent Loss.
Caustic potash.....	5.00
Caustic soda.....	4.40
Sodium carbonate.....	3.70
Sodium borate (borax).....	2.80
Sodium silicate.....	2.40

The chief use of the sodium carbonate in the boiling-out mixture is as an emulsifier, as this alkali does not readily cause saponification of the fatty matters in the cotton. The same remark is also true of sodium borate (borax), though its power in this respect is considerably less. It will be noted that sodium silicate has the least scouring effect, and there is a possibility of this alkali suffering decomposition during the boiling-out process with the result that silica is deposited on the goods; on this account its use has not been recommended on fine goods.

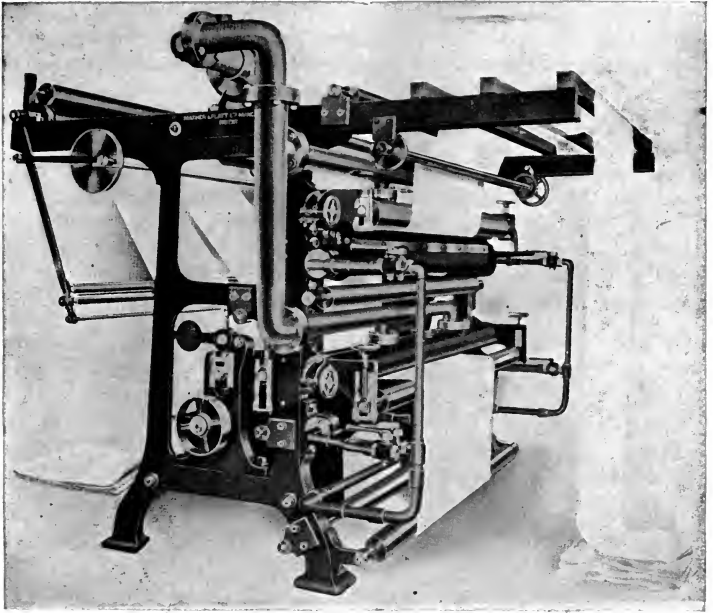

FIG. 95.—Two-Burner Gas Singeing Machine. (Mather & Platt).

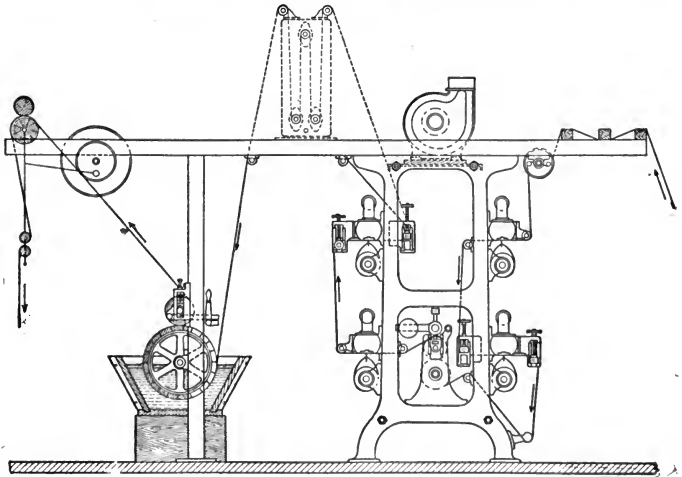

FIG. 96.—Diagram of Gas Singeing Machine.

of chemic to employ. The usual process for cloth is to pass the material through a "chemic" box containing the bleach liquor and provided with squeeze rolls, so that the goods are well padded with the liquor and retain about their own weight of the solution.

The cloth is then folded down into suitable boxes* and allowed to stand exposed to the air and light for one to three hours, depending on the degree of bleaching desired. In this continuous process of treatment the strength of bleaching powder † solution is generally about $2\frac{1}{2}$ to 4° Tw. After the goods have whitened up to the proper point they are run in the same continuous manner through another tank provided with running water for the purpose of washing out the lime from the cloth. From the washing tank the goods then pass directly to a third

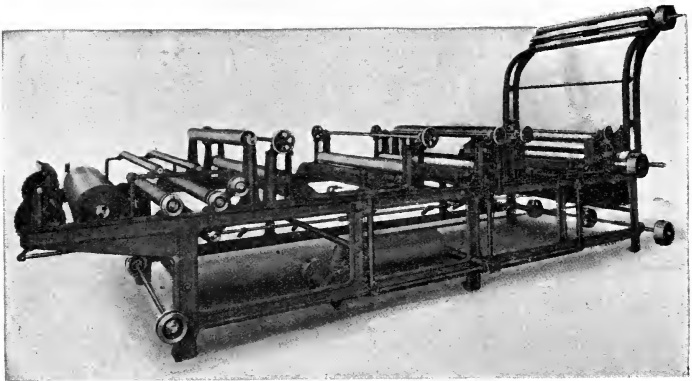

FIG. 97.—Five-Burner Gas Singe, Tulpin Style. (H. W. Butterworth & Sons Co.)

tank containing a solution of anti-chlor. The amount of this chemical required will depend of course on the strength of the chemic originally employed, but usually from 3 to 5 per cent of the weight of the goods will be necessary. Anti-chlor consists of bisulphite of soda in solution

* These usually consist of large wooden or concrete tanks.

† If sodium hypochlorite solution is used (prepared from liquid chlorine and alkali, from bleaching powder and soda ash, or from the electrolysis of salt) the strength of the chemic should be about one-half that of bleaching powder in terms of the content of active chlorine. That is to say, bleaching powder solution of 3° Tw. represents a content of about $8\frac{1}{2}$ grams per liter of active chlorine; so the sodium hypochlorite solution should be of a strength to represent about $4\frac{1}{2}$ grams per liter of active chlorine. The density of the liquor should not necessarily be taken as a criterion, as this may not represent at all accurately the real bleaching activity, but may vary with the presence of dissolved salts.

and it possesses the property of neutralizing chlorine compounds and thus removing them from the fiber. Instead of using anti-chlor it is also possible to employ a dilute solution of sulphuric acid. A solution of about 1° Tw. is the customary strength.

3. Bleaching Powder and its Use.—Bleaching powder or chloride of lime is prepared by treating slaked lime with chlorine gas. Its chemical

formula is $\text{Ca} \begin{cases} \text{OCl} \\ \text{Cl} \end{cases}$, or CaOCl_2 . It is commonly known as “chemic”

or “bleach.” Chloride of lime is a yellowish white powder which smells strongly of chlorine, especially if moistened.* When treated with water it partly goes into solution and partly forms a bulky white precipitate con-

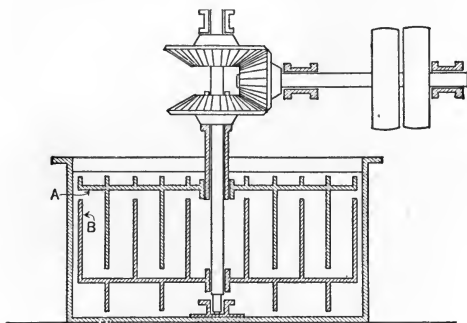
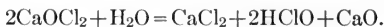

FIG. 98.—Stirring Arrangement for Dissolving Bleaching Powder. (Zipser.)

sisting for the most part of lime (CaO). The solution has a yellowish color and is the liquid employed for the preparation of the bleaching bath. A good quality of chloride of lime should contain about 36 per cent of available chlorine, that is to say, chlorine which is active in the bleaching process. The exact chemical reactions which take place in the use of chloride of lime are not thoroughly understood, though they have been the subject of much investigation. It is probable that when chloride of lime is dissolved in water, calcium chloride (CaCl_2), hypochlorous acid (HClO), and calcium oxide (CaO) are formed, as follows:



* Exposure to the action of carbon dioxide also causes the evolution of chlorine from both bleaching powder and its solutions (see Taylor, *Jour. Soc. Dyers and Col.*, 1910, p. 115). This effect of carbon dioxide has not generally been recognized by bleachers in practice, it usually being considered that carbonic acid causes the formation of hypochlorous acid when acting on solutions of bleaching powder.

Hence the bleaching liquor, as used, may be considered as a solution of hypochlorous acid; the calcium chloride produces no effect in bleaching.* No doubt a portion of the lime also remains in solution as calcium hypochlorite ($\text{Ca}(\text{OCl})_2$). The insoluble calcium oxide is filtered off (or settled out) before the bleaching liquor is used. Hypochlorous acid is a very unstable substance (especially in the presence of organic matter, such as the fibers), and it readily decomposes into water and an oxide of chlorine (Cl_2O), as follows:

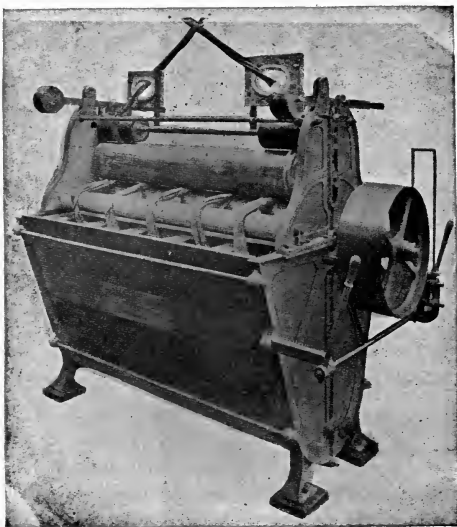
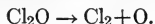
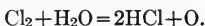

FIG. 99.—Chemic Box.

The latter is a strong oxidant, as it splits up into chlorine and free oxygen.



The chlorine thus liberated reacts with the water present to form hydrochloric acid and another portion of free oxygen:



* The effect of the calcium chloride in the bleaching bath is obscure. It is claimed, however, to be beneficial. The addition of common salt to the bleaching liquor has been recommended as increasing the efficiency of the bleaching. The exact mechanism of its action is not known.

Under certain conditions it is probable that the hypochlorous acid decomposes directly into hydrochloric acid and oxygen:

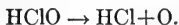

Solutions of bleaching powder are best prepared by first grinding the powder with a small quantity of cold water until a thin uniform paste is

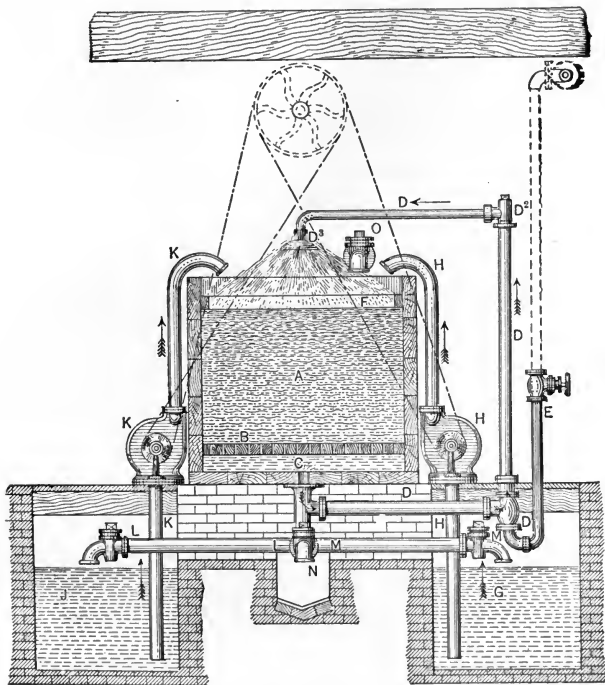
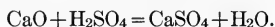
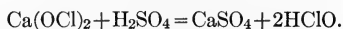

FIG. 100.—Chemic and Souring Box.

obtained, and then diluting with cold water and allowing to settle until the liquor is clear. A concentrated solution of bleaching powder will show a density of about 18° Tw. For the preparation of the bleaching bath this is diluted to about 2° Tw. Care should be taken that no undissolved particles of bleaching powder pass into the bleaching bath, otherwise the cotton may become tendered in spots. It is also necessary that the material be completely immersed in the solution during the bleaching,

for under the influence of the oxygen of the air the bleaching liquor will seriously weaken the cotton. The temperature of the bleaching bath should always be cold; it is only in exceptional cases where low-grade material is treated that the bleaching liquor is ever warmed, and even then only to about 100° F. The time of immersion of the cotton in the bleaching solution should be from one-half to one hour; too long a treatment will cause a tendering of the fiber.

6. The Acid Treatment.—When the cotton comes from the solution of bleaching powder it contains a considerable amount of lime compounds, partly as calcium hypochlorite and partly as calcium oxide; there is also present calcium chloride. The acid treatment (generally known as “souring”) is for the purpose of decomposing the calcium hypochlorite and the calcium oxide:



In the first case hypochlorous acid is formed which furthers and completes the bleaching. In both cases calcium sulphate (gypsum) is formed as a white, finely divided, though insoluble, powder. This is quite easily removed from the fiber by subsequent washing, and being of a very neutral character, has no action on the cotton. As a rule, the cotton comes up much whiter after the souring, and the evolution of free chlorine gas is very evident. The souring is usually done in a cold bath of sulphuric acid of 1° Tw. density. Stronger solutions are not advisable, as they are liable to weaken the cotton. Hydrochloric acid may be used to replace the sulphuric, in which case calcium chloride will be formed, which is a very soluble salt and is more easily removed from the fiber than the insoluble calcium sulphate. To obtain an equivalent acid strength about 2.25 parts by weight of hydrochloric acid should be used for 1 part by weight of sulphuric acid. In case the boiling-out, bleaching, etc., are carried out in machines containing copper or bronze a small amount of copper salt will be formed which with sulphuric acid will produce an insoluble precipitate of a double sulphate of copper and calcium. This will become fixed in the cotton and is very difficult to remove. If hydrochloric acid, however, is used, no insoluble precipitate will be formed, and the copper salt is easily washed away.

7. Washing.—Immediately following the souring the cotton should be thoroughly washed with fresh water in order to remove as far as possible all of the acid. Should the washing be delayed for any length of time there is danger of portions of the bleached material becoming dry, which will cause tender spots to form. The washing should be continued until the presence of acid is no longer evident; this may be shown by testing the

cotton with a piece of blue litmus paper, which will turn red if any acid is present. The washing is also for the purpose of removing the sulphate of calcium which is precipitated in the cotton during the souring. The chlorine which is generated in the material during the same process is also removed by the washing, and care should be taken to eliminate it very thoroughly, otherwise the cotton will subsequently be weakened by over-oxidation and the formation of acid in the fiber. The presence of chlorine in the cotton may be tested for by a mixed solution of potassium

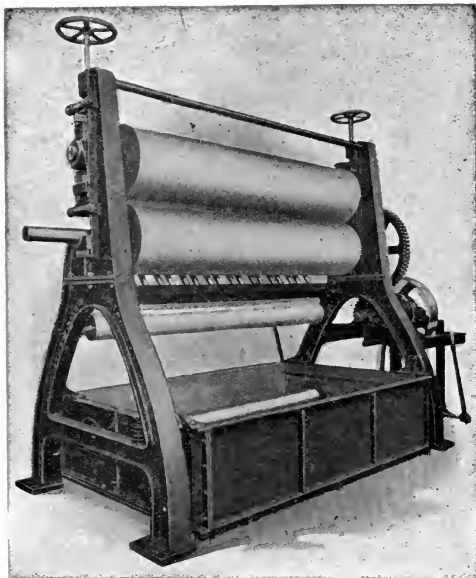

FIG. 101.—Bleach House Washer. (Textile-Finishing Machinery Co.)

iodide and starch paste, which will give a blue color with a trace of chloride. This test depends on the fact that chlorine liberates iodine from potassium iodide, and the free iodine combines with the starch to form a compound with an intensely blue color.

8. Soaping and Tinting.—The final operation essential to the bleaching of cotton is that of soaping. For this purpose the material is treated in a dilute lukewarm solution of soap. The latter should be of good quality and free from any ingredients liable to cause discolorations in the dried and finished bleach. The object of the soaping is primarily to *soften* the

cotton, which will have acquired considerable harshness in the boiling-out, bleaching, and acid treatments. It also has the purpose of neutralizing absolutely all trace of acid in the cotton, and thus preventing subsequent tendering. In the soap bath it is also customary to add a small quantity of a blue dyestuff, such as Cotton Blue, Methylene Blue, Soluble Prussian Blue (bleacher's tint), etc., for the purpose of *tinting* the bleached white to a satisfactory bluish tone. In case a cream white bleach is desired, the tinting is omitted. Care must be had not to tint the cotton too strongly, otherwise the material will appear dull and dirty.

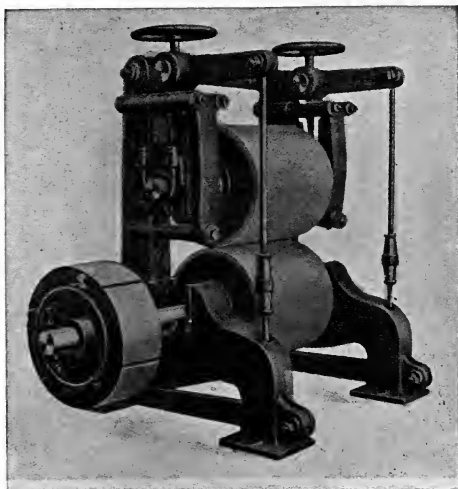

FIG 102.—Bleach House Squeezer. (Textile-Finishing Machinery Co.)

In the entire process of bleaching, the cotton will lose in weight about 5 to 7 per cent. If properly bleached the loss in tensile strength should not be over 5 per cent. The elasticity will be somewhat less than that of the unbleached cotton. The tendering of cotton in bleaching may be due to several causes:

(1) Oxidation caused by exposure to the air during the boiling-out process. If a skein of cotton yarn is so hung as to be partly suspended in a solution of caustic soda and boiled thus for some time, it will be found to be seriously weakened at that part where it comes into contact simultaneously with the alkaline liquor and the air.

(2) Oxidation due to the use of too strong a solution of bleaching powder, or to its becoming overheated.

(3) The drying of acid in the fiber or of particles of lime from sediment in the bleaching bath.

The oxidation of cotton leads to the formation of a substance known as *oxycellulose*, which is structureless and friable in character, hence its formation leads to a weakening of the fiber. The presence of oxycellulose may usually be recognized by staining the cotton with a dilute solution

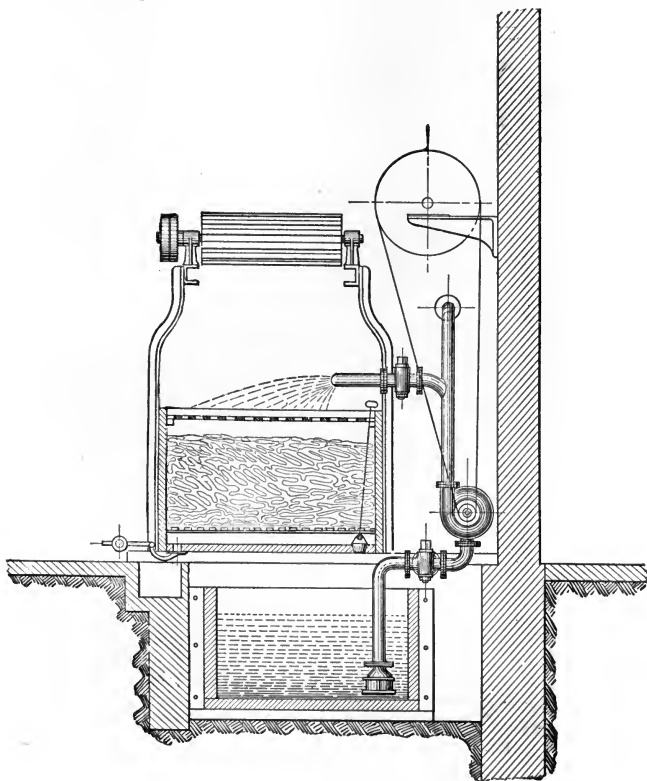

FIG. 103.—Bleach Vat for Warps and Skeins.

of Methylene Blue; ordinary cotton has but slight affinity for this coloring matter, whereas oxycellulose is strongly dyed.

9. Use of "Anti-chlor."—As the perfect removal of the chlorine from the cotton is very difficult by simply washing with water, it is sometimes expedient to neutralize the free chlorine with a suitable chemical agent. The chief substances used as "anti-chlors" are sodium hyposulphite

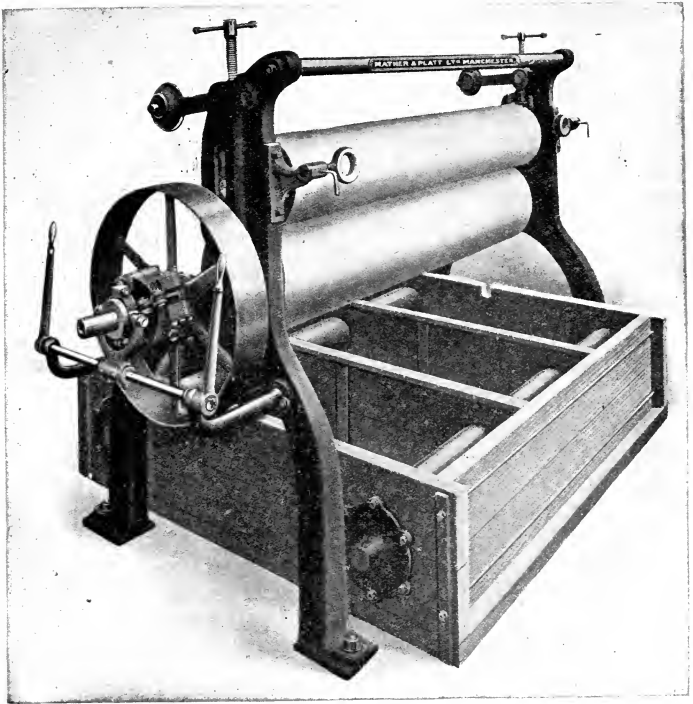

FIG. 104.—Roller Washing Machine. (Mather & Platt.)

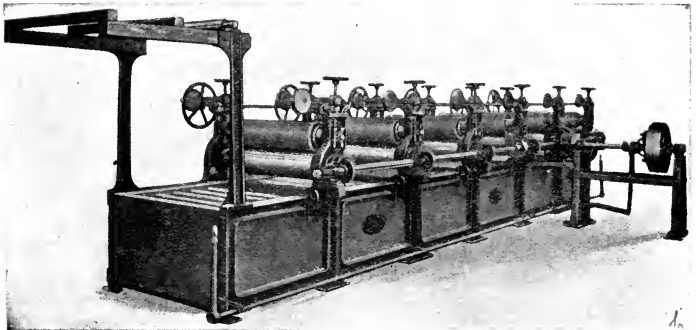

FIG. 105.—Six-Compartment Open Washer or Soaper. (Textile-Finishing Machinery Co.)

($\text{Na}_2\text{S}_2\text{O}_3$) and sodium bisulphite (NaHSO_3). The reactions in the two cases are as follows:

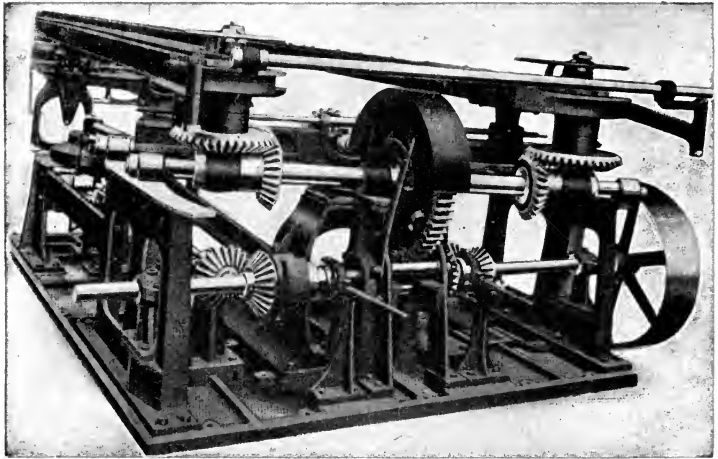
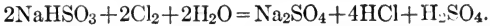
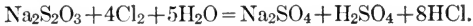
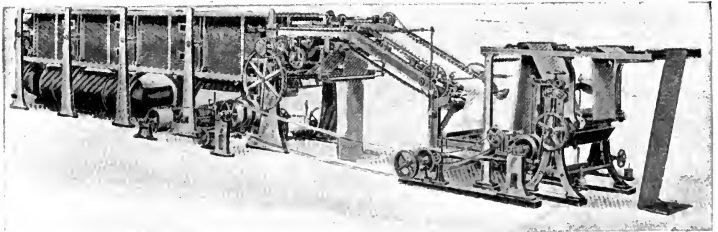

FIG. 106.—Vibratory Tentering Machine. (H. W. Butterworth & Sons Co.)



• FIG. 107.—Tentering and Drying Machine.

After treatment with anti-chlor the bleached cotton should be well washed and soaped, for it will be noticed from the above reactions that acid is formed in both cases.

10. Use of Acetic Acid.—In some cases cotton is bleached with the use of acetic rather than sulphuric acid. Acetic acid is less liable to cause tendering of the fiber, and the acid may be added directly to the bath of

chloride of lime, though this causes a considerable loss of chlorine. Otherwise the acetic acid acts in the same manner as sulphuric acid. Although this method has been strongly advocated by some chemists it does not seem to have acquired much practical importance.

11. Bleaching with Sodium Hypochlorite.—This reagent is also known as “chloride of soda,” and corresponds to chloride of lime in its bleaching

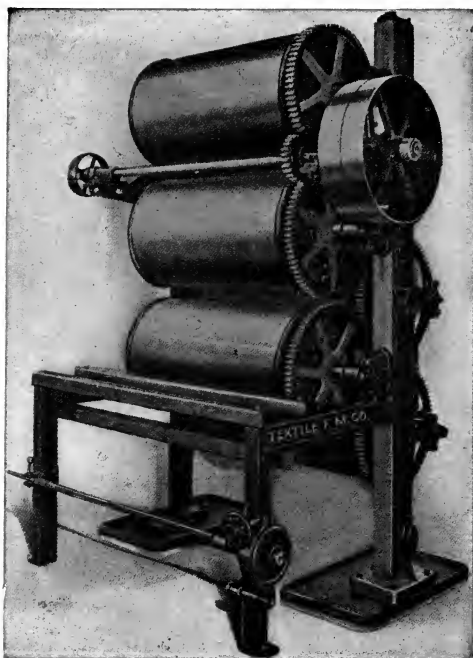

FIG. 108.—Upright Drying Machine with Tension Stands.
(Textile-Finishing Machinery Co.)

properties.* It may conveniently be prepared by adding a solution of soda ash to one of chloride of lime until no further precipitation takes place. †

* Sodium hypochlorite costs about twice as much as bleaching powder, but, on the other hand, its chlorine is twice as energetic in bleaching. Therefore but little advantage in cost attends the use of sodium hypochlorite, except where a very soluble salt is needed.

† A good proportion of the ingredients to use is 60 to 65 lbs. of soda ash to 100 lbs. of bleaching powder, supposing the latter to be full strength (36 per cent available chlorine).

The white sediment of calcium carbonate is allowed to settle and the clear liquor containing sodium hypochlorite in solution is drawn off and used for bleaching. As there is always a small amount of caustic lime ($\text{Ca}(\text{OH})_2$)

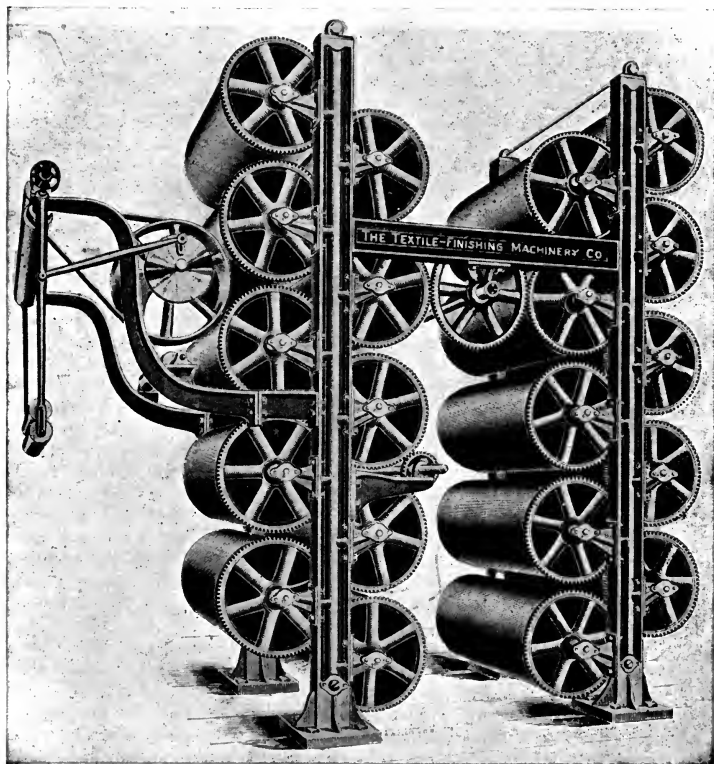

FIG. 109.—Upright Drying Machine with Folder. (Textile-Finishing Machinery Co.)

present in solutions of bleaching powder, a proportionate amount of caustic soda will be present in this solution.* It is generally used for the bleaching

* Sodium hypochlorite may also be made by the addition of caustic soda to a solution of bleaching powder; and still another method is the action of sodium sulphate on bleaching powder. The advantage of using the latter is the low price of sodium sulphate; there is precipitated in this reaction, however, very finely divided calcium sulphate, which is slow in settling. In order to improve on this it is best to add some soda ash along with the sodium sulphate, whereby some calcium carbonate is formed, which settles rapidly and also carries down the calcium sulphate.

of fine and delicate fabrics and where it is not desirable to introduce any lime into the cotton.*

12. Bleaching with Liquid Chlorine.—A bleaching agent consisting of sodium hypochlorite is prepared by saturating a cold solution of caustic soda or soda ash with chlorine gas.† It is used in the same manner

* Though solutions of chloride of lime have now been used in practical bleaching for over a century, and the methods employed give admirable results at a very low cost, yet there are certain disadvantages and disagreeable features attached to the use of chloride of lime, and it would mark a considerable advance in the art of bleaching if these could be overcome. In fact, in order to obviate some of these disadvantages, solutions of sodium hypochlorite in some cases have been employed; these solutions being prepared by the interaction of soda ash with a solution of chloride of lime. Such hypochlorite liquors, however, are more or less strongly alkaline, and are rather expensive for practical use. It was sought, however, to obtain in this manner a bleaching liquor that contained no lime in solution, which would be mild in its action on the fiber, yet thorough in its decolorizing effect on the pigment matter. The chlorine must also be in such a form as admits of its ready and complete use as an oxidizing agent, for it must be borne in mind that the bleaching effect with chlorine liquors is not caused by the direct action of the chlorine itself, but by its indirect action with water to liberate oxygen in a strongly reactive chemical condition. In the preparation of sodium hypochlorite liquors from chloride of lime, there is more or less loss in efficiency of the original chlorine value. First there is the original chemical reaction in the preparation of the gaseous chlorine (either by the older chemical processes or by the newer electrolytic methods), then this is converted into bleaching powder by reaction with quicklime, and this bleaching powder is finally by another chemical reaction brought into the condition of sodium hypochlorite. Of course, in each one of these transformations there is more or less loss of value.

The use of solutions of sodium hypochlorite, however, was regarded with some favor, especially for the bleaching of fine and delicate fabrics, as the chemicals were easily and completely removed from the goods with a minimum treatment with acid and washing. The use of chloride of lime always necessitates a rather thorough acid treatment to decompose the chlorine compounds and allow of their ready removal from the fiber. A very thorough series of washings must also be given the fabric to remove all trace of the chemicals involved. This necessitates the employment of a large amount of water and a rather severe mechanical treatment in the washing machine.

As sulphuric acid is mostly used for the souring of bleached goods, a highly insoluble sulphate of lime is precipitated in the fiber, and becomes rather difficult to remove from the goods; while its presence, at least, causes the bleached fabric to be harsher, and may indeed result in other defects and even tendering. By the use of sodium hypochlorite no insoluble mineral compound is left within the fiber, and as all of the compounds formed by the bleaching reactions are very soluble, a comparatively slight degree of washing is required for the complete removal of all chlorine derivatives, the prolonged action of which is very injurious to the cotton fiber.

† Chlorine gas is made on a large scale as a by-product in the manufacture of caustic soda by electrolysis of common salt. The gas is purified, dried, and liquefied in special apparatus, and put in steel cylinder containers, usually holding about 100 lbs. of the liquefied gas and under a pressure of about 90 lbs. per square inch at ordinary room temperature (70° F.). In this form it is very convenient to use in the preparation of hypochlorite liquors, as the gas may be run directly from the container under proper control in any desired amount.

as sodium hypochlorite and is a very efficient bleaching agent. This method of bleaching has come into very extensive use in the United States and has much to recommend it. In the first place, on dissolving chlorine in soda ash a clear liquor is obtained free from any sediment; the long period of settling is done away with and there is no disagreeable sludge to dispose of. In the second place, the bleach liquor does not contain any lime salts or other compounds which are liable to be precipitated in the goods and give rise to subsequent defects. Furthermore the bleach liquor prepared in this way shows about twice the bleaching activity of chloride of lime solutions containing the same amount of available chlorine. The same thing is true of sodium hypochlorite solutions made from bleaching powder and soda ash or from the electrolysis of salt, and is due to the more rapid oxidizing action of the sodium salt.

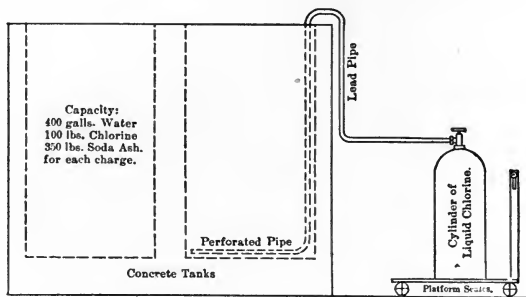

FIG. 110.—Diagram of Liquid Chlorine Installation for Preparation of Sodium Hypochlorite Bleach Liquor.

The usual method of making a bleach liquor with liquid chlorine is to use $3\frac{1}{2}$ lbs. of soda ash for 1 lb. of chlorine. It is necessary to use this excess of alkali in order to prevent the decomposition of the solution. The solution thus obtained is strongly alkaline, and should be used for bleaching soon after being prepared, as otherwise the bleaching strength will run down. Or, $1\frac{1}{4}$ lbs. of caustic soda may be used for 1 lb. of chlorine. This will give a solution more nearly neutral, and it will also keep longer than the one made with soda ash. The chlorine, however, is not absorbed as readily by the caustic soda as it is by the soda ash, and unless good stirring is used, small quantities of chlorine gas will continually escape while making the solution, giving rise to very objectionable and corrosive fumes. Also in making the solution with caustic soda the liquor heats up and it is generally necessary to cool with ice in order to prevent loss of chlorine. At times the solution is prepared by using a mixture of soda ash and caustic soda.

In preparing a liquid chlorine bleach liquor on a large scale a cement vat is used for holding the alkali solution. On a basis of 100 lbs. of liquid chlorine use 350 lbs. of soda ash dissolved in 400 gallons of water. The vat should be about $3\frac{1}{2} \times 3\frac{1}{2}$ ft. and 5 ft. deep. The cylinder of liquid chlorine is connected with a lead pipe running into the vat and perforated at the bottom. The flow of chlorine is regulated by the outlet valve on the cylinder, and should be so controlled that no gas escapes into the air. As the chlorine evaporates from the liquid in the cylinder there is considerable reduction of temperature which will usually cause frost to form on the outside of the container, and also cause a reduction in the flow of the gas. If it is necessary to stimulate the flow of gas hot water

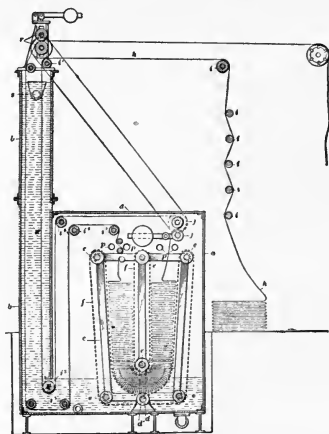

FIG. 111.—Continuous Bleach System. (Rigamonti-Togliani.)

or steam may be run over the container. Care should be had not to overcharge the solution with chlorine, as then the liquid will decompose and soon entirely revert to salt with liberation of oxygen with effervescence. The solution of hypochlorite prepared from liquid chlorine may be used in place of the ordinary liquor of bleaching powder without further adjustment of the bleaching process. The proper strength of the bleach liquor cannot be regulated by the density or hydrometer reading (with either Twaddell or Baumé hydrometer) as the presence of a large amount of salts causes a rather high density irrespective of the chlorine strength. Of course in freshly prepared solutions the hydrometer reading will show the comparative strength of the liquor; for ordinary purpose of bleaching this should be about $1\frac{1}{2}$ to $2\frac{1}{2}^{\circ}$ Tw., but liquid

chlorine bleach solutions of this strength have approximately one-half the active chlorine strength of chloride of lime solutions of the same density, although they possess the same bleaching ability.

13. Electrolytic Bleach Liquors.—Solutions of sodium hypochlorite prepared electrolytically by the action of the electric current on a solution of common salt are also employed in bleaching. It is claimed that liquors thus prepared show a much higher bleaching efficiency than ordinary solutions of sodium hypochlorite, but actual bleaching tests carried out with sodium hypochlorite solutions prepared from bleaching powder and soda ash, from liquid chlorine and soda ash, and by the electrolytic methods

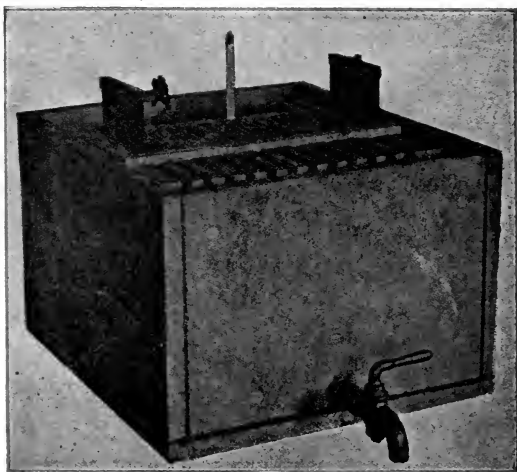

FIG. 112.—Electrolyzer for Bleach Liquor. (National Laundry Machine Co.)

all show practically the same bleaching effect for the same content of available chlorine.

There are a number of different cells on the market for the preparing of bleaching liquors directly, and for small-scale operations they have proved very successful in many cases, especially in laundries where they are very largely used. They have also been tried in various textile bleacheries, but here it is mostly conceded that the use of liquid chlorine is more convenient and less costly. The current efficiency of cells making sodium hypochlorite directly is low, and on a large scale it is more economical to make the chlorine and the caustic soda separately. One advantage possessed by the electrolytic bleach liquor is that it is practically neutral,

consisting essentially of a solution of sodium hypochlorite with a large excess of common salt and containing very little caustic soda. The electrolytic bleach liquor does not keep for any length of time, as its available chlorine strength rapidly runs down.

As soon as the electric current became a comparatively cheap source of energy, and the possibility of chemical reactions through electrolysis

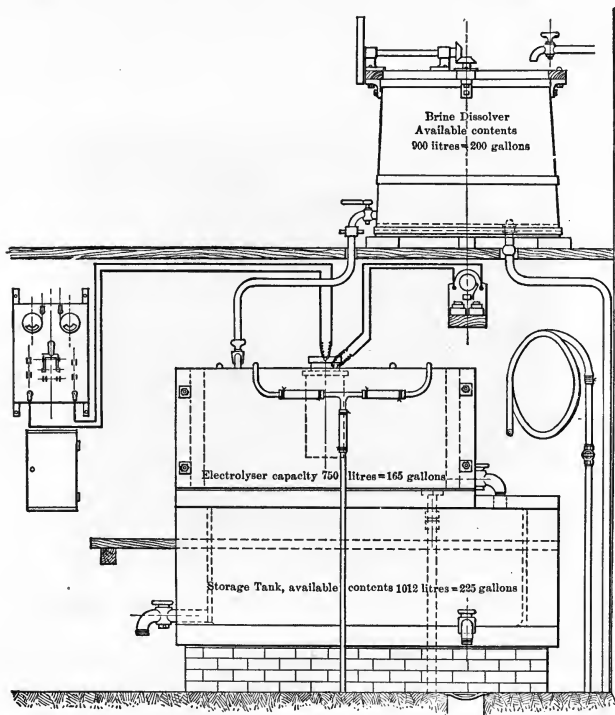

FIG. 113.—Plant for Electrolytic Bleach. (National Laundry Machine Co.)

became known, considerable attention was paid to the electrolysis of solutions of common salt (sodium chloride) with a view to the production of caustic soda and chlorine. When a current of electricity is passed through a solution of common salt, metallic sodium is liberated at one pole and chlorine gas at the other. In a simple cell, however, secondary reactions immediately take place; the metallic sodium at once reacts with the

water present, forming sodium hydrate (caustic soda) and liberating hydrogen gas. In a short time the caustic soda will reach the region of the cell containing the chlorine, and then another reaction occurs whereby sodium hypochlorite is formed. Hence, the products obtained by the action of a current of electricity on a solution of common salt are sodium hypochlorite in solution and hydrogen evolved as a gas.

This process, however, cannot be carried out to such an extent as to produce a concentrated solution of sodium hypochlorite, for secondary reactions soon take place, the sodium hypochlorite, being decomposed into other compounds which revert to sodium chloride again. The amount of hypochlorite formed per unit of current energy decreases with the accumulation of the hypochlorite in the cell, consequently in such type of cell it is not feasible to produce anything but a rather dilute solution of sodium hypochlorite. This solution, however, may be employed directly for bleaching, being properly diluted to meet the conditions required. The cell may be made to operate in a continuous or circulating manner by the constant introduction of fresh salt solution in proportion to the amount of hypochlorite removed.

In order completely to electrolyze the salt it is necessary to separate the products resulting from the primary electrolytic action. This is accomplished by the use of a diaphragm cell, so arranged that the chlorine is removed as a gas from one pole, and the metallic sodium by forming an amalgam with mercury at the other pole. The chlorine is utilized by absorbing it over quicklime or in milk-of-lime, for the production of bleaching powder. The sodium is eventually obtained as caustic soda by decomposing the amalgam with water. The diaphragm cell is in extensive use both in this country and Europe for the independent production of bleaching powder and caustic soda, and is also operated in connection with large paper pulp mills.

It is the hypochlorite cell, however, which has special interest to the cotton bleacher; for its use as at present developed does not involve a large outlay of capital and expert labor, and when employed for the production of dilute solutions of sodium hypochlorite to be used directly in bleaching, its efficiency can be maintained so as to bring the cost of the bleaching down to a favorable comparison with chloride of lime.*

* Outside of the factor of cost, however, there are other considerations to be borne in mind when comparing the method of electrolytic bleaching with that in which chloride of lime is used. In the first place, chloride of lime is an obnoxious substance to handle. This is especially true in mills where only a moderate amount of bleaching is done, and which consequently cannot go to the expense and labor of handling the bleaching powder in the most scientific manner. There is great danger of "fly," or dust from the bleaching powder when being mixed, contaminating or destroying valuable products in the mill. The preparation of the bleaching solution requires a thorough agitation of the chemic with water, then prolonged settling and filtering in order to obtain properly

It is a matter of experience that when bleaching with chloride of lime there is always a strong odor of chlorine gas evident, which shows that

clarified liquor. This requires a series of tanks and pumps and the necessity of handling large amounts of sludge. In order to obtain the full value of the chloride of lime it is necessary to leach out the powder several times. It is therefore easy to understand that the preparation of the bleach liquor in the case of chloride of lime must be taken into consideration when comparing the cost with that of the electrolytic liquor.

In the second place, the bleaching efficiency of the two solutions must be compared. By this is meant, that if we take equal volumes of the two solutions both containing the same quantity of active chlorine, will the one solution bleach more fiber than the other? A considerable amount of work, both of a theoretical and practical nature, has been done on this question. The general opinion in practice seems to be that the chlorine in the electrolytic liquor has a higher bleaching efficiency than that in the liquor prepared from chloride of lime. Just why this should be it is difficult to say, but the chemical and molecular condition of the chlorine in the two cases may be somewhat different with the result that in the bleaching operation there is less actual loss of chlorine when bleaching with electrolytic liquors.

In the next place, we must consider the difference in the composition and properties of the solutions in the two cases. - A bleaching liquor prepared from chloride of lime is a complicated solution, the exact constituents of which have never yet been satisfactorily determined. It is known, however, to contain a large proportion of calcium hydrate (caustic lime) and calcium chloride, the active chlorine probably existing in combination as calcium hypochlorite. The caustic lime makes the solution rather strongly alkaline, and unless care is exercised in the treatment of fabrics with chloride of lime solutions, spots will be formed consisting of oxycellulose resulting from the action of the caustic lime on the cotton fiber. This causes tendering and yellowing, and is a frequent defect in bleaching.

The electrolytic bleaching liquor contains common salt and sodium hypochlorite, and is a neutral solution. The product of decomposition resulting from the action of the bleaching process is only common salt, so that in this solution there is nothing to act harmfully on the cotton fiber. This is, however, supposing that the electrolysis has been conducted under the proper conditions, and these involve three factors, namely, current density, strength of brine solution and temperature. If these are not in proper adjustment there is danger of sodium chlorate being formed in conjunction with the hypochlorite, and this substance, if accumulated in sufficient quantity, will act injuriously on the fiber.

The proper conditions of operating the cell, however, are now rather thoroughly understood, and under proper supervision there is not much danger of the formation of chlorates in any quantity sufficient to cause injury. We see, then, that in electrolytic bleach liquors practically the only ingredient is eventually sodium chloride (common salt); or if sulphuric acid is employed in the souring of the bleached goods, sodium sulphate will also be present. Both of these substances, however, are neutral, and being highly soluble, are easily removed from the fiber by a slight washing. With the chloride of lime bleaching, however, when sulphuric acid is employed for souring, we have to consider as present the neutral though highly insoluble calcium sulphate and the rather corrosive though highly soluble calcium chloride. The caustic lime originally present during bleaching, of course, is also converted into sulphate by the souring process. The calcium chloride is easily removed by the washing but more or less of the calcium sulphate will remain in the goods, and if the souring is not sufficiently thorough there is a possibility of some caustic lime also remaining, a feature which is especially bad.

there must be a considerable loss of this agent, for all chlorine which escapes from the bleaching liquors or from the fabric when being bleached cannot effect any bleaching action and is a total loss. When using electrolytic bleaching liquors, on the other hand, there is no apparent odor of free chlorine either in the liquors themselves or in the fabric undergoing bleaching, hence it is an indication of very little loss of chlorine during the bleaching process. The bleaching action of electrolytic chlorine is also found to be much more rapid than that in chloride of lime liquors. This also tends to conserve the chlorine from loss, and hence gives it a higher efficiency in bleaching.

Owing to the action of the lime salts in the bleaching, and to the fact that more or less of these salts are left in the finished bleached goods, the bleaching with chloride of lime will give a somewhat harsher feel to the fabric than when electrolytic liquors are used. This seems at least to be the general experience in practice. As a factor in this connection, we must also consider that the latter form of bleaching does not require as severe an acid treatment nor as prolonged a washing.

It might be mentioned that there have been other attempts at the production of electrolytic bleach liquors where solutions other than common salt have been employed. Several years ago the Hermite process was quite prominent experimentally in England and Europe; and there were offshoots from this process. Instead of employing a solution of common salt, solutions of sea water and solutions containing magnesium chloride were used. These cells, however, never seemed to obtain a firm foothold in practice, and cells of a later type seem to have been the most successful.

14. Bleaching Loose Cotton.—Loose cotton is seldom bleached for purposes of spinning, as the bleaching operation considerably deteriorates the spinning qualities of the fiber. This is due to the fact that in the bleaching the waxy matters are removed, and hence the fiber becomes less plastic and coherent, besides being more brittle. Sometimes, however, cotton in the half-spun condition is bleached, and there are mechanical devices available for the proper bleaching of cotton roving and slubbing. A cold method for bleaching loose cotton has been proposed wherein the cotton is first treated in a suitable machine so that cold water is forced through the mass under considerable pressure; then a cold solution of bleaching powder is circulated through the cotton, and subsequently dilute acid, followed by a thorough washing and soaping. This method is said to leave the cotton almost unimpaired as to its spinning qualities. Such a process is attaining considerable practical value for the spinning of filling cops from bleached stock. Loose cotton, however, is largely bleached for use as medicinal *absorbent cotton*. The object in view in this case is not only to obtain a white and pure fiber, but also to make

it highly absorbent of liquids. In fact, the purpose is not so much to bleach the cotton in the sense of destroying the color, as to remove all impurities from the fiber which may in any manner interfere with its ready absorption of liquids. Hence, the chief operation is a very thorough boiling-out to remove perfectly the waxy and resinous matters. For this purpose the cotton is boiled in a comparatively strong solution of caustic soda under pressure for eight to ten hours. After this treatment it is bleached in the usual manner with chloride of lime and sulphuric acid. The quality of absorbent cotton is tested by the readiness with which it sinks in water.

15. Bleaching Cotton Skein Yarn.—In the bleaching of cotton yarn in the form of skeins there are several methods of handling. The yarn is boiled-out in the customary manner in a kier, the closed pressure type being the one mostly used at present. For conducting the chemicking, washing, and souring, however, several methods are available. In small installations the yarn may be placed on ordinary dye sticks and worked by hand in open tubs containing the necessary liquors. Or the yarn may be run in suitable machines where it is rotated through the liquors on a spider frame, being moved and turned mechanically. Or again, it may be packed in a wooden or concrete tank and the liquors are pumped over the skeins and thus kept in circulation; this is known as the "still" method of bleaching. For single yarns of very fine count (such as 100's, 120's, etc.), which will not stand much handling, apparatus has been devised so that all the operations of boiling-out, chemicking, washing, and souring take place in a single kier without moving the goods. Such a kier is lined with lead or tiles so as to withstand the action of the chemic and the acid liquors. The kier is of the closed or pressure type and after the skeins are carefully packed therein the air is sucked out by a vacuum line, the boiling-out liquor admitted, the steam is turned on and the goods are boiled for the requisite length of time. Washing is then carried out, after which proper treatment is given with a chemic of sodium hypochlorite followed by an anti-chlor or acid and finally washing and softening. The admission and evacuation of the liquors are controlled by air suction and pressure, so that the yarn is not disturbed.

16. Bleaching Cotton Warps.—This is a method of bleaching which is quite extensively practiced at the present time, especially in cases where the material is to be used in the warp form for weaving and where the yarn has been mercerized in the warp and is bleached after mercerization. For unmercerized yarn the warps have first to be boiled-out as usual in kiers. In handling the goods the warps are usually doubled or linked up in chains and then run as a long continuous string. After boiling-out the warps are run through a chemic box so as to be padded with the chloride of lime or hypochlorite solution in the same manner as when bleaching

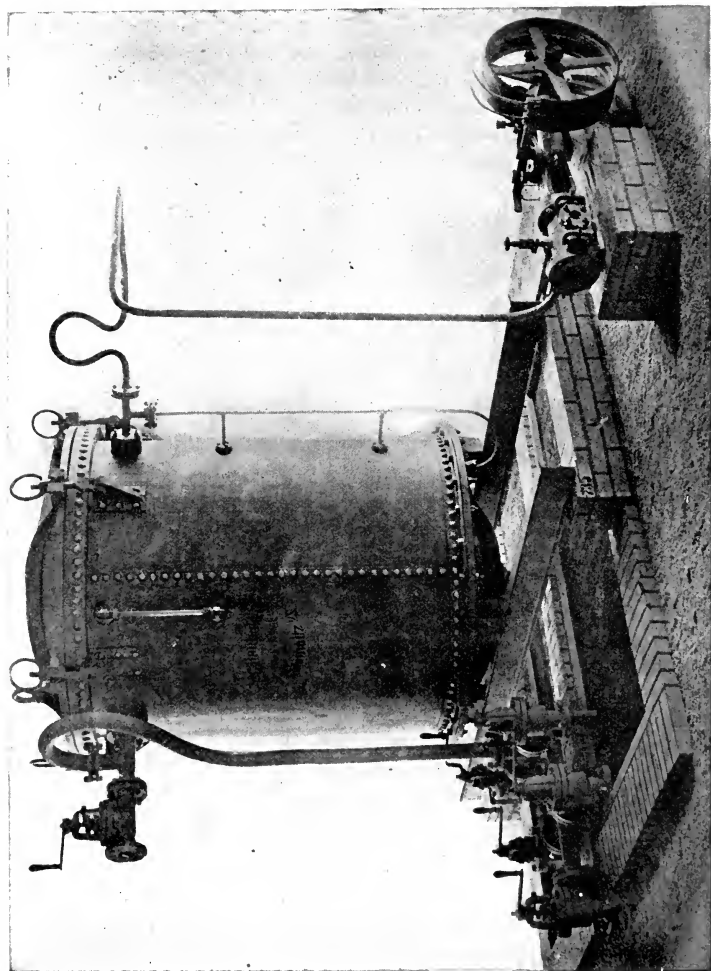

FIG. 114.—Vacuum Bleaching Kier for Fine Yarns.

cloth. The goods are then folded down in bins and allowed to bleach for several hours, after which they are run in string form through tanks with squeeze rolls for treatment with the wash waters and other solutions. Or a still bleach may be given by folding the warps down in a cistern and pumping the bleach and sour liquors over the goods. These liquors percolate down through the yarn, are drawn off at the bottom by the pump, thus maintaining the circulation.

17. Bleaching Knitgoods.—Cotton knitgoods (chiefly used for underwear) are very largely bleached in the piece, or rather in the roll of knitted

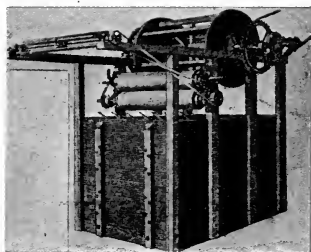

FIG. 115.—Bleaching Machine for Knitgoods in Roll.

cloth, previous to being made up into garments. The gray goods as they come from the knitting machines must first be well boiled-out in a kier, and this is especially true of goods made from carded cotton yarns which contain a considerable amount of motes or seed particles. Like any other form of cotton bleaching the success of the process depends primarily on the proper and complete boiling-out of the goods. In general the method of boiling-out knitgoods is the same as that

for woven cloth or other forms of cotton material.

In regard to the bleaching operation proper (generally known as treatment with chemic), the method of running knitgoods is generally somewhat different from that of woven cloth owing to the knitted structure of the fabric not permitting of much tension on the goods. There are two general methods of handling knitgoods. In the first method the goods are run continuously in a long chain through the liquor, entering the tank at one end and passing spirally up and down over a revolving winch or wooden roller and passing out at the other end of the machine. In this method the cloth is simply padded with the chemic, and as it passes out of the machine it goes through a pair of squeeze rolls for the purpose of removing the superfluous liquor.

After coming from the chemic box thus saturated with the liquor, the goods are folded down in wooden boxes or crates and left exposed to the air and light for several hours, or until the bleaching action has progressed to a satisfactory point. In order to obtain a very even bleach it is well in this process to run the goods over so as to change the position of the materials. The cloth is then run through an acid or an anti-chlor bath. On knitgoods it is probably better to employ anti-chlor, as the

chlorine compounds are more quickly and completely neutralized and there is less danger of acid spots on the goods. The treatment with either anti-chlor or acid is termed the "souring" process, and at this point the bleaching action is finished. A very thorough washing is then necessary in order to remove all trace of the sour or acid. Whichever agent is employed for the souring, acid will be formed in the goods as a part of the reaction, and if this is not completely removed the goods will become tender after a time and turn yellow. Subsequent to the washing process it is usual to give a further treatment with a solution of soap or other softener in which a little bluish violet coloring matter is dissolved for the purpose of tinting.

The second method of handling the goods in the bleaching may be termed the discontinuous method. Instead of running the cloth in one

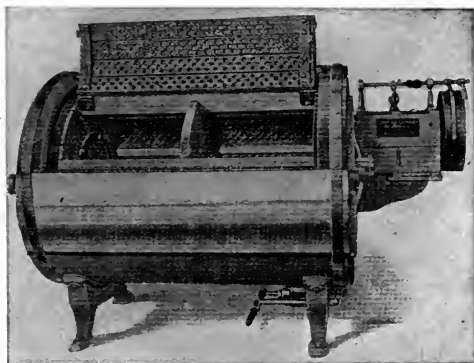

Fig. 116.—Cylinder Washer for Hosiery and Knitgoods.

long chain through the machine continuously, the separate rolls of cloth are treated as units. A string tub machine is used, which consists of an oblong tank over which revolves a large spar roller or winch for the purpose of carrying the cloth. The separate rolls of cloth are strung over this roller and then the ends of each roll are tied together. Suitable prongs are provided in the machine to keep the different rolls apart. In this system the goods are bleached together in the machine, and do not require to be aged in the air while saturated with the chemic as in the other process. All of the processes are carried out in the same machine without removal of the goods. The first bath to be given is the chemic, which consists of a solution of hypochlorite of about 1 to $1\frac{1}{2}^{\circ}$ Tw., and the cloth is run in this solution for one-half to one hour, depending on the degree of bleaching desired. If the cloth is made from low-grade carded yarns

which are very much specked with seed motes, it will be necessary to heat the bleaching liquor to 100° F. towards the end of the run in order to remove the seed particles.

After the treatment with the chemic solution, the latter is run out of the machine, and the goods are then given a good washing with fresh running water for thirty minutes to one hour, depending on the amount of water employed. The treatment with anti-chlor solution is next given, using about 5 per cent of anti-chlor on the weight of the goods. The souring will require about twenty minutes. A thorough washing is again given, after which the goods may be soaped and tinted if desired.

The latter method of treatment is to be preferred to the former or continuous process for several reasons. In the first place, in the continuous process one end of the cloth receives a longer treatment with the chemic than the other end. The first end of the cloth out of the chemic bath remains at the bottom of the boxes and consequently is the last end out of the boxes to go into the washing and souring baths. The difference in time between the passage of the two ends will vary from one-half to one hour, depending on the length of the chain of goods. This introduces a serious element of unevenness in the bleaching which is continually causing trouble in this system of handling. In the second system each portion of the goods receives the same treatment all through, so this factor of unevenness is eliminated. In the second place, the continuous system requires the use of stronger solutions of chemic, which is always an element of danger in the production of streaked goods and over-bleached spots leading to tender and spotted fabrics. Furthermore the fact that the goods remain for such a considerable period saturated with this strong chemic may lead to streaked and tender goods. The lime and chlorine compounds are also more difficult to remove from the cloth, and there is also danger of portions of the goods drying out at the edges and thus leading to the formation of tender parts.

As to the size of the machine required for the treatment, it would be best to obtain a kier of sufficient size to take care of a day's production. The tanks required in the continuous process should be of sufficient size to hold about 500 gallons of water. The tank required for the discontinuous method should hold about 1000 gallons, and should be of sufficient length to be able to run twelve to fourteen rolls of cloth, as this would probably take care of about 500 lbs. of goods at a time.

In addition to the boiling kier and the tanks a hydro-extractor will be required for removing the excess of water from the goods. A drying apparatus will also be necessary, of which there are two forms in general use. In the one the rolls of damp cloth are drawn up over a wire cylinder through which hot air is blown. When the cloth arrives at the upper end it is dry and is rolled up into an even roll in a slightly stretched condition

so as to remove all creases and folds. In the other system of drying the cloth is carried through a drying chamber heated with steam coils and

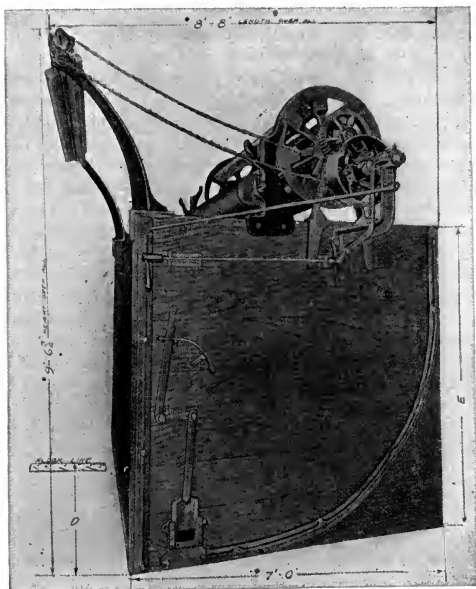

FIG. 117.—Roll Machine for Bleaching Knitgoods.

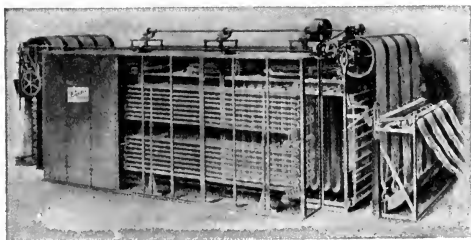

FIG. 118.—Dryer for Knitgoods.

through which air is passed by means of a fan. The goods are folded up and down over rods in the loose state, and on this account it is necessary to smooth out the wrinkles in the cloth afterwards by a special device

of stretching and taking up on a roller. In the case of formed goods in which the cloth is of uneven width throughout its length, the second system of drying is probably the most desirable.

18. Experimental.—Exp. 33. Bleaching Cotton by Means of Tinting.—Take a skein of cotton yarn which has been boiled out in soap and soluble oil, and tint it by working in a bath containing 300 cc. of water and a few drops of Methyl Violet 5B, cold for twenty minutes. Then wash and dry. The small amount of bluish violet coloring matter neutralizes the slight tint of brownish yellow natural to the cotton, with the result that a neutral gray tint is produced; and this latter color is less perceptible to the eye than either the yellow or violet color, consequently the tinted cotton appears to be whiter than the natural fiber. Care must be taken not to give the cotton too pronounced a violet color; it will be found that a very little dyestuff will suffice.

Exp. 34. Bleaching Cotton with Chloride of Lime.—Take a weighed skein of cotton yarn and boil it out in caustic soda as described in Exp. 23. Take another weighed skein and boil it out with soap as described in Exp. 25; also a third weighed skein scoured with Monopol oil as in Exp. 26. Wash these skeins well and steep in a solution of chloride of lime (bleaching powder) of 2° Tw. strength. Work for several minutes until the fiber is thoroughly saturated with the liquor; then immerse in the solution and allow to stand for one hour. Then squeeze and rinse in water, and "sour" by passing for fifteen minutes through a cold bath of sulphuric acid of 1° Tw. strength. Finally wash well in water to remove all trace of acid. Reweigh each skein and calculate the percentage of loss in each case, and compare the bleach obtained with each method of boiling-out. Test the skeins for *acid* by moistening a portion with a little water and pressing against it a piece of blue litmus paper; if the test paper turns red, acid is still present in the fiber, and the washing has been imperfect, with a result that the cotton will soon become tender. To test the bleached cotton for traces of *chlorine* which may remain after bleaching, take a portion of the skein and warm with a small amount of potassium iodide-starch solution; if a blue color is developed, there is still chlorine in the fiber. The test solution may be prepared by dissolving a little starch paste (made by boiling up some starch with water to a paste) in a solution of potassium iodide.

Exp. 35. Use of "Anti-chlor" for Removing Chlorine in Bleaching.—Take a skein of cotton yarn which has been boiled-out in caustic soda in the usual manner, and bleach it for one hour in a cold solution of chloride of lime at 2° Tw., then wash in water. On a portion of the skein place a drop or two of the potassium iodide-starch solution, and it will be found that a blue color is developed, showing the presence of chlorine. Now pass the skein through a bath containing a little sulphuric acid for a few minutes and wash again. Test with the potassium iodide-starch solution again, and it will still be found that free chlorine is present. Prepare a bath containing 300 cc. of water and 1 gram of sodium thiosulphate (sodium hyposulphite) and pass the skein through this solution cold for ten minutes. Wash, and again test with the potassium iodide-starch solution, when it will be found that the free chlorine has been neutralized. The sodium hyposulphite is called "anti-chlor" when used for this purpose; sodium bisulphite will also answer the same purpose.

Exp. 36. Bleaching Loose Cotton for Absorbent Purposes.—Weigh out 10 grams of loose cotton and boil for one hour in a bath containing 300 cc. of water and 5 grams of caustic soda. Rinse off well in fresh water and bleach in a cold solution of chloride of lime at 2° Tw. for one hour. Rinse, and pass through a cold solution of sulphuric acid at 1° Tw. for twenty minutes. Then wash well in several changes of water until all acid is removed. Then squeeze and dry. Reweigh the sample and calculate the percentage of loss. Test the bleached cotton for absorbent qualities by placing a small bit

of it on the surface of cold water; if it is perfectly absorbent, it should sink at once. Try a small piece of raw cotton in the same manner, and it will be found that the latter does not sink at all.

Exp. 37. Tinting and Softening of Bleached Cotton.—Boil-out four skeins of cotton yarn in caustic soda in the usual manner; wash well in water, and bleach for one hour in a cold bath of chloride of lime at 2° Tw. Wash, squeeze, and pass for fifteen minutes through a cold bath of sulphuric acid at 1° Tw. Wash in two changes of water. Then test the skeins with litmus paper, and the chances are that they will still show the presence of acid. Set one of the skeins aside for comparison. Take another one of the skeins and work for fifteen minutes in a bath containing 300 cc. of water, 1 gram of soap, and $\frac{1}{100}$ per cent of Methyl Violet 5 B; have the temperature at about 140° F. Then squeeze and dry. Take a third skein and treat in the same soap bath, but add $\frac{1}{100}$ per cent of the coloring matter; squeeze and dry. Take the fourth skein and treat in

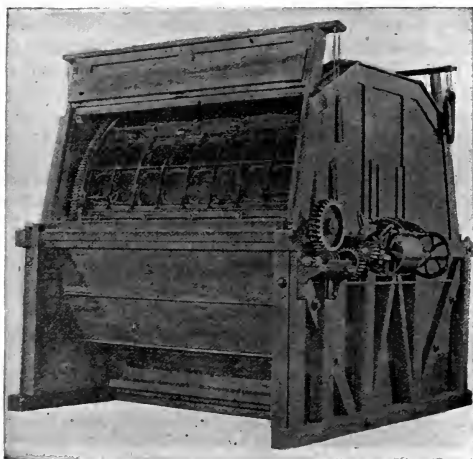

FIG. 119.—Raw Stock Bleaching Machine. (Delahunty Dyeing Machine Co.)

the same manner with the soap solution, but add $\frac{1}{50}$ per cent of the dyestuff; squeeze and dry. The percentages of the dyestuff are to be calculated on the weight of the cotton tinted. That is, $\frac{1}{100}$ per cent on 10 grams of cotton would be 0.0005 gram. The solutions provided should contain 0.1 gram of dyestuff per liter (1000 cc.); hence 1 cc. would represent 0.0001 gram of dyestuff, and it would require 5 cc. to give the necessary $\frac{1}{100}$ per cent, or 10 cc. for $\frac{1}{50}$ per cent, or 20 cc. for $\frac{1}{25}$ per cent. After the several skeins have dried, compare the feel or softness of the first with that of the others which have been treated with the soap bath. Also compare the degrees of tinting of the latter three skeins and the difference in the character of the white obtained in each case.

Exp. 38. Use of Acetic Acid in Bleaching.—Boil out a skein of cotton yarn with caustic soda in the usual manner and bleach for one hour in a cold solution of chloride of lime at 2° Tw. containing also a little acetic acid. Then wash well in fresh water and pass through the dilute soap bath as described above. It will be noticed that some chlorine is given off in the bleach bath containing the acetic acid, but the bleaching does

not require the after use of an acid, from which there is always danger of tendering the fiber.

Exp. 39. Use of Lime Boil in Bleaching Cotton.—Prepare a solution of lime-water by slaking 10 grams of quicklime (oxide of calcium, CaO) with a small quantity of water, and then diluting to 300 cc. Boil a weighed skein of cotton yarn in this bath for one hour, then wash and pass through a cold bath containing 300 cc. of water and 3 cc. of concentrated hydrochloric acid; work for fifteen minutes. Wash and bleach for one hour in a cold solution of chloride of lime at 2° Tw. Wash, and pass back through the cold acid bath for fifteen minutes. Then wash well and soap as usual in a dilute warm soap bath. Wash and dry. Reweigh and calculate the percentage of loss. Compare this method of bleaching with the previous ones. The first treatment with acid is required in order to dissolve out any lime compounds formed in the fiber, which would otherwise remain and tender the cotton, and also not allow the chloride of lime to act as perfectly as it should.

Exp. 40. Use of Sodium Hypochlorite.—Prepare a bath containing sodium hypochlorite solution of 1° Tw. In this cold bath steep for one hour a skein of cotton yarn previously boiled-out with caustic soda. Wash and pass through a cold bath of sulphuric acid at 1° Tw. for fifteen minutes. Then wash well and soap as usual. Sodium hypochlorite is prepared by adding a solution of soda ash to one of chloride of lime, allowing the precipitate of calcium carbonate to settle and drawing off the clear liquor. It is more efficient as a bleaching agent than chloride of lime, and is also less liable to cause tendering of the fiber. It is more expensive, however, than chloride of lime.

Exp. 41. Comparison of the Use of Sulphuric and Hydrochloric Acids in Bleaching Cotton.—Take two skeins of cotton yarn which have been boiled-out with caustic soda and bleach them in the usual manner with chloride of lime solution at 2° Tw. Without washing, take one of the skeins and pass through a bath containing 300 cc. of water and 3 cc. of hydrochloric acid cold for fifteen minutes, then wash well and dry. Take the other skein and treat in a similar manner with a solution of 2 cc. of sulphuric acid in 300 cc. of water; wash well and dry. Notice that in the bath containing the hydrochloric acid there is no precipitate formed, as the lime compound with this acid is soluble in water; whereas in the sulphuric acid bath a precipitate of calcium sulphate is formed which will remain to a greater or lesser extent in the cotton.

Exp. 42. Use of Sodium Peroxide for Bleaching Cotton.—Prepare a bath containing 400 cc. of water and 3 cc. of concentrated sulphuric acid; have this solution cold and then carefully add with constant stirring 4 grams of sodium peroxide.* After all of the

* Sodium perborate has also been brought forward as a bleaching agent, more especially for use in laundries. It is a substance somewhat similar in its bleaching effect to sodium peroxide. It is more expensive, however, than sodium peroxide, and furthermore, only contains 10.4 per cent of active oxygen as compared with about 20 per cent in sodium peroxide. Sodium perborate, however, is more stable than the peroxide, and it was principally on this account that it attracted attention for purposes of bleaching. Sodium peroxide decomposes with violent rapidity when dissolved in cold water; whereas sodium perborate requires to be dissolved in hot water, and the resulting products are hydrogen peroxide, caustic soda, and borax. On this account, the bleaching bath can be employed at an elevated temperature. Sodium perborate has been particularly put forward as a bleaching agent for laundries, and a number of proprietary mixtures have been put on the market which combine scouring and bleaching properties. *Persil* is a mixture of soap, soda ash, sodium silicate and a small amount of sodium perborate. *Clarax* is a mixture of borax, sodium phosphate and sodium perborate; *Ozonite* is a mixture similar to *Persil* containing the ingredients in a somewhat different proportion. *Perborin* is pure sodium perborate, while *Perborin M* is a mixture of *Perborin* with soap and alkali.

latter has been added test the solution with a strip of blue litmus paper. If the bath is acid in reaction, the paper will turn red, but if not add a few more drops of acid until the bath does show a slightly acid reaction. This insures the fact that all of the caustic alkali produced by the solution of the sodium peroxide in water, has been neutralized. Then add a few drops of sodium phosphate solution until the test paper shows that the bath is slightly alkaline in reaction. This is done because the bath bleaches more efficiently when somewhat alkaline. Heat the bath to 120° F., and work in it a skein of cotton yarn which has been boiled-off in caustic soda. After working for about ten minutes so as to thoroughly impregnate the fiber with the liquid, immerse the skein beneath the solution and allow it to stay for twenty-four hours. Then remove the skein, wash well in fresh water, and finally soap in a dilute bath containing a little Methyl Violet for tinting in the usual manner. Compare this bleach with that obtained by the use of chloride of lime.

Exp. 43. Showing the Influence of Iron in the Bleaching Bath with Sodium Peroxide.—Prepare a bleaching bath as above described with sulphuric acid and sodium peroxide, but add to it a small quantity of iron (such as a small tack, etc.). Carry out the bleaching of a skein of cotton yarn in exactly the same manner as before, and after finishing all of the operations, notice the effect of the presence of the iron on the character of the bleach.

Exp. 44. Bleaching Cotton with Potassium Permanganate.—Prepare a bath containing 400 cc. of water and 2 cc. of concentrated sulphuric acid. Work a skein of cotton yarn which has been boiled-out with caustic soda in the usual manner in this bath cold for ten minutes; then add 5 cc. of potassium permanganate solution (containing 50 grams per liter) and work cold for twenty minutes longer. Then wash in fresh water, when it will be noticed that the cotton has become brown in color, due to the hydrate of manganese which has been precipitated in the fiber. Now pass the skein through a bath containing 400 cc. of water and 5 cc. of sodium bisulphite solution (containing 50 grams per liter); work cold for twenty minutes, or until the cotton is white. The sodium bisulphite reduces and dissolves the manganese hydrate from the cotton and leaves the bleached fiber. Finally wash well and dry. Compare the quality of this bleach with the other methods,

CHAPTER V

CLASSIFICATION OF DYES

1. General Classification of Dyestuffs.—With respect to their general properties nearly all coloring matters may be divided into six general classes, as follows:

- | | |
|-----------------------|-------------------|
| (a) Acid Dyes. | (d) Mordant Dyes. |
| (b) Basic Dyes. | (e) Sulphur Dyes. |
| (c) Substantive Dyes. | (f) Vat Dyes. |

This classification in a general way is based on the chemical nature of the dyestuff and its reaction towards the fiber. The following is a brief summary of these properties:

(a) *Acid Dyes.* Salts of color-acids; dye animal fibers directly; do not dye vegetable fibers; mostly applied to wool and silk.*

(b) *Basic Dyes.* Salts of color-bases; dye animal fibers directly; dye vegetable fibers on a tannin mordant; mostly applied to cotton and silk.

(c) *Substantive Dyes.* Of neutral chemical nature; dye both animal and vegetable fibers directly; mostly applied to cotton and somewhat to both wool and silk.

(d) *Mordant Dyes.* Of neutral chemical nature; dye neither animal nor vegetable fibers directly, but require a metallic mordant; mostly applied to wool.

(e) *Sulphur Dyes.* Soluble in sodium sulphide; used exclusively for vegetable fibers, which they dye directly.

(f) *Vat Dyes.* Soluble in sodium hydrosulphite; dye both animal and vegetable fibers directly; used mostly on cotton and to some extent on wool; characterized by great fastness.

The great majority of the dyestuffs used at the present time are derived from coal-tar products, the vegetable dyes, with few exceptions, being almost obsolete.

* According to Knecht, the distinction of the acid dyes as a separate group is based on practical requirements rather than on strictly scientific principles. On the one hand there is no sharp line of demarcation between them and the direct cotton colors, and on the other hand, the acid colors, acid chrome colors, and mordant colors are frequently related to each other, a number of dyes belonging practically to two of these groups or even to all of them, as is, for instance, the case with Cotton Yellow G. A few like the Soluble Blues, can also be dyed like the basic colors. The common characteristic of the acid dyes is that they are dyed on wool and silk in an acid bath and that they can be mixed with each other to produce compound shades.

- (a) *Acid Dyes*. Mostly derived from azo compounds of benzene and toluene.
- (b) *Basic Dyes*. Mostly derived from aniline and its homologues.
- (c) *Substantive Dyes*. Mostly derived from benzidine and tolidine.
- (d) *Mordant Dyes*. Mostly derived from anthracene.
- (e) *Sulphur Dyes*. Derived from various organic products by fusion with sulphur and sodium sulphide.
- (f) *Vat Dyes*. Derived principally from anthracene and carbazol, including also some derivatives of indigo.

Previous to the discovery of the coal-tar dyes, the coloring matters employed were of either vegetable or mineral origin.

- (a) *Vegetable Dyes*. Logwood, Indigo, Fustic, Hypernic, Cochineal, Madder, Cutch, Camwood, Brazil-wood, Archil, Quercitron, Safflower, Persian Berries, etc.
- (b) *Mineral Dyes*. Iron Black, Iron Buff, Manganese Bistre, Chrome Yellow, Prussian Blue, etc.

The first coal-tar dyestuff was discovered in 1856 by Perkin; it was known as Mauve, and was soon followed by other aniline dyes. It is wrong, however, to apply the term "aniline" colors to all coal-tar dyes, as there are now many which are not derived from aniline.

For the same amount of actual coloring matter the coal-tar dyes are in general much cheaper than the vegetable colors; they have also far greater intensity of color, are much brighter, and in many cases are faster.

Based on their general methods of application, we may classify practically all of the dyes used at the present time into the following groups:

- (a) *Acid dyes*, such as Acid Violet, Naphthol Yellow, etc.
- (b) *Basic dyes*, such as Magenta, Methylene Blue, etc.
- (c) *Mordant dyes*, such as Alizarine Red, Gallocyanine, etc., and most of the vegetable dyes.
- (d) *After-chromed dyes*, such as Chromotrope, Diamond Black, etc.
- (e) *Substantive dyes*, such as Benzopurpurine, Chrysophenine, etc.
- (f) *Developed dyes*, such as Diamine Black BH, Primuline, etc.
- (g) *Naphthol dyes*, such as Paranitraniline Red, etc.
- (h) *Coupled dyes*, such as Benzo Nitrol Brown, etc.
- (i) *Sulphur dyes*, such as Sulphur Black, Sulphur Blue, etc.
- (j) *Vat dyes*, such as Indigo, Indanthrene Blue, etc.
- (k) *Oxidized dyes*, such as Aniline Black.
- (l) *Mineral pigment dyes*, such as Chrome Yellow, Prussian Blue, etc.

The most important of these classes, and those containing the greatest number and the most diversified colors, are the six groups mentioned in the first paragraph of this section.*

* There is also a group of dyes known as *spirit colors*, which are insoluble in water and require to be dissolved in wood alcohol, acetin, etc. They are used to some extent in the dyeing of silk and as printing colors, but their principal use is for the coloring of varnishes, etc.

The *acid dyes* are principally used for the dyeing of wool and silk, and only to a limited extent for the dyeing of cotton or other vegetable fibers.* They are applied to the animal fibers in baths containing either sulphuric acid or acetic acid.

The *basic dyes* are used chiefly for the dyeing of cotton and silk; only a few members of this group are used in wool-dyeing. They are applied to the animal fibers directly from neutral baths.† For cotton, or other

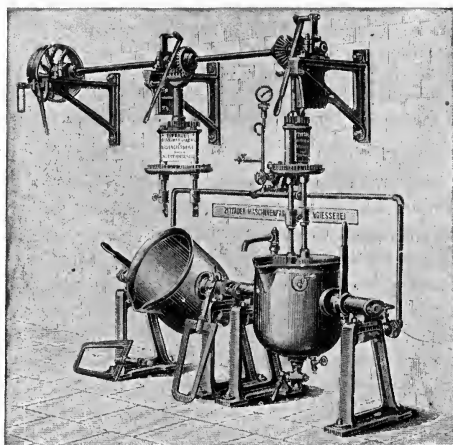

FIG. 120.—Kettles for Dissolving Dyes, Extracts, and Finishing Materials.

vegetable fibers, a mordant of an acid character (such as tannic acid) is required.

* The acid dyes are of considerable importance for the dyeing of jute, as this fiber differs noticeably from most of the other vegetable fibers in its chemical composition. Instead of consisting of more or less pure cellulose, it is composed of an alteration product of cellulose known as ligno-cellulose, and the latter possesses the property of combining directly with the acid dyes. Jute also combines directly with the basic dyes without the intervention of a tannin mordant, as is required by cotton.

† A separate group of dyestuffs is frequently made of the *eosin* or *phthalein* dyes. This group includes certain of both the acid and basic dyes, which are what might be termed "neutral" dyes. They comprise the eosins, erythrosins, phloxines, rose bengals, and rhodamines. They are applied in neutral or slightly acid baths, and are largely used for the dyeing of silk, though to a certain extent also for wool and cotton. All these dyes are pink in color and are characterized by great brilliance and fluorescence. The rhodamines in reality belong to the basic group, whereas the others are acid dyes.

The *mordant dyes* are almost exclusively used for the dyeing of wool, with the exception of Alizarine Red, which is also largely used for the dyeing of cotton (for Turkey Red). These dyes do not have a direct affinity for any of the fibers, and require the use of a metallic mordant (usually potassium bichromate) in their application.

The *after-chromed dyes* are very similar to the mordant dyes in their general characteristics, but the mordant is applied after the dyeing. These colors are used exclusively on wool and have a direct affinity for this fiber, though the color so obtained, as a rule, has little value. The after-chroming process usually alters this color considerably and gives it fastness.

The *substantive dyes* are so called because they have a direct affinity for all fibers. They are primarily cotton dyes, though they are also used to some extent on wool and silk. They are applied in neutral baths.

The *developed dyes* are used almost exclusively on cotton, though a few are also applicable to silk. They are first dyed in a manner similar to the substantive colors in a neutral solution; the dyed material is then treated with a solution of nitrous acid (obtained by the addition of acid to a solution of sodium nitrite)—a process known as *diazotizing*,—and afterwards with a solution of beta-naphthol (or other similar body), which is known as the *developer*, and from which this class of dyes receives its name. By these operations a new dyestuff is built up in the fiber.

The *naphthol dyes* are somewhat similar in general to the preceding group, only the order of the operations is reversed. The material to be dyed is first treated with a solution of beta-naphthol (or other similar developer), and then with a solution of a diazotized base representing the dyestuff. In this manner a dyestuff is actually made in the fiber. These dyes are but few in number and are applied only to cotton.

The *coupled dyes* are another similar group, the material being first dyed with a substantive color and then treated with a solution of diazotized paranitraniline; this resulting in the formation of a new dyestuff in the fiber. Such dyes are applicable only to cotton and are quite limited in number and range of color.

The *sulphur dyes* are also applied almost exclusively to cotton, though in certain cases they may also be used on silk. They are dyed with the aid of sodium sulphide which is added to the dyebath, and the dyestuff apparently contains sulphur compounds in its composition. In other respects they are very similar to the substantive dyes.

The *vat dyes* form a small group of colors employed on all the fibers. The dyestuffs themselves are insoluble and require to be first reduced by means of a strong reducing agent (such as sodium hydrosulphite or other suitable substance) and dissolved in an alkaline liquor. This combination forms the so-called "vat." Indigo is the chief representative of this

group, though other dyes of a similar character have lately been added, such as the indanthrene, helindone, and algol colors, as well as the thio-indigo colors.

The group of *oxidized dyes* is practically limited to only one member known as Aniline Black. This dye, which is extensively used, is formed by the proper oxidation of aniline directly in the fiber. It is used principally on cotton and to a lesser extent on silk.

The *mineral pigment dyes* are colored compounds of the metals formed by the precipitation in the fiber of suitable metallic salts, such as Chrome Yellow formed by precipitation of lead acetate in the fiber with potassium bichromate. These dyes are almost entirely used for dyeing cotton; some

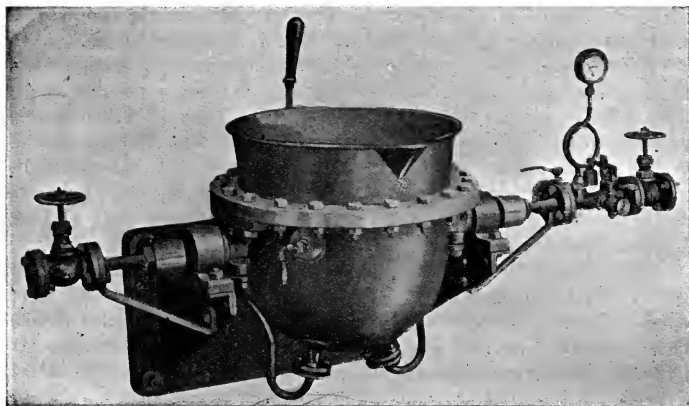

FIG. 121.—Modern Type of Kettle for Preparing Solutions for Dyeing.

were formerly used for dyeing wool and silk, but this application of them is now almost entirely discontinued.

2. Action of Dyestuffs on the Textile Fibers.—The various classes of dyestuffs, as already indicated above, react quite differently with the several textile fibers. Though there is considerable similarity in their reaction with wool and silk, as constituting the general class of animal fibers, still even here there are points of difference to be observed in the dyeing properties of these two fibers. The greatest differences, however, are to be noticed between the animal fibers on the one hand and cotton (and the vegetable fibers in general) on the other hand. The methods of dyeing and the particular dyestuffs employed which are suitable for one fiber may be totally inappropriate for the other fiber; therefore in an intelligent

understanding of the process of dyeing, it is necessary both to be able properly to classify the dyestuff and also to be well acquainted with the difference in the behavior of these groups of dyes on the various fibers or materials to be dyed.

Although there is no doubt a certain degree of chemical reactivity to be considered as existing between the fiber and the dyestuff in the dyeing process, as far as the practical dyeing is concerned we have chiefly to consider the physical distribution of the coloring matter through the substance of the fiber. In a true dyeing operation the color is not simply deposited on the surface of the fiber, but saturates or penetrates it throughout. If a cross-section of a dyed fiber is examined microscopically, it will be found that the color extends through the interior, and with but few exceptions (what might be called *pigment* dyes) there is no apparent separation of dyestuff particles from the general substance of the fiber. This saturation of the color through the fiber is generally somewhat gradual, and for complete penetration usually requires a rather prolonged boiling or steeping in the dyebath. Just what causes the combination of the dyestuff with the fiber, and in what form this combination exists, is not definitely known, though a discussion of these points will be considered under the theory of dyeing.

3. Action of Dyestuffs on Wool.—Wool is to be considered as the most reactive of all the fibers towards dyestuffs.* Practically all the different classes of dyestuffs will combine with wool; although in certain cases it may not be practical to use on this fiber the methods of dyeing required for some of the groups of dyes. Sulphur dyes, for example, are not applicable to wool because the process of dyeing requires the use of a strongly caustic alkaline bath (sodium sulphide) which would destroy the wool. Also with some other groups, such as the developed, the naphthol and the coupled dyes, either dyebaths injurious to the wool are employed, or the

* Wool has a greater affinity for dyestuffs than has any other textile material. Being an animal fiber it combines directly with acid, basic, and substantive colors. The active constituent in wool which is supposed to take part in the dyeing process is "keratine," and this is apparently a very reactive chemical body. The wool fiber is a colloidal substance, and no doubt forms with most coloring matters a "solid solution." Its chemical composition, however, apparently plays an important rôle in the application of certain classes of dyestuffs, such as the acid and basic dyes. The affinity of wool for most dyes is much greater at a boiling temperature than in the cold; hence the dyeing of wool nearly always takes place in a solution at or near the boiling point. This condition, however, will depend somewhat on the character of the dyestuff employed; the phthalein dyes, for instance (including the eosins and rhodamines) are usually applied at a temperature of about 140 to 150° F., and many acid dyes at a temperature of 180 to 190° F.; whereas the most of the mordant dyes require the bath to be at the boiling temperature for their proper fixation.

Many of the basic dyes, on the other hand, will combine rather easily with wool even in cold baths.

color may be produced in a much more satisfactory manner with other dyes more readily applicable to this fiber.

Owing to the close similarity in the chemical natures of wool and silk, these two fibers exhibit much the same properties in their affinities towards dyestuffs. One of the chief differences, however, between the two fibers in this respect is in the proper temperature of dyeing. In the case of silk the dyestuff appears to combine more readily with the fiber at lower temperatures (about 140 to 160° F.) while with wool the dyeing takes place better at higher temperatures (200 to 212° F., or practically at the boil). In practice, wool is usually dyed in a boiling bath, although actual boiling is not absolutely necessary except in certain cases of very thick goods or hard coarse wools.*

The general relation of wool to the various groups of dyestuffs is as follows:

The *basic dyes* are applied to wool directly in a hot water solution without necessarily any further addition to the bath; good examples of such dyes are Magenta (Fuchsine), Methyl Violet, and Auramine. All of the basic dyes, however, do not react in precisely the same manner with wool, this being somewhat dependent on the chemical nature of the particular dye in question. Some of the basic azo dyes, for example, show a greater affinity for wool when alum is present in the dyebath, as is illustrated by the case of Bismarck Brown. Some of the diphenyl-naphthyl basic dyes, like Victoria Blue, exhibit better dyeing properties towards wool when acid is added to the dyebath.

The group of *acid dyes* is to be considered, *par excellence*, the one most suitable for wool dyeing. Most of the acid dyes show more or less affinity for wool even in a neutral Glaubersalt bath, and certain members of this group may be practically dyed in that manner. Generally speaking, however, the full affinity of the acid dyes for wool is only developed by the proper addition of acid to the bath. Sulphuric or acetic acid is usually employed for this purpose. The application of the acid dyes to wool is a very simple process and usually proceeds without any special difficulties, which accounts for the great popularity of these colors for the dyeing of all manner of woolen materials.

Among the *substantive dyes* a number give very good colors on wool, showing quite a strong affinity for the fiber in a neutral bath, though usually the dyeing takes place better in a bath slightly acidulated with

* Some dyers consider that it is necessary to boil the wool hard in order to dye it perfectly. With but few exceptions, however, this does not appear to be generally necessary. Most dyes belonging to the acid, basic, and substantive classes require a temperature only up to about 195° F., and even some of the mordant dyes may be satisfactorily dyed at this temperature. It may also be remarked in this connection that fine woolen and worsted yarns of such a character as to be easily felted and tangled, should never be vigorously boiled in the dyeing.

acetic acid. Others show but little or no affinity for wool, and are consequently not applicable to this fiber; they belong mostly to the azoxy dyes, such as Mikado Yellow. A relatively small group of the substan-



FIG. 122.—Autoclave (Pressure Kettle) for Preparing Dyewood Solutions.

tive dyes known as the sulphon colors, is especially adapted to the dyeing of wool, being applied in a neutral or slightly acid bath. There is usually a considerable difference in the affinity of the substantive dyes for wool and cotton in the temperature of dyeing. As a rule, wool takes up the

dyestuff better at a temperature at or near the boil, while the color feeds on the cotton better at a lower temperature.

The true *mordant dyes* (alizarines) have but little affinity for unmordanted wool. Some of the sulphonated soluble alizarines will exhibit a certain degree of dyeing properties, though the colors are generally useless with respect to fastness. Towards suitably mordanted wool (prepared with metallic bases such as those of chromium, aluminium, iron, copper, tin, etc.), however, the mordant dyes exhibit a strong attraction, so strong in fact, at high temperatures that uneven shades will generally be the result unless the dyeing process is started at a comparatively low temperature (100 to 140° F.). The reaction in this case, however, is more between the dyestuff and the metallic mordant than between the dyestuff and the fiber itself. The mordant dyes are largely used on wool for the production of fast colors. Most of the vegetable dyes are mordant colors, and the entire group forms the so-called *adjective* dyes of the old classification.

The behavior of the *after-chromed dyes* towards wool is somewhat analogous to that of the mordant dyes in that a suitably fast color-lake is only formed after a mordanting operation. On the other hand, however, the after-chromed dyes are more analogous to the acid dyes in that they combine directly with wool from an acid bath, though the color obtained in this manner may have unsatisfactory fastness. This class of dyes has become a very favorite one for use on wool for the production of fast colors, as usually the dyeing operation is simpler and cheaper than with the true mordant dyes. Some of the after-chromed dyes are chemically analogous to the alizarines, being derivatives of anthracene, and it is probably that with these the after-chroming is a true mordanting operation and the dyestuff combines with the metallic base to form a color-lake. Other of the after-chromed dyes, however, are azo dyes and they are chemically very different from the true mordant dyes. It is probable that in such cases (as with Chromotrope, Diamond Black, Alizarine Yellow G, etc.), the chroming acts as an oxidizing reaction, though apparently the metallic mordant base also takes part in the fixation of the color.

The *vat dyes*, of which Indigo is a good representative, are insoluble in water and require an alkaline reduction to form a dye-bath or "vat." Indigo is extensively used for dyeing wool and some of the other vat dyes are also applied to wool to a limited extent, though they are not used to the same degree as on cotton. It cannot be said that there is a direct affinity of the dyestuff for the wool, for as a matter of fact the fiber is only impregnated with the solution of the reduced dyestuff (leuco compound) by capillary attraction, and the coloring matter is subsequently precipitated within the fiber in an insoluble condition by oxidation in the air.

Owing to the highly insoluble character and the stable nature of these precipitated dyestuffs, the colors so produced as a rule are exceedingly fast.

4. Action of Dyestuffs on Silk.—Silk is only second to wool in its general reactivity towards dyestuffs, and owing to its similar chemical nature (being a proteoid of an amino-acid character like wool) it resembles wool in exhibiting both acid and basic qualities. In the dyeing of boiled-off silk some difference is to be observed from that of soupled silk. The latter is still coated with a considerable layer of sericin or silk-gum, and when dyed most of the color is to be found in the sericin layer.

With the *basic dyes* silk combines very readily, and these colors may be applied in a neutral bath; usually, however, boiled-off liquor is added as this causes a more uniform absorption of the color. The basic dyes,

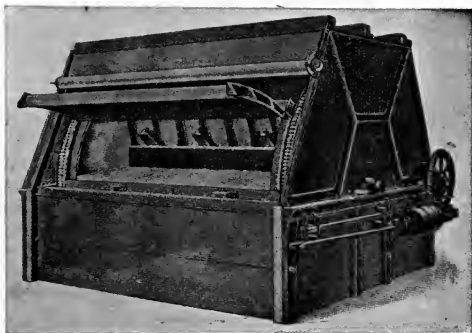

FIG. 123.—Raw Stock Dyeing Machine. (Klauder-Weldon Dyeing Machine Co.)

as a rule, feed on the silk better at a temperature of about 160 to 180° F., for when boiled or subjected to too prolonged a heating some of the color will be stripped from the fiber. Also at high temperatures the color is liable to be uneven as well as superficially deposited. Frequently acetic acid is added to the bath in dyeing basic colors, as this promotes evenness and penetration. The basic dyes are extensively used on silk goods on account of their intense and brilliant colors.

The *acid dyes* also show a strong affinity for silk, many of them dyeing this fiber even from a neutral solution, though better results are usually obtained by employing a bath acidified with either sulphuric or acetic acid.* Most of the acid dyes may be applied to silk at temperatures considerably

* The combination of the acid colors with silk is not as strong as with wool; apparently the basic properties of the silk fiber are too weak to furnish a stable combination with the color-acid. On this account few of the acid dyes can be fixed on silk fast to washing.

below the boil; in fact if too high a temperature is used uneven colors will result. As with the basic dyes, it is customary to make an addition of boiled-off liquor to the bath in order to even up the colors.

Silk may also be dyed satisfactorily with many of the *substantive dyes*, though most of these do not react as well with silk as they do with wool and cotton, and in some cases the color is not taken up at all. The dyeing may be carried out in a neutral bath, though better results are usually obtained if some acetic acid is added. A moderate temperature of about 160 to 180° F. is used.

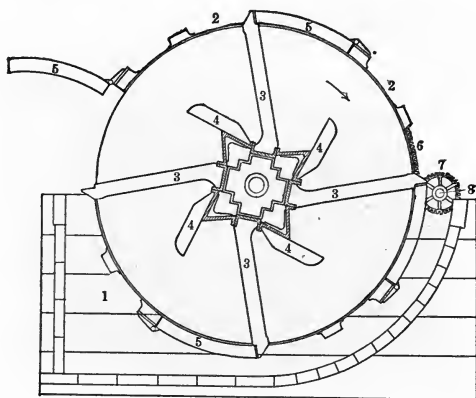

FIG. 124.—Sectional View through the Klauder-Weldon Raw Stock Dyeing Machine.

The *mordant dyes* have but slight affinity for the plain silk fiber, but when previously prepared with a metallic mordant the silk will become dyed. The mordant dyes, however, are rarely used on silk, with the single exception of Logwood, which is extensively used for dyeing black. As with the case of wool, the dyeing of silk with the mordant dyes is rather a combination of the dyestuff with the mordant than with the fiber.

The *vat dyes* may also be applied to silk using a vat similar to that employed for wool. These dyes possess more of the property of pigments precipitated within the fiber, and there is no real combination of the dyestuff with the silk. The other classes of dyestuffs are rarely, if ever, used on silk.

5. Action of Dyestuffs on Cotton.—Unlike the animal fibers cotton is quite inert towards most dyestuffs with the exception of the substantive or

direct cotton colors. As the substance of the cotton fiber is cellulose and not a proteoid, this material is chemically very inactive so that it combines with neither the basic nor the acid dyes. The same is also true with respect to its affinity for metallic salts or mordants.

With the *basic dyes* cotton shows no affinity and can only be dyed with these colors by first preparing the fiber with a tannin mordant.* Bleached cotton shows a slightly greater attraction for basic dyes than raw cotton, and this becomes considerably increased if the cotton has been over-oxidized in the bleaching. Mercerized cotton is also somewhat more reactive with basic colors than ordinary cotton.

The *acid dyes* are also not reactive with cotton, but when applied to the fiber in connection with an alum mordant may be used for a loose form of coloring which possesses but slight stability towards washing.† By impregnating the cotton with a solution of albumin (so-called "animalized" cotton) the fiber may be dyed rather satisfactorily with many acid dyes; in this case, however, it is really the albumin which is dyed rather than the cotton itself.

Towards the *substantive dyes* cotton has a strong affinity which permits of the ready dyeing of this fiber with these colors. It is doubtful, however, if this reaction is due to any chemical activity between the fiber and the dyestuff, but is rather a colloidal combination of the two. The substantive dye, however, is apparently not fixed in an insoluble condition in the fiber, as steeping in water will nearly always continuously remove some of the color. The developed, naphthol, and coupled dyes all practically belong to the general class of substantive dyes, the only difference being that they are built up directly in the fiber. As they are mostly insoluble substances the colors they furnish are much faster as a rule than the other substantive dyes.

The *sulphur dyes* are also substantive in character in that they combine directly with the cotton. They are chemically different, however, from the other direct cotton colors; and being insoluble in water, also yield much faster dyeings.

Towards the *mordant* and *after-chromed dyes* cotton is very inert, and owing to the fact that the fiber is also quite inactive with solutions of metallic salts there is considerable difficulty in applying a mordant, so with the single exception of Turkey Red (dyed with Alizarine) these dyes are practically never employed on cotton.

The *vat dyes* apparently react with cotton merely by a saturation of

* Exception must apparently be made in the case of Victoria Blue B, which dyes unmordanted cotton a full shade from a bath containing acetic acid.

† Even the color-lake of the acid dye with the alum in this case, seems to be decomposed by water and the color removed. The Soluble Blues are faster to washing.

the fiber with the solution of the reduced dye, and a subsequent precipitation of the pigment therein. Owing to the extremely insoluble character of these dyes the colors they produce are very fast, and on this account they have an extensive use in cotton dyeing.

In the case of the *natural dyes* these all belong to the mordant class with respect to cotton, with the exception of Curcuma and Safflower, which may be dyed directly on cotton in a manner similar to the substantive dyes. With *Aniline Black* and the *mineral dyes* their relation to cotton may be considered simply as the precipitation of an insoluble pigment within the fiber.

6. The Use of Mordants.—It has been seen that certain dyes (such as the alizarine and anthracene series) do not form stable combinations with the fibers. If wool, for example, is boiled in a solution of Alizarine Red, in a certain sense it will become dyed, but the color may easily be washed from the fiber. In other words, though the dyestuff is soluble in the fiber, the color-lake does not become "fixed." These dyes, however, form very permanent color-lakes with many metallic oxides, such as those of aluminium, chromium, iron, etc.* Furthermore, wool (and silk also) has the property of dissolving and fixing these metallic salts much in the same manner, for instance, as basic dyes are taken up by the fiber. Therefore if the animal fibers are first boiled in a solution of such metallic salt a certain quantity of the metallic oxide becomes dissolved and fixed in the substance of the wool (or silk), and the fiber so prepared can then be dyed a permanent color with the alizarine (or other mordant) dyestuffs. Cotton (and the vegetable fibers in general) does not have the property of dissolving and fixing these metallic salts (or mordants) to any extent; hence this method of mordanting and dyeing is not readily applicable to the vegetable fibers. The vegetable fibers do, however, possess the property of combining with tannic acid, and this furnishes a method of so preparing these fibers that they may be dyed with the basic dyestuffs. The salts of those metals which are more or less easily dissociated in boiling water are most applicable as mordants for the animal fibers. These salts include compounds of chromium, aluminium, iron, tin, copper, etc., the most important mordants for wool being potassium and sodium bichromates (chrome) and alum (or aluminium sulphate). Pyrolignite of iron (crude ferrous acetate) and the so-called nitrate of iron (really a ferric sulphate)

*Müller-Jacobs (*Jour. Soc. Dyers & Col.*, 1885 and 1886) considers that the rôle of mordants is not only to combine with the dyestuff to form an insoluble precipitate, but also to reduce the permeability of the fiber, so as to obtain an osmotic effect by membranous diffusion. To substantiate this view he states that Alizarine Red requires fifteen times the amount of aluminium hydrate for the proper development of the color as would be necessary to form normal aluminium alizarate.

are used largely for silk; although their use in this connection is primarily for purposes of weighting, their mordanting action being a secondary consideration. The color-lake in the case of a mordant dye consists of the triple compound: fiber—metallic oxide—dyestuff. The mordant dyes are of a mild acid character or contain groups which permit of their uniting chemically with the basic metallic oxide.* On account of the fact that cotton cannot be readily mordanted after the manner of wool the general class of mordant dyes finds little or no application to this fiber. About the only instance of their use in this connection is the dyeing of Turkey Red, and this requires a special and complicated process. One feature to be noticed in connection with the mordant dyes is that the same dyestuff often gives very different colors on different mordants; Alizarine Red, for instance, when dyed on a chrome mordant gives a rather dull purplish red; on an aluminium mordant it gives a bright red; on a tin mordant it gives a scarlet; and on an iron mordant it gives a dull purple.

The term "mordant" is derived from the old French word "mordre," meaning to bite or corrode, it being the idea among the early dyers that the action of the mordant was to corrode the fiber somewhat so as to open up the pores and allow of the better penetration of the coloring matter. It was not known till a later period that the mordant actually combined with the dyestuff to form a color-lake.† In the popular mind the idea

* J. Thom has pointed out that mordants exhibit an elective affinity for dyestuffs; that is to say, they possess a greater attraction for some dyes than for others. For example, cloth mordanted with alumina is dyed yellow with Quercitron; if the same sample is boiled in a decoction of Logwood the latter will displace the Quercitron and the color changes from yellow to purple; while if the sample is further boiled with Madder, the Logwood in turn is displaced and the color changes to red. On the other hand, Knecht (*Jour. Soc. Dyers & Col.*, 1904, p. 98) has shown that metallic mordants themselves may displace each other, as when cloth mordanted with tannate of iron (slate color) is boiled with a solution of titanium chloride, the iron is displaced with the formation of tannate of titanium (orange color).

† The use of mordants was really more extensive in the early days of dyeing than it is now, owing to the fact that most of the dyestuffs (the vegetable dyes) then available required a mordant for their proper fixation in the fiber. In many cases very complicated methods of mordanting were employed, whereby mixed mordants consisting of the salts of several metals were employed in order to produce certain effects. This is apparent if one refers to the old books on dyeing giving recipes used previous to the advent of the coal-tar colors. The instruction is often found "to wash in the river" after dyeing. It is supposed that the beneficial effect to be obtained by this injunction was due to the metallic salts present in the river water. The use of hard water containing lime and magnesium salts was recommended in dyeing Turkey Red so that a compound alum-lime (or alum-magnesia) mordant could be obtained. Prudhomme has shown (*Bull. de Mulhouse*, 1891, page 39 and 217) that alumina precipitated in the presence of magnesia is insoluble in caustic alkalies. Nickel and cobalt salts also act in the same manner; while

of mordants is not very clearly defined; many are apt to include under this term almost any chemical which is used in connection with the dye-stuff in its application to the fiber; for instance, the common salt, glauber-salt, or acid that may be used to aid the dyeing process is loosely spoken of as a "mordant." These should more properly be considered as "assistants," as they do not act in the proper rôle of a mordant. The latter term should only be applied to those materials which actually combine with the fiber on the one hand and the dyestuff on the other, thus forming a necessary link in the eventual color-lake contained in the fiber. A distinction must also be drawn between the use of metallic salts as mordants proper and their use in processes of after-treatment of certain dyed colors. In some cases their effect is to form a more stable color-lake on the fiber, though even here it is doubtful if their action is the same as that of a true mordant. In other cases, such as with many colors where chrome is used as an after-treatment, the effect is simply to cause an oxidation of the dye to another product which is more insoluble and consequently of increased fastness. A good illustration of this is the after-chroming of some of the chromotrope dyes; when applied directly as acid colors these dyes give red or brown colors which have poor fastness, but when after-chromed the color is changed to blue or black and the fastness is greatly increased. The action of the chrome, however, in such cases may be more complicated than is at first apparent; besides its chemical action on the color we have reason to believe that the metallic base also enters into some form of combination in the resulting color-lake. This is evidenced by the fact that alum and bluestone also effect changes in the color of certain dyes and produce an increased fastness in a manner very similar to that of chrome; and in such cases the effect cannot be due to an oxidation of the color, but rather to the formation of a compound in which the metallic base enters as a component.

Generally speaking, mordants are of three classes:

- (a) metallic mordants, such as chrome, alum, bluestone, copperas, tin salts, titanium salts, etc.
- (b) tannin mordants, such as catechu, sumac, tannic acid, etc.
- (c) oil mordants, such as Turkey-red oil, Gallipoli oil, fatty acids, etc.

The metallic mordants are salts of the heavy metals and practically any such salt may be employed, though naturally some are much more suitable than others. They may be used to combine directly with the zinc and tin salts form with each other compound mordants also insoluble in caustic alkalies. It is very probable that in many cases compound mordants are produced on the fiber either intentionally or accidentally. The best mordants as far as cotton is concerned appear to consist of the sesquioxides like those of aluminium, chromium, and iron in combination with monoxides like lime, magnesia, or zinc oxide. In some cases even treble mordants are used, like iron fixed with arsenate of soda and lime.

fiber, as in the ordinary process of mordanting wool, or they may be used in combination with tannin so as to be fixed in the fiber, as in mordanting silk and cotton; or further they may be used in combination with a fatty acid for purposes of fixation, as in mordanting cotton with alum for dyeing Turkey Red. It may thus be seen that a variety of chemical manipulations may be employed in order to obtain a fixation of the metallic mordants in the fibers.

The tannin mordants are used either as indicated above for fixing metallic mordants, or more specifically as mordants in themselves for the dyeing of basic colors on cotton.

The oil mordants consist of fatty acids in one form or another and are used to rather a limited extent and almost exclusively for the fixation of metallic bases in cotton dyeing.

The range of mordants employed and their application is much more extensive in printing than it is in dyeing. This is due to the fact that these compounds may be more readily applied and fixed in the form of a printing paste than in the form of a dilute aqueous solution, such as is usually employed in dyeing.

7. The Pigment Dyes.—These coloring matters are of a different nature from those of the other groups. While the latter are organic compounds and mostly derivatives from coal-tar, the pigment dyes are of a mineral nature. They consist, really, of mineral pigments precipitated more or less mechanically in the fiber. Chrome Yellow, for instance, consists of lead chromate, a compound of an intensely yellow color which may be prepared entirely independent of the fiber and is used extensively as a pigment for the preparation of paints.

8. Relation between Color and Chemical Constitution.—From studies of the chemical constitution of dyestuffs and organic coloring matters in general, it has become evident that there is a definite relation between the color properties of the compound and its chemical structure. It is apparent that the presence of certain molecular groups is necessary in order to have a body capable of forming a dyestuff. Such molecular groups are known as *chromophors*. In addition to this it seems necessary to have certain salt-forming groups of a basic (amino group, NH_2) or acid (phenol group, OH) character present in order that the compound act as a dyestuff in its ability to color the fibers; these salt-forming groups are known as *auxochromes*. Also the chemical characteristics of dyestuffs are due to certain well-defined groups; that is to say, the chemical structure determines in large degree whether the dye is acid, basic, substantive, mordant, sulphur, or a vat dye. The character and arrangement of the chemical groups also more or less determine the nature of the color, as is well illustrated in the case of dyes derived from salicylic acid as a component; all of these dyes are either yellow or have a strong yellow component pres-

ent. There also appears to be some relation between the chemical constitution of the dyestuff and its fastness properties; the presence of certain groups or the arrangement of the molecule in a certain form may make a dyestuff faster to light or washing, for example. The study of the details relating to the chemical structure of dyestuffs, however, is a matter of interest more for the dyestuff chemist and manufacturer than for the dyer, so will not be further considered at this point.

9. General Relations between the Fibers and the Methods of Dyeing.—

(a) **Wool.**—More dyestuffs, perhaps, are applicable to wool than to any other fiber, and consequently the methods of dyeing are quite extensive.

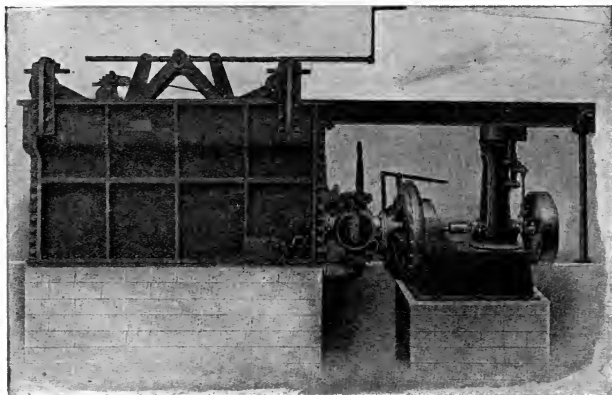

FIG. 125.—Delahunty Circulating Dyeing Machine, Ready for Operation.

In general, however, these methods may be classified under the following groups:

(1) *Dyeing in an acid bath*, where the dye liquor is given a rather strong degree of acidity by the addition of sulphuric acid. This method is principally used for the acid group of dyestuffs, though a few of the substantive dyes as well as alizarine dyes may also be applied by this method.

(2) *Dyeing in a weakly acid bath*, where the acidity of the dye liquor is obtained by the use of acetic acid. This method is employed for most of the basic and substantive dyes, and also for the group of eosin dyestuffs. Some of the after-chromed mordant dyes are also dyed in this manner.

(3) *Dyeing in a neutral bath*, though usually sufficient acetic acid must be added to correct the hardness of the water used. Some of the basic and many of the substantive dyes are applied in this manner. The dye-

bath for previously mordanted wool to be dyed with Alizarine or wood colors is also usually prepared in this manner.

(4) *Dyeing in an alkaline bath* is a rather exceptional method, and is only used for the dyeing of Alkali Blue on account of the insolubility of its free acid.

(5) *Previously mordanting the fiber with a metallic salt* and subsequently dyeing in a fresh bath. This is the usual method of applying the mordant and natural wood colors. Chrome and alum are the chief salts used for mordanting.

(6) *After-treating the dyed color with metallic mordants.*—This method is extensively used with the acid-dyeing mordant colors, and certain acid and substantive dyes which give faster colors by this treatment. The after-treatment takes place in a separate bath.

(7) *Single-bath method of mordanting and dyeing.*—This is merely a modification of the preceding method, the mordanting salt (usually chrome) being added to the dyebath directly. This method is coming into rather extensive use as a number of the mordant and acid dyes may be employed in this manner to yield fast colors.

(8) *Dyeing in specially prepared vats.*—This method is limited to the so-called "vat" colors, such as Indigo, Indanthrenes, etc. The dye-stuff is first reduced and then dissolved in an alkaline bath.

(b) *Silk* is dyed in the same general manner as its congener wool, with the exception that the dyebath is nearly always prepared with the addition of boiled-off liquor, which is the residual soap solution from the scouring of raw silk and contains a large proportion of silk-glue. It acts as a regulator to the dyebath and keeps the silk soft and lustrous. Where boiled-off liquor is not available, soap, glue, dextrin, etc., are employed as substitutes. In some rare cases a method of so-called "dry dyeing" is employed with silk. Instead of using water for the dyebath, the coloring matter is dissolved in naphtha, and the silk is dyed in this solution. The general methods of dyeing silk may be grouped as follows:

(1) *Dyeing in a bath containing boiled-off liquor and acidified with sulphuric acid.*—Most of the acid dyes are applied in this manner, also some of the basic and substantive dyes.

(2) *Dyeing in a bath containing boiled-off liquor slightly "broken" (i.e., acidified) with acetic acid.*—The majority of the basic and substantive dyes are used in this manner; also the eosin dyestuffs.

(3) *Dyeing in a neutral or slightly alkaline boiled-off liquor bath.*—This method is specially used for the dyeing of Alkali Blue.

(4) *Dyeing in a bath containing a small quantity of soap.*—This method is employed for the dyeing of delicate tints with basic dyes.

(5) *Dyeing in a bath containing acetic acid.*—This is sometimes used for acid, basic, and substantive dyes where boiled-off liquor is not

available. Tussah silk and spun silk is also generally dyed in this manner.

Silk is usually *brightened* after dyeing by treatment in a bath of dilute acetic acid, squeezing and drying without washing. This treatment not only brightens the color and increases the luster but also greatly enhances the "scoop" of the fiber.

(c) **Cotton.**—The principal classes of dyestuffs applied to cotton are the substantive and basic dyes, though the number of processes by which cotton may be dyed are numerous.

(1) *Dyeing with substantive colors in a neutral bath* containing common salt or Glaubersalt. This is the ordinary method of dyeing cotton and is applicable to the majority of the substantive dyes.

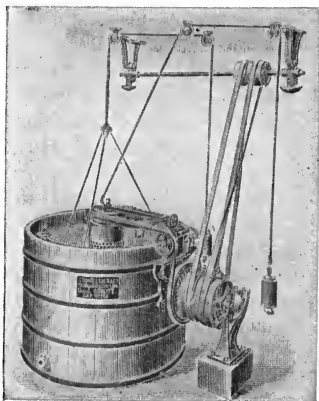

FIG. 126.—Dyeing Machine for Loose Stock. (Esser.)

(2) *Dyeing in a cold alkaline bath.*—Certain of the substantive dyes may be applied in this manner, the dyestuff usually being dissolved in some caustic soda, and soap being added to the bath.

(3) *Dyeing in a bath made strongly alkaline* with the addition of caustic soda. This is a method for the dyeing of certain red substantive colors and has a very limited application.

(4) *Diazotizing a dyed substantive color by treatment with an acidified solution of sodium nitrite and subsequently treating with a substance*

known as a developer.—This is the general method of applying the so-called *developed* dyes, and is extensively used for the production of a number of fast colors.

(5) *Treating a dyed substantive color with a solution of diazotized paranitraniline.*—This furnishes the class of so-called *coupled* colors. In addition to paranitraniline a few other amino bodies of a similar nature are employed. This method is capable of producing some very fast colors, but owing to its complexity and expense it has but a limited application.

(6) *After-treating a dyed substantive color with a solution of a metallic salt.*—This is for the purpose of giving colors faster to washing and light. The metallic salts almost exclusively employed are chrome (potassium bichromate) and bluestone (copper sulphate).

(7) *After-treatment of a dyed substantive color with formaldehyde.*—This process is used principally with black dyes, and is for the purpose of making the color faster to washing.

(8) *Mordanting the fiber with a tannate of a metallic salt and dyeing with a basic color in a fresh bath containing alum or acetic acid.*—This is the general method of applying the basic dyes and some of the natural dyes. The cotton is first treated with a solution of tannin (sumac, tannic acid, etc.), then with a solution of a metallic salt (usually tartar emetic or other suitable salt of antimony, though salts of other metals such as iron, copper, etc., may at times be used), and finally dyed.

(9) *Dyeing in a neutral bath and subsequently treating with a mordant of tannin and antimony.*—This method of after-mordanting is used for the class of *Janus* dyes, and has but a limited application.

(10) *Topping a dyed substantive color with a small amount of basic dye in a fresh neutral bath.*—This method is often employed for brightening and deepening the color obtained with a substantive dye; the latter color acting as a mordant for the basic dye.

(11) *Dyeing in an alkaline bath with the addition of sodium sulphide.*—This is the method generally employed for the application of the class of *sulphur* dyes. Many of these colors may also be after-treated with solutions of metallic salts or topped with basic colors.

(12) *Dyeing in a specially prepared vat containing a reducing agent.*—This method is for the application of Indigo and its various derivatives, as well as the general class of vat colors, such as Indanthrene, Ciba, Algol, and Helindone dyes.

(13) *Dyeing in a bath containing alum.*—This is the method of applying some of the acid dyes to cotton; blue colors are the chief ones obtained and the method has but a limited use.

(14) *Dyeing in a lukewarm bath weakly acidified with acetic acid.*—Certain of the basic dyestuffs, as well as the general class of rhodamine dyes are applied in this manner. The colors produced are very lustrous and bright.

(15) *Dyeing in a bath containing sodium stannate and sulphuric acid.*—This is a special method for the application of Soluble Blue.

(16) *Mordanting with Turkey-red oil and dyeing in a neutral bath.*—Bright pink colors can be obtained in this manner with Rhodamine. Various basic dyes may also be applied by this method.

(17) *Dyeing in a lukewarm bath containing a large amount of common salt.*—Light, bright colors can be obtained in this manner by using the eosin dyes and certain of the acid dyes.

(18) *Mordanting with soap and stannic chloride and dyeing with certain of the basic colors for the production of very bright blue shades.*

(19) *Mordanting with tannic acid and aluminium acetate* and dyeing with the rhodamine dyes for the production of bright pinks.

(20) *Mordanting with alum and sodium stannate* and dyeing with certain acid colors for the production of very bright scarlet and orange shades.

(21) *Mordanting with Turkey-red oil and aluminium acetate* (or other suitable aluminium salt) and dyeing with Alizarine Red. This is the process largely used for the production of the bright, fast red color known as Turkey Red. The method of mordanting and dyeing is rather complicated. Salts of chromium and iron may be used in place of aluminium salts, and other alizarine dyes besides the red may also be used.

(22) *Preparing the fiber with beta-naphthol and treating with diazotized paranitraniline.*—This is the method of dyeing the so-called azo colors which are built up in the fiber. Paranitraniline Red is the principal color of this class, though a number of other colors may be obtained by using certain other amino bodies in place of the paranitraniline.

(23) *Impregnating the fiber with aniline and oxidizing.*—This is the process of producing what is known as Oxidized or Aniline Black, and is also an example of building up a dyestuff directly in the fiber.

(24) *Impregnating the fiber with the solution of a metallic salt (such as lead acetate) and treating with another chemical body capable of producing a colored pigment (such as chrome).*—This is the general method of producing the mineral or pigment colors, such as Chrome Yellow, Iron Buff, etc.

Linen, ramie and the other vegetable fibers in general are dyed in much the same manner as cotton, though special modifications have often to be made depending on the nature of the fiber to be dyed. Jute and fibers of a ligno-cellulose nature differ from cotton in being capable of combining directly with acid and basic dyes as well as the substantive dyes.

Artificial silk (lustra-cellulose) is also a cellulose product, and it is dyed in the same manner as cotton, though special precautions have to be adopted, as this fiber becomes considerably weakened when wet out with water.

Feathers, hair, paper, leather, etc., are also extensively dyed.

10. Experimental. Exp. 45. Action of Acid Dyes.—Prepare a bath containing 300 cc. of water and a few drops of Formyl Violet solution. Take a scoured test skein of woolen yarn, wet it out with warm water, and place it in the above bath; boil for one-half hour; then wash well in fresh water and dry. Repeat this test, using a bath containing 300 cc. of water, 5 cc. of Formyl Violet solution, and a few drops of dilute sulphuric acid solution. It will be found that in the first test the wool is only slightly dyed, whereas in the second test it is well dyed. Repeat the second test, using a wet-out test skein of cotton yarn; wash well and dry. It will be found that the cotton is only slightly tinted by the acid dyestuff. Repeat the test again, using a skein of boiled-off silk, and it will be found that the silk is dyed like the wool.

Exp. 46. Action of Basic Dyes.—Prepare a bath containing 300 cc. of water and 5 cc. of a solution of Magenta, and boil a test skein of woolen yarn therein for one-half hour, then wash well and dry. It will be noticed that the dyestuff is taken up by the wool directly. Repeat the test, using a skein of silk. It will be found that the silk also dyes directly with the basic coloring matter. Repeat the test again, using a skein of cotton yarn. It will be found that in this case the cotton is only slightly tinted with the dyestuff. Take a second skein of cotton and work it for one-half hour at 180° F. in a bath containing 300 cc. of water and a small amount of tannic acid. Squeeze, and then dye as before described in a fresh bath. It will now be found that the treated cotton will combine with the basic dyestuff.

Exp. 47. Action of Substantive Dyes.—Prepare a dyebath containing 300 cc. of water and 10 cc. of a solution of Benzopurpurin 4B, and boil a test skein of wool therein for one-half hour, then wash well and dry. It will be noticed that the wool combines

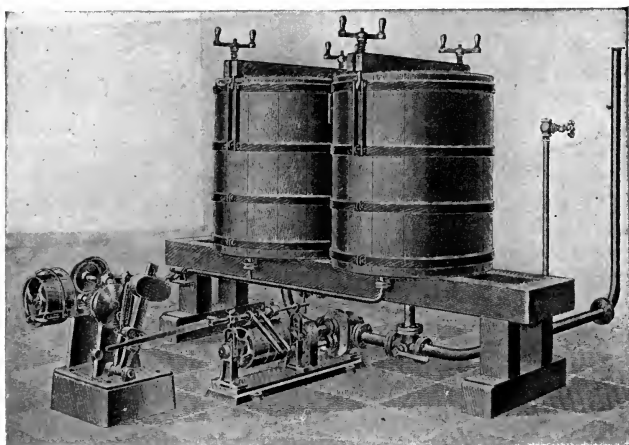

FIG. 127.—Dyeing Machine for Loose Stock. (Klug.)

directly with the substantive dyestuff. Repeat the test, using a skein of silk, and it will be found that the silk will also be dyed. Repeat the test again, using a skein of cotton yarn; the cotton will also be dyed.

Exp. 48. Action of Mordant Dyes.—Dye a skein of woolen yarn in a bath containing 300 cc. of water and a small amount of Alizarine Red; boil for one-half hour. It is found that the dyestuff is not taken up to any extent by the fiber. Boil a second skein of woolen yarn in a bath containing 10 cc. of chrome solution (potassium bichromate) for one-half hour; then rinse and dye as above given. The dyestuff will now be absorbed by the mordanted wool, combining with the chromium oxide in the fiber to form a color-lake. Dye a skein of cotton yarn with Alizarine Red in the above manner; it will be found that the fiber has no attraction for the dyestuff. Mordant a second skein of cotton yarn by working in a cold solution containing 200 cc. of water and 5 grams of ferric chloride for ten minutes; squeeze and pass through a cold solution containing 200 cc. of water and 2 grams of soda ash. This furnishes a deposit of iron oxide on the fiber and gives the latter a buff color. Now dye this mordanted skein in the above manner with Ali-

zarine Red, and it will be found that the dyestuff is absorbed and the cotton becomes dyed. Dye a skein of silk with the solution of Alizarine Red; it will be noticed that silk is similar to wool and cotton, and is not dyed by the alizarine dye. Mordant a second skein of silk with chrome in the same manner as was used for wool, and then dye with the Alizarine Red. It will be found that the mordanted silk, like the wool, will combine with the dyestuff.

Exp. 49. Action of Pigment Dyes.—Work a skein of cotton yarn for fifteen minutes in a cold solution containing 200 cc. of water and 5 grams of lead acetate. Squeeze and then work for fifteen minutes in a second cold solution containing 200 cc. of water and 2 grams of potassium bichromate. Wash well and dry. A yellow pigment consisting of Chrome Yellow (chromate of lead) will be formed in the fiber through the chemical reaction between the lead acetate and the potassium bichromate. This pigment is purely of a mineral nature and is simply deposited in the cells of the fibers and does not combine with the substance of the fiber itself, as is the case with the other methods of dyeing.

CHAPTER VI

APPLICATION OF ACID DYES TO WOOL

1. General Characteristics of the Acid Dyes.*—These colors are the principal dyes employed for the dyeing of woolen materials, especially yarns and piece-goods.† Most of them are level-dyeing; and their general fastness to washing and light is good, though the fastness varies largely with the individual members. The acid dyes, as a rule, are cheap compared with the other classes of dyestuffs and considering their high coloring power. In this latter respect, however, they are not equal to the basic dyes, though these are more costly. Generally speaking, the acid dyes give very clear, fine tones of color of great brightness. In this respect they surpass the substantive and mordant dyes, but are inferior to the basic dyes. In light shades very beautiful tints may be dyed with the acid colors, especially if the wool is first bleached in order to furnish a white basis for the color. For full saturated shades the acid dyes usually require the use of 3 to 5 per cent of color. As to fastness of the acid dyes, it is not possible to lay down a general rule, as this quality differs widely with the individual dyes; many of the acid dyes, however, are

* Most of the acid colors fall into three chemical groups: (a) nitro compounds; (b) azo compounds; (c) and sulphonated basic colors. There are also certain sulphonated dyes derived from anthracene which belong to the acid colors, such as Alizarine Sapphire. With the nitro dyes the acid character is due to the presence of several nitro groups (NO_2) in the molecule; though in the case of Naphthol Yellow S there is also present a sulphonic acid group (SO_3H). The acid character of the other dyes is due to the presence of the sulphonic acid group, or in some cases to the carboxyl group (COOH), such as in the case of the salicylic acid dyes. Of late there have appeared some acid dyes containing metallic radicals, such as chromium and copper. Most of the acid dyes occur commercially in the form of their sodium (or potassium) salts; the Patent Blues, however, occur as the calcium salts. About the only dye to be met with in the form of the free-acid is Picric Acid, and this has very little use as a dyestuff at the present time. With acid-reducing agents (zinc and hydrochloric acid or stannous chloride and hydrochloric acid) the acid dyes (in aqueous solution) are decolorized. The reduction of the sulphonated basic dyes gives a leuco compound from which the original dye may be reproduced by simple oxidation; but with the nitro and azo dyes leuco compounds are not formed, and consequently the original dye cannot be regenerated by oxidation. The nitro dyes on reduction give amino bodies ($\text{NO}_2 \rightarrow \text{NH}_2$), while the azo dyes on reduction have the azo grouping ($-\text{N} : \text{N}-$) split with the formation of two amino bodies ($-\text{NH}_2, -\text{NH}_2$).

† The acid dyes are used largely for the dyeing of suitings, dress goods, knitting and hosiery yarns carpet yarns and hat materials.

quite fast to light * and to washing; as a rule, they will not stand heavy fulling. On this account they are more applicable to the dyeing of the woven cloth (piece dyeing) than to the dyeing of loose stock or yarn. They are largely used for colors on ladies' dress goods and light suitings and other goods where heavy washing is not required.

One of the chief defects of the acid dyes is their tendency to bleed from the dyed fiber and stain undyed material when washed with soap, or even

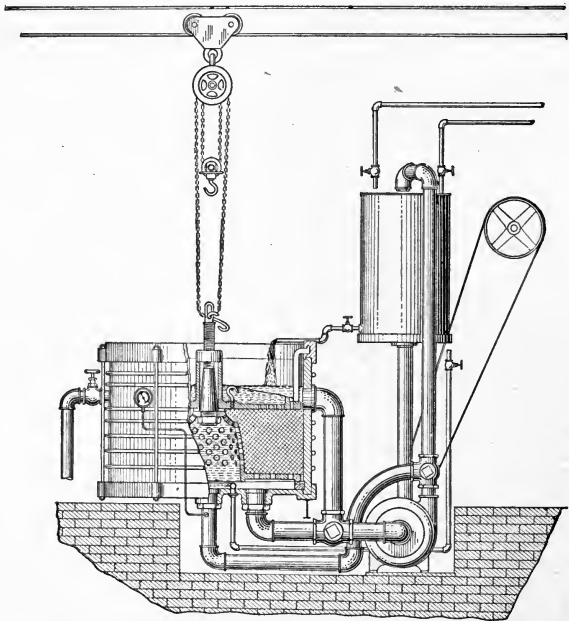

FIG. 128.—Dyeing Apparatus. (Psarski.)

when steeped in warm water. This degree of bleeding is increased if the soap used is alkaline in character, for alkaline liquors affect the acid colors considerably, so much so, in fact, that many of these colors may be stripped in great measure from the fiber by boiling in a weak alkaline liquor (such as ammonium carbonate, soda ash, borax, etc.). Treatment with strongly alkaline liquors is not to be expected, for the wool fiber itself is rapidly destroyed in hot or boiling solutions of the caustic alkalies or even a moder-

* This is specially true of the azo dyes; the acid greens and violets show much less fastness to light.

ately strong solution of soda ash or potassium carbonate. The sensitiveness to alkalis, however, varies greatly among the different acid dyes, and there are quite a number which resist the normal action of alkalis very well. It is almost needless to say that the acid colors are quite resistant to the action of weak acid solutions, seeing that the colors themselves are dyed in such liquors.

In range of color the acid dyes are quite varied, representatives of almost every color being available. Water of ordinary hardness does not have much effect on the acid dyes, and in the dyebath any tendency of hard water to precipitate these colors is prevented by the presence of acid. Material dyed with the acid colors should be well washed after coming from the dyebath, especially if heavy shades are used, otherwise the color may show unnecessary bleeding on scouring, or may have the defect of rubbing or "crocking." Should an acid color show any tendency towards dyeing unevenly, the following precautions should be observed:*

(a) Start the dyebath at a low temperature and heat to the boiling point only very gradually.

(b) Do not add any acid until the goods have been worked in the dyebath for some time, and then add the acid in several portions during the dyeing.

(c) Be sure that the dyestuff is thoroughly dissolved and add the solution in several portions during the dyeing.

(d) Do not use too "short" a dyebath, that is, one containing too little water. †

* Dyestuffs which show a less degree of exhaustion, as a rule, dye more evenly than those which exhaust more completely, though, on the other hand, the colors they produce are usually less fast to washing. A knowledge of the relative exhaustion and level-dyeing properties of dyestuffs is of importance in selecting mixtures of dyestuffs for the production of compound colors. Only those dyes should be combined in the same bath which have approximately the same degree of exhaustion; otherwise in using a standing bath the color ratio is constantly changing and difficulties will be experienced in shade matching.

† Dyes which exhaust too rapidly often give rise to uneven dyeing, especially if the bath is heated at all unevenly. This will be particularly true if the dyestuff solution is added to the hot bath containing the wool. Probably the greater number of dyestuffs show a tendency to come up unevenly in some degree, while the smaller number are of a very level-dyeing nature. Such dyes are not confined to any one class, but extend through all the different groups of dyestuffs. Uneven dyeings, however, may result from a variety of causes. In the manufacture of woollen materials, wools of different quality and origin are mixed together, and it will often happen that one kind of wool will have a greater attraction for the coloring matter than another, hence will dye up a darker color; or sometimes, one kind of wool will take one shade, and another kind of wool a slightly different shade; hence, the dyed color may appear uneven from this cause. For the dyeing of wool it is desirable to use as soft water as possible, though this is not so necessary as in the case of dyeing silk, where it is customary to employ soap as an addition to the dyebath. That the lime in hard water has a certain influence in dyeing is without doubt, although this effect is more or less neutralized by the presence of sulphuric or acetic acid in the dyebath.

2. Preparation of the Dyebath.—For the dyeing of woolen yarn there will be required about sixty times the amount of water or dye liquor as there is material to be dyed; that is to say, 1 lb. of woolen yarn will require about 7.5 gallons of water in the dyebath (1 gallon of water weighs $8\frac{1}{2}$ lbs.). Silk will also require about the same proportion. Cotton yarn, on the other hand, will require only about one-half the amount of dye liquor as wool; that is to say, 1 lb. of cotton may be dyed in about $3\frac{1}{2}$ gallons of dye liquor.*

In dyeing wool with the acid dyestuffs, it is customary to use the following general formula in the preparation of the bath:

4 per cent of sulphuric acid, †

20 per cent of Glaubersalt,

x per cent of dyestuff (in necessary amount to produce the color desired).

While this is to be considered a general method applicable to almost any of the acid dyes, it may be varied somewhat as occasion requires with the use of particular dyestuffs.

Instead of Glaubersalt and acid, sodium bisulphate itself may be used with the same general effect; in which case about 15 per cent is employed (as this will furnish about 4 per cent of free sulphuric acid). ‡

The proper regulation of the temperature of the dyebath is also to be considered. While for most purposes of dyeing it is necessary to boil the material in the dyebath for at least one-half to one hour in order to obtain proper penetration and fixation of the coloring matter, it is also frequently inadvisable to enter the wool when the dye liquor is at a boiling temperature, as this may lead to uneven and superficial dyeing. In a general way it may be said that the most suitable temperature to start the acid dyebath is about 140° F. §

* The porcelain beakers employed for the dye-tests described in this book should conveniently hold about 300 cc. of water; consequently they are of a convenient size for the dyeing of 5-gram skeins of woolen yarn or 10-gram skeins of cotton yarn, so that the woolen and cotton skeins employed for the tests should be supplied in these weights respectively. For silk, skeins of about 2 grams weight may be employed (for economy), consequently for such tests only about 125 cc. of dye liquor should be used.

† In formulas relating to the application of dyestuffs, unless otherwise specified, the percentages refer to the weight of the material being dyed; 100 lbs. of wool, for example, would require 4 lbs. of sulphuric acid and 20 lbs. of Glaubersalt.

‡ In the case of dyeing carbonized goods which have not been neutralized with alkali, and which in consequence are still of an acid character, it is best to start the dyebath with Glaubersalt only, adding a little sodium bisulphate or acid later on if necessary.

§ In the dyeing of piece-goods that are hard to penetrate it is well to increase the amount of Glaubersalt in the bath and also to enter the goods at a somewhat lower temperature. In the case of goods containing kempy wool fibers that are difficult to

It is nearly always necessary to boil the goods in the dyebath in order to obtain a proper fixation of the color even though the full shade of the dye may apparently be developed at a lower temperature or with only a slight degree of boiling.* It must be remembered that the wool fiber is a sort of hardened glue-like filament which becomes softened and rendered absorbent by prolonged treatment with boiling water, and that it is the purpose of the dyeing operation to cause the dyestuff solution to penetrate the innermost parts of the fiber and also to assure as complete an absorption of the coloring matter as possible by the substance of the cell-walls of the fiber. By using a cool dyebath or not boiling sufficiently, there will be a tendency to have the dyestuff taken up only superficially, and also there will be incomplete combination between the color and the colloidal jelly-like mass of the fiber. It will also frequently be found that with insufficient boiling the color will come up uneven or "shattery," whereas this defect may be remedied by longer boiling. It is not desirable, on the other hand, to boil the bath too vigorously or too long, as this will result in injury to the fiber through felting; the bath is best maintained at a simmer, a violent ebullition being avoided.

There are several variations from the typical formula for dyeing acid colors; instead of preparing the bath with all of its ingredients to start with, the bath may be made up with only the color solution and the Glaubersalt; the goods are introduced at the usual temperature of 140° F. and the temperature is gradually raised to the boiling point. During the period of the dyeing the acid is added in several successive portions, and this causes a more gradual feeding on of the color. This method is generally employed in the case of dyes having poor level-dyeing properties, or in the case of goods where penetration is difficult and it is necessary to have the dye feed on very slowly in order to secure uniform coloring. It is also well to use this method in the dyeing of carbonized shoddy or "extract" wool, consisting of fiber which has been already treated with acid. With this kind of material the fiber already has an acid character, and if further immediate additions of acid are made to the bath, the color may be taken up too quickly to give good results.

Another variation of the general method is to replace the sulphuric acid with a milder-acting acid, acetic acid being the one most usually

dye through it is recommended to keep the bath at a lively boil and also to add a little further acid toward the end of the dyeing.

* In the use of acid dyes for purposes of shading when dyeing to match a color, care must be taken to use only the best level-dyeing dyes when the additions of dyestuff are to be made in the boiling bath, otherwise the added color will be taken up too quickly to give even results. If it is not possible to use the very level-dyeing dyes, the dyebath will have to be cooled down somewhat before adding the color.

employed, although of late years, formic acid has also been used for this purpose with very good results.* The action in this case is simply to weaken the acid strength of the bath and this has the same retarding influence on the absorption of the color. From 3 to 5 per cent of acetic acid may be used, or from 2 to 4 per cent of formic acid. It is to be noted that the latter acid is more energetic in its reaction than the former. Frequently, in order to obtain a more satisfactory exhaustion of the dyebath, it is necessary to add some sulphuric acid (usually from 1 to 2 per cent) towards the end of the dyeing. This is probably explained by the fact that the organic acids like acetic and formic acids are volatile in the boiling dyebaths, and consequently the latter gradually loses its acidity on boiling; whereas sulphuric acid, not being volatile, under these conditions keeps the bath acid even after prolonged boiling. It is also to be borne in mind that both acetic and formic acids are considerably more costly than sulphuric acid, therefore economy will demand that they be used to substitute the latter acid to the least degree possible.

For the purpose of obtaining a very gradually developed acidity in the bath in cases where extreme precautions must be taken to produce even and well-penetrated dyeings, the substitution of the acid by ammonium acetate † or sulphate has been suggested. These salts gradually dissociate in a boiling solution, and as the ammonia is highly volatile, the bath will gradually develop acidity on boiling, while maintaining a practically neutral condition at lower temperatures. The acetate is more reactive in this way than the sulphate. To obtain sufficient acidity, however, it is usually necessary to employ considerable amounts of the ammonium salts (from 5 to 10 per cent of the acetate and 40 to 80 per cent of the sulphate), and as these salts are relatively costly, their use in this connection will be limited to very few occasions, such as in the dyeing of heavily fulled cloth or very hard, tightly twisted yarns where good color penetration cannot be obtained by other methods. Also the use of this method requires a very prolonged boiling of the goods. In this connection it might be noted that a solution of ammonium acetate will usually strip down an acid

* Formic acid is coming into use for the dyeing of woollen piece-goods containing cotton or artificial silk effect threads which it is desired to leave white. In order to prevent these effect threads from becoming stained the goods must be dyed in a strongly acid bath, and formic acid is most suited for this purpose as its acidity is very strong (much greater than acetic acid) and at the same time it does not have the same tendering effect on the cotton or artificial silk as sulphuric acid. In the dyeing of such goods, however, they should be well rinsed immediately after dyeing, and they should be dried as soon as possible; for if left for any length of time in the wet state the dye is liable to bleed from the wool and stain the white effect threads.

† Ammonium acetate is made by mixing 4 parts of ammonia (24 per cent) with 10 parts acetic acid (30 per cent). This solution will be slightly alkaline to litmus, but this is of no disadvantage in dyeing.

color to a considerable degree, and on this account has no doubt a specific action in retarding the dyeing operation. A special use of this method, however, is in the dyeing of wool and silk mixed goods when it is desirable to have the acid dyes take up only on the wool and leave the silk colorless. To obtain this result the use of ammonium acetate in place of acid is very satisfactory.

In the case of certain of the acid dyes, the acid may be entirely omitted and a neutral bath be employed.* The dyes, however, that are capable of being used by this method are quite limited, and the method is only used in special cases, such for instance as in dyeing wool and cotton mixtures

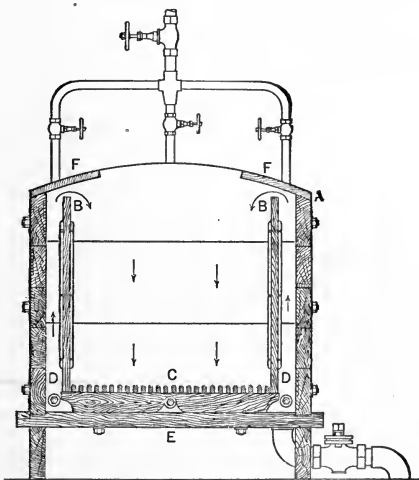

FIG. 129.—Rhodes Dyeing Machine.

(union goods), where a substantive dye is used for coloring both fibers and it is necessary to shade somewhat the wool by the use of a neutral dyeing acid color, the use of acid not being desirable in the bath.

A special modification of the type formula for acid dyes is the use of stannic chloride (1 to 2 per cent) in the bath in addition to the acid and Glaubersalt. This is for the purpose of obtaining more brilliant colors with certain dyes. In this connection it is necessary to avoid the use of

* In dyeing carbonized goods with Alkali Blue care must be taken that the acid in the material is first completely neutralized before entering the dyebath, as otherwise there will be danger of some of the dye being precipitated on the goods. The same precaution should be observed in the dyeing of shoddy goods where the fiber may have been treated with acid solutions.

stannous chloride (which is frequently present in the stannic compound), as this reduces and destroys many of the acid dyes (the azo colors). The addition of alum (6 to 8 per cent) to the bath is also made at times for this same purpose.

3. Function of the Chemicals Employed in Dyeing Acid Colors.—These chemicals are mostly confined to *sulphuric acid* and *glaubersalt*.

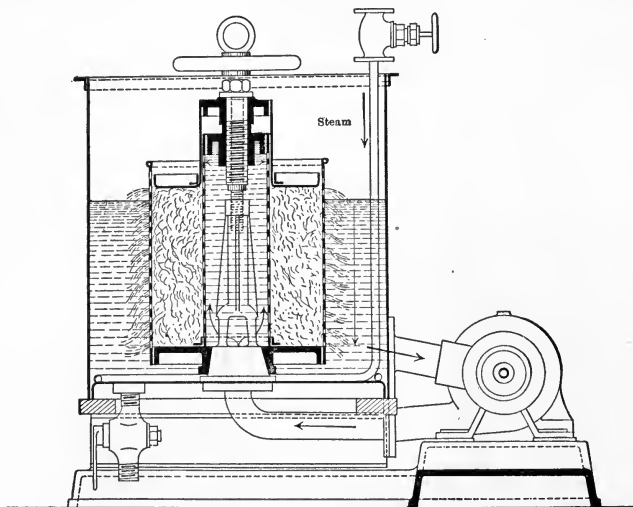

FIG. 130.—Dyeing Machine for Loose Stock. (Obermaier.)

As explained by the general theory of dyeing, the sulphuric acid is used for the purpose of liberating the color-acid of the dyestuff * so that it may

* Apparently the acid exerts other influences besides the one of simply liberating the color-acid. For instance, in dyeing with 2 per cent of Crystal Scarlet only 0.2 per cent of acid would be necessary to split off the free color-acid; but if this amount of sulphuric acid is used in the bath a light shade only of the color is obtained. In order to produce a full shade and obtain satisfactory exhaustion, a much larger quantity of acid is required; in fact it takes thirty to forty times as much acid to obtain maximum results as would be required to simply split off the free color-acid—that is to say, from 2 to 4 per cent of sulphuric acid is used. The acid in the dyebath also apparently reacts with the wool itself, for it has been shown (*Jour. Soc. Dyers & Col.*, 1888, page 107) that if wool is boiled with 10 per cent of sulphuric acid and then boiled out nine times with 100 times its own weight of water, until the water is perfectly neutral in reaction, it will dye a heavier shade with 2 per cent of Crystal Scarlet than another sample of untreated wool with the same quantity of dyestuff, even with the addition of 2½ per cent of sulphuric acid to the dyebath.

more readily combine with the basic component of the fiber; hence the addition of the acid facilitates the dyeing and increases the exhaustion of the bath. Some acid dyes naturally require more acid than others to give the same degree of exhaustion, but 4 per cent (on the weight of the wool) appears to be ample for almost all cases. The dyer does not vary the amount of acid with each individual dyestuff or variation in quantity of dyestuff used, but adheres to the fixed quantity of 4 per cent. Sometimes a better degree of exhaustion may be obtained by the addition of a further quantity (about 2 per cent) of acid near the completion of the dyeing operation. Some of the acid dyes do not require the addition of such a strong acid as sulphuric to liberate the color-acid, but give very good results with a milder acid, such as the organic acetic acid. Formic acid may also be used. Such colors are especially useful for the dyeing of wool-cotton fabrics, as the cotton is not injured by the acetic or formic acid. Nearly all of the acid colors are slightly dissociated on dissolving in water; that is to say, a small amount of the free color-acid is formed; hence a certain degree of dyeing takes place even without the addition of acid. Some of the acid dyes are largely dissociated in solution, and consequently these may be dyed in a neutral bath. Such colors are also useful for wool-cotton dyeing. Therefore the acid dyes may be divided into three groups with reference to the required acidity of the dyebath:

- (a) Dyes which may be applied in a neutral bath.
- (b) Dyes which require a slightly acid bath; usually acetic acid being employed.
- (c) Dyes which require a bath acidulated with sulphuric acid.

The *glaubersalt* used in the dyebath may exert an influence in several different ways:

- (a) In mechanically retarding the interaction between the color-acid and the fiber.
- (b) In chemically retarding the liberation of the color-acid from the dye-salt.
- (c) In affecting the solubility of the dyestuff in the solution.

The first effect will be considered under the general theory of dyeing (Chapter XXV), and is very likely the chief influence exerted by the *glaubersalt*. There is a considerable possibility, however, that a chemical action may come into play. It is a well-established principle in chemistry that when one of the products of a chemical reaction is present in the solution, the rapidity and extent of this reaction will be reduced. Now, in the interaction between sulphuric acid and the dyestuff (which is generally the sodium salt of the color-acid) *glaubersalt* is formed; hence, if a relatively large proportion of *glaubersalt* is already present, the reaction between the acid and the dyestuff will be considerably retarded. Just to what extent this influence of the *glaubersalt* affects the even dyeing of the acid colors is a question; but it is doubtful if it is as important as the

preceding influence. As to the degree in which the glaubersalt affects the solubility of the dyestuff in the solution, it may be stated that this must be rather limited, when it is considered that both the dyestuff and the glaubersalt are in rather dilute solutions. The general effect of the addition of glaubersalt to a dyestuff solution would be to lessen the solubility of the dye; but in order for this effect to be marked the concentration of the glaubersalt in the solution would have to be rather high. If the glaubersalt did act in this manner in the ordinary dyebath, the effect would be to throw the dyestuff out of solution and hence to promote uneven rather than level dyeing; whereas we know the opposite to be the case. Furthermore, many of the acid dyes may be partially stripped from

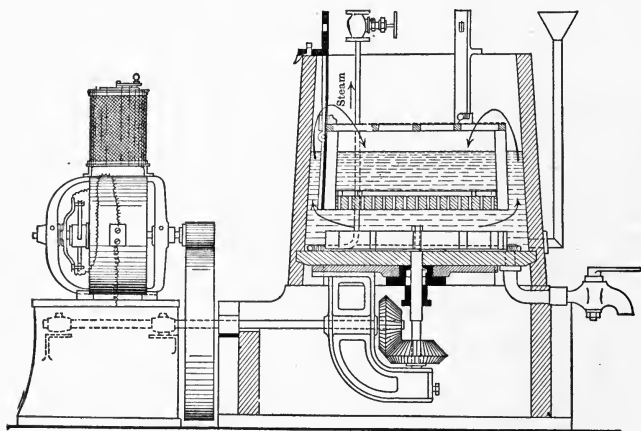

FIG. 131.—Dyeing Machine for Loose Stock. (Schmidt.)

the fiber by boiling in a bath containing glaubersalt; much more of the dyestuff being dissolved than if plain boiling water were used.

Glaubersalt is the common name for crystallized sodium sulphate; it has the chemical formula $\text{Na}_2\text{SO}_4 \cdot 10\text{H}_2\text{O}$. Calcined or desiccated glaubersalt has the water of crystallization removed by heating; it is a white amorphous powder, having the formula Na_2SO_4 . About 44 parts of desiccated glaubersalt are equivalent to 100 parts of the crystalline salt.

4. Exhaustion and Leveling Properties.—The acid dyes, as a rule, exhaust fairly well, though this quality varies with individual members of the group. The exhaustion of the dyebath may usually be considerably increased by the addition of extra acid towards the end of the dyeing operation. In case the bath does not exhaust well, it should be kept as a

“standing kettle,” that is, preserved for further use and freshened up by the addition of the necessary amount of dyestuff. Of course, the poorer the exhaustion of the dyebath the less will be the amount of the second addition of dyestuff. Generally speaking, with the third or fourth successive bath, the amount of dyestuff to be added each time will become constant in order to produce the same shade. Most of the acid dyes will give a “full shade” (in a starting bath) with about 3 to 5 per cent of color. By a full shade is meant the maximum depth of color given by a dyestuff.

When it is necessary to use copper vessels or machines in the dyeing of acid colors on wool in light or bright shades, to obtain the best results about 3 oz. of ammonium sulphocyanide should be added per 100 gallons of dye liquor. This is due to the fact that the acid in the dyebath will dissolve some of the copper and this will then react with the sulphur present in the wool fiber to give a black copper sulphide, thus dulling the dyed shade. The presence of the ammonium sulphocyanide prevents the formation of the copper sulphide.

5. Calculations Used in Dyeing.—The amounts of dyestuffs and chemicals employed in dyeing are usually expressed in terms of percentages on the weight of the material to be dyed. Thus in Exp. 50, “20 per cent of Glaubersalt, 4 per cent of sulphuric acid, and 1 per cent of Acid Magenta” are called for; this would mean that the actual amounts of the substances to be taken are to be the respective percentages on the weight of the yarn dyed, which in this case is 5 grams. Therefore we have:

$$\begin{aligned} 5 \text{ grams} \times .04 &= 0.20 \text{ gram for the sulphuric acid,} \\ 5 \text{ grams} \times .20 &= 1.00 \text{ gram for the Glaubersalt,} \\ 5 \text{ grams} \times .01 &= 0.05 \text{ gram for the dyestuff.} \end{aligned}$$

As these are rather small amounts to be continually weighing out, it is best to have the chemicals and dyestuffs employed in the dye-tests made up in solutions of such strength that convenient volumes will contain the required amounts as needed for the preparation of the dyebaths. As 4 per cent is the customary amount of sulphuric acid to employ, a convenient solution would be one of such strength that 10 cc. would contain 4 per cent of the acid on 5 grams (this being the weight of the woolen yarn employed in all the tests). To prepare 1 liter or 1000 cc. of this solution, proceed as follows:

$$\begin{aligned} 10 \text{ cc. is to contain 4 per cent on 5 grams} &= 0.2 \text{ gram acid.} \\ 1000 \text{ cc. would therefore contain} &= 20 \text{ grams acid.} \end{aligned}$$

As the commercial concentrated sulphuric acid has a density of about 1.84 (i.e. 1 cc. weighs 1.84 grams), 20 grams by weight of the acid would be equivalent to $20 \div 1.84 = 11.9$ cc. Hence the solution should contain 11.9 cc. of the concentrated sulphuric acid per liter. The solution of glau-

bersalt may be prepared in a similar manner. A convenient strength is one containing 20 per cent of the salt on 5 grams in 10 cc. which would be 1 gram in 10 cc., or 100 grams per liter. A convenient strength for the solutions of dyestuffs is 5 grams per liter; hence 1 per cent on 5 grams would be equivalent to 10 cc. of the solution. For a 10-gram skein, where cotton yarn is employed in the tests, 20 cc. would be equivalent to 1 per cent.

6. General Remarks on the Dyeing of Wool.—Wool may be dyed in any of its stages of manufacture, i.e., as *loose wool* or *stock*, as *slubbing*, as *yarn*, or as the *woven piece*. But in whatever form it may come to the dyer, it is necessary that the fiber be as clean as possible; that is, it must be thoroughly scoured. In order to obtain uniformity of results it is best that the dyer should scour the material himself before attempting to dye it, as very frequently imperfect dyeing results from taking too much for granted in the matter of scouring.

In some cases, where a pure and high-grade fabric is desired, it is required to *carbonize* wool stock before dyeing. This is for the purpose of removing the vegetable matter, burrs, straw, grass, etc., from the fiber (see page 74). Sometimes instead of carbonizing the wool in the loose state, the removal of the vegetable matter does not take place until the wool has been woven and dyed in the piece. This is usually done in the case of high-grade wools which on dyeing in dark shades (especially blacks and blues) show little undyed specks due to the accidental presence of vegetable fibers. The cloth is treated with acid, dried, and washed for the purpose of carbonizing much in the same manner as already described for loose wool. Either a solution of sulphuric acid (2 to 4° Tw.) is used, or gaseous hydrochloric acid. Of course, the dyes used must be such as to resist the action of the carbonizing process. In lower grade woolen cloths the vegetable specks are usually covered up by what is known as "speck dyeing," which is mostly confined to blacks. The goods are run through a bath containing Logwood, bluestone, and soda ash, which dyes the specks of vegetable matter.

When light, bright, and delicate colors are to be obtained on loose wool, it is generally necessary to employ bleached stock. The bleaching is done in the usual manner as described on page 108.

7. Dyeing Wool in the Loose Stock.—When dyed in the stock it must be borne in mind that the wool must subsequently be carded, spun, woven, scoured, and finished; therefore it is necessary to select a method of dyeing which will yield a color capable of withstanding the various treatments to which the fiber must be subjected. It is necessary that the color be fast to crocking and scouring at least; hence it is customary to employ fast colors for the dyeing of wool stock. However fast the color may be it is almost impossible to prevent some difference occurring in the shade

as dyed on the stock and that which the finished fabric assumes. This is more or less due to the difference in the mechanical distribution of the fibers after spinning and weaving, usually having the effect of darkening the color. Wool dyed in the stock will also be more or less uneven in shade, due to unevenness in the character of the fiber throughout the mass of the wool, causing different parts to take up the dyestuff somewhat differently. In the subsequent carding process, this unevenness is remedied by the thorough mixing of the different fibers, but at the same time the shade of the entire mass may suffer considerable alteration. Therefore it is readily understood that it is difficult to dye wool in the

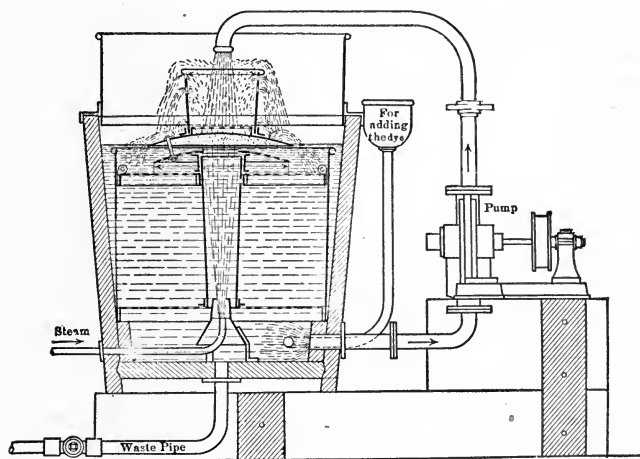

FIG. 132.—Dyeing Machine for Loose Stock. (Dréze-Michaelis.)

stock so as accurately to match a given shade in the finished piece, it being necessary to make a proper allowance for the alteration which the color must suffer during the process of manufacture.

Wool is more perfectly dyed, however, in the loose state than in its other forms. This is due to the fibers being more free and open; consequently more directly exposed to the action of the dye liquor, and allowing of a better absorption and penetration of the dyestuff into the fiber. For the same reason, wool stock requires more dyestuff to be used for a given shade than yarn or cloth; and this, together with the fact that fast dyes must be employed, causes loose wool dyeing to be more expensive in the matter of drugs. There is also always more or less felting of the fibers when wool is dyed in the stock, and a consequent deterioration and loss

during the subsequent carding, drawing, and spinning processes, which is a further item of increased expense to be attached to this method of dyeing.

The chief purpose of dyeing wool in the stock is for the manufacture of *mixes* and fancy yarns. The mixes are obtained by carding a certain proportion of colored wool with white wool (oxfords, grays, etc.), or several colors may be carded together for producing compound shades. If portions of yellow and blue wools, for instance, be carded together and thoroughly mixed, a very uniform resultant color is obtained, which in this case would be green. This is caused by the eye not being able to distinguish the separate colors of two or more fibers in juxtaposition, but only perceives the blended or compound color.

8. Dyeing Tops and Slubbing.—In its dyeing relations slubbing or tops is very similar to wool stock. As it contains a small quantity of oil added for the purpose of carding or combing, it is often necessary to give it a mild scouring preliminary to dyeing. Worsted tops are dyed very extensively in special machines, the object being to leave the fibers as free as possible, so as to avoid loss and bad work in the subsequent drawing and spinning operations. As worsted materials, as a rule, are not very heavily fulled in finishing, and as but a small quantity of oil and dirt are acquired in the process of making the yarn, thus requiring but a mild scouring in the piece, the dyestuffs employed for top dyeing often need not be specially fast to fulling—at least not to the same extent as those required for the dyeing of wool stock or slubbing intended for woollen yarns which, as a rule, are to be subjected to heavy scouring or fulling in the piece. Worsted mixes are mostly dyed in the form of tops, the mixing being done in the drawing and spinning.

9. Dyeing Woollen Yarns.—The dyeing properties of yarn are essentially different from those of wool stock. In this respect yarns may be divided roughly into three classes: (1) carpet yarns (and other low-grade yarns containing coarse, hairy fibers); (2) woollen yarns (made in general from noils and clothing wools); (3) worsted yarns (made from combed tops and including high-grade luster wools). The first class of yarns usually contains a large amount of oil, grease, and dirt, and frequently it is an object not to remove any more of these impurities than possible. The cheaper acid dyes are mostly employed and no special regard is had as to fastness. Woollen yarns are generally thoroughly scoured previous to dyeing, and as these yarns generally go into goods requiring fulling, the faster acid and the mordant dyes are employed; also some substantive dyes are available. For delicate shades the yarn must be bleached, though in some cases the bleaching is done after the dyeing. Worsted yarns contain but little oil and dirt (those spun by the French system contain no oil at all) and hence require very mild scouring. Colors that are fast to light and scouring are usually required on worsted yarns, as these go into cloths

that are not heavily fulled. In the dyeing of worsted yarns one desideratum is to avoid felting of the fibers and to retain the luster of the wool.

10. Dyeing of Piece-Goods.—Piece-goods are dyed only where solid colors are used, though various processes have of late been introduced for the purpose of obtaining varied colored effect threads in the body color of the piece. This is done by preparing the dyed yarn (usually worsted) with a "resist" which prevents this yarn from taking the color when the piece is dyed. Cloth (especially that from woolen yarns) requires a fairly good scouring, as a rule, before dyeing in order to remove the oil, dirt, and dressing used in the preparation of the warp. In any case all piece-goods should be thoroughly wetted-out with hot water before entering the dyebath, otherwise uneven and cloudy colors are liable to follow. Frequently in piece-goods one class of wool is used in the warp and a dif-

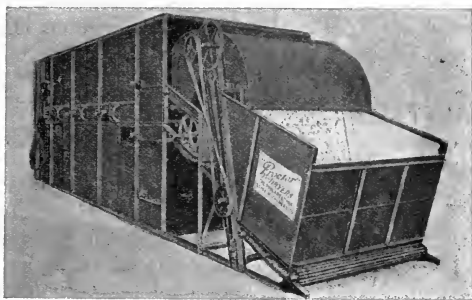

FIG. 133.—Automatic Dryer for Cotton, Wool, Raw Stock, etc.
(Philadelphia Textile Machinery Co.)

ferent class of fiber in the filling; as different qualities of wool are liable to take the same dyestuff a little differently a "skittery" effect is liable to occur. To avoid this as far as possible the piece should be boiled in water for some time before dyeing. Piece-goods are frequently carbonized before dyeing, the operation being carried out in about the same manner as described for loose wool. In case the pieces contain dyed yarns and the carbonizing is done previous to finishing, it is well to employ a solution of aluminium chloride of 9 to 12° Tw. in place of sulphuric acid, as this will cause less injury to the dyed colors.* A solution of magnesium chloride of

* In order to preserve the proper dyeing qualities of the cloth in carbonizing it should be borne in mind that when wool is saturated with acid and exposed to the light the fiber may become so changed as to resist the dyestuff. Also no soap should be allowed to come in contact with the carbonized wool until the fiber has been thoroughly neutralized with soda ash, as otherwise the soap will be decomposed by the acid into free fatty acids which are sticky substances and very difficult to remove from the goods, and may cause bad streaks in the subsequent dyeing.

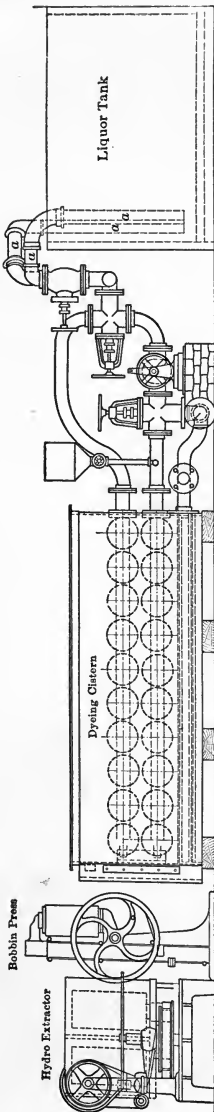

FIG. 134.—Sliver Dyeing Machine. (Haubold.)

15° Tw. may also be used. After saturating with the solution the cloth is hydro-extracted and dried first at a moderate heat and then carbonized at a temperature of about 220° F. The decomposed vegetable particles are then mechanically disintegrated and removed by running the pieces for a short time in a dry fulling mill, after which the goods are neutralized by rinsing in a bath of dilute soda ash or ammonia. Where the pieces contain cotton selvages, in order to prevent the destruction of the cotton yarns in the carbonizing the selvages should be coated with a solution of sodium silicate (15° Tw.) before entering the drying chamber. A thickened soda ash solution may also be used. For the dyeing of delicate shades or for very bright colors, it is usually necessary to bleach woolen or worsted piece-goods previous to dyeing. This is generally done by the method using a solution of sodium bisulphite. The class of colors employed in dyeing piece-goods will vary according to the special demands of fastness. Acid colors are mostly employed, for piece-goods are scoured and fulled previous to dyeing, hence, as a rule, colors especially fast to these requirements are not needed. Where colors very fast to light are required, the mordant dyes are generally used. In the dyeing of piece-goods "lists," or lengthwise streaks, are liable to develop. This fault may arise from a variety of causes. In the first place, the goods may be imperfectly washed, leaving some of the color solution in the fiber. If the pieces are then rolled up and stood on end the residual color solution will drain down to the lower edge and often result in a dark shading on that side of the goods. If the rolls of cloth are laid flat the exposed edges will

dry out, and then by capillary action the liquor will be drawn to the drier parts and thus deposit its color along both edges, leaving the center of the piece lighter. Lists may also be the result of using hard water in washing after scouring and before dyeing, and thus leaving a deposit of lime salts either on one or both edges of the cloth, as above described. This will often cause heavier shades in the subsequent dyeing.

11. Experimental. Exp. 50. General Method of Dyeing on Wool.—Prepare a dyebath containing 300 cc. of water, 20 per cent of Glaubersalt, 4 per cent of sulphuric acid, and 1 per cent of Acid Magenta. Have the temperature of the bath at about 140° F. and place in it a well-scoured and wet-out test skein of woolen yarn; by means of the stirring rods give the skein a few turns in the liquor so as to saturate the fiber thoroughly with the solution. Then allow the skein to hang from a stirring rod into the dyebath, and heat the latter gradually to the boiling point, turning the skein from time to time so that it may dye up evenly. Do not maintain the liquor in a state of actual ebullition, as this will rapidly cause the fibers of the wool to felt together; keep the bath just at a simmer. Continue the dyeing at this temperature for one-half hour, turning the skein from time to time. Then remove the skein, squeeze out the dye liquor, rinse well in fresh water until no more color is removed from the fiber, then squeeze out and dry. This experiment represents the general method of dyeing nearly all acid dyes on wool.

Exp. 51. Showing the Use of Glaubersalt in the Dyebath.—Prepare a bath containing 300 cc. of water, 4 per cent of sulphuric acid, and 2 per cent of Naphthyl Blue Black. Dye a test skein of woolen yarn in this bath, entering at 120° F. and gradually raising to the boil, and continue at that temperature for one-half hour; then wash and dry. It will be found that the skein has become colored rather unevenly, due to the fact that no retarding agent such as Glaubersalt has been added. Now prepare a second bath similar to the preceding one, but also add 20 per cent of Glaubersalt, and then dye a second skein of woolen yarn as before. After washing and drying, compare the evenness of the colors on the two skeins.

Exp. 52. Showing the Influence of the Amount of Acid in Dyeing with Acid Colors.—Prepare four dyebaths, each containing 300 cc. of water, 20 per cent of Glaubersalt, and 2 per cent of Formyl Violet 10 B. To the first bath add 1 per cent of sulphuric acid, to the second add 2 per cent of the acid, to the third add 4 per cent of the acid, and finally to the fourth add 8 per cent of the acid. Dye a skein of woolen yarn in each of these baths in the usual manner; that is, entering at 120° F., gradually raising to the boil and dyeing at that temperature for one-half hour. After dyeing, wash and dry, and compare the color on the several skeins. Also compare the depth of color left in the respective dyebaths after the dyeing operation has been completed.

Exp. 53. Showing the Exhaustion of the Dyebath.—Prepare a bath containing 300 cc. of water, 2 per cent of Acid Magenta, 4 per cent of sulphuric acid, and 20 per cent of Glaubersalt. Dye a skein of woolen yarn in this bath in the usual manner. Squeeze the excess of dye liquor back into the bath; wash the dyed skein and dry. Then dye a second skein of woolen yarn in the same bath without any further addition of dyestuff or chemicals, but fill up the dyebath with water so that the volume is brought back to the original point. After dyeing, squeeze the excess of liquor into the bath again, wash the second skein and dry. Then add water again to the bath to bring it back to the original volume, and dye a third skein of woolen yarn in the same manner, and after dyeing, wash and dry. Compare the color obtained on the three skeins, and this will give a good idea of the relative exhaustion of the dyebath.

Exp. 54. Dyeing Acid Dyes in a Neutral Bath.—Some of the acid dyes are dissociated considerably on dissolving in water and liberate sufficient color-acid to allow

of the dyeing of the wool without the addition of any acid to the bath. Prepare a bath containing 300 cc. of water, 10 per cent of Glaubersalt, and 1 per cent of Orange ENZ Dye a skein of woolen yarn in this bath in the usual manner, and wash and dry. Prepare a second bath containing 300 cc. of water, 10 per cent of Glaubersalt, 1 per cent of Orange ENZ, and 4 per cent of sulphuric acid. Dye a skein of woolen yarn in this bath in the usual manner, and wash and dry. Compare the color obtained on the two skeins by these methods.

Exp. 55. Dyeing of Alkali Blue.—The color-acids of a few of the acid dyes are insoluble in water, and therefore acid cannot be added directly to the dyebath, but must be employed in a separate bath. This method is represented in the application of Alkali Blue. Dye a test skein of woolen yarn in a bath of 300 cc. of water, 10 per cent of Glaubersalt, 1 per cent of Alkali Blue, and 2 per cent of borax. After boiling for twenty minutes, remove the skein, squeeze, rinse slightly, and pass into a fresh bath contain-

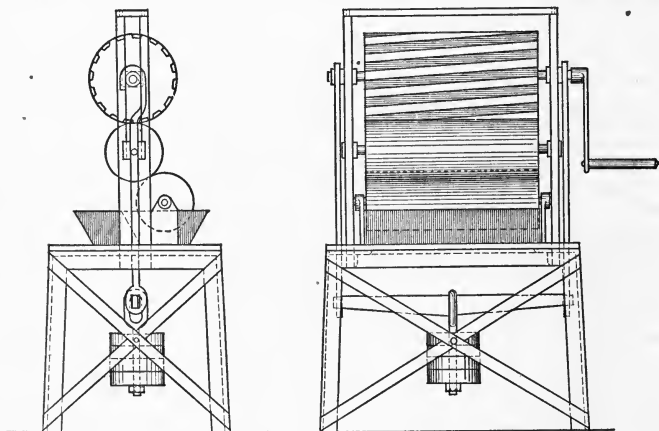

FIG. 135.—Printing Machine for Slubbing. (Vigoureux System.)

ing 300 cc. of water and 5 per cent of sulphuric acid; enter at 160° F., bring to the boil and continue for twenty minutes. Notice that the full blue color of the dye is not developed until the material is treated with the acid bath. Borax is a mild alkali, and is added to the dyebath for the purpose of insuring its remaining perfectly neutral. In place of borax, other alkalies may be used, such as 1 per cent of sal soda, or 2 per cent of ammonia water, or 5 per cent of sodium silicate. To show the effect of adding the acid directly to the dyebath, prepare a bath containing 300 cc. of water, 10 per cent of Glaubersalt, 1 per cent of Alkali Blue, and 4 per cent of sulphuric acid. Dye a skein of woolen yarn in this bath in the usual manner, and wash and dry. Compare the result with that obtained in the first method. Also notice that the addition of the acid to the bath causes the precipitation of the coloring matter. The color obtained with Alkali Blue may be brightened and at the same time rendered faster to fulling, by the addition of a small percentage of Victoria Blue B to the acid developing bath.

Exp. 56. Dyeing Acid Dyes on Acidified Wool.—Wool combines with acids with considerable affinity, and when so treated will dye with the acid colors without any

further addition of acid to the dyebath. Carbonized shoddy (recovered wool fiber treated with acid for the purpose of decomposing vegetable fibers), on this account, will generally dye more heavily than ordinary wool under the same conditions. Work a test skein of woolen yarn in a bath containing 300 cc. of water and 10 per cent of sulphuric acid, boiling for fifteen minutes. Then rinse in fresh water and squeeze. Dye this skein, together with one of ordinary wool, in a bath containing 300 cc. of water, 20 per cent of Glaubersalt, and 1 per cent of Formyl Violet 10 B. After dyeing wash well and dry. Then compare the two skeins for depth of color, and it will be found that the one treated with acid has been dyed much the deeper shade.

Exp. 57. Use of Acetic Acid in Dyeing Acid Colors.—Some of the acid dyes tend to go on to the fiber too rapidly if sulphuric acid is used in the bath, owing to the fact that the color-acid is liberated too rapidly and has a strong affinity for the fiber; hence uneven dyeings are liable to result. This fault may be avoided by using a weak acid, such as acetic acid, and not adding all of the acid at once but in several portions. To more thoroughly exhaust the bath some sulphuric acid may be added towards the end of the dyeing operation.* Prepare a dyebath containing 300 cc. of water, 20 per cent of Glaubersalt, and 1 per cent Sulphon Cyanine Blue, and dye a skein of woolen yarn as usual for twenty minutes, then lift the skein and add 2 per cent of acetic acid, and continue the dyeing for ten minutes. Lift the skein a second time and add 2 per cent of sulphuric acid and continue dyeing for fifteen minutes. Then wash and dry.

Exp. 58. Use of Phthalein Dyes.—These dyes are represented by the eosins and related coloring matters. They are applied in neutral or weakly acid baths, and give delicate red and pink shades which are characterized by a peculiar brightness and fluorescence. The shades may also be made more brilliant by dyeing on wool which has first been treated with alum. Prepare a bath containing 300 cc. of water, 10 per cent of Glaubersalt, and 1 per cent of Eosin, and dye a skein of woolen yarn in the usual

* There is a special group of acid azo dyes known as the Sulphon colors which are principally used for the dyeing of wool and which are applied in neutral or slightly alkaline baths. They form sort of a connecting link between the substantive dyes on the one hand and the acid dyes on the other, and are quite useful in the dyeing of mixed wool and cotton materials where substantive dyes are used, as they may be employed for shading the wool in the same neutral bath. They are mostly blue dyes and when dyed alone on wool they give shades that are quite fast to light, washing and even moderate fulling. In this case the Sulphon dyes are usually applied in a bath containing 3 to 5 per cent of ammonium acetate and 10 per cent of Glaubersalt; the goods are entered in the lukewarm bath, the temperature is gradually raised to the boil and kept at that point for one hour. Better exhaustion is usually obtained by adding a small quantity of acetic acid towards the end of the dyeing. In using these colors it is important that the bath does not become alkaline, otherwise bad results will be obtained. This is liable to happen in dyeing carbonized pieces which have been neutralized with alkali; such goods should be well acidulated before dyeing, otherwise the color will rush on too quickly. In order to increase the fastness of some of the Sulphon blues the dyeings may be after-treated with $\frac{1}{2}$ per cent of chrome and $\frac{1}{2}$ per cent bluestone. In this class of colors is included the Sulphon and Lanacyl dyes and such dyes as Pegu Brown and Toledo Blue. When dyeing with the Sulphoncyanines (also known as Coomassie Navy Blue) it is very important that the wool should be free from grease and soapy residues, as these colors are especially sensitive in this respect. They are sensitive to reducing agents yielding brown reduction products, and this reduction may take place in the dyebath in the presence of iron. To prevent this effect it is always advisable to add about $\frac{1}{2}$ per cent of chrome to the bath, which prevents the reduction and has no effect on the dyestuffs.

manner. Prepare a second bath containing 300 cc. of water, 10 per cent of Glaubersalt, 5 per cent of acetic acid, and 1 per cent of Eosin, and dye a skein of woolen yarn in the usual manner. Prepare a third bath containing 300 cc. of water, 5 per cent of alum and 5 per cent of tartar, and 5 per cent of acetic acid; boil a skein of woolen yarn in this bath for one-half hour, then lift and add 1 per cent of Eosin, and continue dyeing for twenty minutes. Erythrosine, Phloxine, and Rose Bengale also belong to this group of phthalein dyes. The tartar is used in the bath to aid in the decomposition of the alum.

CHAPTER VII

APPLICATION OF ACID DYES TO SILK, COTTON, ETC.

1. **Dyeing of Silk with Acid Colors.**—The three methods outlined under the experiments of this chapter describe briefly the general reactions of acid dyes with silk. In practice boiled-off liquor (or *bast soap*, as it is also called) is nearly always employed with the acid colors.* For the dyeing of 10 lbs. of silk skeins a dyebath is prepared with about 40 gallons of water and 10 to 15 gallons of boiled-off liquor. For most purposes the bath is acidified with an excess of sulphuric acid; that is to say, sufficient sulphuric acid is added to give a decidedly acid taste to the liquor. The acidity may also be tested with blue litmus paper, which should be turned red. Before the addition of the dyestuff the bath is heated to 100° F., any scum which may have formed is removed with a ladle, and then the silk is entered and given several turns. The skeins are then thrown up and the dyestuff solution added. The temperature is raised to 140° F., the silk re-entered and the dyeing continued to the boil. Each time the bath is heated the goods should be thrown up to avoid tangling. When the addition of sulphuric acid is not considered desirable, acetic, formic, tartaric, or citric acid may be employed.

A too-prolonged boiling of the bath should be avoided, as this is liable to damage the silk and dull the luster. When possible to obtain level shades it is advisable to keep the bath under the boiling point.† In

* Though the practice of using bast soap in silk dyeing is almost universal, the absolute necessity of its employment has been questioned. Ganswindt (*Theorie und Praxis der modernen Färberei*, 2d part, page 16) claims to have shown by practical tests that the results obtained without the use of bast soap are equally as good as those obtained otherwise, the luster and feel of the fiber being the same. Though the presence of the bast soap in the bath retards the velocity of the dyeing (which aids the penetration and evenness of the color), it also prevents a good exhaustion of the dyestuff, which is a drawback.

† In all cases of dyeing silk which is not twisted (or corded) it is advised to keep the dye liquor under the point of ebullition. This will prevent the fine silk fiber from becoming frayed and tangled. The influence of the temperature on the affinity of many dyestuffs for silk is also very marked; in many cases the dyestuff is taken up better by the fiber when the temperature is considerably under the boiling point, and may even be considerably stripped at the more elevated temperature. Some dyers consider it best to use temperatures between 140 and 180° F., the exact temperature being dependent on the dyestuff employed.

dyeing silk with the eosin dyestuffs an excess of acid should be avoided, just sufficient being added to give the bath a slightly acid taste, or so that the liquor no longer gives a froth. In this case the bath is spoken of as "broken," and is practically neutral in reaction, as it should affect neither blue or red litmus paper.*

When dyeing Alkali Blue on silk an alkaline bath is employed, the bath being prepared with about one-half the usual quantity of boiled-off liquor, and no acid is added. After dyeing the silk is rinsed and passed through a bath strongly acidified with acetic acid.

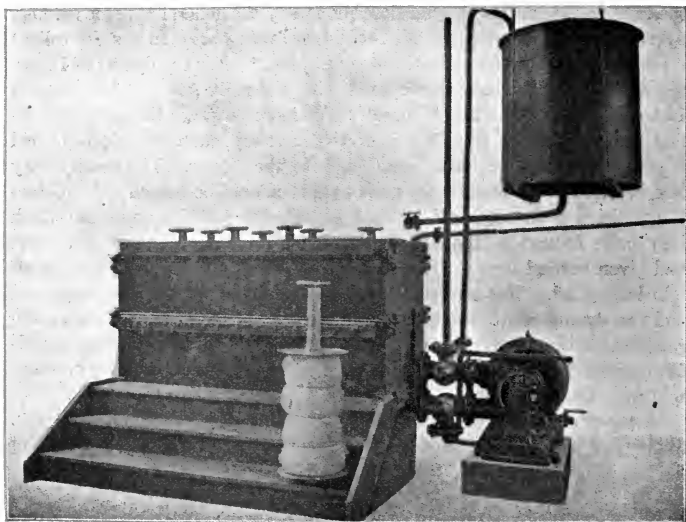

FIG. 136.—Dyeing Machine for Slubbing. (Obermaier.)

Tussah silk is usually dyed without the addition of boiled-off liquor, a little acetic or sulphuric acid being added. The boiled-off liquor from Tussah silk is not suitable for use in dyeing, as it contains too much impurity.

In order to obtain uniform shades in the dyeing of silk, it is frequently

* It is generally considered essential to add the acid to the bath first, and afterwards the soap solution or boiled-off liquor. This probably avoids the separation of fatty acid which might be induced by the contact of the stronger acid with the soap solution if the reverse procedure was followed.

necessary to add the dye solution in several successive portions and to raise the temperature of the bath very slowly.

Though boiled-off liquor (or its equivalent in soap) is nearly always used as an ingredient in the bath, it is not essential to the actual dyeing process. Silk may be dyed with the acid colors in practically the same manner as used for wool; that is to say, preparing the dyebath with dye solution and acid. The use of Glaubersalt is not to be recommended in silk dyeing as it appears to affect the luster of the fiber. Silk may be dyed quite satisfactorily in a bath with the addition of from 2 to 5 per cent of acetic acid, entering the goods at 140° F., gradually raising to 200 to 205° F., and maintaining at that temperature for one-half to one hour. After dyeing, rinse off in fresh water and "brighten" by working in a very dilute bath (about 1 per cent) of acetic or tartaric acid; squeeze well and dry without rinsing. This process of so-called "brightening" is for the purpose of increasing the luster and giving a "scroop" to the fiber.* The drying of the small amount of the organic acid into the fiber appears to give this result without injury to the material.

In its relation to acid dyes, silk differs somewhat from wool in that the dye appears to be taken up better at a temperature somewhat under the boil. This difference is made use of in the dyeing of wool and silk mixed goods by employing a boiling bath with the addition of a relatively small amount (2 per cent) of acetic acid; under these conditions the color will feed almost exclusively onto the wool. The silk may be dyed subsequently in another shade if desirable by using a fresh lukewarm bath with the proper dye.

As previously mentioned, silk does not exhibit the same affinity as wool for the acid dyes, and as a consequence, they show less fastness to washing on silk. Some of the acid colors, in fact, are removed from silk by washing in plain water. This must not be taken, however, as a general rule, as there are quite a number of acid dyes which produce colors on silk of very satisfactory fastness to washing. The fastness to light and other conditions is generally about the same on silk as on wool.

The use of boiled-off liquor or "bast" soap in the dyeing of silk has perhaps several functions: (a) it acts as a regulator in the dyeing process, retarding the absorption of the color and giving more regular and better penetrated dyeings; (b) it prevents loss of weight in the silk, especially if there is much silk-glue still left on the fiber; (c) it adds to the softness and luster of the dyed silk.

In the dyeing of spun silk it is not so customary to use the boiled-off liquor, the yarns being dyed simply in the ordinary acid bath. Spun silk should also be "brightened" with acetic or tartaric acid.

* In the case of dyeing light shades where the dyebath is practically exhausted, instead of using a separate "brightening" bath, the goods coming from the dyebath may simply be wrung out and dried without washing.

The fastness of the acid dyeings on silk may be somewhat increased by an after-treatment with tannin or by an after-treatment with aluminium acetate.

The acid dyes are principally used on silk for the production of fancy colors, the black acid dyes, though largely used on wool, have but little use on silk, as it is not possible to produce as satisfactory a black with them as with Logwood. The black acid dyes do not seem to properly fill the fiber so as to make it opaque to light, in consequence of which the color exhibits a slaty appearance, while with Logwood (by reason of the relatively large amount of pigment mordant employed) the fiber is rendered opaque and the color produced is a full rich black. Furthermore, by dyeing with Logwood and suitable mordants, a considerable amount of weighting may be added to the silk.

2. Notes on the Weighting of Silk.—In the boiling-off of silk when all of the silk gum is removed there is a loss in weight of about 22 to 25 per cent; that is to say 1 lb. of raw silk will yield only about 12 ozs. of boiled-off silk. In order to make up for this loss the dyer is usually required to weight the silk with suitable materials so as to bring the weight of the dyed product back to the original weight of the raw silk. This is called the "par" weight, and the silk is not considered as really weighted at all. But very frequently a great deal more weighting material is added than that necessary to bring it back to par, and the weighting may run as high as 50 to 100 per cent, and even at times to as much as 300 per cent. In par silk the actual amount of weighting for 12 ozs. of real silk is 4 ozs., so as to bring it back to 16 ozs. or 1 lb. If the dyer is required to weight the silk 50 per cent above par, it is intended that for 1 lb. of raw silk he receives he should deliver $1\frac{1}{2}$ lbs. of dyed silk; but as 1 lb. of raw silk represents only 12 ozs. of actual silk, and as this is brought up to 24 ozs. there is actually added 12 ozs. of weighting material, or an amount equal in weight to that of the silk itself. Silk weighted to this extent is known as 24 oz. silk. The customary weighting of silk for ordinary purposes is from 24 to 28 ozs., and by this is meant that 1 lb. of raw silk is brought up to this weight by the dyer.

There are two general methods of weighting silk, (a) for blacks, and (b) for white or fancy colors. When weighting is done for black dyed silk the materials employed are tannins and iron salts. The silk is nearly always weighted in the form of skein yarns as this is the most suitable form with which to operate. The boiled-off silk is steeped in a rather strong bath of cutch, gambier, or other suitable tannin. As the silk fiber is particularly reactive towards solutions of tannin, it readily absorbs the tannic acid from solution, and the silk becomes charged with a considerable proportion of tannin. The skeins are then squeezed and passed into a bath containing nitrate of iron (which is really a basic sulphate of iron, and so called by reason of it being made by the action of nitric acid on fer-

rous sulphate). This precipitates tannate of iron in the fiber, which is of a dark gray or black color. A treatment with yellow prussiate of potash is also given so as to furnish a precipitate of Prussian Blue. This gives a pleasing bluish tone to the finished black and also adds to the weighting. A treatment with a weak alkaline bath or soap is also given in order to complete the precipitation and fixation of the iron compounds and to neutralize any excess of tannic acid. These treatments are repeated several times, depending on the degree of weighting desired; usually each treatment adds from 12 to 20 per cent of weight. After the weighting processes have been completed, the silk is dyed with Logwood, to which is added some Fustic (for the purpose of obtaining an intense jet black). Black

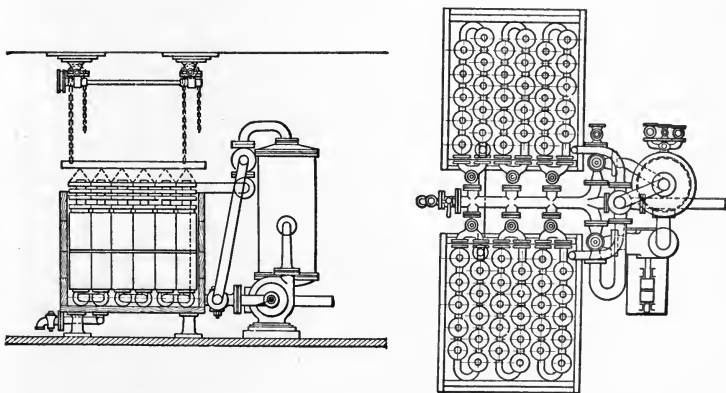

FIG. 137.—Card Sliver Bleaching Machine. (Pornitz.)

silks are usually weighted more heavily than fancy colored silk, and 36 to 40 oz. silk is often produced by the dyer.

When the weighting is for silk that is to be left white or is to be dyed in fancy colors, naturally the tannin and iron method cannot be used on account of the dark color of the weighting material. In order to obtain a weighting which gives practically no color to the silk it is customary to use stannic chloride. The silk has a strong affinity for this compound and takes up the tin quite readily, and the latter is fixed in the fiber by washing in water containing lime. The silk skeins are treated with a stannic chloride (SnCl_4) solution of about 50° Tw. cold. For this purpose the silk is packed in a rubber-lined hydro-extractor and the tin solution (known in the dyehouse as "dynamite") is run in. The liquor is forced through the fiber very evenly by the rapid motion of the hydro-extractor and at the same time the excess of liquor is removed. The silk is then well washed

in water containing some lime in solution. Or it may be washed with a dilute solution of sodium phosphate. This causes the fixation of the tin in the fiber as a stannic hydrate (or as a basic phosphate). Care must be taken to conduct the tin treatment at a low temperature (about 40 to 50° F.) which is usually accomplished by having the tin treatment carried out in a suitable room provided with artificial refrigeration, so that a constant low temperature may be maintained irrespective of the atmospheric temperature. It is also necessary to remove thoroughly all of the acid radical (the hydrochloric acid) from the tin combined with the silk. The tin chloride on treatment with water is decomposed into tin hydrate and hydrochloric acid. The latter is washed out and is further neutralized by the lime or sodium phosphate that is used with the water. If any residues of the acid are left in the silk the fiber will develop tenderness and gradually become rotten, or show so-called "burnt" places. By conducting the operations with proper care and by maintaining constant conditions it has been demonstrated that tin-weighted silk is not weakened and does not show any degree of deterioration even over long periods of time. One tin treatment usually adds from 20 to 25 per cent of weight, and higher weighting may be obtained by repeating the treatments several times. Silk weighted in this manner with tin may be dyed delicate light shades or may be left as a white fiber. For the latter purpose a bleached silk will have to be used. The tin weighting does not interfere with the subsequent dyeing operations; in fact the tin acts as a mordant for many of the dyes and gives faster colors than would otherwise be the case.* The tin weighting also adds to the luster of the silk as well as to the body of the fiber; it also gives it a good firm feel and allows of a high degree of "scroop" being imparted to the silk.

3. Dyeing Cotton with the Acid Dyes.—The acid dyes have little or no direct attraction for cotton or vegetable fibers in general and on this account they have a very limited use in this field of dyeing. There are cases, however, where the acid dyes are used on cotton, and among them may be noted dyeings for upholstery and drapery fabrics or such materials that require colors having fastness to light but no especial requirements as to fastness to washing.† As cotton is very inert chemically, and as it is presumed that the attraction of the animal fibers for the acid dyes is due to the basic properties of these fibers, it would be reasonable to expect

* When dyeing acid colors on tin-weighted silk difficulty may at times be experienced in obtaining even shades owing to uneven or defective weighting. Also some acid dyes have a much lessened affinity for weighted silk, the tin salt acting as a resist to the dye.

† The Croceine Scarlets and other such azo compounds obtained from beta-naphthol sulphonic acid B, gamma acid, or alpha-naphthol disulphonic acid Sch, are used considerably for this class of dyeing, as the colors have a greater fastness to light than the benzidine dyes, and furthermore are not sensitive to acids.

that if cotton were mordanted with a basic mordant it would then be capable of being dyed with the acid colors.* We find this, in fact, to be the case. If the cotton material is mordanted with suitable metallic oxides (bases), it will combine with the acid dyes. Alum is the principal metallic base used in this connection, chiefly on account of the fact that the salt is readily dissociated in such a manner as to liberate the acid (sulphuric acid) and precipitate the base (alumina, Al_2O_3), within the fiber. Unlike wool, cotton exhibits very little chemical activity towards solutions of metallic salts, and therefore only a few of the more readily dissociated salts (such as alum) are available for use in the direct mordanting of cotton. Alum is also suited to this purpose by reason of the colorless quality of the base, so that the color of the resulting dyeing is not affected.

In a few cases the acid dyes are used on cotton without a mordant, simply using the dye solution itself for impregnating the fiber. In such a method of dyeing, it is necessary to use as short a bath as possible, and common salt is added until the bath stands at 5 to 7° Tw. The dyeing is done in a hot solution (160 to 180° F.) and the goods are simply wrung out and dried without washing. Only pale shades may be dyed in this manner, and the colors, of course have no fastness to washing, nor are they as fast to light as those produced with a metallic mordant.

The usual procedure in dyeing the acid colors on cotton is to make up the dyebath with the required dye solution and the least amount of water as possible; alum (10 to 20 per cent) and either glauber salt or common salt (20 per cent) is also added. The goods are dyed at about 180° F. for an hour, squeezed or wrung out as evenly as possible, and then dried without rinsing. As the dyebath exhausts but poorly it should be used as a standing kettle for the dyeing of succeeding lots of goods.†

* It has been suggested to "animalize" the cotton by coating it with gelatine or albumin. Experiments have been made by first treating the cotton with tannic acid and then with a solution of gelatine, the latter combining with the tannin to form an insoluble compound. Also treating the cotton with a solution of albumin and steaming has been suggested. The albumin or gelatine mordant thus obtained will dye with the acid colors. None of these processes, however, has any practical value. If cotton is treated for several hours with strong nitric acid it also shows an affinity for acid colors; but here the fiber is probably changed to a nitrated body.

† The following recommended processes are also representative of this method:

(1) Enter the previously soaped cotton material in the dyebath containing the acid color and 3 to 4 per cent of alum, and dye lukewarm (Bayer).

(2) Dye in as short a liquor as possible containing the dyestuff together with 4½ ozs. of alum and 2 lbs. of glauber salt per 10 gallons of liquor. The quantity of dyestuff is dependent on the depth of shade required; the first bath should be charged with considerably larger quantities of dyes than the subsequent baths, for example,

	First bath.	Subsequent bath.
For dark shades.....	10%	2% dye
For light shades.....	3%	0.5% dye

Enter the cotton at 120 to 140° F. and without further heating dye in the cooling bath. Then squeeze out and dry without rinsing (Cassella).

Depending on circumstances and the character of the dyestuff employed this method may be varied in several ways. The cotton may be first

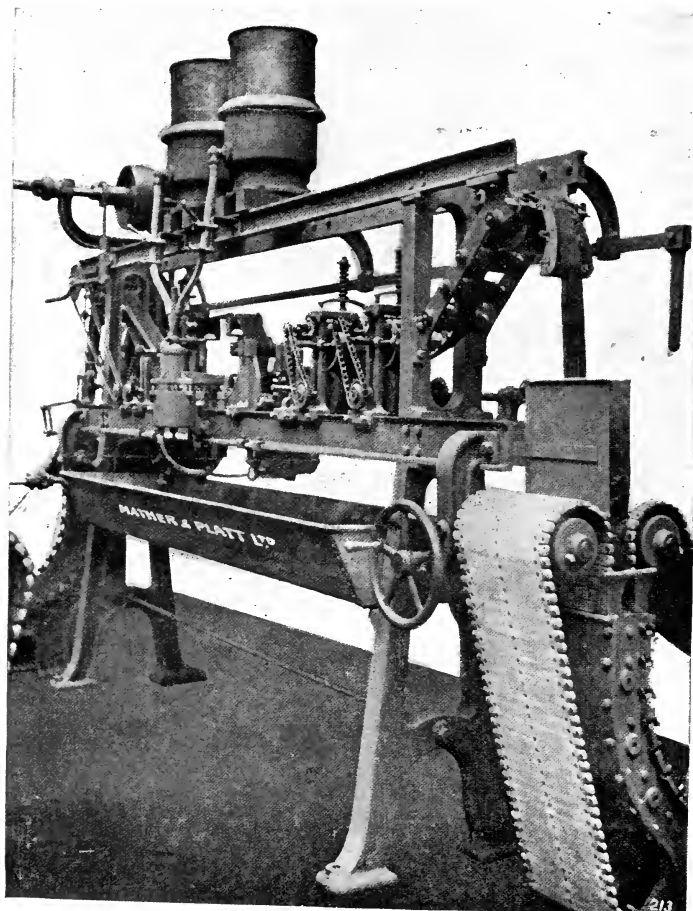

FIG. 138.—Dyeing Machine for Sliver. (Mather & Platt.)

impregnated with a solution of soap containing also a small amount of gelatine; the goods are squeezed out and then entered in the dyebath

which is made up with 10 per cent of alum and 20 to 40 per cent of common salt. In another method the cotton is first mordanted with a basic solution of alum prepared by dissolving 1 lb. of alum and $\frac{1}{2}$ lb. of soda ash in 20 gallons of water. The goods are worked in this bath hot for a short time and then laid down in the liquor and steeped for four to five hours. Squeeze and dye in a separate dyebath at 160° F. A method by which colors faster to washing may be obtained is to first treat the cotton with tannin and then mordant with alum. The tannin is rather easily taken up by the cotton and seems to fix the alum mordant by forming an insoluble tannate of aluminium. Enter the cotton in a boiling bath containing 4 per cent of tannic acid; work the material for a short time and then steep in the cooling bath for two hours. Squeeze, and pass through the mordant bath of alum and soda ash prepared as above, rinse slightly and then dye as usual.

A tin mordant may also be used on cotton, as this gives a colorless base for combination with the acid colors. The goods are steeped at 140° F. in a bath containing $\frac{1}{2}$ lb. of stannate of soda to 20 gallons of water; squeeze and steep for two hours in the alum bath prepared as above, then afterwards dye as usual. The tin mordant may also be used by first steeping the goods in a soap-gelatine bath (10 per cent of soap and 5 per cent of gelatine) at 140° F., then treating for one-half hour in a cold bath containing 10 per cent of stannic chloride (SnCl_4); squeeze, treat with the basic alum bath, and then dye as usual.*

In cases where the dyestuff used forms insoluble precipitates with alum (Biebrich Scarlet, Fast Red A, etc.), it is advisable to give the alum-mordanted cotton a slight rinsing before entering the dyebath, otherwise the dyeings may be streaky and will crock badly. A small quantity of acetic acid should also be added to the dyebath.

The rather special group of acid dyes including Water Blue (Soluble Blue) and the water-soluble indulines and nigrosines is sometimes used in cotton dyeing. They may be either dyed direct by the alum and glauber-salt method or on a tannin-antimony mordant as described in the application of basic dyes. Very bright shades of blue may be obtained in this way which have good fastness to light but little or no fastness to washing. Soluble Blue is also used as a tinting blue in the bleaching and laundering of cotton goods.

* Modifications of this process are as follows:

(1) Allow the previously boiled-off cotton material to lie for two hours (or better yet, overnight) in a bath containing sodium stannate at 6 to 7° Tw.; wring out and pass through a bath containing 15 to 20 per cent of alum (or 7 to 10 per cent of aluminium sulphate) and 2 to 3 per cent of soda. After a couple of hours wring out or rinse, and dye lukewarm (Bayer).

(2) Treat the cotton for one hour in a solution of stannic chloride 7 to 10° Tw., wring out and pass through a bath containing aluminium acetate 6° Tw. for one to two hours. Then rinse and dye in a lukewarm bath (Bayer).

The eosin group of acid dyes is also used to a limited extent in cotton dyeing for the production of bright and delicate print colors. These dyes are applied in as short a bath as possible with the addition of 30 to 60 per cent of common salt; run for three-fourths hour at 100° F., then wring out and dry without rinsing. A starting bath will require 2 to 10 per cent of dyestuff, as the exhaustion is very poor; but subsequent dyeings in the standing bath will need only the addition of about one-fifth this amount of dye. A better quality of bright pink shades with these dyes may be obtained by using a mordant of Turkey-red oil. This method is usually applied to yarn in the following manner: the skeins are steeped in lots of 1 lb each in a liquor consisting of one part of Turkey-red oil and two parts of water. The yarn must be evenly impregnated and

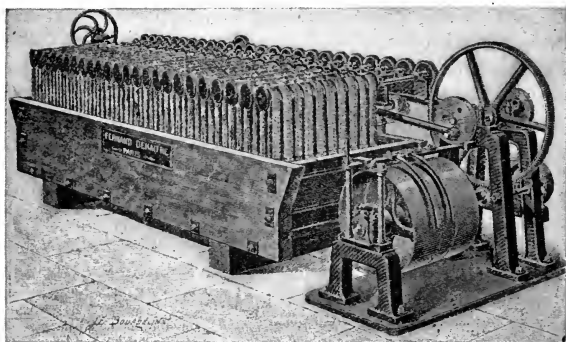

FIG. 139.—Skein Dyeing Machine. (Dehaitre.)

squeezed (this is usually done in a special apparatus), and then dried. Generally the mordanting operation is repeated several times. The yarn is then dyed in a short cold bath with the addition of a little acetic acid. This method gives a bright fluorescent pink on bleached cotton that can be obtained in no other manner.

4. The After-chromed Acid Dyes.—A number of the acid dyes may be after-treated with solutions of metallic salts, either for the purpose of developing them or of making the dyed color faster to light and washing. Chrome is the chief salt used for this purpose, though bluestone is sometimes used also.* The action of the chrome on these dyes may be in two

* An example of the use of bluestone is in the dyeing of Naphthylamine Black; in this case the dyebath is charged with 1 per cent of oxalic acid, 5 per cent of acetic acid, 10 per cent of Glaubersalt and the required amount of dye. After dyeing for one hour at the boil, add 3 per cent of bluestone and continue for one-half hour.

ways (a) to oxidize or otherwise develop the color, as with the chromotrop dyes and Azo Rubine; in which case the chroming generally alters the shade of the dyed color very considerably, as for example from a red to a black; (b) to form a color-lake with the acid dye after the manner of the mordant dyes. The latter class really falls under the mordant colors, for in the practical application of these dyes, the acid-dyed color is not used, but the operation is always carried on to the after-chroming before the dyeing is considered finished. Representative dyes of this class are Diamond Black, Chrome Black, Cloth Red, Anthracene Brown and Alizarine Yellow GG. It is always a doubtful question whether to consider these dyes under the division of acid colors or under the mordant dyes. As they are all azo dyes, however, and as they are dyed in acid baths and give more or less satisfactory colors even when considered solely as acid dyes without a subsequent chroming, it may perhaps be proper to treat them under the consideration of acid dyes.

But, on the other hand, the useful colors which they furnish are only those which are obtained by using a true mordant to form an actual color-lake, and on this account they should be regarded as mordant dyes in the true sense. The methods of dyeing also tend to have these dyes considered under the group of mordant colors, therefore a discussion of their use will be postponed until the group of mordant dyes is considered.

The chromotrop dyes are so-called because they are obtained from chromotropic acid combined with various diazo bases. They are almost exclusively used in wool dyeing. The colors produced by direct dyeing in an acid bath are mostly reds and bluish reds, and though these colors may be used as such, they are not of much importance owing to their lack of fastness and due to the fact that the same colors may be obtained by the use of cheaper dyes. By after-treating with chrome, however, dark blue to bluish black colors are obtained which have a high degree of fastness and are very desirable colors. The dyeing is carried out in the usual manner in a bath containing 10 to 20 per cent of Glaubersalt and 4 per cent of sulphuric acid, and boiling for one hour. After dyeing, the goods are lifted out, the dye liquor cooled off somewhat, and $1\frac{1}{2}$ to 2 per cent of chrome and 1 per cent of sulphuric acid are added, the goods are re-entered and color developed by boiling for one hour. The colors thus obtained are very fast to light, washing, acids, alkalies, and moderately fast to fulling. The fastness to fulling is said to be improved by adding 3 per cent of lactic acid with the chrome.

5. On the Proper Storage of Dyestuffs.—Dyestuffs should be kept in a cool dry room, and any barrels or tins which have been opened should be kept well covered up, otherwise one color may become contaminated by dust from another dye; also the dyestuffs are liable to absorb moisture from

the air. The absorption of moisture may cause the dyestuff to cake together and become difficult to dissolve, and besides the dyestuff will alter its weight by the amount of moisture absorbed. Steam from the dyehouse should be carefully excluded from the drug room in which the dyes are stored. Dyestuffs in the form of pastes should always be well stirred up before weighing out and should be kept from exposure to the air, otherwise the water of the paste will evaporate and the dyestuff will alter very materially in its strength. Paste dyes are usually of 20 per cent strength; that is, they contain 20 per cent of actual dyestuff, the rest being water.

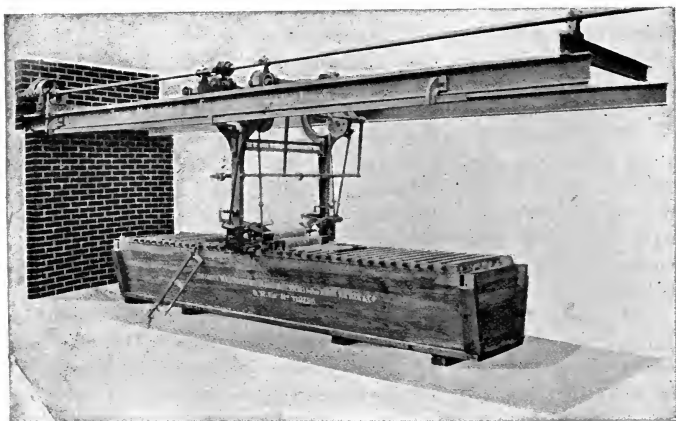

FIG. 140.—Skein Dyeing Machine. (Zittauer.)

Paste dyes in barrels should be protected with a suitable tightly fitting cover on the inside of which is a dampened cotton cloth. This will tend to prevent the evaporation of moisture from the paste and thus preserve its normal strength. Paste colors should also be preserved from freezing, as this may cause alteration in the properties and strength of the dyestuff. Dyestuffs should never be stored or weighed off in the dyehouse proper or in any place where the goods to be dyed are directly exposed, as dust from the colors may cause mysterious spots on the goods.

6. Dissolving of Dyestuffs.—The proper solution of dyestuffs is an important factor in obtaining good results in dyeing, both with respect to the testing of dyes and in their practical application on a large scale. The solubility of dyes varies considerably depending on the nature of the particular dye, but even for the most difficultly soluble dyes about

200 to 250 parts of water are generally ample to effect a good solution; and in cases where the dye is readily soluble, from 10 to 50 parts of water is sufficient.* The solubility of the dye also depends on the kind of water used; pure soft water should always be used wherever possible, and if hard water alone is available it should be corrected by the addition of a small amount of acetic acid (about $\frac{3}{4}$ oz. of acid of 9° Tw. to 100 gallons of water for each 10° of hardness in parts per million) sufficient to give the water a slight acid reaction with litmus paper.

Dyestuffs should always be well dissolved before adding to the dye-bath, and in most cases the solution should be strained through a fine sieve or cloth in order to remove insoluble matters or undissolved specks of dyestuff. Generally speaking boiling water is used for dissolving dyes, though there are certain cases where a lower temperature should be used. In the case of many basic dyes, such as Methyl Violet, Malachite Green, etc., it is best to first stir up the dyestuff with a little cold water to which a small amount of acetic acid has been added, and then dissolve in boiling water.†

In dissolving colors in the dyehouse, it is often the practice to put the dyestuff in a wooden bucket, pour cold water over it and then boil up by introducing steam through an open pipe. Under these circumstances it frequently happens that the live steam of a high temperature coming in direct contact with the dry dyestuff will cause decomposition, leading in some cases to the formation of highly insoluble sticky, tarry products which may cause considerable trouble in dyeing. The proper procedure should be to mix the proper amount of boiling hot water with the dyestuff and dissolve with good stirring.

Some of the acid dyes ‡ are better dissolved by the addition of a little sulphuric acid to the water; but in dissolving Alkali Blue or Water Blue, a small quantity of soda ash or borax should be added, especially if the water used is at all hard. For the phthalein dyes like Eosin, Rose Ben-

* In general it may be said that for difficultly soluble dyes $\frac{1}{2}$ lb. may be dissolved in 10 gallons of water, and for ordinary dyes about 2 lbs. may be dissolved in 10 gallons of water.

† A few colors like Auramine should not be dissolved in boiling water, as the color is partially decomposed; such colors should be dissolved at about 160 to 180° F.

‡ The acid dyes, as a rule, are quite soluble in water, and can usually be dissolved in about twenty-five to fifty times their weight of water. With acid dyes the use of hard water is not so injurious, as sulphuric acid is added to the bath and this will effectively prevent the formation of any insoluble lime-lake of the coloring matter. The acid dyes may be dissolved in boiling water without danger of being decomposed at that temperature. In general it may be said that the more sulphonic acid groups present in the acid dyestuff, the more soluble it will be. The acid dyes may be dissolved in copper or tinned copper vessels but in this case no addition of acid should be made while dissolving, as many of these dyes are reduced by stannous salts, such as would be formed by contact of the acidified solution with the tin.

gale, etc., the water should first be boiled up with a little soda ash, and after settling the clear liquor should be used for dissolving the dye.

In dissolving substantive dyes the water should be made slightly alkaline with a little soda ash. The sulphur dyes are quite insoluble in water and require to be dissolved in a solution of sodium sulphide or caustic soda. Generally the amount of sodium sulphide required is equal to that of the dyestuff, though in the case of highly concentrated dyes (sulphur blacks) twice the quantity of sodium sulphide may be necessary.

In the use of standing baths it may at times be found that the dyestuff becomes partially precipitated. This may be caused by impurities in the water or by impurities introduced by the materials being dyed, such as soapy residues, pectin matters of cotton, etc. Or the precipitation may be due to the gradual accumulation of too much salt in the bath. It may be dangerous to use such old baths for further dyeing, as the colors so obtained may show lack of fastness to rubbing or washing and defective and spotted goods may result.

Some dyes require special precautions and methods for solution, and attention will be called to these when such dyes are under consideration.

It is a bad policy to dissolve the coloring matter directly in the dyevat itself, as undissolved parts may adhere to the pipes or sides of the vat, or portions of the dyestuff may be decomposed by contact with the live steam or the superheated pipe. An enameled pail is an excellent vessel for the dissolving of dyestuffs. If a wooden bucket is used, the wood will absorb a considerable quantity of the concentrated dye solution, and unless it is used continually for the same dyestuff, succeeding solutions will be shaded and discolored by the bleeding out of the preceding color. Frequently the exhausted liquor of a preceding dyebath is employed for dissolving a fresh amount of dyestuff. This, however, may sometimes lead to bad results owing to the acid character of the liquor or to the presence of salts, so when this method is used it should be ascertained if the dyestuff employed is injured by such a treatment.

In certain cases stock solution of dyestuffs are prepared of definite strengths, and the dyer uses these by measuring off certain volumes from time to time as required. These stock solutions should be of sufficient dilution to insure the complete solution of the dyestuff employed. It should also be borne in mind that a number of dyestuffs, though perfectly dissolved in a hot solution, will crystallize out on cooling, and furthermore many dye solutions deteriorate on prolonged standing, hence a reasonable degree of caution must be exercised in the preparation and maintenance of stock solutions.

7. Action of Metals on Dyestuff Solutions.—Dyevats and apparatus are generally made of wood, but there are forms of dyeing machinery employing metal in contact with the dyebath. This is frequently copper

or bronze, and there are certain dyes which are quite sensitive to these metals. Usually the action of copper in this connection may be prevented by hanging a piece of zinc in the bath, or by the addition of a little ammonium sulphocyanide. Sulphur dyes, being dissolved with sodium sulphide, cannot be used in contact with copper, brass, or bronze metal, so wood or iron dye vessels must be used. In some forms of dyeing machines (such as cop machines where perforated spindles are used) the metal parts are made of nickel or monel metal.

8. Apparatus for Dyeing.—Yarn is mostly dyed in suitable wooden vats, the skeins being suspended in the vats from wooden sticks.* Many

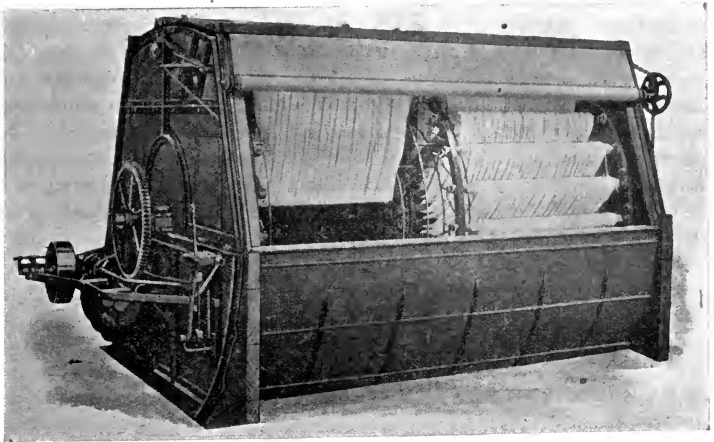

FIG. 141.—Skein Dyeing Machine; Revolving Type. (Klauder-Weldon Dyeing Machine Co.)

dyes are more or less sensitive to the action of metals, though in many cases bronze or copper surfaces may be in contact with the dyevat without injury to the color. Silk is frequently dyed in copper vats.† The sensitiveness of most dyes to copper may be avoided by the placing of strips

* These sticks are generally of birch, maple, or fir when used for wool or cotton. When silk skeins are dyed, however, it is better to use sticks of polished willow, though bamboo sticks are also excellent.

† On account of the fineness of the silk fiber and its liability to become frayed and broken by rubbing against the sides of wooden vats, it is customary to employ copper vats. It is possible to use wooden vats, however, for both boiling-off and dyeing silk if they are lined on the inside with canvas; this will present a smooth surface to the silk fiber and prevent it being frayed by catching in the fine splinters always present in the wooden vats.

of zinc in the vat or by the addition of ammonium sulphocyanide. Yarn may also be dyed on machines, where the hanks are turned mechanically. Loose wool is frequently dyed by poling in large round copper vats; it may also be dyed in rotating machines. Cloth is generally dyed in vats, being turned by means of a revolving winch; or it may be dyed on a jigger, consisting of two sets of rollers which roll the cloth on and off through the dye liquor. Warps are also dyed by machine. Yarn may also be dyed in cops by means of suitable machines so devised as to force the dye liquor through the cop by pressure or suction.

9. Apparatus for Dyeing Cotton Yarn.—Wooden vats are generally used for dyeing cotton in the form of hanks, and they are usually constructed to hold 50 or 100 lbs. It is seldom they are made larger or smaller than this for practical work. During the dyeing process the hanks are hung on smooth rods, so that only about one-fourth of their length is above the dye liquor. The yarn is turned by hand, or a stick may be used, in which case a pointed stick which is thinner than that on which the yarn hangs, is passed through the hank below the other stick, and the yarn is then raised with it and turned. The vats must be so constructed that the yarn can be easily turned without too much water being required in proportion to the cotton. The following are suitable internal dimensions:

For 50 lbs. yarn	{	length, 64 ins.
		breadth, 22½ ins.
		depth, 23½ ins.
For 100 lbs. yarn	{	length, 118 ins.
		breadth, 22½ ins.
		depth, 23½ ins.

The dye liquor is heated by a steam coil which may enter the liquor at the top end of the vat. If the vats are long, two coils may be used, one from each end, but if short, one coil will be sufficient. These coils are closed at the ends, but the sides are suitably perforated with small holes, and it is best to fix them on to the steam pipe with a union joint so they may be removed from the vat if necessary. The steam coil should lie under a perforated false bottom of wood, so as to prevent the yarn from coming in direct contact with the hot pipe, and also so that the force of the escaping steam may be broken and disseminated and not tangle up the yarn. In some cases, the pipe is fitted behind a perforated wooden partition which stands 4 to 6 ins. from the top end of the vat, and which is a little lower than the latter. This arrangement offers certain advantages, as solutions of dyestuffs, etc., may be poured into the space behind it during the dyeing process and gradually distributed through the liquor without having to remove the yarn. To let the liquor run off after dyeing, it is best to have the vat fitted with a valve which can be opened by turning

a handle from the outside. The old method of having a plug to be drawn is bad, as the workmen are liable to be scalded. The rods on which the yarn is hung should be hard straight sticks of hazel, ash, etc., from which all knots are removed so that no rough places are left.

Besides the vat method of dyeing, cotton yarn may be dyed by machines; in one form a vat is used as with hand dyeing, but the sticks are turned mechanically by a system of interacting cogs. In another form, such as the Klauder-Weldon or Giles machine, the rods are arranged on a circular spider frame rotating in a semicircular vat, the sticks also being turned mechanically as the frame rotates; in this method, only one-half the load of yarn is in the liquor at any one time, so that economy in the amount of dye liquor is effected; the yarn is also kept out straight by being more or less stretched between the rods, which prevents tangling.

Another method of machine dyeing, which has come into practice of late, and which may also be employed for yarns, though it is mostly used for cops, bobbins, etc., is where the material is tightly packed in a chamber of metal fixed to a suction tube and pump; the cotton remains stationary and the dyeing is effected by forcing the heated liquor through the material.

Cotton yarn is also largely dyed in the form of prepared warps, in which case a special warp-dyeing machine is used, the warp or chain running over rollers up and down through the vat several times, then through squeeze rollers; if necessary several runs are made through the machine to obtain the desired shade. In the latter case, the machine may consist of several compartments each provided with squeeze rollers, and the yarn is run through each compartment successively.

10. Apparatus for Dyeing Woolen Yarn.—This material is usually dyed in wooden vats similar to those just described for the dyeing of cotton yarn. It must be borne in mind, however, that for woolen yarn dyed on sticks in large vats there will be required about 300 to 450 gallons of water for 100 lbs. of yarn, depending on the nature of the material. In general the yarn is entered into the hot acid dye liquor (in the case of acid dyes) and is dyed for one and one-half to two hours at the boil. About 2 to $3\frac{1}{2}$ lbs. of yarn are placed on each stick, and for a 100-lb. lot four men are generally employed in turning at the beginning, but later only two men are required. The yarn must not be turned more often than is necessary to obtain even colors, otherwise the fibers will become felted. From time to time the position of the sticks should be changed, that is, those in the middle of the vat should be moved to the ends, and so on. On a first kettle when dyeing woolen yarn it is usual to add a rather large quantity of Glaubersalt, often as much as 50 lbs. on a 100-lb. vat, this being a great help toward the production of level dyeings. On subsequent dyeings in the same vat only 5 lbs. of Glaubersalt need be added. As a rule, old dye liquors cannot be used for longer than a week; though there are exceptional cases where they may be

used continuously for several months. Usually, the shades on woolen yarn are not perfectly level at the beginning of the process; but the color should distribute itself evenly after being boiled for sometime; generally, the dyeings should be perfectly level a quarter of an hour after the color solution has been added to the bath.

Woolen yarn may also be dyed in suitable machines similar to those used for cotton dyeing, the rotating spider form of machine being used extensively in this country, England, and Germany. This is especially true for fine worsted yarns, or in fact any kind of yarn which is easily matted or tangled; in such cases it is almost impossible to obtain satisfactory results by dyeing by hand in open vats on sticks, as the motion of the yarn and the boiling of the bath, especially if live steam is used for heating, cause a great felting and tangling of the threads. Such yarn is best dyed in a revolving machine, where the hanks may be stretched out and preserved in a straight condition throughout the dyeing operation, and no felting will result. Yarn which is liable to curl up, due to tight twist, should be scalded before washing or dyeing; this may be done by twisting the hanks together tightly and laying them in boiling water for a couple of hours, then allowing them to cool before untwisting. In using the revolving machine for dyeing or scouring, this previous scalding will be superfluous, as the yarn will naturally undergo this operation when stretched in the machine during the dyeing process itself. With such yarns, however, the hanks should not be unstretched until they have passed through cold water or have cooled down.

11. Apparatus for Dyeing Silk Yarn.—Small lots of silk yarn are usually dyed in copper boilers, and larger lots in copper or copper-plated vats. These are usually mounted on wheeled frames, so that, with the exception of the long heavy vats, they may be conveniently moved about the dye-house. This arrangement is a desirable one, as the dyer requires to use larger or smaller vats according to the quantity of silk which has to be dyed at one time. As the vats are often used for the most varying shades, it is necessary to frequently cleanse them thoroughly. For this purpose they may be first boiled out with old boiled-off liquor, or the inner sides may be thoroughly scoured with a hot strong solution of soda ash. After this has been run out, the vat is rinsed with water and then cleansed again with dilute sulphuric acid, and finally rinsed out again with water. The larger vats, which are stationary, are generally heated with a steam coil placed under a perforated false bottom; for the smaller vats, usually movable steam pipes are inserted. These steam pipes should be fitted so as to turn in a ball-and-socket joint so that they may be moved around in any direction. The silk is hung in hanks on smooth rods in the same manner as wool or cotton, about $\frac{1}{2}$ lb. of silk being distributed on each stick. Silk may also be dyed in machines, the chief form in this country being the

revolving spider type, for which purpose a special machine is constructed. The spider is so arranged that at any time the entire lot of yarn may be raised out of the liquor.

12. Influence of the Water Employed in Dyeing.—Water as employed in the dyehouse for the preparation of vats and the solution of the dyestuffs and various chemicals is generally obtained either from a river supply

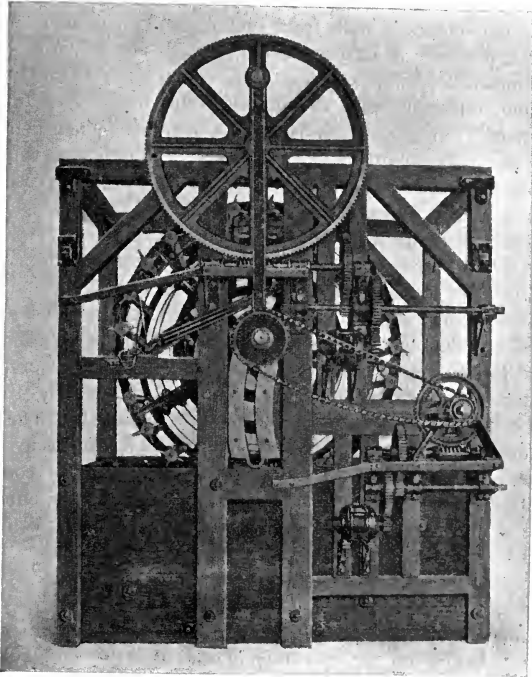

FIG. 142—Skein Dyeing Machine for Silk with Automatic Hoist. (Giles Dye Machinery Co.)

or from a well or spring. Rain-water is sometimes collected and employed for purposes where a very pure article is desired, such as for the solution of dyestuffs, etc.; it is usually not available in sufficient quantities nor regular enough in its supply to be serviceable for the preparation of dyevats. Rain-water is considered as the purest form of natural water. Well and spring water are derived from rain-water which has passed through the surface of the earth until it has reached an impervious layer which causes it to collect in subterranean reservoirs from which it may be pumped as

well-water, or it may flow underground until it eventually reappears at the surface as a spring. Such water usually contains various metallic salts in solution and generally has but little insoluble matter in suspension. The exact nature and amount of the dissolved substances will naturally vary considerably with the character of the soil and rock through which the water has passed. Some rocks, like granite and gneiss, are very insoluble, and water percolating through these may be quite free from dissolved impurities, and springs or wells from such a source may be quite "soft." If the water, however, in its percolation through the soil passes through strata of limestone, chalk, sandstone, etc., some mineral compounds pass into solution, especially salts of magnesia and lime. Such a water is termed "hard." Iron compounds form a common constituent of soils and rocks, and consequently water that passes through such will be liable to contamination with iron; this will be more especially the case if at the same time it is in contact with decaying vegetable matter, as the latter furnishes certain organic acids which exert a strong solvent action on the iron compounds. Water containing a marked content of iron is termed "chalybeate" or "ferruginous."

River-water consists largely of surface-water, that is, rain-water which drains directly from the surface of the soil without percolating through the ground to any extent; besides this, river-water also contains well or spring-water feeding into it from small streams, etc., having their origin in springs. The surface-water draining into a river is liable to bring into it a large amount of suspended matter, though not so much dissolved matter. The nature and extent of this suspended matter will, of course, vary largely with the season of the year and the character of the environment. From this it may be seen that river-water will, as a rule, contain more suspended matter and less dissolved matter than well-water. The suspended matter is comparatively easily removed, however, whereas the dissolved substances may give rise to considerable trouble.

The influence of the impurities in water on the dyeing operations will depend very largely on the character of the dyestuffs employed. Hard water containing lime and magnesia compounds, as a rule, does not interfere with the dyeing of colors in an acid bath, as the addition of the acid prevents any precipitation of the coloring matter by the metallic salt. In certain cases the tone of the resulting color-lake may be somewhat modified by the presence of the mineral salts, but such is very rarely the case. The presence of iron, however, even in very slight quantities, in the water, may cause a considerable alteration in the color, usually dulling and darkening it. With the general class of basic dyes hard water cannot be employed without suitable correction by the addition of acetic acid. The basic dyes form insoluble precipitates with lime and magnesia compounds which will result in a large loss of coloring matter and also faulty and

streaky dyeing by reason of the sticky precipitate of coloring matter becoming smeared on the material being dyed. The presence of iron in the water is also very deleterious in using basic dyes. With the class of substantive colors the influence of hard water varies largely with the particular dyestuff, in some cases causing precipitation and in others not. As a general rule, however, it may be taken that hard water is deleterious with this class of dyes, and should be corrected by the addition of a suitable amount of soda ash in order to precipitate all the lime and magnesia compounds which may be in solution. The presence of iron is also bad, as it causes a discoloration of the dyestuff. With mordant dyes the use of hard water, if it does not contain any iron, is considered beneficial, as the lime present produces a better color-lake; in fact, unless the water is sufficiently hard, a soluble salt of lime is usually added in the dyeing of most alizarine colors. In certain cases where a dulled or "saddened" effect is desired, the presence of iron may be beneficial.*

In mordanting operations, such as in the use of metallic salts on wool or silk, hard water may be used with impunity provided it does not contain any iron, which will result in the dulling of the eventual color-lake. In mordanting cotton with tannic acid, the use of hard water may be considered as somewhat beneficial, if anything, as it leads to a better fixation of the tannin mordant.

In bleaching operations on cotton, where chloride of lime or acids or caustic soda may be employed, the use of hard water is not injurious; though it should not be contaminated with iron. In the bleaching of wool with solutions of sodium bisulphite, hard water may also be employed. In all operations of scouring or bleaching where soap solutions are employed hard water should not be used, as the soap forms a highly insoluble and sticky precipitate with the mineral salts present in the water, causing thereby great loss of soap and the liability of serious faults in the textiles due to the precipitate of soap becoming incorporated with the fabrics (see page 100). One part of lime present in hard water will precipitate about sixteen parts of ordinary soap.

* In the case of water having a considerable degree of hardness the carbonates of lime or magnesia present may have some influence in dyeing and mordanting. In the case of mordanting, carbonates will produce precipitates with salts of iron, aluminium or tin, and will reduce bichromates to the neutral salts, tartar and tannin are also more or less neutralized. In certain dyeing operations the presence of carbonates exerts a considerable influence; with Cochineal Scarlets, for instance, the shades are much bluer, the dyes such as Methyl Violet, Victoria Blue, Alizarine Blue and Coerulein are precipitated by carbonates, which may lead to loss of dyestuff and the production of streaky colors. In the case of Alizarine Red the presence of lime salts is very beneficial, as shown by Hummel (*Jour. Soc. Dyers & Col.*, 1884, page 11). Carbonate of lime or magnesia, if present in considerable amount gives deeper, though duller, shades with Logwood and Fustic.

When hard water is employed for the washing of fabrics, whether after scouring, dyeing, or bleaching, it may give rise to certain faults known as "lists" by reason of the uneven draining and evaporating of the hard water from the goods, thus leaving deposited in the material the dissolved

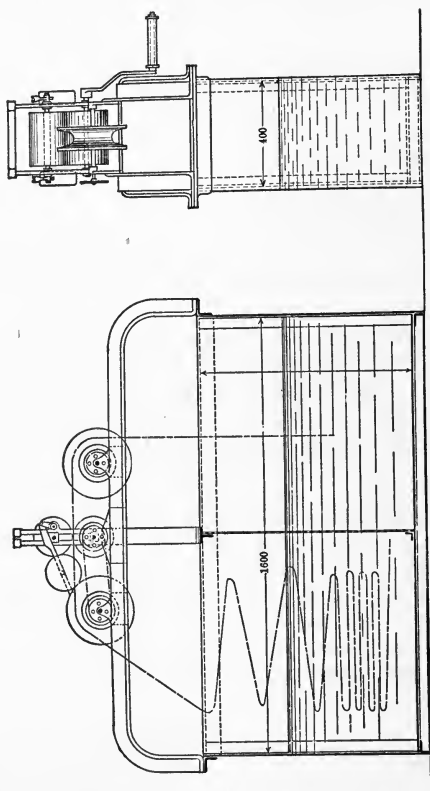

FIG. 143.—Hand Machine for Dyeing Warps.

mineral matter.* Hard water, in fact, is probably more injurious in this connection than in most of the other operations of dyeing.

* These "lists" (see page 192) are light or dark streaks running lengthwise with the cloth. When the washed cloth is rolled up and laid horizontally, the water evaporates at each end, thus causing a greater deposition of mineral matter at the ends (sides of the cloth) than at the middle. If the roll is stood on end the water seeps down to one side and evaporates slowly depositing more mineral matter at one side and gradually shading

Water employed for the dyeing of silk should be especially pure and soft. As soap or boiled-off liquor is almost a universal addition to the dyebath in the case of silk, if the water is at all hard a portion of the soap will be precipitated in the bath, and the sticky and dirty scum will contaminate the silk fiber and injure its luster and appearance.

13. Experimental. Experiment 59. Dyeing of Silk with Acid Dyes.—Dye a test skein of silk yarn in a bath containing 150 cc. of water, 2 per cent of sulphuric acid, and 2 per cent Naphthol Yellow; enter at 120° F., gradually raise to the boil, and dye at that temperature for one-half hour, then wash well and “brighten” by passing through a bath containing 1 gram of tartaric acid and 150 cc. of water at 100° F.* Squeeze without washing and dry. Like wool, silk will also combine directly with the acid colors. Usually a bath is employed containing a considerable amount of boiled-off liquor acidified with acetic acid. This is to prevent as little loss in the weight of the silk as possible during the dyeing, as silk usually comes to the dyer still containing more or less of the silk-glue, which would come off in the dyebath if there were not a considerable amount of the same substance present.

Exp. 60. Use of Acetic Acid in Dyeing Silk.—Dye a test skein of silk yarn in a bath containing 150 cc. of water, 4 per cent of acetic acid, and 2 per cent Eosin; enter at 120° F., gradually raise to the boil, and dye at this temperature for one-half hour. Then wash well and brighten as in Exp. 59. Squeeze and dry. This method of dyeing is used where feebly acid dyes are employed.

Exp. 61. Use of Boiled-off Liquor in Dyeing Silk.—Boiled-off liquor is the scouring bath left after the scouring of silk with strong soap solutions, and consists of the solution of soap and silk-glue. Prepare a bath containing 15 cc. of boiled-off liquor and 125 cc. of water, 2 per cent of Brilliant Croceine, and sufficient sulphuric acid to give the bath a decidedly acid reaction with litmus paper. The presence of the silk-glue prevents the precipitation of the soap by the addition of the acid. Dye a test skein of silk yarn in this bath, entering at 100° F. and gradually raising to 180° F., and continue at that temperature for one-half hour. Wash well and brighten as described in Exp. 59. Squeeze and dry.

Exp. 62. General Method of Dyeing Acid Dyes on Cotton.—Cotton has no direct affinity for the acid colors and requires a basic mordant to combine with the color-acid of the dyestuff. Alum is used at times for this purpose. Prepare a bath containing

off to the other side. On dyeing, the mineral matter may act as a resist or as a mordant, depending on the dye employed, thus giving white lists or dark lists as the case may be (see also page 193).

* The purpose of this treatment is to brighten the dyed color and also to impart to the silk fiber a “scroop,” causing it to emit a crunching or crackling sound when squeezed and rubbed. The cause of the brightening action on the color is probably due to the neutralizing of the soap on the fiber by the acid; as it is claimed that as a result of the use of soap (or bast soap) in the dyebath the dyed color does not come up clear and bright, nor does mere washing in water correct this defect. According to Ganswindt (*Theorie und Praxis der modernen Färberei*, part II, page 17) the use of the subsequent brightening bath of acid is not required when the silk is dyed without any soap in the bath. The production of the “scroop” in the silk is probably caused by the hardening of the surface of the fiber by the action of the acid. In place of tartaric acid for this purpose, the cheaper acetic acid may also be used (5 grams per liter). Sulphuric acid (2.5 grams per liter) may also be employed, but in this case the silk should be rinsed slightly after treatment with the acid.

250 cc. of water, 20 per cent of alum, 20 per cent of Glaubersalt, and 2 per cent of Water Blue; enter a skein of cotton yarn at 140° F., raise to 180° F. and keep at that temperature for forty-five minutes; then squeeze and dry without washing. It will be noticed that a rather concentrated or "short" bath is employed and that even then the exhaustion is very imperfect. These dyes are not much used on cotton at the present time, except for such materials as curtains, etc., where bright colors are desired which have good fastness to light and where fastness to washing is not demanded. To show the lack of fastness to washing of this color, plait a portion of the dyed sample with some strands of white cotton yarn, and scour this test sample in a dilute soap solution; it will be found that the color will wash out almost completely. When applied to cotton, these dyes are usually known as "alum colors" because that salt is used in the bath.

Exp. 63. Dyeing in a Neutral Salt Bath.—This method is generally employed for the dyeing of bright pale shades on cotton with the acid dyes. Use a skein of bleached cotton yarn, and dye in a bath containing 250 cc. of water, 10 grams of common salt, and 10 per cent of Eosin; work for forty-five minutes at a temperature of 140° F., then squeeze and dry without washing. The large amount of salt employed helps to better exhaust the bath, as the dyestuff is less soluble in salt solutions. The bath, however, is in no wise exhausted and should be employed in practice for a "standing" bath for the dyeing of subsequent lots.

Exp. 64. Use of "Blue Mordant."—This mordant is a tartrate of aluminium, and may be prepared by dissolving 22 parts of aluminium sulphate in 45 parts of water, and then adding a solution of 4½ parts of tartaric acid dissolved in 20 parts of water, after which gradually add a solution of 6½ parts of soda ash in 35 parts of water, and dilute the whole to 175 parts with water. For mordanting, use 1 part of this solution to 30 parts of water, or 10 cc. to 300 cc. of water. Work a skein of cotton yarn in a bath containing 300 cc. of water, 10 cc. of "blue mordant," and 1 per cent of Water Blue 6B for one-half hour at 160° F. Squeeze and dry without washing.

Exp. 65. Use of Sodium Stannate Mordant.—This salt is easily decomposed when its solution is boiled, and thus liberates oxide of tin in the fiber. It is used as follows: Steep a skein of cotton yarn for one-half hour in a bath containing 200 cc. of water and 5 grams of sodium stannate at 180° F. Remove the skein, squeeze, and dye in a bath containing 250 cc. of water and 1 per cent of Ponceau 4B and 5 per cent of alum; enter at 140° F., gradually raise to 190° F., and dye at that temperature for one-half hour. Squeeze and dry without washing.

Exp. 66. After-treatment of an Acid Dye with Chrome.—Some of the acid dyes on being treated after dyeing with a boiling solution of chrome (potassium bichromate) are changed into faster and deeper colors.* The chrome may act in two ways: in the first place, it may combine with the dyestuff to give a permanent color-lake (similar to the mordant dyes), and secondly, it may cause an oxidation of the dyestuff whereby a new compound is obtained on the fiber which is faster in color than the original one. Dye two skeins of woolen yarn in the usual manner in a bath containing 300 cc. of water, 10 per cent of Glaubersalt, 4 per cent of sulphuric acid, and 1 per cent of Cloth Red GA. After dyeing for one-half hour, lift the skeins from the bath and add 2 per cent of chrome. Re-enter one of the skeins, and continue boiling for twenty minutes. Then wash and dry. Compare the color of the two skeins, and it will be noticed that the chromed one

* Sometimes a previous treatment with a mordant of chrome and bluestone is recommended for the purpose of giving dyeings faster to fulling, and more especially on shoddy material. The wool is first boiled for one hour in a bath containing 2 per cent of chrome, 3 per cent of bluestone, and 2 per cent of sulphuric acid; rinse and dye in a fresh bath containing the acid dyestuff and a small quantity (1 to 2 per cent) of sulphuric acid.

is deeper in shade. Test the fastness of the dyeings to washing in the following manner: Take a portion of each skein and plait it with some strands of white woolen yarn, and then scour the samples so prepared in a lukewarm dilute soap solution containing about 5 grams of soap per liter. Next wash in fresh water, and allow the two tests to dry, and compare them as to the loss of color and as to the amount of color that bleeds into the white wool.

Exp. 67. Use of a Chromotrop Dye.—This class of dyes gives red or brown colors when dyed in an acid bath, but the color so obtained is of little importance. When

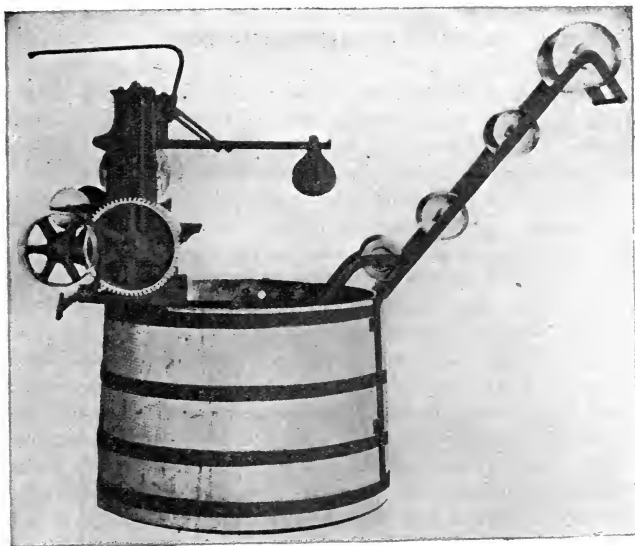

FIG. 144.—Warp Dyeing Machine for Long Chain System.
(H. W. Butterworth & Sons Co.)

after-treated, however, with solutions of metallic salts (such as chrome) the color changes to black and becomes very fast. Prepare a bath containing 300 cc. of water, 4 per cent of sulphuric acid, 20 per cent of glaubersalt, and 6 per cent of Chromotrop FB; dye two skeins of woolen yarn in this bath in the usual manner for one-half hour, then lift and add 3 per cent of chrome and 2 per cent of sulphuric acid, re-enter one of the skeins and continue boiling for twenty minutes,

CHAPTER VIII

REPRESENTATIVE ACID DYES

1. Nomenclature of Dyestuffs.—The manner of naming dyestuffs, unfortunately, is a very confused matter. In the early days of dyestuff manufacture the name given to a coloring matter usually had some reference to a particular quality of tone, such as Malachite Green, Fuchsine, Croceine Scarlet, etc., or was given as a courtesy to some prominent historical character, such as Bismarck Brown, Victoria Blue, etc. Names were also given as indicative of the use of the dye, as Cloth Red, Acid Magenta, Chrome Black, etc., or as indicating the chemical nature of the dyes, such as Tartrazine (derived from dioxy-tartaric acid), Azo Rubine, Diazo Black, Methyl Violet, Metanil Yellow, etc.

As the number of dyes increased, however, and as the number of dyestuff manufacturers multiplied, all kinds of names were introduced, and frequently different manufacturing firms complicated the matter by giving widely different names to the same product in an attempt to establish a proprietary value to their own dye. A direct cotton blue, for instance, was given the following variety of names, depending on the manufacturer, although they all related to exactly the same product: Diamine Blue BX, Benzo Blue BX, Congo Blue BX, Dianil Blue HG, Naphthamine Blue BX, Azidine Blue BX, Niagara Blue BX. This naturally led to a great deal of confusion, which increased as time went on. Later there was some tendency towards system in that many manufacturers gave class names to certain lines of their products, for instance, the general line of substantive cotton dyes received the following names from different firms:

Diamine Colors (Cassella)	Titan Colors (Holliday)
Benzo Colors (Bayer)	Hessian Colors (Leonhardt)
Oxamine Colors (Badische)	Columbia Colors (Berlin)
Dianil Colors (Höchst)	Naphthamine Colors (Kalle)

The general line of sulphur dyes also received special class names, such as:

Sulphur Colors (Berlin)	Katigen Colors (Bayer)
Immedial Colors (Cassella)	Kryogene Colors (Badische)
Thiogene Colors (Höchst)	Thion Colors (Kalle)

Since the war, with the advent of many new dyestuff manufacturers in America and England, these class names have been further multiplied; for instance, we have Erie Colors, Pontamine Colors, Amanil Colors, Auwico Colors, etc.

The letters frequently to be noted after the names of dyestuffs are often private trade distinctions for the use of the manufacturer in identifying the color; such for instance, as Brilliant Croceine MOOO, Alizarine Blue SAP and Diamine Black BH. In many cases these letters refer to the particular shade of the dyestuff, as, for example, B stands for a blue tone, R for red, G (gelb) or Y for yellow. We have, for instance, Methyl

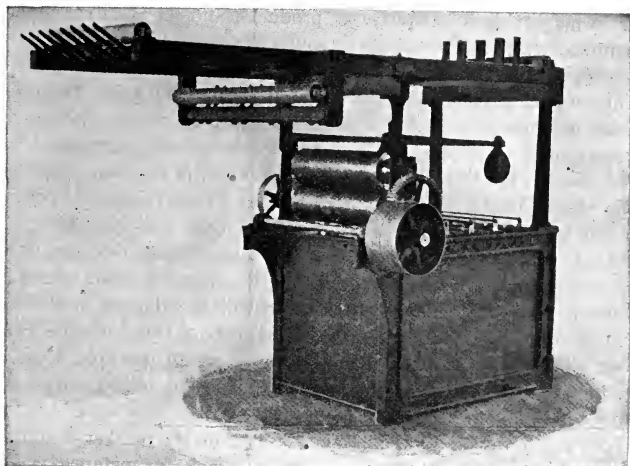

FIG. 145.—Warp Dyeing Machine, Single Compartment.
(H. W. Butterworth & Sons Co.)

Violet B and Methyl Violet BB or 2B, which would indicate that the latter dye is bluer in tone than the former. Also we have Acid Yellow G and Acid Yellow R, meaning that the former is of a greenish tone while the latter is of an orange tone (reddish). When the letter X is used it mostly refers to a concentrated type; Sulphur Black AX for instance would mean that the dye in question is represented as a specially strong type. The letter W usually designates a wool dye; L means a light-fast type of dye; while S refers to a specially soluble dye. In some cases we may have letters of Roman numerals indicating different strengths of the dye, as with Auramine O and Auramine I, II, III. In this case Auramine O means the pure strong type while the marks I, II, and III refer to types more and more diluted in strength.

The matter is still further complicated by the fact that in addition to the large number of single dyes to be met with, there are also a large number of mixed dyes; that is to say, a green dye, for example, may be made by suitably mixing a yellow and blue dye. This green dye is usually given some particular name and designating letter or number for identification to the manufacturer. Formyl Blue B, for instance, is a bright blue dye-stuff made by mixing Formyl Violet S4B (a single dye) with another dye of such character that the mixture gives a blue. In order to cater to convenience of the dyer, a great number of such mixed dyes have been brought into trade, and this has needlessly added to the multiplicity of the products as well as to the confusion of the names. It would be far better to market dyes as individual products, and let the dyer make his own compounds and mixtures for the purpose of matching colors.

Attempts have been made to systematize and classify dyes for the purpose of simplifying their nomenclature and thus identifying the product by some universally accepted designation; but all these attempts have been more or less abortive. Perhaps the most generally accepted classification of dyes for this purpose of identification is the numbered list of dyes in the "Dyestuff Tables" of Schultz. These tables are published every few years in order to include the additional dyes appearing. The last edition was that of 1914, and the numbers given to the dyes in these tables have generally been adopted during the past few years where identification is necessary. The same scheme will be adopted in this book, and where it is especially necessary to identify a dyestuff, the Schultz number will be given in parenthesized italics; as for example, Rose Bengale (*597*), the number meaning that this dye is the one identified in the Schultz Tables under *597*.

There are, however, a large number of dyes on the market that are not to be found in the Schultz Tables. Zambesi Black, for instance, is a well-known dye, and one which was largely used prior to the war (and will presumably again be an important item); yet it is not listed or identified in Schultz Tables. This is also true of a number of the more recent vat dyes.

The following is a list arranged alphabetically of the various trade names of various groups of dyes, which will help to identify the class of the dyestuff and its manufacturer.

<i>Group Name</i>	<i>Dye Class</i>	<i>Manufacturer</i>
Acid Alizarine	Acid Chrome	Höchst
Acid Anthracene	Acid Chrome	Bayer
Acid Chrome	Acid Chrome	Bayer
Acidol	Acid	Weiler
Acidol Chromate	Acid Chrome	Weiler
Acridine	Basic	Leonhardt

<i>Group Name</i>	<i>Dye Class</i>	<i>Manufacturer</i>
Aetz	Acid (Discharged)	Basle
Algone	Vat	Bayer
Alizadine	Acid Chrome	British Dyes
Alizarine	Chrome and Acid Chrome	Various
Alizarine Azo	Acid Chrome	Durand
Alizarol	Acid Chrome	National
Alkali	Substantive	Dahl
Alphanol	Acid	Cassella
Amacid	Acid	Amer. Anil. Prod.
Amanil	Substantive	Amer. Anil. Prod.
Amidazol	Sulphur	Holliday
Amido	Acid	Höchst
Aminine	Substantive	Brassard
Anachrome	Acid Chrome	Brassard
Anthra Chromate	Acid Chrome	Leonhardt
Anthra Chrome	Acid Chrome	Leonhardt
Anthracene Acid	Acid Chrome	Cassella
Anthracene Chromate	Acid Chrome	Cassella
Anthracene Chrome	Acid Chrome	Cassella
Anthracyanine	Acid	Bayer
Anthracyl Chrome	Acid Chrome	Dahl
Anthranol	Acid Chrome	Dahl, U. S. Color
Anthraquinone	Acid	Badische
Atlantamine	Substantive	Atlantic
Atlantene	Developed	Atlantic
Atlanthrene	Chrome	Atlantic
Atlantole	Acid	Atlantic
Auronal	Sulphur	Weiler
Auto Chrome	Acid Chrome	Höchst
Autogene	Sulphur	Poirrier
Autol	Pigment	Badische
Azidine	Substantive	Jäger
Azo	Acid	Various
Azo Acid	Acid	Various
Azo Alizarine	Acid Chrome	Durand
Azophor	Coupled	Höchst
Benzamine	Substantive	Dahl
Benzo	Substantive	Bayer
Benzo Chrome	Substantive (Chromed)	Bayer
Benzo Fast	Substantive	Bayer
Benzoform	Substantive (formaldehyde)	Bayer
Benzoin	Substantive	Beyer & Kegel
Benzo Light	Substantive (light fast)	Bayer
Benzonitrol	Coupled	Bayer
Benzyl	Acid	Basle
Biebrich	Acid	Kalle
Brilliant Alizarine	Chrome	Bayer.
Brilliant Benzo	Substantive	Bayer.
Brilliant Dianil	Substantive	Höchst
Brilliant Fat	Oil Soluble	Basle
Buffalo	Acid	National

<i>Group Name</i>	<i>Dye Class</i>	<i>Manufacturer</i>
Caledon	Vat	Scottish Dyes
Cerasine	Spirit and Oil Soluble	Cassella
Ceres	Dyes for Lakes	Bayer
Chicago	Substantive	Berlin
Chloramine	Substantive	Bayer, Sandoz
Chloranthrene	Vat	British Dyes

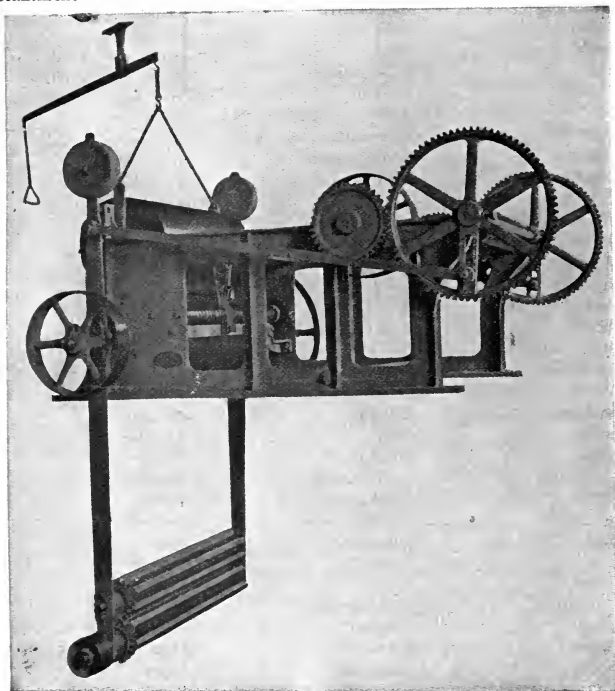

FIG. 146.—Machine for Doubling Warps Previous to Dyeing.
(H. W. Butterworth & Sons Co.)

Chlorantine	Substantive	Basle
Chlorazol	Substantive	British Dyes
Chromanthrene	Chrome	Levinstein
Chrome Fast	Acid Chrome	Bayer
Chromoxan	Acid Chrome	Bayer
Ciba	Vat	Basle
Cibanone	Vat	Basle
Columbia	Substantive	Berlin
Congo	Substantive	Berlin

<i>Group Name</i>	<i>Dye Class</i>	<i>Manufacturer</i>
Coomassie	Acid	Levinstein
Cotton	Substantive	Various
Cross Dye	Sulphur	British Dyes
Crumpsall	Acid	Levinstein
Cyananthrol	Acid	Badische
Diadem Chrome	Acid Chrome	Holliday
Diamine	Substantive	Cassella
Diamine Nitrazol	Coupled	Cassella
Diamond	Acid Chrome	Bayer
Dianil	Substantive	Höchst
Dianil Fast	Substantive	Höchst
Dianol	Substantive	Levinstein
Diazanil	Developed	Höchst
Diazine	Basic	Kalle
Diazo	Developed	Bayer
Diazo Light	Developed (light fast)	Bayer
Diazogen	Developed	Jäger
Diphenyl	Substantive	Geigy
Direct	Substantive	Various
Discharge	Acid (Dischargeable)	Basle
Domingo	Acid	Leonhardt
Domingo Alizarine	Acid Chrome	Leonhardt
Domingo Chrome	Acid Chrome	Leonhardt
Duatol	Dyes for Union Goods	Cassella
Duranthrene	Vat	Levinstein
Durindone	Vat	Levinstein
Eboli	Substantive	Leonhardt
Eclipse	Sulphur	Geigy
Era Chrome	Acid Chrome	Levinstein
Erganone	Chrome, Printing	Badische
Erie	Substantive	National
Erio	Acid	Geigy
Erio Chromal	Acid Chrome	Geigy
Erio Chrome	Acid Chrome	Geigy
Erweco-Alizarine	Acid Chrome	Wedekind
Formal	Substantive (formaldehyde)	Geigy
Furrol	Fur Dyes	Cassella
Gallanil	Acid	Durand
Gallo	Chrome Printing	Bayer
Glycine	Substantive	Kinzlberger
Graphitol	Lake Colors	Griesheim
Guinea	Acid	Berlin
Half-wool	Dyes for Union Goods	Various
Hansa	Lake Colors	Höchst
Helindone	Vat	Höchst
Helio	Lake Colors	Bayer
Hessian	Substantive	Leonhardt
Hydranthrene	Vat	Holliday
Hydron	Vat	Cassella
Hydrosulphon	Sulphur	Brassard
Immedial	Sulphur	Cassella

<i>Group Name</i>	<i>Dye Class</i>	<i>Manufacturer</i>
Indanthrene	Vat	Badische
Janus	Basic	Höchst
Kashmir	Acid	Bayer
Katigen	Sulphur	Bayer
Kiton	Acid	Basle
Kyrogene	Sulphur	Badische
Lanacyl	Acid	Cassella
Lanasol	Acid Chrome	Basle
Leucol	Vat	Bayer
Lissamine	Acid	Levinstein
Lithol	Lake Colors	Badische
Mercerol	Acid	Holliday
Metachrome	Acid Chrome	Berlin, Brotherton
Methylene	Basic	Höchst
Mikado	Substantive	Leonhardt
Milling	Acid	Various
Modern	Printing Colors	Durand
Monochrome	Acid Chrome	Bayer, Holliday
Naka	Fur Dyes	Höchst
Naphthamine	Substantive	Kalle
Naphthol	Acid	Various
Naphthylamine	Acid	Various
Neofom	Substantive (formaldehyde)	Basle
Neptune	Acid	Badische
Niagara	Substantive	National
Nitrazo	Coupled	Jäger
Oil	Oil Soluble	Various
Omega Chrome	Acid Chrome	Sandoz
Ortho	Acid	Berlin
Osfa Chrome	Acid Chrome	Hruschau
Osfamine	Substantive	Hruschau
Osfanil	Substantive	Hruschau
Osfathion	Sulphur	Hruschau
Oxamine	Substantive	Badische
Oxy Chrome	Acid Chrome	Griesheim
Oxy Diamine	Substantive	Cassella
Palatine	Acid	Badische
Palatine Chrome	Acid Chrome	Badische
Para	Coupled	Bayer
Parachrome	Acid Chrome	Oxley
Paramine	Substantive	Holliday
Paranil	Coupled	Berlin
Paranol	Substantive	U. S. Color
Paraphor	Coupled	Höchst
Permanent	Lake Colors	Berlin
Pheno	Substantive	Heller & Merz
Phenochrome	Chrome, Printing	Kalle
Phenyl	Acid	Française
Pigment	Lake Colors	Höchst
Pluto	Substantive	Bayer
Polar	Acid	Geigy

<i>Group Name</i>	<i>Dye Class</i>	<i>Manufacturer</i>
Polyphenyl	Substantive	Geigy
Pontacyl	Acid	Du Pont
Pontamine	Substantive	Du Pont
Pontochrome	Acid Chrome	Du Pont
Primazine	Lake Colors	Badische
Pyrazol	Substantive	Sandoz
Pyramine	Substantive	Badische
Pyrogene	Sulphur	Basle
Pyrol	Sulphur	Leonhardt
Pyronal	Oil Soluble	Dahl
Renol	Substantive	Weiler
Rhoduline	Basic	Bayer
Rosanthrene	Substantive	Basle
St. Denis	Substantive	Poirrier
Salicine	Acid Chrome	Kalle
Serichrome	Acid Chrome	National
Seto	Acid	Geigy
Sita	Lake Colors	Weiler
Solochrome	Chrome	Levinstein
Stilbene	Substantive	Various
Sulphanil	Substantive	Kalle
Sulphine	Sulphur	Noetzel, Istel & Co.
Sulpho	Sulphur	Holliday
Sulphogene	Sulphur	Du Pont, Basle
Sulphon	Acid	Bayer
Sulphon Acid	Acid	Bayer
Sulphur	Sulphur	Berlin, National
Sulphurof	Sulphur	Dahl
Sultan	Substantive	British Dyes
Supramine	Acid	Bayer
Superchrome	Acid Chrome	National
Tannate	Basic	Dahl
Thiazine	Substantive	Bayer
Thio Indigo	Vat	Kalle
Thiogene	Sulphur	Höchst
Thion	Sulphur	Kalle
Thional	Sulphur	Sandoz
Thionol	Sulphur	Levinstein
Thionone	Sulphur	Holliday
Thiophor	Sulphur	Jäger
Thioxine	Sulphur	Griesheim
Titan	Substantive	British Dyes
Toluylene	Substantive	Griesheim
Triatol	Dyes for Union Goods	Dörr
Triazol	Substantive	Griesheim
Trisulphon	Substantive	Sandoz
Tyemond	Acid	Holliday
Ultra	Chrome	Sandoz
Ursol	Fur Dyes	Berlin
Victoria	Acid	Various
Vidal	Sulphur	Poirrier

<i>Group Name</i>	<i>Dye Class</i>	<i>Manufacturer</i>
Vulcan	Sulphur	Levinstein
Wakefield	Acid	Brassard
Wool	Acid	Various
Xylene	Acid	Sandoz
Zambesi	Developed	Berlin

2. Dyestuff Manufacturers.—Owing to the complex nomenclature of dyes depending to a considerable extent on the particular manufacturer, it really becomes necessary at times to include the name of the manufacturer with the dyestuff in order properly to identify it. Previous to the war by far the greater part of the dyes sold throughout the world were made by German manufacturers and there were only a small scattering of other manufacturers through England, France, Switzerland and America. Since the war, however, the dyestuff industry has been developed to large proportions in other nations besides Germany, so that now the matter is still further complicated by a greatly extended list of manufacturers. For the convenience and instruction of the reader, a list of the principal dyestuff manufacturers in different countries is given in an appended list. There will also be found a designated abbreviation which may be used at times in connection with particular dyestuffs in order to identify the product. Naturally the author has taken pains carefully to avoid, as far as possible, reference to particular manufacturers or any tendency to give prominence to one make of color over another. At the present time, when most of the patents covering the principal dyes have run out, the same dyestuff is made by a number of manufacturers, and generally there is little or no variation in the type and quality of the different makes. Unfortunately, however, the names of many of these dyes have been trade-marked and of course these names remain the property of the particular manufacturer, although the dye may be universally known commercially by its original trade-marked name. Diamine Blue 2B, for instance, is a well-known cotton dyestuff, and is made by a large number of firms; but the name "Diamine" is a trade-mark of a particular manufacturer (Leopold Cassella & Co., of Frankfort, Germany), and therefore this dye is to be met with under a variety of names, some also trade-marked (such as Benzo Blue 2B, Pontamine Blue 2B) and others not (such as Direct Blue 2B).

LIST OF PRINCIPAL DYESTUFF MANUFACTURERS

(a) United States

National Aniline and Chemical Co. (National)
 E. I. du Pont de Nemours & Co. (Du Pont)
 Grasselli Chemical Co. (Grasselli)
 Newport Chemical Works (Newport)
 Heller & Merz Co. (H. & M.)

John Campbell & Co. (Campbell)	Butterworth-Judson Corp. (B. & J.)
Atlantic Dyestuff Co. (Atlantic)	Dow Chemical Co. (Dow)
Pharma Chemical Co. (Pharma)	Peerless Color Co. (Peer)
Essex Aniline Works (Essex)	Calco Chemical Co. (Calco)
Central Dyestuffs & Chemical Co. (Central)	Dye Products & Chemical Co. (Dye Prod)
Althouse Chemical Co. (Althouse)	Cincinnati Chemical Works (Cin)
E. C. Klipstein & Sons' Co. (Klip)	Croton Color & Chemical Co. (Croton)
Noil Color & Chemical Co. (Noil)	American Aniline Products (A. A. P.)
United States Color & Chemical Co. (U. S. Col.)	

(b) Germany

Badische Anilin und Soda Fabrik (Badische)
 Actien-Gesellschaft für Anilin-Fabrikation; Berlin Aniline Works (Berlin)
 Farbenfabriken vorm. Fried. Bayer & Co. (Bayer)
 Leopold Cassella & Co. (Cassella)
 Farbwerke vorm. Meister Lucius & Brüning (Höchst)
 Chemische Fabrik, Griesheim-Elektron (Griesheim)
 Farbwerk Mülheim vorm. A. Leonhardt & Co. (Leonhardt)
 Kalle & Co. (Kalle)
 Leipziger Anilinfabrik Beyer & Kegel (Beyer & Kegel)
 Carl Jäger Anilinfabrik (Jäger)
 R. Wedekind & Co. (Wedekind)
 Chemikalienwerk Griesheim (Noetzel & Istel)
 Chemische Fabriken vorm. Weiler-ter-Meer (Weiler)
 Wülfig, Dahl & Co. (Dahl)

(c) England

British Dyestuff Corp. (British Dyes)
 L. B. Holliday & Co. (Holliday)
 Levinstein, Ltd. (Levinstein), now joined with British Dyestuff Corp.
 Clayton Aniline Co. (Clayton)
 F. à Brassard & Crawford (Brassard)
 The Lazard-Godchaux Co. (Lazard)
 J. C. Oxley's Dyes & Chemicals (Oxley)
 Brotherton & Co. (Brotherton)
 Barking Chemical Co. (Barking)
 British Alizarine Co. (Br. Alizarine)
 Scottish Dyes, Ltd. (Scot. Dyes)

(d) Switzerland

Gesellschaft für Chemisene Industrie in Basle (Basle)
 Farbwerke vorm. L. Durand Huguenin & Co. (Durand)
 J. R. Geigy (Geigy)
 Sandoz Chemical Works (Sandoz)

(e) France

Société Anonyme des Matières Colorantes (Poirrier)
 John Casthelaz, Bruère et Cie. (Gasthelaz)
 Société Nouvelle de Couleurs d'Aniline de Pantin (Pantin)
 Compagnie Nationale de Matières Colorantes et de Produits Chimiques (C. N. M. C.)

Laroche & Juillard (Laroche)

Compagnie Française de Produits Chimiques et Matières Colorantes (Française)

(f) Italy

Società Italiana Prodotti Esplorenti

Società Italiana Colori Artificiali

Fabbrica Italiana Materie Coloranti Bonelli

Industria Nazionale Colori Anilina

Chimica Lombarda Bianchi

3. List of the Principal Acid Dyestuffs.—The acid dyes to be met with upon the market at the present time include a very large number. This is further increased by the fact that many different names are frequently given to the same dyestuff by different manufacturers and dealers, and still further by the use of mixed dyes to produce different shades and tones. It would be practically impossible to give a complete list of all the acid dyes in trade, but the following will give a fair idea of the principal dyes. They are roughly classified according to color.

(a) Red

Acid Carmoisine	Azo Phloxine	Coccine
Acid Cerise	Azo Red	Cochineal Red
Acid Fuchsine	Azo Rhodine	Cochineal Scarlet
Acid Magenta	Azo Rubine	Cotton Scarlet
Acid Maroon	Benzyl Red	Cresol Red
Acid Red	Biebrich Acid Red	Croceine
Acid Rhodamine	Biebrich Scarlet	Croceine Scarlet
Acid Rosamine	Bordeaux	Crystal Ponceau
Acid Ponceau	Brilliant Acid Carmine	Crystal Scarlet
Alkali Fast Red	Brilliant Bordeaux	Cyanosine
Amaranth	Brilliant Carmoisine	Double Brilliant Scarlet
Amido Naphthol Red	Brilliant Cochineal	Double Ponceau
Anisoline	Brilliant Croceine	Double Scarlet
Anthracene Red	Brilliant Double Scarlet	Emin Red
Apollo Red	Brilliant Fast Red	Eosamine
Archil Substitute	Brilliant Orseille	Eosin
Azo Acid Carmine	Brilliant Ponceau	Eosin Scarlet
Azo Acid Fuchsine	Brilliant Rubine	Erythrine
Azo Acid Rubine	Brilliant Scarlet	Erythrosine
Azo Acid Magenta	Brilliant Sulphon Red	Fast Acid Eosin
Azo Bordeaux	Cardinal	Fast Acid Fuchsine
Azo Cardinal	Cardinal Red	Fast Acid Phloxine
Azo Carmine	Carmoisine	Fast Bordeaux
Azo Croceine	Cerasine	Fast Claret Red
Azo Cochineal	Chromazon Red	Fast Crimson
Azo Crimson	Chromotrop	Fast Fuchsine
Azo Eosin	Chromotrop 2R	Fast Ponceau
Azo Fuchsine	Clayton Cloth Red	Fast Red
Azo Graphic Red	Cloth Red	Fast Scarlet
Azo Grenadine	Cloth Scarlet	Florida Red
Azo Orseille	Coccine	Guinea Bordeaux

Guinea Carmine	New Red	Scarlet
Lake Scarlet	Orecline	Silk Red
Lanafuchsine	Orseille Red	Silk Scarlet
Leveling Red	Palatine Red	Sorbine Red
Mars Red	Palatine Scarlet	Sulphon Carmine
Mercerine Wool Red	Phloxine	Tolane Red
Mercerine Wool Scarlet	Ponceau	Tyemond Red
Milling Red	Pyrotine Red	Tyemond Scarlet
Milling Scarlet	Roccelline	Victoria Rubine
Naphthorubine	Rock Scarlet	Victoria Scarlet
Naphthol Red	Rosazeine	Violamine
Naphthol Scarlet	Rose Bengale	Wakefield Acid Red
Naphthylamine Red	Rosinduline	Wakefield Ponceau
New Claret	Roxamine	Wool Red
New Coccine	Salicine Red	Wool Scarlet

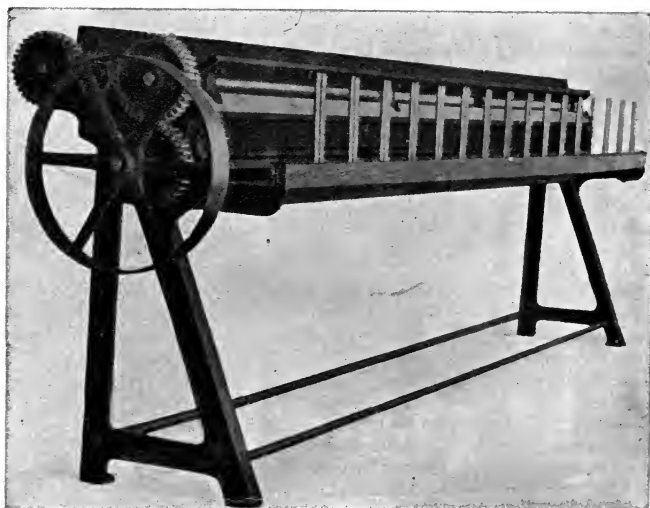

FIG. 147.—Machine for Splitting Warps after Dyeing.
(H. W. Butterworth & Sons Co.)

(b) Orange

Aniline Orange	Kermesine Orange	Orange R, G, etc.
Aurantia	Mandarin G	Palatine Orange
Brilliant Orange	Milling Orange	Pyrotine Orange
Croceine Orange	Orange I	Tyemond Orange
Crystal Orange	Orange II	Wool Orange
Gold Orange	Orange IV	

(c) Yellow

Acid Yellow	Flavaniline	Persian Yellow
Alkali Yellow	Flavazine	Pieric Acid
Alpine Yellow	Golden Yellow	Quinoline Yellow
Azo Acid Yellow	Helianthine	Resorcine Yellow
Azo Flavine	Indian Yellow	Solid Yellow
Azo Yellow	Martius Yellow	Sun Yellow
Brilliant Yellow	Mercerol Wool Yellow	Tartrazine
Chinoline Yellow	Metanil Yellow	Tropæoline
Chrysoine	Milling Yellow	Tyemond Yellow
Cinereine	Naphthol Yellow	Uranine
Citronine	Naphthol Yellow S	Victoria Yellow
Curcumine	Naphthylamine Yellow	Wool Yellow
Fast Yellow	New Yellow	Xanthamine
Fast Light Yellow		

(d) Green

Acid Green	Cyprus Green	Light Green
Agalma Green	Diamond Green	Lissamine Green B
Alkali Fast Green	Domingo Green	Milling Green
Alizarine Green	Eboli Green	Naphthaline Green
Alizarine Cyanine Green	Fast Acid Green	Naphthol Green
Anthracene Acid Green	Fast Green	Neptune Green
Benzyl Green	Fast Green Bluish	Night Green
Brilliant Acid Green	Fast Light Green	Patent Green
Brilliant Milling Green	Guinea Green	Wool Green S
Cyanole Green	Kiton Green	

(e) Blue

Acid Blue	Coomassie Acid Blue	Gallanyl Indigo
Acid Peacock Blue	Coomassie Navy Blue	Gallocyanine
Alizarine Blue SAP, SAE	Copper Blue	Gallazin A
Alizarine Pure Blue	Cotton Blue	Gentiana Blue
Alizarine Sapphire	Cyanine	Indigo Blue
Alkali Blue	Cyanole	Indigo Carmine
Alphazurine	Cyprus Blue	Indigo Extract
Anthra Cyanine	Disulphine Blue	Indigo Substitute
Anthracene Blue	Durasol Acid Blue B	Indigotine
Azine Blue	Eriochlorine	Indocyanine
Azo Acid Blue	Eriocyanine	Induline
Azo Dark Blue	Erioglaurine	Intensive Blue
Azo Marine Blue	Ethyl Blue	Ketone Blue
Azo Navy Blue	Fast Acid Blue	Kiton Blue
Bavarian Blue	Fast Blue	Lanacyl Blue
Benzyl Blue	Fast Blue Black	Lanacyl Marine Blue
Biebrich Acid Blue	Fast Blue for Wool	Lazuline Blue
Blackley Blue	Fast Sky Blue	Lyons Blue
Brilliant Blue	Fast Wool Cyanone	Marinol Acid Blue
Brilliant Silk Blue	Fast Wool Blue	Marine Blue
Carmine Blue	Flourescent Blue	Methane Dark Blue
China Blue	Formyl Blue	Methyl Alkali Blue
Cloth Blue	Full Blue	Methyl Soluble Blue

Milling Blue
 Naphthaline Blue
 Naphthazine Blue
 Naphthol Blue
 Naphthyl Blue
 Navy Blue
 Neptune Blue
 New Patent Blue
 Night Blue
 Opal Blue

Patent Blue
 Patent Marine Blue
 Patent Neutral Blue
 Peri Wool Blue
 Pure Blue
 Sapphire Blue
 Silk Blue
 Solid Blue
 Soluble Blue
 Spirit Blue

Sulphocyanine
 Sulphon Acid Blue
 Thiocarmin
 Turquoise Blue
 Urania Blue
 Victoria Marine Blue
 Water Blue
 Wool Blue
 Wool Marine Blue

(f) Violet

Acid Mauve
 Acid Violet
 Alkali Violet
 Azo Acid Violet
 Azo Wool Violet
 Benzal Violet
 Benzyl Violet
 Biebrich Acid Violet

Ethyl Acid Violet
 Fast Acid Violet
 Fast Sulphon Violet
 Fast Violet
 Fast Wool Violet
 Formyl Violet
 Guinea Violet
 Lanacyl Violet

Lissamine Violet 2 R
 Naphthyl Violet
 Neutral Violet
 Red Violet
 Regina Violet
 Victoria Violet
 Violamine
 Wool Violet

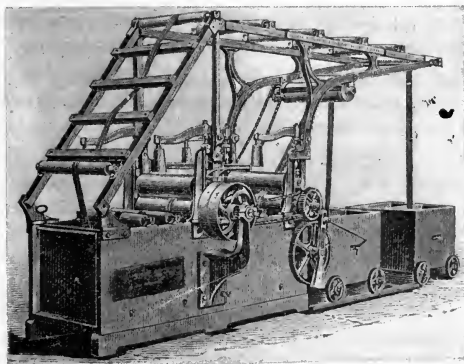

FIG. 148.—Warp Dyeing Machine. (Zittauer.)

(g) Brown

Acid Brown
 Azo Brown
 Bismarck Acid Brown
 Bronze Acid Brown
 Chestnut Brown

Chromogen
 Clayton Wool Brown
 Dark Acid Brown
 Fast Brown

Marron
 Naphthol Brown
 Naphthylamine Brown
 Resorcinc Brown

(h) Black

Acid Black
 Agalma Black
 Alizarine Black

Amido Naphthol Black
 Aniline Gray
 Anthracene Acid Black

Anthracite Black
 Azo Acid Black
 Azo Black

Azo Merino Black	Domingo Violet Black	Norwood Black
Biebrich Patent Black	Durol Black	Palatine Black
Brilliant Black	Ethyl Black	Patent Palatine Black
Buffalo Blacks	Mercerol Wool Black	Phenol Black
Burl Black	Methane Black	Phenylamine Black
Cashmere Black	Naphtacyl Black	Phenylene Black
Coomassie Black	Naphthaline Acid Black	Silk Black
Coomassie Blue Black	Naphthol Black	Sudan Black
Coomassie Fast Black	Naphthyl Blue Black	Victoria Black
Copper Black	Naphthylamine Black	Wakefield Acid Black
Deep Black	Nerol	Wool Black
Domingo Acid Black	New Victoria Black	Wool Deep Black
Domingo Azo Black	Nigrosine	Wool Gray
Domingo Blue Black		

4. Experimental. Exp. 68. Representative Acid Dyes on Wool.—Dye test skeins of woollen yarn in baths containing 300 cc. of water, 20 per cent of Glaubersalt, 4 per cent of sulphuric acid, and 1 per cent respectively of the following dyestuffs:

Naphthol Red EB	Acid Violet 5BF
Emin Red	Patent Blue V
Tartrazine	Orange II
Naphthol Yellow S	Wool Blue 2B
Alizarine Blue SAE	Acid Green

Enter at 140° F., gradually raise to the boil, and continue at that temperature for one-half hour; wash well and dry. These test skeins are to be preserved for the purpose of testing the colors for fastness to various agencies.

Exp. 65. Representative Acid Dyes on Cotton.—Dye test skeins of cotton yarn in baths containing 200 cc. of water, 20 per cent of alum, and 50 per cent of common salt at a temperature of 180° F. for one hour. Wring out and dry without washing. Preserve the dyed skeins for the purpose of testing the colors for fastness.

Use 10 per cent of the following dyestuffs:

Brilliant Orange G	Brilliant Croceine M
Ponceau 4R	Metanil Yellow
Rose Bengale	Erythrosine B
Methyl Blue	Irisamine G

Exp. 70. Representative Acid Dyes on Silk.—Dye test skeins of silk yarn in baths containing 150 cc. of water, 15 cc. of boiled-off liquor, and acidify with sulphuric acid. Dye for one hour at 180° F. Wash well and brighten with tartaric acid.

Use 2 per cent of the following dyestuffs:

Acid Magenta	Crystal Ponceau 6R
Acid Violet 4RS	Cyanole BB
Methyl Blue for silk	Acid Green
Orange II	Azo Fuchsine
Lyons Blue	Silk Black 4BF 6 per cent.

CHAPTER IX

STRIPPING OF COLORS; TESTING THE FASTNESS OF DYES

1. **Stripping of Dyed Fabrics.**—It is frequently necessary to “strip” or remove the color from dyed materials. This is especially true of shoddy (recovered wool) which has been obtained from mixtures of various colors. The object of the stripping is to obtain a light-colored bottom on which to dye another color. The following are the chief methods of stripping shoddy:

(1) By steeping for six to eight hours (or overnight) in a lukewarm solution of soda ash containing 1 lb. of soda ash to 10 gallons of water. This treatment will remove a considerable number of the more fugitive acid dyes. Boiling in a solution of ammonia (2 lbs. to 10 gallons) is also very effective with many acid dyes and does less injury to the fiber.

(2) Boil for thirty minutes in a solution containing 2 to 5 lbs. of ammonium acetate to 100 gallons of water. This is also suitable for many acid dyes, and there is very little damage to the material.

(3) Boil for one-half to one hour in a liquor containing 3 to 7 per cent of chrome and 3 to 10 per cent of sulphuric acid (based on the weight of the material). This method will strip a number of the fast alizarine and mordant colors. The material at the same time also becomes mordanted for subsequent dyeing with fast colors.

(4) Boil for thirty minutes in a bath containing 3 to 5 per cent of sulphuric acid (or $1\frac{1}{2}$ to 2 per cent of formic acid, or 8 to 10 per cent of acetic acid) and 3 to 5 per cent of Decroline (or Hydraldite). These latter stripping agents are hydrosulphite compounds,* and will very effectively remove a large number of colors from shoddy. Though their cost is relatively high their efficiency is also high.

Stripping at times must also be resorted to when too heavy a shade is obtained in dyeing, and it is necessary to remove some of the color on the fiber to match a shade. In the case of woollen materials, especially where acid dyes are used, boiling in a bath containing a considerable quantity of Glaubersalt will often take off considerable color. Also boiling in a bath containing ammonium acetate is very efficacious. In cotton dyeings,

* These stripping agents are usually basic zinc hydrosulphite compounds or formaldehyde compounds of hydrosulphites.

where substantive colors are used, boiling in fresh water will generally bring down the color considerably.

For stripping the different classes of dyes in cases where the color has come out uneven or has been overdyed, the following methods are suggested:

(a) *Acid Colors*.—Boil with a rather strong solution of glauber salt, or boil in a solution of ammonia water. The more resistant colors may be stripped down with hydrosulphite.

(b) *Mordant Colors*.—These are usually rather difficult to remove and also uneven shades being difficult to correct must often be redyed to a darker color or to black. Sometimes stripping can be partially effected by boiling the dyed wool in a fairly strong solution of sulphuric, hydro-

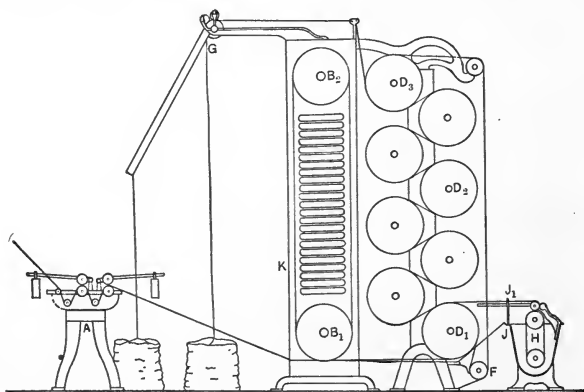

FIG. 149.—Warp Dyeing Machine. (Fries.)

chloric or oxalic acid whereby the dyestuff color-lake is more or less decomposed. By succeeding the acid treatment with a warm ammonia bath the dye that is split away from the mordant may be removed.

(c) *Substantive Dyes on Cotton*.—These may be partially stripped by boiling in water containing a small amount of soda ash in solution. If more strenuous methods are desired use hydrosulphite, titanous chloride or a weak solution of bleaching powder.

(d) *Sulphur Dyes on Cotton*.—For a light stripping run through a hot solution of sodium sulphide; a more vigorous, or even complete stripping may be obtained by treating the dyed material in a bath of bleaching powder at 4 to 5° Tw. and acidulating with acetic acid.

2. Experimental. Exp. 71. Stripping of Substantive Colors with Chloride of Lime.—Take one of the skeins of cotton yarn which has been dyed with Benzopur-

purine in a previous experiment, and steep it for one-half hour in a cold solution of chloride of lime at 2° Tw.; then squeeze and pass through a cold dilute solution of sulphuric acid for ten minutes; then wash well, soap and dry. Preserve a sample of the color before this treatment and compare it with the color as finally obtained.

Exp. 72. Stripping Substantive Colors with Titanous Salts.—Take another of the skeins of cotton yarn which has been dyed with Benzopurpurine as above, and steep it for one-half hour in a solution of titanous sulphate containing 5 cc. of the liquid to 300 cc. of water; then gradually warm to 180° F.; squeeze, and wash well in fresh water. Preserve a sample of the color before treatment and compare it with the color as finally obtained.

Exp. 73. Stripping Substantive Colors with Hyraldite.—This compound is a derivative of sodium hydrosulphite with formaldehyde, and possesses very strong reducing properties. Take one of the skeins of cotton yarn dyed with Benzopurpurine as above, and work it in a bath containing 300 cc. of water, 5 per cent of Hyraldite A, and 3 per cent of acetic acid; enter cold, and gradually bring to the boil, then add 3 per cent more of acetic acid and continue boiling for fifteen minutes. Then remove the skein and wash well in fresh warm water. Preserve a sample of the skein before treatment and compare it with the color as finally obtained.

3. Fastness of Dyes.—The fastness of a dye refers to the ability of the color produced by it to withstand the destructive effect of certain agencies acting upon it. No dyestuff of organic nature can be considered as *absolutely* fast; that is to say, the color produced by it can be changed or destroyed by one means or another. The fastness of a color, however, must be considered with reference to those agencies acting upon it *normally* under the customary conditions of use and wear. These conditions vary greatly depending on the character of the goods to which the color is applied. To the ordinary consumer of dyed goods, however, the most usual qualities of fastness required are reasonable resistance to the action of light and washing (treatment with soap and hot water). To the manufacturer of the goods, however, and to the dyer of the color, the qualities of fastness must be considered in a broader manner, and the dye must be selected with reference to its ability to produce a color that will satisfactorily meet the requirements of the goods both in the course of manufacture and in subsequent wear. The dyes for hat felts, for example, as far as the use of the material goes, require only a good fastness to light, and there is no need of a fastness to washing, because hats are not washed. But in the course of the manufacture of the hat, the felt form after it is dyed has to pass through a number of operations to all of which the color must be fast; for instance, it is hot-pressed on forms and is subjected to rather high temperatures; it is steamed, and usually stiffened by the use of various sizing materials. So in addition to the required fastness to light, a dye for use on hat felts must also be fast to hot-pressing and steaming. On the other hand, dyes employed for coloring hosiery need not be particularly fast to light, but they must be very fast to washing, and furthermore, must be fast to perspiration and rubbing (crocking).

In the case of colors dyed on cotton wash fabrics (and these are acquiring an increasing importance as articles of apparel), the consumer is particularly interested in the fastness to washing in the laundry. As it has become the almost universal practice of the modern laundry in addition to scouring the goods with soap and hot water, to whiten them by a treatment with a mild hypochlorite solution, it will be seen that fastness in this case requires the dyestuff to withstand the bleaching action of a dilute solution of hypochlorite (known as chlorine bleaching). There are but very few colors that will withstand this influence, and the dyes have to be selected with great care.

An extended discussion of the fastness of dyes and the qualities of fastness required for different classes of material will be taken up in a later chapter; it will suffice at this point to take up the more simple tests to ascertain the more common qualities of fastness, and this is most efficiently done by carrying out the practical tests on various dyed colors.

4. Experimental. Exp. 74. Fastness to Light.—For this test (and those succeeding) use five of the skeins dyed in the preceding chapter. Cut off a sample of the dyed skein about 3 ins. in length and place it in an exposure board, arranging it in such a manner that one-half of the sample is exposed to the light, while the other half is protected. Hang the exposure board on the inside of a window facing the south in order to obtain as much sunlight as possible. Allow the exposure to continue for one week, at the end of which time examine the sample for fading. If the color shows any perceptible alteration, it must be considered as *not fast* to light. If no fading is observed, the exposure should be continued for three weeks more. The sample is now examined a second time, and if any fading is apparent, the sample is removed and classified as *moderately fast*. If no fading is apparent the sample may be classified as *quite fast* to light. The degrees of fastness to light may also be classified numerically as follows:

1. Not faded in four weeks' exposure.
2. Not faded in one week's exposure.
3. Faded by one week's exposure.

Exp. 75. Fastness to Washing.—This is to represent the fastness of the color to scouring with soap. Take five or six strands of the dyed yarn to be tested and plait it with a similar amount of white woolen and white cotton strands, so as to make up a small test sample about 4 ins. in length. This sample is then steeped in a soap solution containing 5 grams of soap per liter. About 50 cc. of the solution will be required for each test and not more than one sample should be scoured in the same liquor. Have the temperature of the soap solution at 140° F., and wash the sample thoroughly by rubbing with the hands in the same manner as if the sample were dirty and one was trying to clean it. Use every precaution of cleanliness in order to prevent the sample from becoming stained with any other color. Then wash well in fresh warm water, and dry. Note if this treatment has caused the color to bleed into either the white wool or cotton with which the colored yarn is plaited, also if any of the color runs into the soap liquor, and after drying compare the sample with the original color and note if it has undergone any alteration.

Exp. 76. Fastness to Fulling or Milling.—Plait together a small test sample about 4 ins. in length, using several strands of the dyed yarn and some strands of white woolen yarn. Work the sample so prepared in about 50 cc. of a solution containing 5 grams of

soap and 2 grams of soda ash per liter at a temperature of 140° F. Rub the sample vigorously between the hands or between two pieces of wood in order to felt the fibers together and so imitate the action of fulling. After the fibers have been well felted together, wash the sample in fresh warm water, and dry. Note if the color has bled into the white wool or into the soap liquor; also compare the tested sample with the original color and note if it has undergone any alteration. The fulling test is only applicable to dyeings on wool.

Exp. 77. Fastness to Water.—This test is more especially applied to dyeings on silk and cotton yarns, and is to represent particularly fastness to rain. Plait together a small test sample about 4 ins. in length, using strands of the dyed yarn with similar amounts of white silk and white cotton yarns. Steep this sample in distilled water for twelve hours (overnight), then squeeze out and dry. Note if the color has bled into either of the white yarns or into the steeping water.

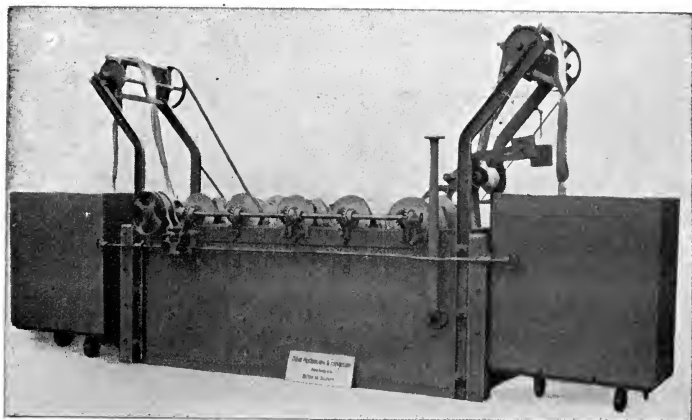

FIG. 150.—Machine for Dyeing, Bleaching or Washing Skeins Tied in Long Chains.

Exp. 78. Fastness to Perspiration.—This is required of all clothing material intended for wear next to the skin; also for materials for making horse-blankets, etc. The action of perspiration is an acid one, and is said to be best represented chemically by the action of acetic or lactic acid on the color. Plait a few strands of the dyed yarn with strands of white wool and cotton yarns in the usual manner, and steep for one hour in about 50 cc. of a solution containing 100 cc. of lactic acid (22 per cent) per liter at the ordinary temperature. Then squeeze, wash and dry. Note if the color has bled into either of the white yarns or if the color has suffered any change from the original.

Exp. 79. Fastness to Carbonizing.—The carbonizing process is the treatment of woolen material with acid and then drying for the purpose of decomposing any vegetable matter present. It is especially used in connection with shoddy, though it is also at times employed on woolen piece-goods to remove specks of vegetable matter in the finished cloth. Take a small sample of the dyed woolen skein and steep it for fifteen minutes in a solution of sulphuric acid at 4° Tw. and at a temperature of 140° F. Squeeze, and dry without washing, then wash well and dry again. Note if the color has under-

gone any alteration by this treatment. This test is only applicable to dyed woolen materials.

Exp. 80. Fastness to Cross-Dyeing.—By cross-dyeing is meant the dyeing of pieces containing white wool woven with dyed cotton yarn; the wool being dyed in a boiling acid bath, the dyed cotton must not be changed by the process. Make a small plaited sample of strands of the dyed cotton yarn with strands of white woolen yarn and boil the sample so prepared for fifteen minutes in about 50 cc. of a solution containing 1 cc. of concentrated sulphuric acid and 2 grams of glaubersalt per liter; wash well, and dry.

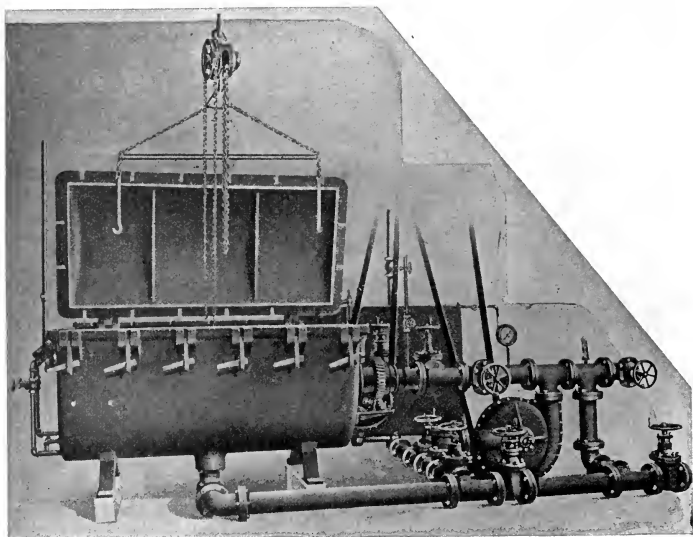

FIG. 151.—Beam Dyeing Machine for Warps. (Columbus Truck and Supply Manufacturing Co.)

Note if the color has undergone any alteration or if it has bled into the white yarn. This test is applied only to cotton dyeings.

Exp. 81. Fastness to Stoving.—Sometimes it is necessary to bleach woolen pieces containing white and colored yarns woven together in order to clear up the white yarns. This bleaching is done with sulphur dioxide (fumes from burning sulphur) as a rule, and the process is known as “stoving.” Take a small sample of the dyed woolen yarn, moisten with water, and hang it for six hours in a closed compartment containing sulphurous acid gas. Note if the color has undergone any alteration. This test is applied only to dyed woolen materials.

Exp. 82. Fastness to Chloring.—Cotton pieces containing white and dyed yarns woven together sometimes require the bleaching of the white after being woven. Toweling with colored borders is a good example of this class of material. The dyed colors

CHAPTER X

APPLICATION OF BASIC DYES

1. Characteristics of the Basic Dyes.—The basic dyes are mostly employed in the form of their salts, and in the dyebath these salts are apparently dissociated into the dyebase and the acid.* In the dyeing operation, the acid is left in the bath while the dye base combines with the fiber (in the case of wool or silk) or with the acid mordant (in the case of cotton).

Like the acid dyes, the basic dyes are to be found represented in a number of different chemical groups of dyestuffs. The principal basic dyes, however, are derivatives of triphenylmethane, as this group furnishes dyes having the most beauty, intensity, and brightness, though they do not, as a rule, possess any remarkable fastness. Some of the chief representatives of this group are Magenta (Fuchsine), Methyl Violet, and Malachite Green. Notwithstanding their lack of fastness they are staple dyestuffs and largely used for many purposes on account of their great brilliancy and purity of tone. There are also a number of basic dyes to be found among the azine derivatives, such as Safranine and Induline. Phosphine and Acridine Orange are acridine derivatives, while Methylene Blue and Thioflavine both have sulphur as a substantial constituent, the one being a thiazine and the other a thiazol derivative. There are some basic dyes also to be found among the azo colors, such as Bismarck Brown and Chrysoidine; these, however, are also characterized by lack of fastness.

Nearly all the basic dyes may be converted into colorless derivatives by the action of strong reducing agents (such as zinc and hydrochloric acid). These colorless bodies are known as *leuco-compounds*; and in most cases are readily converted into the dyestuff again by simple oxidation (even by action of atmospheric oxygen). Certain of the basic colors, however, such as Indoine, though reduced to leuco-compounds, will not form the original dye again on oxidation.

* The commercial form of basic dyes is usually the chloride, though sometimes the acetate, oxalate, sulphate, or even nitrate may be used. In some cases the dye consists of the double salt of hydrochloric acid and zinc chloride. It is very rarely that the dye is to be met with in the form of the free base. Those basic dyes prepared by the "melt" process (such as Magenta, Methyl Violet, etc.) are usually in the form of crystals, while most others occur as powders.

As a class, the basic dyes give the most brilliant and intense colors of all dyes. As a rule, they have much greater tinctorial power than acid dyes of corresponding color. Their chief drawback is their lack of fastness, especially to light and washing, on which account they must be used with discretion and their field of application is necessarily limited. Like most other large classes of dyes, however, the fastness varies considerably with different individual dyes. Methylene Blue and Induline, for example, when dyed on cotton, show very considerable fastness to light and soaping. In certain cases a dye may be faster when dyed on wool than when used on

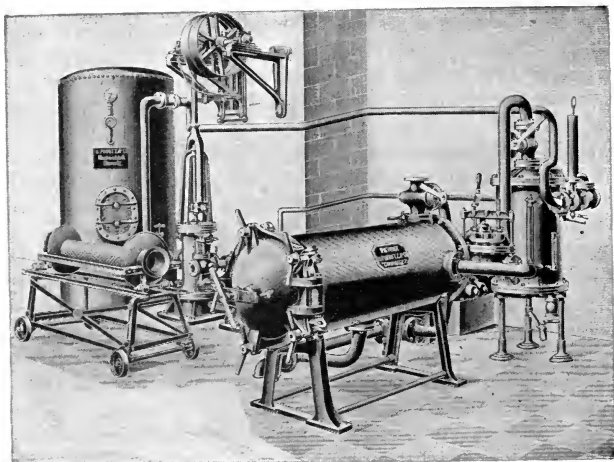

FIG. 152.—Warp Dyeing Machine; Closed Type. (Pornitz.)

cotton; as, for instance, with Magenta. On the other hand, in the case of Methylene Blue and Safranine, the reverse is the case.

Historically considered, the basic dyes are the oldest of the coal-tar synthetic colors. The first was produced by Perkin in 1856 and was known as Perkin's Mauve. As most of them are made from aniline (or homologues of aniline like toluidine), they received the general name of "aniline dyes," and this name has still persisted in the trade as inclusive of all coal-tar dyes; though at the present time, of course, there are a great many coal-tar dyes not made either directly or indirectly from aniline, hence the practice of designating them all as "aniline dyes" is both misleading and erroneous. Owing to the fact that these early basic dyes were rather fugitive, it became a popular impression that all "aniline dyes" are defi-

cient in fastness and are far inferior to the old natural dyes. Strange to say, this impression persists in the popular mind even to the present day, though it is a well-known fact easily demonstrated by actual test, that there are a great many coal-tar dyes possessing qualities of fastness far surpassing those of any of the natural dyes. In fact, one of the chief reasons for the decline in the use of most of the natural dyes is their lack of ability to meet the fastness requirements of the present-day colors.

Though of wide use and of great value in the early days of synthetic dyes, the basic dyes as a class have not the same importance as formerly. The introduction of the acid dyes for wool and silk, as well as the substantive and sulphur dyes for cotton have displaced the basic colors to a

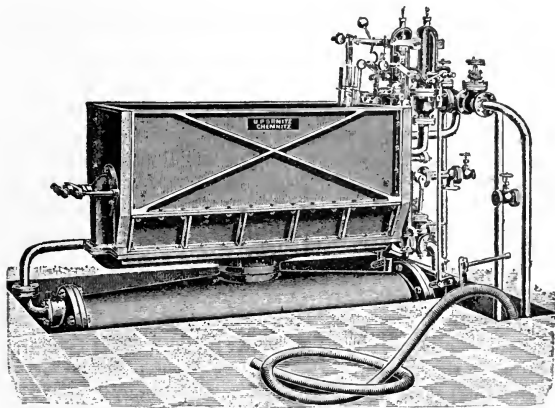

FIG. 153.—Open Dyeing Machine with Automatic Regulating Arrangement for Vacuum, Steam, or Compressed Air, for Warps on Beams. (Pornitz.)

great extent. Many of these other dyes are much faster and much cheaper than the basic dyes, and except where great brilliancy and purity of tone is desired, the basic dyes are not used. In cotton dyeing, their use is restricted on account of the expensive and complicated process of dyeing, three different operations and baths being required,—mordanting, fixing, and dyeing. The basic dyes, however, are still largely used in calico printing and for the production of light tints and brilliant colors on silk. They are also used considerably in paper dyeing and staining and in the dyeing of jute.

2. The Use of Basic Dyes on Silk.—The basic dyes are very largely employed on silk, for the silk fiber has a strong affinity for these coloring matters, and the methods of their application are simple. Further-

more, the colors obtained with the basic dyes are especially characterized by depth and brilliancy, factors which are very important in dyeing silk. On account of the strong affinity of basic colors for silk, it is not always wise to add all of the required dyestuff at once to the bath, but in several portions as the dyeing proceeds. The basic colors, in fact, are especially adapted to silk goods as it is usually desirable on this fiber to obtain clear brilliant colors of pure tones, and also the requirements of fastness to light and washing are not so strict. Silk is usually dyed with the basic dyes in a bath containing boiled-off liquor "broken" (that is, neutralized) with acetic acid; entering the goods at 100° F., and gradually raising to 180° F. Instead of boiled-off liquor, soap may be used, or it may be omitted entirely, the dyebath simply being made up with acetic acid. After dyeing, the silk is rinsed and brightened by passing through a bath slightly acidulated with acetic or tartaric acid, squeezing and drying.

Especial care must be taken in the solution of the basic dyes, for when boiling water is employed for this purpose there is liability of tarry matters being formed by a partial decomposition of the dyestuff. It is best to use warm water acidified with acetic acid. In some cases the dyes are more readily dissolved if a little methylated alcohol is added. Acetin, which is a preparation from acetic acid and glycerin, is sometimes employed for assisting the solution of basic dyes.*

The basic dyes give good exhaustion in the dyebath, and it is seldom necessary to employ standing baths. The temperature when dyeing basic colors is seldom brought to over 180° F., as higher temperatures may cause decomposition of the dyestuff (especially noticeable in the case of Auramine and Diamond Magenta), leading to the formation of sticky, insoluble, tarry products. As the basic colors are quite sensitive to hard water, it is always necessary to correct such water by the proper addition of acetic acid.

The basic colors are especially serviceable in the dyeing of weighted silks where the weighting has been done with tin salts.† An after-treatment with tannic acid and tartar emetic is generally resorted to for the purpose of giving greater fastness to washing.‡

* It has already been remarked that in the case of Auramine, the solution should not be heated over 170° F., as otherwise the dye will suffer decomposition and a precipitate will form. It is also to be noted that solutions of Bismarck Brown and Chrysoidine should not be boiled for any length of time. In dissolving Victoria Blue and Fast Blue for Cotton, the dye should be stirred up with some acetic acid; with the cheaper grades of Magenta, hydrochloric acid should be used.

† No special precautions are necessary in dyeing tin-weighted silk with basic dyes except to give the silk a warm wash before dyeing to remove any unfixed metallic salt. Tin-weighted silk which has been long in stock is liable to dye unevenly, owing to decomposition of the weighting.

‡ Colors on silk are frequently required to be fast to water (that is, should not bleed

The dyeing of weighted silk is done in a boiled-off liquor bath (half boiled-off liquor and half water) just broken with acetic acid; the goods are entered at 100° F., and slowly brought to 180° F. After dyeing, the goods are well rinsed and brightened as usual with acetic or tartaric acid. Some of the basic dyes (Ethyl Green, Diphenyl Blue, Methyl Violet) give colors on silk which have a good fastness to water, but with many of them, the fastness in this respect is not very satisfactory, though the fastness may be much increased by an after-treatment with tannin and tartar emetic. The basic dyes having good fastness to light on silk are Rhodamine, Ethyl Green, Malachite Green, and Diphenyl Blue. On tin-weighted silk, Methylene Blue and Methyl Violet (R brands), also have good fastness to light.

3. Use of Basic Dyes for Wool.—The basic dyes * at the present time do not find much application on woolen goods, as better results are generally to be obtained by the use of acid colors.† In former years, the basic colors were much more used for wool than they are now; but by treatment with sulphuric acid many of the basic dyes can be converted into corresponding acid derivatives which are used instead. Thus, Magenta gives Acid Magenta, Methyl Violet is converted into Acid Violet, etc. The affinity of basic dyes for wool is very great, hence they are liable to dye up uneven unless proper precautions are taken, such as adding the dye solution to the bath in several portions, starting the dyeing at a low temperature, adding some acetic acid or alum to the bath, etc. Rhodamine is quite extensively used on wool for the production of bright pink colors;‡ the dyed material may be bleached with sulphurous acid gas, which when steeped in water overnight). Most basic dyes will not stand this test, though their fastness in this respect may be considerably improved by the following after-treatment. The dyed silk is worked for fifteen minutes at 140° F. in a bath containing 5 to 10 per cent tannic acid, then steeped overnight. Squeeze and work in a bath containing 2½ to 5 per cent tartar. Then wash well and dry. Allowance must be made of the fact that the treatments somewhat dull the tone of the color.

* Victoria Blue is still used considerably in wool dyeing notwithstanding its lack of fastness to light. It gives brilliant sky to royal blues of good fastness to washing and fulling and surpasses all other wool blues for brilliancy. It is usually dyed, however, in a manner similar to that of acid dyes.

† Malachite Green (and also Ethyl Green), though seldom used at the present time for dyeing wool, requires a special method of application to this fiber. Previous to dyeing the wool is treated with what is known as the sulphur mordant in the following manner: For 10 lbs. of wool, use a bath containing 1 lb. of sodium hyposulphite, 1 lb. of alum and 6 ozs. of sulphuric acid; enter the goods at 100° F., gradually raise to 180° F., and work at that temperature for one hour; rinse well, and dye in a bath containing 3 ozs. of sodium acetate, and have the temperature not to exceed 180° F.

‡ Rhodamine is dyed on wool in a bath containing either 5 per cent of acetic acid or 20 per cent of Glaubersalt and 1 to 3 per cent of sodium bisulphate. Victoria Blue is also dyed in the same manner. On this account many dyers are liable to classify these two colors among the acid dyes.

siderably brightens up the color and also gives it greater fastness to light.* Rhodamine pinks are sufficiently fast to washing for most purposes.

Colors obtained with basic dyes on wool are as a rule not very fast to light or washing, and also exhibit a tendency to crock. The basic dyes are used much more on cotton than they are on wool, though even here their importance has been considerably diminished since the introduction of the direct cotton dyes. Where great depth and brilliancy of shade, however, are required, they are still used, for they far surpass the substantive dyes in these respects. In this connection, it may be mentioned that the basic dyes are considerably used for topping both the substantive and the sulphur dyes, for the purpose of brightening the tone (see page 263). The green obtained, for instance, with a Direct Cotton Green or a Sulphur Green is comparatively dull, but if topped in a separate dyebath with even a very small proportion of Malachite Green, the tone of the resulting green color is wonderfully brightened. Dye spots, consisting of uneven streaks or spots, often occur when dyeing with basic colors, caused by precipitation of the color-base in the dyebath either by the use of hard water or by imperfect solution.

4. Experimental. Exp. 84. Dyeing Silk with Basic Colors.—Dye a test skein of silk in a bath containing 150 cc. of water, 25 cc. of boiled-off liquor, and 2 per cent of Magenta; enter the skein at 120° F., and gradually bring to 180° F., and dye at that temperature for one-half hour, then wash well and dry. Silk, like wool, has a direct affinity for the basic colors.

Exp. 85. Dyeing Silk in a Neutral Soap Bath.—Prepare a bath containing 150 cc. of water, 5 per cent of soap (which should be a neutral, olive oil soap).† Work the test skein of silk in this bath for a short time at 140° F., then add 2 per cent of Methylene Blue solution in several portions, at the same time raising the temperature of the bath to 180° F. Continue at this temperature for fifteen minutes, then add sufficient acetic

* Besides Rhodamine there may also be used such dyes as Auramine, Methyl Violet, Victoria Blue, Nile Blue, and Light Green SF. The dyeing is usually conducted in a lukewarm soap bath (containing 1 oz. of neutral soap per gallon of soft water), and after the goods are hydro-extracted they are bleached with sulphurous acid gas in the ordinary "stoying" chamber. For pale, delicate shades on yarns, the bleaching operation may be carried out directly in the dyebath itself by the use of sodium bisulphite solution. About 15 per cent of the latter (32° Tw.) is added to the dyebath, with 10 per cent of Glaubersalt and 2 per cent of sulphuric acid. The dyeing is started lukewarm and brought to the boil. The same dyestuffs mentioned above may be used, and in addition Palatine Scarlet, Tartrazine, and Acid Violet. The bath should not be boiled for any length of time or the colors will be dulled.

† When dyeing souple or éru silk, a soap bath cannot be used, as this would cause a considerable portion of the silk-glué to be removed and thus the silk would lose in weight. In such cases, bast soap (boiled-off liquor) only can be used in the dyebath. It has been proposed, however, to treat the souple or éru silk with a dilute solution of formaldehyde, which has the effect of rendering the silk-glué insoluble. It is said that silk treated in this manner can then be dyed in hot soap solutions without any material loss of silk-glué.

acid to slightly acidulate the bath, and continue dyeing for fifteen minutes longer. Then wash well and brighten with acetic acid in the manner given in Exp. 59. Dye a second sample of silk in the same manner with 2 per cent of Rhodamine.

Exp. 86. After-treatment of Basic Dyes on Silk with Tannin.—Dye a test skein of silk with 2 per cent of Methyl Violet as described in Exp. 84; wash well and pass into

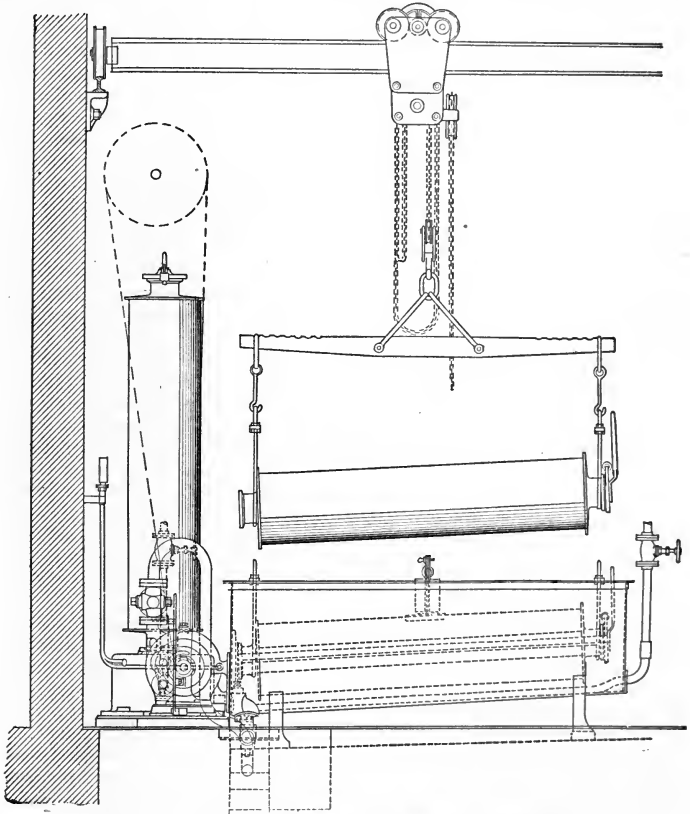

FIG. 154.—Beam Dyeing Machine for Warps. (Haubold.)

a fresh bath containing 100 cc. of water and 1 gram of tannic acid; work for twenty minutes at 180° F., then sink under the liquor and leave for one-half hour without further heating. Squeeze out the excess of liquor and work in a fresh bath containing 100 cc. of water and 0.5 gram tartar emetic at a temperature of 140° F. for twenty minutes. Wash well and brighten with acetic acid as usual. Dye a second skein of silk in the same manner with 2 per cent of Malachite Green.

Exp. 87. General Method of Applying Basic Dyes to Wool.—Basic colors are usually dyed on wool in neutral or slightly acid baths. Dye a skein of woollen yarn in a bath containing 300 cc. of water, 2 per cent of acetic acid, 10 per cent of Glaubersalt, and 1 per cent of Methylene Blue; enter at 100° F., gradually raise to 180° F., and dye at that temperature for one-half hour. Dye another skein of woollen yarn in a similar bath containing 10 per cent of Glaubersalt and 1 per cent of Methylene Blue in the same manner, and note that the dyestuff is absorbed more rapidly. The function of the acid is to retard the dyeing, and so assist in the even distribution and thorough penetration of the color. If the bath in the first case does not exhaust completely, lift the skein and add 4 per cent of borax and continue dyeing for fifteen minutes. The borax is a mild alkali, and is added for the purpose of neutralizing the acid in the bath and so permitting the complete exhaustion of the dyestuff. Acetic acid is better to use in dyeing basic colors than sulphuric acid, as the former is volatile, and as the temperature of the dyebath rises the acidity becomes lessened and consequently the exhaustion is better.

Exp. 88. Showing Effect of Hard Water in Dyeing Basic Dyes.—Prepare two dyebaths with $\frac{1}{2}$ per cent of Magenta; in the one case using distilled water and in the other ordinary tap water. Dye a skein of wool in each of these baths. Both baths should be entirely exhausted. Note that the color is heavier on the first skein than on the second. Add a small quantity of sulphuric acid to each bath; the bath with distilled water will remain colorless, showing that no dye has been left. But the bath with hard water will become colored pink, which is due to the fact that part of the dyestuff was precipitated as the leuco-base, which on the addition of the acid becomes converted again into the colored salt and goes into solution. On this account, it is frequently recommended in dyeing wool or silk with basic dyes to use a small amount of acid in the bath. An excess of acid, however, should be avoided, as it will decrease the exhaustion of the bath.

Exp. 89. Showing the Greater Coloring Power of Basic Dyes over Acid Dyes.—Dye a skein of woollen yarn in a bath containing 300 cc. of water, 10 per cent of Glaubersalt, 4 per cent of sulphuric acid, and 2 per cent of Acid Magenta; enter at 140° F., gradually raise to the boil and dye at that temperature for one-half hour. Dye a second skein in a bath containing 300 cc. of water, 10 per cent of Glaubersalt, and 2 per cent of Magenta; dye for the same length of time and under similar conditions as above. After dyeing, wash and dry the two skeins. Note the depth of color on each, and it will be found that the skein dyed with the acid color is considerably lighter than the one dyed with the basic color.

Exp. 90. Use of a Neutral Bath.—Most basic dyes will dye fairly well on wool from neutral baths, though the water used should be soft, or, if hard, should be corrected by the addition of acetic acid. For each degree of hardness of the water about $\frac{1}{4}$ oz. of acetic acid should be added per 100 gallons of water. Or perhaps a more convenient method is to add acetic acid to the water of the dyebath until it shows a faint acid reaction with litmus paper (turning blue litmus paper red). The color is more apt to be uneven from neutral baths than from those containing acid. Dye a skein of woollen yarn in a bath containing 300 cc. of water, 10 per cent of Glaubersalt, and 1 per cent of Rhodamine; enter at 100° F., gradually bring to 180° F., and continue at that temperature for one-half hour. Wash and dry.

CHAPTER XI

BASIC DYES ON COTTON

1. The Use of Basic Colors on Cotton.—Though the basic dyes possess a strong affinity for the animal fibers, and may be dyed on these in a neutral bath without any other addition than the dyestuff itself, cotton (and the vegetable fibers in general) possesses but a very slight attraction for this class of dyestuffs. A few of the basic dyes, such as Magenta, Chrysoidine, Bismarck Brown, and Methylene Blue, will be absorbed to a certain extent by the cotton fiber; but most of the color may be washed out with cold water, and almost entirely removed with a warm soap solution. An exception must be mentioned of certain dyes among the class of water-soluble indulines, such as Indazine, Indamine Blue, Toluylene Blue, Nigramine, New Gray, Methylene Gray and Indoine Blue, which give dyeings of considerable fastness on cotton with no other addition to the dye bath than sodium acetate.*

In order to dye cotton with the basic dyes it is customary to previously mordant the material with tannin and antimony. It may be considered that a tannate of antimony is precipitated within the fiber which exhibits a strong affinity for the basic dyes and gives with them an insoluble color-lake. The affinity between the dyestuff and the antimony tannate is usually so great that it is difficult to obtain uniform colors in the dyeing, as, for instance, with Methylene Blue, Nigramine, etc. On this account it is advised not to add all of the dyestuff to the bath at once, but to dissolve it up and add the solution in several portions. Furthermore, it is best to start the dyeing at a low temperature and not to raise the temperature too rapidly. As a rule, it will not be necessary to bring the bath to the boil, as the dyeing is usually complete at about 180° F.

In the dyeing of basic colors on cotton the tannin mordant may be applied in one of two ways: (1) steeping the cotton in the solution of tannin for a comparatively long time, then squeezing and fixing with tartar emetic or other suitable salt; (2) padding with the solution of tannin,

* Rather full and fast colors may be obtained in this manner if the dyeing is given an after-treatment with chrome.

which consists in impregnating the cotton with a strong solution for a short time, then squeezing and drying or fixing first with an antimony salt. The first method is that usually employed for yarn dyeing, while the padding method is largely used in cloth dyeing and also for the production of mordanted cloth for purposes of printing. In the steeping process it has been the custom to lay the yarn * down in the tannin liquor overnight, starting at a temperature somewhat under the boiling point and allowing to cool; it is a question as to whether the cotton will absorb much more tannin in this time than in a couple of hours. From experiments which have been performed on this point it would seem that by entering the cotton at a temperature just under the boil and allowing it to steep in the cooling liquor for about 2 hours it will absorb about as much tannin as it would if the steeping was continued for ten to twelve hours.† It is best to start the steeping at a temperature near the boiling point, chiefly for the purpose of driving out air bubbles from the fiber and causing better penetration of the tannin solution. The higher temperature does not appear to influence the actual absorption of the tannin itself by the cotton, as more is absorbed from a cooling bath than from one in which a high temperature is maintained.

The strength of the tannin bath should be based on the amount of coloring matter to be subsequently used, it being customary to take about twice as much tannin (as tannic acid and corresponding amounts of tannin extracts in accordance with the percentage of tannic acid present) as dyestuff; that is, if a color is to be obtained requiring about 2 per cent of dyestuff, about 4 per cent of tannin should be used for mordanting. Where light shades are being dyed it is not customary to preserve the tannin bath, but for dark heavy shades, where baths containing 4 to 10 per cent of tannin are being used, it is best to use the baths continuously,

* Before the yarn is placed in the tannin bath, it is advisable first thoroughly to wet it out in order that the tannin may be effectively and uniformly absorbed. This is especially true if the tannin bath is not used at the boil. If the dry cotton is steeped in the tannin bath, it will be found that often spots and streaks will subsequently develop on dyeing due to the lack of uniform mordanting. In cases when it may not be considered practical to boil-out the cotton first, it is advisable to add some soluble oil (such as Monopol Oil) to the hot tannin bath (1 pint of oil to 100 gallons). This will cause the cotton to wet-out very uniformly in the bath itself even at temperatures considerably below the boil. It is better, however, to always enter the goods in the boiling tannin bath, work for half an hour at that temperature to ensure even penetration of the goods, and then to steep the cotton for two hours in the cooling bath. Under these conditions the cotton will be uniformly mordanted, and will have absorbed practically its maximum amount of tannin. Where hard-twisted and heavy goods are in question, it is always advisable to use some soluble oil in the tannin bath.

It has been shown that cotton absorbs tannic acid most readily at a temperature of about 105° F.

freshening the standing bath each time with 3 to 4 per cent of tannin.* The amount of liquor used in the mordanting bath should not be more than fifteen to twenty times the weight of the cotton; that is, each pound of cotton should have about 2 gallons of water for mordanting; if a greater amount of water is used, the proportion of tannin absorbed by the fiber will be lessened and a correspondingly larger amount of tannin will have to be used.

The water employed in the mordanting bath should be as free from iron as possible if the tannin is to be fixed with antimony; for iron present in even a slight trace will alter the color of the dyeing considerably, especially in the case of pale shades. If the water does contain any iron, a small

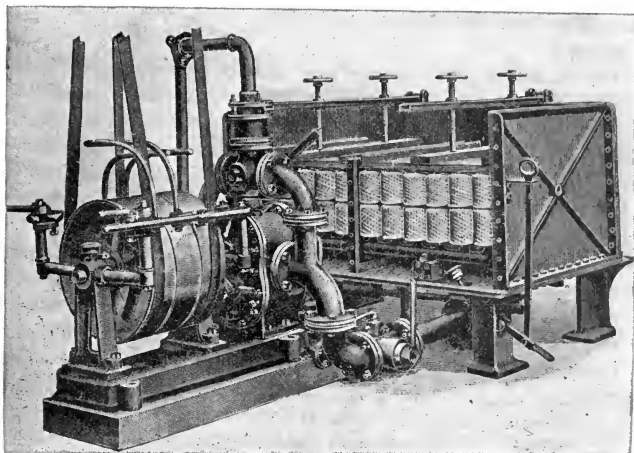

FIG. 155.—Dyeing Machine for Yarn in Form of Spools. (Erckens & Brix.)

amount of hydrochloric acid should be added which will hold the iron tannate in solution and prevent it from contaminating the fiber. Hard water, that is, a calcareous water, unless of very considerable hardness, is not especially detrimental for use with tannin; if there is much lime present, it may result in the precipitation of some of the mordant in the form of tannate of lime. Such water may be best corrected by the addition of sufficient acetic acid to give a slight acid reaction to the bath previous to the addition of the tannin.

* Since the tannin bath exhausts but very incompletely, it is nearly always the practice in dyehouses to maintain a standing bath. Usually about one-half the quantity of tannin used in the first bath is added for each subsequent lot of goods. In case old tannin baths show a tendency to ferment, they should be boiled up from time to time, or some preservative such as salicylic acid may be added to the solution.

After the steeping in the tannin is completed, the cotton should be well squeezed or wrung out to remove the excess of liquor; in practice this may be best accomplished by hydro-extraction. It is not advisable to rinse the cotton after removal from the tannin bath, as this will only result in redissolving some of the absorbed tannin, and the residual liquor in the cotton will still be a solution of tannin; so that the rinsing does not serve the purpose of removing such residual liquor, but only results in the lessening of the mordant. There does not appear to be much difficulty attached to the uneven squeezing or wringing of the mordanted cotton leading to uneven results in the subsequent dyeing; probably if the tannin through one cause or another, is distributed very unevenly through the cotton, there may result uneven dyeing, yet under ordinary conditions particular caution does not have to be taken in the even squeezing of the wet cotton.*

After the mordanted cotton is squeezed the next operation is to pass through a fixing bath containing tartar emetic or other suitable salt of antimony. The fixing is complete in from fifteen to thirty minutes and a cold bath is used; the amount of tartar emetic necessary is about one-half that of the tannin used; in other words, it is about equivalent to the amount of dyestuff to be used.† For other antimony salts, corresponding amounts must be used.

The reaction in the fixing bath consists of the formation of antimony tannate in the fiber, and it should be so adjusted that all of the tannin present is thus combined; this reaction necessitates, of course, the liberation in the bath of the acid previously combined with the antimony—with tartar emetic there would be liberated tartaric acid.‡ On this account

* The tannin should be fixed as soon as possible after mordanting, otherwise the tannin will drain more to one part of the goods than another and result in uneven dyeing.

† The following table shows the usual relation between dyestuff, tannin and tartar emetic.

Dye %	Tannin %	Tartar Emetic %
0.1	$\frac{1}{2}$	$\frac{1}{4}$
$\frac{1}{4}$	1	$\frac{1}{2}$
$\frac{1}{2}$	$1\frac{1}{2}$	$\frac{3}{4}$
1	3	$1\frac{1}{2}$
$1\frac{1}{2}$	5	$2\frac{1}{2}$
2	8	4

‡ A process has lately been devised relating to the better fixation of the tannin by tartar emetic when mordanting cotton for dyeing with basic colors. In this connection a study has been made of the proper conditions for the most economical fixation of the tannin. It has been demonstrated that the fixation of the tannin by the tartar emetic is not effected as rapidly as has generally been supposed. The maximum degree of fixation is obtained by a treatment of about forty minutes' duration in the tartar emetic bath; if the treatment is continued for a longer period than this, however, the amount of tannin fixed is diminished rather than increased. But the new process to

when using the fixing liquor as a standing bath, it will be necessary to add sufficient soda ash from time to time to neutralize the acidity,* otherwise the tannate of antimony will be dissolved from the fiber. When the fixation of the tannin mordant is completed the cotton must be thoroughly washed for the purpose of removing all uncombined tartar emetic or tannin; if excess of either of these is present in the fiber when it is passed into the dyebath it will result in the loss of coloring matter and probably lead to streaked and imperfect dyeing.† After the mordanting and fixing operations are finished too long a time should not elapse before the dyeing, for if the mordanted cotton is exposed for any length of time to the air and light the exposed parts will turn somewhat brownish and after dyeing will appear duller. If the dyeing cannot be carried out the same day as the mordanting and fixing,‡ the material should be covered with a moistened cloth.

In some cases, in order more thoroughly to combine any excess of tartar emetic in the fiber after fixing, the cotton is passed back into the tannin bath (usually a rather weak one). This "back-tanning" may also be done after dyeing; it also appears to give some colors a greater fastness to washing. As antimony compounds are of a poisonous nature they should be thoroughly fixed in the fiber, as otherwise blood poisoning might result from fabrics worn next the skin. In certain cases (as with Victoria Blue and Methylene Blue) in order to obtain even shades it is necessary to wash the cotton after fixing for fifteen to thirty minutes in a warm soap bath (containing about 2 ozs. soap to 10 gallons of water), and afterwards wash in fresh water. This treatment usually produces clearer and more even shades.

In the dyeing it is best to start the bath cold, using twenty-five to thirty times as much water as cotton (1 lb. of cotton would therefore require about 4 gallons of water), and adding first about 1 to 1½ per cent of acetic acid; this serves the purpose of correcting any hardness in the water and thus prevents any precipitation of coloring matter, and also makes the bath slightly acid which avoids too rapid an exhaustion of dye-stuff in the dyeing. After the acid has been placed in the bath a portion

which reference has been made is the addition of common salt to the tartar emetic bath. This addition, it has been shown, increases very materially the amount of tannin fixed upon the fiber. Furthermore, the solution of tartar emetic may be made much more dilute, and the time of treatment may be considerably reduced to obtain the maximum fixation of the tannin. The amount of salt recommended to be used in this connection is about 6 ozs. per gallon, and the addition is made directly to the bath of tartar emetic.

* Sufficient soda ash should be added to cause a slight turbidity in the bath. Excess of alkali will cause loss of the antimony fixing agent.

† In the case of dyeing heavy shades where a strong mordant is employed, it is best to give the goods a slight soaping after fixing with tartar emetic. This will more effectively remove the unfixed mordant and give colors which are faster and more uniform.

of the color solution is added, and then the cotton is entered and worked for about ten minutes; the material is then lifted, and a further portion of the dyestuff solution added, the bath being heated to about 100° F. Finally the rest of the color is added and the bath is raised to about 140 to 160° F., and the dyeing completed. In place of acetic acid, an addition of about 3 per cent of aluminium sulphate or 5 per cent of alum may be made.* In the case of certain basic colors the dyeing is finished by raising the temperature of the bath to the boil, as with Naphthindone. †

When the tannin mordant is to be fixed with iron instead of antimony, where dark colors are to be employed, the fixing bath is made up with 3 to 5 per cent of copperas, or consists of nitrate of iron at 3 to 4° Tw. The bath is employed cold, and it is well to add a small quantity of chalk (calcium carbonate) to prevent the accumulation of acid (from the acid combined with the iron salt and which will be liberated when the iron combines with the tannin to form tannate of iron); about 2 to 4 per cent of chalk will be all that is necessary. Dyeings on an iron-tannin mordant are not so fast ‡ as those on an antimony-tannin base, so the process of fixing with iron is sometimes modified by first fixing with antimony and subsequently with iron, or even by saddening with an iron liquor after the dyeing is finished.

In some cases increased fastness to washing for basic dyeings may be obtained by giving the dyed goods a passage through the tannin bath (the old tannin liquor may be used), wringing out, and then passing through the tartar emetic bath again and washing well.§

* With certain dyes alum is said to give better results than acetic acid. It is recommended in dyeing Soluble Blue, Fast Blues, and Nigrosines to use 5 to 10 per cent of alum in the dyebath.

† Colors dyed with Victoria Blue are made brighter and more uniform if after dyeing the goods are soured for twenty minutes at 140° F., with 1 to 3 per cent of sulphuric acid. After souring, the goods are rinsed and soaped at 180° F. for twenty minutes with 10 per cent of soap.

‡ The iron-tannin lake is not fast to acids, as these decompose the lake into soluble compounds.

§ It will generally be noted, however, that this treatment has a tendency to dull the colors obtained; though shades fast to boiling soap solution may be obtained in this manner with the following dyes:

Auramine	Brilliant Green
Acridine Red	Pyronine G
Acridine Scarlet	Capri Green
Acridine Orange	Capri Blue
Cresyl Blue	New Metamine Blue
Fast Blue	Victoria Blue
Indol Blue F.	Cresyl Fast Violet
Malachite Green	Methylene Blue

Safranine

An aluminium-tannin mordant is sometimes used for the production of bright pinks with the Rhodamines. The yarn is mordanted in the usual manner with tannic acid; squeezed, and passed through a bath containing 20 gallons of aluminium acetate liquor (9° Tw.) per 100 gallons of bath. Rinse well and dye with Rhodamine.

Certain of the basic colors, such as Naphthindone and Irisamine, may be dyed on cotton direct without a mordant.* The dyebath is prepared with 3 to 5 lbs. of salt per 10 gallons of liquor according to the depth of shade; the dyeing is started at 100° F., and the bath is slowly brought to the boil; after dyeing the goods are simply wrung out as evenly as possible and dried. This method is not often practiced, as the colors obtained are not very fast to washing or light. †

Cotton may also be dyed with basic colors by using other mordants than tannin. A fatty acid mordant is used in certain cases, especially for light and brilliant shades.

Light delicate shades may be obtained by dyeing direct on bleached cottons with such basic dyes as Rhodamine, Diamond Green or Methylene Blue. Use a dyebath containing 1 to 2 per cent of acetic acid. After dyeing, squeeze without rinsing and dry. The colors obtained in this manner, of course, are not fast to washing. ‡ The following dyes may also be dyed direct on cotton, using alum in the bath: Indone Blue, Indoine Blue, Victoria Blue, Soluble Blue, Pure Blue and Water Blue. The dyeing is carried out in a short bath at 140° F., with the addition of 1 to 4 per cent of alum; then slowly bring to the boil and work for twenty minutes. Wring and dry without rinsing. The colors obtained in this manner are very brilliant but are not fast. Methylene Blue and Soluble Blue may also be dyed, by first working in a bath containing 4 to 5 lbs. of soap (per 100 gallons) for one-half hour at 140° F.; squeeze and pass through a cold bath containing 2 lbs. of stannous chloride (per 100 gallons); rinse and dye

* Indol Blue may be dyed direct by adding 5 per cent of alum and 10 per cent of common salt to the bath and dyeing at 180° F. for one hour. Rinse and work the material in a fresh bath for one-half hour at 90° F. with 1½ times the quantity of tannic acid as dyestuff. By using the tannin bath at lower temperature, redder shades are obtained, while at higher temperatures, the shades are greener in tone.

† *Single Bath Method* (Höchst).—Use a cold dyebath containing 6 to 8 per cent of acetic acid; then add 1 to 2 per cent of tannic acid, and finally the dyestuff solution (up to 1 per cent). Enter the cotton; work for one-half hour cold, then one-quarter hour at 110° F., and one-quarter hour at 140° F.; then rinse, wring out, and dry. Faster colors are obtained by dyeing as above and adding to the first rinsing bath, ½ to 1½ per cent of tartar emetic. Small quantities of dyestuffs may be added to this bath for purposes of shading.

‡ Very brilliant colors may be obtained with Methyl Cotton Blue by dyeing the bleached cotton in a bath containing 1 lb. of alum, ¼ lb. of tartar emetic and the required dyestuff; work for one-half hour at 120° F., then squeeze and dry without rinsing.

in a fresh bath containing 1 lb. of alum (per 100 gallons) for one hour at 140° F. Wring and dry.

For the production of bright pinks on cotton certain basic dyes, like Irisamine and Rhodamine, and combinations of these with Auramine and Safranine, may be used on a mordant of Turkey-red oil.* The yarn is mordanted in lots of 1 pound each in a liquor containing 1 part Turkey-red oil and 2 parts of water, and after each lot is mordanted about 1 pint of such a mixture is added afresh. After mordanting, the yarn is wrung out well, straightened and dried, after which the same treatment is repeated. The dyeing is conducted in a cold concentrated bath with addition of some acetic acid, the color solution being added in several portions. In

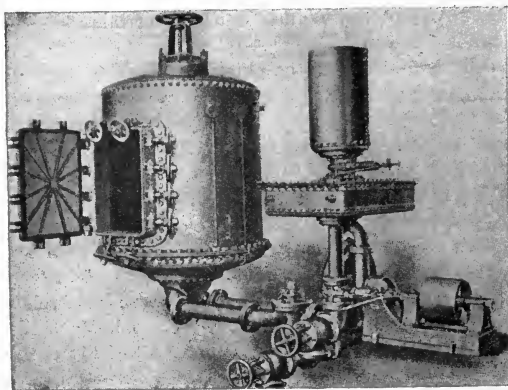

FIG. 156.—Franklin Dyeing Machine for Yarn, etc., on Spools and Cheeses.

order to produce level shades it is necessary that the yarn be wrung out as evenly as possible and that the mordanting be repeated several times.

When light shades and bright tints are to be dyed on cotton it will be necessary first to bleach the yarn or cloth that is to be dyed in order to provide a satisfactory white bottom for the color. For this character of work considerable care must be taken in the bleaching operations to have a uniform bleach, and to avoid any degree of overbleaching that may lead to the formation of oxycellulose, as such conditions will almost inevitably result in uneven dyeings or streaky goods. Bleached cotton also,

*Basic Dyes on a Turkey-red oil mordant or on an alum mordant have but limited application to cotton, as the colors run badly and are not fast to washing. They are sometimes employed where great brilliancy is the chief feature.

as a rule, shows much greater affinity for the color, and proper precautions must be used in order that the dyestuff is not taken up too rapidly. For the production of certain delicate tints on bleached cotton several of the basic dyes may be used without a mordant. The color obtained on bleached cotton is much faster than that on unbleached cotton.

Soap may also be used as a source of the fatty acid mordant, in which case it will be necessary to have a metallic fixing agent in order to form an insoluble compound with the fatty acid. The colors obtained with fatty acid mordants are usually much brighter than those on a tannin mordant, but the fastness to washing is very poor as is also the fastness to light.*

Certain dyestuffs also act as mordants for basic colors. Cotton dyed with sulphur colors, for instance, may be dyed in a fresh bath with basic dyes; cotton dyed with substantive dyes also acts in the same manner. Only a comparatively small amount of basic dye (up to $\frac{1}{2}$ per cent) is taken up in this process, but it is sufficient to considerably influence the shade. The process is chiefly used for the purpose of brightening the colors obtained with sulphur or substantive dyes, and the operation is called "topping." The colors obtained have a fairly good fastness, as a rule, especially if after-treated with tannin and tartar emetic. Cotton dyed with Alizarine dyes, Logwood and the natural dye-woods, and Aniline Black may also be topped with basic dyes.

Though in dyeing operations, tannin and fatty acid mordants are about the only ones employed in practice for basic dyes, there are a number of other mordants which have been proposed for use in printing. For instance, the sulphides of zinc and tin have been used, as well as the zinc salts of hydroferro- and hydroferricyanic acids, obtained by precipitating zinc salts with yellow prussiate and red prussiate of potash (see Balanche, *Jour. Soc. Chem. Ind.*, 1882, p. 182 and Reber, *ibid.*, 1885, p. 343).

Besides their general use in the dyeing of textiles, the basic dyes are also largely used for the preparation of writing and hectographic inks, lakes for lithographic inks, for coloring typewriter ribbons, copy-paper, pencils, etc.

2. Substances Employed for Mordanting Cotton.—Tannins. By the general term "tannins" is meant a number of related organic acids which occur as the astringent principles in vegetable life. They are generally analogous in their chemical properties and are characterized by their

* The method of mordanting cotton with soap is as follows: Use a bath containing 2 gallons of water and 2 lbs. of neutral soap at about 180° F. Steep the cotton in lots of 1 lb. each in this bath for several minutes; wring out and dry at a moderate heat. For heavier mordanting, the operations must be repeated several times. To fix the fatty acid, work the cotton in a bath consisting of a dilute solution of aluminium acetate at 150° F. (1 gallon of aluminium acetate liquor, 8° Tw., to 200 gallons of water). Wash, squeeze, and pass through a weak soap bath (1 lb. of soap to 100 gallons water). Finally wash well and dye.

property of tanning animal skins (that is, converting the animal tissue into leather), forming insoluble compounds with albumin, precipitating basic dyes from solution, and yielding bluish or greenish black colors with solutions of iron salts. The majority of the natural tannins also contain yellowish or brownish coloring matters; pure tannic acid, however, has no special color. Some of the tannins, such as decoctions of gallnuts and extracts of sumac, may be almost entirely decolorized by proper methods of treatment. Where delicate and bright colors are to be obtained on cotton with basic dyes it will be necessary to employ either pure tannic acid or a decolorized sumac extract.

Though cotton is in general very inert towards solutions of organic acids, it appears to possess considerable affinity for tannic acid, and will absorb it readily from its solutions. Tannins should be stored in a dry place, as continued exposure to damp air will cause the tannic acid to decompose, giving brownish colored resinous substances. The following are the most important tannins employed in the mordanting of cotton:

(1) *Tannic acid*, or gallo-tannic acid, is prepared especially from gallnuts, which are very rich in this acid. Tannic acid comes on the market in the form of a light brown powder or yellowish to brownish scales which usually darken somewhat on exposure to light. It is soluble in 6 parts of cold water, and in even a less quantity of hot water; it is also freely soluble in alcohol, dilute acetic acid, and glycerin. Solutions of tannic acid, and also of any of the tannins, will gradually undergo fermentation and become destroyed. In order to prevent this decomposition in standing baths used for mordanting, it is advisable to boil up the baths repeatedly or to add a small amount of carbolic acid to them. When used as a standing bath about 70 per cent of the amount of tannin originally added to the first bath should be used for replenishing.

(2) *Sumac* is next in importance to tannic acid for purposes of dyeing cotton. The sumac from the *Rhus coriaria* is considered the best and it contains gallo-tannic acid. Sicilian sumac is the best and least colored variety; after this comes the American (Virginian) sumac, which can now be obtained in very good qualities. Commercial sumac usually consists of the whole or the crushed or pulverized leaves, though the stalks and small stems are frequently admixed. Good qualities have an olive-green color and a pleasant smell; they contain from 15 to 20 per cent, and sometimes as high as 25 per cent of tannin. Sumacs which are dull in color and of a musty smell have deteriorated by exposure to moist air and prolonged storing. Sumac contains a small amount of dull reddish brown coloring matter, which prohibits its use in most cases for light and brilliant shades, so that it is chiefly employed for dark shades. Sumac extract is a thick dark brown liquid or paste, usually of about 52° Tw. density. It also occurs in the solid state. Decolorized sumac extracts

are also to be had, and may be used in place of pure tannic acid for light colors. Liquid sumac extracts are very liable to fermentation, especially if kept in a warm moist room.

(3) *Galls*, or gallnuts, are ball-shaped excrescences which grow on various plants, especially oak trees, and result from the sting of an insect in depositing its eggs. Of the oak-galls, the green or black Aleppo galls and the Turkish or Levant galls are the best and contain about 55 to 60 per cent of gallo-tannic acid. Chinese and Japanese galls contain up to 80 per cent of gallo-tannic acid, and these are principally used for the production of pure tannic acid.

(4) *Myrobolans* consist of the fruit of several Chinese and Indian plants, and they occur in trade in the dry state; they contain 25 to 45 per cent of

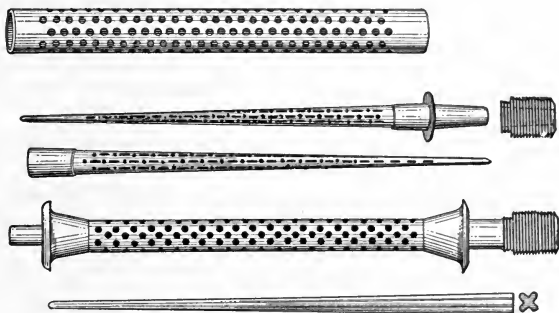

FIG. 157.—Perforated Spindles for Cops and Tubes for Dyeing.

tannin and a yellowish brown coloring matter. They are not much used in this country, though sometimes employed for dyeing cotton black.

(5) *Divi-divi* is the fruit of certain plants in Central and South America; they contain 20 to 35 per cent of tannin, and are used in the same way as myrobolans. There are many other tannin substances which are more or less locally employed where they are to be obtained in abundance, but the above mentioned varieties are the principal ones to be met with in trade. In the mordanting of cotton for dyeing, 1 lb. of pure tannic acid is equivalent to about $1\frac{1}{2}$ to 2 lbs. of gallnuts, or 4 lbs. of sumac extract of 25 per cent strength, or to 5 to 6 lbs. of sumac leaves.

3. Tartar Emetic and Antimony Salts.—Tartar emetic is the double tartrate of antimony and potassium; it is a crystalline salt and is not very soluble in cold water, but it is rather easily soluble in hot water.* One

* The solubility of tartar emetic may be much increased by the addition of common salt. Prudhomme, who first observed this fact (*Bull. de Mulhouse*, 1890, p. 549)

part of the salt requires about 13 parts of water for solution at 70° F. and only about 3 parts of water at 180° F. The active principle in tartar emetic which enters into the fixation of the tannin in the mordanting of cotton is the antimony trioxide, Sb_2O_3 , of which the pure salt contains 43.4 per cent. The commercial product consists of fine crystals of irregular lumps containing about 43 per cent of antimony trioxide. It is frequently adulterated with cheaper substances. Though tartar emetic and the rest of the salts of antimony are poisonous, no ill effects need be feared from its use in dyeing, if the goods are well washed after mordanting. As tartar emetic is rather an expensive chemical, it is often replaced by cheaper salts of antimony, which have the same effect in the fixation of the tannic acid. The chief substitutes are as follows:

(1) *Antimony salt*, which is the double salt of antimony fluoride and ammonium sulphate; it occurs as white crystals, of which 140 parts are soluble in 100 parts of water. The solution is strongly acid and corrodes glass and metals, owing to the hydrofluoric acid liberated. Antimony salt contains 47 per cent of antimony trioxide; hence 9 parts are equivalent to 10 parts of tartar emetic.

(2) *Patent salt*, or *double antimony fluoride*, is antimony-sodium fluoride. It is also crystalline and readily soluble, and likewise corrodes glass and metals. It contains 66 per cent of antimony trioxide; hence 65.8 parts of this salt are equivalent to 100 parts of tartar emetic. Of these two double fluorides of antimony, 5 to 20 parts are dissolved in 1000 parts of water, and their strong acidity is neutralized by the addition of 6 to 8 per cent in weight of soda ash, or just enough to render the bath slightly turbid.

(3) *Antimony oxalate* is the double oxalate of potassium and antimony, and was introduced as the first cheap substitute of tartar emetic; it has given much satisfaction, but has been nearly superseded by the double fluorides. It occurs as crystals which are readily soluble in water, but which dissociate rapidly into an insoluble basic oxalate of antimony and a soluble binoxalate. It contains only 25.1 per cent of antimony trioxide, as against 43.4 per cent in tartar emetic; though it is claimed to replace equal weights of the latter, as it combines more rapidly with tannic acid.

(4) *Antimonine* is the double lactate of antimony and calcium. It occurs as crystals containing 15 per cent of antimony trioxide,* it is hygro-

attributed it to the formation of a molecular compound between the salt and the tartar emetic. This view, however, has later been disproved, and the reaction is attributed to a reversible double decomposition between the two salts, as follows:

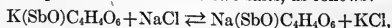

and it is the formation of the sodium salt which accounts for the increased solubility.

* It is said, however, to have the same effect, weight for weight, as tartar emetic, as all of the antimony oxide it contains enters into the reaction. This claim seems hardly

scopic and very readily soluble. It should be employed in a weakly acid solution, that is, with the addition of about $1\frac{1}{2}$ pints of acetic acid per 100 gallons of liquor. This product is quite extensively employed.

The fixing bath of tartar emetic, like that of the tannin, may be employed continuously, being freshened up accordingly. As the bath becomes acid on using, due to the removal of the antimony trioxide, a little soda ash should be added from time to time to neutralize the acid as it accumulates; this is best done by adding a dilute solution of soda ash until a slight turbidity is apparent.* If the liberated tartaric acid is allowed to accumulate without being neutralized, it will act so as to redissolve the precipitated antimony tannate, and thus lessen the value of the fixing bath.

4. Experimental. Exp. 91. General Method of Dyeing.—As cotton does not possess acidic properties, it does not combine directly with basic dyes, but requires an acid substance (mordant) to be added to the fiber in order for the dyeing to take place. Cotton readily absorbs tannic acid from solution, and as this acid forms good color-lakes with the basic dyes, it is a very suitable mordant for cotton in this connection. To illustrate this reaction, proceed as follows: Steep a skein of cotton yarn in a bath containing 300 cc. of water and 2 per cent of tannic acid; enter at 120° F., raise to 190° F., then allow the skein to remain immersed in the bath without further heating, as it is found that the maximum amount of tannic acid is absorbed from a cooling bath. Now squeeze the skein, and together with an unmordanted skein of cotton yarn pass into a dyebath containing 300 cc. of water and 1 per cent of Methylene Blue; enter at 100° F., gradually raise to 190° F., and dye at that temperature for one-half hour; wash well and dry. It will be found that the mordanted skein has become dyed, whereas the other skein has only become slightly tinted. As tannic acid is liable to suffer decomposition at the boil, giving rise to brown coloring matters and resinous products, it is not recommended to boil the mordanting bath, as the shade eventually obtained will probably be dulled. The tannin, by this method of treatment, is not held in an insoluble state in the cotton, so that when the goods are placed in the dyebath some of the tannic acid passes again into solution in the dye liquor, causing some of the dyestuff to be precipitated and also causing a loss of color to the fiber. Hence it is customary to fix the tannic acid in an insoluble condition on the fiber before passing into the dyebath, as will be described in a succeeding experiment. Tannin is a vegetable astringent principle and occurs in many plants or vegetable extracts, such as sumac (containing about 20 per cent of tannic acid), cutch (containing about 40 per cent of tannic acid), etc. These vegetable extracts may be used in place of tannic acid itself, provided sufficient amount of them be taken to give the proper amount of actual tannic acid. Many of these vegetable extracts, however, also contain more or less brown coloring matters associated with the tannin, and these are absorbed by the cotton, causing the latter to become considerably colored in the mordanting.

Exp. 92. Fixing Tannin on Cotton with Tartar Emetic.—In order to fix the tannin mordant absorbed by the cotton from the mordanting bath so that it will not dissolve

probable, as it would mean that the tartar emetic is only one-third exhausted from the fixing bath.

*The addition of common salt to the fixing bath is said to be more beneficial than that of soda ash, as the presence of salt causes the quantitative fixation of the tannin by the tartar emetic.

into the dyebath, it is best to combine it with some metallic base and so form an insoluble tannate. Most of the tannates of the metals are dark in color, hence unsuitable for dyeing, except for the production of a limited range of shades. The tannate of antimony, however, possesses but very little color, and scarcely affects the resulting color of the dye. Tartar emetic is potassium antimony tartrate, and it is the antimony oxide present in the salt which serves the purpose of fixing the tannin; that is, the tannin reacts with the tartar emetic to form antimony tannate. Proceed as follows: Mordant a skein of cotton yarn in a bath containing 300 cc. of water and 2 per cent of tannin as

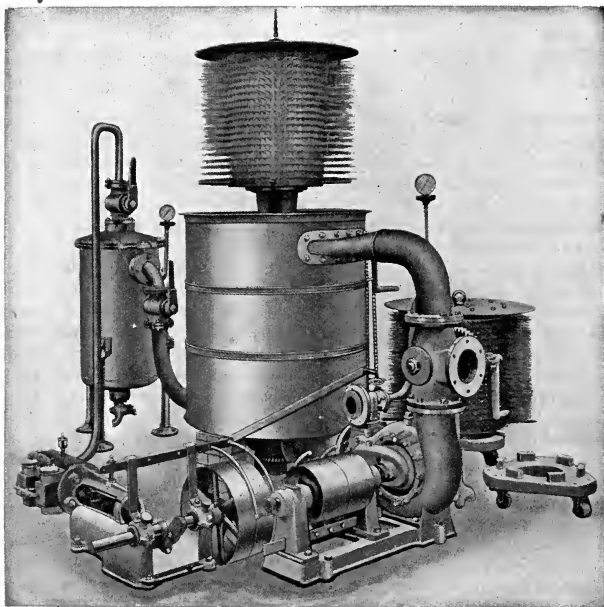

FIG. 158.—Dyeing Machine for Cops, etc. (Haubold).

before described; squeeze and pass into a fresh bath containing 300 cc. of water and 1 per cent of tartar emetic; work cold for fifteen minutes. Then wash well in fresh water to remove any excess of the antimony compound and any unfixed tannin, and pass to a dyebath containing 300 cc. of water, 1 per cent of Methyl Violet, and 2 per cent of acetic acid; enter at 100° F., gradually raise to 190° F., and dye at that temperature for one-half hour. The amount of tannin used in mordanting should be about twice that of the dyestuff, and the amount of tartar emetic should be about one-half that of the tannin. The acetic acid is employed for the purpose of retarding the dyeing, so as to promote even and well penetrated colors.

Exp. 93. Fixing Tannin with Copperas.—Copperas is iron sulphate, and as it occurs in the form of green crystals, it is known as "green vitriol." Salts of iron combine with tannic acid to give black tannate of iron, hence tannin fixed on cotton with copperas or other iron salts gives the fibers a gray to black color, which, of course, affects the shade eventually dyed on the mordant. Mordant a skein of cotton yarn in the manner described above with 2 per cent of tannin, squeeze, and steep for fifteen minutes in a cold bath containing 300 cc. of water, 5 per cent of copperas and 5 per cent of whiting. The latter is calcium carbonate or chalk, and is added in order to keep the bath neutral, for when the tannic acid combines with the iron of the copperas there is liberated some sulphuric acid, and as tannate of iron is soluble in sulphuric acid, it will be redissolved. The chalk in the bath combines with the sulphuric acid as fast as formed, and thus keeps the bath neutral, so that the iron is able to combine fully with the tannic acid. Wash the mordanted skein, which will now have a gray or slate color, and preserve a sample for comparison, then dye the rest of the skein in a bath containing 300 cc. of water, 1 per cent of Methylene Blue and 2 per cent of acetic acid in the usual manner. Wash and dry. In the same bath with this skein also dye a skein of cotton yarn which has been mordanted in the usual manner with tannin and fixed with tartar emetic. Notice the difference in the colors obtained, due to the iron mordant; also compare the mordant color with the dyed color, and note the influence of the bottom color of the mordant on the resulting color-lake.

Exp. 94. Use of Other Agents in Dyeing Basic Dyes.—Mordant a test skein of cotton yarn in a bath containing 300 cc. of water and 20 per cent of sumac extract. Enter at 190° F., work the cotton in the bath for fifteen minutes, then steep under the liquor for one hour without further heating. Squeeze the skein and pass into a fresh bath containing 300 cc. of water and 2 per cent of antimony salt (a double salt of antimony fluoride with ammonium sulphate); work cold for fifteen minutes, then wash well and dye in a fresh bath containing 300 cc. of water, 5 per cent of alum, and 2 per cent of Thioflavine T. Conduct the dyeing operation as usual. Wash well and dry.

Exp. 95. Dyeing Basic Colors in One Bath.—Prepare a cold bath containing 300 cc. of water, 6 per cent of acetic acid, 2 per cent of tannic acid, and 1 per cent of Malachite Green. Dye a skein of cotton yarn in this bath cold for fifteen minutes, then raise the temperature to 105° F. for fifteen minutes, and finally to 140° F. for fifteen minutes; then rinse the skein, squeeze, and dry. The fastness to washing of the colors dyed in this manner may be increased by first rinsing after dyeing in water containing $\frac{1}{2}$ to 2 per cent of tartar emetic. This method is only applicable to amounts of dyestuff up to about 1 per cent. The color-lake is held in solution by the presence of the acetic acid, and only separates out gradually in the fiber on heating the bath.

Exp. 96. Use of the Janus Dyes.—These dyestuffs are basic colors which also possess substantive or direct dyeing properties, though to form a fast color-lake it is necessary to fix the dye with tannin. Prepare a dyebath containing 300 cc. of water, 2 per cent of acetic acid, 5 per cent of zinc sulphate, and 2 per cent of Janus Red. Add only a portion of the dyestuff solution at first; enter the cotton skein at about 200° F., work for ten minutes, then add the remainder of the dyestuff; work for ten minutes longer, and then add 20 per cent of common salt, and work for one-half hour at the boil. Rinse the dyed cotton, and pass into a fixing bath containing 300 cc. of water, 4 per cent of tannic acid; work cold for fifteen minutes; then lift the skein and add to the bath 2 per cent of tartar emetic and 1 per cent of sulphuric acid, and work cold for fifteen minutes longer, then raise the temperature to 140° F. for fifteen minutes. Finally wash well and dry.

CHAPTER XII

PRINCIPAL BASIC DYES

1. List of the Principal Basic Dyes.—The basic dyes do not include such a large list as the acid dyes, though the apparent number is considerably increased by the fact that the same dyestuff is frequently given a variety of different names, and furthermore, a number of mixtures are marketed under specific names. Some of these dyes are more adapted to the dyeing of silk than of cotton, and vice versa; this can only be determined by reference to the specific properties of the individual dyestuffs.

(a) Red

Acridine Red	Diamond Magenta	Parafuchsin
Acridine Scarlet	Fast Pink	Patent Rhodamine
Aniline Maroon	Fast Red	Pyronine
Aniline Scarlet	Fuchsin	Rhodamine B, G, 6G
Anisoline	Geranium	Rhodine
Bordeaux	Grenadine	Rhoduline Pink
Brilliant Rhoduline Red	Induline Scarlet	Rhoduline Red
Brilliant Rose	Irisamine	Rhoduline Scarlet
Brilliant Safranine	Isorubine	Rosazeine
Camelia	Janus Bordeaux	Rosole Red
Cardinal	Janus Red	Rosole Scarlet
Cardinal Red	Magenta	Rubine
Carthamine	Magenta Scarlet	Russian Red
Cerise	Maroon	Safranine
Clemantine	Neutral Red	Safranine Scarlet
Cotton Red	Neutral Scarlet	Tannate Fast Scarlet
Diamond Fuchsin	New Magenta	Tannate Rubine

(b) Orange

Acridine Orange	Cotton Orange	New Phosphine
Azo Phosphine	Diamond Phosphine	Paraphosphine
Brilliant Phosphine	Flavinduline	Patent Phosphine
Canelle	Flavophosphine	Phosphine
Chrysoidine	Homophosphine	Rhoduline Orange
Coriphosphine	New Acridine Orange	Tannin Orange

(c) Yellow

Acridine Golden Yellow	Benzoflavine	Methylene Yellow
Acridine Yellow	Corioflavine	Philadelphia Yellow
Aniline Yellow	Euchrysin	Rheonine
Auracine	Flavazol Yellow	Rhoduline Yellow
Auramine	Janus Yellow	Thioflavine T
Aurophosphine	Leather Yellow	Xanthine

(d) Green

Azine Green	Ethyl Green	New Fast Green
Bengal Green	Fast Greens	New Green
Benzol Green	Imperial Green	New Solid Green
Brilliant Green	Janus Green	New Victoria Green
Capri Green	Light Green	Tannate Dark Green
China Green	Malachite Green	Tannate Fast Green
Diamond Green	Methyl Green	Victoria Green
Diazine Green	Methylene Green	Zinc Green
Emerald Green		

(e) Blue

Acetine Blue	Gentianine	New Cotton Blues
Acetinduline	Glacier Blue	New Diamond Indigo Blue
Alkali Blues	Helvetia Blue	New Ethyl Blue
Alkaline Blue	Indamine Blue	New Fast Blue
Azindone Blue	Indanil Blue	New Indigo Blue
Azure Blue	Indazine	New Metamine Blue
Basle Blue	Indigen	New Methylene Blue
Bavarian Blue	Indigo Blue	New Solid Blue
Bengal Blue	Indine Blue	New Victoria Blue
Blackley Blue	Indoine	Night Blue
Bleu de Lyon	Indoine Blue	Nile Blue
Bombay Blue	Indol Blue	Opal Cotton Blue
Brilliant Blue	Indone Blue	Paper Blue
Brilliant Cresyl Blue	Indophenine Blue	Paraphenylene Blue
Brilliant Diazine Blue	Janus Blue	Peacock Blue
Brilliant Glacier Blue	Janus Dark Blue	Phenine Blue
Brilliant Metamine Blue	Jute Blue	Phenine Navy Blue
Brilliant Victoria Blue	Light Blue	Phenylene Blue
Capri Blue	Madras Blue	Printing Blue
China Blue	Malta Blue	Pure Blue
Cotton Blue	Marine Blue	Rhoduline Blue
Cotton Light Blue	Meldola's Blue	Rhoduline Sky Blue
Cresyl Blue	Metaphenylene Blue	Setocyanine
Crystal Fast Blue	Methyl Blue	Setoglauanine
Dark Blue	Methyl Cotton Blue	Setopaline
Diazine Blue	Methyl Indone	Solid Blue
Diphen Blue	Methyl Light Blue	Soluble Blues
Diphenylamine Blue	Methyl Water Blue	Swiss Blue
Ethyl Blue	Methylene Blue	Thiazine Blue
Ethylene Blue	Methylene Dark Blue	Thionine Blue
Excelsior Cotton Blue	Methylene Indigo	Toluidine Blue
Fast Blue	Muscarine	Toluylene Blue
Fast Blue for Cotton	Naphthindone	Turkey Blue
Fast Cotton Blue	Naphthol Blue	Turquoise Blue
Fast Marine Blue	Neutral Blue	Victoria Blues
Fast Navy Blue	Neutral Peacock Blue	Victoria Night Blue
Fast New Blue	New Blue	Water Blue

(f) Violet

Brilliant Rhoduline Purple
 Brilliant Violet
 Clematine
 Cresyl Fast Violet
 Crystal Violet
 Dahlia
 Ethyl Purple
 Ethyl Violet
 Fast Neutral Violet
 Giroflé
 Heliotrope

Hofmann's Violet
 Irisamine
 Iris Violet
 Methyl Violets
 Methylene Heliotrope
 Methylene Violet
 Neutral Violet
 Paraphenylene Violet
 Paris Violet
 Primula

Red Violet
 Regina Violet
 Rhoduline Heliotrope
 Rhoduline Violet
 Rosolane
 Rubine Violet
 Soda Violet
 Tannate Violet
 Tannin Heliotrope
 Violets

(g) Brown

Aeridine Brown
 Bismarck Brown
 Brown extra soluble
 Cutch Brown
 Excelsior Brown

Janus Brown
 Leather Brown
 Manchester Brown
 Nut Brown

Phenylene Brown
 Rheonine
 Tannin Brown
 Vesuvine

(h) Black

Coal Black
 Diazine Black
 Direct Gray
 Fast Black
 Fast Gray
 Gray NO
 Janus Black
 Janus Gray
 Jet Black

Jute Black
 Jute Coal Black
 Leather Black
 Logwood Substitute
 Malta Gray
 Methylene Gray
 Neutral Black
 New Fast Gray

New Gray
 New Methylene Gray
 Nigrosine
 Paper Black
 Silk Gray
 Straw Black
 Tannate Fast Black
 Tannate Gray

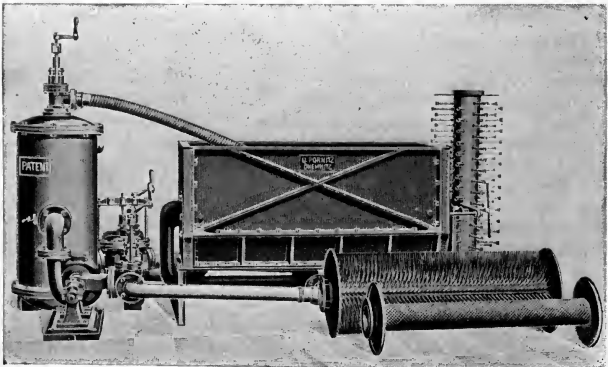

FIG. 159.—Open Horizontal Dyeing or Bleaching Machine for Warper's Beams, Cops, and Cross-wound Bobbins. (Pornitz.)

2. Notes on the Practical Dyeing of Basic Colors.—The basic dyes are very seldom employed for the dyeing of cotton or loose stock, as the mordanting makes the cotton somewhat harsh and bad to work in the subsequent processes of spinning. Yarn, however, both as skein and warp, is extensively dyed with these colors, and the same is also true of piece-goods. Skein yarn is mordanted, fixed, and dyed in the usual forms of apparatus, either hand-dyed in the tubs or dyed on suitable skein machines. Warps may best be handled by first impregnating with the tannin solution in an ordinary warp-dyeing machine, then laying down in the tannin and steeping overnight. The fixing and dyeing are done by running in the ordinary warp machine. In the case of light shades on warps, the mordanting and fixing may be carried out in a continuous six-box warp machine; the first two boxes containing the tannin solution, the next two the fixing bath of tartar emetic (with the addition of a small amount of chalk), while the last two boxes are used for rinsing. Warps which are hard-twisted should always be soaped after mordanting to insure even colors. In the application of the dyestuff to warps, the bath should contain acetic acid or alum, and the first end should be run cold, and best without any addition of dyestuff. The dye solution is then added continuously while the warps are running and the temperature of the bath should be raised after each end.

In applying tannin and tartar emetic to cotton piece-goods, either the padding machine or jigger will be found convenient. The tannin bath is started at the boil in the jigger and the goods are run for an hour in the cooling bath. The tartar emetic may also be applied in an open soaper or washer. If the padding machine or jigger is used, two ends are given, half of the tartar emetic solution being added for each end. The dyeing is usually carried out in the jigger in a rather dilute solution, and with the addition of acetic acid or alum. The first end is usually given cold and without any addition of dyestuff, after which the dye solution is gradually fed in and the temperature of the bath raised slowly to 160° F., or 200° F.

The basic dyes are not well adapted to the dyeing of cops or package goods in dyeing machines on account of the numerous operations involved and the bad penetrating and leveling properties of the basic dyes under such conditions. When such a method of dyeing is desired, however, the tannin bath should be circulated hot and should contain a small amount of soluble oil (1 pint of Monopol Oil per 100 gallons) in order to obtain penetration and uniformity. After tanning, the cops should be hydro-extracted in order to remove the excess of liquor, and then treated with the tartar emetic solution at 140° F. After this the goods should be treated with a dilute soap solution and then dyed. The dyeing should be started cold and either acetic acid or alum is added to the dye bath; the addition of dyestuff solution must be regulated with care in order to obtain uniform results; also the rise in temperature must be very gradual. It must be

borne in mind that the cops (or other package goods) act as a filter on the various solutions which are circulated through the cotton, and consequently any imperfectly dissolved material will be deposited in the outside layers of the cop and thus give shaded dyeings.

3. Experimental. Exp. 97. Principal Basic Dyes on Cotton.—Use test skeins of cotton yarn mordanted in the manner described in Exp. 92 with 4 per cent of tannin and 2 per cent of tartar emetic. Prepare the dyebath with 2 per cent of alum and the dyestuffs given below; enter at 100° F., gradually raise the temperature to 180° F., and dye at that point for one-half hour; wash well and dry.

2 per cent Bismarck Brown.	2 per cent Victoria Blue B.
2 per cent Safranine.	1 per cent Rhodamine.
2 per cent Brilliant Green.	1 per cent Brilliant Phosphine.
2 per cent New Methylene Blue BB.	2 per cent Acridine Red.
2 per cent Tannin Orange R.	½ per cent Irisamine.

Test five of these colors for fastness to light, washing, and crocking.

RECORD OF RESULTS OF TESTS

Tests.	1	2	3	4	5
Light.....					
Washing {	Soap liquor.....				
	White wool.....				
	White cotton.....				
Crocking.....					

Exp. 98. Principal Basic Dyes on Silk.—Use a dyebath containing 5 per cent of soap and slightly acidify by the addition of sufficient acetic acid. Enter the silk at about 100° F., and gradually raise to 190° F., and dye at that temperature for one-half hour. Wash well, and brighten by passing the dyed skeins through a bath of dilute acetic acid, squeezing and drying without washing. Use the following dyestuffs:

¼ per cent Diamond Fuchsine.	1 per cent Auramine.
2 per cent Diamond Fuchsine.	2 per cent Malachite Green.
3 per cent Safranine.	2 per cent Bismarck Brown.
¼ per cent Methylene Blue.	¼ per cent Rhodamine.
2 per cent Methylene Blue.	2 per cent Tannin Orange R.

Test five of these colors for fastness to water.

RECORDS OF RESULTS OF TESTS

Tests.	1	2	3	4	5
Test to water {	Steeping water.....				
	White silk.....				
	White cotton.....				

CHAPTER XIII

APPLICATION OF SUBSTANTIVE DYES TO COTTON

1. The Substantive Dyestuffs.—These coloring matters were first discovered by Boettiger in 1884 in the dyestuff known as Congo Red. They are distinguished by the common property of dyeing the vegetable fibers in full and comparatively fast shades without the intervention of mordants; they also dye the animal fibers, wool and silk. Their chief application, however, is to cotton. At present there are several distinct classes of substantive dyes as far as their chemical constitution is concerned,* but for the most part they are derived more or less directly from the parent substance benzidine, and are characterized by being “tetrazo” compounds; that is to say, their molecule contains the azo group $N=N$ twice. As benzidine is a diamine compound (that is, contains the amine group, NH_2 , twice) these colors are also known as the “diamine” colors.†

There are also a number of substantive dyes prepared from complex sulphuretted bases, of which Primuline is the type.

The substantive colors as a class are very soluble in water, and when using them it is not so particular to employ soft water as when using the basic dyes. It is not well, however, to use a very hard water either for dissolving the color or preparing the dyebath. If only hard water is available it should first be boiled up with some soda ash before the addition of the dyestuff. In preparing the dyebath with substantive colors it is fre-

* According to Green's classification the substantive cotton dyes include five groups from a chemical point of view, as follows:

<i>Class</i>	<i>Example</i>
Disazo dyes	Benzopurpurine 4B
Trisazo dyes	Titan Black FF
Tetrakisazo dyes	Toluylene Brown R
Stilbene dyes	Mikado Orange
Thiazole dyes	Primuline

† The substantive dyes include derivatives of benzidine, tolidine, diamidostilbene, and various azoxydiamines; they also include certain derivatives of stilbene (from nitro-toluene sulphonic acid), such as the Mikado colors, Stilbene Yellow, etc. Another class of direct cotton or substantive dyes is not included in the azo dyes at all, but is derived from certain bases made from sulphur compounds of paratoluidine or its homologues; these form the Primuline group of dyes.

quently the practice of the dyer to add the dyestuff directly to the bath; while it is frequently possible to do this without bad results, nevertheless it is not to be recommended for general practice, as it is always best to first properly dissolve the dyestuff and then use the solution for additions to the bath. If, however, the dyestuff is added directly, it is always best to first add the soda ash, then the dyestuff, and finally the salt.

2. Use of Substantive Dyes on Cotton.—The nature of the dyeing process with regard to the substantive colors on cotton is not as yet thoroughly understood; unlike the dyeing of the acid and basic colors, there appears to be no reason for assuming that a chemical reaction occurs between the fiber and the dyestuff. It seems to be simply a case of the absorption of the coloring matter by the substance of the fiber, and though the color is withdrawn from the solution and fixed by the cotton with considerable stability, yet it may be redissolved from the fiber by repeatedly boiling in water. It is said that if two skeins of cotton yarn, the one dyed with a substantive color and the other undyed, are boiled together in water for a long time, the two skeins will eventually become dyed the same color.

The substantive dyes as a rule are very soluble in water, and consequently the dyebaths are seldom completely exhausted even when relatively small amounts of the coloring matter are used. Cotton which has been dyed with a substantive color will also usually bleed, or have some of its color extracted again when boiled in fresh water; and this extraction of color may be successively repeated until a large part of the dyestuff has been removed from the fiber. Again, the amount of coloring matter which can be taken up by the cotton fiber appears to be rather limited, on which account very heavy, dense shades, as a rule, cannot be obtained with the substantive colors on cotton.*

By the addition of salt to the dyebath the solubility of the coloring matter in the water is lessened, and consequently more of the color is forced on the cotton; this condition is also favored by employing as "short" a bath as possible, that is, one containing a minimum amount of dye liquor. Either common salt (sodium chloride) or Glaubersalt (sodium sulphate) may be used in the dyebath, though the former is mostly used, as it is anhydrous and does not require such a large amount to be added. In common practice about 20 per cent of salt is used in the bath, though when it is desired to obtain heavy shades or to get a better degree of exhaustion

* By mordanting cotton with tannate of tin the reactivity of the fiber with substantive dyes is much decreased. This fact is the basis of the so-called method of "resist" dyeing for cotton goods. Cotton yarn prepared with tannate of tin is woven in pattern effect with untreated yarn. The cloth is then dyed with substantive colors and two-color effects are thus obtainable. The tannate of tin is obtained on the fiber by first mordanting the cotton with tannin and then treating with a bath containing stannic chloride.

larger amounts of salt may be used, even to as high as 100 per cent on the weight of the cotton being dyed. If too great an amount of salt is added there will be danger of some of the dyestuff being precipitated or "salted out"; this, however, as a rule will not occur until about 1 lb. of salt per gallon of solution has been added, an amount which will hardly ever be used in practice. When the dye liquor, however, is employed as a standing bath, care must be had that in the successive additions of dyestuffs and salt the accumulation of the latter in the bath does not become too great. In order to control this amount the density of the liquor should be deter-

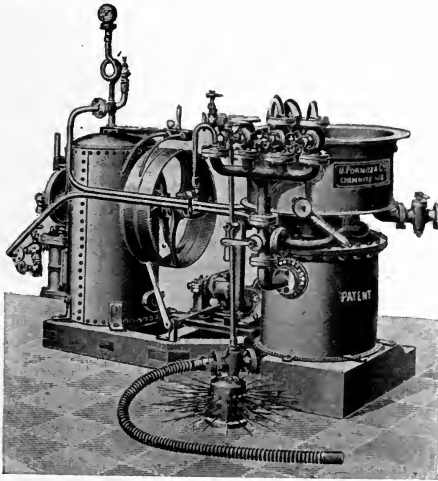

Fig. 160.—Sample Dyeing Machine for Cops and Tubes. (Pornitz.)

mined with a hydrometer. For light shades, as a rule, but little salt is used, and as only a slight proportion of color remains in the bath, the liquors are seldom kept for further use. For medium shades the best density of the dye liquor is about 2° Tw., and for dark shades from 4 to 6° Tw. In determining the density of the liquor with the hydrometer, a small portion should be taken from the vat and allowed to cool before being tested.* When dyeing in baths containing a large amount of salt, it is best not to add the salt until towards the end of the operation, and the goods after coming from the dyebath should be well rinsed in fresh water, otherwise the salt may crystallize in the material and afterwards be more difficult to remove.

* The densities given refer to those based on a temperature of 60° F. The density of the hot or boiling liquor will be considerably less for the same content of salt.

Increased exhaustion of the dyebath may also be obtained by using vats heated with closed steam coils, as the introduction of live steam into the bath considerably dilutes it. Increased exhaustion is also obtained by allowing the color to feed on the cotton from a cooling bath; that is to say, the cotton should not be taken from the bath at a boil, but the steam should be turned off and the bath allowed to cool down with the cotton in it.

As the substantive colors are so soluble in water and exhaust so poorly, it will seldom occur that they will dye unevenly;* if such, however, does happen, they may be easily leveled by continued working in a boiling bath.

It may happen, however, that in dyeing very delicate shades, especially on a bleached bottom, the color will show a tendency to come up uneven. Under these circumstances it is advisable to reduce the amount of salt added to the dyebath, or even to omit it entirely. Greater evenness can also be obtained by dyeing in a soap bath, or with the addition of Turkey-red oil, recovered oil, or other soluble oil preparations suitable for cotton dyeing. The presence of the oil leads to better penetration and more even distribution of the color. Even dyeing is also promoted by slowly feeding on the color in a comparatively cool dyebath (140 to 160° F.). The use of soluble oil is especially recommended when dyeing delicate colors on mercerized cotton or artificial silk.

A large number of the substantive dyes are capable of forming lakes with many of the basic colors, and this property is utilized in a practical manner in the dyeing of many heavy and bright compound shades on cotton, where the fiber is first dyed with a substantive color and subsequently topped off with a basic dye. The method is especially useful for the production of bright greens and blues. These lakes are fairly permanent to washing, though many are decomposed by boiling water.

Many of the substantive dyes appear to work somewhat better when the bath is made slightly alkaline † by the addition of soda ash, sodium phosphate, sodium silicate, borax, soap, etc.‡ Just what is the action

* In dyeing mercerized cotton with substantive dyes, on account of the much greater affinity of the fiber for the dye, the color is sometimes uneven, so it is well to use less salt or dye in a soap bath. If the mercerized cotton has been dried unevenly, it will nearly always come up uneven.

† Certain substantive dyes, like Rosophenine 4B require the use of a strongly alkaline bath, adding twice the weight of caustic soda as of dyestuff, and using also a large amount of salt (100 to 140 per cent).

‡ In using an alkali such as soda ash in the bath with the substantive colors it must be remembered that this increases the solubility of the dyestuff and this may lead to a disadvantage in that after dyeing if the goods are allowed to lie around in the wet state the color may drain from one portion of the material to another and thus give rise to uneven or shaded dyeings. This defect becomes more pronounced if soda ash is used than when it is omitted. In some cases where the dye is not very soluble (as with Diamine Brown M) the use of soda ash is beneficial; this is also true in the dyeing of heavy

of the alkali in this case is uncertain; it probably aids in the penetration of the coloring matter into the fiber. For light shades it is sometimes beneficial to add Turkey-red oil to the bath. In preparing the dyebath in practice, it is best to first add the alkali (if such is used), then the color solution, and finally the salt.

The substantive colors should be dissolved in boiling water, and if possible, water from condensed steam should be used. If the water to be used for dissolving the dyestuff is calcareous, it is best first to boil the water up with an amount of soda ash equivalent to the weight of the dyestuff to be dissolved. After dissolving the color, the solution should be strained through a piece of cotton cloth or fine sieve. When the dyestuff is added in an undissolved condition directly to the dyebath, some soda ash should first be added, the bath boiled up, and then the dyestuff added, after which the salt is added.

Where hard water must be used in dyeing substantive colors, it should always first be corrected by treatment with a suitable amount of soda ash. With certain colors which are especially sensitive to hard water, it is recommended to dye with addition of 2 to 4 per cent of acid potassium oxalate, the amount depending on the hardness of the water and the quantity of dyestuff to be used; it should be noted that an excess of the oxalate is injurious, causing the color to exhaust badly and giving dull shades.

It is a mistake to suppose that the substantive dyes require a vigorously boiling bath for dyeing; while it is true that a boiling bath will give a better penetration of color, it is also a fact that the amount of color absorbed by the cotton is greater when the temperature of the bath is under the boil, and it has already been pointed out that a better degree of exhaustion is obtained by allowing the goods to remain for some time in the cooling bath. When desirable, most of the substantive colors may be dyed at moderate temperatures, and even cold.* In such cases it is best

fabrics and tightly twisted yarns where it is desired to obtain good penetration of color. In the dyeing of Chrysamine it is necessary to use sodium phosphate to develop the proper shade of the color, and it does not seem that other alkalies will serve the same purpose.

* The best temperature for dyeing the substantive colors on cotton varies considerably with the different dyes. While Chrysophenine, for example, will dye practically a full shade at 100° F., Benzo Fast Scarlet 4BS is hardly taken up by the fiber at all until 140° F. is reached. Owing to the difference in the amount of absorption of the colors by the cotton at different temperatures it will be seen that in dyeing successive lots with compound shades where a mixture of several dyes is used considerable trouble in matching may be caused unless the temperature conditions are maintained the same. In using mixtures of dyes for compound shades it is always advisable to select those which possess approximately the same dyeing qualities, and it is always better to have colors which are very soluble than those which are difficultly soluble. This is especially true if the dyes are to be employed for shading purposes; that is to say, for addition towards the end of the dyeing in order to throw the shade to the desired tone, as these dyes are usually added directly to the boiling dyebath.

to add to the bath some soap or Turkey-red oil in order to obtain better penetration of the coloring matter. When dyeing in a cold bath it is sometimes recommended to mix the dyestuff first with its own weight of caustic soda solution (76° Tw.), then dissolve in a sufficient quantity of hot water, and add this solution to the dyebath along with a little soap.*

For dyeing light shades† for each 100 lbs. of cotton yarn about 200 gallons of water should be used, while for dark shades the amount of water should be limited to about 130 gallons. For dark shades, especially where only one dyestuff is used in the color, the yarn can usually be entered at the boil; for lighter shades, and where several dyes may be used in combination, it is best to enter the cotton at 140 to 160° F., and gradually raise to the boil. If any tendency towards unevenness is observed, it is best to add only a part of the salt to the bath at first and reserve the rest to be added near the end of the dyeing. Yarn which has been dyed in light shades is not generally rinsed after dyeing unless alkali has been used in the bath; but where heavy shades are obtained the yarn should always be well rinsed in order to remove all excess of residual dye liquor and salt solution.

The fastness and quality of the colors produced with the substantive dyes vary greatly with the individual dyestuff, and no general rule in

* The following is a list of suitable dyestuffs for use in a cold bath:

Benzo Azurine G	Diamine Heliotrope
Brilliant Azurine 5G	Diamine Orange
Brilliant Orange G	Diamine Red 10B
Brilliant Purpurine	Diamine Rose
Chicago Blues	Diamine Sky Blue FF
Chrysophenine	Diamine Yellow CP
Columbia Black	Diaminogene B
Columbia Blue G & R	Erica BN & GN
Columbia Green	Erie Blue
Congo Brown	Heliotrope BB
Congo Rubine	Orange TA
Cosmos Red	Oxamine Black
Cotton Brown	Oxamine Blue
Cotton Red	Oxamine Brown
Cotton Rubine	Oxamine Claret
Cotton Yellow	Oxamine Fast Red
Curcumine S	Oxydiamine Yellow
Diamine Black BH	Pyramine Orange
Diamine Blue	Pyramine Yellow
Diamine Brown M & S	Thioflavine
Diamine Fast Yellow	Zambesi Blue BX

† In the dyeing of light shades bleached cotton should nearly always be used if clear bright tones of color are desired. As bleached cotton is somewhat liable to dye up unevenly, the dyeing should be done in a boiling soap bath, or one containing soluble oil. This is particularly true of very light shades of sky blue, flesh, pink, etc. No salt should be added to the bath.

this respect can be formulated. On account of their great solubility, however, they are very liable to bleed on washing, and in many cases they are sensitive to the action of acids. In fastness to light they vary greatly, while some are quite fugitive, others are very fast; in general, however, they are as fast as the basic dyes in this respect.*

3. After-treatment of the Substantive Dyes.—A number of the substantive colors show a greater degree of fastness to washing and light when after-treated with solutions of metallic salts.† Chrome and blue-

* The substantive dyes cover a great range in their qualities of fastness; Congo Red, for example, is very sensitive to acids, whereas Benzo Fast Scarlet 4BS is exceedingly fast to acids. Primuline, on the one hand, has very poor fastness to light, while Chlorazol Fast Yellow B is exceedingly fast in this respect.

† Hübner summarizes the methods for applying substantive dyes to cotton as follows:

1. Dyed direct.
2. Dyed direct, then diazotized and developed with various developers.
3. Dyed direct and coupled with diazotized paranitraniline.
4. Dyed direct and after-treated with bichromate; the material should be well rinsed after dyeing and treated for one-half hour at the boil with 2 to 3 per cent of either potassium or sodium bichromate, with or without the addition of a small quantity of acetic acid.
5. Dyed direct and after-treated with copper sulphate; the material is well rinsed and treated for one-half hour at 120° F. with 1 to 4 per cent of copper sulphate and 1 to 2 per cent of acetic acid. Basic dyes may be added to the copper bath for purposes of shading, in which case the cotton should be entered cold, and the bath gradually heated to 140° F. The after-treatment with copper sulphate improves the fastness to washing, but more especially the fastness to light. Salts of nickel and cobalt may also be used for the same purpose, but as they have no better effect than copper sulphate and are much more expensive, their use is not practical.
6. Dyed direct and after-treated with bluestone and chrome; use 1 to 3 per cent of chrome, 1 to 3 per cent of bluestone and 1 to 3 per cent of acetic acid, for one-half hour at 140 to 200° F. This treatment increases the fastness to washing more than the preceding one and also increases the fastness to light. After the treatment the cotton should be well rinsed and if necessary soaped to neutralize excess of acid and to soften the goods.
7. Dyed direct in a bath without addition of soda.
8. Dyed direct and after-treated with formaldehyde; treat for fifteen to twenty minutes at 120 to 240° F., or for one-half hour in a cold bath with $\frac{1}{2}$ to 3 per cent of formaldehyde (40 per cent), using also 2 to 3 per cent of acetic acid. This increases the fastness to washing of some dyes.
9. Dyed direct and after-treated with Solidogen; prepare the bath with 2 per cent of hydrochloric acid and 2 to 6 per cent of Solidogen (Höchst), and treat for one-half hour in the boiling bath.
10. Dyed direct and after-treated with chromium fluoride or chrome alum; this improves the fastness to washing. Treat for one-half hour at 140 to 200° F. with 2 to 4 per cent of chromium chloride (20° Bé.) or 2 to 4 per cent of chromium fluoride and 2 to 3 per cent acetic acid, or 4 to 5 per cent of chrome alum and 2 to 3 per cent acetic acid.
11. Dyed direct and developed with bleaching powder solution; this is limited almost exclusively to Primuline. Treat for one-quarter hour at 70° F. in a bath con-

stone are chiefly used for this purpose, the former for increasing more especially the fastness to washing, and the latter for increasing the fastness to light. Not all of the substantive dyes are capable of this treatment, and even in the case of those with which the process may be used, the color is usually darkened and dulled to a marked degree. This fact has to be allowed for in the matching of shades, and usually causes a good deal of trouble. The after-treatment is usually carried out in a fresh bath, though in cases where light shades are being dyed and the dyebath is practically exhausted, the after-treatment may be effected directly in this bath. The amount of metallic salt to be used varies with the depth of shade dyed, from 1 to 3 per cent of either chrome or bluestone being used together with about the same amount of acetic acid. The bath is run at from 140° F. to the boil, though some recommend not to go above 160° F. In some cases a combined treatment with both chrome and bluestone is given. In certain cases where chrome cannot be used (on account of its strong oxidizing action) it may be replaced by chromium fluoride or chrome alum. Increased fastness to washing and water may also be given to many of the substantive colors by an after-treatment with salts of aluminium (about 5 lbs. of aluminium acetate of 4° Tw., 4 to 6 ozs. of aluminium sulphate, or 8 ozs. of alum per 10 gallons of liquor being used). The goods are treated at a lukewarm temperature, and hydro-extracted and dried without further washing. By treatment with a solution of formaldehyde it has been found that increased fastness to washing may be obtained with a number of the substantive dyes. This is especially true of some of the direct blacks. The process is carried out by treating the dyed goods for one-half hour in a bath at 140° F. containing 3 per cent of formaldehyde (30 per cent) and 3 per cent of acetic acid (9° Tw.). In some cases it is recommended to add about 1 per cent of chrome to the bath, though this would seem to be merely equivalent to treating the color with a chromium salt, as formaldehyde being a strong reducing agent and chrome a strong oxidizing agent, the two reacting with one another would produce a chromium salt in the bath with the loss of the formaldehyde.*

taining one-half gallon bleaching solution of 15° Tw. to 100 gallons of water. This gives a very fast reddish yellow color; by raising the temperature the reddish tone gives place to pure yellow, but this shade deteriorates with age.

* The increase in weight of cotton during dyeing is sometimes a consideration of some importance. It must be borne in mind in this connection that when raw cotton is treated with solutions of boiling water, especially if alkali is present, a certain loss in weight will be observed due to the removal of the gummy and pectin matters from the fiber. This will usually amount to from 3 to 5 per cent, unless the cotton is bleached before dyeing, when the loss will be larger owing to the bleaching process removing more of the impurities. In the dyeing operation, of course, a certain amount of dyestuff is fixed in the fiber and also various mordants, etc., depending on the process of dyeing employed. This naturally adds some weight to the cotton, and the net increase in weight will be the difference between the amount of materials taken up by the fiber

In some cases an after-treatment may be given with 2 to 3 per cent of pyrolignite of iron (15° Tw.). This renders the shade duller and is chiefly used on dark blues and blacks.

To increase the fastness to washing it has also been suggested to give an after-treatment with magnesium sulphate, followed by a passage through a weak solution of caustic soda.* Some red dyes may be made faster by adding a small quantity of sodium stannate to the caustic soda bath, this is especially true of Benzo Fast Scarlet, which, under such conditions gives a red color almost as fast as a diazotized and developed red.

Another method of after-treatment which also weights the cotton to some extent (as well as increasing the fastness of the color to washing), is to pass the cotton through a tannin bath and subsequently fix with pyrolignite of iron. Of course, this is only suitable for blacks or other dark colors.

Some of the substantive dyes (such as Congo Red and Benzopurpurine) are very sensitive to the action of acids, and in dyeing these colors it is often useful to give them an after-treatment in a bath containing soda ash (5 per cent), as with this treatment the color is apt to change less on exposure.

Black colors are often given an after-treatment in a lukewarm dilute soap bath containing also a little olive oil, as this gives the black a deeper and more beautiful tone. Blacks with substantive dyes which are after-treated with chrome and bluestone, may also have this after-treatment

and the loss due to removal of impurities. In the case of substantive colors the weight of the cotton is generally very little altered by the dyeing; with the sulphur colors the weight is somewhat increased, especially in the case of Sulphur Blacks; basic dyes, owing to the mordant of tannin and antimony, will also increase the weight from 2 to 5 per cent. With Aniline Black and Turkey Red the weighting amounts to as much as 10 per cent. It is sometimes desirable to increase artificially the weight of dyed cotton goods. In the case of piece dyeing this is readily effected in the finishing of the cloth by using starch sizes and mineral filling; but in the case of yarns and knit goods where such methods of finishing are not available other methods must be adopted in which the fiber must absorb the weighting material. Magnesium sulphate (Epsom salts) is generally used for this purpose, as follows (Cassella): For 100 lbs. of cotton yarn or knit goods, use a bath of 160 gallons of water containing 100 lbs. of magnesium sulphate, 16 lbs. of dextrine and 4 lbs. of rape-seed oil saponified with 1 lb. of soda. The goods are steeped for a short time in the lukewarm bath, then hydro-extracted and dried. An increase in weight of 8 to 10 per cent can be obtained. Instead of using rape-seed oil and soda, sometimes glycerin is added, as the presence of this in the fiber causes a greater absorption of moisture. For weighting yarns or goods dyed with substantive black colors, a treatment with tannin and iron salts may be resorted to, as this not only increases the weight, but also adds to the depth of the color. The goods are steeped for several hours in a bath containing 15 to 20 per cent of sumac extract, squeezed and treated in a bath of pyrolignite of iron standing at 3 to 5° Tw., then rinsed and dried. By this method an increase in weight of about 7 per cent can be obtained.

* See W. Warr, Brit. Pat. 25,165 of 1904 (*Jour. Soc. Dyers & Col.*, 1905, p. 118).

combined with a process for the production of a one-bath Aniline Black; the substantive dye in this case forming a good bottom color for the Aniline Black. The process is capable of yielding a very fine black fast to rubbing and acids and also giving a softer fiber than when dyed with Aniline Black alone by the usual process.

4. Topping Substantive Colors with Basic Dyes.—It has already been stated that the substantive dyes do not produce very bright or brilliant shades on cotton, at least not comparing in this respect with the basic

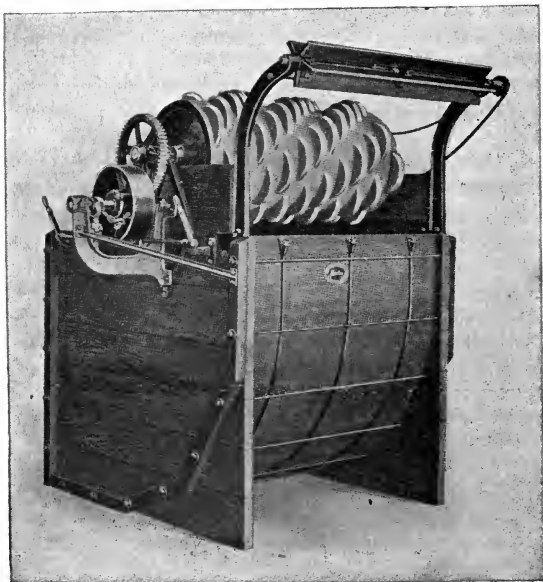

FIG. 161.—Piece Dye Kettle. (Jas. Hunter Machine Co.)

and acid dyes.* It has been found possible, however, to improve very materially the brilliancy of the color by topping with a small quantity of a basic dye, using a separate bath. The substantive color appears to act as a mordant for the basic dye, so that a certain amount of the latter becomes fixed upon the fiber and does not merely stain it, but produces a compound shade with the substantive color which has good fastness to washing. The fastness to washing may be improved by an after-treatment

* This quality, however, has been greatly improved in some of the more recently discovered substantive dyes. Chlorazol Brilliant Blue and the Benzo Brilliant Violets, for example, are almost equal in brilliancy to Methylene Blue and Methyl Violet.

with tannin in another bath, but this materially increases the cost of the process. Usually in this topping process a basic dye of the same general color as the substantive dye is used; as for example, the cotton is first dyed with a Direct Blue and then topped off with a small quantity of Methylene Blue. This will give a bright deep shade of blue far surpassing the original Direct Blue. Bright greens may also be obtained by first dyeing with a Direct Green (which only gives a dull green at best) and then topping with Malachite Green.

The basic dye, as a rule, tends to be taken up by the dyed cotton very rapidly, and uneven results will be obtained unless proper precautions are taken in the dyeing. It is generally necessary to start with a cold bath and raise the temperature gradually to about 140° F., and also to add the solution of the basic coloring matter in several portions to the dyebath rather than all at once. Furthermore, in order to retard the dyeing a small quantity of acetic acid or alum should be added to the bath, as the basic dye will go on the fiber less rapidly from a slightly acid bath.

Perhaps the fastest dyeings by this method are to be obtained by first dyeing with the substantive dye in a bath which also contains 2 to 4 per cent of tannic acid; dye at the boil and then allow to remain in the cooling bath for some time in order to absorb the maximum quantity of dye and tannin; squeeze out and pass through a fresh cold bath containing 1 to 2 per cent of tartar emetic. Then wash well and top in a fresh bath with the necessary basic dye. For blacks or dark blues pyrolignite of iron may be used in place of tartar emetic.

5. Dyeing Cotton Warps in the Size.—Cotton warps are sized usually with paste mixtures of starch, waxes, and China clay, for the purpose of giving stiffness and protection to the yarn in the process of weaving. Sometimes where great cheapness in dyeing is required the dye is applied to the warp at the same time with the size. The size is simply mixed with the required dye solution and the mixture is then padded on to the warp in a suitable machine provided with a size box and squeeze rollers. The warps pass through in rope form, and as they are usually run at good speed (30 to 50 yards per minute) any portion of the yarn is in contact with the size for a brief time (one-half to one minute) and therefore dyes must be used that will dye into the fiber readily. For light shades one passage is usually sufficient, but for heavier shades several runs may be given. For this character of dyeing the substantive dyes give the best results and are the ones most extensively used. For brilliant shades and bright tints some of the acid dyes may also be used.*

* The following method is recommended for the preparation of the size for dyeing: 100 lbs. of wheat flour are stirred with water to a thin paste in a wooden vessel fitted with a stirrer. This is then stirred two to three days until perfectly uniform so that no

The dyed size is applied hot so as to give as good a penetration of color as possible, but even at the best it will be easily recognized that this is a poor method of dyeing and is more of the order of coating the yarn with the color. The method is employed somewhat for dyeing cotton warps used in the weaving of low-grade shoddy union cloths and also for warps used in various ornamental fabrics and backing yarns for rugs and carpets. It is naturally most serviceable in the case of fabrics which are not to be washed, for such treatment would remove most of the size and also the color.

The dyeing of hank yarn is also sometimes done in the size, in which case a form of hank sizing machine is used for applying the colored size.

6. Experimental. Exp. 99. Dyeing Substantive Dyes on Cotton.—These dyes are usually applied to cotton in a neutral bath containing either common salt or Glaubersalt; hence, the name of "salt" or "direct cotton" colors for this class of dyes. Dye a skein of cotton yarn in a bath containing 300 cc. of water, 20 per cent of common salt, and 1 per cent of Congo Red; enter at 140° F., gradually raise to the boil and dye at that temperature for one-half hour; then wash well and dry. The bath does not exhaust very well, but by adding more salt towards the end of the dyeing a better degree of exhaustion may be obtained, although the colors are not apt to be so fast to washing. The use of the common salt (or of Glaubersalt) in the bath is to increase the exhaustion and give better penetration of the color through the fiber. The substantive dyes give

more lumps are present. At the same time 100 lbs. of potato flour are treated in the same manner, the only difference being that it becomes uniform much quicker.

These two pastes are then run together into another vessel which is also provided with a stirrer and which is generally placed above the sizing trough. To this mixture are now added:

1 lb. Japanese wax
12 lbs. coconut oil
50 lbs. magnesium sulphate
100 lbs. China clay

This is now diluted down to 150 gallons and thoroughly stirred for two to three hours. It is then boiled for one hour or until the mixture is thick enough. The dyestuff which has first been completely dissolved is then added and the boiling is continued until the size has the correct feel. The whole or part of it is now run into the sizing trough and the dyeing is commenced.

In addition to the substances mentioned above magnesium chloride is frequently added as a weighting agent, also substances which help to promote penetration are added in small quantities, for example, Turkey-red oil.

The consistency of the size differs in various cases; for fine yarns it is required thinner than for coarser yarns.

Of the coal-tar colors the substantive dyes are the most extensively used for dyeing in the size. The acid dyes are also employed for several shades (gray, blue, cream, white).

It has been found by experience that when working with substantive dyes the 50 lbs. of magnesium sulphate can be suitably replaced by 20 to 30 lbs. of potash or an equal quantity of calcined soda. For weighting 50 to 100 lbs. of barium sulphate can then be added. When working with acid dyes one can add 20 lbs. of magnesium sulphate in place of 50 lbs. and also 30 lbs. of barium sulphate.

good colors on cotton, many of them being fast to light, acids, and alkalis, though some of them are changed by treatment with acids, as is the case with Congo Red. To show this action, dip a few strands of the dyed yarn plaited together into a dilute solution of sulphuric acid; it will be found that the red color is changed to a bluish black. The red color may be brought back by treatment with alkalis, which may be shown by dipping a portion of the above sample in a dilute solution of soda ash. Do this carefully and then wash well so that the sample will show one-half discolored and the other half red. The chief defect of the substantive dyes, however, on cotton, is their liability to bleed on washing in hot water or soap solutions. To show this action, make up two plaited samples from the dyed skein together with white cotton yarn; boil one of these in plain water for fifteen minutes, then squeeze and dry, when it will be found that the color has bled into the white yarn. Scour the other sample in a warm dilute soap bath, then wash in fresh water and dry, and note if the color has bled or not into the white.

Exp. 100. Influence of the Amount of Salt in the Dyebath.—Dye skeins of cotton yarn in baths containing 3 per cent of Erie Blue and the respective amounts of common salt as given below; enter at 160° F., bring to the boil, and dye at that temperature for one-half hour, then wash well and dry.

- | | |
|----------------------------|------------------------------|
| (1) Use no salt | (3) Use 20 per cent of salt |
| (2) Use 5 per cent of salt | (4) Use 100 per cent of salt |

Compare the depth of color obtained on the several skeins and determine what influence if any, the amount of salt has on the color taken up by the fiber.

Exp. 101. Showing the Influence of the Temperature of the Dyebath.—Dye test skeins of cotton yarn in a bath containing 300 cc. of water, 20 per cent of salt, and 2 per cent of Benzopurpurine 4B. Regulate the temperature as follows:

- (1) Dye for one-half hour at the ordinary room temperature, which is about 60 to 80° F.
- (2) Enter cold and raise to 120° F., and continue at that temperature for one-half hour.
- (3) Enter cold and raise to 160° F., and continue at that temperature for one-half hour.
- (4) Enter cold and raise to 180° F., and continue at that temperature for one-half hour.
- (5) Enter cold and raise to the boil and continue at that temperature for one-half hour.

In each case squeeze the excess of liquor from the skein back into the dyebath, and without further addition of dyestuff or salt, but simply diluting the bath to its original volume with water, dye a second set of skeins in these baths at the boil for one-half hour. Wash and dry. Compare the relative depths of colors on the several sets of skeins and in this manner determine how the temperature of the dyebath affects the exhaustion of the color.

Exp. 102. Use of Soda Ash.—Very often a better degree of exhaustion of the dyebath and a greater fastness of the color to washing may be obtained by dyeing substantive colors in a bath made slightly alkaline with soda ash. Dye a skein of cotton yarn in a bath containing 20 per cent of salt, 1 per cent of soda ash, and 2 per cent of Direct Green; enter at 160° F., gradually bring to the boil, and dye at that temperature for one-half hour. Wash well and dry. In place of using soda ash, which is a strong alkali, milder alkaline salts such as sodium phosphate * or sodium silicate may be used.

* When using sodium phosphate from 1 to 3 per cent of the salt is added to the bath. Certain substantive yellow and green dyes give much brighter and purer colors when dyed with this alkali.

Exp. 103. Use of Soap.—This method is somewhat similar to the preceding one, except that soap is used for making the bath alkaline; it is also supposed that this makes the color somewhat faster to washing with soap. Dye a skein of cotton yarn in a bath containing 5 per cent of soap and 2 per cent of Direct Green; enter at 160° F., gradually bring to the boil, and dye at that temperature for one-half hour; wash well and dry. Salt cannot be used in the bath, as it precipitates the soap. For comparison dye another skein of cotton yarn in a bath with 20 per cent of salt and 2 per cent of Direct Green in the usual manner; wash well and dry. Compare the colors obtained on these skeins with the one in the previous experiment; also test them for fastness to washing and note if the method of dyeing in the alkaline or soap bath has increased the fastness of the color to any extent.

Exp. 104. After-treatment with Chrome.—This treatment is for the purpose of increasing the fastness of certain substantive dyes to washing and acids; it also deepens the color, as a rule, to quite a degree, and in some cases causes a considerable change in the tone of the color. Dye two skeins of cotton yarn together in a bath containing 20 per cent of common salt and 2 per cent of Chromanil Brown 2G; enter at 160° F., gradually raise to the boil, and dye at that temperature for one-half hour; wash well and

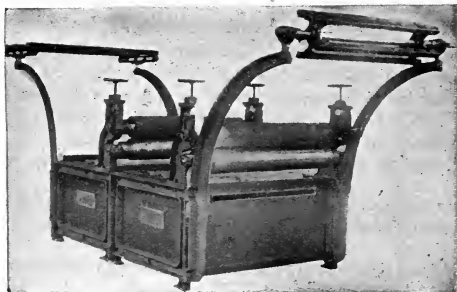

FIG. 162.—Two-Compartment Dyeing Machine. (Textile-Finishing Machinery Co.)

set one of the skeins aside for comparison. Take the second skein and pass into a bath containing 2 per cent of chrome; boil for fifteen minutes, then wash well and dry. Compare the colors obtained on each of the skeins and thus note the effect of the after-chroming on the color. Make tests on both skeins for fastness to washing and perspiration; also test the colors for their fastness to light.

Exp. 105. After-treatment with Bluestone.—This treatment is usually for the purpose of giving an increased fastness to light; the color is also generally considerably altered in tone by the treatment. Dye two skeins of cotton yarn together in a bath containing 20 per cent of common salt and 3 per cent of Diamine Blue RW; enter at 160° F., gradually raise to the boil, and dye at that temperature for one-half hour; wash well, and set one of the skeins aside for comparison. Pass the second skein into a fresh bath containing 3 per cent of bluestone and 3 per cent of acetic acid; work for fifteen minutes at a temperature of 180° F., then wash well and dry. Compare the color on the two skeins, and make a test on each for its fastness to light.

Exp. 106. Use of Formaldehyde for Fastening Substantive Colors.—This reagent appears to increase the fastness of several of the substantive colors on cotton, especially with respect to bleeding on washing. Dye two skeins of cotton yarn in a bath containing 300 cc. of water, 20 per cent of common salt, 1 per cent of soda ash, and 8 per cent of

Diamine Jet Black; enter at 140° F., gradually raise to the boil, and dye at that temperature for one-half hour; wash well, and pass one skein into a bath containing 300 cc. of water and 5 cc. of formaldehyde solution (40 per cent strength); enter at 120° F., gradually raise to 165° F., and keep at that temperature for one-half hour; then wash well and dry. Compare the colors obtained on the two skeins to see if the treatment affects the shade in any manner; then make tests on both skeins for their fastness to washing.

Exp. 107. Dyeing in a Cold Bath.—Many of the substantive dyes are taken up by cotton from a cold bath almost as well as from a hot bath, and these become very useful in cases where it is not desirable to employ a very hot liquor in the dyebath. Dye five test skeins of cotton yarn with the following dyestuffs respectively in baths containing 20 per cent of common salt and 2 per cent of the dyestuff, enter cold and dye (without heating) for three-quarters of an hour; then wash and dry. It is necessary to have the yarn very well boiled-out for this method of dyeing, as otherwise it will be difficult to obtain good penetration of the coloring matter into the fiber. It is also well to add to the dyebath a small amount of Turkey-red oil in order to increase the penetration. Use the following dyestuffs:

Erika BN	Chrysophenine
Brilliant Orange G	Chicago Blue 6B
Heliotrope 2B	

For the dyeing of light shades soap is often added to the bath, as this helps the wetting-out of the cotton; for heavy shades, besides Turkey-red oil, there may also be added a small amount of soda ash to give a better exhaustion of the bath.

Exp. 108. Dyeing Substantive Dyes in Connection with Logwood.—This process is mostly used for the production of fast blacks on cotton, the Logwood giving depth of color and fastness to washing, while the substantive dye gives tone to the black and usually increases the fastness of the color to acids. Dye a test skein of cotton yarn in a bath containing 300 cc. of water 10 per cent of Glaubersalt, 3 per cent of Diamine Jet Black SS, and 10 per cent of Logwood extract; enter at 140° F., gradually raise to the boil and dye at that temperature for three-quarters of an hour; expose to the air for several hours in order to oxidize the Logwood, then work for fifteen minutes in a cold bath of pyrolignite of iron at 2° Tw., containing a small amount of chalk to neutralize the bath. This latter bath is for the purpose of combining with and fixing the Logwood dye. Finally wash well, squeeze, and dry. Test the color so obtained for its fastness to washing and acids.

Exp. 109. Shading Substantive Dyes with Basic Dyes.—Substantive dyes act as mordants toward basic dyes, on which account the latter may be employed for purposes of topping or shading the former. According to the depth of the substantive dyeing, from $\frac{1}{4}$ to $\frac{1}{2}$ per cent of basic dye may be fixed with considerable fastness to washing. Almost any substantive dye may be used as the bottom color, and almost any basic dye may be employed for topping. The dyeing with the substantive color is carried out in the usual manner, while the topping with the basic color is done in a fresh cold bath, either with or without the addition of a small amount of acetic acid. The method is used for the purpose of giving increased depth of color as well as increased brightness; for the substantive colors, as a rule, are neither very intense nor very bright. In some cases the fastness of the color to washing and light is also increased. Dye five test skeins of cotton yarn in the usual manner with 2 per cent of Chrysophenine; wash well and top the five skeins as follows in cold baths containing $\frac{1}{4}$ per cent of the respective dyestuffs:

Methylene Blue	Rhodamine
Methyl Violet	Auramine Q

Malachite Green

Enter cold and dye at that temperature for one-half hour; wash well and dry.

Dye a skein of cotton yarn in the usual manner with 2 per cent of Chicago Blue 6B; wash well and top as in the foregoing test with $\frac{1}{4}$ per cent of Methylene Blue; wash well and dry.

Dye a skein of cotton yarn in the usual manner with 3 per cent of Diamine Scarlet 3B; wash well and top as before with $\frac{1}{2}$ per cent of Rhodamine.

In each case preserve a sample of the skein dyed with the substantive color alone and compare it with the topped sample.

Exp. 110. Topping of Substantive Dyes on Cutch.—This method is often employed for the production of heavy browns, as the bottom color of the Cutch deepens the final color of the substantive dye very materially. Cutch is the extract obtained from the acacia plant, and is a tannin material containing a large amount of natural brown coloring matter. Dye two skeins of cotton yarn in a bath containing 300 cc. of water, 30 per cent of Cutch, and 5 per cent of bluestone; enter at 160° F., gradually raise to the boil and dye at that temperature for one-half hour; squeeze, and pass into a bath containing 300 cc. of water and 3 per cent of chrome, and boil for fifteen minutes; wash well, and dye one of the skeins in a fresh bath containing 300 cc. of water, 2 per cent of Diamine Brown M, 20 per cent of common salt, and 3 per cent of soap; enter at 140° F., gradually raise to the boil, and dye at that temperature for one-half hour, then wash well and dry. The addition of the soap to the last bath serves to soften the cotton which becomes rather harsh on dyeing with Cutch. Compare the colors on the two skeins and test each for its fastness to washing.

Exp. 111. After-treatment of Substantive Dyes with Sumac and Iron Salts.—This process is sometimes employed on dark colors, and especially on blacks, to increase the depth of the color and also its fastness to washing. Dye two skeins of cotton yarn in the usual manner with 6 per cent of Diamineral Black B; rinse, and steep one of the skeins for one hour at 140° F. in a bath containing 300 cc. of water and 10 per cent of sumac extract; squeeze, and work for fifteen minutes in a cold bath of pyrolignite of iron at 3° Tw.; finally wash well and dry. Compare the character of the colors obtained on the two skeins, and test the fastness of each to washing.

Exp. 112. Topping of Substantive Dyes with Aniline Black.—This method is used for the production of fast black shades on cotton with the substantive dyes, and it is said at a lower cost than when Aniline Black alone is used. The aniline salt is usually added to the after-treatment bath of chrome. Dye a skein of cotton yarn in the usual manner with 3 per cent of Columbia Black FB; squeeze and treat in the following bath: 300 cc. of water, 1 gram of aniline salt, 2½ cc. of concentrated hydrochloric acid, and 1½ grams of chrome. Work in this solution cold for one-half hour, then slowly raise to the boil, and continue at that temperature for five minutes; then wash well and soap off in a lukewarm weak soap bath, and dry. Test the black obtained in this manner for fastness to light and washing.

Exp. 113. After-treatment of Substantive Dyes with Pyrolignite of Iron.—Salts of iron appear to act toward substantive dyes much in the same manner as other metallic salts, though the fastness to water is probably not increased to the same degree. Dye two skeins of cotton yarn in the usual manner with 2 per cent of Diamine Catechine B; wash and work one of the skeins in a bath containing 200 cc. of water and 10 cc. of pyrolignite of iron of 32° Tw. at a temperature of 140° F. for fifteen minutes; then wash well and dry. Compare the two skeins for color and test them for fastness to water and washing.

7. List of the Principal Substantive Dyes.—The substantive dyes form a very large and ever-increasing group. Although the most of them are applied almost exclusively to cotton, nevertheless many of them are

also used for dyeing wool and silk. Some of the substantive dyes are also adapted for after-treatment with bluestone and chrome. These are indicated in a separate list.

(a) Red

Acetopurpurine 8B	Chloramine Red	Dianol Brilliant Reds
Alkali Bordeaux	Chlorantine Pink	Dianol Fast Bordeaux
Alkali Claret	Chlorantine Red 4B and 8B	Dianol Fast Clarets
Alkali Grenat	Chlorazol Fast Red	Dianol Fast Pink
Alkali Pink	Chlorazol Red	Dianol Fast Reds
Alkali Purple	Columbia Bordeaux	Dianol Fast Scarlets
Alkali Purpurine	Columbia Fast Scarlet	Dianol Scarlets
Alkali Red	Columbia Red 4B and 8B	Diazo Bordeaux 7B
Azidine Bordeaux	Congo Corinth G	Diazo Brilliant Scarlets
Azidine Brilliant Red	Congo Magenta	Diazo Fast Bordeaux BL
Azidine Corinth	Congo Red	Diazo Fast Red 7BL
Azidine Fast Red	Congo Rubine	Diazo Geranine B
Azidine Fast Scarlet	Cosmos Red	Diazo Rubine
Azidine Purpurine	Cotton Corinth	Diazogen Bordeaux
Azidine Red	Cotton Fast Red	Diazogen Corinth
Azidine Scarlet	Cotton Red 4B	Diazogen Reds
Azo Purpurine	Cotton Rubine	Diazogen Scarlet
Benzamine Fast Red	Crumpsall Direct Fast Red	Diphenyl Blue Red
Benzamine Maroon	Delta Direct Red 5B	Diphenyl Fast Bordeaux
Benzo Bordeaux	Deltapurpurine 5B, 7B, G	Diphenyl Fast Red
Benzo Fast Red L and GL	Diamine Azo Bordeaux	Diphenyl Purpurine
Benzo Fast Rose	Diamine Azo Scarlet	Diphenyl Red 8B
Benzo Fast Rubine	Diamine Bordeaux B and S	Direct Acid Reds
Benzo Fast Scarlet	Diamine Brilliant Bordeaux	Direct Bordeaux
Benzo New Red	Diamine Brilliant Rubine	Direct Brilliant Bordeaux
Benzo Nitrol Bordeaux	Diamine Brilliant Scarlet S	Direct Brilliant Red 10B
Benzopurpurine B, 4B, 6B, and 10B	Diamine Cotton Red	Direct Fast Acid Reds
Benzo Red 10B and SG	Diamine Fast Red F	Direct Pink
Benzo Rhoduline Red B and 3B	Diamine Fast Scarlet	Direct Reds
Benzo Rubine	Diamine Nitrazol Bordeaux	Direct Safranine
Benzo Scarlet	Diamine Nitrazol Scarlet	Direct Scarlet
Blackley Scarlet	Diamine Purpurines	Erie Cardinal
Bordeaux COV	Diamine Reds	Erie Congo
Brilliant Congo	Diamine Rose BD, BG and GD	Erie Delta Red
Brilliant Dianil Red	Diamine Rubine	Erie Fast Red FD
Brilliant Geranine	Diamine Scarlet B, 3B and HS	Erie Garnet
Brilliant Purpurine 4B and 10B	Diamine Violet Red	Erie Pink
Buffalo Direct Cardinal	Dianil Bordeaux	Erie Red 4B
Buffalo Direct Crimson	Dianil Fast Red	Erika
Buffalo Direct Garnet	Dianil Fast Scarlet	Fast Cotton Reds
Buffalo Direct Pink	Dianil Garnet	Fast Red SBL
Buffalo Direct Red 4B	Dianil Pink	Formal Red
Chicago Red	Dianil Ponceau G and 2R	Geranine G and 2B
	Dianil Reds	Hessian Bordeaux
		Hessian Brilliant Purple
		Hessian Fast Red

Hessian Fast Rubine	Para Scarlet G	Rosophenine Pink
Hessian Purple B, D, and N	Paranil Bordeaux	St. Denis Red
Naphthamine Bordeaux	Purpuramine	Salmon Red
Naphthamine Fast Scarlet	Renol Bordeaux	Scarlet for Cotton
Naphthamine Reds	Renol Brilliant Red	Sultan
Naphthamine Scarlets	Renol Corinth	Sultan Scarlet
Niagara Fast Reds	Renol Fast Scarlet	Thiazine Reds
Niagara Fast Scarlets	Renol Orange R	Titan Pink
Oxamine Bordeaux	Renol Pinks	Toluylene Bordeaux
Oxamine Clarets	Renol Rosamine	Toluylene Red
Oxamine Fast Claret	Renol Rubine	Triazol Bordeaux
Oxamine Fast Red	Renolamine Red	Triazol Corinth
Oxamine Garnet	Rosanthrene	Triazol Fast Red
Oxamine Maroon	Rosanthrene Bordeaux	Triazol Red 10B
Oxamine Reds	Rosazurines	Trona Red
Para Garnet G	Rosophenine	

(b) Orange

Alkali Orange	Dianil Orange	Oxydiamine Orange
Azidine Orange	Diazo Brilliant Orange	Para Orange
Benzo Fast Orange S	Diazogen Orange	Paramine Direct Orange
Benzo Orange R	Diphenyl Oranges	Pluto Orange G
Brilliant Orange G	Direct Brilliant Orange	Polyphenyl Orange
Buffalo Direct Orange	Direct Orange	Pyramine Orange R and 3G
Chicago Orange	Erie Orange	Pyrazol Orange
Chloramine Orange	Formal Orange	Renol Orange
Chlorantine Orange	Hessian Orange	Rosanthrene Orange
Chlorophenine Orange	Mikado Orange	Stilbene Orange
Columbia Orange	Naphthamine Orange	Sultan Orange
Congo Orange G and R	New Toluylene Orange	Titan Orange
Cotton Orange G and R	Niagara Fast Orange	Toluylene Fast Orange
Diamine Fast Orange	Orange TA	Toluylene Orange
Diamine Nitrazol Orange	Osfamine Orange	Vesuvine Orange
Diamine Orange		

(c) Yellow

Alkali Fast Yellow	Chlorophenine	Diphenyl Chrysoin
Alkali Leather Yellow	Chromine G	Diphenyl Citronine
Alkali Yellow R	Chrysamine G and R	Diphenyl Fast Yellow
Aurophenine	Chrysobarine	Diphenyl Phosphine
Azidine Fast Yellow	Chrysophenine	Diphenyl Yellow
Azidine Yellows	Clayton Yellow	Direct Fast Yellow
Benzamine Fast Yellow	Columbia Yellow	Direct Yellows
Benzo Fast Yellow	Cotton Yellow G and R	Erie Fast Yellow
Boston Direct Yellow	Curcumine S	Erie Yellow
Brilliant Yellow	Diamine Fast Yellow	Fast Yellow R
Buffalo Direct Yellow	Diamine Gold	Formal Yellow
Carbazole Yellow	Diamine Yellow	Hessian Yellow
Chloramine Yellow GG and M	Dianil Yellow	Kresotine Yellow
Chlorantine Yellow T	Dianol Fast Yellow	Mekong Yellow
Chlorazol Fast Yellow	Dianol Yellow Y	Mikado Goid Yellow
	Diphenyl Chlorine Yellow	Mikado Yellow

Mimosa	Paraphenine Yellow	Thiazol Yellow G and R
Naphthamine Yellow	Phenine Yellow	Thiochromogene
Nitrophenine	Polyphenyl Yellow	Thioflavine S
Oriol	Primuline	Titan Yellow
Oxydiamine Yellow	Pyramine Yellow	Toluylene Yellow
Oxy Dianil Yellow	Renol Yellow	Triazol Fast Yellow
Oxyphenine	Salicine Yellow G and GG	Triazol Yellow
Para Yellow	Stilbene Yellow	Turmerine
Paramine Direct Yellow	Sultan Yellow	Xanthine
Paranil Yellow	Sun Yellow	Yellow CR and D

(d) Green

Alkali Green	Dianol Dark Green	Osfamine Dark Green
Azidine Dark Green	Dianol Fast Green	Osfanil Dark Green
Azidine Green	Dianol Green	Oxamine Dark Green
Benzo Dark Greens	Dianol Olive	Oxamine Green
Benzo Greens	Dianol Pea Green	Para Fast Green
Benzo Olive	Diazo Olive	Para Green
Brilliant Benzo Green	Diphenyl Green	Para Olive
Chloramine Green	Direct Brilliant Green	Paramine Green
Chlorazol Green	Direct Dark Green	Polyphenyl Green
Columbia Dark Green	Direct Green	Renol Dark Green
Columbia Green	Eboli Green	Renol Green
Diamine Dark Green	Erie Direct Green	Renol Olive
Diamine Green	Erie Green	Renolazine Green
Diamine Nitrazol Green	Formal Olive	Tolamine Green
Dianil Dark Green	Naphthamine Dark Green	Triazol Green
Dianil Greens	Naphthamine Green	Union Green
Dianol Chrome Green		

(e) Blue

Acetylene Blue	Benzo Cyanide B, 3B and R	Chloramine Sky Blue
Acetylene Sky Blue	Benzo Dark Blue R, G, and 5G	Chlorantine Pure Blue
Alkali Azo Blue	Benzo Fast Blue	Chlorazol Blue
Alkali Azurine	Benzo Indigo Blue	Chlorazol Brilliant Blue
Alkali Brilliant Blue	Benzo Marine Blue	Chlorazol Dark Blue
Alkali Chrome Blue	Benzo Navy Blue	Chlorazol Dark Navy
Azidine Black Blue	Benzo New Blue	Chlorazol Fast Blue
Azidine Blues	Benzo Pure Blue	Chlorazol Sky Blue
Azidine Sky Blue	Benzo Red Blue G	Columbia Blue
Azo Blue	Benzo Sky Blue	Columbia Dark Blue
Azo Corinth	Benzo Steel Blue	Columbia Fast Blue
Azo Dark Blue	Betamine Blue 8B	Congo Blue
Azo Mauve	Brilliant Azurine	Congo Fast Blue
Azo Navy Blue B	Brilliant Benzo Blue 6B	Congo Pure Blue
Benzamine Blues	Brilliant Congo Blue	Congo Sky Blue
Benzamine Para Blue	Brilliant Fast Blues	Cotton Blue
Benzo Azurine G, 3G and R	Brilliant Sky Blue	Cotton Pure Blue
Benzo Blue	Buffalo Direct Blue	Diamine Azo Blue R and 2R
Benzo Chrome Dark Blue B and N	Chicago Blues	Diamine Bengal Blue
Benzo Copper Blue B	Chloramine Blue	Diamine Blue BX, RW, BG, 2B, 3B

Diamine Brilliant Blue G	Direct Dark Blue	Oxy Chlorazol Blue
Diamine Cyanine	Direct Fast Blue	Oxydiamine Blue R, 3R, and G
Diamine Dark Blue	Direct Indigo Blue	Oxyphenol Sky Blue
Diamine Fast Blue	Direct Indone Blue	Para Blues
Diamine Fast Brilliant Blue	Direct Sky Blue	Paramine Blues
Diamine New Blue	Eboli Blue B, 6B, and 2R	Paramine Navy Blue
Diamine Pure Blue	Eboli Dark Blue	Paramine Sky Blue
Diamine Sky Blue	Eboli Sky Blue	Phenamine Blue
Diamine Steel Blue	Erie Blue BX and 2G	Renol Blues
Diamineral Blue	Formal Blue	Renol Fast Blue
Diaminogene Blue	Indigene Blue	Renol Indigo Blue
Diaminogene Dark Blue	Isamine Blue	Renol Light Blue
Diaminogene Sky Blue	Melogene Blue	Renol Pure Blue
Dianil Azurine	Naphthamine Blue	St. Denis Blue
Dianil Blues	Naphthamine Brilliant Blue	Solamine Blues
Dianil Dark Blue	Naphthamine Deep Blue	Titan Como
Dianil Indigo	Naphthamine Indigo	Titan Dark Navy
Diazol Blues	Naphthamine Sky Blue	Titan Fast Navy
Dianol Brilliant Blue	Naphthazurine	Titan Navy
Dianol Dark Blue	Naphthogene Blues	Toledo Blue V
Dianol Fast Blue	Naphthyl Blue BB	Toluyene Blue
Dianol Sky Blue	New Toluyene Blue	Toluyene Dark Blue
Dianol Steel Blue	Niagara Blues	Triamine Blue
Diazo Blue	Niagara Fast Blue	Triazol Blue
Diazo Indigo Blue	Niagara Sky Blue	Triazol Dark Blue
Diazo Navy Blue	Opaline	Triazol Indigo Blue
Diazo Red Blue	Osfamine Blues	Triazol Pure Blue
Diazo Sky Blue	Osfanil Blues	Trisulfone Blue
Diphenyl Blue 3G	Osfanil Pure Blue	Union Navy Blue
Diphenyl Brilliant Blue	Oxamine Blue	Zambesi Indigo
Diphenyl Fast Blue	Oxamine Copper Blue	Zambesi Pure Blue
Direct Blue 2BX, and 3BX	Oxamine Dark Blue	
Direct Blue B and R	Oxamine Pure Blue	

(f) Violet

Alkali Azo Violet	Clemantine	Direct Violet
Azidine Violet	Columbia Violet	Erie Violet
Azo Corinth	Congo Corinth	Heliotrope
Azo Gallein	Congo Violet	Hessian Bordeaux
Azo Mauve	Diamine Brilliant Violet	Hessian Violet
Azo Violet	Diamine Fast Violet	Naphthamine Violets
Benzamine Violet	Diamine Heliotrope G, O, and B	Osfamine Violets
Benzo Fast Heliotrope	Diamine Violet N	Osfanil Violet
Benzo Fast Violet	Dianil Bordeaux	Oxamine Violet
Benzo Violet	Dianil Violet	Oxydiamine Violet B, R, and G
Bordeaux COV	Dianol Brilliant Violet	Paramine Violet
Bordeaux extra	Dianol Violets	Renol Violet
Brilliant Benzo Violet	Diazo Fast Violets	Rosanthere Violet
Brilliant Congo Violet	Diazogen Violet	St. Denis Violet
Chloramine Violet	Diphenyl Fast Violet	Triazol Violet
Chlorantine Lilac	Diphenyl Violet	Trisulphone Violet
Chlorazol Violet		

(g) Brown

Alkali Bronze	Cupranil Browns	Hessian Brown
Alkali Brown	Diamine Bronze	Mikado Browns
Alkali Chrome Brown	Diamine Browns	Naphthamine Bronze
Alkali Cutch	Diamine Catechines	Naphthamine Browns
Alkali Dark Brown	Diamine Cutch	New Toluylene Browns
Alkali Mode Brown	Diamine Fast Browns	Nitramine Brown
Alkali New Brown	Diamine Nitrazol Browns	Nitranil Browns
Alkali Red Brown	Diamineral Browns	Oxamine Browns
Azidine Bronze	Dianil Browns	Oxamine Dark Brown
Azidine Browns	Dianil Chrome Brown	Oxamine Maroon
Azidine Dark Browns	Dianil Fast Brown	Oxydiamine Browns
Benzamine Browns	Dianil Japonine	Oxyphenol Browns
Benzamine Dark Brown	Dianol Bronze	Panama Brown
Benzo Bronze	Dianol Browns	Para Bronze
Benzo Brown	Dianol Catechine	Para Brown
Benzo Chrome Brown	Dianol Cotton Brown	Paramine Brown
Benzo Dark Brown	Dianol Union Browns	Paramine Dark Brown
Benzo Nitrol Browns	Diazo Browns	Paranil Browns
Catechu Brown	Diazogen Brown	Pegu Browns
Chicago Brown	Diphenyl Bronze	Pluto Browns
Chloramine Browns *	Diphenyl Browns	Renol Bronze
Chlorantine Brown	Diphenyl Catechine	Renol Browns
Chlorazol Browns	Diphenyl Fast Brown	Renol Dark Brown
Chlorazol Catechine	Diphenyl Red Brown	Renol Deep Browns
Chlorazol Deep Browns	Direct Bronze Brown	Renol Havana
Chromanil Brown	Direct Browns	Renol Khaki
Columbia Browns	Direct Dark Brown	Renol Maroon
Congo Browns	Direct Fast Brown	Terra Cotta
Copper Brown	Direct Naphthamine Browns	Thiazine Browns
Cotton Browns	Discharge Browns	Toluylene Browns
Cotton Dark Browns	Erie Browns	Triazol Browns
Crumpsall Direct Fast Browns	Erie Fast Brown	Trisulphone Bronze
Crumpsall Direct Fast Khaki	Fast Cotton Brown	Trisulphone Browns
	Formal Brown	Union Brown
	Havana Brown	Zambesi Browns

(h) Black

Alkali Black B and G	Chlorazol Fast Blacks	Diamine Jet Black
Alkali Blue Black	Chromanil Blacks	Diamine Milling Blacks
Alkali Chrome Black	Cold Black	Diamine Nitrazol Black
Alkali Deep Black	Columbia Blacks	Diamineral Blacks
Azidine Blacks	Columbia Fast Blacks	Diaminogene B, and extra
Azidine Carbon	Cotton Blacks	Dianil Blacks
Azidine Direct Blacks	Cotton Milling Black	Dianol Blacks
Benzo Chrome Black	Diamine Azo Black	Dianol Brilliant Blacks
Benzo Chrome Blue Black	Diamine Beta Black	Dianol Chrome Blue Black
Benzo Fast Blacks	Diamine Blacks	Dianol Copper Black
Benzo Nitrol Black	Diamine Blue Black	Dianol Diazo Blacks
Carbide Blacks	Diamine Deep Black	Dianol Fast Blacks
Chloramine Blacks	Diamine Fast Blacks	Dianol Jet Black

Dianol Union Black	Hessian Fast Black	Panama Black
Diazine Black	Indigene Blacks	Para Diamine Blacks
Diazo Blacks	Ingrain Blacks	Paramine Blacks
Diazo Blue Black	Isodiphenyl Black	Paranil Black
Diazo Brilliant Black	Melantherine	Patent Dianil Blacks
Diazo Fast Blacks	Naphthamine Blacks	Pluto Blacks
Diazogen Black	Naphthamine Deep Black	Polyphenyl Black
Diphenyl Blacks	Naphthamine Direct Blacks	Renol Blacks
Diphenyl Blue Black	Naphthamine Fast Blacks	Renol Deep Black
Diphenyl Fast Black	Neropaline	Renolamine Blacks
Direct Blacks	Niagara Fast Black	Tabora Black
Direct Blue Blacks	Nyanza Black	Titan Blacks
Direct Chrome Black	Osfamine Black	Titan Fast Blacks
Direct Deep Black	Osfanil Blacks	Tolulylene Black
Direct Naphthamine Black	Oxamine Blacks	Triazol Blacks
Erie Blacks	Oxydiamine Blacks	Violet Black
Formal Blacks	Oxydiamine Carbon	Zambesi Blacks
Grounding Black for Cotton	Oxydiaminogenes	

(i) Gray

Benzo Fast Gray	Diphenyl Fast Gray	Hessian Copper Gray
Chicago Gray	Diphenyl Gray	Hessian Gray
Diamine Fast Gray	Direct Gray	Neutral Gray
Diamine Gray	Fast Gray	Zambesi Gray
Dianol Gray		

8. Substantive Dyes Suitable for After-treatment with Bluestone

Azo Violet	Cresotine Yellow	Dianil Dark Blue
Benzo Azurine G, 3G, and R	Diamine Bengal Blue	Dianil Fast Brown
Benzo Blue	Diamine Blue RW	Dianil Japonine
Benzo Copper Blue B	Diamine Brilliant Blue G	Dianil Orange
Benzo Cyanine B, 3B, and R	Diamine Brown M, B, G3	Dianil Yellows
Benzo Indigo Blue	Diamine Catechine	Diazo Blue
Benzo Pure Blue	Diamine Fast Black F	Diazo Indigo Blue
Benzo Sky Blue	Diamine New Blue	Diazo Navy Blue
Brilliant Azurine	Diamine Orange B	Hessian Copper Gray
Brilliant Benzo Blue 6B	Diamine Sky Blue FF	Oxamine Blue
Catechu Brown	Diamineral Black	Oxamine Red
Chicago Blue 6B, B, RW	Diamineral Blue	Oxamine Violet
Chloramine Violet R	Diamineral Brown	Oxydiamine Blue
Chrysamine G and R	Dianil Blacks	Oxydiamine Orange
Congo Blue 2B	Dianil Blues	Phenamine Blue
Congo Brown	Dianil Brown	Pluto Orange G
Cotton Yellow R, G	Dianil Copper Brown	Zambesi Black

9. Substantive Dyes Suitable for After-treatment with Chrome and Bluestone

Benzo Chrome Black B and N	Benzo Green	Chromanil Brown
Benzo Chrome Blue Black B	Benzo Indigo Blue	Chrysamine G and R
Benzo Chrome Brown	Carbide Black BO	Columbia Black Blue G
Benzo Dark Green	Catechu Brown	Columbia Chrome Black
	Chromanil Black	Congo Brown G, R

Cotton Yellow R	Dianil Blacks	Dianil Yellow 3G
Cresotine Yellow	Dianil Blues	Direct Deep Black ERW
Cupranil Brown	Dianil Brown	Oxamine Blue BG
Diamine Browns	Dianil Copper Brown	Oxamine Violet
Diamine Catechine	Dianil Dark Blue	Pluto Blacks
Diamine Dark Blue B	Dianil Fast Brown	Pluto Orange G
Diamine Fast Black	Dianil Green	Toluylene Orange G
Diamine Jet Blacks	Dianil Japonine	Trisulphone Brown S
Diamineral Black	Dianil Orange N	Zambesi Black

CHAPTER XIV

SUBSTANTIVE DYES ON WOOL AND SILK

1. **The Substantive Colors on Wool.**—These dyes have gained considerable favor in various branches of wool dyeing, especially for knitting yarns fast to washing, carded wool and worsted yarns fast to milling, shoddy yarns, loose wool, and also for the dyeing of slubbing and yarns in machines.* For the latter they are especially adapted owing to their great solubility in water. The chief recommendation of these dyes to wool is their good fastness to washing, and in many cases excellent fastness to milling.† This is especially true of the after-treated dyeings. Most of the substantive colors are also fast to stoving. The fastness of the substantive colors to washing is, as a rule, much better on wool than it is on cotton. The same is also true regarding the fastness to light. The exhaustion of the bath is also generally better when wool is dyed.

The general method of dyeing the substantive dyes on wool is to prepare the bath with 10 to 20 per cent of Glaubersalt and 5 per cent of ammonium acetate; enter the goods at 140° F. and slowly bring to the boil, and dye at that temperature for three-quarters of an hour. In case the bath is not thoroughly exhausted add about 2 per cent of acetic acid and con-

* The substantive dyes have not heretofore been used for the dyeing of woollen goods to the extent that would be expected considering their good qualities for this purpose. There has probably been more or less lack of information by most dyers concerning their use on wool, as the emphasis has always been laid on their particular use for cotton, so that most people think of them exclusively as cotton dyes. One reason for their not being adopted as wool dyes has been the fact that as a group they have been considerably more costly than the acid dyes or even the chrome dyeing colors, a condition which has been due chiefly to the fact that the more important of these dyes have been under patent restrictions. At the present time this is no longer the case, as many* of the very desirable substantive dyes are now free from patents. In many cases the substantive dyes may be employed for wool with as good success in the production of fulling fast colors as the chrome and alizarine dyes, and since no mordanting operation is required their method of application is much simpler and cheaper.

† The fastness to milling of many of the substantive dyes on wool is much better than that of most of the acid dyes. The colors, however, are not as bright and pure in tone as those of the acid dyes. Frequently, also the tone of the color on wool is quite different from that obtained on cotton with the same dye.

tinue boiling for fifteen minutes. Sometimes, however, the bath is prepared simply with the Glaubersalt and acetic acid.* The idea of employing ammonium acetate is due to the fact that these dyes are liable to exhaust too quickly if the acid is added to start with and thus give rise to uneven dyeings; whereas with ammonium acetate, the bath becomes acid only slowly at a boiling temperature by the decomposition of the ammonium acetate into ammonia (which is volatilized from the bath) and acetic acid.

It should be observed that in dyeing wool with the substantive colors, neutral baths, or such as are but slightly acidulated with acetic acid, with few exceptions, are the most serviceable. If the baths are made too strongly acid, the color is taken up too rapidly by the wool, and uneven dyeings may result, which cannot afterwards be improved, even by prolonged boiling. In the case of material which is difficult to dye level, or if compound shades are not readily obtained, it is best to begin the dyeing without the addition of acid, and only when the greater part of the color has been taken up should the acid be added to the bath in order to increase the exhaustion. It should also be borne in mind that any vegetable matter present in the wool is not dyed as much in an acid bath as in a neutral one.

Some of the substantive colors on wool may be after-treated with chromium or copper salts to produce faster shades much in the same manner as was described in the case of cotton dyeing.

The after-treatment with chrome or chromium fluoride is usually carried out by adding the salts to the exhausted dyebath with the addition of 3 to 4 per cent of acetic acid and using about one-half the weight of chrome as dyestuff or about the same weight of chromium fluoride as dyestuff. The dyeings may also be after-treated with bluestone in the same manner as with chrome, about the same weight of bluestone as dyestuff being taken. An after-treatment with both chrome and bluestone may be simultaneously effected in the same manner. The metallic salt should

* A variation of the process which is applicable in the case of some of the substantive dyes is to replace the acetic acid and Glaubersalt with a corresponding amount of sodium bisulphate (2 to 5 per cent).

The use of sulphuric acid in place of acetic acid in the dyeing of substantive colors on wool is not to be recommended, as the use of this acid will generally cause the color to go on the fiber too rapidly, thus giving rise to uneven results. In the case of some of the blue substantive dyes, however, where the color is hardly taken up at all from a neutral bath, it is well to first add about 2 per cent of acetic acid to the bath, and then after dyeing for some time, to add a small quantity of sulphuric acid (2 per cent).

Some of the substantive dyes may be dyed on wool mordanted with chrome, or be dyed first and chromed afterwards (like Diamine Fast Red, Geranine, and Benzo Orange). The after-chroming may be done in the same bath as the dyeing, using either chrome or chromium fluoride.

not be added until the bath is quite well exhausted of the dye. In order to obtain a better exhaustion of the dyebath for after-treatment it is best to add about 3 to 5 per cent of acetic acid to the bath in finishing the dyeing; in case the bath does not exhaust well, it is best to carry out the after-treatment in a separate bath with the addition of 4 per cent of acetic acid. Substantive dyes on wool after-treated with bluestone retain their remarkable fastness to light even after fulling, provided a neutral curd soap is used; free alkali (which is generally present in soft soap) should never be present in the soap used under these circumstances.*

The substantive dyes have considerable importance in that branch of woolen dyeing involving fabrics containing a mixture of wool and

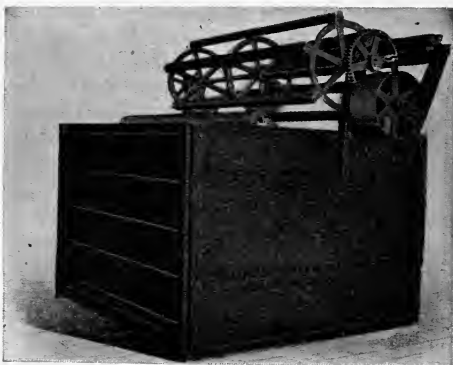

Fig. 163.—Reel Dyeing Machine. (James Hunter Machine Co.)

cotton (union goods and woolen or worsted goods containing cotton or mercerized cotton effect threads). Owing to the fact that many of these dyes may be dyed on both fibers simultaneously in one bath they are frequently spoken of in this connection as "union dyes." Their use has simplified the dyeing of union goods to a very great extent. A full discussion of their use in this particular will be taken up in the section on the dyeing of union fabrics.

2. The Substantive Colors on Silk.—The majority of these colors may be dyed on silk, giving shades of considerable fastness to washing and

* This after-treatment with chrome and bluestone has the effect of increasing the fastness of the colors to light and fulling. There are only certain of the dyes which have their fastness thus increased, while with some the fastness is not particularly affected. The after-treatment also has the effect of somewhat dulling the shade.

water * as well as to light, hence they are of considerable importance in this branch of dyeing. They are also useful for goods that may be subjected to severe treatment with alkalies, such as fancy silk threads running through cotton or woolen fabrics.

The substantive colors are best dyed on silk with the addition of Glaubersalt and acetic acid, or in a bath containing boiled-off liquor. If the dyeing is done without the latter, add to the bath for pale shades about 5 per cent and for heavy shades about 10 per cent of Glaubersalt, and only a small quantity (from 1 to 4 per cent) of acetic acid at the beginning of the operation. If the color goes on the fiber too slowly, a little more acetic acid may be gradually added during the dyeing process. This precaution is necessary because it is difficult to obtain level colors if the bath is too acid at the beginning. For the same reason it is also important not to start the dyeing at too high a temperature. It is best to commence at 120° F. and slowly raise to the boil. For shading let the bath cool to 140 to 160° F., then add the necessary color solution and gradually heat up again. When dyeing light colors the baths exhaust, as a rule, with the addition of Glaubersalt only, or with a very little acetic acid added. For heavy shades the addition of 2 to 10 per cent of acetic acid is necessary.

When dyeing in a bath containing boiled-off liquor, for light shades the liquor need only be slightly acid, but for heavy shades the acidity should be greater. The bath should contain about one-tenth of its volume of boiled-off liquor. Since alkalies prevent the absorption of substantive dyes by the silk, the use of too much boiled-off liquor would make the bath too alkaline in character for proper neutralization. The brightening after dyeing may be done with either acetic or sulphuric acid, and the dyeings may be shaded in this bath in any desired manner. The fastness of the substantive colors on silk to acids, alkalies, stoving, and light corresponds in general to that which they possess when dyed on wool. †

The substantive dyes are especially suitable for the dyeing of satin

* The colors obtained with the substantive dyes on silk, as a rule, are much faster than those on cotton; in fact, they are about of equal fastness to those produced on wool. The colors are usually much faster to water than those obtained with the acid dyes, though they do not possess the same brilliancy. Most of the substantive dyes yield rather dull shades. These colors, however, may be after-treated with basic dyes to furnish brilliant tones.

† The processes of after-treatment with chrome or bluestone may also be used in the dyeing of these colors on silk. The amount of chrome used should not be more than one-third the weight of the dyestuff employed. The use of too much chrome will injure the luster of the fiber. The substantive dyes may also be diazotized and developed on silk in practically the same manner as on cotton, and this process is used quite extensively for the production of certain shades, especially on goods containing both silk and cotton (such as hosiery). This process cannot be used on wool, as the wool fiber itself is susceptible of diazotization and becomes rather highly colored thereby, thus spoiling the color obtained in dyeing.

goods (fabrics containing silk and cotton) as the color is taken up simultaneously on both fibers from a single bath. A full discussion of this subject will be taken up under the topic of dyeing silk-cotton fabrics.

Red substantive dyes that are sensitive to acids may be dyed on silk in a bath containing sodium phosphate (5 per cent) and soap (5 per cent). It is well, however, to avoid the use of acid-sensitive dyes (such as Congo Red and Benzopurpurine 4B) and use only those having proper fastness to acids (such as Diamine Scarlet 3B, Benzo Fast Scarlet, Erika, etc.). Other suitable substantive dyes for silk are Benzo Orange, Mikado Orange, Chrysophenine (especially important for silk), Chrysamine (which must be dyed in a bath containing sodium phosphate and soap), Benzo Azurine, Diamine Sky Blue, and Diamine Brown V. Some of the blacks are also used, especially those for diazotizing and developing.

3. Experimental. Exp. 114. General Method of Dyeing Wool.—These colors are usually dyed on wool in a neutral bath containing either Glaubersalt or common salt. Although the substantive colors are primarily dyes for use on cotton, nevertheless, they are being employed to a considerable extent on wool, as many of them give colors of eminent fastness. Dye a skein of woolen yarn in a bath containing 20 per cent of Glaubersalt and 3 per cent of Diamine Scarlet 3B. Enter at 140° F., gradually bring to the boil, and dye at that temperature for one-half hour, then wash well and dry. Common salt may be used in the bath in place of Glaubersalt and has the same effect. The purpose of the addition of these neutral salts is to cause a better penetration and distribution of the coloring matter, and also to cause a better exhaustion of the dyebath. The substantive dyes, as a rule, are very soluble in water, and show no particular tendency to go on the fiber unevenly, hence the material may be entered at comparatively high temperatures without the danger of unevenness. Also due to its good solubility in water, the dyestuff does not give complete exhaustion in the bath. The substantive dyes do not produce as bright or as full shades on wool as the basic and acid dyes. Some of the substantive dyes, especially the reds, are very sensitive to the action of acids, their color being changed, as has been shown in the previous chapter, with Congo Red. The dyestuff used above, however, is fast to acid, as may be shown by moistening a small sample of the dyed yarn with a dilute solution of sulphuric acid, washing and drying. Also test this color for its fastness to fulling.

Exp. 115. Use of Ammonium Acetate in the Dyebath.—The use of this salt in the dyebath appears to give better exhaustion and also to make the color faster to fulling. Dye a skein of woolen yarn in a bath containing 5 per cent of ammonium acetate and 3 per cent of Diamine Green G; enter at 140° F., gradually raise to the boil, and dye at that temperature for one-half hour. Wash and dry. The ammonium acetate, on boiling, decomposes into ammonia (which is volatilized) and free acetic acid, and this no doubt helps in the dyeing of the wool. Ammonium acetate may be readily prepared by mixing ammonia water and acetic acid in the following proportions: 32 parts of strong ammonia water and 50 parts of acetic acid (1.031 sp. gr.) which will give a solution containing 25 parts of ammonium acetate. Diamine Green gives a color on wool which has good fastness to washing.

Exp. 116. Dyeing in a Slightly Acid Bath.—Some of the substantive dyes may be applied to wool in slightly acid baths in much the same manner as the acid dyes. This method is especially useful for the production of two-color effects on mixtures containing wool and cotton. Dye a skein of woolen yarn in a bath containing 20 per cent

of Glaubersalt, 4 per cent of acetic acid, and 2 per cent of Chrysophenine; enter at 140° F., gradually raise to the boil, and dye at that temperature for one-half hour; wash and dry. Acetic acid is mostly used in this connection, as sulphuric acid is too strong and is liable to injure the color, and where cotton is present there is danger of the latter fiber being tendered by the incomplete removal of the acid, whereas acetic acid, being volatile, is easily removed. Chrysophenine gives a good yellow color on wool which is exceedingly fast to light; to show this expose a sample to light for thirty days.

Exp. 117. Showing the Application of Substantive Dyes on Union Material.—Dye a skein of union yarn (containing wool and cotton threads twisted together) in a bath containing 20 per cent of Glaubersalt, 4 per cent of acetic acid, and 2 per cent of Chrysophenine; enter at 140° F., gradually raise to the boil, and dye at that temperature for one-half hour; wash well and dry. It will be found that both fibers will be dyed about a uniform color. Dye a second skein of union yarn in a bath containing 20 per

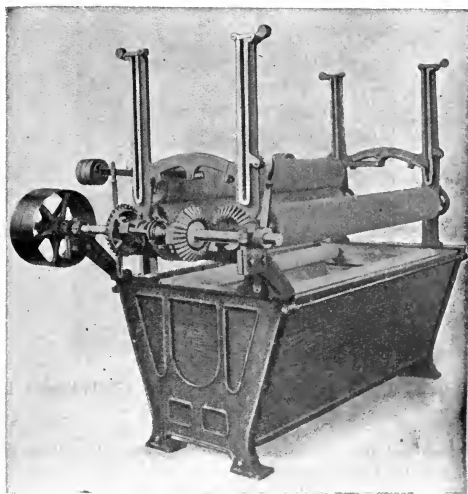

FIG. 164.—Dyeing Jig. (Textile-Finishing Machinery Co.)

cent of Glaubersalt, 4 per cent of acetic acid, 2 per cent of Chrysophenine and 1 per cent of Acid Violet. Dye in the usual manner, wash well, and dry. It will be found in this case that the wool has been dyed with both the yellow and violet colors, giving a resultant olive green, whereas the cotton has been dyed with the yellow and has only been slightly tinted with the violet, so that a two-color effect has been obtained. Union dyes are especially employed for dyeing blacks where it is desirable to hide the cotton woven in with the wool. As a rule, the cotton dyes better at low temperatures than the wool, and the wool better at high temperatures. Dye a skein of union (wool and cotton) yarn in a bath containing 300 cc. of water, 20 per cent of Glaubersalt, and 6 per cent of Erie Black; enter at 100° F., and dye at that temperature for one-half hour; then wash well and dry. It will be noticed that the cotton is dyed much darker than the wool. Dye a second skein of union yarn in a similar bath, but at a tempera-

ture of 175° F. for one-half hour; then wash well and dry. It will be found that both fibers are nearly the same depth. Dye a third skein of union yarn in a similar bath, but at the boil for one-half hour; then wash well and dry. It will be found that the wool is dyed somewhat darker than the cotton. Dye a fourth skein of union yarn in a bath containing 300 cc. of water, 20 per cent of Glaubersalt, and 8 per cent of Union Black B; enter at 120° F., gradually raise to the boil, and dye at that temperature for one-half hour. Wash well and dry. Compare the color obtained on the two fibers.

Exp. 118. After-treatment with Chrome.—This treatment is for the purpose of increasing the fastness of the color to washing and light. At the same time it also causes an increase in the depth of the color. Dye two test skeins of woolen yarn in a bath containing 20 per cent of Glaubersalt, 10 per cent of ammonium acetate, and 3 per cent of Diamine Fast Red F; enter at 140° F., gradually raise to the boil, and dye at that temperature for one-half hour. Remove one of the skeins, wash, and dry. Add to the dyebath 2 per cent of chrome, re-enter the second skein and continue boiling for twenty

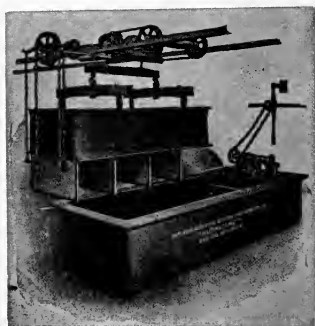

FIG. 165.—Circulating Dyeing Machine for Hosiery. (Philadelphia Dyeing Machine Co.)

minutes; then wash and dry. Compare the colors obtained on these two samples, and test each skein for its fastness to washing.

Exp. 119. After-treatment with Chromium Fluoride.—This salt is sometimes substituted for chrome. It acts in much the same manner by increasing the fastness of certain colors to light and washing, and also deepening the shade. As it is not a strong oxidizing agent like chrome, it may be used at times where the latter cannot. Dye two test skeins of woolen yarn in a bath containing 20 per cent of Glaubersalt and 3 per cent of Direct Green; enter at 140° F., gradually raise to the boil, and dye at that temperature for one-half hour. Remove one of the skeins, and wash and dry. Add to the dyebath 3 per cent of chromium fluoride, re-enter the second skein and boil for twenty minutes longer; then wash and dry. Compare the two skeins with respect to their color and make tests on each to determine the fastness to washing.

Exp. 120. Example of a Substantive Dye not Coloring Wool.—There are a few of the substantive dyes which are not taken up by the wool fiber, especially if the bath is at a comparatively low temperature and is slightly alkaline. Dye a test skein of woolen yarn in a bath containing 20 per cent of Glaubersalt, 1 per cent of soda ash, and 2 per cent of Mikado Yellow; enter at 100° F., gradually raise to 120° F., and dye at that temperature for one-half hour; then wash well and dry. It will be found that the wool is

hardly tinted by this color. On this account, such dyes are very useful for the dyeing of union materials where it is desirable to leave the wool undyed.

Exp. 121. General Method of Applying Substantive Dyes to Silk.—This fiber, like wool, will dye very readily with many of the substantive colors, yielding shades which are fast to washing and water and in many cases fast to light. Dye a skein of silk in a bath containing 10 per cent of soap (or a boiled-off liquor bath may be employed where this is available) and 3 per cent of Benzo Fast Scarlet; enter at 140° F., gradually raise to the boil and dye at that temperature for one-half hour. Wash well and dry. Silk may also be dyed in a slightly acid bath, as with wool. Dye a skein of silk in a bath containing 3 per cent of Chrysophenine, 10 per cent of glaubersalt, and 4 per cent of acetic acid; enter at 140° F., bring to 180° F., and dye at that temperature for one-half hour. Wash

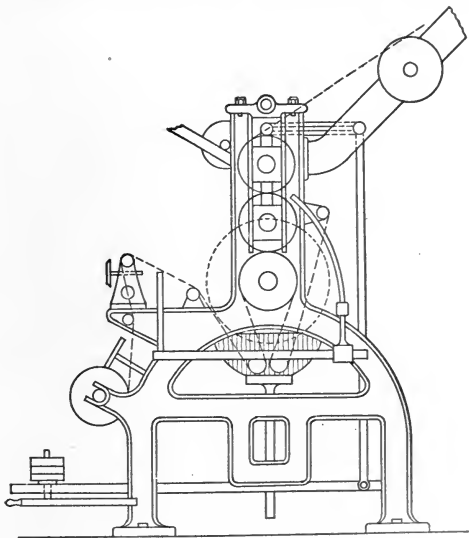

FIG. 166.—Padding Machine for Dyeing Cotton Cloth.

well and dry. As with wool, silk dyed with the substantive colors may be after-treated with chrome, etc., in order to obtain faster shades. The substantive colors are also very useful in the dyeing of half-silk (silk and cotton fabrics), both for single colors and for the production of two-color effects, in the same manner as already described under their application to wool.

Exp. 122. Representative Substantive Dyes.—Dye skeins of cotton yarn in baths containing 1 per cent of soda ash, 20 per cent of common salt and 2 per cent of the respective dyes named below; enter at 160° F., bring to the boil, and dye at that temperature for one-half hour, then wash and dry. Use the following dyestuffs:

- | | | |
|------------------------|-----------------------|------------------------|
| (1) Thioflavine S | (4) Diamine Orange D | (7) Diamine Rose BD |
| (2) Diamine Brown 3G | (5) Chicago Blue 6B | (8) Benzo Fast Scarlet |
| (3) Diamine Bordeaux B | (6) Columbia Black FB | (9) Dianil Blue G |
| | (10) Dianil Green G | |

Test these dyeings for fastness to washing and water.

Make a record of the results as follows:

Dyestuff.	Washing.			Water.	
	White wool.	White cotton.	Water.	White cotton.	Water.
.....					
.....					
.....					
.....					
.....					
.....					
.....					
.....					

4. Principal Substantive Dyes Applicable to Wool

Alkali Orange	Chrysophenine G	Diamine Steel Blue L
Azo Violet	Columbia Fast Scarlet 4B	Diamine Violet N
Benzo Azurine G, 3G	Columbia Green	Diamine Yellow CP
Benzo Blue BX, RW, 2R, 4R	Columbia Violet R	Diaminogene extra
Benzo Brown B, NB, G, 2G, 5R	Congo Brown G, R	Dianil Black N, E
	Congo Corinth G, N	Dianil Black T
Benzo Bordeaux 6B	Congo Orange G, R	Dianil Blue BX
Benzo Chrome Brown B, G, R	Congo Red 4R	Dianil Brown, 3GO, 3R
	Congo Rubine	Dianil Claret Red G, B
Benzo Cyanine B, R	Cotton Brown I, II, III	Dianil Copper Brown O
Benzo Dark Green B, 2G	Cotton Orange G, R	Dianil Green G
Benzo Fast Black	Cresotine Yellow G	Dianil Indigo O
Benzo Fast Blue 5R	Curcumine S	Dianil Orange N
Benzo Fast Orange S	Delta Purpurine 5B	Dianil Red R, 4B, 10B
Benzo Fast Red L, GL	Diamine Black HW	Dianil Scarlet G, 2R
Benzo Fast Scarlet 4BS, 8BS	Diamine Blue RW, 3B, 2B	Dianil Yellow G
GS	Diamine Brown 3G, R, M, B	Dianil Yellow 3G, R, 2R
Benzo Fast Violet R	Diamine Bordeaux B, S	Diazo Black B, R, 3B
Benzo Fast Yellow 5G	Diamine Brilliant Bordeaux	Diazo Fast Black SD
Benzo Green B, R	R	Diphenyl Citronine
Benzo Orange R	Diamine Brilliant Scarlet S	Diphenyl Fast Yellow
Benzopurpurine 4B	Diamine Catechine G	Direct Blue Black B, 2B, N
Benzo Rhoduline Red B, 3B	Diamine Fast Red F	Direct Fast Brown B
Benzo Violet R, RL	Diamine Fast Yellow FF	Eboli Green S, ST
Bordeaux COV	Diamine Gold	Erica B, G, 2GN
Brilliant Azurine B, G, 5G	Diamine Green G, B, CL	Geranine 2B, G
Brilliant Congo R	Diamine Jet Black OO	Hessian Bordeaux
Brilliant Dianil Red R	Diamine Orange B, F	Hessian Brilliant Purple
Brilliant Geranine B, 3B	Diamine Purpurine B, 3B,	Hessian Purple N
Brilliant Orange G	6B	Hessian Violet
Brilliant Purpurine 10B	Diamine Red B	Hessian Yellow
Carbazol Yellow	Diamine Red 4B, 6B, 10B	Mikado Orange
Chicago Blue B, 6B	Diamine Rose GD, BG,	Nyanza Black B
Chicago Blue 2R, 4R	BD, B	Orange TA
Chloramine Orange G	Diamine Scarlet B, 3B	Oxydiamine Brown G
Chrysamine G, R	Diamine Sky Blue FF	Oxydiamine Orange G, R

Oxydiamine Violet B, G, R	Polyphenyl Yellow	Thioflavine S
Oxydiamine Yellow TZ	Rose Azurine B, G	Toluylene Orange G, R
Pegu Brown	Salicine Yellow	Wool Brown G, R
Pluto Brown 2G, NB, R	Sun Yellow	Zambesi Black D, F
Pluto Orange G	Thiazole Yellow G, R	

5. Substantive Dyes Suitable for Silk

Aurophenine O	Chicago Blue 6B, 4B, B, RW	Diamine Steel Blue L
Azo Blue	Chicago Blue R, 2R	Diamine Violet N, 2B
Azo Violet	Chloramine Orange G	Diamine Yellow CP
Benzo Azurine G, R	Chloramine Violet R	Diamineral Brown G
Benzo Blue 2B, RW	Chloramine Yellow GG	Diaminogene extra
Benzo Brown B, G, R	Chrysamine G, R	Dianil Blue G, B, R
Benzo Chrome Brown B, G, R	Chrysophenine G	Dianil Brown 3GO, 4, BD
Benzo Cyanine 3B	Columbia Brown R	Dianil Orange G, N
Benzo Dark Green B, 2G	Columbia Fast Scarlet 4B	Dianil Red 4B
Benzo Fast Black	Columbia Green	Dianil Yellow R, 3G
Benzo Fast Blue B, 5R	Columbia Violet R	Diazo Black B, R
Benzo Fast Gray	Columbia Yellow	Diazurine B
Benzo Fast Orange S	Congo Brown G, R	Direct Blue Black B
Benzo Fast Pink 2BL	Congo Corinth G, B	Direct Bronze Brown
Benzo Fast Red GL	Congo Orange G, R	Direct Fast Brown B
Benzo Fast Scarlet 4BS	Congo Rubine	Direct Yellow R
Benzo Fast Violet R	Cotton Brown I, II, III	Erica B
Benzo Fast Yellow 5GL	Cureumine S	Geranine 2B, G
Benzo Green 2B, G	Delta Purpurine 5B	Heliotrope BB
Benzo Indigo Blue	Diamine Blue BX, 2B	Hessian Purple N
Benzo Olive	Diamine Blue RW	Janus Brown R
Benzopurpurine 4B	Diamine Bordeaux S	Janus Red B
Benzo Red SG	Diamine Brown 3G, R, B	Janus Yellow G, R
Benzo Rhoduline Red B	Diamine Dark Blue B	Mikado Orange GO, 4RO
Benzo Sky Blue	Diamine Fast Blue G	Neutral Gray G
Benzo Violet R, RL	Diamine Fast Brown G, R	Oxydiamine Black FFC, JB
Brilliant Azurine B, 5G, 2R	Diamine Fast Red F	Oxydiamine Brown, 3GN
Brilliant Benzo Blue 6B	Diamine Fast Yellow B, FF, M	Oxydiamine Violet B, R, G
Brilliant Benzo Green B	Diamine Gray G	Pluto Black A, F
Brilliant Congo R	Diamine Green B, CL, G	Pluto Orange G
Brilliant Dianil Red R	Diamine Orange F, G, D	Rose Azurine B, G
Brilliant Geranine B	Diamine Red B	Salmon Red
Brilliant Orange G	Diamine Rose BD, BG	Thioflavine S
Brilliant Purpurine R, 10B	Diamine Scarlet B, 3B	Toluylene Orange G
Brilliant Sulphon Azurine R	Diamine Sky Blue	Zambesi Black D
Catechu Brown DX		Zambesi Brown G

CHAPTER XV

DEVELOPED DYES ON COTTON AND SILK

1. The Production of Developed Colors on Cotton.—The defect of the substantive dyes on cotton is their liability to bleed when washed, although this may be remedied in some cases by an after-treatment with certain metallic salts; still faster dyeings may usually be obtained by the diazotizing and developing process. This process is more especially employed for the production of Primuline Red as a substitute for the more expensive Turkey Red,* and for the production of fast blacks; the other colors are not so much used. The developing process not only materially increases the fastness of the colors to washing and acids but it also greatly increases the intensity of the shade.† It has already been noted that the substantive colors do not yield very deep shades on cotton, even when large amounts of dyestuff are used in the bath; in many cases the blacks when dyed direct give only dark blue or slate colors, and produce only a deep black on being diazotized and developed.‡ Not all of the substantive dyes may be developed, but a sufficient number of them are susceptible to this treatment to give a wide range of shade, and there are a number of the dyes which diazotizing does not affect, and which may in consequence be used for purposes of shading, being added directly to the same dye-bath as the developed color.

The dyeing of developed colors is distinctly a chemical operation whereby one dyestuff is changed into another on the fiber.§ The nitrous acid of the diazotizing bath converts the amino group of the first dyestuff into an unstable azo body, which is subsequently combined with a

* This process seems to have first been employed by the English chemist Green in 1887 using Primuline, a dye which he had discovered.

† The fastness to washing of the colors obtained by diazotizing and developing is, as a rule, very good. With the same dyestuff, however, the fastness may vary considerably with different developers. Primuline, for example, developed with beta-naphthol gives a color somewhat faster to washing than when developed with phenylene-diamine or with phenol. In fastness to light the developed colors, in general, are about the same as the dyes from which they are derived. The diazotizing and developing process does not appear to increase the fastness of the color in this respect. In fastness to acids the developed colors, as a rule, are very good, and may be used very satisfactorily for purposes of cross-dyeing.

‡ In order that a substantive dye may be suitable for diazotizing, it is necessary that it contain a free amino group ($-\text{NH}_2$) in the molecule.

§ On this account the developed dyes were frequently spoken of as "ingrain" colors

“ developer ” to form a stable azo dyestuff. The operation may be represented by the following schematic equations:

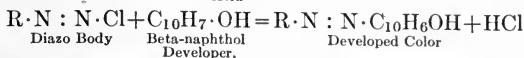
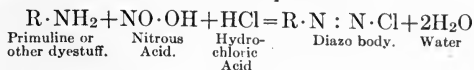

From this it may be seen that the Primuline is converted into another totally different body. The diazotizing and developing reactions are also very largely employed for the production of the majority of the substantive dyes themselves, without any reference to the fiber.

Although there are quite a number of dyestuffs (and other bodies as well) that are capable of undergoing the above reactions, yet there are but a limited number with which the process may be used to give the desired results. The developed color must be faster, or possess other exceptional qualities, and to this end it is necessary that the new dye prepared on the fiber be insoluble and also possess satisfactory tinctorial properties. The properties of some dyes are not affected by the diazotizing and developing processes, while others have their fastness very much increased without any great alteration in the color; the general tendency of the process, however, is to considerably deepen the shade.

It must be borne in mind that developed colors require three different operations and as many different baths; this necessitates, of course, a triple handling of the cotton and therefore a greater expense than when dyeing the substantive colors alone. There is nothing different in the first dyeing process of the developed colors beyond that of the ordinary substantive dyes, which have already been discussed. The second operation, that of diazotizing, is the same for all the developed colors, and consists in working the dyed and rinsed cotton in a cold bath containing sodium nitrite and hydrochloric acid; the operation requires only ten to fifteen minutes. After diazotizing it is well to rinse the goods in water slightly acidulated with hydrochloric acid. The third operation, that of developing, is also done in a cold bath and requires only from ten to fifteen minutes; the kind of developer* used depending on the dyestuff employed and the color desired.

* When developers of a phenol character are employed (such as beta-naphthol) it is necessary to first dissolve them in a little hot water containing caustic soda or soda ash (about the same amount as developer used), and the developing bath should always be somewhat alkaline in character, as a small amount of acid is always carried over in the goods from the diazotizing bath; hence in a standing bath of developer it is necessary to add from time to time a small amount of alkali, sodium acetate being the most suitable salt to employ. When amino developers are used (such as meta-phenylenediamine), if they are not already in the forms of salts (as amines are of a basic character), they must first be dissolved in hydrochloric acid. This is most conveniently done by adding the acid to the amine suspended or melted in water.

A diazotizing bath for 10 lbs. of cotton can be prepared with $\frac{1}{2}$ lb. sodium nitrite and $\frac{3}{4}$ lb. hydrochloric acid (of 32° Tw.); sulphuric acid may be used in place of hydrochloric, in which case only $\frac{1}{2}$ lb. of acid (of 168° Tw.) is employed. In preparing the bath the nitrite should first be dissolved in some water, added to the bath, after which the acid is added.* For standing baths only one-third of the above mentioned quantities is used. In order to ascertain if the diazotizing bath is still active, dip into it a piece of paper impregnated with starch paste and potassium iodide, which should at once turn blue. When working the bath it should smell dis-

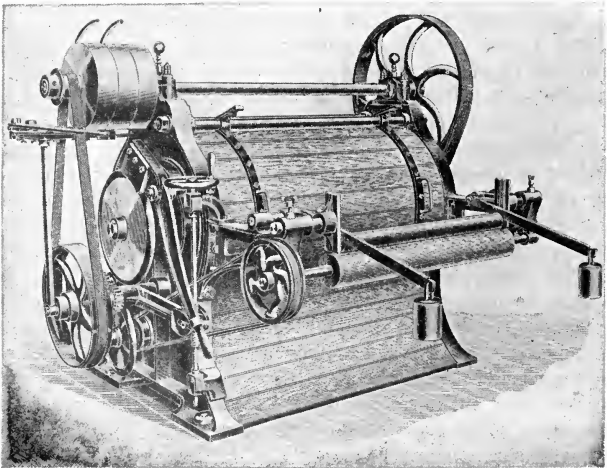

FIG. 167.—Centrifuge for Cloth. (Heine.)

tinety of nitrous acid, though the odor should not be too pungent, which would indicate an excess of nitrite. This is not necessarily injurious, but should be avoided for reasons of economy. The diazotizing is best conducted in wooden vessels, though when dyeing in machines the diazotizing and developing may take place in copper vessels. It is not neces-

* Based on the weight of the cotton the following proportions are recommended for the diazotizing bath:

	For Pale or Medium Shades Per Cent	For Heavy Shades Per Cent
Sodium nitrite.....	1½	2½
Hydrochloric acid.....	5	7½
or Sulphuric acid.....	3	5

The dyed cotton is rinsed in cold water and then worked for fifteen minutes in the cold diazotizing bath. The goods are then once lightly rinsed in water acidulated with hydrochloric acid and developed without delay. When diazotizing in machines or the jigger, smaller amounts of nitrite and acid will usually be found sufficient.

sary to hydro-extract or wring out after diazotizing; the goods are allowed to drain, and then rinsed slightly in water acidulated with 1 pint of hydrochloric acid to 100 gallons, and then entered directly into the developing bath. It is also important to remember that the diazotized goods should not be left standing for any length of time, but the rinsing and developing should proceed immediately after the diazotizing. Especial care should be taken not to expose the diazotized color to glaring light or to any source of heat.

The developing bath is prepared with cold water and the requisite amount of developer in solution. The goods are turned a few times in this bath, then taken out and rinsed off.

2. Developers.—The principal developers in use are beta-naphthol and phenylene-diamine. The latter, however, is usually a mixture containing more or less toluylene-diamine, the action of which is practically the same.

The beta-naphthol solution for developing may be prepared conveniently by dissolving 7 lbs. 3 ozs. of beta-naphthol and 6 lbs. caustic soda (of 77° Tw.) in 10 gallons of boiling water; for each 10 lbs. of cotton developed use 1½ pints of this solution.* For phenylene-diamine or toluylene-

* The following methods of preparing some other developers are recommended:

Developer.	Amount Dissolved in 10 Gallons of Boiling Water.	Amount of Solution Used for 10 lbs. Cotton.	
		Light Shades.	Heavy Shades.
Naphthylamine Ether powder	2 lbs. 4½ ozs. with 1 lb. 2 ozs. hydrochloric acid	3¼ pints.	6½ pints.
Naphthylamine Ether N powder	2 lbs. 4½ ozs. with ½ pint of hydrochloric acid	3¼ pints	6½ pints
Fast Blue Developer AN	13½ lbs.	⅔ pint	1½ pints
Fast Blue Developer AD	3 lbs. 11 ozs. with 1½ lbs. of hydrochloric acid	2 pints	4 pints
Resorcine	5½ lbs. with 12 lbs. of caustic soda, 77° Tw.	⅝ pint	1¼ pints
Phenol	4 lbs. 11 ozs. with 12 lbs. of caustic soda, 77° Tw.	⅞ pint	1¼ pints
Bordeaux Developer	2 lbs. 4½ ozs. with 1½ pints of hydrochloric acid	3¼ pints	6½ pints

diamine, dissolve $4\frac{1}{2}$ lbs. of the salt with $1\frac{1}{2}$ lbs. of soda ash in 10 gallons of boiling water, and $1\frac{1}{2}$ pints of this solution is sufficient for 10 lbs. of cotton.* If the baths are used repeatedly, the above quantities are used for the first two or three lots, after which only three-fourths the amounts are taken.† The amount of water in the diazotizing and developing baths should be about twenty times the weight of the cotton. An addition of bluestone to the diazotizing bath increases the fastness to light of the color in most cases; for such purpose, however, it is best to give an after-treatment with bluestone after developing, by passing the goods through a cold or lukewarm bath containing 3 per cent of bluestone and 3 per cent of acetic acid, and then rinsing. After development or after this treatment the cotton is usually soaped or oiled for the purpose of softening. Developed dyeings may be topped with basic dyes in the same manner as the direct dyeings with substantive colors.

By combining the same dyestuff with different developers a variety of colors may be obtained; for example:

- Primuline with beta-naphthol = red;
- Primuline with alpha-naphthol = claret-red;
- Primuline with phenol = yellow;
- Primuline with resorcine = brown;
- Primuline with phenylene-diamine = red-brown.

In the dyeing of blacks with phenylene-diamine as the developer a bluer tone may be given by adding a small quantity of beta-naphthol to the developing bath. Care must be had, however, in thus mixing devel-

* The quantities of the different developers required may be calculated on the following basis:

Developer.	For Developing of	
	2 Per Cent Dyeings. Per Cent	4 to 5 Per Cent Dyeings. Per Cent
Beta-naphthol	0.45	0.90
Naphthylamine Ether powder	0.75	1.50
Naphthylamine Ether N.	0.75	1.50
Blue Developer AN	1.00	2.00
Fast Blue Developer AD.	0.75	1.50
Resorcine	0.35	0.70
Phenylene-diamine powder	0.35	0.70
Phenol	0.25	0.50
Bordeaux Developer	0.50	1.00

† Care should be taken not to employ too large an amount of developer in dyeing, and this is especially true in the case of blacks obtained with phenylene- or toluylene-diamine. The excess of developer which does not react with the diazo body will remain in the goods and on exposure to air will turn brown, thus giving a dull rusty tone to the black color, and also causing excessive bleeding when washed with white cotton. On the other hand, the use of too small a quantity of developer will cause the color to lack fullness—have a so-called “hungry” look—and also to have inferior fastness to washing.

opers, as some do not work well with others. The following, however, can be used together.

- Beta-naphthol with resorcine;
- Beta-naphthol with phenylene-diamine;
- Beta-naphthol with toluylene-diamine;
- Phenylene-diamine with resorcine;
- Toluylene-diamine with resorcine;
- Naphthylamine ether with Fast Blue Developer AD.

A few of the diazotized colors may be developed in another manner than that indicated in the foregoing. Primuline, for instance, may be developed by treating in a lukewarm bath (100° F.) containing soda ash (2½ to 5 per cent, according to depth of shade), a yellow color of fairly good fastness being obtained. Diamine Cutch may also be developed in this manner.* Another variation in the method of developing is to treat with a cold dilute (½° Tw.) solution of bleaching powder. Primuline treated in this manner gives a yellow color of great fastness to light, washing, cross dyeing and even to bleaching. The same method is used independently of dyeing for the manufacture of a yellow dyestuff (Chloramine Yellow).

The following is a list of the principal developers with their common trade names:

1. Beta-naphthol, frequently known just as "naphthol" = Red Developer, Dye Salt II.
2. Sodium salt of beta-naphthol, frequently not distinguished from the above = Developer A.
3. Beta-naphthol-7-sulphonic acid (sodium salt); this is known as "F-acid," or "mono-sulphonic acid," or "shading salt."
4. Naphthol R; this is a mixture of beta-naphthol with 10 per cent of F-acid; it gives a bluer tone of red than beta-naphthol alone in developing Primuline or Para Red = Dye Salt I. †
5. Resorcine = Developer F, Orange Developer, Dye Salt VI.
6. Phenol = Developer J, Yellow Developer, Dye Salt VII.
7. Meta-phenylene-diamine hydrochloride = Developer C. Brown Developer, Dye Salt V.
8. Meta-phenylene-diamine base = Developer E.
9. Meta-toluylene-diamine base = Developer H.
10. Ethyl-beta-naphthylamine = Naphthylamine Ether, Developer B.
11. Amino-diphenylamine = Fast Blue Developer AD.
12. Amino-naphthol-sulphonic acid G = Blue Developer AN, Developer G.
13. Alpha-naphthol = Maroon Developer.
14. Alpha-naphthol-para-sulphonic acid = Crimson Developer.

*The diazotized goods are entered directly into the alkali bath without a previous rinsing, and worked for about fifteen minutes, after which they are rinsed and soaped in the usual manner.

† As Naphthol R contains a sulphonic acid the red dyestuff produced is more soluble than that with beta-naphthol alone, and hence is less fast to soaping.

15. Alpha-naphthol-sulphonic acid R = Dye Salt IV.
16. Beta-naphthol-disulphonic acid = Maroon Developer.
17. Dioxy-naphthalene = Developer D.
18. Diamino-azobenzene hydrochloride = Chrysoidine.
19. Naphthol AS; this is beta-oxy-naphthoic acid anilide, $C_{10}H_7(OH)(CO \cdot NH \cdot C_6H_5)$. It is used particularly as a developer for the naphthol class of dyes.
20. Nerogene D is a chlorinated diamine.

The usual developers consist of amines or phenols (or naphthols) or sulphonic acid derivatives of these. When using toluylene-diamine, as this is very sensitive to oxidation, in order to prevent the development of a brown tone it is necessary to make the first wash water slightly acid so that any residues of the developer may be dissolved and removed.

The shade of color developed from any particular dyestuff varies considerably with the different developers; this may be shown by a consideration of the action of different developers on Primuline:

Beta-naphthol	gives	red
R salt	gives	maroon
NW salt	gives	crimson
Resorcine	gives	orange
Phenol	gives	yellow
Meta-phenylene-diamine	gives	brown
Alpha-naphthylamine	gives	purple
Naphthylamine ether	gives	blue
Ethyl-beta-naphthylamine	gives	maroon
Beta-naphthol-sulpho acid S	gives	red
Benzidine	gives	dull drab yellow
Salicylic acid	gives	yellow
Caustic soda	gives	dull yellow
Amino-diphenylamine	gives	pale green
Dianisidine	gives	pale green
Dioxy-naphthalene	gives	gray

These colors, however, are by no means of equal importance; the alpha-naphthylamine purple, for example, is very fugitive to light; the blue from naphthylamine ether is not fast to washing, etc. In practice this greatly curtails the range of shades obtainable from Primuline, the beta-naphthol red being by far the most important.

3. Methods of Shading Developed Dyes.—From a consideration of the process by which developed dyes are applied it will be readily understood that the intensity or depth of the color obtained will depend entirely upon the amount of color fixed in the first operation, since the diazotizing and developing baths must always contain an excess of the reagents. This fact presents certain difficulties in the way of readily matching shades to a sample, particularly as there may be no combination of dye and developer that may yield the exact shade required. A number of methods, however, may be employed for the purpose of modifying the shade

of any particular developed dyeing in order to match any desired shade. These methods may be summarized as follows:

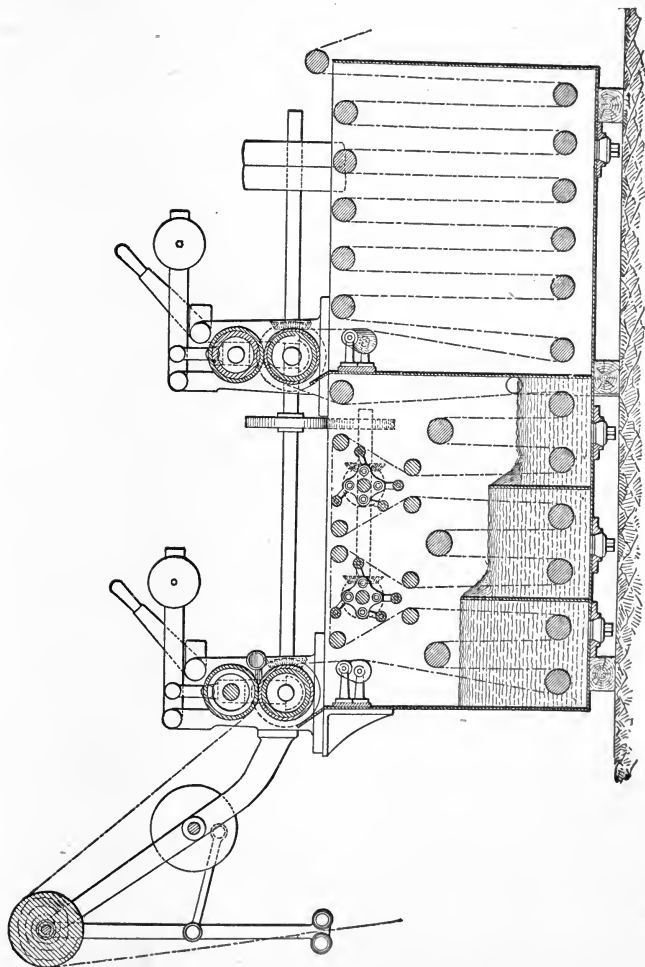

FIG. 108.—Washing and Dyeing Machine for Open Width. (Dehaitre.)

(a) Dyeing with a mixture of two or more diazotizable dyes. In carrying out this method care should be taken to select those dyes which

require similar conditions in the dyebath, as otherwise great waste of color may ensue. This method is chiefly used for the dyeing of clarets, browns, and blacks.

(b) Using a mixture of developers. In this case it is, of course, necessary to use either alkaline or acid developers exclusively, or to employ those that, even if not of the same class, may yet work together. The shades produced in this case are usually intermediate to those which would be obtained by the developers if used singly.

(c) The use of an amino developer, and subsequent rediazotization of the color and development of the color anew. This method is not much employed, as it requires such a number of processes and the duplication of the color in succeeding lots is very difficult. It is only suitable for the dyeing of certain browns.

(d) Dyeing simultaneously with a mixture of diazotizable and non-diazotizable dyes. This is the most important method for producing radical modifications of shade and is the one which is chiefly used in practice. Only those dyes which are unaffected by the process and which at the same time are fast to washing and acids should be used.

(e) Topping the developed dyes with basic colors. The developed dyes act as mordants for the basic colors in the same manner as the substantive dyes. This process is very useful in enabling exact matching of colors and also for the purpose of adding brilliancy of tone to the developed dyes, which otherwise are rather dull.

4. Application of Developed Dyes to Silk.—The process of diazotizing and developing certain of the substantive colors on the fiber may be applied to silk with very good results. The colors so obtained have excellent fastness to water and boiling soap,* and some of the dyes have even good fastness to milling. Where colors requiring these qualities are needed on silk this process of dyeing is quite largely used. This is especially true where a fulling fast black is desired on silk noils to be used for fancy effects in woolen fabrics. The method of applying these dyes to silk is practically the same as that used in dyeing cotton. The substantive dye is first applied in a bath containing boiled-off liquor or soap with the addition of 10 to 40 per cent of Glaubersalt (depending on the depth of the shade). The silk is entered lukewarm and the bath is gradually brought to the boil and dyed just under the boil for one-half hour. In some cases it may be necessary to acidify the bath with acetic or sulphuric acid in order to

* Colors on raw silk which will subsequently withstand a degumming operation in a boiling soap bath may be obtained with Primuline developed with beta-naphthol and with Diamine Fast Yellow A coupled with diazotized paranitraniline. Other colors which will also stand this process are Victoria Blue B, Formyl Violet S4B after-treated with tannin and antimony, as well as most of the alizarine dyes on a chrome mordant.

obtain proper exhaustion of the color. After dyeing the goods are rinsed and diazotized in a cold bath containing 4 per cent of sodium nitrite and 6 per cent of sulphuric acid, rinsed, and then developed immediately as required. About the only developers used in connection with silk dyeing are phenylene-diamine salt (use 0.7 per cent dissolved in one-third its weight of soda) and beta-naphthol (use 1 per cent dissolved in its own weight of caustic soda lye of 77° Tw.). The developing bath is used cold for fifteen minutes, then rinse well and wash in a hot soap solution; finally brighten by passing through weak acetic acid and dry without rinsing. Primuline Red and Diazo Black are the two principal developed colors used for silk.*

The following list gives the substantive dyes which may be applied to silk by the method of diazotizing and developing the color on the fiber.

Benzo Fast Black (beta-naphthol)	Diazo Bordeaux (beta-naphthol)
Benzo Nitrol Browns (diazotized paranitraniline)	Diazo Brilliant Black B (naphthol S)
Columbia Brown R (toluylene-diamine)	Diazo Brown G (beta-naphthol, also with soda)
Diamine Azo Blue R (beta-naphthol)	Diazo Indigo Blue B, M (beta-naphthol)
Diamine Azo Scarlet B, R (beta-naphthol)	Diazo Red Blue 3R (beta-naphthol)
Diamine Black BH (beta-naphthol, phenylene-diamine)	Direct Deep Black E, RW (beta-naphthol)
Diamine Nitrazol Browns (diazotized paranitraniline)	Naphtogene Blue 2R (beta-naphthol)
Diaminogene B (beta-naphthol, phenylene-diamine)	Pluto Orange G (diazotized paranitraniline)
Diaminogene Blues (beta-naphthol)	Primuline (beta-naphthol)
Diaminogene Sky Blue N (beta-naphthol)	Zambesi Black D, F, R (toluylene-diamine)
Diazethyl Black (naphthol S)	Zambesi Brown G (toluylene-diamine)
Diazo Black 2B (beta-naphthol)	Zambesi Indigo Blue 2R (beta-naphthol)
Diazo Blue 3R (beta-naphthol)	Zambesi Pure Blue 4B (beta-naphthol)

5. Coupled Dyes.—This class of colors, though of minor importance, has some use for the production of fast brown shades on cotton. Like the developed colors, they are also built up by chemical means in the fiber itself, but instead of the dyestuff which is dyed on the cotton being diazotized, the operation is reversed, and the dyestuff is used as a developer to combine (or *couple*) with a diazotized base, † which latter consists almost

* The coupling process of treating the dyed color with diazotized paranitraniline may also be used in the dyeing of silk for the production of certain fast shades. The method is carried out in the same manner as for cotton.

† The building up of dyestuffs directly on the fiber may take place in three different ways:

(a) Dyeing with certain substantive colors, then diazotizing and finally developing with a phenolic or amino body. This is the process which has just been considered.

(b) Dyeing with certain substantive colors, then developing with a solution of diazotized paranitraniline. This includes the group of coupled dyeings.

(c) Padding the cotton with a phenolic body (such as beta-naphthol), then develop-

exclusively of *paranitraniline*, $C_6H_4(NO_2) \cdot (NH_2)$. The process consists briefly of dyeing the cotton with a suitable substantive dyestuff in the usual manner, then coupling in a fresh cold bath containing a solution of diazotized paranitraniline, soda ash, and sodium acetate. The solution of diazotized paranitraniline is prepared as follows: 2 lbs. of paranitraniline are dissolved in $1\frac{1}{2}$ gallons of pure boiling water, adding $\frac{1}{2}$ gallon of hydrochloric acid (32° Tw.) and stirring until the solution is complete. Then add $3\frac{1}{2}$ gallons of cold water, which will precipitate paranitraniline hydrochloride in the form of a yellow paste. When this is cold a solution of $1\frac{1}{2}$ lbs. of sodium nitrite in 1 gallon of cold water is added. In about fifteen to twenty minutes a clear solution should result; this is diluted to

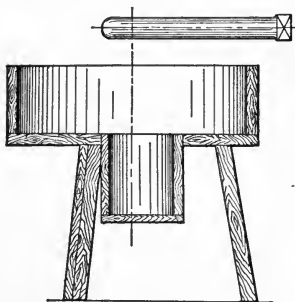

FIG. 169.—Apparatus for Impregnating Yarn with Beta-Naphthol.

20 gallons with cold water. The solution thus prepared consists of the diazo body of paranitraniline, $C_6H_4(NO_2) \cdot N : N \cdot Cl$, and is a quite unstable substance. On this account the solution should be prepared just before being needed, and should not be kept for any great length of time. If preserved from direct light and heat in wooden or earthen vessels, it will keep its strength for several days. The coupling bath for 100 lbs. of cotton for light shades ($1\frac{1}{2}$ to 2 per cent dyeings) is prepared with $3\frac{1}{2}$ gallons of the diazotized paranitraniline

solution, 8 ozs. of soda ash, and $3\frac{1}{4}$ ozs. of sodium acetate. For heavy

ing with a diazotized amino base. This includes the group of naphthol colors, of which Paranitraniline Red is the type and chief representative.

All three of these methods are the same in principle, and include the same three essentials:

- (a) An aromatic amino base.
- (b) A diazotizing process whereby this base is converted into a diazo salt.
- (c) A phenolic or amino body capable of combining with the diazo salt to yield a stable dyestuff.

The first method differs from the other two in the order in which these three essentials are applied to the cotton fiber. The first two methods start with a body which already possesses the properties of a substantive dyestuff, while in the third method no actual dyestuff at all is employed, but the coloring matter is formed from its constituents. In the first method the substantive dye used furnishes the base of the diazo body; whereas in the second method the dyestuff plays the rôle of the developer with which the diazo salt is to be combined. In the third method only phenolic bodies are employed for coupling with the diazo salt of the base, though the number of bases with which the diazo salts may be used is quite large.

shades (3 to 4 per cent dyeings) these quantities are increased to 5 to 7 gallons of diazotized paranitraniline solution, 1 lb. of soda ash, and 6 ozs. sodium acetate. The dyeings obtained by this process have very good fastness to washing, fulling, and acids. The colors may be shaded by the addition of small quantities of basic dyes to the coupling bath. Attempts have been made to prepare the diazotized paranitraniline in such a form that it will be stable enough to become an article of trade. One such preparation was Nitrazol C, but, owing to the liability of this substance to spontaneous combustion, it is no longer handled. Nitrosamine Red, Benzo Nitrol and Azophor Red PN are somewhat similar products.

Azophor Red PN is a form of diazotized paranitraniline,* and is sold as a brownish yellow powder. The padding with naphthol is done in precisely the same manner as when employing paranitraniline, but the developing bath is prepared in a somewhat different manner. †

**Azophor Red PN* is diazotized paranitraniline with an admixture of aluminium sulphate and sodium sulphate. *Nitrazol C* is paranitraniline diazotized in a solution of strong sulphuric acid and mixed with sufficient sodium sulphate to produce a stable solid mass. *Nitrosamine Red* is the sodium salt of para-nitro-phenyl-nitrosamine produced by the action of caustic soda on para-nitro-diazobenzene chloride. As such it does not react with the alkaline solution of beta-naphthol, but is readily reconverted into the diazo compound by the action of acid, and consequently it may be used in acid solution like the ordinary diazo compound.

Paranitraniline S. is the crystallized sulphuric acid salt of paranitraniline. It occurs in the form of a dull yellowish crystalline powder. When treated with water it turns to a deep yellowish color, decomposing into free sulphuric acid and paranitraniline; hence it can only be dissolved in hot water containing acids. It is used in practically the same way as paranitraniline but only requires one-half the quantity of sodium nitrite for diazotization, as it contains one-half the amount of actual paranitraniline.

† The manufacturers recommend the following process: 50 lbs. of Azophor Red PN are dissolved by stirring in 40 gallons of cold water; this requires from fifteen to twenty minutes, after which the solution is allowed to stand for one to two hours, and then strained through a cotton cloth to remove a small amount of insoluble matter which rises to the surface. The clear solution thus obtained, which contains a salt of para-nitro-diazo-benzene, is neutralized by the addition of 26.8 lbs. of caustic soda (36° Tw.), diluted to 10 gallons, stirring fifteen minutes, or until the precipitate which it produces redissolves; the whole developing solution is then diluted with its own volume of water, or 50 gallons. The developing bath must be used directly after neutralizing with soda, but the acid solution obtained by dissolving the Azophor Red PN is fairly stable, and if kept in a cool place and not exposed to a strong light, may be kept for several days. After passing through the bath the cotton is allowed to stand for a short time to insure complete development, after which it is washed and soaped for fifteen minutes at 140° F. in a solution containing 1 gram of soap per liter. By the use of Naphthol R in the padding solution instead of the ordinary beta-naphthol, somewhat bluer reds are obtained. It is also considered that the addition of Para Soap PN (ricinoleate of ammonia) instead of Turkey-red oil to the bath increases the brilliancy of the color.

Nitrosamine Red has the probable constitution of C_6H_4 $\begin{cases} N \begin{cases} NO \\ Na \end{cases} \\ NO_2 \end{cases}$

It is quite stable, and on treatment with hydrochloric acid yields paranitro-diazo-benzene chloride; that is, diazotized paranitraniline, according to the following reaction:*

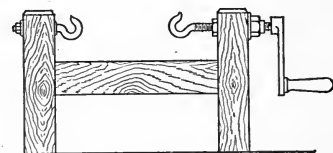
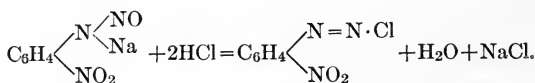

FIG. 170.—Wringer for Naphthol Prepared Yarn.

6. The Naphthol Colors.—This class includes such colors as Paranitraniline Red, Dianisidine Blue, etc.† They are azo dyes built up on the fiber by first treating with a developer (usually beta-naphthol) and then with a diazotized solution of a suitable base, such as paranitraniline. The process is practically the reverse of the ordinary method for the production of diazotized and developed colors, and is more analogous to the

* The preparation of the developing solution consists in treating the Nitrosamine Red with acid; 87.5 lbs. of Nitrosamine Red paste are mixed with 75 gallons of water and 37.5 lbs. of hydrochloric acid (30° Tw.). Stir well for ten to fifteen minutes, then add 44 lbs. of acetate of soda crystals. Stir till dissolved, strain through cloth, and dilute to 100 gallons. It is possible to dye with Nitrosamine Red and beta-naphthol in one bath, but the colors produced are inferior to those obtained by padding previously with the naphthol solution. The process is as follows:

Single-bath Nitrosamine Red.—Dissolve by stirring 3 lbs. 2 ozs. of powdered beta-naphthol, 2 lbs. 13 ozs. caustic soda (70° Tw.) 17 lbs. of Nitrosamine Red (25 per cent) in 20 gallons of water. Then add 10 lbs. of Turkey-red oil. Pad the cloth in this solution, dry at a low temperature, and allow to lie twelve hours to develop. At the end of this time the cloth will have acquired a dull orange color, and is then washed and soaped to clear the color.

† Probably the first commercial application of the naphthol colors was in England in 1880 by Holliday, who dyed yarn a fine bluish red for towel headings under the name of Vacanceine Red. It was produced by padding the yarn with beta-naphthol and coupling with diazotized beta-naphthylamine. Para Red was first produced in 1889 and was developed by the Farbwerke Höchst. It rapidly became a cheap substitute for Turkey Red on piece-goods but was not employed to any great extent in yarn dyeing. It was very largely introduced as a printing color in Russia.

process used in the dyeing of the coupled colors, except that instead of starting with a dyestuff in the first place, a simple developer without special tinctorial properties is used.

The naphthol colors are more employed in cotton printing than in dyeing; in the latter Paranitraniline Red is about the only color of this class which has any practical importance.

The principal developers used in this process are the following: beta-naphthol (and its related products such as Naphthol R * and D), alpha-

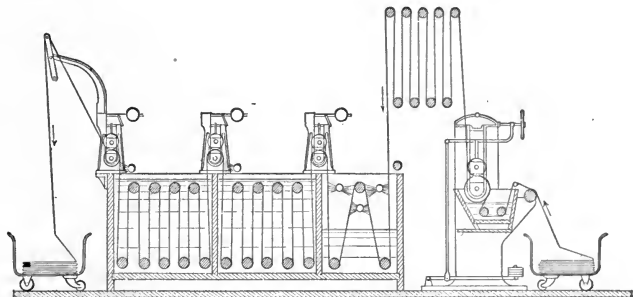

FIG. 171.—Developing Para Red on Piece-Goods. (Cassella.)

naphthol and resorcin. The principal bases which may be used, and the colors they produce in combination with beta-naphthol, are as follows:

<i>Base.</i>	<i>Color with beta-naphthol.</i>
Alpha-naphthylamine	bluish red
Amino-azo-benzene	crimson
Aniline	orange yellow
Azo-black base	black
Benzidine	purplish brown
Beta-naphthylamine	crimson
Chloranisidine	scarlet
Dianisidine	blue
Meta-nitraniline	orange
Nitro-ortho-toluidine	orange red
Nitro-para-toluidine	orange
Nitro-phenetidine	bluish crimson
Ortho-amino-azo-toluene	claret red
Para-nitraniline	red
Para-toluidine	yellow orange
Tolidine	purplish brown

* This is the (2 : 7) beta-naphthol-mono-sulphonic acid F, and is also known as shading salt. It gives a bluer tone to the red. Naphthol D is a mixture of beta-naphthol with dioxy-naphthalene.

The general process of dyeing with the naphthol colors is first to impregnate the cotton with a solution containing the beta-naphthol and soluble oil; the preparation of the solution of the diazotized base; and the development of the color in the diazo solution.

The fastness of the naphthol colors is in general very good, in fact surpassing most of the cotton dyes in this respect with the exception of the vat dyes.* Most of the colors are very fast to soaping and washing and light, and many also possess good fastness to bleaching with chlorine. These colors have, however, certain defects: (a) they are liable to crock to a considerable degree, especially if not very carefully dyed, and this would be expected owing to the pigment character of the dyestuff formed in and on the fiber; (b) they sublime from the fiber when heated.†

7. Paranitraniline Red.—This is much used in place of Turkey Red. It furnishes a very fine bright shade of red, somewhat more yellow in tone, however, than Turkey Red. The shade may be made bluer in tone by proper treatment.‡ The color is very fast to washing and fulling, not bleeding into interwoven white when scoured in hot soap solutions. It

* There appeared on the market in 1914 a new developer known as Naphthol AS, consisting of beta-oxy-naphthoic acid anilide. This compound aroused considerable interest, owing to the great brilliancy and fastness of the colors obtainable from it. The blue produced by coupling it with dianisidine in the presence of copper chloride is said to be faster to chlorine bleaching than either Indigo or Hydron Blue and the red obtained by coupling it with Fast Red G base is said to be faster to light than Para Red. A further advantage it possesses over beta-naphthol is that its solution appears to have substantive dyeing qualities on the cotton fiber, and hence it is not necessary to dry the naphthol-prepared material, but after well squeezing it from the naphthol bath the goods may be passed directly into the developing bath. It is used as follows: 12 parts Naphthol AS, 20 parts caustic soda (62° Tw.) and 30 parts Turkey-red oil. The Naphthol AS is stirred into a smooth paste with the caustic soda and the oil, then add water and boil until dissolved and make up to 1000 parts, then add 12 parts formaldehyde (40 per cent). Impregnate the cotton at 80 to 100° F. The makers of this product have also patented a process whereby the Naphthol AS may be mixed directly with certain nitrosamines and used directly under the name of "Rapid Fast Dyes." The concentrated solutions of the nitrosamines are mixed with the Naphthol AS alkali salt to give paste or powder products without formation of the color. These dissolve readily in cold water and their dilute solutions precipitate the respective dyes when warmed, or if acetic acid and chrome are added. The cloth to be dyed is simply padded with the mixed "Rapid Fast Dye," dried in a hot flue and passed through a solution containing acetic acid near the boil. The outbreak of the war prevented further development of this process.

† This quality, in fact, is employed as a characteristic test for the naphthol dyes on the fiber, the sample being placed between white cotton cloth and ironed with a hot iron, when the color will sublime onto the white cloth. Shades that have been coupled in the presence of a copper salt (like Dianisidine Blue) do not sublime.

‡ The use of aluminate of soda has been recommended to improve the bluish tone of Para Red, and to cause the beta-naphthol to be better fixed during the drying. It is employed as an addition to the naphthol preparation.

is also fast to perspiration and dilute mineral acids, also to dilute chloride of lime solution for mild bleaching. It is quite fast to light, though it is not equal in this respect to Turkey Red.

The chief difficulty attached to the dyeing of Paranitraniline Red is in the production of even shades which are well penetrated through the fiber. This is due to the uneven grounding with the beta-naphthol solution, and hence the solution must be padded on mechanically in a concentrated form. The cotton fiber has no especial attraction towards the beta-naphthol. Caustic soda is employed in this solution for the purpose of more thoroughly dissolving the beta-naphthol, which is not soluble in plain water. As it passes into solution in reality it becomes converted into the sodium salt of beta-naphthol. Soluble oil or Turkey-red oil is also used for the purpose of obtaining better penetration and a more even distribution of the beta-naphthol solution through the fiber. Much better

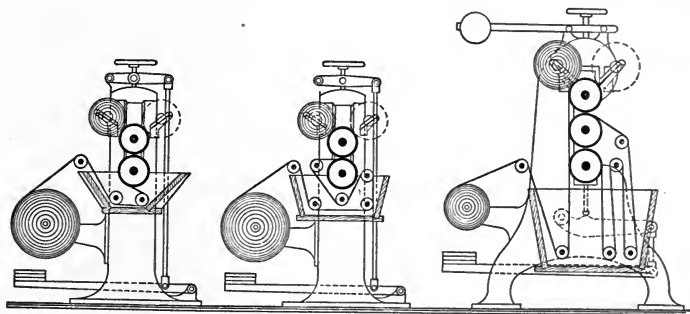

FIG. 172.—Types of Padding Machines Showing Methods of Running Cloth.

penetration is obtained on single-ply yarns than on tightly twisted yarns, and the yarn should also be especially well boiled-out and bleached * before attempting to pad with the naphthol solution. It is much easier to evenly pad cloth than it is yarn, as the mechanical processes are much simpler. After the cotton is padded it must be dried, which is for the purpose of making the beta-naphthol more insoluble, so that it will not be redissolved from the fiber when passed into the paranitraniline solution. The intensity of the ultimate color obtained depends on the amount of the beta-naphthol deposited in the fiber, and consequently on the strength of the padding solution. If heavier or more bluish shades are desired an increased amount of naphthol and caustic soda must be used; also by using Naphthol R a bluer tone may be obtained more closely approaching

* In order to brighten or clarify the shade of Paranitraniline Red on unbleached yarn, the cotton may subsequently be chlored in a solution of bleaching powder of 1° Tw.

that of Turkey Red. By reducing the amount of oil employed the ultimate color obtained will be yellower in shade. In employing the naphthol solution it is expedient to use it warm (120 to 140° F.), as the fiber will be better penetrated. The naphthol solution should be freshly prepared and used as soon as possible, as it commences to decompose in about ten hours' time. It should be kept in wooden, enameled, or earthenware vessels, and neither the solution nor the padded yarn or cloth should come in contact with metal, especially copper, as this will give rise to brownish spots.*

In the practical operation of this process the following procedure is recommended: Take 1 lb. † of yarn on a stick and work in about 2 gallons of the naphthol solution in a wooden vessel; give four to five turns, wring, shake out the skein, then wring again and lay the yarn aside. Add to the bath about $\frac{2}{3}$ pint of the naphthol solution, take a second pound-lot of the yarn and proceed as before. In wringing the yarn the excess of liquor is run back into the bath each time. The entire series of operations of steeping and wringing is now repeated taking the lots of yarn in the same succession as before, but no further additions of the naphthol solution are made.

The use of special yarn padding or impregnating machines has been introduced in this method of dyeing, but the secret of obtaining successful results is in the even distribution of the naphthol solution, and it is claimed that this can be done better by hand treatment than by any other means,

* By the action of copper salts Paranitraniline Red is easily converted into a brown, and this fact is turned to practical account for the production of brown shades. The copper salt may be applied either along with the naphthol or with the developer, or the developed color may be subsequently treated with the copper salt. The most satisfactory results, however, are obtained by adding the copper salt to the padding solution, because the presence of the metallic salt renders the diazo solution very unstable. This, of course necessitates, the preparation of an alkaline copper solution, and is done as follows: 350 grams of copper chloride (76° Tw.), 125 grams of tartaric acid, 100 grams of glycerin, and 425 grams of caustic soda (36° Tw.). Dissolve the tartaric acid in the copper solution, add the glycerin, and then run in the alkali gradually, stirring until the precipitate which at first forms redissolves. The naphthol preparation is made with 25 grams of beta-naphthol, 59 grams of caustic soda (36° Tw.), 30 grams of Turkey-red oil (or Para Soap PN), and 100 grams of the alkaline copper solution. Dilute to 1 liter, and pad in the usual manner, dry at a low temperature and develop as for red; the most suitable bases being para-nitraniline, meta-nitraniline, and beta-naphthylamine.

† In order that the quantity of naphthol solution retained by the yarn may be made as uniform as possible, it is recommended to weigh the yarn. For well-bleached yarn, the following proportionate weights may be taken as equivalent.

- 100 lbs. raw cotton yarn give
- 88 lbs. dry bleached yarn, or
- 152-158 lbs. hydro-extracted wetted yarn.

When properly padded with the beta-naphthol solution the same yarn should weigh hydro-extracted about 162-176 lbs., or dry about 97 lbs.

though, of course, it requires a highly skilled operator to carry out the processes successfully, as all the operations have to be conducted with the greatest exactness.

After all the yarn has been padded, it is hydro-extracted and hung up to dry. If the wringing or hydro-extracting is incomplete so that an excess of the naphthol solution is left in the fiber, brown streaks are liable to form.

For 100 lbs. of yarn the naphthol solution is prepared as follows:

- 3 lbs. of beta-naphthol;
- 3 lbs. of caustic soda solution (72° Tw.);
- 10 lbs. of Turkey-red oil, and dilute with water to 7½ gallons.

The time allowed for drying the yarn after padding should be about three hours, and the best temperature for drying is about 140° F.* To obtain good results it is absolutely necessary that the evaporated moisture be carried off by a flue or fan and also that the yarn should be turned several times during the drying, but without being touched by the hands.† This is to prevent an excess of the padding solution from accumulating in the lower parts of the hanks. The skeins should be hung up loosely and not overlap. Care must be taken in the drying not to have the yarn acquire a brownish color,‡ as this will considerably dull the eventual red color produced.

The paranitraniline bath should not have a temperature above 65° F., otherwise the color will not be properly developed and the shades will come out yellow and streaky.§ The diazotized paranitraniline solution

* If dried at high temperatures the beta-naphthol will volatilize from the fiber.

† In the drying of yarn grounded with beta-naphthol, the sticks on which the hanks are hung should be previously rubbed with some of the naphthol solution; and care should be taken to prevent any water dropping on the yarn during the drying, or a spot will be produced.

‡ In order to prevent the material from turning brown it has been recommended to add to the naphthol solution a solution of antimony oxide in caustic soda and glycerin. Tartar emetic (or other antimony salt), together with an equal weight of glycerin, is dissolved in water, and a solution of caustic soda is added until the precipitate at first formed is redissolved. The antimony salt should be used in the proportion of about 25 per cent of the naphthol. Ready prepared products of this nature are on the market, such as Naphthol LC. Owing to the expense of the antimony this process is rarely used. It is also claimed that the addition of glucose for the same purpose acts almost as well.

§ Diazo compounds are notably very unstable products, and are not prepared in the solid state for dyeing. Even in solution they gradually decompose, particularly when heated, and in decomposing they form resinous products from which good colors cannot be obtained. It is necessary, therefore, to keep the temperature low, if possible, below 40° F. This is true of all diazo solutions, whether used for naphthol dyes or for other classes of developed dyes. As ice is frequently added to keep the temperature down, all these classes of dyes are sometimes spoken of as "ice colors." The diazo compounds also decompose rapidly in alkaline solution, hence it is essential to use a

under normal conditions will keep for several days, but after the addition of the acetate of soda it will not keep more than eight to ten hours. Copper or metal vessels should not be used for this solution. In the practical working of the process it is recommended to operate in the same manner as for the grounding with naphthol; that is, to use only a pound of the yarn at a time for treatment. This will require about $1\frac{1}{2}$ gallons of the paranitraniline solution and the same quantity of cold water. Give the yarn a few turns in this solution, wring slightly, give a few more turns, and finally wring well, allowing the excess of liquor to run back into the bath. For

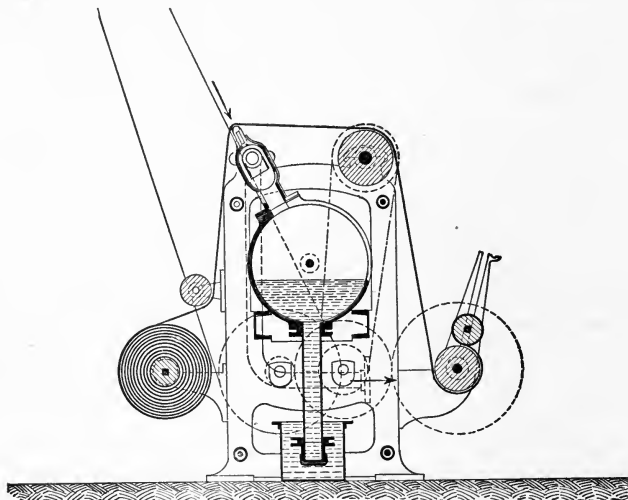

FIG. 173.—Vacuum Hydro-Extractor for Cloth.

100 lbs. of yarn about 16 gallons of the paranitraniline liquor will be required.

After the yarn has been dyed it is important that it should be rinsed as soon as possible, each hank being rinsed as soon as dyed.

The diazotized paranitraniline solution is prepared as follows: 2 lbs. of paranitraniline are stirred to a homogeneous paste in an enameled or wooden vessel with 3 gallons of boiling water. Then add $5\frac{1}{2}$ lbs. of hydrochloric acid (32° Tw.), continue stirring for fifteen minutes, and boil until the solution is clear, which is an important point; then add 10 gallons of cold water. The object of this is to precipitate the paranitraniline rather strongly acid solution. But as the diazo compound does not combine with the naphthol in the presence of strong mineral acids, sufficient sodium acetate is added to the diazo solution to neutralize the free mineral acid.

hydrochloride in a very fine state of division, so it easily diazotizes. To this mixture then add a solution of 1 lb. of sodium nitrite in 2 gallons of cold water. Run this solution in quickly and stir for fifteen minutes.* The solution should contain a slight excess of nitrous acid,† and should therefore develop a blue color with starch-iodide paper. Dilute to 20 gallons and this will form the stock diazo solution from which the developing bath is prepared as required by diluting with six times its volume of water and neutralizing with sodium acetate.‡

* In case the diazo solution does not become clear on adding the nitrite solution, but forms a copious yellow precipitate, it indicates a lack of hydrochloric acid or sodium nitrite. In the diazo solution hydrochloric acid must always be in excess to make the solution more stable, and excess of nitrite is necessary to make up for loss of nitrous fumes and to make it certain that all of the paranitraniline has been diazotized, for if this is not the case the unchanged paranitraniline will couple with the diazotized paranitraniline to form the yellow precipitate referred to.

† Copious evolution of nitrous fumes, however, must be avoided, as this is an indication of improper conditions; the large excess of nitrous acid will form nitrosonaphthol, which will diminish the stability of the diazo solution and tend to dull the color.

‡ Though the diazotization of paranitraniline by means of sodium nitrite and hydrochloric acid is rather simple as a chemical reaction, yet it requires considerable practice in order to obtain a perfectly soluble diazo-compound. In this connection, the following precautions have been recommended:

(1) The paranitraniline should first be stirred up with sufficient acid, allowed to stand for a few minutes, and then gradually brought into solution with hot or boiling water.

(2) The clear, hot solution should then be poured in a thin stream into cold water, while a constant stirring is maintained, in order that the precipitate which forms may be as finely divided as possible, because the finer and more uniform this precipitate, the quicker and more complete will be the action of the sodium nitrite.

(3) The lower the temperature is maintained while adding the sodium nitrite, the clearer and more stable will be the diazo solution. The addition of ice, however, is necessary only on hot days; as a rule, cold water alone is sufficient, it only being necessary not to allow the temperature to rise above 50° F.

(4) The solution of sodium nitrite should be concentrated, and should be run in quickly and with constant stirring; the more rapidly the sodium nitrite is added the clearer will be the diazo solution. The diazotization of the paranitraniline is complete only after all of the nitrite has been added, and the solution has been allowed to stand ten to fifteen minutes. It may be ascertained if free nitrous acid is still present in the bath by testing with a strip of potassium iodide starch paper which would turn bluish black in color. When all of the diazo solution is not to be used immediately but in successive quantities, only those portions in actual use should be neutralized with sodium acetate, as after the addition of this salt the solution is far less stable than in the acid condition.

(5) The hydrochloric acid solution of the diazo-body is unsuitable for developing, because under these conditions the beta-naphthol does not cause any formation of dyestuff. The development only takes place in acetic acid or neutral solution; and excess of acetic acid does not matter, but the slightest quantity of free hydrochloric acid will considerably affect the results. When a mixture of soda ash and sodium acetate is used for neutralizing, their relative quantities should be so adjusted as to leave the solution slightly acid; if sufficient soda ash is used to cause the diazo solution to be neutral or alkaline in a short time it becomes cloudy and the developed shades are poor.

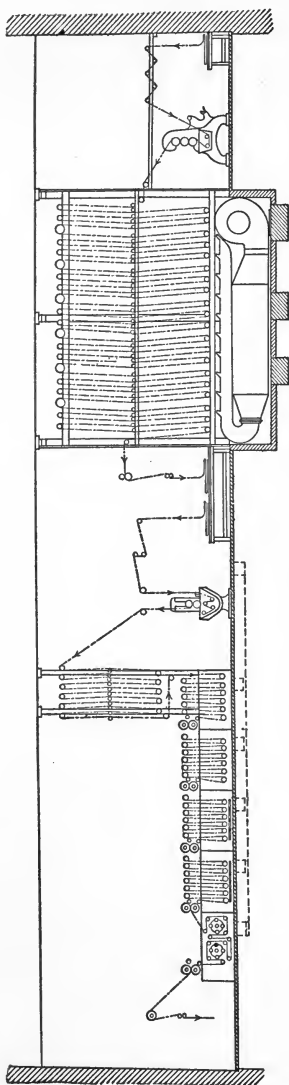

FIG. 174.—Dyeing Cotton Cloth with Para Red.

The dyed yarn is then put through a final process of "brightening," which is done by working the yarn for a short time at 140° F. in a solution of 4 grams of soap per liter. A good olive oil soap should be used, otherwise yellower toned shades may be produced. Bluer but not so bright shades may be obtained by passing the cotton through a further bath containing 18 parts of Turkey-red oil and 2 parts of soda ash per 1000 parts of water.

In order to obtain clear bright shades in the dyeing of Paranitraniline Red it is necessary that all of the chemicals employed should be as pure as possible. Caustic soda lye of a brownish color and containing iron in solution should not be used. It should also be borne in mind that the caustic soda lye decreases in strength when left exposed to the air, as it rapidly absorbs carbonic acid and a portion becomes converted into sodium carbonate.* On this account the naphthol padding solution soon deteriorates. The Turkey-red oil used should be neutral and not acid, otherwise it must be neutralized with caustic soda before use. Lack of uniformity in Paranitraniline Red is often due to the varying quality of the oil employed. Commercial beta-naphthol, as a rule, is sufficiently pure for use in the dyeing

* In developing with diazotized paranitraniline solution hydrochloric acid and caustic soda of the right strength must be used, as free mineral acid prevents the coupling while free caustic soda decomposes the diazo compound.

of Paranitraniline Red; though sometimes small quantities of alpha-naphthol may be present, causing the color to become brownish and dull. If too great an amount of naphthol solution is used for padding, or if the padding solution is too alkaline, the color will be liable to crock and also to possess a yellowish bronzy appearance.

Paranitraniline Red is well adapted for dyeing yarns for fancy woven articles, fustians, and ticking; for articles woven with white which require to be boiled-off and subsequently lightly bleached, such as toweling and shirtings.* The introduction of the vat dyes during recent years, however, has greatly lessened the use of Para Red. This red cannot be used for union goods which have to be cross-dyed in strongly acid baths, or for cottons which require to undergo a strong bleaching, or for goods which must subsequently be treated with copper salts for waterproofing.†

8. Notes Respecting Developing.—In the case of Paranitraniline Red, Meta-nitraniline Orange, Nitrosamine, and the browns, the combination with the naphthol is practically instantaneous, and it is only necessary to pass the material quickly through the diazo solution and wash off immediately; in fact, the process is frequently made continuous. With other developers such as Azophor Red, the naphthylamines, nitrophenetidine, benzidine and tolidine, dianisidine and Azophor Blue, the combination proceeds much more slowly, and to insure complete coupling it is necessary

* The fastness to rubbing of Paranitraniline Red is dependent more or less on the thorough soaping the yarn receives after dyeing, and also upon the uniformity and thoroughness with which the beta-naphthol is fixed, and on the use of a clear, slightly acid diazo solution.

† *Properties of the Developed Colors.*—Many of the azo colors produced by the method given in the foregoing pages withstand the action of light in a satisfactory manner, the reds and browns being the fastest, and the blues and purplish reds the most fugitive. They are also reasonably fast to washing with water or neutral soap, but are rather easily affected by boiling alkalies, and particularly by mineral acids, on which latter account they should not be employed for the dyeing of cotton warps which are to be subsequently cross-dyed with white wool. The colors vary much in their behavior under the action of steaming. Paranitraniline Red becomes duller by even a short steaming, but the red produced by the azophor developer is said to be unaffected. On the other hand, the brown produced by paranitraniline in conjunction with copper is improved by a slight steaming, as are also the claret browns obtained by the use of benzidine and tolidine. The dianisidine and azophor blues become greener and brighter by a short steaming. Many of the azo colors are volatile when subjected to a dry heat, or even volatilize slowly at ordinary temperatures. Thus they are liable to mark off when subjected to hot pressing. The colors are not usually injuriously affected by dilute solutions of bleaching powder or other oxidizing agents, but are readily destroyed by reducing agents, which act as discharges. The reds are particularly sensitive to the action of metallic salts, for instance, copper salts convert the red into a brown. In all operations, therefore, contact with copper or iron should be avoided, the vessels employed being constructed of stone, wood, or preferably, earthenware. The injurious effect of copper salts may, however, be neutralized by the addition of oxalate of ammonia to the developing solution.

to allow the material to remain saturated with the diazo solution for five, ten, or even thirty minutes before washing off. In the three-bath process for blues, the material is passed straight out of the diazo solution into the sodium acetate bath and allowed to remain for fifteen minutes; it being only at this stage, when the acidity of the diazo solution is neutralized, that complete combination occurs.*

The diazo solutions are usually rather stable in the acid condition, and may be kept for a day or two in a dark cool place; but in the presence of copper salts, or when neutralized with sodium acetate or other alkali, they readily decompose. For this reason the addition of the copper salt or of an alkali must only take place immediately before using. The amount of diazo solution in the developing bath should be as small as possible, and the bath should be continuously, or very frequently, replenished with fresh solution.

It is very important that the material should be quickly and regularly impregnated with the developing solution, avoiding any mere capillary distribution of the liquid, which leads to irregularity. The necessity of this is easily recognized if a strip of naphthol-prepared cloth is partially immersed in a diazo solution and allowed to remain at rest for a minute before complete immersion; under which conditions it will be found that that portion of the strip which was at first immediately above the surface of the liquor develops a paler color. This is due to the exhaustion of the diazo solution in immediate contact with the cotton, the liquor devoid of developer then rising by capillarity and diluting the naphthol prepare.

Cotton warps are most conveniently developed by running the yarn continuously through the solution. Hanks may be placed on reels or immersed by hand, taking care in the latter case to hold the hank loosely, so that the solution may have free access. Thin cloth may often be satisfactorily treated by merely running in the open width between a pair of rollers, of which the lower one revolves in the liquor; but thick or closely woven material should be passed several times through the solution, and finally through the squeezing rolls.

* In using meta-phenylene-diamine or meta-toluylene-diamine, in order to prevent the formation of Bismarck Brown (by combination of the developer with itself) it is best to add 25 grams of soda ash per 10 lbs. of cotton. This addition is made to the bath together with the developer. Nerogene D (which is a chlorinated diamine) is used as follows (Berlin):

90 grams Nerogene D are dissolved in
300 cc. water, and add
90 grams hydrochloric acid.

Use this for developing 10 kilos (22 lbs.) of cotton, adding to the bath with the developer

300 grams soda ash.

In the case of slowly developing developers, such as those mentioned in a foregoing paragraph, it will be found advantageous to thicken the diazo solution with flour, starch, or gum, as this greatly adds to the production of level colors. The same course is sometimes adopted for the grounding with naphthol for these developers, since the naphthol is then less liable to dissolve off the material before being rendered insoluble by combination with the developer. When a thickener is required gum tragacanth or wheat flour is the most satisfactory. A thickened grounding may be prepared as follows: Dissolve 250 grams of beta-naphthol in 300 grams of caustic soda (70° Tw.) and 1000 cc. of water. Dissolve also 50 grams of gum tragacanth in 1000 cc. of water. Mix the two solutions and dilute to 10 liters. The thickened diazo solutions may contain from 3 to 5 grams of tragacanth or 5 to 15 grams of flour per liter.

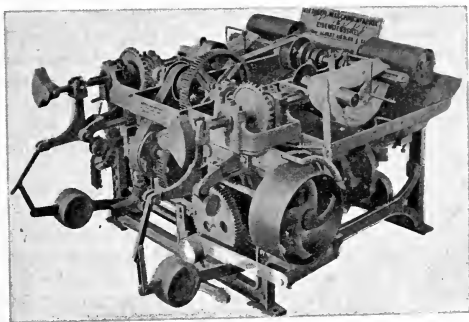

Fig. 175.—Machine for Padding Cotton Yarn. (Zittauer.)

9. Other Naphthol Dyes.—The following naphthol colors may be dyed by the same general process as Para Red. They are used but little for the dyeing of cotton yarn, though sometimes employed for cotton pieces. They have a much more extensive use in calico-printing.*

* Other naphthol colors of minor importance are: *Paranitraniline Brown*, made by boiling Paranitraniline Red in a solution of copper sulphate; it may also be made directly by using an alkaline copper solution in admixture with the naphthol preparation.

Amino-azo-benzene.—This developer produces a somewhat bluer shade of red than beta-naphthylamine, the developing bath being prepared as follows: 14 parts of amino-azo-benzene are treated with 23.6 parts of hydrochloric acid (36° Tw.) and 200 parts of water. Then add 4.6 parts of sodium nitrite in 100 parts of water. Stir for fifteen minutes, filter, and before using add 30 parts of ammonium acetate, and dilute to 1000 parts.

Azo Garnet.—This color is produced by using amino-azo-toluene as the developer, this base being sold as the hydrochloride. Dissolve 26 parts of amino-azo-toluene salt in 200 parts of water, and add 23.6 parts of hydrochloric acid (36° Tw.) and a solution

Dianisidine Blue is prepared from a beta-naphthol ground coupled with diazotized dianisidine.* This, however, gives only a dull violet color, but when treated with copper compounds a beautiful fast blue is obtained. While this color is fast to washing and light, † it is unfortunately very sensitive to acids and perspiration. Attempts have been made to improve it in this respect by the use of beta-oxynaphthoic acid, F-acid, or dioxynaphthalene as an addition to the naphthol solution. A special naphthol preparation containing these mixtures is marketed as Naphthol D. Diazotized dianisidine in a stable form is also put on the market under the name of Azophor Blue D.

Alpha-naphthylamine Claret is beta-naphthol combined with diazotized alpha-naphthylamine; ‡ it gives a rather bright bluish shade of

of 4.6 parts of sodium nitrite in 100 parts of water. Stir for fifteen minutes, filter, and add 30 parts of ammonium acetate, and dilute to 100 parts.

Azo Maroon.—Benzidine (diamino-diphenyl) and tolidine (its dimethyl compound) produce in conjunction with beta-naphthol maroon shades of a very similar character. The padding is done in the usual manner and the developing bath is prepared as follows: 18 parts of benzidine (or 21 parts of tolidine) are dissolved in 63 parts of hydrochloric acid (36° Tw.) and 300 parts of water; then 15 parts of sodium nitrite in 100 parts of water are run in; stir for fifteen minutes, filter, and add 40 grams of sodium acetate, and dilute to 1000 parts.

Nitro-ortho-toluidine produces a bright reddish orange color on a beta-naphthol prepare, while *meta-nitraniline* gives a yellower shade. The padding solution is prepared in the same manner as for reds, and the developing baths in the following manner: 15 parts of ortho-nitro-toluidine or 14 parts of meta-nitraniline are dissolved in 26 parts of hydrochloric acid (36° Tw.) and 200 parts of water. Then diazotize by adding 4.6 parts of sodium nitrite in 100 parts of water. Stir fifteen minutes, filter, and add 30 parts of sodium acetate, and dilute to 1000 parts.

Azo Black Base O is a patented product which on a beta-naphthol prepare produces a purplish black. Mixed with the necessary quantity of sodium nitrite it is sold as Azo Black Base ON. It is more adapted for printing than for dyeing purposes. The naphthol prepare is made with 30 grams of beta-naphthol, 75 grams of caustic soda (36° Tw.) and 1 liter of water. The developing bath is prepared with 53 grams of Azo Black Base, 130 grams of hydrochloric acid (36° Tw.), 32 grams of sodium nitrite, and 900 cc. of water. Stir twenty minutes, strain, and before using add 30 grams of sodium acetate. If required for printing, the solution, of course, must be suitably thickened.

* The dianisidine is prepared as follows: 3 parts of dianisidine salt in 10 parts of water are well mixed with 5 parts of hydrochloric acid in 10 parts of water; add 2 parts of sodium nitrite in 10 parts of water and 2 parts of copper chloride of 77° Tw. Dilute with water to 250 parts and neutralize with sodium acetate.

† Dianisidine Blue is faster to light on cotton than Indigo; it would doubtless be much more extensively used than it is if it were not for the fact that it lacks fastness to acids and perspiration.

‡ The diazo solution of alpha-naphthylamine may be prepared as follows: 143 grams of alpha-naphthylamine are melted in 2 liters of hot water, then add 200 grams of hydrochloric acid (28° Tw.) and heat on the water bath until all is dissolved. Next add 190 grams of hydrochloric acid and stir until quite cold. A paste of the hydrochloride is thus obtained, but all goes into solution again when the nitrite is added. Into the well-

red very fast to acids and washing, but of no great fastness to light. The diazotized naphthylamine solution is very easily decomposed and must be kept cooled to about 40° F. with ice.

Chloranisidine Scarlet is prepared from beta-naphthol and diazotized chloranisidine. The color has good fastness to light, washing, and even a moderate fastness to bleaching with chlorine.

Nitrophenetidine has the composition $C_6H_3(OC_2H_5)NH_2NO_2$, and is sold as Blue Red O. In conjunction with beta-naphthol it gives a bluish red or pink. For a pink shade the beta-naphthol bath is made of $\frac{1}{3}$ to $\frac{1}{10}$ the usual strength, or 2 to 5 grams per liter.*

10. List of the Principal Developed Dyes

Alkali Azo Violet	Diamine Azo Scarlet	Diazethyl Black B, R
Alkali Blue Black	Diamine Beta Blacks	Diazine Black H
Azidine Black BHN	Diamine Blacks BH, BO, RO	Diazo Blacks (all brands)
Azidine Direct Blacks	Diamine Blue 2B, BH	Diazo Blues
Azidine Fast Red	Diamine Blue Black	Diazo Blue Black
Azidine Green 2G, 2B	Diamine Bronze	Diazo Bordeaux
Azidine Violet	Diamine Brown M, S, V	Diazo Brilliant Black
Azo Mauve	Diamine Cutch	Diazo Brilliant Orange
Benamine Brown M	Diamine Heliotrope	Diazo Brilliant Scarlet
Benzo Azurine 3R	Diamine Jet Black SS	Diazo Brown
Benzo Fast Black	Diamineral Blue	Diazo Dark Blue
Chlorazol Browns	Diaminogenes	Diazo Fast Black
Chlorazol Fast Yellow	Diaminogene Blues	Diazo Fast Bordeaux BL
Columbia Brown	Diaminogene extra	Diazo Fast Red 7BL
Cotton Black RW	Diaminogene Sky Blues	Diazo Fast Violet
Cotton Brown AN	Dianil Black ES	Diazo Geranine B
Cotton Fast Reds	Dianil Brown	Diazo Indigo Blue
Cupranil Browns	Dianil Dark Blue	Diazo Navy Blue
Diamine Azo Black	Dianol Blue BH	Diazo Olive G
Diamine Azo Blue	Dianol Diazo Blacks	Diazo Rubine
Diamine Azo Bordeaux	Dianol Steel Blue	Diazo Sky Blue

cooled liquor pour 550 cc. of nitrite solution (150 grams of sodium nitrite per liter), introducing it below the surface and stir well. The temperature should not rise above 30° F. After standing for fifteen minutes filter and dilute to 10 liters. Shortly before using add 300 grams of sodium acetate. Alpha-naphthylamine Salt S is the sulphate of alpha-naphthylamine and is a convenient form for use; for diazotizing use 192 grams with 100 grams of concentrated sulphuric acid and 520 cc. of nitrite solution. Care must be taken to avoid the use of impure alpha-naphthylamine, as this will produce spotted dyeings. Beta-naphthylamine may be used in the same way; it gives a bluer and duller shade of red than paranitraniline.

* The developing bath is prepared as follows: Dissolve 14.5 parts of nitrophenetidine in 9.5 parts of hydrochloric acid (36° Tw.) and 200 parts of water. Then run in 1.5 parts of sodium nitrite dissolved in 50 parts of water. Stir for fifteen minutes, strain, and just before using add 5 parts of sodium acetate. Stir till dissolved and dilute to 1000 parts. The development is not completed by a single passage through the solution and the material should be allowed to remain saturated with the developing solution for fifteen minutes. Then wash well and soap.

Diazogen Black	Melantherine	Renol Blue B
Diazogen Bordeaux	Naphthamine Blacks	Renol Brown MB
Diazogen Brown	Naphthamine Blue BE	Renol Violet
Diazogen Corinth	Naphthamine Browns	Renolamine Blacks
Diazogen Reds	Naphthamine Fast Blacks	Rosolamine Red
Diazogen Scarlet	Naphthamine Greens	Rosanthrene
Diazogen Violet 5R	Naphthogene Blues	Rosanthrene Bordeaux
Diazurine B	Neropaline	Rosanthrene Violet 5R
Diazyl Black	Niagara Fast Black M	Sulphines
Direct Black BH	Osfamine Black	Thiochromogene
Direct Brown	Osfanil Blacks	Titan Fast Blacks
Direct Dark Brown	Oxamine Black A	Titan Orange
Direct Deep Blacks	Oxamine Blue BG	Toluylene Blue Black
Direct Fast Brown	Oxamine Blue 3R	Toluylene Brown G
Direct Indigo Blues	Oxamine Brown B, R	Triazol Blacks
Direct Indone Blue	Oxamine Violet	Triazol Dark Blues
Fast Cotton Reds	Oxy Diaminogenes	Yellow PR
Hessian Bordeaux	Paramine Navy Blue	Zambesi Blacks
Indigene Blacks	Pluto Black L	Zambesi Blue
Indigene Blues	Pluto Brown	Zambesi Browns
Indigo Blue B	Polychromine A and B	Zambesi Gray
Ingrain Blacks	Primuline (all brands)	Zambesi Indigo Blue
Melanogen Blue BH	Renol Black SF	

**11. List of Dyestuffs Suitable for Shading Developed Colors
(or unaffected by diazotizing)**

Aurophenine O	Diamine Fast Yellow	Dianil Claret Red G, B
Columbia Yellow	Diamine Green B, G	Dianil Direct Yellow
Curcumine S	Diamine New Blue R	Dianil Fast Brown B
Diamine Black HW	Diamine Orange B, G	Dianil Orange G, F
Diamine Blue 3R	Diamine Steel Blue	Dianil Red, R, 4B, 10B
Diamine Bordeaux S	Diamine Violet N	Dianil Yellows
Diamine Fast Black F	Diamineral Blue R	Oxydiamine Violet B, R, G
Diamine Fast Blue	Diamineral Brown G	Oxydianil Yellow O
Diamine Fast Red F	Dianil Blues	Thioflavine S
Diamine Fast Scarlet		

12. List of Dyestuffs Suitable for the Coupling Process

Benzamine Browns	Congo Browns	Diamine Gray G
Benzo Brown G	Cotton Black	Diamine Jet Black
Benzo Nitrol Black	Cotton Brown AN	Diamine Nitrazol Black B
Benzo Nitrol Bordeaux	Cotton Yellows	Diamine Nitrazol Bordeaux
Benzo Nitrol Browns	Cotton Yellow G	Diamine Nitrazol Browns
Chicago Blue, B, R	Diamine Bengal Blue	Diamine Nitrazol Green G
Chlorazol Browns	Diamine Bengal Blue G	Diamine Nitrazol Orange
Chlorazol Dark Navy	Diamine Black B, BR, R	Diamine Nitrazol Scarlet
Chlorazol Green	Diamine Blue NC, 3B	Diaminogene
Chlorazol Red	Diamine Bronze G	Dianil Blacks, CR, R, N, PR
Chlorazol Violets	Diamine Brown MR, S, B,	Dianil Blue
Chrysamine	M	Dianil Brown B, D, 3GO, 2G
Columbia Black R, BB	Diamine Cutch	Dianil Orange
Columbia Fast Blacks	Diamine Fast Yellow A	Dianol Blacks

Dianol Coupling Greens	Oxydiamine Blacks	Paranil Yellow
Diazo Brown G, R	Oxydiamine Brown G	Pluto Brown R, GG
Diazogen Orange	Oxydiamine Carbon	Pluto Orange G
Direct Blue Black	Oxydiamine Orange	Polychromine
Direct Deep Black E, RW	Para Blues	Primuline
Direct Fast Brown B	Para Bronze	Pyramine Orange 3G
Direct Orange	Para Brown	Renol Blacks
Naphthamine Black	Para Diamine Blacks	Renol Brown R, PR
Naphthamine Blue BE	Para Fast Green	Renol Orange
Nitramine Browns	Para Garnet G	Renol Orange R
Nitranil Browns	Para Green	Renolazine Green
Osfanil Blacks	Para Olive G	Sultan Orange
Oxamine Blue BG	Para Orange	Toluylene Brown G, R
Oxamine Brown, 3G, B, R	Para Scarlet G	Toluylene Orange G, R
Oxamine Maroon	Para Yellow	Triazol Blacks
Oxamine Red	Paranil Bordeaux	Thiazol Yellows
Oxamine Violet	Paranil Browns	

13. Experimental Exp. 123. General Method of Applying Developed Dyes.—Certain of the substantive dyes may be applied to cotton and then changed by chemical treatment into other dyestuffs which may be of a totally different color, and are frequently much faster or deeper in shade than the original color from which they have been derived. In other words, the dyestuff is built up within the fiber itself just as ordinary dyestuffs are formed without reference to the fiber. This class of substantive dyes is known as the "developed" or "diazotized" colors, from the chemical processes through which they pass. These dyes form a rather important class of colors, the value and adaptability of which are constantly growing. Primuline was the first of these dyes discovered, and is still the most important one in use and may be taken as the type of the entire class. Dye a test skein of cotton yarn in a bath containing 6 per cent of Primuline, 20 per cent of salt, and 1 per cent of soda ash; enter at 140° F., gradually raise to the boil and dye at that temperature for one-half hour. It will be noticed that this is simply the general method for applying substantive dyes, and that the color obtained is yellow. Rinse the skein in fresh water and pass into a cold bath containing 5 per cent of sodium nitrite and 6 per cent of sulphuric acid; work for about ten minutes. It will be noted that the yellow color of the dye is altered to a brownish yellow by this treatment, and if the odor of the bath is observed the presence of nitrous acid will be noted. Rinse the skein with cold water, and immediately pass into a third bath containing 2 per cent of beta-naphthol solution; work cold for fifteen minutes, then wash well and dry. When placed in the third bath it will be noticed that the skein turns a bright red color, which is due to the new dyestuff which has thus been formed within the fiber. In the first bath the Primuline acts merely as a substantive dye, and gives a yellow color which possesses no fastness and is unimportant.* The second solution is termed the "diazotizing" bath. The action of the sodium nitrite on the sulphuric acid

* The final intensity of the color obtained with Primuline will depend entirely upon the amount of dyestuff fixed on the fiber in the first bath; hence in order to obtain uniform shades on successive lots of dyed goods, it is necessary to always use definite amounts of dyestuff. With 6 per cent of Primuline in the starting bath a full shade of Primuline Red will be obtained; for a standing bath about 3 per cent of Primuline will be required, but no further addition of salt or soda need be made. The primrose yellow shade of Primuline dyed direct is fast to alkali, but is turned orange by acid, and is also fugitive to light.

is to liberate nitrous acid and form sodium sulphate; the nitrous acid acts on the dye-stuff in such a manner that the amino groups (NH_2) present are changed into what are known as "diazo" groups, $\text{N}:\text{N}$. This diazo group combines with the sulphuric acid present in the bath and forms primuline-diazo-sulphate. The diazo body is very unstable, hence the bath must be employed cold, and the cotton must be passed from this bath as soon as possible into the third bath, for if the diazotized material is allowed to stand for any length of time, especially if exposed to strong light, the diazo body will decompose and the eventual color will be spoiled. The diazotizing bath should smell distinctly of nitrous acid, and if such is not the case, more sodium nitrite and acid should be added. Care should be taken that this bath does not become heated by leaky steam-pipes, etc. Sometimes, in fact, ice is added to this bath for the purpose of keeping the temperature down (hence these colors are sometimes spoken of as "ice colors"); but if the bath is kept at the ordinary temperature of water (about 60 to 70° F.) no artificial cooling is necessary. The third bath is termed the "developing" bath, and the beta-naphthol (or other like body) is spoken of as the "developer." Its function is to combine with the unstable diazo body to give the new and permanent coloring

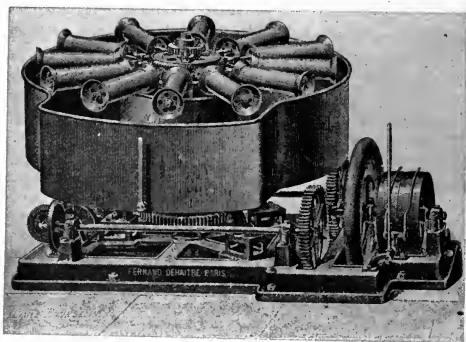

Fig. 176.—Yarn Washer. (Dehaitre.)

matter. This bath should also be cold, otherwise the diazo body on first entering the bath will be decomposed before it has had a chance to become fixed by the developer. Beta-naphthol is not very soluble in water (especially cold water), hence, before adding it to the bath it is advisable to dissolve it in a little hot water together with its weight of soda ash, or caustic soda, and add this solution to the developing bath.

Exp. 124. Showing the Action of Heat on the Diazo Body.—Dye a skein of cotton yarn as before with 6 per cent of Primuline; rinse and diazotize in a bath containing 5 per cent of sodium nitrite and 6 per cent of sulphuric acid; work for ten minutes at a temperature of 180° F., then rinse, and pass into the developing bath prepared as above described; work cold for ten minutes, then wash and dry. Compare the color obtained on the skein with that on the one in the previous experiment. Dye another skein of cotton yarn with 6 per cent of Primuline as before, and diazotize cold as in the previous experiment. Then wash the skein in hot water for ten minutes, and afterwards develop as already described in the beta-naphthol bath cold for ten minutes. Notice the influence of the hot washing on the eventual color. Dye another skein with 6 per cent of

Primuline as before; diazotize cold, and expose to the air for several hours; then develop as usual in the beta-naphthol bath cold for ten minutes. Notice the influence of the long exposure on the color.

Exp. 125. Developed Black on Cotton.—Although there are several black dyes among the substantive colors, yet they do not yield very satisfactory colors either as regards depth of tone or fastness to bleeding when dyed directly. Some of these may be diazotized and developed, however, and so produce black colors of great beauty and fastness. Dye a skein of cotton yarn in a bath containing 6 per cent of Diamine Black BH,* 20 per cent of common salt, and 1 per cent of soda ash; enter at 140° F., gradually raise to the boil, and dye at that temperature for one-half hour; rinse, and diazotize as usual, and then develop with 2 per cent of phenylene-diamine salt in same manner as employed for beta-naphthol; wash well and dry. Phenylene-diamine salt is best dissolved previously to its addition to the bath with a little soda ash. Test the black thus obtained for fastness to washing and cross-dyeing. Also preserve a sample of the color before diazotization and compare it in tone of color with the developed dyeing; also test the fastness of the direct dyeing to washing and cross-dyeing, and compare these results with those of the developed dyeing.

Exp. 126. Developed Brown on Cotton.—Dye a test skein of cotton in the usual manner with 3 per cent of Diamine Cutch, 20 per cent of Glaubersalt, and 1 per cent of soda ash. Rinse, diazotize, and develop for fifteen minutes in a bath containing 4 grams of soda ash per liter of water at 120° F. The direct color obtained with this dye has no value, but the diazotized color developed in this manner with soda ash gives a fine cutch brown shade very fast to washing and acids, of moderate fastness to light and fairly fast even to chlorine. This dye is a derivative of naphthylene-diamine coupled with alpha-naphthylamine. The treatment with soda ash converts the alpha-naphthylamine into alpha-naphthol, and thus forms a new dyestuff.

Exp. 127. Developed Blue on Cotton.—Dye a test skein of cotton in the usual manner with 3 per cent of Diaminogene Blue BB, 20 per cent of Glaubersalt and 1 per cent of soda ash. Diazotize and develop with beta-naphthol. The blue so obtained is quite fast to washing and acids. Dark navy blue shades may be obtained by using Diamine Azo Blue R, diazotizing and developing with Naphthylamine Ether N.

Exp. 128. Shading of Developed Dyeings with Other Substantive Dyes.—As a number of the substantive dyes are not appreciably changed on being subjected to the diazotizing and developing processes, they may be employed for the purpose of shading off the usual developed colors. Dye a skein of cotton yarn in the usual manner with 1 per cent of Zambesi Pure Blue 4B and 1 per cent of Dianil Yellow 3G. Diazotize and develop as usual with beta-naphthol. As the yellow remains unaffected by the process a green color will be the result. By using suitable combinations in this manner a large number of varied shades may be obtained among the developed dyes.

Exp. 129. After-treatment of a Developed Dye with Bluestone.—This process is for the purpose of making the colors faster to light. As already stated, the fastness of the developed colors to light is, as a rule, no greater than that of the original dyeing. All of the developed colors, however, are not susceptible to this treatment, either because their fastness is in no wise enhanced or because their shade is destroyed by the action of

*This dye (Schultz 333) is the principal one employed for the production of developed blacks. It is known under a wide variety of names, depending on the maker, as Dianil Black ES, Naphthamine Black CE, Renolamine Black BH, Azidine Black BH, Direct Black HB, Diazo Black BH, Diazine Black H, Oxamine Black BHN, etc. It gives a very fine deep shade of black fast to washing and acids. When developed with beta-naphthol it gives a bluish black, while with Naphthylamine Ether N a navy blue shade is obtained.

the metallic salt. In some cases, however, and especially with a number of the blue dyes, the after-treatment has the effect of greatly increasing the fastness without materially injuring the shade. Generally the process is carried out in the same manner as with the substantive dyes, using a second bath containing a solution of bluestone together with a small amount of acetic acid. In a few instances, however, the bluestone may be added directly to the diazotizing bath, and the diazotization and development carried out as usual: (a) Dye a test skein of cotton in the usual manner with 2 per cent of Benzo Azurine G; rinse, diazotize and develop with beta-naphthol. Rinse and treat for twenty minutes in a boiling bath containing 2 per cent of bluestone and 1 per cent of acetic acid. (b) Dye two test skeins of cotton in the usual manner with 6 per cent of Zambesi Black BR; rinse and diazotize the one with the addition of 5 per cent of bluestone to the bath, and the other without the addition of the bluestone. Develop both skeins with meta-toluylene-diamine. Compare the two skeins thus dyed for color and fastness to light and washing. When the latter method of after-treatment is used the fastness to washing is not increased in the same degree as when the after-treatment takes place in a separate bath. Both methods, however, appear to give equal increase in the fastness to light.

Exp. 130. Dyeing by the Coupling Process.—In this process of dyeing the dyestuff as first applied to the fiber is not diazotized but acts in the rôle of a developer towards a diazotized base with which the dyed material is subsequently treated. The base employed for coupling with the dyestuff is paranitraniline; a few other bases of like nature may also be used, but they are of minor importance. The general process in this method of dyeing is to apply the substantive color in the usual manner, rinse, and then work for half an hour in a cold solution of the diazotized base. There are a number of substantive dyes suitable for the coupling process, yielding mostly black, blue, brown, and yellow shades. The colors obtained are characterized by the same fastness to washing and acids as those produced by the usual diazotizing and developing process. Dye a skein of cotton in the usual manner with 2 per cent of Benzo Nitrol Brown G. Rinse and treat with 45 cc. of diazotized paranitraniline solution, $\frac{1}{2}$ per cent of soda ash and $\frac{1}{4}$ per cent of sodium acetate. Work cold for one-half hour, then rinse and dry. The diazotized paranitraniline solution is prepared as follows: 20 grams paranitraniline are dissolved in 200 cc. of boiling distilled water; stir well and add 50 cc. of hydrochloric acid; stir, and after complete solution add 425 cc. of cold water. This will cause the precipitation of paranitraniline hydrochloride in the form of a yellow paste. When the paste is quite cold add 15 grams of sodium nitrite dissolved in 70 cc. of cold water. Stir well and in about twenty minutes a clear solution should result. This is diluted with cold water to 2500 cc. Keep this diazo solution in an earthenware or wooden vessel well protected from light and heat, under which conditions it may be preserved for some days without material decomposition. The alkali and sodium acetate are added to the coupling bath for the purpose of neutralizing the acid present. The brown color obtained in this manner is very fast to washing and even fulling; it will also stand cross-dyeing, though the fastness to light is not particularly good. The coupling process, as a rule, greatly intensifies the shade. In the dyeing of coupled blacks there is no advantage to be gained over the blacks produced by the usual method of diazotizing, and as the latter process is more readily carried out it is to be preferred.

Exp. 131. Dyeing Primuline on Silk.—Some of the developed dyes are very suitable for the dyeing of fast colors on silk. Dye a skein of silk in a bath containing 10 per cent of Glaubersalt and 10 per cent of Primuline; enter at 140° F., and gradually bring to the boil and dye at that temperature for one-half hour; rinse, and diazotize and develop with beta-naphthol as already described in the foregoing experiments. This should give a good heavy red which is fast to washing and water.

Exp. 132. Dyeing a Developed Black on Silk.—Dye a skein of silk yarn in a bath containing 10 per cent of glaubersalt and 10 per cent of Zambesi Black D * in the usual manner; diazotize and develop with 3 per cent of toluylene-diamine. Wash well and dry. Test this color for fastness to washing and water.

* A product known as Nerogene D is also recommended as a developer for this dye. This developer should first be dissolved in water acidulated with hydrochloric acid, and, after adding to the bath, should be neutralized with soda ash.

CHAPTER XVI

APPLICATION OF MORDANT DYES

1. **The Mordant Dyes.**—As already explained in studying the general properties of dyestuffs, the mordant dyes refer to those colors which require the aid of a metallic mordant in order to furnish a satisfactory dyeing on the fiber. In former years the only distinction between mordant dyes and those which could be dyed directly was to call the former "adjective" dyes and the latter "substantive" dyes. Hummel drew the distinction by calling the direct dyeing colors "monogenetic," and the mordant colors "polygenetic"; but these rather cumbersome names have practically passed out of the parlance of tinctorial chemistry. In the early development of the coal-tar dyes, the class of mordant colors practically included only the true alizarines (derivatives of anthracene) and most of the natural wood dyes. At the present time, however, the mordant dyes are to be found in a rather wide variety of groups, and the name includes many dyes other than those of the true alizarines. The latter dyes will not dye wool at all without a mordant, whereas there are many mordant dyes now which though they do not give a satisfactorily fast color without the aid of a mordant, nevertheless will dye wool without a mordant.*

* Whittaker (*Dyeing with Coal-Tar Dyestuffs*) gives the following classification of mordant dyes:

<i>Class.</i>	<i>Example.</i>
Anthracene dyes	Alizarine
Monoazo dyes	Mordant Yellow O
Disazo dyes	Diamond Black F
Oxazine dyes	Gallocyanine
Triphenylmethane dyes	Chrome Violet
Nitroso dyes	Gambine
Oxyquinone dyes	Alizarine Black
Xanthene dyes	Coerulein

It has been the habit of the dye makers to call most any color which may be applied on a mordant an "alizarine" dye, whether derived from anthracene or not. Of late years, however, there has been a tendency to call such colors "chrome" dyes rather than "alizarine," and this is by far a more satisfactory nomenclature. Alizarine Yellow and Anthracene Yellow, for instance, bear no chemical relation to alizarine or anthracene.

The mordant dyes as a class are particularly applied to wool, and give the fastest colors to light and washing. In trade they are to be met with as both pastes and powders—the paste being used in case the dye is rather insoluble in water, and if dried to a powder would be difficult for the dyer to use. This is particularly true in the case of alizarines. The powder dyes of the alizarines are usually in the form of the bisulphite compounds which are much more soluble in water. On heating in the dye-bath the bisulphite compound dissociates and the insoluble alizarine dye is precipitated.

2. The Mordanting of Wool.—In the dyeing of woollen goods where the colors obtained are desired to be very fast, it is nearly always necessary to first mordant the material; that is to say, the wool must be treated with solutions of certain metallic salts previous to the dyeing operation in

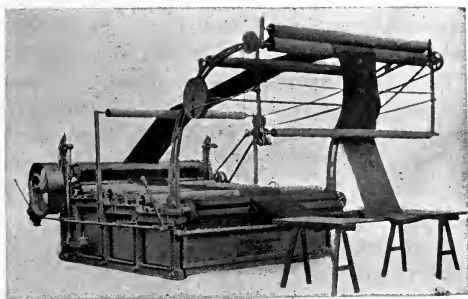

FIG. 177.—Open Width Washer. (Zittauer.)

order to change the chemical properties of the fiber in such a manner that on subsequently dyeing a color-lake or combination with the dye-stuff may be obtained which is permanent in its nature.*

Wool is especially susceptible to the action of solutions of various metallic salts, particularly those whose aqueous solutions are more or less readily dissociated with the formation of insoluble metallic hydrates or oxides. When boiled in a solution of such a salt the substance of the wool fiber apparently brings about a dissociation of the metallic compound in such a manner that the hydrate of the metal is absorbed and firmly combined with the wool itself. Just exactly what takes place in this fixation

* The term "mordant" is derived from the Latin word *mordere*, to bite. According to Hummel this term was introduced into the dyer's vocabulary because the early French dyers considered that the utility of these metallic salts used as mordants consisted in their corrosive action, the general opinion being that they made the textile fibers rough, and thus opened the pores and rendered the fibers more suitable for the entrance and penetration of the coloring matter.

of the metallic compound by the wool fiber is still a matter of considerable discussion, but whatever may be the reason and cause of the reaction, the effect is well understood and the process is very largely employed in dyeing.

A dissociation of the mordanting salts no doubt takes place, induced and augmented both by the dilution and the heating of the solution and the addition of the various assisting agents; and furthermore this dissociation is partly brought about by the presence of the fiber itself in the boiling solution.

While in some cases a difficultly soluble basic salt of the metallic mordant may be absorbed by the fiber, in most cases of mordanting (on wool at least) the material which is precipitated in the fiber (or combined in some physico-chemical form with the substance of the fiber) is a metallic hydrate or oxide. Most of the metals which act best as mordants for wool are those which rather easily form basic salts, resulting eventually in the removal of the acid constituent of the salt, and thus forming the hydrate. In the case of mordant salts capable of forming basic compounds, it must be borne in mind that there are usually several steps possible in the gradation of the basic salts from the neutral salt to the hydrate. Taking aluminium sulphate as an example of this type of salt, we have, for instance:

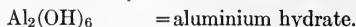
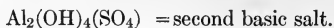
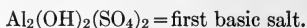

The progressive formation of these basic salts may be considered as a reaction of the salt with water and the withdrawal or elimination of acid, as follows:

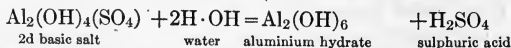
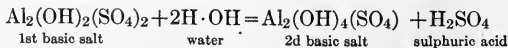
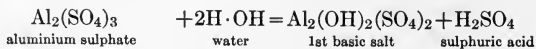

There is perhaps more or less of a chemical reaction between the wool and the mordanting salt, and this question has been gone into with quite some detail by Liechti and Schwitzer (see *Jour. Soc. Dyers & Col.*, 1886, p. 161). It is well known that wool is capable of combining with relatively small amounts of sulphuric acid when boiled in a dilute solution of this acid, and the acid so combined is not removed by subsequent extraction with boiling water. Viewed in this relation the wool may be said to

possess a basic character; but it also possesses an acid character in that it can combine with bases. In applying these principles to the action of a boiling dilute solution of aluminium sulphate on wool we have the following as a suggested explanation of what takes place: in a boiling dilute solution of aluminium sulphate, in the first place, a certain amount of dissociation of the salt occurs, so that there exists already in the solution some free acid and some of the basic salt. The wool combines with this free acid, on the one hand, and with the basic salt (or with the hydrate if the dissociation has gone far enough) on the other hand. The alumina which is thus taken up by the fiber is converted into an insoluble form. Under certain conditions, no doubt, the basic salts themselves are absorbed by the fiber as such; and these apparently undergo further decomposition

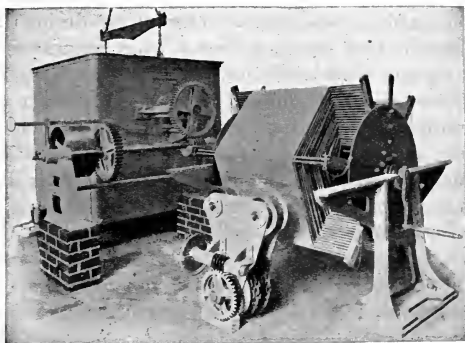

FIG. 178.—Machine for Boiling, Mordanting or Dyeing Cloth in Open Width.
(Zittauer.)

when washed with water, as acid is removed and the compound becomes more basic.

Under these circumstances it would perhaps be thought that the basic salts would be eminently adapted to use as mordants; but it seems that in the case of the aluminium compounds at least, the basic salts too readily dissociate with the formation of fine precipitates, and this precipitation takes place in the mordanting bath before the wool fiber has thoroughly absorbed the salt, with the result that there is a considerable amount of precipitated mordant attached to the outer layers and interstices of the fiber as a superficial deposit which is rather easily removed by washing or rubbing. On this account it will be seen that it is not desirable to employ a salt for mordanting which dissociates too readily, and, in fact, in practice, it is usually found to be necessary to employ some agent which will retard this dissociation so that the substance of the fiber may first become

thoroughly impregnated with the salt before any insoluble compound is formed.

The principal metals, the salts of which are employed for the mordanting of wool are chromium, aluminium, copper, and iron. The first two are the most extensively used and the latter two are of only minor importance in this connection. Tin salts are also sometimes employed in conjunction with certain dyes, such as Cochineal. The chief mordant, however, by far, is sodium (or potassium) bichromate, more commonly known in the dyehouse as "chrome." This is the mordant used for dyeing practically all of the alizarine, mordant, and acid-mordant or after-chromed dyes; it is also the principal mordant used in conjunction with the natural dyewoods.

3. Mordanting with Chrome.—At the present time the salt used for this method of mordanting is sodium bichromate, $\text{Na}_2\text{Cr}_2\text{O}_7$. Formerly potassium bichromate was used almost entirely; but during the recent war potassium salts were very scarce, and even before the war sodium bichromate was coming into vogue as a mordant, as the sodium salt was cheaper than the potassium salt. In former times the potassium salt was preferred owing to the fact that it crystallized nicely and could thus be prepared very pure and free from iron (which is very essential in its use as a mordant for most colors), whereas the sodium salt was difficult to obtain in a crystalline condition, and furthermore it deliquesced on exposure to the air and became pasty and hard to handle. Modern and improved methods of manufacture, however, developed a crystalline form of sodium bichromate in a highly purified state and it rapidly displaced the potassium salt.

When wool is boiled in a solution of sodium bichromate alone the salt is only slightly dissociated. There is, however, a small amount of chromium salt fixed in the fiber, the bichromate apparently being reduced to a certain degree by the substance of the wool fiber itself, with the result that a small proportion of chromium hydrate is formed and taken up by the fiber. To obtain a proper degree of mordanting, however, it is necessary to add some assisting agent to the solution of chrome. These assisting agents may be of various kinds; acids such as sulphuric, hydrochloric, etc., may be used, also various organic substances such as cream of tartar, lactic acid, etc. When sulphuric acid, for example, is added to a solution of sodium bichromate, a corresponding amount of chromic acid is liberated; this is readily taken up by the wool fiber, mostly in the form of the acid chromium oxide, though a small amount of reduced chromium oxide is also present (due to the reducing action of the organic substance of the fiber. This forms what might be called an oxidizing mordant, and is useful in cases where not only the mordanting action of the salt is needed but where an oxidizing effect is also desired, as in the case of dyeing wool with Logwood extract.

Usually, however, an assistant is employed which exerts a reducing action on the sodium bichromate, so that the mordant as eventually

obtained on the fiber consists of the chromium oxide rather than the chromic acid oxide. In this connection it may be well to call attention to the fact that chromium is a metal which is capable of forming two oxides, the one Cr_2O_3 , is known as chromium oxide and forms salts with acids, so that the metal acts as a base. On the other hand, chromium also forms the oxide CrO_3 , known as the oxide of chromic acid because this oxide forms salts with bases (such as sodium and potassium) and, therefore, the metal acts as an acid. Sodium bichromate is a derivative of the acid oxide, and both chromic acid and its salts are yellow in color (at least when in solution). Chrome alum or chromium sulphate, for instance, are salts of chromium oxide, the base, and both the salts and the base are green in color. Generally speaking, when wool is mordanted with chrome it is the green basic chromium compound that is desired as the mordant on the fiber, so it will be seen that it is necessary to reduce the acid chrome to the basic chromium compound. It is spoken of as a reducing action because it is converting a compound derived from a higher oxide (CrO_3) to one derived from a lower oxide (Cr_2O_3). The reduction of salts of chromic acid to those of chromium oxide takes place rather readily in the presence of many organic substances, the latter themselves being oxidized. Certain inorganic reducing agents may be employed also, such as sodium bisulphite (in the Amend mordanting process).^{*} Chrome alum or chromium sulphate may also be used directly, but these do not seem to give as satisfactory a mordanting as when chrome is employed. The chief idea in mordanting is to obtain a maximum amount of chromium oxide (Cr_2O_3) fixed in the fiber for a minimum amount of the salt used in the process; also the absorption of the mordant must be uniform and it must penetrate well throughout the mass of the fiber substance in order that the colors subsequently dyed may be satisfactory.

Practical experience seems to indicate that the most satisfactory assistant for use in mordanting wool with chrome is cream of tartar. Owing to the rather high cost of this material, however, many other materials have been used. Some of these are oxalic acid, lactic acid, lactoline (sodium lactate), lignorosin (a substance obtained from the waste sulphite liquors in the preparation of paper pulp), and many others. Even sodium bisulphate has been used as a tartar substitute, but in this case the effect would be the same as using a corresponding amount of sulphuric acid, and only an oxidizing mordant would be obtained unless some reducing medium was also employed in connection with the bisulphate.

^{*} Amend's process of mordanting is as follows: first mordant the wool for ten minutes with 1 per cent chromic acid; then add 3 per cent sulphuric acid and work for one-half hour cold; add 8 to 10 per cent sodium bisulphite (52° Tw.) and work cold for three-quarters of an hour; run off the liquor and treat in a fresh bath containing 5 per cent soda ash, warming to 130° F. for one-half hour then rinse well. This method is obsolete on account of its complexity.

The selection of the assisting agent will depend somewhat on the nature of the dyeing and the dyestuff to be used.* In the dyeing of dark blue, blacks, and other heavy shades with the alizarines, it is found that lactic acid is quite satisfactory, while with light shades and bright tones the proper effect is only obtained with tartar; although this latter assistant is in general the highest in cost of all those employed.

In the practical application of the mordanting operation it is customary to boil the woolen material (which may be either in the form of yarn or woven cloth) for one and one-half to two hours in the mordant bath which contains the necessary quantity of chrome and the reducing agent

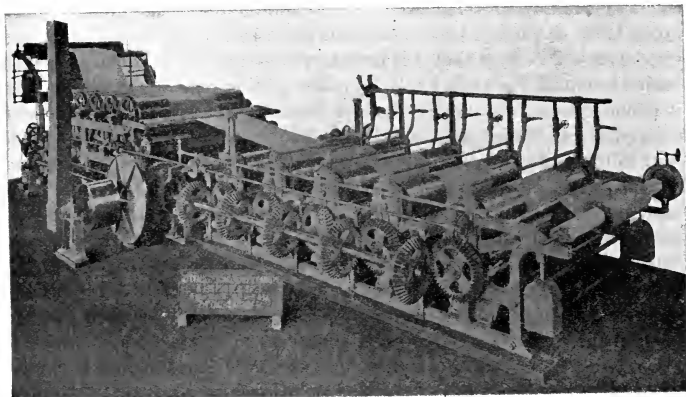

FIG. 179.—Open Width Crabbing and Dyeing Machine. (Zittauer.)

which may have been selected. The color of the mordant liquor at first is golden yellow, but it gradually changes to a greenish tone, and the wool itself also acquires a greenish color. The best results in subsequent dyeing are said to be obtained if the goods after boiling are allowed to remain in the warm bath overnight, and this rule is good for all mordants except that of tin. After coming from the mordant bath the goods should be well washed, and they are then ready for the dyeing operation.

* The exact method of chroming to be adopted can be determined only from a knowledge of the particular dyestuff to be used. For example, Brilliant Alizarine Blue R will give the best result when dyed on a mordant of chrome and oxalic acid; Gallocyanine gives colors much faster to rubbing on a mordant of chrome and tartar than on a mordant of chrome and sulphuric, oxalic, or formic acids. On the other hand, Alizarine Brown M must be dyed on a mordant of chrome and acid, as the shades on chrome and tartar are not fast to fulling.

In mordanting wool with chrome the mordanting bath is not exhausted and may be used again for fresh lots of wool, adding about 2 per cent of chrome and 3 per cent of tartar each time.* After mordanting the wool should be well washed in order to remove the excess of mordanting liquor from the fiber, which coming in contact with the dye liquor would cause a loss of coloring matter by precipitation and also form a loosely adherent surface color-lake on the fiber which would eventually rub off badly and cause the color to smut or crock. It has been demonstrated that about 3 per cent of chrome is the proper amount of mordant to employ for full shades of alizarine colors; for lighter shades less mordant may be used. If larger quantities than 3 per cent are employed, the color is liable to be injured and will not be as heavy or as bright as when only 3 per cent is used. The use of too much chrome also has the effect of oxidizing the wool fiber itself, causing it to become harsh, and with some dyes to take up less coloring matter. In place of using tartar as the assistant in the mordanting process, there may be employed such substances as those mentioned above, and even sulphuric or hydrochloric acids may also be used, and sodium bisulphate (which is sold as "tartar substitute") is frequently employed where cheapness is more desirable than quality.† It is the general opinion, however, that tartar furnishes the best all-round results. Lactic acid employed in connection with sulphuric acid is a very good assistant where heavy shades, such as blues, browns, etc., are to be dyed; it causes a complete reduction and exhaustion of the mordanting bath and only requires the use of about 2 per cent of chrome in place of the usual 3 per cent; it causes the mordanted wool to have a very decided greenish color, however, and on this account does not give as good results as tartar in certain shades. The use of formic acid as a chrome assistant is becoming of some importance.

4. Mordanting with Other Metallic Salts.—In mordanting with alum, the mordant employed is usually potash alum rather than soda alum, as the former is more liable to be free from impurities, and more especially free from traces of iron, which would exert a dulling effect in the subsequent dyeing. Of recent years aluminium sulphate has been prepared commercially in a high degree of purity, and this salt is now being exten-

* The chrome and tartar should be dissolved and added separately to the bath.

† When substitutes for tartar are employed, the following relative proportions may be used:

Sulphuric acid.....	1½ to 2 per cent
Oxalic acid.....	1½ to 2 per cent
Lactoline.....	1½ to 2 per cent
Formic acid.....	2 to 4 per cent
Lactic acid.....	5 per cent
Sulphuric acid.....	1 per cent

sively used for mordant purposes, as its content of active mordanting material is much higher than is the case with alum, as the latter contains a large proportion of water of crystallization, and also contains a considerable amount of inert potassium sulphate. In using either alum or aluminium sulphate the customary and the best assistant to employ is tartar. In this case, however, the tartar does not act as a reducing agent on the mordanting salt, but serves as a means of bringing about a more ready dissociation of the salt so that more of the aluminium hydrate may be taken up by the fiber. It is usual to boil the wool in the mordant bath for

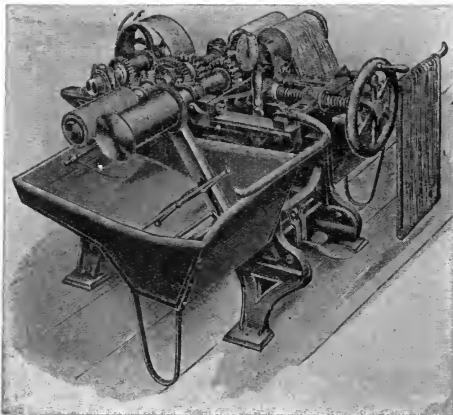

Fig. 180.—Machine for Mordanting Cotton Yarn. (Timmer.)

one and one-half to two hours in a manner similar to that of mordanting with chrome. Apparently if the mordanting takes place without the addition of tartar to the bath, the aluminium compound taken up by the fiber (either in the form of a hydrate or a basic sulphate) is not in a satisfactory condition to form a good color-lake with the dyestuff. Oxalic acid or lactic acid may also be employed in place of tartar and at a more reasonable cost, but the results in dyeing do not, as a rule, appear to be as good. The influence of the tartar in the mordanting with aluminium compounds is perhaps more in the way of affecting the physical condition of the absorbed aluminium hydrate or oxide rather than chemically influencing the reaction, and it is well known in the preparation of color-lakes (irrespective of the fiber) that the physical condition of the base on

which the color is precipitated has much to do with the satisfactory nature of the finished color-lake.

Mordanting wool with iron or tin compounds is seldom done in general practice. For the production of an iron mordant ferrous sulphate (copperas) is generally employed, the wool being boiled in the mordanting bath with the addition of an equal amount of oxalic acid. If tartar is used in this case there will be precipitated in the wool a basic sulphate of iron and the fiber will exhibit a rusty-brown appearance; whereas by the use of oxalic acid no precipitation takes place, and the wool acquires a nice creamy color.

For mordanting with tin it is customary to employ stannous chloride or tin crystals with the addition of tartar, and boiling the wool as usual in the mordant bath for one and one-half to two hours. It is not advisable to allow the wool to steep in the mordant bath, as the fiber is liable to become harsh and tendered.

5. Description of Mordanting Methods.—The following is a brief summary and description of the principal methods employed in mordanting wool in practice.

(a) **Chrome Mordant.**—In this case chrome alone is used without any assistant, and this is perhaps the method of mordanting most commonly employed by dyers. The wool is simply boiled for one to two hours in a bath containing 2 to 4 per cent of chrome. A standing bath may be maintained, being freshened up each time by the addition of about three-fourths of the original amount of chrome.*

(b) **Chrome and Tartar Mordant.**—Use 3 per cent (on the weight of the wool) of chrome as sodium bichromate. This should be well dissolved in the mordant bath, which should be at about 160° F. Enter the wool, which should be well scoured and washed, and bring to the boil for one-half hour. Then add 3 per cent of tartar dissolved in hot water, stir up well and boil for one to one and one-half hours longer. Where hard water is used it is best to add a small amount of acetic acid. In the case of light shades being dyed the quantity of chrome and tartar may be correspondingly diminished. By allowing the goods after boiling to steep for some time in the warm mordant bath the intensity of the mordanting may be somewhat increased.

(c) **Chrome and Formic Acid.**—This acid is being more and more used as a chrome assistant, as it gives very good results, and practically exhausts the bath, and consequently less chrome is required. Prepare the bath with 1 to 2 per cent of chrome and 1 to 2 per cent of formic acid

* It is claimed by dyers, in fact, that old mordanting baths of chrome give better results in dyeing than when fresh baths are used; this is perhaps due to the partial reduction of the chrome and the presence of accumulated colloidal substances which may aid in the mordanting.

(80 per cent). The disadvantage of this method is that the reduction of the chrome takes place too rapidly and uneven mordanting is liable to result which will show up in uneven dyeings. It is best, therefore, to start the bath at 140° F. and gradually bring up to the boil, and then boil for about one and one-half hours.

(d) **Chrome and Sulphuric Acid.**—This method is employed when an oxidizing mordant is desired, especially when dyeing Logwood. The mordant obtained on the wool is of a yellow color, and probably consists of a chromate of chromium which is capable of exerting a rather strong oxidizing action on the dye. Other chrome mordants give a greenish color to the mordanted wool, as the mordant on the fiber consists of chromium hydrate or oxide and retains no oxidizing power. Prepare the bath with 3 per cent of chrome and 1 per cent of sulphuric acid and boil the wool

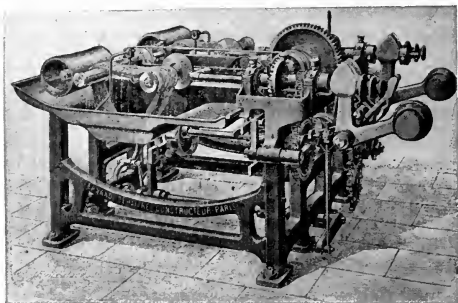

FIG. 181.—Yarn Mordanting Machine. (Dehaitre.)

for one to two hours. After treating with this mordant the wool should not be exposed long to light, as this will cause reduction of the chrome to the green chromium oxide, and may give rise to streaky colors in dyeing.

(e) **Chrome and Lactic Acid Mordant.**—This process is carried out in practically the same manner as the preceding, only in this case 2½ per cent of chrome and 5 per cent of lactic acid are used. The lactic acid which is commercially available is usually of 50 per cent strength, and comes in the form of a liquid. The amount referred to in this process is based on the commercial variety.

(f) **Another Chrome and Lactic Acid Mordant.**—The mordant bath is made up with the required quantity of water, heated to 160° F., and then the following mordant materials are added in their respective order: 2½ per cent of chrome, 1¼ per cent of sulphuric acid (66° Bé.), and 3 per cent of lactic acid; stir up the bath well, enter the wool and work for one-half hour at 160° F., bring up to the boil within half an hour and finally

boil for one hour. Under these conditions the bath becomes almost completely exhausted, and, therefore, may be considered as somewhat of an improvement over the preceding process, and furthermore less lactic acid is required.

(g) **Chrome and Oxalic Acid Mordant.**—Prepare the mordant bath with 3 per cent of chrome and 3 per cent of oxalic acid. Carry out the treatment as in process (a). By the further addition of $\frac{1}{2}$ to 1 per cent of sulphuric acid it is possible to obtain a better exhaustion of the bath. This method of mordanting is somewhat cheaper than the chrome and tartar method, and in certain dyeings gives brighter shades than the latter.

(h) **Chromium Fluoride Mordant.**—In this case the mordant bath is prepared with 4 per cent of chromium fluoride and 1 per cent of oxalic acid, and the wool is treated at the boil for one hour.

(i) **Alum Mordant.**—The mordant bath is made up with 5 per cent of iron-free alum (or 3 per cent of pure aluminium sulphate) and 5 per cent of tartar (or $2\frac{1}{2}$ per cent of oxalic acid). The two salts should first be well dissolved in warm water and then added to the bath, which is heated to a temperature of about 160° F. The wool is then entered, the bath is brought up to the boil within half an hour, and the boiling is continued for an hour longer.

(j) **Iron Mordant.**—The bath is prepared in the following manner: dissolve in the warm bath 5 per cent of oxalic acid; then dissolve in some very soft cold water 5 per cent of ferrous sulphate (copperas). Add this latter solution to the oxalic acid bath with constant stirring, and when the bath has become clear and colorless, introduce the wool, and boil for one and one-half hours. After mordanting the wool should be almost white or only show a creamy color, and in no case should be brown.

(k) **Tin Mordant.**—In the preparation of this bath use the following ingredients: 4 per cent stannous chloride and 5 per cent of tartar; treat the wool for one hour at 190° F., taking care not to bring the bath to the boil. After one hour remove from the bath and wash very well, and under no circumstances leave the wool lying in the bath.

6. Single-bath Methods of Mordanting.—In former days the mordants were nearly always applied in a separate bath from that of the dyeing operation; or, at least, the mordant was applied first, and if the bath was completely exhausted, the same bath could then be employed as the dye-bath. This was especially true in cases of dyeing where the natural dyewoods were employed and where the old-line alizarines were used. The use of two baths was almost essential to obtain a satisfactory dyeing. In later years, however, a number of the coal-tar dyes were found to be of such a nature that the mordant and the dyestuff could be applied in one bath by first dyeing the wool with the coloring matter in an ordinary acid bath (using generally acetic acid, though sometimes sulphuric acid was also

added later to obtain as complete exhaustion as possible) and then adding the mordant (which was nearly always chrome) and boiling the material for about one-half hour longer. This one-bath, or after-chroming, method was of course only applicable to dyestuffs which were capable of being taken up by the wool in a neutral or acid bath. In fact, these dyes (which were generally certain sulphonated alizarine dyes or certain azo acid dyes) really dyed the wool like an acid color, but the dyeing so obtained was not particularly fast. By after-mordanting, however, a true mordant color-lake was produced which had very satisfactory fastness.

In more recent years it was also discovered that certain of these acid mordant dyes could be used in a single bath simultaneously with the mordant if certain precautions were observed in the process. In this case the

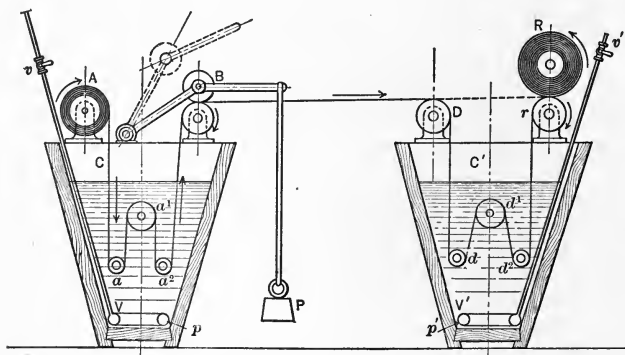

FIG. 182.—Jigger for Oiling, Mordanting and Dyeing Cotton Cloth. (Dehaitre.)

dyestuff solution is added to the bath together with the chrome, also using some ammonium sulphate or acetate and keeping the bath well under the boil for some time. This process was known as the "meta-chrome," "chromate," or "mono-chrome" method, and was very largely used on account of the great saving in handling and time as well the use of less machinery and materials. In this process the dyeing and the mordanting may be said to take place simultaneously, and the mordant is prevented from precipitating the dyestuff as a color-lake in the bath by the presence of the ammonium salt. The dye and the mordant are taken up by the fiber simultaneously, but the color-lake or insoluble dye-mordant compound is only produced when the bath is finally brought to the boil and the ammonium salts are dissociated and driven off.

7. Dyeing with Mordant Colors.—In dyeing wool with the mordant colors it is particularly important that the material be thoroughly scoured

free from greasy substances, and that the soapy residues be very completely removed by rinsing. If this is not done sticky insoluble metallic compounds will be formed with the mordant employed and these will enter into the formation of the color-lakes eventually dyed with the result that the color may appear streaky or spotty and exhibit the bad defect of rubbing. Wool is very largely dyed with the mordant colors in the loose stock for the production of yarns entering into fabrics which are afterwards more or less heavily fullled (or felted), so that these dyes are more used for woolen goods than for worsteds (which require no fulling). It is essential, therefore, that the mordanting and dyeing operations should be so conducted as to injure the fiber to the least extent, otherwise great waste will occur in the carding and spinning operations. Also precautions must be had not to make the fiber harsh or brittle in the mordanting.

As in dyeing with mordant colors it is usually necessary to boil the material in the dyebath rather vigorously and for a long period, it is best to use suitable dyeing machines that require a minimum mechanical treatment of the fibers; it is preferable to circulate the liquors through the fiber, while maintaining the latter at rest in a fixed position.

Calcium acetate is frequently added to the dyebath for the purpose of brightening the color, and it is supposed that a triple color-lake is formed between the chromium, the calcium, and the alizarine. Where the water employed for the dyebath is sufficiently hard (that is, contains sufficient lime salts in solution) the addition of acetic acid in requisite amounts will form the necessary calcium acetate, hence none of this salt need be added under such conditions. For water of 5 to 10° of hardness (one degree of hardness represents 1 part of lime in 100,000 parts of water) 2 parts acetic acid (of 9° Bé.) should be added for each 1000 parts of water in the dyebath; and for water of 10 to 15° hardness 3 parts of acetic acid should be added.* The best and most practical way, perhaps, is to add acetic acid to the dyebath until a test-paper of blue litmus is distinctly reddened. Acetic acid is furthermore added to the dyebath for the purpose of more thoroughly exhausting the coloring matter, but the addition of the acid in this case should not be made until near the end of the dyeing operation, in order to prevent unevenness.

When dyeing piece-goods, hat felts, or such material that is difficult to penetrate, it is advisable not to use acetic acid at the beginning of the dyeing operation, but to add about 3 gallons of ammonium acetate solution per 1000 gallons of dye liquor. After boiling for an hour the acetic acid may be added to further the exhaustion of the dyebath.

The alizarines, as a rule, exhaust quite well and many of them will not require the addition of any acid, especially when light shades are dyed.

* From 1 to 3 gallons of acetic acid (9° Tw.) will be required per 1000 gallons of dye liquor.

The initial temperature of the alizarine dyebath should be quite low (100° F. or even lower), and the elevation of the temperature to the boil should be gradual in order to have the dyeing even and well penetrated.* The color-lake does not develop fully until after boiling for some time, hence it requires a longer time, as a rule, to dye alizarines than it does acid colors on wool.

When dark colors are dyed with the alizarines the fastness to fulling may be materially increased by the addition of about $\frac{1}{2}$ per cent of chrome after dyeing, and continuing the boiling for one-half hour longer.

8. Top-chrome Method.—In this process of dyeing mordant colors the dyestuff is first applied to the fiber and then the mordant is added either in the same bath as the dyestuff or in a separate bath. The method of

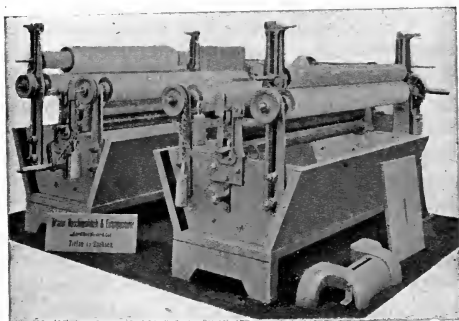

FIG. 183.—Jiggers for Mordanting and Dyeing. (Zittauer.)

simply adding the mordant to the same bath is coming more and more into vogue as this cuts down the handling of the goods and decreases the expense. In using this process, of course, it is necessary to employ dyestuffs that are taken up by the wool from an acid bath with good exhaustion so that when the chrome mordant is added there is little or no dye left in the bath, as otherwise a lake would be precipitated by the chrome combining with the excess of dyestuff. While this method has advantages of simplicity and cost there are difficulties in matching to shade and also the range of dyestuffs that are applicable is somewhat limited. The true alizarine dyes cannot be employed by this method, as a rule, as these will only be taken

* When the soluble powdered alizarines (the bisulphite compounds) are used the temperature of the dyebath should not be raised above 150° F. until practically all of the color has been absorbed, as at higher temperatures the bisulphite compound of the dye splits up and allows the insoluble dyestuff to be precipitated in the liquor. This causes loss of dyestuff and also gives colors which will rub badly.

up by the fiber when a mordant is already present. It is also more difficult to obtain level dyeing with the top-chrome method, especially on yarns and piece-goods. The method, however, is well adapted to the dyeing of loose wool and slubbing where perfect level dyeing is not required, as any lack of uniformity is corrected by the mixing of the fibers in drawing and spinning. The method is also largely used for the dyeing of blacks and blues and heavy shades of brown, where the acid-chrome dyes are used. In the case of loose wool and slubbing the material is left in a better condition for spinning than when the pre-mordanting method is used, and as regards fastness it may be said that in many cases this is even better than by the older process, as the after-mordanting tends more thoroughly to fix the dyestuff and does not leave any excess of unfixed dye to rub or wash off.

In applying this process the dyestuff is first well boiled up with a small amount of water in the dyevat,* then the bath is made up with cold water and 1 to 5 per cent of acetic acid; the goods are entered and the temperature of the bath is gradually raised to the boil and maintained at that temperature for one hour. In case the bath is not completely exhausted about $\frac{1}{2}$ to 1 per cent of sulphuric acid is added and the boiling is continued until the liquor is clear. Then from $\frac{1}{2}$ to 2 per cent (depending on the amount of dyestuff used) of chrome is added, and the boiling continued for one-half hour.† After dyeing the wool should be washed off immediately to prevent change of color due to the prolonged action of the chrome liquor.

In dyeing piece-goods or yarns by this process it is not advisable to add all of the acid at once, but to add it in portions until the bath is exhausted.‡ Where the goods contain white cotton effect-threads it is necessary to use

* To obtain the best results with some of the after-chromed colors it is recommended to correct the water used in the dyebath by the addition of ammonium oxalate. For 100 gallons of dye liquor the following amounts of this salt will be necessary:

For soft water (3 to 7° hardness).....	2 ozs.
Moderately hard water (7 to 10°).....	5 ozs.
Very hard water (10 to 14°).....	6 ozs.

† It is very important that the chrome should not be added until the dyebath is completely exhausted of color, as otherwise a brownish shade will nearly always result (in the dyeing of blacks). The tone of the chrome blacks may be somewhat regulated by the amounts of sulphuric acid and chrome used, smaller amounts giving bluish tones and larger amounts jet shades. In dyeing potting chrome blacks it is best to use 2 to 3 per cent of sulphuric acid and 2 to 3 per cent of chrome.

‡ In cases of some dyes satisfactory evenness of color can only be obtained (especially when dyeing piece-goods) by first boiling the material in the dyebath with addition of acetic acid alone, and then adding the dyestuff solution. When dyeing with Chrome Blue it is recommended to add lactic acid (about 4 per cent) together with the chrome, as this gives increased fastness to fulling. With some dyes, such as Palatine Chrome Black SR, acetic acid only can be used in dyeing.

more sulphuric acid in exhausting the bath in order to prevent bleeding into the cotton.

One of the principal uses of the top-chrome method is in the application of the so-called "chrome blacks" to wool. Very large quantities of these blacks are used in the dyeing of wool for the production of shades that are especially fast to washing, light and fulling, and in many cases to potting.* These blacks are of the general type of Diamond Black, of which there are a number of different brands on the market; they are also known as Chrome Black, Anthracene Chrome Black, Erio Chrome Black, etc. Diamond Black F is a very good example of this class of colors, and it has been very extensively employed on wool to take the place of Logwood, as it is very fast to light and washing, as well as fulling. It is not fast to potting, however, and until rather recently the only blacks that were fast in this respect were Logwood Black and Alizarine Black. Diamond Black PV (the suffix "P" meaning fast to potting), however, will stand the potting test, and on this account is a very important dyestuff. The PV brand is also much more soluble than the others and requires more sulphuric acid and chrome in the dyeing. It is very largely used for the dyeing of carbonized rags, as it gives a well-penetrated color. The chrome blacks do not give satisfactory colors when dyed by the pre-chrome method, nor are the results very good with the meta-chrome process.

9. Mono-chrome or Meta-chrome Method.—In this process of dyeing not only is but one bath employed, but the dyestuff and the chrome mordant are added together, so that the mordanting and the dyeing take place simultaneously. Several years ago this process was used with the aid of a special "meta-chrome" mordant which consisted of a mixture of potassium chromate and ammonium sulphate. At the present time the dyer usually makes up his own meta-chrome mordant. This process is capable of being used with a large number of the mordant dyes, as many of these are not precipitated by a neutral chromate. On the other hand, others like Gallocyanine and the true alizarines cannot be used in this way, as even the neutral chromate will cause precipitation of the color-lake. The theory of the meta-chrome process is that when the dye-bath is made up comparatively cold with the mixture of the dyestuff with chrome and an ammonium salt, there is no formation of the color-lake; when the bath is heated, however, the ammonium salt (which is no doubt

* Potting is a process employed for giving a certain character of finish to woollen cloth. Briefly described it consists of wrapping the goods around a roller and immersing in water for about twenty-four hours, then giggering. These operations are repeated several times until the desired results are obtained. It is necessary that the dyestuff employed shall not bleed into adjacent whites or colors. The potting blacks are also serviceable for heavy fulling of goods having mercerized cotton-effect threads, as the mercerized cotton will become more or less stained by any other blacks.

dissociated in the bath) is decomposed and free ammonia is driven off, leaving acid in the bath. Thus the conditions become such as to cause a precipitation of the color-lake; but at this stage the dyestuff has been practically all absorbed by the fiber, so that the formation of the color-lake takes place only within the fiber. This process has come into large use for the dyeing of all manner of chrome shades on wool in any form of manufacture from the loose stock to the finished cloth. It is more especially adapted perhaps to the dyeing of slubbing and yarns. The dyes, however, must be properly selected with the limitations of the method in view. Dyes for this purpose are called by various names, such as Meta-chrome, Mono-chrome, Chromate Colors, Auto-chrome, etc. This process has a distinct advantage over the other methods of applying mordant dyes in

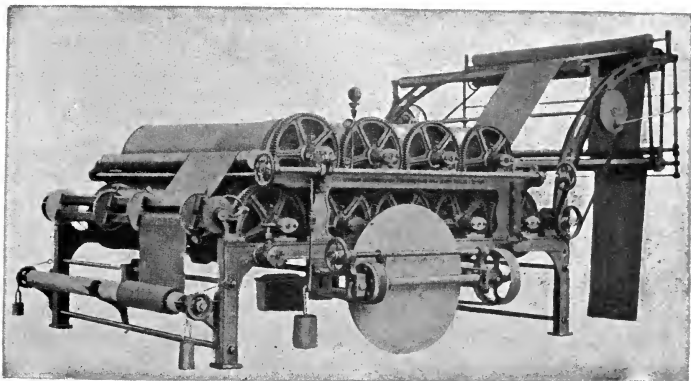

FIG. 184.—Horizontal Drying Cans. (Zittauer.)

that it requires only a single bath, and as the shade develops gradually it is much easier for the dyer to match his colors than with the top-chrome process where the exact color is not known until after the dye has all been absorbed and the chrome is added.

The meta-chrome method may be carried out as follows: First add the color solution to the bath and then a solution containing the required amount of chrome and ammonium sulphate made alkaline with ammonia. In dyeing yarns enter the goods at 140° F., slowly bring up to the boil and dye for one hour. Loose wool or slubbing may be started at higher temperatures. Ammonium acetate may be used in place of the sulphate, but it is doubtful if it gives as good results, while at the same time it is more expensive. Or the chrome may be used alone with ammonia, and acetic acid is added toward the end of the dyeing to make the bath acid. Formic

acid may also be used in the same manner.* The amount of chrome taken is usually half the weight of the color used, though this may vary somewhat according to the dye. For each part of chrome use $2\frac{1}{2}$ parts of ammonium sulphate (or if acids are employed use $2\frac{1}{2}$ parts acetic acid, 1 part of formic acid, 1 part of sulphuric acid, or 4 parts of niter cake). Where small quantities of dyes are used the amount of chrome taken should not be less than 1 per cent.

The dyes which can be used with the meta-chrome process include browns, reds, greens, and yellows. There are as yet no dark blue or black dyes which are suitable for this process. There are also some other dyes than the mordant colors which may be used in the bath for shading and which will stand the action of the chrome. Such dyes, for instance, are Sulphon Cyanine, Indocyanine, and Patent Blue.

10. Dyeing on Various Mordants.—Where very bright colors are desired as with reds, blues, and yellows, chrome cannot be used as the mordant, but alum or stannous chloride may be employed. Alum is used to quite an extent for certain shades, but as the colors obtained on a tin mordant are not as fast and as the tin mordant makes the wool harsh and brittle, it is very little used in practice. In order to obtain as bright and clear colors as possible with the alizarine dyes, it is necessary that the water and the chemicals employed both for mordanting and dyeing should be free from any trace of iron, as the presence of this metal causes a saddening of the color.

Other metallic mordants than chrome may also be employed in the same manner as the top-chroming method. Chromium fluoride, alum, copperas, and bluestone may be employed, and either the single-bath or two-bath method may be used, the first, however, always being preferable wherever possible. After-mordanting with chromium fluoride is chiefly employed for the dyeing of medium to dark blue colors on piece-goods with the use of the Anthracene Blues. The dyebath is prepared with 20 per cent of glauber salt, 4 per cent of oxalic acid and the necessary dyestuff. The dyeing is first run cold for thirty minutes, then brought to the boil for about one hour. The solution of chromium fluoride (2 to 4 per cent) is then added, and the boiling continued for about thirty minutes.

After-mordanting with alum is occasionally carried out in the dyeing of

* Another one-bath dyeing process somewhat resembling the meta-chrome process is one using a mordant of chrome and formic acid in the following manner: The bath is first prepared with $1\frac{1}{2}$ per cent of chrome and 2 per cent of formic acid (80 per cent); run the goods for $1\frac{1}{2}$ hours at 160° F., then add the well-dissolved dyestuff and continue the dyeing for one hour; finally add 2 per cent more of formic acid and gradually bring to the boil. This method depends on the fact that the use of formic acid completely exhausts the chrome before the dye is added and therefore no precipitation of dye takes place in the bath. This process, however, has not proved very popular and no doubt the results are not as satisfactory as by the other method.

bright reds. The acid-chrome or milling reds are used and the dyeing is done as above described, then a solution of 10 per cent of alum in hot water is added, and the dyeing continued at the boil for one-half hour. The oxalic acid is added in these cases of after-mordanting in order to correct the hardness of the water, and where this is considerable the amount of oxalic acid must be correspondingly increased. The presence of copper surfaces should be avoided in the dyebath, either wooden or tinned copper vessels being used. The Alizarine Reds and Oranges may be dyed in this manner.

The after-mordanting with copperas (ferrous sulphate) is principally employed in the case of dyeing black where Logwood is used in connection

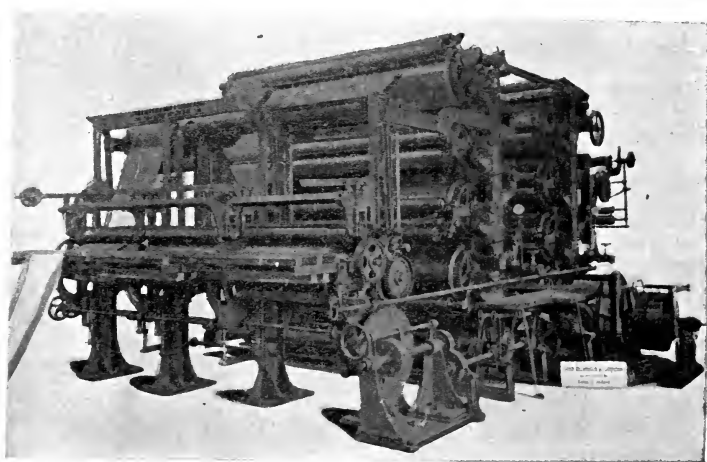

FIG. 185.—Dryer and Foulard.

with a coal-tar mordant dyestuff. Bluestone is usually employed in conjunction with the iron salt. The following is an example of this process: Dye with $2\frac{1}{2}$ per cent of oxalic acid, 3 per cent of Palatine Black 4B and 10 per cent of Logwood extract; after boiling for one hour add 8 per cent of copperas and 2 per cent of bluestone, and continue boiling for one hour. Quite a variety of dyes may be used in this manner for the shading of Logwood Black, such as Fast Blue, Alkali Violet, Acid Violet, and Fast Green SF.

An after-mordanting with bluestone is sometimes given for the purpose of increasing the fastness to light of certain dyes. The dyeing is done in the usual manner and then the bluestone is added to the bath and the boiling is continued for one-half to one hour.

11. Experimental. Exp. 133. General Method of Dyeing Mordant Colors.—The most generally used mordant for wool is chrome or sodium bichromate. It is applied to the fiber in the following manner: Prepare a bath containing 3 per cent of chrome and 4 per cent of tartar; enter a test skein of woolen yarn at 140° F., gradually raise to the boil, and continue at that temperature for one-half hour; wash well, and then dye in a fresh bath containing 2 per cent Alizarine Blue NG and 4 per cent of calcium acetate; enter at 100° F., gradually raise to the boil, and dye at that temperature for one-half hour; then add 2 per cent of acetic acid and boil for fifteen minutes longer; wash well and dry. Sodium (or potassium) bichromate, is a salt of chromic acid (CrO_3), while the mordant which is eventually produced on the fiber is chromium oxide (Cr_2O_3); hence in the process of mordanting the chrome must undergo reduction. This is brought about partly by the wool itself, but chiefly by the aid of the tartar. The latter is potassium

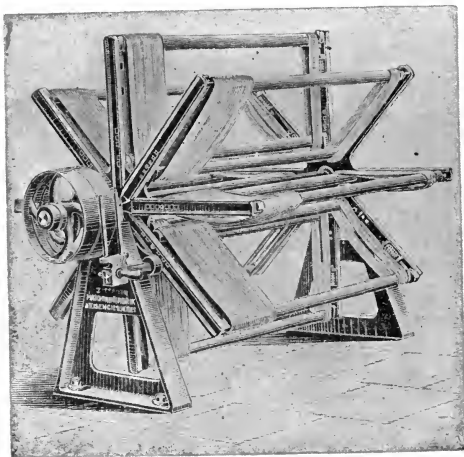

FIG. 186.—Dryer for Mordanted Yarn.

acid tartrate, or potassium bitartrate, and is a reducing agent. When mordanting it will be noticed that the wool is first yellow in color; this is probably due to the formation of chromium chromate in the fiber. If this compound is exposed to the action of strong light it will suffer a rapid reduction to chromium oxide, which is green in color; hence it is best not to expose the mordanted wool unevenly to light for any length of time before dyeing.

Exp. 134. Effect of Iron Salts in the Bath.—Alizarine colors are much affected by the presence of iron salts in either the mordant or the dyebath, the color being considerably dulled through the formation of an iron color-lake with the dyestuff. To show this influence in the mordant bath, mordant a skein of woolen yarn in a bath containing 3 per cent of chrome, 4 per cent of tartar, and a few drops of a solution of copperas. After mordanting dye as usual with 2 per cent of Alizarine Blue NG; wash and dry and compare the color thus obtained with that produced with the same mordant and dyestuff without the addition of the iron salt. Mordant a second skein of woolen yarn in the usual manner with 3 per cent of chrome and 4 per cent of tartar, and dye as

before with 2 per cent of Alizarine Blue NG, but add to the dyebath a few drops of a solution of copperas. Notice the effect of this on the appearance of the color.

Exp. 135. Comparison of Different Mordants on Wool.—Mordant a skein of woolen yarn in a bath containing 3 per cent of chrome and 4 per cent of tartar; enter at 140° F., gradually bring to the boil, and continue at that temperature for one-half hour; wash well and dye in a fresh bath containing 2 per cent of Alizarine Red SW; enter at 100° F., gradually bring to the boil, and dye at that temperature for one-half hour, then wash well and dry.

Mordant a second skein of woolen yarn in a similar manner, but instead of chrome use as the mordant: 10 per cent of alum, 3 per cent of tartar and 2 per cent of oxalic acid. Wash well, and dye with 2 per cent of Alizarine Red SW, adding to the dyebath 2 per cent of calcium acetate, 1 per cent of soap, and $\frac{1}{2}$ per cent of tannic acid, each of these latter ingredients being dissolved separately in water. This mordant is principally used for red, orange, and maroon colors. The presence of copper surfaces in the dyebath should be avoided as this will dull the colors. The harmful influence of the copper, however, may be avoided by the addition of 3 ozs. of ammonium sulphocyanide per 100 gallons of dye liquor.

Mordant a third skein, using 8 per cent of copperas as the mordant with 8 per cent of oxalic acid; wash well and dye with 2 per cent of Alizarine Red SW.

Mordant a fourth skein with 5 per cent of bluestone and 4 per cent of tartar; wash well and dye with 2 per cent of Alizarine Red SW.

Mordant a fifth skein with 4 per cent of stannous chloride and 2 per cent of oxalic acid; wash well and dye with 2 per cent of Alizarine Red SW.

Compare the several colors obtained on the different mordants with the same dye-stuff, and also preserve samples of the original mordanted yarn before dyeing in each case, so as to be able to compare the colors given by the mordants alone. Make a record of the results as follows:

Mordant.	Color of mordanted skein.	Color of dyed skein.
Chromium.....
Aluminium.....
Iron.....
Copper.....
Tin.....

Exp. 136. After-mordanting with Chrome.—This method may be used with quite a number of the mordant colors, and is becoming a favorite process, as only one bath is required. Dye a skein of woolen yarn in a bath containing 2 per cent of Anthracene Yellow C, 2 per cent of sulphuric acid, and 20 per cent of Glaubersalt; enter at 120° F., gradually bring to the boil, and continue at that temperature for one-half hour; then lift the skein and add 3 per cent of chrome, and continue the boiling for fifteen minutes; wash and dry. Preserve a sample of the color before chroming and compare it with the chromed color. Many of the mordant dyes are now prepared in such a manner that they have slight acid properties and are capable of being absorbed by the wool fiber from acid baths; these dyes are chiefly in the powder form, and some are compounds of the alizarine dyes with sodium bisulphite; they are also much more soluble in water than the ordinary alizarines.

Dye a skein of woolen yarn in a bath containing 4 per cent of acetic acid, 2 per cent of Acid Alizarine Green R, and 20 per cent of glaubersalt. Dye in the same manner as before and then add 3 per cent of chrome as above; wash well and dry.

Dye a third skein in a bath containing 2 per cent of sulphuric acid, 4 per cent of Diamond Black F and 20 per cent of glaubersalt; dye as before and after-chrome with 2 per cent of chrome and 1 per cent of sulphuric acid; wash well and dry.

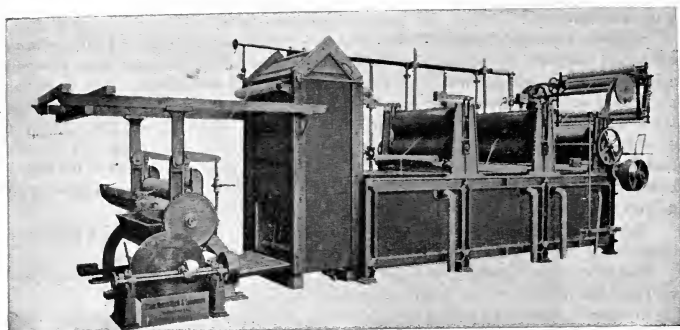

FIG. 187.—Padder, Steamer and Washer for Mordanting Cotton and Dyeing Pieces. (Zittauer.)

Dye a fourth skein with 2 per cent of Diamond Flavine in the same manner and after-chrome; wash and dry. In each case preserve a sample of the skein before chroming in order to observe any change in the color due to the chroming.

Test these colors as to their fastness to washing and acids.

Make a record of the results in the following manner:

Dyestuff.	Effect of chroming.	Washing test.			Acid test.
		Color.	White wool.	White cotton.	
Anthracene Yellow C.....
Acid Alizarine Green R.....
Diamond Black F.....
Diamond Flavine.....

Exp. 137. One-bath Process.—The one-bath after-chroming process may be illustrated as follows:

(a) **Dyeing with an Acid-chrome Color.**—First dye in a bath containing 3 per cent of Alizarine Yellow G and 4 per cent of acetic acid; after dyeing at the boil for one hour, lift the goods and add 2 per cent of chrome and 1 per cent of sulphuric acid previously dissolved in some warm water. Re-enter the goods and boil for one-half hour longer.

This is an example of an azo dyestuff which reacts with wool as an ordinary acid dye, but which is also capable of forming a faster color-lake with the chrome mordant.

(b) **Dyeing with a Chrome Black or Chromotrop Dye.**—First dye in a bath with 6 per cent of Chromotrop 2B, 20 per cent of glaubersalt, and 4 per cent of sulphuric acid; then lift the goods and add 3 per cent of chrome and boil for one-half hour longer. This kind of a dye gives an acid dyeing which is of a purplish red color, but when the chrome mordant is applied the color changes to a full black. In this case the color-lake with the chrome is of an entirely different color from that of the acid dyestuff itself.

Exp. 138. Various One-bath Methods.—The one-bath mordanting and dyeing operation may be understood by a consideration of the following examples:

(a) **Use of Meta-chrome Dye.**—Prepare the dyebath by first adding 2 per cent of chrome and 5 per cent of ammonium acetate, and then add 2 per cent of Meta-chrome

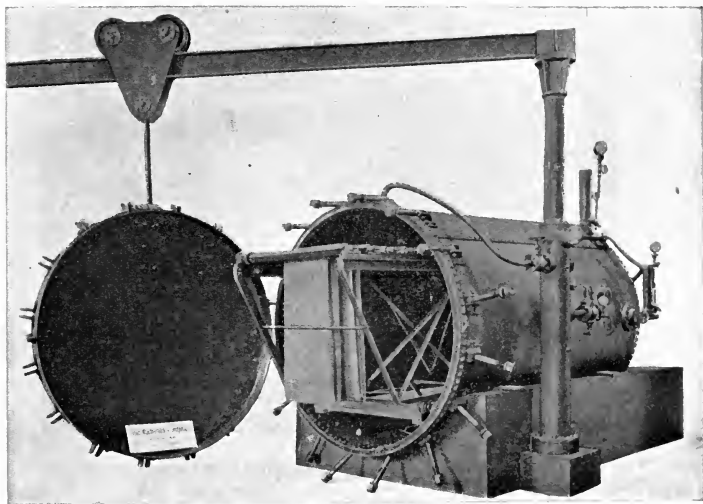

FIG. 188.—Apparatus for Steaming and Fixing Mordanted Cotton.

Brown; enter the wool at 140° F., gradually raise to the boil and maintain at that temperature for three-quarters of an hour.

(b) **Use of Tin Mordant and Cochineal in One Bath.**—Cochineal was formerly very largely used for the production of scarlets on woolen goods, and even at the present time it still is used for this purpose to a considerable degree. For the production of this color a tin mordant is employed in the following manner: Prepare the dyebath with 10 per cent of ground Cochineal, 6 per cent of oxalic acid and 6 per cent of stannous chloride; boil up the bath for about ten minutes, then add sufficient cold water to bring the temperature down to about 150° F. The wool is then entered, the temperature is gradually brought up to the boil and the dyeing continued for one hour. By this single-bath process a scarlet of a brighter and yellower shade is obtained than with the two-bath process where the mordant is first applied and the dyeing takes place in a fresh bath.

(c) **Dyeing Logwood in One Bath.**—This method of dyeing is sometimes practiced for the production of dark blue or black on cheap shoddy goods. The dyebath is prepared with 6 per cent of Logwood extract, 2 per cent of oxalic acid, 2 per cent of tartar, 4 per cent of copperas (ferrous sulphate) and 4 per cent of bluestone (copper sulphate). Bring the bath up to the boil, enter the goods and continue dyeing for one hour.

Exp. 139. Saddening Method of Dyeing.—In former days when dyewoods were used to a much greater extent than they are now, there was a modification of the ordinary process of mordanting known as the "saddening" method. In this process the goods were first mordanted and then dyed as usual, and then mordanted again with another metallic salt chiefly for the purpose of "saddening" or dulling the shade, and also for the purpose of making it faster. The latter effect was probably due to the second

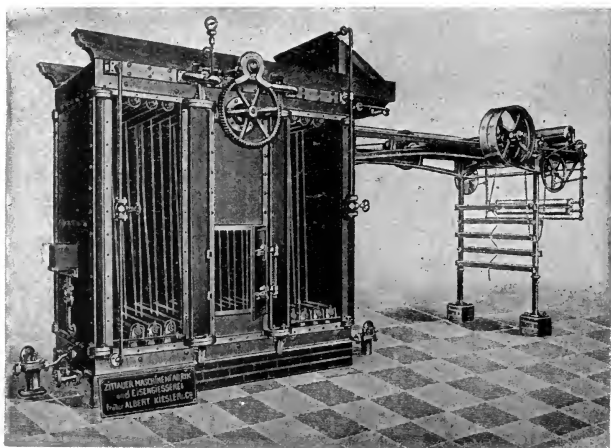

FIG. 189.—Steaming and Ageing Machine. (Dehaitre.)

mordant fixing some of the excess of dyestuff taken up by the fiber and which was not properly combined in the form of a color-lake with the metallic salt used as the first mordant. Sometimes the second mordant was applied in the dyebath after the dyeing was completed, though more generally a third fresh bath was used. An illustration of this method of dyeing is as follows:

(a) **Dyeing a Brown with Alizarine or Madder.**—Mordant in the usual manner with 3 per cent of chrome and 4 per cent of tartar, and then dye in a fresh bath with 20 per cent of ground madder root and 2 per cent of calcium acetate. Then mordant again in a third fresh bath using 2 per cent of copperas and 4 per cent of oxalic acid. In many old dyeing recipes there will often be found a direction to "wash in the river" after dyeing. This was no doubt for the purpose of saddening the color by utilizing the iron and lime present in the river water to act as a secondary mordant.

(b) **Dyeing an Olive Brown with Sandal Wood.**—Prepare the dyebath with 50 per cent of Sandal-wood, 2 per cent of Fustic extract and 1 per cent of oxalic acid; boil the wool in this bath for one and one-half hours, then add 2 per cent of bluestone and

boil for fifteen minutes longer, and next add 3 per cent of copperas and continue boiling for another fifteen minutes. A slight addition of soda will also improve the appearance of the color and further darken the shade.

12. Use of Mordant Dyes on Silk.—The mordant colors are not very extensively used for the dyeing of silk owing to the fact that when the silk is subjected to the mordanting operations, especially with chrome, it suffers considerably in its good qualities, and particularly in its luster. Furthermore, dyeings on silk are usually not required to have any great fastness to washing and light, but it is sought to obtain as bright and clear a color as possible at the same time retaining the luster and softness of the fiber. There are of course occasions where it is desirable to dye colors on silk which shall have pre-eminent fastness to light and sometimes to washing, and in such cases it may be necessary to employ the mordant dyes.

As chrome cannot be used with advantage on silk as with wool, on account of its tendency to destroy the luster and injure the fiber, the mordanting is usually done with chromium chloride. The silk is steeped overnight in a cold bath of chromium chloride of 2° Tw., or chrome alum of 9° Tw. may be used. Squeeze out the excess of liquor and wash well, then fix for half an hour in a cold bath of sodium silicate of 1° Tw., and finally rinse very thoroughly.* A basic chromium salt is thus obtained as a mordant on the fiber without particular injury to the latter. Dye in a boiled-off liquor bath broken with acetic acid, entering the goods cold and gradually raising to the boil for one hour, then wash and brighten in a weak bath of acetic acid.

13. Mordant Dyes on Cotton.—As already pointed out, cotton has very little affinity for metallic bases. Unlike wool, for instance, when boiled in a solution of chrome or alum and tartar, there is very little of the metallic hydrate taken up by and fixed in the fiber. Owing to this fact the general class of mordant dyes has but little application to cotton. Practically the only mordant dye used in cotton dyeing is Alizarine Red, which gives the well-known Turkey Red. In cotton printing, however, where the application of metallic mordants is more readily made, a number of the mordant dyes are used.†

* In the dyeing of silk noils, where the preservation of the luster is not particularly important the mordant dyes may be used in the same manner as with wool, employing either the top-chrome or the meta-chrome methods.

† In America there is practically no dyeing of Turkey Red on cotton yarns, but a large quantity of gray yarn is sent to England where it is dyed Turkey Red and returned here for weaving purposes. The explanation of this condition probably lies in the fact that such dyeing is a highly specialized branch and is practiced even in England and other countries in only very limited localities; also the process is cumbersome and requires much hand labor and therefore is not well adapted to American conditions. Alizarine dyes, however, are used very largely in calico-printing. Turkey Red has

Owing to the difficulty of properly mordanting cotton directly with metallic salts, rather roundabout and complicated methods have to be adopted. About the sole mordant employed is alumina, and in order to have this fixed in the fiber, it is necessary to treat the cotton first with tannin (which it readily absorbs from solution) or a fatty acid in some suitable form such as Turkey-red oil (which may be readily padded into the fiber). The cotton thus prepared when treated with basic aluminium salts will have aluminium tannate, or, which is far preferable, the aluminium salt of the fatty acid precipitated within the fiber. Padding with the oil preparation allows of considerable metallic base being fixed, and this permits, therefore, of a full heavy shade of red being dyed with alizarine.*

In the mordanting of cotton an operation known as "ageing" is introduced which is not used in mordanting wool. Usually both the oil and the alum treatment requires an ageing. The mordant material is first absorbed by the cotton chiefly by mere capillarity, and the object of the ageing is to bring about a thorough and even decomposition of the mordant compound within the fiber so that the insoluble mordant is fixed. The ageing is usually carried out by hanging the material in suitable warm moist rooms for several days. In former days a dunging operation was often used, whereby the goods were soaked in a decoction of cow's dung for the purpose of decomposing the metallic salt and fixing the insoluble mordant base.

Turkey Red is the name applied to the color obtained on cotton by using madder or alizarine on a mordant of aluminium and oil. This color was formerly of very great importance, and is still very largely used, though in many instances it is replaced by reds obtained with Primuline or with Paranitraniline. Though madder was used in former years for this class of dyeing, at present the artificial alizarine is altogether employed.

Turkey-red dyeing is a rather complicated process, although the various operations may vary considerably with the exact character of the color desired.

14. Experimental. Exp. 140. Old Process for Turkey Red.—Take a skein of well-bleached yarn which has first been boiled out in caustic soda and mordant in a bath containing acetate of aluminium at 9° Tw. It is worked in this bath until the yarn is thor-

largely been replaced on both yarn and piece-goods by Para Red (paranitraniline diazotized and coupled with beta-naphthol), though this latter color is far inferior to Turkey Red in fastness. It is, however, much cheaper and easier to apply.

* In olden times the process of Turkey-red dyeing required as much as four months' time for completion; newer processes, however, have cut this time down to about three days, though with some sacrifice to fastness. The Turkey-red dye is not a simple lake of aluminium and alizarine, but a rather complex lake containing aluminium, calcium, and alizarine, together, no doubt, with a fatty acid. In the old methods of dyeing Turkey Red a rancid olive oil was used, whereas at present the oil employed is a sulphated castor oil (commonly known as Turkey-red oil).

oughly and evenly impregnated with the mordant; then wring out, and dry at a temperature of 120° F. for twenty-four hours.

Next work in a solution containing 10 parts of Turkey-red oil to 90 parts water. The cotton must be thoroughly and evenly impregnated with this solution. Wring out and dry at a temperature of 160° F. for twelve hours.

Next mordant again in the bath of aluminium acetate as described above; squeeze and dry as before.

Next work in a bath containing 0.5 part chalk to 100 parts water, at 100° F. for one-half hour. Then wash well with clean water.

Next dye in a bath containing 15 per cent Alizarine paste and 4 per cent calcium acetate; enter at 70° F., and gradually raise to the boil.

Next oil the cotton again as described above.

Next steam for one hour at one atmosphere pressure, and wash well.

Finally boil for one hour in a bath containing 5 parts soap to 1000 parts water.

The old or emulsion process for dyeing Turkey Red on cotton is summarized as follows by Whittaker in an adaptation from Felsen's "*Türkisch Rot und Seine Concurrenten*:"

First Operation—Boiling.—The yarns are never bleached by chemicing (or treatment with chloride of lime solution), but simply freed from the naturally adhering fatty and resinous substances by "bowking"—i.e., boiling under pressure with alkaline liquors. The general method is to boil the yarn for four to five hours, under a pressure of 30 lbs., in a solution of caustic soda lye of 1° Tw. Some use silicate or carbonate of soda or work in low-pressure kiers; in these cases the boiling has to be continued for six to eight hours. When the yarn has

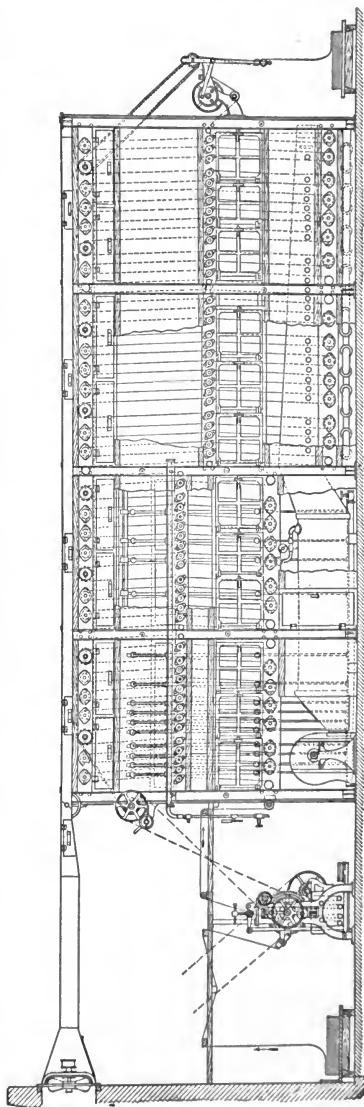

FIG. 190.—Padder and Hot Flue. (Mather & Platt.)

been thoroughly cleaned in this way it is washed well with water, hydro-extracted, and dried in a stove at 120 to 140° F. (50 to 60° C.).

Second Operation—First Green Liquor.—The yarn is passed into the so-called first green liquor, which is prepared by mixing rancid olive oil with sodium carbonate and sheep or cow dung. The most suitable olive oil is that which forms the most perfect and permanent emulsion with the smallest quantity of sodium carbonate. For 100 lbs. of yarn the bath is made up with 15 lbs. of emulsive oil, 1½ to 2 lbs. of dung, 20 gallons of water, and so much of a concentrated solution of sodium carbonate as will bring the liquor to a specific gravity of 2° Tw. In this bath the yarn is thoroughly saturated with the emulsive liquor, at a temperature of about 100° F. (40° C.), for half a minute, and then wrung out evenly. This process, usually called tramping, is done by "tramping machines," which steep the single hanks into the liquors and often also wring out the hanks without much hand labor. After being well prepared the hanks are thrown out into heaps for the night; on the following morning they are exposed to the open air until they feel dry; and finally, they are placed in "stoves" heated to 140° F. (60° C.) for twelve hours (stoving). In some works which produce the very best kinds of Turkey Red, as regards fastness to alkalis and to chlorine, the yarns are exposed in the open air for three or more days, and then they need not be placed in the stoves; while at present they are frequently brought straight into the stoves after having been piled up overnight. In this last case the steam given off in large quantities during the drying must be allowed to escape, as its retention causes the fibers to be tendered. During the prolonged exposure of the yarns in the open air, the fiber is bleached by the sun, especially in the sunny Eastern countries; the slightly greater brilliancy of the Turkey Reds which have been produced in the East is attributable to this action.

Third and Fourth Operations—Second and Third Green Liquors.—These consist of a second and third repetition of the second operation, the object being to increase the amount of oil in the fiber. The baths are prepared exactly as for the first green liquor, and the goods are steeped, exposed to the air, and stoved as before; but it is not necessary to pile them up to lie in heaps overnight.

Some of the alkali which is used in preparing the bath is liberated by the chemical transformation of the oil in the fiber and dissolves, during the second and third treatment, in the green liquor, which is absorbed by the yarn. The excess of this liquor, which is pressed out by the wringing of the hanks, if allowed to flow back into the tramping tank, would change the specific gravity of the bath, and as it is of importance that all the liquors should be maintained regularly of the same specific gravity, only the liquor which is expressed during the steeping in the first oil bath is allowed to run back into the tramping tank; that from the second and third oil baths is collected separately and used only after being reduced to its original specific gravity by dilution with water.

About 30 per cent of oil of the weight of the yarn is used, but only a part of this is permanently fixed in the fiber.

Fifth, Sixth, Seventh and Eighth Operations—First, Second, Third, and Fourth White Liquor Baths.—The yarn has been impregnated with oil, and the latter transformed into such a state by the hanging and stoving operations that it is not readily stripped by weak alkaline liquors. A part of the absorbed oil, however, has not become insoluble or adheres superficially to the fiber. This oil is removed by repeated treatments with alkali in order to avoid the formation of the "surface" color, which is always disposed to rub and smear off.

The goods are tramped for this purpose four times in solution of sodium carbonate (2° Tw.), wrung out, hung up in the open air, and "stoved" as in the previous operations; a different bath is used each time. The oil which is stripped from the fiber forms an emulsion and imparts a white color to the bath, hence the name white baths. The old white baths may be used for the preparation of fresh green liquors.

Ninth Operation—Steeping.—The yarn is steeped for a further purification in water at 130° F. (55° C.), for twenty-four hours, washed well and stoved at 140° F. (60° C.). If it still contains much unmodified oil, a solution of sodium carbonate at $\frac{1}{2}$ ° Tw. is used, the yarn is steeped two hours in tepid water, washed and dried.

Tenth Operation—Sumacing or Galling.—An infusion is prepared of 12 lbs. of best leaf sumac for every 100 lbs. of yarn, and the cold solution is filtered and diluted to $1\frac{1}{2}$ ° Tw. The yarn, while still warm from the stoving operation, is steeped for six hours in the solution at 120° F. (50° C.), and then hydro-extracted. It thus takes up a certain amount of tannic acid.

Eleventh Operation—Aluming or Mordanting.—Cake alum is dissolved in warm water, and, when nearly cold, a cold solution of one-fourth its weight of soda crystals is added. Fifteen to 20 per cent of red liquor, 16° Tw., and 0.5 to 0.7 per cent tin crystals (of the weight of the alum) are often added to the liquor, but these additions are not essential. The addition of stannous chloride is made to prevent ferric oxide from entering into the color-lake and to introduce tin in some form into the color, to make the shade more fiery. In this solution, which is brought to a specific gravity of 8° Tw. and kept at a temperature of 100 to 120° F. (40 to 50° C.), the yarn is steeped for twenty-four hours, then thoroughly washed and hydro-extracted. By this operation aluminium salts are formed, with the previously fixed oxyfatty acids and tannic acids.

The yarn, which is at last ready for dyeing, should now possess a deep yellowish tinge.

Twelfth Operation—Dyeing.—The goods are best dyed in wooden vats with closed steam coils of tinned copper. Iron vessels must be covered from time to time with a coating of insoluble iron tannate, by boiling out with a weak decoction of sumac; if this is not done the red shade will be rendered dull by iron compounds.

The water used for dyeing should indicate 2 to 3° of hardness (Clark's scale); if it contains little or no lime, a suitable amount of ground chalk (about $\frac{1}{2}$ per cent of the weight of the 20 per cent Alizarine paste employed) must be added. Very hard water, or water which contains iron, cannot be used in Turkey-red dyeing.

The dyebath is prepared with 8 to 10 per cent of Alizarine (20 per cent), 1 per cent of tannic acid (or 3 to 5 per cent of good sumac), and about 30 per cent of ox-blood (of the weight of the cotton). The yarn is entered into the cold dyebath, the temperature gradually raised to boiling during one hour, and maintained so for thirty to sixty minutes longer. After dyeing, rinsing in water is advisable.

The goods now possess a dull red color, which is transformed by the "clearing" processes into the brilliant Turkey-red shade.

Thirteenth Operation—First Clearing.—The yarn is boiled for four hours in open pans or under a pressure of 3 to 4 lbs. with about 3 per cent of palm-oil soap, dissolved in a sufficient quantity of water.

Fourteenth Operation—Second Clearing.—The yarn is boiled for one to two hours at 3 to 4 lbs. pressure with a solution of $2\frac{1}{2}$ per cent. of palm-oil soap and 0.15 per cent of tin crystals (on the weight of the cotton), and afterwards thoroughly washed in water. The excess of water is removed by mechanical means (hydraulic press or hydro-extractor) and then the goods are dried in an open-air shed. This closes the long chain of operations.

Exp. 141. Short Process for Turkey Red.—Use a skin of well-bleached and boiled-out cotton.

(1) Sumac in a bath containing 5 parts sumac in 100 parts water; immerse for twelve hours; squeeze.

(2) Mordant in aluminium acetate at 9° Tw., working until the cotton is thoroughly and evenly impregnated, squeeze, and dry for twenty-four hours at 120° F.

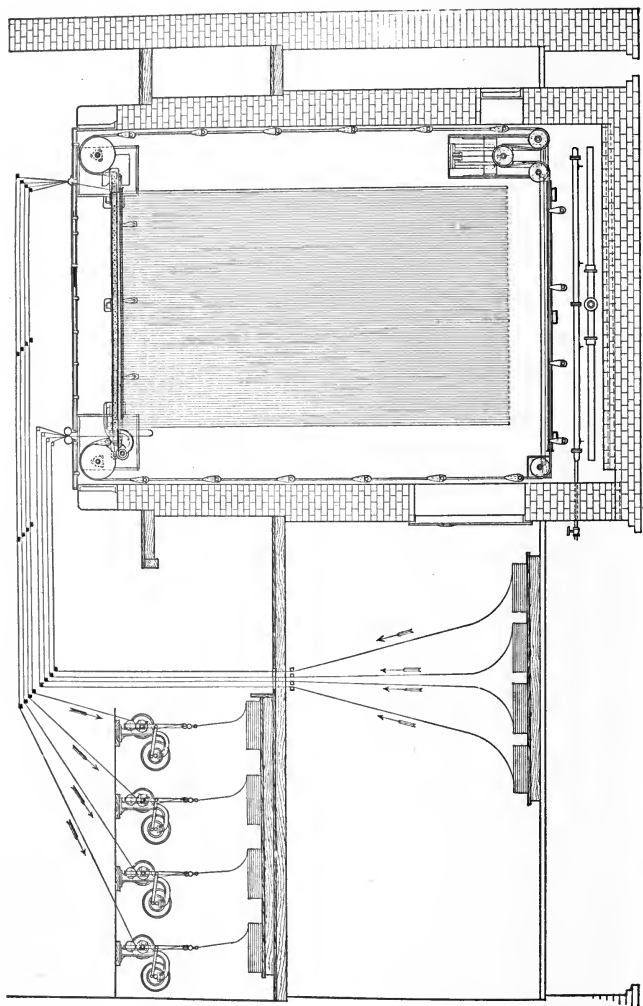

Fig. 191.—Automatic Steamer and Ager. (Mather & Platt.)

(3) Chalk in a bath containing 0.5 part chalk in 100 parts water at 100° F. for one-half hour; wash well.

(4) Dye with 15 per cent Alizarine paste and 4 per cent calcium acetate; entering at 70° F. and gradually bring to the boil; continue at this temperature for one hour.

(5) Brighten by boiling for one hour in a bath of 5 parts soap to 1000 parts water.

This process is cheaper than the foregoing, but does not give as bright shades.

The new process for dyeing Turkey Red may be summarized as follows (adaptation by Whittaker from Felsen's "*Turkish Rot und Seine Concurrenten*"):

Sulphated Oil or Turkey-red Oil Process for Yarn and Piece-goods.—This process also yields beautiful red shades, which are, however, not quite as fast as those obtained by the preceding process.

Turkey-red oil prepared from castor oil is most generally used; sulphated oil can be employed, but has not proved so good, as it does not oxidize and polymerize as readily.

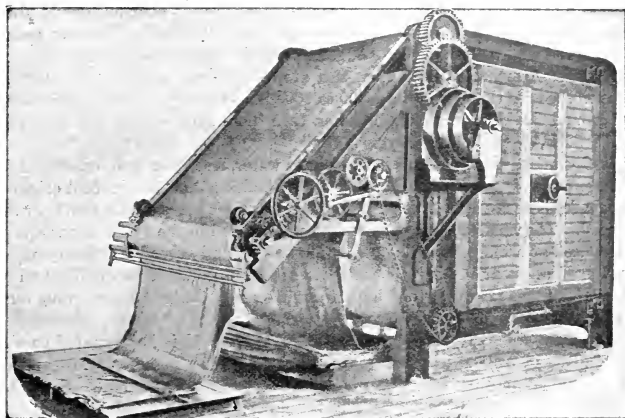

FIG. 192.—Tentering and Drying Machine. (Heathcote.)

Very good results are obtained with a carefully made castor-oil soap—i.e., sodium ricinoleate, but this is not used on the large scale.

First Operation—Boiling.—This is done exactly in the same way as in the preceding processes. Bleaching has to be resorted to in the case of light shades (especially pinks) to obtain bright tints, but the action of the chlorine has to be restricted as far as possible to the destruction of the natural coloring matters of the cotton fiber, while the formation of oxycellulose must be prevented; for this reason, hypochlorite of soda is preferable to bleaching powder or better still is bleaching with potassium permanganate.

Second Operation—Oil preparing.—The washed goods are hydro-extracted, but not dried, and then worked in a bath containing 10 to 20 lbs. of neutralized Turkey-red oil (50 per cent) for every 10 gallons of water. When thoroughly saturated with the liquor they are evenly wrung out.

Third Operation—Storing.—The oiled goods are dried at temperatures ranging from 100 to 140° F. (40 to 60° C.). For the production of a bright and intense red, the operations of oiling and drying and subsequent aluming are repeated once or twice.

Frequently the oiled goods are steamed under a pressure of 8 lbs. for sixty to ninety minutes, but this is not essential.

The compounds constituting the Turkey-red oil are decomposed by the operations of oiling, drying, and steaming, ammonium or sodium sulphate and various organic acids being formed. The latter are similar to the corresponding substances deposited in the fiber in the older processes, and consist of products of the oxidation and polymerization of ricinoleic acid, etc.

Fourth Operation—Aluming.—The goods are worked for five or six hours in a warm bath 100° F. (40° C.) of red liquor 10° Tw. or of basic aluminium sulphate 10° Tw., well wrung out and dried at 100 to 120° F. (40 to 50° C.)

Fifth Operation—Chalking.—This resembles the treatments in the other Turkey-red processes, by which the material is worked in a weak alkaline bath for the purpose of purifying it from an excess of oil; in this process, however, the purification takes place after the aluming, so that not only is there a removal of oil, but also a more complete precipitation of the alumina which has been absorbed by the fiber during the aluming. A chalk bath is generally employed for this purpose (chalking). Brighter colors are said to be produced when phosphate of soda or ammonium carbonate are employed as fixing agents. Arsenate of soda gives still brighter colors than the phosphate. The cotton is worked for thirty minutes at 90 to 100° F. (30 to 40° C.) in a bath containing $\frac{1}{4}$ lb. of ground chalk per 10 gallons of water, then thoroughly washed and dyed without drying.

Sixth Operation—Dyeing.—Moderately hard water, free from iron, exactly as in the emulsion process, is required. For very deep shades about 15 per cent of Alizarine (yellow shade) is necessary; a fine pink is obtained by this process with 1 or 2 per cent of Alizarine V. The whole quantity of the dyestuff is added to the dyebath, and the goods are introduced at a temperature not exceeding 25° C. and turned for twenty minutes; in about half an hour the bath is heated to 140 to 160° F. (60 to 70° C.), and maintained at this temperature for one hour. After dyeing, the goods are wrung out and dried with or without previous washing.

Seventh Operation—Second Oil Preparing.—The material is impregnated once more with a solution of neutralized Turkey-red oil (5 to 10 lbs. per 10 gallons) and dried. The second oiling may be dispensed with or take place after the mordanting. In the latter case a fresh treatment in a weak solution of basic aluminium sulphate or red liquor follows for the purpose of fixing the oil.

Eighth Operation—Steaming.—The goods are steamed for one hour at 15 lbs. pressure or two hours without pressure to develop the color. According to a more recent process, neither oiling nor steaming follows the dyeing; the dyed goods are simply heated for some hours in water under considerable pressure. It is said that the beauty increases up to a pressure of about 65 lbs. When the goods come from the dyebath, they possess an orange tinge, and a part of the dyestuff can be stripped by rinsing in water, since it is not intimately combined with the mordants. The complex lake is formed by steaming only, and the material then receives a dull red color which is brightened by the clearing baths.

Ninth and Tenth Operations—First and Second Clearings.—These operations may be executed as in the older processes; but less severe treatments are sufficient. A fine brilliant red is produced by once or twice boiling under 4 to 8 lbs. pressure for thirty to sixty minutes in $\frac{1}{2}$ per cent soap solutions (without any further additions). The soaped goods are well washed in water and dried at a moderate temperature.

The process can be simplified by raising the temperature of the dyebath to the boiling point. In this case the oiling after dyeing is to be omitted, and the steaming may be dispensed with. But the shade is never so bright or fast as that of the colors which have been produced at a lower temperature with subsequent steaming.

15. List of the Principal Mordant Dyes

(a) Applicable to Previously Mordanted Wool

Acid Anthracene Browns	Anthracene Dark Blue W	Diamond Orange
Acid Chrome Black	Anthracene Red	Diamond Yellow
Acid Chrome Brown	Anthracene Yellow	Dioxine
Alizarine	Anthracyl Fast Red	Domingo Chrome Red
Alizarine Blacks	Anthracyl Blue G and R	Domingo Chrome Yellow
Alizarine Blue (all brands)	Anthraquinone Blue	Fast Brown
Alizarine Blue Black Wand SW	Anthraquinone Green	Fast Mordant Yellow
Alizarine Blue S (all brands)	Anthraquinone Violet	Fast Printing Yellow 3G
Alizarine Bordeaux	Azo Chromine G	Gallamine Blue
Alizarine Brown (all brands)	Blue PRC	Gallanyl Indigo PS
Alizarine Chrome Black W	Brilliant Alizarine Blues	Gallanyl Violet
Alizarine Cyanine (all brands)	Brilliant Alizarine Cyanine	Gallocyanine
Alizarine Cyanine Black	Carbazol Yellow	Galleine
Alizarine Dark Blues	Celestine Blue B	Galloflavine
Alizarine Fast Blacks	Chromazurine S	Gallozine A
Alizarine Gray G and R	Chrome Blue	Gambine G and R
Alizarine Greens	Chrome Brown	Indochromine
Alizarine Indigo SW and SMW	Chrome Fast Yellow	Meta-chrome Brown
Alizarine Maroon	Chrome Patent Green	Milling Brown
Alizarine Orange	Chrome Violet	Milling Orange
Alizarine Purpurine	Chrome Yellows	Milling Red
Alizarine Reds (pastes and powders)	Chromocyanine B and V	Milling Yellow
Alizarine Sapphire	Cloth Brown	Mordant Yellows
Alizarine Viridine FF and DG	Cloth Orange	Phenocyanine B and VS
Alizarine Yellows	Cloth Red B, G	Prune
Alizarine Yellow N powder	Cloth Scarlet	Reso flavine
Anthracene Blue	Coeruleine	Rufigallol
Anthracene Brown (all brands)	Coeruleine S in paste	Sulphamine
	Coreine 2R, AB, and AR	Sulphamine Brown A and E
	Cyananthrol	Salicine Red
	Delphine Blue	Salicine Yellows
	Diamond Blacks	Wool Red
	Diamond Brown paste	Wool Yellow
	Diamond Flavine G	

(b) Suitable for After-mordanting

Acid Alizarine Black	Acid Chrome Brown	Alizarol Yellow
Acid Alizarine Blue BB, GR	Alizarine Black, powder	Alphanol Blue
Acid Alizarine Brown B	Alizarine Blues, powder	Anthracene Acid Blacks
Acid Alizarine Gray	Alizarine Blue SAP, SAE, SKY	Anthracene Acid Blue
Acid Alizarine Green	Alizarine Cyanine Green	Anthracene Acid Brown (all brands)
Acid Alizarine Grenat	Alizarine Greens	Anthracene Blue Black
Acid Alizarine Yellow	Alizarine Sapphire	Anthracene Chromate Brown
Acid Anthracene Brown R, T, and W	Alizarol Black	Anthracene Chromate Green
Acid Chrome Black B and C	Alizarol Brown	Anthracene Chrome Black
	Alizarol Orange	Anthracene Chrome Blue

Anthracene Chrome Browns	Cypress Green	Mono-chrome Brown
Anthracene Red	Diadem Chrome Black	Mono-chrome Gray
Anthracene Yellows	Diadem Chrome Blue Black	Mono-chrome Orange
Buffalo Chrome Black	Diadem Chrome Green	Mono-chrome Yellow
Chromate Blacks	Diadem Chrome Red	Palatine Chrome Black (Gal
Chrome Black B and T	Diamond Black (all brands)	atine Chrome Black and
Chrome Blue	Diamond Browns	Palatine Chrome Blue re-
Chrome Fast Blacks	Diamond Flavine G	quire the addition of a
Chrome Fast Reds	Diamond Green B	small quantity (1 per
Chrome Fast Yellows	Domingo Chrome Black	cent) of sulphuric acid to
Chrome Green	Domingo Violet Black	the dyebath)
Chrome Patent Black	Emin Red	Palatine Chrome Blue
Chrome Yellows	Meta-chrome Bordeaux	Palatine Chrome Brown W
Cloth Red B, G	Meta-chrome Orange	Serichrome Blue
Cypress Blue	Meta-chrome Yellows	Serichrome Green

(c) Suitable for Dyeing in an Acid Bath without After-chroming

Alizarine Cyanine Green	Alizarine Pure Blue	Fast Green G
Alizarine Heliotrope	Alizarine Sapphire	Milling Green S
Alizarine Irisol	Diamond Brown 3R	Naphthol Green B

(d) Chrome Developed Dyestuffs

Acid Alizarine Black R	Carmoisine B	Chromotrop (all brands)
Azo Fuchsine B and G	Chrome Brown BO and RO	Florida Red
Azo Rubine	Chromogen I	

(e) Dyes for Shading, Not Affected by Chrome

Acid Chrome Black B, G	Bordeaux extra	Formyl Violets
Acid Violet 4B	Brilliant Milling Blue	Indocyanines
Acid Yellow AT	Brilliant Milling Green	Rhodamine B, G
Alkali Fast Green 6B	Diamine Fast Red F	Soluble Blues
Anthracene Red	Fast Acid Violet 10B	Sulphon Cyanines
Anthracite Black	Fast Greens	Tartrazine
Azo Crimson 3	Fast Light Yellows	Wool Red B
Azo Fuchsine 6B	Formyl Blue	

CHAPTER XVII

SULPHUR DYES

1. Nature of the Sulphur Dyes.—These colors belong to the general group of substantive cotton dyes and are of rather recent introduction. They are so called because they consist of sulphur compounds,* and are dyed, as a rule, with the addition of sodium sulphide to the bath. The first of these dyes was discovered in 1867 by two French chemists,† and was known as Cachou de Laval; it was prepared by fusing wood shavings and sawdust with sodium sulphide or sulphur. As it had but little tinctorial power it was not a success as a dyestuff.‡ During recent years, however, a large number of these dyes have appeared in almost all colors with the exception of red, and even a so-called sulphur red dye has been brought out, but it is far from being a pure red color.§ We have Sulphur Blacks, Browns, Blues, Yellows, and Greens. The sulphur colors are especially

* The chemical nature of the sulphur dyes is still more or less undetermined, but it is probable that they consist of a mixture of complicated organic derivatives, in which sulphur appears to be a constituent part.

† Croissant and Bretonnière.

‡ The discovery of the sulphur dyes must be credited to the French. Some years after the introduction of Cachou de Laval another French chemist named Vidal discovered that black sulphur dyes could be produced by fusing various aromatic amines with sodium sulphide and sulphur. This soon led other investigators into the field, and between the years 1890 and 1910 a large number of sulphur dyes had been prepared. In the United States the sulphur dyes were among the first to be developed after the outbreak of the Great War, and at the present time practically a full line of the important sulphur dyes are made in this country, and the methods of manufacture have been so improved that these dyes are now available in a purer and more concentrated form than they were when formerly imported from Germany. Though Sulphur Blacks may be made from quite a number of different materials, by far the most important black is the one made from dinitro-phenol, which in turn is made by nitrating chlorbenzol.

§ Thio-indigo Red is sometimes referred to as a red sulphur dye, but this is incorrect, for this dye cannot be considered as belonging to the class of sulphur dyes; it is a vat dye and belongs to the same group as Indigo. In its method of manufacture it also differs radically from the true sulphur dyes. On the other hand, Hydron Blue, though usually classed with the vat dyes and dyed after the manner of Indigo, is properly speaking a sulphur dye, being made according to the general methods for this group, and also from the fact that it may be used as a sulphur dye in a bath with sodium sulphide.

remarkable for their fastness to washing and even fulling, as well as to acids in cross-dyeing. They also furnish deep, heavy shades on cotton.

2. Dissolving the Sulphur Dyes.—Some of the sulphur dyes are directly soluble in water, but these as a rule are not the pure dyestuffs, but contain sufficient residual sodium sulphide left from the process of manufacture to carry the dye into solution. As most of the sulphur dyes, however, at the present time are purified in manufacture by precipitation of the solution of the crude dye with sulphuric acid practically all of the sodium sulphide is eliminated from the dyestuff.* By this means much more concentrated dyes may be obtained, and furthermore the dyes will keep much better, as they are not so deliquescent as when sodium sulphide is present. Whether

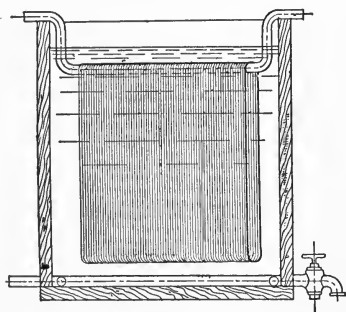

FIG. 193.—Dyeing on Bent Sticks for Sulphur Dyes.

the sodium sulphide acts as a reducing agent and reduces the dyestuff to a soluble leuco-derivative, or whether it acts merely as a solvent on the dyestuff, or still further, whether it combines with the dyestuff to form a soluble compound, are all questions which have not yet been satisfactorily answered. There are points which may be brought forward in favor of each one of these propositions. Sodium sulphide, we know, is a rather strong reducing agent, and apparently the coloring matter may be precipitated from solution

in many cases by simple oxidation with air. In the case of certain blue sulphur dyes, for instance, there seems to be little or no question as to the formation of a reduced leuco-body, for the color of the dissolved dye is not the same color as the dyestuff—instead of being blue it is yellow or greenish, somewhat resembling the appearance of reduced indigo in an indigo vat. Furthermore, many of the sulphur dyes may be brought into solution with sodium sulphite † or sodium hydrosulphite, in which case there is scarcely any doubt as to the formation of a reduced

* The yellow sulphur dyes are the most insoluble of this class of colors and hence care should be taken in dissolving them, or the true value of the dyestuff will be lost in dyeing. Only concentrated sodium sulphide should be used with the Sulphur Yellows, and the best method for dissolving these dyes is to first stir them up into a paste with their own weight of caustic soda, and then to add the sulphide and hot water.

† According to a patent of the Berlin Aniline Works the dyestuff is brought into solution by the use of neutral sodium sulphite in the presence of caustic soda and glucose. This solution is not recommended for use in dyeing, but for printing.

soluble leuco-derivative. In the case of the black and brown dyes, however, this reduction to a leuco-compound is not so apparent.

On the other hand, in the case of Sulphur Black, for instance, the color is taken up by the fiber from solution in practically the same manner as a substantive dye, and there seems to be little or no oxidation required for the development of the color, and the dyestuff appears to act in this case as if it were simply dissolved as such in the sodium sulphide. The third possibility of the dyestuff combining with the sodium sulphide receives some measure of support in that the dye is precipitated from solution by the addition of acid; but this feature may also be explained by the acid neutralizing the alkali in which the dye is dissolved, without any special necessity of the dye forming a compound with the sodium sulphide or not.

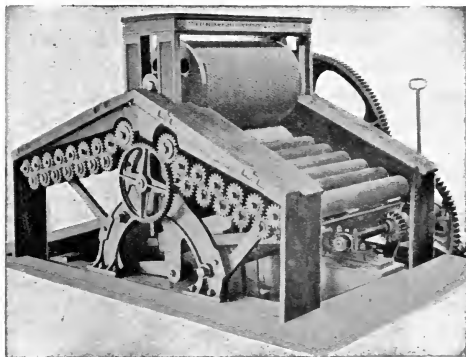

FIG. 194.—Large Size Squeezer for Skein Yarns.

The exact chemistry of this entire matter is yet to be worked out, as nothing very definite has been determined.

The sulphur dyes are best dissolved in iron or wooden vessels by pouring over them hot water containing a part of the sodium sulphide required for the dyeing. The dyebaths should be of wood, and all the metallic pipes and fittings should be of iron or lead, copper and brass being avoided as much as possible, as these have a bad effect on the dyes.*

3. Method of Dyeing.—The sulphur colors are mostly dyed in a bath containing sodium sulphide, soda ash, common salt, and many of them may be after-treated with chrome or bluestone with considerable improve-

* It should also be noted that the dyed goods before being rinsed free from the dye liquor should not come in contact with copper or brass; after washing, however, contact with these metals has no effect on the color.

ment as to their fastness. The sodium sulphide is for the purpose of dissolving and in some cases of reducing the dyestuff (in the case of certain blue dyes); the soda ash is for the purpose of correcting the hardness of the water and making the bath alkaline,* as the dyes appear to work better in an alkaline bath; the salt is added as with ordinary substantive dyes, for the purpose of obtaining a better exhaustion of the dyebath. In some cases the dyestuff itself contains sufficient sodium sulphide to dissolve it in the bath, and consequently none need be added. The sulphur dyes are evidently not as yet distinct chemical bodies; that is to say, the proper tinctorial principle in many cases has not been isolated from contaminating by-products in their manufacture, and consequently it often takes a relatively large amount of dyestuff to obtain a full shade; from 10 to 15 per cent, as a rule, in the case of colors; though in the case of blacks, the color is now generally purified and concentrated so that a full shade is obtained with $4\frac{1}{2}$ to 6 per cent (standing bath) of dyestuff. In this respect, however, these dyes are constantly being improved, as better methods of manufacture are devised. At first, sulphur dyes were sold usually in the form of irregular lumps which rapidly deteriorated on exposure to air and dampness † with liberation of sulphuretted hydrogen; but in this respect there has been much improvement of late by selling the dyes in dry powder form. The sulphur dyes exhaust badly and require a large amount of salt in the bath where heavy shades are to be dyed.‡ On this account the dyebath should be used as "short" as possible. The quantity of liquor will naturally vary with the character of the machine in which the dyeing operation is carried out, but in general it may be stated that when dyeing loose cotton or yarn in an ordinary dye-vessel the proportion of liquor should be from 1 : 20 to 1 : 30, while in dyeing cops and tubes in special forms of dyeing apparatus the proportion of the cotton to the dye liquor

* In some cases, soda ash may be substituted in part or entirely with caustic soda. In the dyeing of Sulphur Black the addition of a small amount of caustic soda is recommended (one-tenth of the weight of the dyestuff) in order to prevent the development of sulphuretted hydrogen gas, the odor of which is very disagreeable and poisonous. This addition of caustic soda is usually made in dissolving the dyestuff. Care should be had not to add too much caustic soda, as otherwise the dyeings will show a brownish tone.

† On account of the hygroscopic nature of the sulphur dyes, they should always be stored in a dry place and protected as far as possible from moisture.

‡ An interesting method for the dyeing of Sulphur Black has been suggested by the Badische Co. A cold fermentation vat somewhat after the manner of Indigo is employed. The vat is filled with 60 gallons of cold water and then set with 8 lbs. of wheat or potato flour, 6 lbs. of bran, 2 lbs. of syrup or honey, and 2 lbs. of soda ash. From 5 to 7 lbs. of Sulphur Black are added per 100 gallons of dye liquor. The following additions must be made to the vat from time to time: 3 lbs. of dyestuff, $\frac{1}{2}$ lb. flour, $\frac{1}{2}$ lb. of bran, and $\frac{1}{2}$ lb. of syrup. After three to four days the vat will be perfectly clear, of a greenish color and ready to use. The vat liquor should always produce a red color with phenolphthalein paper, and the dyebath should be used as short as possible.

may be from 1 : 5 to 1 : 10. In dyeing cloth in jiggers the proportion of liquor will also be quite low (about 1 : 5.) In the use of short baths, however, care must always be exercised not to have the liquor so highly concentrated as to throw the dye and the various salts out of solution. In order to avoid the dilution of the dyebath during the dyeing and the heating up of successive baths it is advisable to use closed steam pipes instead of live steam for purposes of heating.

One of the drawbacks to the use of the sulphur dyes has been their recognized liability to cause a tendering of the fiber, which is slow in development and often does not become evident until some months after the goods have been dyed. Recent researches on this subject have shown that

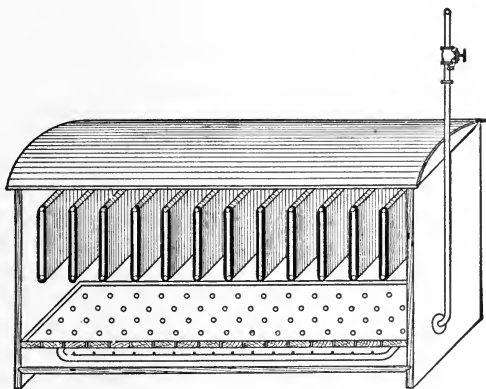

FIG. 195.—Steam Vat for Developing Sulphur Colors on Skein Yarn.

the tendering is caused by the development of free sulphuric acid in the goods, and furthermore that this acid is not derived from sodium sulphide left in the fiber, but is formed by the oxidation of the color-molecule itself.* In order to prevent this tendering action it has been suggested to treat the dyed goods with tannic acid (1 per cent) and lime water, thus forming tannate of lime in the fiber.† This is insoluble in water and possesses the ability to neutralize the free sulphuric acid as fast as formed. Actual tests have shown that this treatment is very efficacious.

Tendering in the case of goods dyed with Sulphur Black may arise in union goods where the warp is dyed with Sulphur Black and the cloth is subjected to a "stoving" operation for the purpose of bleaching the wool

* See Pilling, *Jour. Dyers and Col.*, 1906, p. 54; Vlies, *ibid.*, 1910, p. 79.

† See Holden, *Jour. Soc. Dyers and Col.*, 1910, p. 76.

or of brightening the color dyed on the wool. For such goods suitable direct cotton colors should be used in place of sulphur dyes. Cotton goods dyed with Sulphur Black may also show tendering if after-treated with bluestone. Such an after-treatment is sometimes practiced in order to improve the shade of the black. After-treatment with chrome, on the other hand, reduces the danger of tendering in Sulphur Blacks. To test a dyeing of Sulphur Black for liability to tender, heat the sample in an oven for one hour at 280° F. (140° C.) then expose to the atmosphere until the cotton regains its natural moisture. Carry out a blank test on undyed cotton and then compare the samples for strength. The tendering of cotton dyed with Sulphur Black is due to the formation of sulphuric acid in the fiber, but this acid is not derived from the free sulphur which may have become attached to the fiber, as is very generally supposed. Zänker has shown that the sulphuric acid is derived from the sulphur combined constitutionally in the dye. All of the sulphur existing as a component part of the dye, however, is not convertible into acid, but only a relatively small proportion. The presence of any heavy metals (such as iron) in the dye will cause the formation of acid very quickly.

The sodium sulphide in the bath should be sufficient thoroughly to dissolve all the dyestuff so that the bath is clear; if the bath is turbid, more sodium sulphide should be added. Usually the amount of sodium sulphide required is equal to that of the dyestuff, though in cases of highly concentrated dyes and blacks, this quantity may need to be considerably increased. Insufficient sodium sulphide will leave undissolved dyestuff in the bath, and cotton dyed under such conditions will be coated with a loosely adherent layer of dyestuff, which will subsequently wash off or crock, while the color will usually show uneven streaks or bronziness.*

Probably the chief defect which arises in the dyeing of Sulphur Blacks on cotton is the bronzing of the color. The bronziness may be removed in most cases by treating the dyed goods in a bath containing an emulsion of oil. Olive oil with soda and some soap may be used for this purpose, or the following has also been recommended: melt 100 lbs. of palm-oil in

* Bronziness in the dyeing of Sulphur Black may be due to several causes: (1) The use of too much salt in the bath; this may readily be corrected by properly diluting the bath with water. (2) The use of too much dyestuff causing an overloading of the fiber with color. (3) The use of too little sodium sulphide, thus allowing the dye to come out of solution too readily. A few drops of the dyebath placed on filter paper should show no undissolved sediment. (4) Undue exposure of the material to the air during dyeing, or by allowing the dyed goods to lie or hang some time before being rinsed. (5) Incomplete rinsing after dyeing; if the rinsing is complete the last wash waters should flow off clear. If bronziness develops on the dyed cotton from whatever cause, it may be removed by passing the goods through a weak warm bath of sodium sulphide, which has the effect of dissolving off the outer layer of unfixed dyestuff which causes the bronziness. This sodium sulphide wash should be very dilute, as otherwise so much color may be removed that the black will dry up thin and slaty.

an iron pan, add 12 lbs. of caustic soda (90° Tw.), stir the mixture and allow to stand overnight; 10 per cent of this emulsion is used on the cotton in a bath at 140° F. Not only will the bronziness be removed but the handle of the cotton will also be made much softer. In order to test the condition of the bath some of the liquor should be dropped on a piece of white blotting paper, when if a perceptible precipitation is shown, more sodium sulphide should be added until the bath is brought to the proper condition. If sodium sulphide crystals are employed instead of the fused sodium sulphide, just about twice the quantity must be used, as the crystals contain a large amount of water of crystallization. The amount of sodium sulphide to be added to the bath will also vary with the character of apparatus employed in dyeing. In open dye-vessels, such as vats and jiggers, permitting free access of air, it will be necessary to use about twice as much sodium sulphide as dyestuff, whereas in dyeing machines of the closed type where there is little or no access of air, the amount of sodium sulphide may be reduced to a weight equal to that of the dyestuff used.

Unnecessary boiling of the dyebath should be avoided, as this causes the oxidation of the sulphide to too great an extent; if there is too much sodium sulphide present, on the other hand, the cotton will not take up the color well and the dyeings will appear thin. In place of using common salt, Glaubersalt may be used with like effect. In order to control the amounts of salts which are present in standing kettles, it is best to use hydrometer tests; for blacks the cold dye liquor should stand at 8 to 10° Tw. at 60° F., but for blues and other colors it should not exceed 4 to 5° Tw. It should be borne in mind that 10 parts of common salt are equivalent to 12 parts of calcined Glaubersalt or to 24 parts of the crystallized Glaubersalt.*

As the dyebaths with sulphur colors exhaust but poorly they are usually preserved as standing kettles, when only about two-thirds of the original amount of dye need be added to the second bath to produce the same

* The amount of salts added should really be based on the volume of dye liquor rather than upon the weight of the cotton being dyed. The following table shows the relative amounts:

Proportion of Liquor.	Pounds per 100 Gallons of Liquor.	
	Glaubersalt (crystallized)	Common Salt.
1 : 5	20-25	8-10
1 : 10 to 1 : 15	20-50	8-20
1 : 20 to 1 : 30	100-120	40-50

When the dyeing is carried out in a mechanical apparatus in which the material is closely packed and a concentrated dye liquor is used, it is best to employ Glaubersalt rather than common salt, as the former is more soluble.

shade. The amount of dyestuff to be added usually has to be adjusted till the third or fourth bath, when it becomes constant.* A proportional amount of sodium sulphide has to be added with the dyestuff. As a rule, the sulphur dyebaths do not deteriorate to any extent on standing. The sodium sulphide contained in the liquor is gradually oxidized to sodium sulphate (glaubersalt) on prolonged exposure to the air, and the coloring matter in consequence becomes precipitated;† but this may easily be remedied and the bath brought back to its useful condition again by boiling up and adding a fresh amount of sodium sulphide.‡

When dyebaths of Sulphur Black remain used for some length of time, the sodium sulphide will become more or less completely oxidized by the air; and consequently on bringing the bath into use again it will be necessary to use considerably more sodium sulphide than would at first be indicated. Under such circumstances the liquor of the bath should always be tested with a piece of filter paper to see if the dyestuff is in proper solution.§

The length of time a standing bath may be used with Sulphur Black

* The quantity of dyestuff to be added to the second bath for the production of a certain depth of color is about one-half to two-thirds that originally taken for the first bath. The quantity of sodium sulphide to be added, however, is not necessarily in the same proportion, as this is not taken up by the fiber from the dyebath in the same ratio as the dyestuff, but to a less degree. On the other hand, more or less of the sodium sulphide is oxidized in the bath to sodium sulphate. Therefore the proper amount of sodium sulphide to be added must be governed by the amount required to bring the dyestuff in the bath to a condition of good solution. The amount of salt and soda taken up from the bath by the fiber is also much less than that of the dyestuff, therefore the quantities of these to be added are relatively small, and are to be governed by the density of the bath, as already pointed out.

† Frequently when dyeing Sulphur Blacks a white scum of finely divided sulphur will collect on the surface of the dyebath and become attached to the cotton, leaving a white mark. This defect may be remedied by adding sodium sulphite to the dyebath.

‡ Almost perfect exhaustion may be obtained in dyeing with sulphur dyes by adding 5 per cent of ammonium sulphate to the bath towards the end of the dyeing and boiling fifteen minutes longer (see Whittaker, *Dyer and Calico Printer*, 1916, p. 50). This action may be illustrated by the following test: Prepare two dyebaths (a) 18 per cent Sulphur Black, 18 per cent sodium sulphide, 5 per cent soda ash and 60 per cent salt; (b) 12 per cent Sulphur Black, 12 per cent sodium sulphide, 5 per cent soda ash and 60 per cent salt. Enter the yarn into the boiling dyebath, work one-half hour, then add 5 per cent ammonium sulphate to bath (b) and continue boiling for fifteen minutes. It will be found that both dyeings will have about equal depth of shade, showing that the second bath is completely exhausted. The explanation of this action is that the ammonium sulphate is decomposed with gradual liberation of acid that throws out the dyestuff on the fiber.

§ In the dyeing of cotton piece-goods with Sulphur Black in the jigger it is not recommended to add salt to the bath, as this is liable to redden the shade and there is also a tendency of the selvedge to come up bronzy. In dyeing cotton pieces with a worsted border with Sulphur Black the dyebath must be cold to leave the wool white, also glue is added to the bath to prevent the wool from being injured by the alkali present (about 1 per cent of glue is added to the first bath).

will depend a good deal on the quantity and character of the impurities constantly being introduced. If good soft water is employed and if the cotton is boiled out before coming into the dyebath, the latter may be used at times for months before it is necessary to discard it. If, however, dirty or hard water is used and if the raw cotton is introduced directly into the bath a large amount of impurities will collect in the liquor and it will soon be rendered unfit for use. Before running off an old bath, however, the dyestuff may be saved from it by passing through it several batches of goods without further addition of dyestuff, then bringing these batches up to shade in the fresh bath.*

In special cases glucose, dextrin and Turkey-red oil are added to the bath in order to secure better exhaustion and better penetration of the goods.† In nearly all cases the sulphur dyes may be dyed in a boiling bath, though just under the boil is a better practice; in the case of some blue dyes, the temperature of the bath should not be over 85° F. The sulphur colors may also be dyed very well in lukewarm or even cold baths. After dyeing it is important that the goods be well squeezed and thoroughly rinsed immediately after coming from the dyebath, in order to prevent the precipitation of unfixed dyestuff superficially on the fiber; this rinsing gives rise to more even shades and the colors are faster to rubbing.‡

* Besides the ordinary form of Sulphur Black in powder, this dye is also marketed in the form of a paste, in which case it will usually contain about 40 per cent of solid dyestuff. It will, however, show a greater strength than this when compared with the dry powder, and will also show much less acidity and less content of iron. This is due to the fact that in drying Sulphur Black, unless very special precautions are taken, some of the tinctorial strength of the dye will be lost and a considerable quantity of acid (presumably sulphuric acid or a bisulphate salt) is also formed in the drying. This latter dissolves some iron from the pans, etc., which thus gets into the dyestuff. In order to prevent the formation of acid in the paste dye it is customary to add a small quantity of soda ash directly to the paste (and the same can be done in the preparation of the dry powder). The paste, though possessing these better features, is not generally favored by the dyers, as it will be continually drying out and thus changing in strength unless used up very shortly after the container is opened. Furthermore, the proportion of freight expense is higher on account of the water content of the paste. On the other hand, the cost of manufacture of the paste is less per unit of color than the powder.

Sulphur Black has also been marketed in the form of a liquid (as in Thiogene Black Liquid M, of Höchst) which consists of the reduced coloring matter in solution ready for use in dyeing. A 50 per cent solution was generally made, and this required only one-third the usual amount of sodium sulphide to be added to the bath. This form of Sulphur Black was especially recommended for dyeing by the padding method.

† These additions are seldom made except when heavy yarns or closely woven goods are being dyed.

‡ As the liquor in the goods contains considerable dyestuff this should be squeezed back into the bath for the sake of economy. The first rinsing bath will also contain quite a lot of dyestuff, and this liquor may be used for freshening up the old dyebath or for the solution of the next addition of coloring matter. If a small proportion of

With some of the blues it is necessary to oxidize the color after dyeing; this may be done by squeezing and hanging in the air, or by steaming in

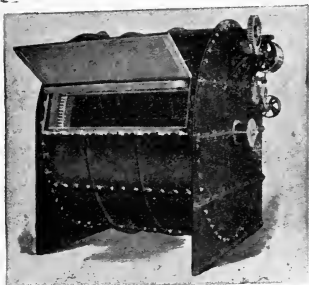

FIG. 196.—Iron Dyeing Machine for Sulphur Colors. (Klauder-Weldon Dyeing Machine Co.)

the air, or by after-treating with a solution containing a small amount of chrome or sodium peroxide. Some of the Sulphur Blues, however, dye direct without any after-treatment.*

Owing to the strong alkalinity of the sulphur dyebath, caution should be used not to get the liquor on the hands or skin of the workmen. In handling the goods the hands should be protected with rubber gloves.

In dyeing yarn in the open vat on sticks, if the goods are simply lifted out of the dyevat and hung up to drain, there will be so much dye liquor in the yarn that the dye is liable to oxidize and show up bronzy on the goods. On the other hand, if the yarn is not allowed to drain but is washed off immediately a larger amount of dye liquor will be lost in the wash waters. In order to overcome these undesirable features it is necessary to wring or squeeze the yarn as it is taken from the vat. To do this by sodium sulphide is used in the first rinsing bath, the goods will be more thoroughly cleansed of any unfixed particles of coloring matter, and consequently will exhibit a greater degree of fastness to crocking.

* The after-treatment by steaming for the purpose of developing the proper color of certain of the blue sulphur dyes may be conveniently carried out on skein yarn by hanging the hanks in an empty vat, and rather than employ the dyevat itself it is best to use one that has been specially arranged for this purpose. The vat should be fitted with a perforated false bottom and with a roof-shaped lid covered on the inside with cloth. This is done in order to prevent the condense water from dripping on the goods, as the dyeings will not develop where drops of water fall on the material. The steam pipe carries an air injector so that the steaming treatment is accomplished with a mixture of steam and air at a temperature of 180 to 200° F. The perforations in the steam pipe should be in an oblique downward direction so that the steam does not blow directly on to the goods (see Fig. 195). Cloth may be steamed by folding it up loosely in the moist condition and leaving it in a room at 175° F. for several hours. During the steaming of the sulphur dyes it is necessary that the goods contain some caustic soda and sodium sulphide; on this account it is best not to rinse the goods before steaming. If the goods are washed after dyeing, before being placed in the steam box they should be passed through a bath containing $\frac{1}{4}$ oz. of caustic soda and 1 oz. of sodium sulphide per gallon. In some cases, instead of steaming the development may be satisfactorily accomplished by squeezing the yarn out evenly then hanging it up on sticks and exposing it to the air at the ordinary temperature for several hours. In the case of warps and loose cotton the goods are simply allowed to lie in the warm moist condition until properly oxidized.

hand is both inconvenient and harmful to the workmen as the sodium sulphide liquor is quite corrosive to the hands and skin. It is best to have the dyevat provided with a yarn wringer through which the skeins are passed before being rinsed. It should be so arranged that the dye liquor that is squeezed out runs back into the bath. If it is not feasible to squeeze the yarn in this manner, the hanks should be put in a centrifugal hydro-extractor and the excess liquid removed. The yarn may then be washed in the hydro-extractor before being removed.

Many of the sulphur dyes resemble the vat colors in that they may be reduced to a soluble leuco-compound by the action of reducing agents in the presence of strong alkaline solutions. Under these circumstances they may be used practically as vat dyes, similar to Indigo or the indanthrene colors. This process, so far, has been but slightly studied and its practical feasibility has not been thoroughly established. According to Ganswindt (*Theorie und Praxis der modernen Farberei*, p. 306) the only form of this process which has been discussed is the glucose-caustic soda vat. It may be prepared as follows: Sulphur Black (or Sulphur Blue), for example, is mixed with an equal weight of caustic soda (40° Bé.) which has been previously diluted with an equal volume of water; then an equal weight of glucose is added, and the mixture heated, when a complete reduction and solution will result. This liquor furnishes the "stock-vat" and is added in the desired amount to the dyebath, which is made up with common salt and neutral sodium sulphite. It is even said that in this manner the sulphur dyes may be applied in connection with Indigo in the same vat. According to a French patent of the Höchst Co. better results can be obtained by the use of hydrosulphite as the reducing agent. In this case the dyestuff is mixed with fifteen times its weight of hydrosulphite solution (13° Bé.) at a temperature of 140° F. This furnishes the stock-vat and may be used in a manner similar to that described above.*

* An English process patented by Lodge-Evans for the use of sulphur dyes in a reduced form in a vat is of interest. The process was devised chiefly for the application of sulphur dyes in union dyeing, garment dyeing and the dyeing of delicate fibers, such as artificial silk, which will not stand the action of a boiling bath of sodium sulphide. The process depends on the dissolving of the dyestuff in a solution of sodium sulphite; this gives a perfect solution of the leuco-compound, which, however, has no dyeing properties. The addition of ammonium sulphide or sodium hydrosulphite to this solution brings it to a condition in which it will dye the various fibers satisfactorily.

The preparation of the ammonium sulphide vat is carried out as follows: Boil up 1 part of sulphur dyestuff with 2 parts sodium sulphite (cryst.); then add 1 part sodium sulphide (conc.) and boil until solution is complete. Cool down the bath and add 2 parts ammonium sulphate, which produces ammonium sulphide and sodium sulphate in the bath by double decomposition. The ammonium sulphide is used as it does not have the same destructive effect as sodium sulphide on wool, silk, and artificial silk.

The hydrosulphite vat is prepared as follows: Boil up 1 part of the sulphur dye with

4. After-treatment of Sulphur Dyes.—The depth and bloominess of Sulphur Blacks may be considerably improved by giving the cotton an oil finish after dyeing.* An olive-oil emulsion prepared by boiling up 1 pint of olive oil and $\frac{1}{2}$ lb. of soda ash with 5 gallons of water will serve very well. This amount of emulsion will be sufficient for treating 100 lbs. of cotton. A lukewarm bath containing a small quantity (1 to 3 per cent) of soap or cotton softener may also be used for brightening the color.† This treatment also serves the purpose of softening the goods, which are usually made rather harsh and stiff when dyed in heavy shades with the sulphur colors.‡

Dyeings with Sulphur Black will usually become somewhat bluer after standing for a short time, and therefore this must be allowed for in matching colors. This slight change in tone is probably due to oxidation. It usually requires a few days to effect the maximum change and after that the color is permanent. If it is desired to bring up this change immediately,

4 parts sodium sulphite (cryst.) until complete solution is obtained; then cool the liquor and add 1 part of sodium hydrosulphite powder (conc.). The formaldehyde or zinc hydrosulphite compounds must not be used.

In dyeing with these baths they are started cold, at which temperature cotton and artificial silk only are dyed. If union goods or silk-cotton material is to be dyed the temperature of the bath must be raised if a uniform shade on both fibers is desired. The proper temperature varies with the different colors; Sulphur Black, for instance, dyes well at 150° F., while Sulphur Blue, Sulphur Green, Sulphur Brown, and Sulphur Yellow should be dyed at about 100° F. Even with these conditions, however, the wool and silk are somewhat tendered, therefore in practice the process will doubtless be mostly limited in the case of union goods to the dyeing of the cotton in fast colors in the piece. In dyeing artificial silk the hydrosulphite bath is preferred, as the color goes on well in a cold bath without injury to the luster and strength of the fiber.

* In dyeing mercerized cotton with sulphur dyes it will generally be found that the fiber has lost much of its luster. This defect may be somewhat improved by an after-treatment at 140° F. in a bath containing 3 per cent of soap and 1 per cent of olive oil emulsified with ammonia.

† The various mixtures suggested for the purpose of softening yarns dyed with Sulphur Blacks include the following: (1) Use 3 per cent of soft soap in a bath at about 200° F. for one-half hour; this makes the shade rather fuller and bluer. (2) An emulsion of 2 per cent of soap and 1 per cent of olive oil, used in a bath at 140° F. for one-half hour will also make the shade fuller and bluer. (3) An emulsion of 2 per cent of soap with 3 per cent of Turkey-red oil, used in a bath at 140° F. for one-half hour. (4) An emulsion of 1 per cent of soda ash with $1\frac{1}{2}$ per cent of olive oil, used in a bath at 140° F. for one-half hour. (5) An emulsion made by boiling up 1 per cent of starch with 1 per cent of pressed lard, used in a bath at 120° F. for one-half hour; this will deepen the black without altering its tone.

‡ In the dyeing of Sulphur Blacks on cotton hosiery it is sometimes desirable to imitate the peculiar "handle" of Aniline Black dyeings. In order to accomplish this the cotton may be treated as follows: The goods after dyeing are well rinsed and then treated with a hot bath containing 4 ozs. of soap per 10 gallons; lift, drain, and then treat for a short time in a lukewarm bath containing 6 ozs. alum and 6 ozs. sodium acetate per 10 gallons, then hydro-extract and dry.

the dyeings may be after-treated for half an hour in a fresh bath at about 160° F. with 3 per cent of chrome and 5 per cent of caustic soda.

Some of the sulphur dyes require to be fixed or after-treated with metallic salts, such as chrome or bluestone.* In certain cases this after-treatment is necessary for the complete development of the color, while in other cases it merely increases somewhat the fastness of the color to light and washing.† The

* The after-treatment with bluestone must never be used with Sulphur Blacks as this will cause the dyed cotton to become tender.

† There is a group of the sulphur colors known as the Melanogen dyes (Höchst) which is somewhat different from the usual sulphur colors in that the direct dyeings have no value, but require to be after-treated with metallic salts in order to furnish satisfactory shades. It is supposed that they form real color-lakes with the metallic compounds. The Melanogen for black is dyed without the addition of sodium sulphide, using a rather concentrated bath with the addition of 2 to 5 per cent of soda ash and 4 ozs. of common salt for each gallon of dye liquor. After dyeing the goods are rinsed and after-treated in a fresh bath with 4 per cent of copper sulphate and 2 per cent of acetic acid to give a jet black, or with 4 per

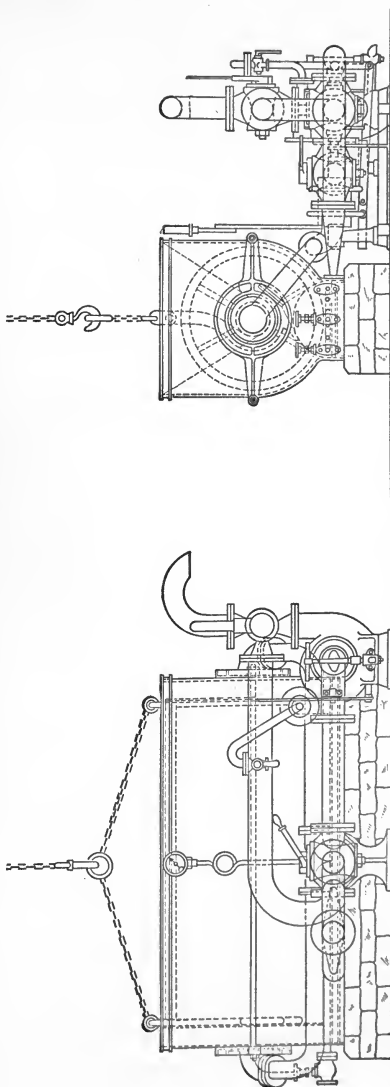

FIG. 197.—Machine for Dyeing Sulphur Colors on Beamed Warps.

after-treatment, as a rule, darkens the shade and dulls the color. It is carried out in the same manner as for substantive dyes. An after-treatment with sodium acetate is also frequently given the sulphur colors; this is especially so with the brown dyes. It is for the purpose of neutralizing the excess of sodium sulphide in the fiber. The treatment usually alters the shade somewhat, but if it is omitted the color of the dyed cotton will generally slowly change considerably after several weeks' standing.

The sulphur colors may be stripped to a certain extent (in case the color goes over the required shade) by treating with a hot bath containing sodium sulphide (3 to 10 ozs. of sodium sulphide per 10 gallons of water).

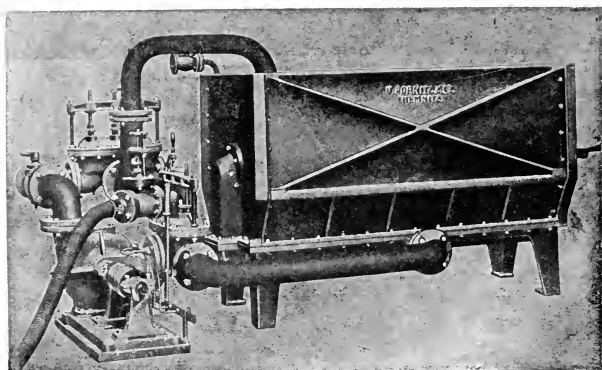

FIG. 198.—Dyeing Beams with Sulphur Dyes. (Pornitz.)

Solutions of soap and soda ash have but little effect on the sulphur dyes. If a greater degree of stripping is desired, solutions of bleaching powder may be used.

5. Topping of Sulphur Colors.—The sulphur colors may be topped with a variety of dyes. Like the general class of substantive colors they possess the property of fixing basic dyes, though to a greater extent. The fastness of the color does not appear to be much impaired by the topping, provided an excess of basic dye is not employed. The amount of the latter actually fixed is about 0.2 to 0.4 per cent, and this is sufficient to furnish good bright shades. The topping is carried out in a fresh cold bath with

cent of nickel sulphate and acetic acid to give a bluish black, or with 4 per cent of zinc sulphate and acetic acid to give a violet tone black. The Melanogen Blue is dyed and developed in the same manner.

the addition of 2 to 4 per cent of acetic acid, and care must be taken to avoid unevenness as the basic color is absorbed very rapidly.* The sulphur colors may also be topped with the ordinary substantive dyes in a fresh bath,† or certain of the latter may be used together with the sulphur dyes in the same bath.‡ The sulphur dyes may also be topped with Indigo for the purpose of obtaining very fast heavy shades of the latter with only a small amount of Indigo being used. The Sulphur Blues and Blacks are chiefly used for this purpose.§ The Sulphur Blacks may also be topped with one-bath Aniline Black, especially where a weighting of the cotton is desired. The Aniline Black is applied in the following bath: 4 per cent of aniline salt, 6 per cent of hydrochloric acid (30° Tw.), 3 per cent of sulphuric acid (168° Tw.), 3 per cent of bluestone, and 4 per cent of chrome. The cotton (previously dyed with the sulphur color) is worked in the cold bath for one hour. The bath is then slowly heated to 140° F., and the goods are finally well washed and soaped. The advantage of this process of dyeing, however, over the plain Sulphur Black is to be questioned. The natural dyewoods, as well as the Alizarine colors, may also be used for topping the sulphur colors, but such processes would have very little application.¶

6. Fastness of Sulphur Colors.—In general fastness the sulphur dyes far surpass most other cotton colors. They have great fastness to washing, fulling, acids, alkalis, and water, and their fastness to light is in general

* If only a very small amount of the basic dye is used for shading purposes, it may be dyed in a cold soap bath; but in this case it is necessary to avoid carefully the use of hard water.

† The sulphur dyes may also be used as ground colors for Paranitraniline Red, thus producing claret reds, grenades, and dark brown shades.

‡ In this case, however, the dyestuff solutions must be prepared separately and added to the bath. Naturally, only those substantive dyes may be used that are not affected by the sodium sulphide present in the bath.

§ The sulphur dyes (and more especially Sulphur Blue) apparently act as a mordant towards Indigo. Cotton wares dyed with Sulphur Blue and then dyed in the indigo vat take up considerably more Indigo than undyed cotton. In this way the sulphur dye forms a very good bottom color for the Indigo; and in fact, this process has found considerable use in practice, as by its means a heavy shade of indigo blue may be obtained with a minimum quantity of Indigo, and the color is just as fast as with Indigo alone.

¶ During the war navy blue on cotton uniform cloth and overalls was dyed by first dyeing the material a medium shade with Sulphur Black and then topping with Methylene Blue and Methyl Violet. In topping the sulphur colors with basic dyes the sulphur dyed cotton must be thoroughly washed in order to remove all alkali and sodium sulphide as completely as possible. The basic dye is then applied in a cold bath with the addition of 5 per cent of acetic acid or alum to prevent the color from going on too quickly, as the sulphur dye possesses a strong affinity for the basic dye. It is necessary that the topping bath should be kept acid throughout, for if the cotton has not been thoroughly washed the sodium sulphide may act on the basic dye.

good.* They are not fast, however, to bleaching with chloride of lime; though certain of them withstand a slight treatment with this reagent.

As a rule, the sulphur dyes are taken up by cotton very evenly; though in cases where an after-treatment is necessary to develop the color, care should be taken to have the goods squeezed uniformly, otherwise they are liable to finish up unevenly. In fastness to rubbing or crocking the sulphur dyes are very satisfactory, provided they have been well washed after dyeing, so that all unfixed dyestuff and liquor is completely removed.

The sulphur dyes are eminently suited for cross-dye colors, where dyed cotton warps are woven with white wool filling, and the latter is subsequently dyed in an acid bath. They are also suitable for colored weaving

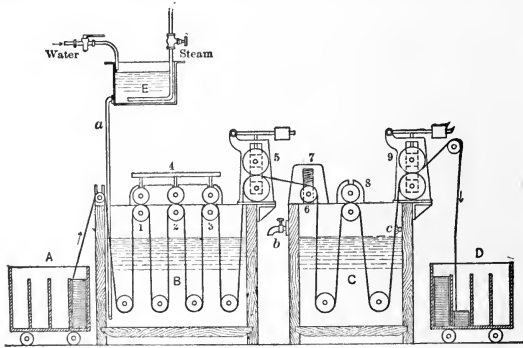

FIG. 199.—Machine for Dyeing Warps with Sulphur Colors.

yarns in goods which must stand considerable washing. For the dyeing of hosiery yarns they are also very useful; the Sulphur Blacks, as a rule, giving a color on hosiery as satisfactory in every respect as Aniline Black, there being less liability of tendering the cotton and the goods are more comfortable to the feet. Furthermore the process of dyeing Sulphur Black on hosiery is much shorter and simpler than when Aniline Black is used, and there is more certainty in the production of uniform results. The cost of dyeing hosiery with Sulphur Black is somewhat less than with Aniline Black.

The Sulphur Browns of a tan shade are also very largely used in the dyeing of cotton hosiery for the production of the well-known tan colors. Much faster and more satisfactory shades on hosiery can be obtained in this manner than with the substantive dyes, or in fact, with any other colors.

*The fastness to light of some of the sulphur dyes, however, is only moderate. Therefore care should be used in the proper selection of these dyestuffs.

For the purpose of brightening the colors thus produced with the sulphur dyes they may be suitably topped with such basic dyes as Safranin, Flavophosphine, Brilliant Green, and Methylene Blue. The topped colors require but a very small amount of the basic dye, and the general fastness is not changed. The sulphur dyed tans are much more satisfactory for hosiery than those obtained with Cutch, as the color is not only faster, but the goods are left in a soft condition and not made harsh and stiff as with Cutch.

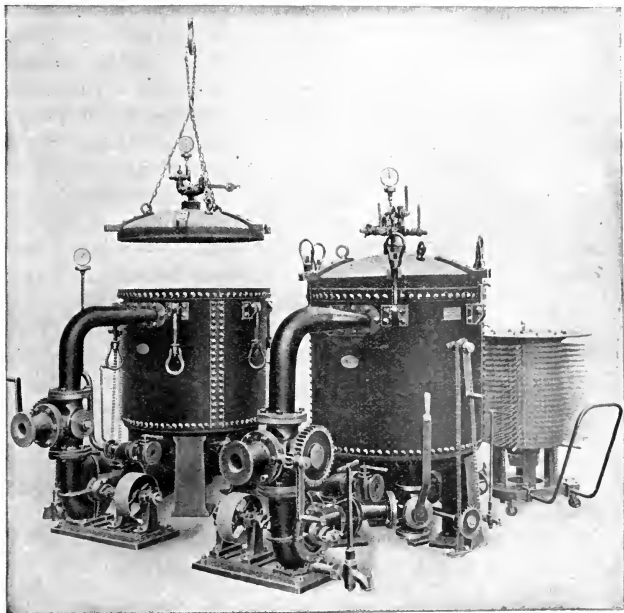

FIG. 200.—Cop and Cheese Dyeing Machines for Sulphur Colors. (Haubold.)

Sulphur Black and the other sulphur dyestuffs show a greater affinity towards mercerized cotton than towards the unmercerized fiber. Therefore in the dyeing of mercerized cotton, smaller amounts of dyestuff must be used than when dyeing ordinary cotton. Also the dye bath should be charged with much less salt, and it is also permissible to employ more dilute baths. Mercerized cotton should always be wetted-out before going into the dye bath. Artificial silk also exhibits a strong affinity towards the sulphur dyes, the collodion or Chardonnet silk being especially reactive in this respect. As artificial silk is quite sensitive to hot

solutions of caustic alkalies (sodium hydrate or sodium sulphide) in dyeing this fiber the alkalinity of the bath should be as little as possible, and the temperature should not run over 140° F. It is also well to add Monopol Oil to the bath.

Sulphur Brown (in combination with Sulphur Black and Sulphur Yellow as required) is very largely employed for the production of brown khaki and olive-drab shades on cotton uniform cloth. Their high degree of fastness to washing and light renders them eminently adapted to this purpose. Heavy cloth, such as canvas, tarpaulin, etc., is generally dyed with the mineral pigment iron buff combined with chrome green, but for uniform cloth the mineral dyes are unsuitable on account of the harshness and stiffness they impart to the fabric. During the late war the sulphur dyes were used on an enormous scale for the dyeing of government cotton uniform cloth, and the results obtained were very good. Of course since there are a large number and variety of Sulphur Browns made from a wide variety of raw materials and by different methods, it is natural to find some that are not as fast as others; but by proper selection it is possible to obtain dyes of very satisfactory fastness. As the colors obtained with sulphur dyes are not fast to chlorine bleaching, there have been many instances where khaki uniform cloth has suffered on being laundered where hypochlorite bleach liquors have been used in the laundry methods.

Since the war sulphur dyes have also come into considerable vogue for use in dyeing denims for workmen's overalls. Formerly this class of goods was dyed almost exclusively with Indigo, in fact accounted for the principal consumption of Indigo in this country. Sulphur Browns and Sulphur Blues are now extensively used for this cloth, and the results have proved so satisfactory that no doubt they will permanently replace Indigo to a very considerable extent in the future. The color obtained with Indigo, perhaps is somewhat brighter and clearer in tone than most of the Sulphur Blues, but some of the sulphur colors even in this respect are practically the equal of Indigo. It is also said that while Indigo gradually loses its intensity of color on long exposure to light and by repeated washings, it always preserves its purity of tone, whereas the Sulphur Blues, though at times even superior to Indigo in retaining the depth of shade, nevertheless soon lose their purity of tone and become tarnished in color. While this may be true to a certain extent, it has little effect on the practical use of the color. The use of sulphur brown and khaki shades on overall material had its inspiration, of course, in the extensive use of khaki during the war. These shades are even more serviceable in practical use than the blue colors, both when employed in solid colors and when used as stripes.

Owing to the great interest aroused in the manufacture of sulphur dyes in this country and their extensive use by reason of the war, the possibilities of their application to various forms of cotton materials for the production

of fast colors has been more and more recognized by dyers and the trade in general. As a consequence, these dyes are now perhaps far more used in this country than they were before the war, and wherever it is possible to produce the required shades they have largely replaced many of the formerly used substantive colors, as they are much faster to washing, and also many of them are less expensive. The blue sulphur dyes, however, are as yet of a high price owing to the methods and raw materials employed in their manufacture; and on this account they cannot as yet be employed in competition with Indigo on a price basis. It also limits their use considerably in many forms of cotton dyeing, where such dyes as Direct Blue 2B are still employed.

7. Apparatus Used in Dyeing Sulphur Colors.—As a rule it is recommended when dyeing with the sulphur colors that the best results are to be

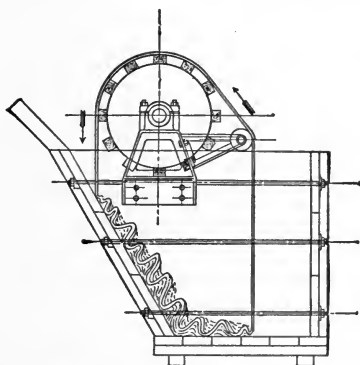

FIG. 201.—Dye Winch for Cloth.

obtained when the goods are kept entirely submerged beneath the dye-liquor during the dyeing process, in order to avoid the oxidation of the coloring matter on the fiber by exposure to the air, as otherwise precipitation of unfixed dyestuff is liable to take place and give rise to colors that will crock and bleed off in washing.

In the case of yarn dyeing the skeins may be kept beneath the liquor in ordinary open vat dyeing by the use of bent iron sticks (see Fig. 193). This system was largely used a few years ago, but at the present time with the use of more highly purified dyes, it is not considered so important, and the dyeing is more generally carried out in the ordinary manner with the use of straight sticks. Skein yarn may also be dyed on a revolving spider type of machine, constructed of iron throughout and so arranged that the goods are kept beneath the liquor.

In the dyeing of warps two general types of machines may be employed: first, a continuous dyeing machine in which the warps run through from

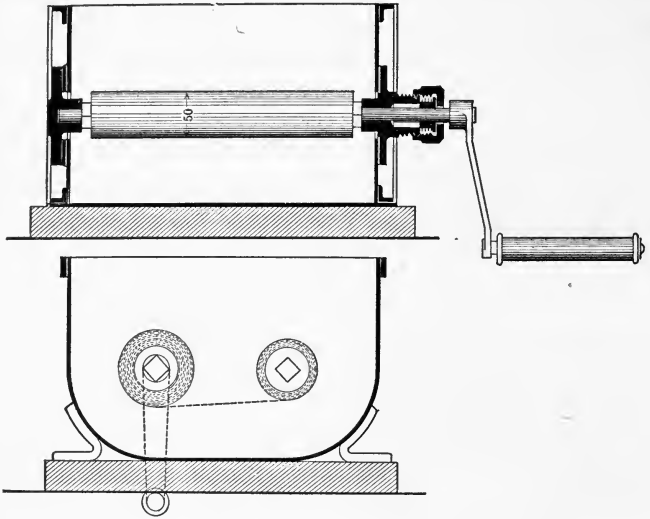

FIG. 202.—Small Jigger for Dyeing Samples with Sulphur Dyes.

end to end in rope form; and, second, beam dyeing machines, in which the warp is wound on a perforated beam and dyed by circulating the liquor

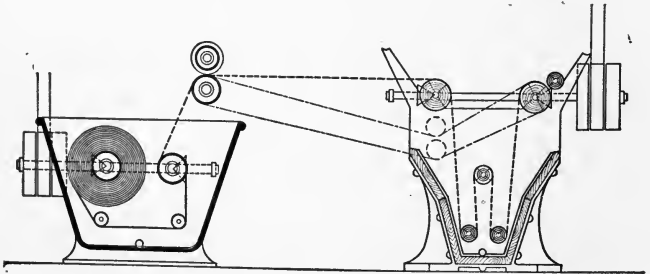

FIG. 203.—Submerged Jigger and Washer for Sulphur Dyes.

through the goods. The continuous-warp dyeing machines for sulphur colors are usually somewhat differently constructed from those machines

used for the dyeing of the ordinary substantive colors. They are usually arranged in the form of several dye-tubs separated by squeeze rollers, and the warps are run through singly without being doubled; each tub is

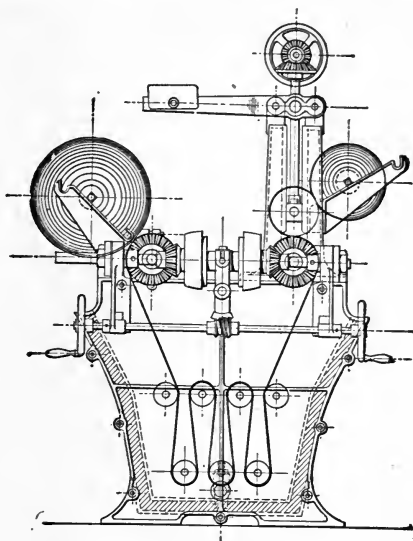

FIG. 204.—Jigger for Sulphur Dyes.

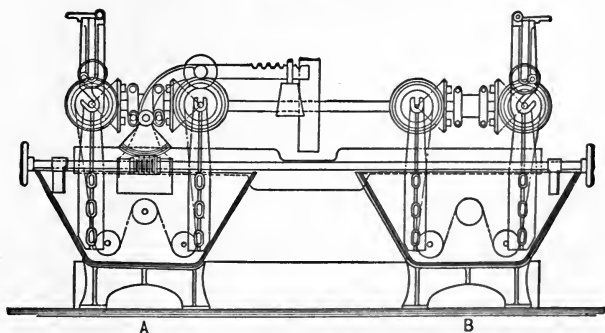

FIG. 205.—Double Jigger for Sulphur Colors.

provided with guide rollers, in some cases so arranged as to keep the goods beneath the liquor, while in other cases this feature is not insisted upon. Usually from six to eight warps, separated from each other by pot-eyes,

are run through the machine simultaneously. In the Fries machine the warps are first padded with the dye liquor, then run through a steaming

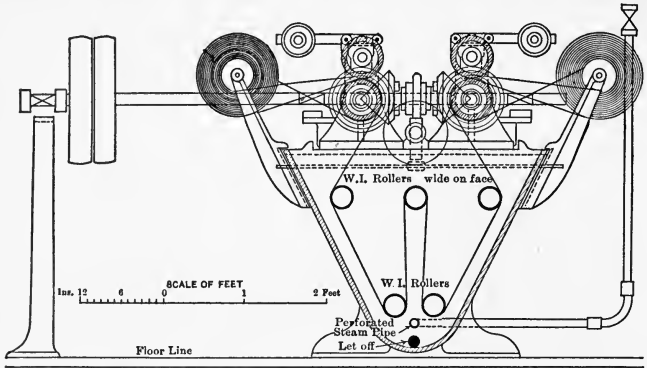

FIG. 206.—Padding Jigger for Sulphur Dyes. (Mather & Platt.)

chest to fix the dyeing, then through a washer, and finally over drying cans, thus making a continuous operation of the entire process (see Fig. 149).

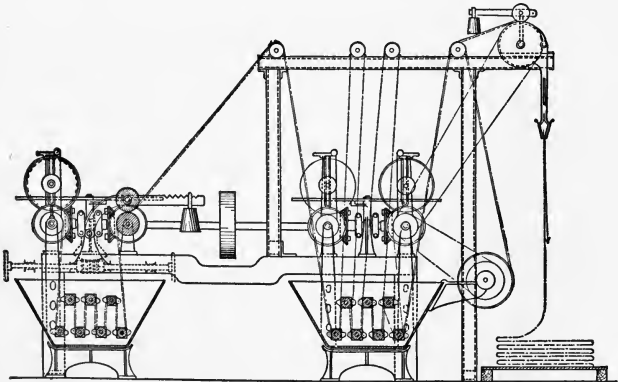

FIG. 207.—Double Jigger Rigged for Sulphur Blue Using Second Machine for Developing and Washing.

In dyeing warps on the beam the perforated beam is placed in a tank provided with suitable fittings and a pump so that the dye liquor may be forced by the pump from the perforated beam outward through the warp,

and then reversing the valve the liquor may be pumped in the opposite direction (see Fig. 197).

For the dyeing of piece-goods there are four types of apparatus: first, the ordinary dye-tub with winch (see Fig. 20,) ; this form, however, is very seldom used for sulphur colors; second, the jigger, which is very similar in construction to the ordinary jigger used for dyeing other colors; except for sulphur colors the tank and parts as well as the rollers are usually made of iron, and frequently the mechanism is so arranged that the cloth is kept entirely underneath the liquor (see Figs. 202 and 203). Also a set of two jiggers is frequently employed, the first being used for the dyeing and the second for the rinsing (see Figs. 204 and 205). Third, we have the continuous open-width dyeing machine, consisting of a series of several tanks provided with suitable guide rollers and nips (squeeze rollers); the construction is usually of iron throughout and the rolls are so arranged as to keep the cloth beneath the liquor. Fourth, the dyeing with sulphur colors is frequently carried out on a padding machine resembling a Foulard (see Fig. 206). This is used for rapid work where a

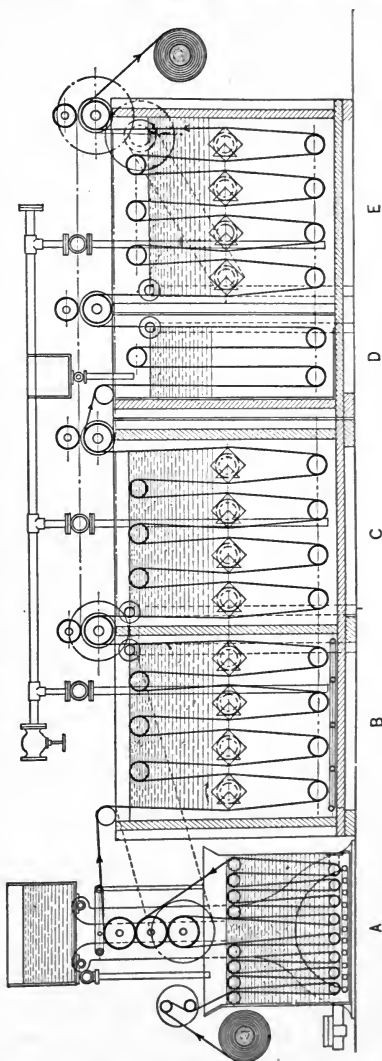

FIG. 208.—Padding Installation for Use of Sulphur Black, *A*, Padding Tank with Three Rolls; *B*, Warm Water; *C*, Cold Water; *D*, Acid Tank for Dilute Acetic Acid; *E*, Cold Water for Final Rinse.

surface dyeing only is permissible, and only for comparatively light shades. By steaming the goods afterwards better penetration and fixation of the dyestuff is procured.

Cotton raw stock is largely dyed with the sulphur colors for solid shades for the purpose of making mixes with white or other colors. On a small scale it is customary to dye the stock in an open tub or vat and circulate the material by poling by hand, such as is ordinarily practiced in the dyeing of other classes of cotton colors. On a large scale, however, it is generally the practice to employ an apparatus in which the dye liquor is circulated through the closely packed cotton, as in the type generally known as the Psarski dyeing machine (see Fig. 128). This machine is particularly adapted to the dyeing of sulphur colors, as there is but little

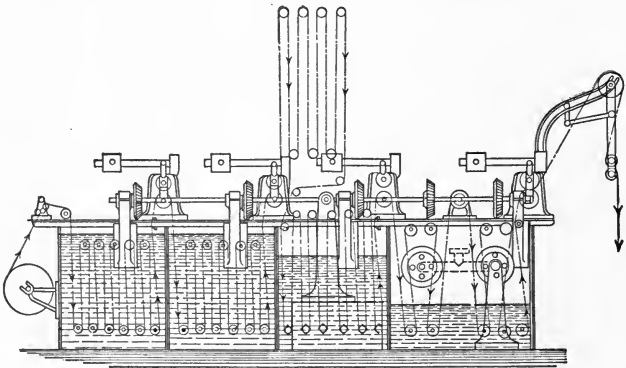

FIG. 209.—Continuous Dyeing Machine.

exposure of the liquor to the air, and furthermore a rather concentrated dye liquor may be used. After dyeing the material may be readily washed in the same machine.

Cotton yarns in package form, such as cops, tubes, and cheeses, may also be dyed very satisfactorily with the sulphur dyes in special forms of apparatus, such as already described under the methods employed for the dyeing of substantive colors.

It has also been suggested to employ foam dyeing with the sulphur colors. In this process an apparatus is used as shown in Figs. 212 and 213. A small quantity of concentrated dye liquor consisting of the solutions of dyestuff and sodium sulphide with additions of Turkey-red oil and soap is used in the bottom of the tank, so that the level of the liquor does not quite reach up to the bottom of the cage containing the cotton material

(yarns, cops, cheeses, etc.). The liquor, on being boiled vigorously, produces a great deal of foam, which comes in contact with the goods and causes the dyestuff to penetrate even such dense packages as cops and

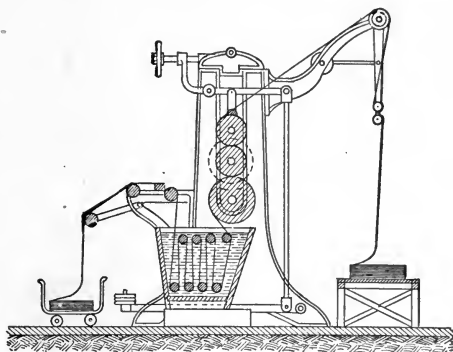

FIG. 210.—Dyeing Sulphur Colors on Foulard.

tubes. Usually direct steam is also used to produce a more copious foaming. The property of the dyestuff foam of penetrating the goods so as to yield even dyeings entirely through the mass of the material is rather

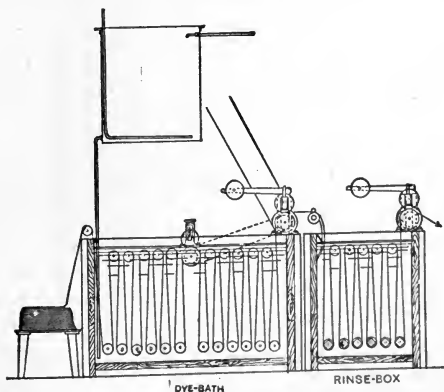

FIG. 211.—Dyebath and Rinse-Box for Sulphur Dyes.

remarkable, and is probably due to the surface tension of the foam bubbles. The same is also true when dyeing in ordinary cop dyeing machines, where

the liquor is to be sucked back and forth through the cotton; if some Turkey-red oil and a little soap are added to the bath it will tend to foam

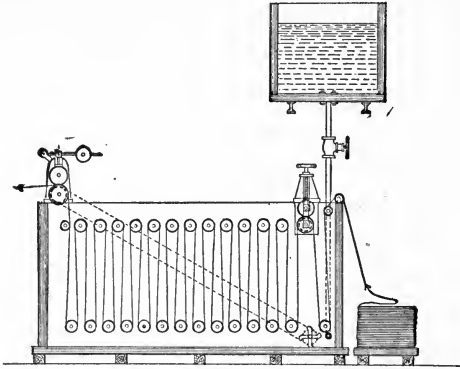

FIG. 212.—Dye Box for Continuous Dyeing Sulphur Colors.

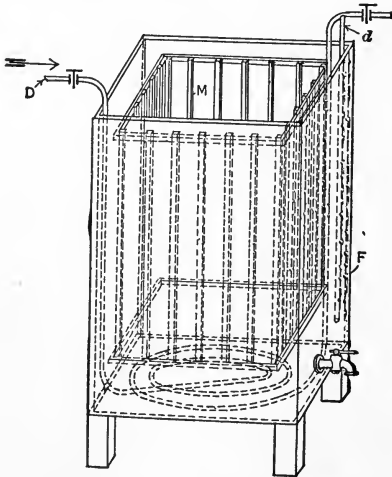

FIG. 213.—Apparatus for Foam Dyeing.

considerably on vigorous boiling, and the penetration of the color will be much more rapid and complete than would otherwise be the case.

8. List of Principal Sulphur Dyes

(a) Red

Auronal Corinth	Sulphur Corinth	Thiogene Purple
Immedial Bordeaux	Sulphurol Bordeaux	Thionone Corinth
Katigen Bordeaux	Thiogene Dark Red	

(b) Orange

Auronal Orange	Pyrogene Orange	Thionol Orange
Eclipse Orange	Sulphurol Orange	Thiophor Orange
Eclipse Phosphine	Thiogene Orange	Thioxine Orange
Immedial Orange	Thion Orange	

(c) Yellow

Auronal Yellow	Pyrol Yellow	Thion Yellow
Cross Dye Yellow	Sulphogene Yellow	Thional Yellow
Eclipse Yellow	Sulphur Yellow	Thionol Yellow
Immedial Yellow	Sulphurol Yellow	Thionone Yellow
Katigen Yellow	Thiogene Golden Yellow	Thiophor Yellow
Kryogene Yellow	Thiogene Yellow	Thioxine Yellow
Pyrogene Yellow		

(d) Green

Auronal Green	Katigen Green	Thional Brilliant Green
Cross Dye Green	Katigen Olive	Thional Dark Green
Eclipse Fast Green	Kryogene Olive	Thional Green
Eclipse Fast Olive	Nigrosulphine	Thionol Brilliant Green
Eclipse Green	Pyrogene Blue Green	Thionol Dark Green
Eclipse Olive	Pyrogene Dark Green	Thionol Green
Immedial Brilliant Green	Pyrogene Green	Thionol Olive
Immedial Dark Green	Pyrogene Olive	Thionone Green
Immedial Deep Green	Pyrol Green	Thiophor Dark Green
Immedial Green	Sulphogene Green	Thiophor Deep Green
Immedial Olive	Sulphur Olive	Thiophor Green
Immedial Yellow Olive	Sulphurol Dark Green	Thiophor Olive
Katigen Brilliant Green	Sulphurol Green	Thiophor Yellow Olive
Katigen Chrome Blue 5G	Thiogene Green	Thioxine Olive
Katigen Dark Green	Thion Green	

(e) Blue

Auronal Blue	Immedial Indone	Katigen Dark Blue
Cross Dye Blue	Immedial Indone Violet	Katigen Direct Blue
Eclipse Blue	Immedial New Blue	Katigen Indigo
Eclipse Fast Dark Blue	Immedial Prune	Katigen Navy Blue
Eclipse Violet	Immedial Pure Blue	Katigen Violet
Immedial Blue	Immedial Sky Blue	Kryogene Blue
Immedial Dark Blue	Immedial Violet	Kryogene Direct Blue
Immedial Direct Blue	Katigen Azurine	Kryogene Violet
Immedial Green Blue	Katigen Blue B	Melanogen Blue
Immedial Indogene	Katigen Chrome Blue	Pyrogene Blue

Pyrogene Cyanine
 Pyrogene Direct Blue
 Pyrogene Indigo Blue
 Pyrol Blue
 Pyrol Direct Blue
 Pyrol Navy Blue
 Sulphogene Blue
 Sulphur Blue
 Sulphur Indigo
 Sulphurol Direct Blue
 Sulphurol Indigo
 Thiogene Blue
 Thiogene Cyanine

Thiogene Dark Blue
 Thiogene Deep Blue
 Thiogene Direct Blue
 Thiogene Heliotrope
 Thiogene New Blue
 Thiogene Violet
 Thion Blue
 Thion Deep Violet
 Thion Direct Blue
 Thion Navy Blue
 Thion Violet
 Thional Blue
 Thional Indigo

Thionol Blue
 Thionol Brilliant Blue
 Thionol Dark Blue
 Thionol Dark Purple
 Thionol Direct Blue
 Thionone Brilliant Blue
 Thionone Indigo
 Thionone Navy Blue
 Thiophor Blue
 Thiophor Cyanine
 Thiophor Dark Blue
 Thiophor Indigo
 Thiophor Violet

(f) **Brown**

Auronal Black Brown
 Auronal Khaki
 Cachou de Laval
 Cachou R
 Cross Dye Brown
 Cross Dye Drab
 Eclipse Bronze
 Eclipse Brown
 Eclipse Red Brown
 Immedial Bronze
 Immedial Brown
 Immedial Cutch
 Immedial Dark Brown
 Immedial Maroon
 Immedial Red Brown
 Immedial Yellow Brown
 Katigen Black Brown
 Katigen Bronze
 Katigen Brown
 Katigen Chrome Brown
 Katigen Cutch
 Katigen Khaki
 Katigen Red Brown

Katigen Yellow Brown
 Kryogene Brown
 Kryogene Red Brown
 Pyrogene Brown
 Pyrogene Catechu
 Pyrol Bronze
 Pyrol Brown
 Pyrol Dark Brown
 Pyrol Red Brown
 Sulphanil Brown
 Sulphogene Brown
 Sulphur Brown
 Sulphur Catechu
 Sulphurol Brown
 Sulphurol Dark Brown
 Thiocatechine
 Thiogene Bronze
 Thiogene Brown
 Thiogene Cutch
 Thiogene Dark Red
 Thiogene Khaki
 Thiogene Olive
 Thiogene Yellow Brown

Thion Brown
 Thion Cutch
 Thion Violet Brown
 Thional Bronze
 Thional Brown
 Thional Dark Brown
 Thionol Brilliant Corinth
 Thionol Brown
 Thionol Corinth
 Thionol Khaki
 Thionone Brown
 Thionone Dark Brown
 Thionone Drab
 Thionone Khaki
 Thiophor Black Brown
 Thiophor Bronze
 Thiophor Brown
 Thiophor Dark Brown
 Thiophor Red Brown
 Thiophor Violet Brown
 Thiophor Yellow Brown
 Thioxine Brown
 Vulcan Brown

(g) **Black**

Anthraquinone Black
 Atlantic Black B, G, R
 Auronal Black
 Autogene Black
 Cross Dye Black
 Eclipse Black
 Immedial Black
 Immedial Brilliant Black
 Immedial Brilliant Carbone
 Immedial Carbone
 Indo Carbone

Katigen Black
 Katigen Blue Black
 Katigen Deep Black
 Kryogene Black
 Melanogen
 Mercaptol Black
 Osfathion Black
 Pyrogene Black
 Pyrogene Deep Black
 Pyrogene Gray
 Pyrol Black

Pyrol Blue Black
 Pyrol Brilliant Black
 Sulphanil Black
 Sulphenol Black
 Sulphogene Black
 Sulphur Black
 Sulphur Blue Black
 Sulphurol Black
 Thiocarbone
 Thiogene Black
 Thiogene Black Liquid

Thiogene Coal Black	Thionone Black	Thiophor Brilliant Carbon
Thiogene Diamond Black	Thionone Black Paste	Thiophor Carbon
Thion Black	Thionone Deep Black	Thiophor Deep Black
Thional Black	Thionone Printing Black	Thiophor Field Gray
Thionol Black	Thiophenol Black	Thioxine Black
Thionol Brilliant Black	Thiophor Black	Vidal Black
Thionol Gray		

9. Experimental. Exp. 142. General Method of Applying Sulphur Dyes.—Prepare a bath containing 5 per cent of Sulphur Brown, 5 per cent of sodium sulphide, 5 per cent of soda ash, and 25 per cent of common salt. Dye a skein of cotton yarn in this bath, entering at 140° F., gradually raise to the boil, and dye at that temperature for one-half hour; wash and dry. It will be noticed that the dyebath does not exhaust very well, so dye a second skein of cotton yarn in the same bath without adding any further dyestuff or chemicals, only diluting the bath to its original volume with water. Also dye a third skein in the same manner. Compare the colors on the three skeins, the gradation of which will show the comparative exhaustion of the bath.

Exp. 143. After-treatment of Sulphur Dyes with Chrome.—An after-treatment with chrome is sometimes given in order to obtain a faster color. Dye a skein of cotton yarn with 5 per cent of Sulphur Brown in the same manner as above described; squeeze, rinse, and treat in a fresh bath containing 2 per cent of chrome and 3 per cent of acetic acid; boil for fifteen minutes; wash well and dry.* Compare the color of this skein with the corresponding one in the previous experiment and note the effect of the after-treatment on the tone of the color. Also test the fastness of these two dyeings to washing and cross-dyeing.

Exp. 144. Obtaining Black with Sulphur Dyes.—Dye a skein of cotton yarn in a bath containing 10 per cent of Sulphur Black A extra, 15 per cent of sodium sulphide, 5 per cent of soda ash, and 50 per cent of common salt; enter at 140° F., gradually raise to the boil, and dye at that temperature for one-half hour; wash well, and treat in a bath containing 2 per cent of olive oil emulsion; then rinse and dry. Test the color of this skein for fastness to washing and cross-dyeing.

Dilute the above dyebath to its original volume with water, and without further addition of dyestuff or other ingredient, dye a second skein of cotton yarn. This will give the exhaust test of the bath and show the relative amount of dyestuff left behind in the dye liquor.

Prepare another dyebath as first given above with 10 per cent of Sulphur Black; dye a skein of cotton yarn, squeeze well so that the liquor runs back into the bath. Now add 6 per cent of dyestuff dissolved in an equal quantity (6 per cent) of sodium sulphide, 1 per cent of soda ash and 10 per cent of common salt. Dye a second skein in this bath, and compare the depth of color with the first skein. Make up the bath again adding 4 per cent of dyestuff dissolved in 4 per cent of sodium sulphide, but make no further additions of soda ash or salt. Test the bath to see if the dye is well dissolved by putting

* Other methods of after-treatment which have been recommended are as follows: (1) The dyeings are treated in a fresh bath for about one-half hour at the ordinary temperature with 3 to 5 per cent of zinc sulphate and 3 to 5 per cent of sodium acetate. This method is used with certain of the Sulphur Browns, and causes but slight change in the tone of color, but increases the fastness to washing. (2) Treat the dyed material in a fresh boiling bath for about one-half hour with 1 to 2 per cent of chrome and 1 to 2 per cent of bluestone and 3 per cent of acetic acid. This treatment is used on many of the Sulphur Browns, and while making the tone of color somewhat duller and darker, in many cases considerably increases the fastness to washing and light.

a drop on filter paper when it should not show any insoluble sediment. Dye a third skein in this bath and note if the color is equal to that of the first dyeing. In all cases dilute the dyebath with water to its original volume. After the last dyeing, and after proper dilution with water to the original volume, test the density of the bath with a hydrometer at a temperature of 160° F. Also take the density when the bath is cold.

Exp. 145. Use of Sulphur Blue.—Dye a skein of cotton yarn in a bath containing 5 per cent of Direct Sulphur Blue, 10 per cent of sodium sulphide, 5 per cent of soda ash, and 50 per cent of common salt. Enter at 140 to 160° F. and gradually raise to the boil, and dye at that temperature for three-quarters of an hour. Then squeeze, allow the skein to cool and rinse well, and dry.

Exp. 146. Use of Sulphur Blue Requiring Development.—Prepare a dyebath as before but use 5 per cent of Sulphur Blue L (or one of similar type) and one-half per cent of caustic soda in addition to the sodium sulphide, soda ash, and common salt. Dye a skein of cotton yarn in this as before: squeeze and then develop the dyeing by steaming.*

Exp. 147. Use of Sulphur Yellow.—Dye a skein of cotton yarn in a bath containing 5 per cent of Sulphur Yellow, 7 per cent of sodium sulphide, 5 per cent of soda ash, and 50 per cent of common salt. Enter at 140 to 160° F. and gradually bring to the boil. Dye at this temperature for three-quarters of an hour, then squeeze and wash well.

Exp. 148. Topping a Sulphur Dye with Basic Dye.—Dye a skein of cotton yarn as in Exp. 145 with 5 per cent of Direct Sulphur Blue, squeeze and rinse, and then top by dyeing in a fresh bath at 140° F. with $\frac{1}{10}$ per cent of Methylene Blue and 2 per cent of acetic acid. Notice the change in shade due to the topping and also test the fastness of the dyeing to washing.

Exp. 149. Dyeing Khaki with Sulphur Dyes.—Dye a skein of cotton yarn in a bath containing 5 per cent of Sulphur Khaki, 5 per cent of sodium sulphide, 2 per cent of soda ash, and 50 per cent of common salt. Enter at 160° F. and gradually raise to the boil and dye at that temperature for three-quarters of an hour. Squeeze and rinse and wash off in a weak soap bath at 160° F., and dry. Test this color for fastness to light and washing.

* If it is not convenient to carry out the development process by steaming, treat the dyed skein in a dilute bath of hydrogen peroxide, using 10 cc. of hydrogen peroxide (12-volume strength) to 300 cc. of water. For the development of some Sulphur Blues (like Sulphur Indigo and its type) it is advantageous to employ the following treatment: 1 per cent of chrome, 3 per cent of bluestone, and 5 per cent of acetic acid; work the dyed cotton in this bath for one-half hour at the boil; rinse well, and then rinse again in a bath containing 2 per cent of soda ash and 2 per cent of soap at 160° F.

CHAPTER XVIII

THE VAT DYES

1. Classes of Vat Dyes.—The vat dyes are so called because they are applied in a special kind of a dyebath in which the dye is reduced to a soluble form by means of a strong reducing agent, such as hydrosulphite.

The vat dyes are to be divided into several groups, depending upon their chemical nature and origin, as follows:

- (a) *Indigo*, including both natural and synthetic.
- (b) *Thio-indigo dyes*, containing sulphur.
- (c) *Indigo derivatives*, such as the brom-indigos; usually not derived directly from indigo itself, but built up synthetically.
- (d) *Anthraquinone derivatives*, including the various Indanthrene, Cibanone, Algol dyes, some Helindone, and others.
- (e) *Carbazol derivatives*, of which Hydrone Blue is the chief representative.

In a broad sense, all of the vat dyes at present known appear to be members of three distinct chemical groups:

(a) *Indigoids* including Indigo and its various derivatives such as the Thio-indigos, Helindone and Ciba dyes, and some of the red Algol dyes. The chemical constitution of this class is similar to that of Indigo. They may be applied in a neutral or slightly alkaline bath, and hence may be used for both wool and cotton dyeing. Their reduction products are pale yellow or almost colorless (similar to indigo), which exposure to the air re-oxidizes to the original color. As distinguished from the next class they are sublimed as colored vapors from the fiber when heated.

(b) *Anthraquinone dyes*,* including the Indanthrene, the Cibanone, and most of the Algol dyes. They are complex derivatives of anthraquinone and require a strongly alkaline vat in dyeing, consequently they are only useful for the dyeing of cotton. In common with all the dyes of the anthracene class their reduced compounds are not colorless but have about the same color as the original dye. When the dyed fiber is heated these dyes do not sublime or form colored vapors as with the indigoids.

(c) *Carbazol Dyes*, or Hydrone Blue.

With the exception of Indigo the vat dyes are all of comparatively recent introduction. The dyes themselves are highly insoluble in water,

* Of the different classes of vat dyes in a general way it may be said that the anthraquinone dyes are the fastest, the carbazol dyes are next and the indigoid dyes are the least fast. On the other hand, however, the indigoid dyes are easier to dye. Indigo is faster on wool than it is on cotton.

but readily yield products on reduction which are soluble in alkaline liquids. The dyebath, therefore, consists of a mixture of the dyestuff, a strong reducing agent and an alkali; and such a mixture is termed a "vat."*

The vat dyes at present include quite a wide range of colors; Indigo is a blue dyestuff, the thio-indigo dyes and their derivatives are mostly reds and scarlets, the anthraquinone dyes include blue, yellow, brown, green, violet, gray, orange, etc. The carbazol dyes are blue. The vat dyes are characterized in general by great fastness to light, washing, acids, alkalis, and in many cases to bleaching with hypochlorites.† This makes them very valuable products, especially for cotton goods, and they have been coming more and more into use, and show every indication of ranking

* The different classes of vat dyes vary considerably in their ease of application; the anthracene dyes are the most difficult to apply, while the indigoid and carbazol colors are much easier to dye, especially with regard to penetration and even colors. The halogenated anthracene dyes are much better in this respect than the non-halogenated dyes. The hydron series is the only one which includes a navy blue at a reasonable price, the other classes of colors have always been very high in price. In the dyeing of compound shades with the vat dyes there is frequently considerable difficulty experienced, especially in obtaining even colors. It may also be remarked that while the self shades of two colors may be fast, when dyed in mixture the compound shade may not be as fast, but on the other hand the opposite may also be true; Anthraflavone, for example, is not very fast as a self shade, but when dyed in combination with Indanthrene Blue the compound shade is very fast. It must also be remembered that some of the vat dyes are applied best at one temperature and some at another and in dyeing mixtures a proper balance of temperature must be maintained, as the correct temperature in the dyeing of vat dyes is of the utmost importance if the best results are to be obtained. The anthracene vat dyes require the use of more alkali in the vat than the dyes of the indigoid or hydron series (about four times as much), but on the other hand they require much less hydrosulphite. The amount of caustic soda to be used, strange to say, is to be calculated on the volume of the liquor employed and not on the amount of dyestuff used, so that in dyeing a light shade just as much caustic soda is required as for a heavy shade. In using a mixture of vat dyes for the production of compound shades it is always best to first reduce each dyestuff separately and then mix them in the dyebath.

† Though the vat colors in general are fast to bleaching with hypochlorite liquors (known as fast to chlorine), they do not as a rule withstand kier-boiling with caustic soda (an operation which usually precedes bleaching). Their fastness in this respect has been found to be improved by boiling with sodium perborate. It has also been found that by introducing a small quantity of potassium bromate ($\frac{1}{4}$ oz. per gallon) into the kier liquor, the bleeding of the color may be largely prevented. The use of a small amount of anthraquinone is also employed for the same purpose.

In kier-boiling cotton pieces containing yarns dyed with the vat colors it will sometimes be found that the goods at the bottom of the kier will be stained by the marking off of the color. This is supposed to be due to the fact that the alkali in the kier liquor together with the impurities removed from the cloth form a sort of local vat which reduces and dissolves the color, thus allowing it to run. Certain products, such as *Ludigol* (meta-nitro-benzene-sulphonic acid) have been recommended as additions to the kier to prevent the staining of the goods, but it is a question as to whether they successfully accomplish this purpose.

as the principal cotton dyes of the future. As they are rather difficult to manufacture and require complicated processes in their preparation, the vat dyes are quite expensive, and on this account are used chiefly for the dyeing of raw cotton or yarns to be used for colored stripes in otherwise white fabrics, so that only a relatively small amount of dyed yarn is used in the total fabric.

Though the vat dyes may be applied to all fibers they are more suited to the dyeing of cotton, as most of them require a rather strongly alkaline dyevat.* The material to be dyed is simply immersed in the "vat" or dyebath until the goods are thoroughly impregnated with the solution. The material is then squeezed and exposed to the air, which causes the oxidation of the reduced "leuco" compound and the formation of the color. The temperature of the vat is usually lukewarm for the purpose of

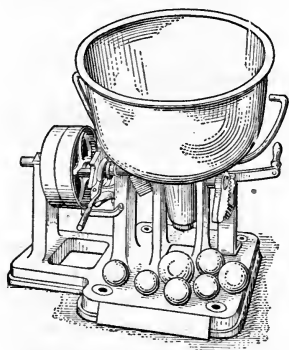

FIG. 214.—Indigo Mill. (Ball Form.)

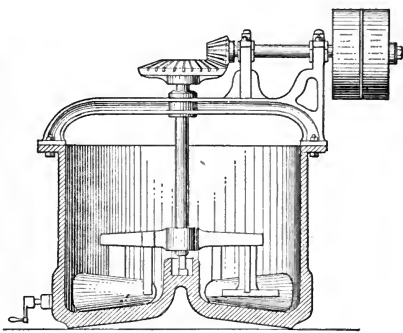

FIG. 215.—Indigo Mill. (Cone Form.)

facilitating the impregnation of the fiber with the solution. In some cases the dipping and oxidation have to be repeated several times in order to build up a heavy color.

The vat dyes have come to be very essential dyes for cotton, as it is only by the use of these dyes that laundry-fast colors in cotton wash-fabrics can be obtained. They are necessary dyes for the production of colors in shirtings, blouse material, cotton skirtings, and hosiery and such fabrics or garments that require to be frequently laundered. No

* The vat dyes in some cases have been proposed for use with wool, but owing to the fact that the vat is strongly alkaline with caustic soda it is difficult to apply properly the color to wool. Most of the vat dyes show no affinity for wool below a temperature of 160° F., and glue or sulphonated oil soap must be used in the bath to protect the fiber from the action of the alkali; furthermore in order to obtain fast colors it is necessary to boil the dyed goods in sulphuric acid to destroy the hydrosulphite, and this is a great disadvantage.

other class of colors will stand the bleaching effect of the hypochlorite liquors used in whitening cotton goods in the modern laundry. There are but few other dyes with this property (Chloramine Yellow). It was on the great fastness of the vat dyes that the reputation of the excellent quality and fastness of the German-made dyes became so strongly fixed in the mind of the public. Many of the vat dyes are faster than Indigo, though of course this latter dye is itself to be considered but a member of the general class of vat dyes.

In the practical use of the vat dyes it is usually the custom to first prepare a stock vat or solution of the reduced dyestuff, and this is used in such quantities as may be necessary for there plenishing of the dyevat. In the preparation of this stock solution the following is a typical method:*

100 lbs. of dyestuff (which is generally in the form of a paste containing 20 per cent of dry dye);

20 gallons of water at 160° F.;

2-6 gallons of caustic soda solution of 76° Tw.;

10-40 lbs. of hydrosulphite powder (anhydrous sodium hydrosulphite).

The exact amounts of hydrosulphite and caustic soda will depend on the particular dyestuff employed. Very frequently some Turkey-red oil (or similar sulphonated soluble oil) is also added.

The vat is best made up in a wooden barrel or tank fitted with a steam pipe so that the contents may be maintained at a temperature of 160° F. until the reduction is completed, which usually requires about one hour or somewhat less. The solution may then be made up to 40 or 50 gallons with water and is ready for use. It is important that the water employed for both the stock solution and the dyevat should first have the dissolved air corrected by the addition of a little hydrosulphite and caustic soda; 100 gallons of water will usually require about 4 ozs. of caustic soda and 3 ozs. of hydrosulphite. As far as possible soft water should be used. The

* Whittaker gives the following typical vats for the three classes of vat dyes:

Anthracene Series.....	{	10 per cent Chloranthrene Blue BD (10 per cent paste)
		30 per cent caustic soda (76° Tw.)
		2½ per cent hydrosulphite powder conc.
Indigoid Series.....	{	2 per cent Ciba Blue 2R powder
		7 per cent caustic soda (76° Tw.)
		7 per cent hydrosulphite powder conc.
Carbazol Series.....	{	6 per cent Hydron Blue G paste
		6.6 per cent caustic soda (76° Tw.)
		6 per cent hydrosulphite powder conc.

The color should first be stirred up to a smooth paste with the caustic soda, hot water added, and then the hydrosulphite. In some cases it may be found necessary to heat the liquor even to the boil in order to obtain a complete solution.

purpose of the correction is to remove the dissolved oxygen and the hardness in the water so as to avoid precipitation of the dyestuff.

The stock solution must be preserved from undue exposure to the air, otherwise dyestuff will be precipitated and cause bad shades. This same precaution also applies to the dyevat. The latter is prepared by heating the necessary volume of water to about 100° F., adding the necessary amount of caustic soda and hydrosulphite required to counteract the dissolved oxygen, and then adding the required amount of the stock dye solution. The vat is then gently stirred and allowed to rest awhile before use for dyeing.*

When yarn is dyed it should first be well boiled-out, and if open dye vats are used the yarn should be entirely submerged beneath the liquor by being hung on bent iron rods similar to those recommended for use in the dyeing of sulphur colors (see page 376). In dyeing yarn it is also important that it should be evenly wrung out after steeping in the vat, and more even results are always obtained if several dips are given. After dyeing and wringing the yarn is then exposed to the air for about thirty minutes to oxidize completely the leuco-compound to the dyestuff. It is then boiled in a bath containing about 2 lbs. of soap per 100 gallons of liquor.† This is for the purpose of completely developing the color and removing all unfixed dyestuff, which would otherwise dull the shade and cause crocking.

On account of the difficulty of obtaining even shades and good penetration of color, it is more satisfactory to dye vat colors in the loose stock rather than on yarn or piece-goods. By dyeing yarn in the form of warps, however, very good results can be obtained. When dyeing loose stock it is

* In the preparation of the dye bath with the vat dyes it is sometimes a question as to when the proper degree of reduction is obtained. With some dyes the reduced or leuco-compound is of a different color than the dye, and in this case it is easy to determine if the vat is completely reduced; for instance, Chloranthrene Yellow gives a reduced vat which is blue in color. On the other hand, some of the dyes give vats of the same general color as that of the dye, and it is difficult to tell just when the color is reduced by the appearance of the vat. Chloranthrene Blue, for example, gives a reduced vat which is also blue in color. To determine if reduction in such a case is complete Whitaker recommends drawing out some of the vat liquor in a pipette and allowing it to run slowly down the side of a clean test tube held against the light; if the dye is reduced the liquor will show clear, but if it is not completely reduced undissolved particles of color will be detected in the liquid. With the blues of the indigoid class, like Ciba Blue, the reduced vats are bright golden yellow in color and consequently there is little difficulty in ascertaining when reduction is complete.

† Owing to the large amount of caustic alkali used in the bath with the vat dyes, after dyeing the cotton the goods must be soured in a weak acid bath to neutralize the alkali, then washed, soaped well and washed again before drying. The soaping is a very necessary operation, as it both develops and brightens the shade, besides softening the goods and ensuring neutralization of all acid.

well to employ some form of dyeing machine which will permit of the dye liquor being circulated through the material with a minimum exposure to the air. Piece-goods may be dyed on the jigger, preferably on that form in which the goods are kept entirely immersed, otherwise the piece will become oxidized at the edges and may show lists or streaks.

The vat colors in general are well adapted for machine dyeing of cops, tubes, warps, etc. In Europe, Indigo (and the rest of the vat dyes) is very largely dyed in this fashion, there being in extensive use a number of special forms of cop dyeing machines for this purpose.

2. Indigo.—Indigo is probably the most important and most extensively used single dyestuff both of antiquity and of the present time. Historically considered it is one of the oldest dyestuffs known, and appears to have been first employed in India and Egypt. It was not introduced into Europe until late in the Middle Ages, but previous to this time another plant of the same character known as *woad* had long been used in dyeing.* The Portuguese first introduced Indigo into European trade under the name *anil*, a word derived from the Sanskrit name *nila*, meaning indigo or blue. It is interesting to know that aniline thus derived its name from Indigo, as it was first prepared by the distillation of this dyestuff.

The dyestuff Indigo is derived from a number of plants of the *indigofera* or *isatis* variety, but its principal commercial sources are the following: *Indigofera tinctoria*, *I. anil*, *I. disperma*, *I. argenticia*.

The coloring principle present in Indigo is known as **indigotine** or indigo-blue. The crude product derived from the plant, however, contains several other bodies in varying amounts, † such as **indirubin** (or indigo-red), ‡

* Woad is still used to some extent in the preparation of certain vats, but only in connection with Indigo, and never by itself.

† Of the various associated substances in natural Indigo, the only one of interest to the dyer is the indigo-red or indirubin. This may be present to the extent of 15 per cent. It may readily be isolated from the natural Indigo by treating first with dilute sulphuric acid, then with caustic potash and finally washing with boiling alcohol. The first two treatments remove the indigo-gluten and the indigo-brown, while the indirubin is dissolved by the boiling alcohol, from which it precipitates on cooling as a reddish brown powder. With the exception of its color and its solubility in boiling alcohol, indirubin is very similar to Indigo; like the latter it dissolves in concentrated sulphuric acid and may be converted by reducing agents into a leuco-compound soluble in alkalis. In other words it forms a vat like Indigo, but its reduction is slower. This explains why certain kinds of Indigo having a high content of indirubin are harder to reduce than other varieties of Indigo having less indirubin. The presence of indirubin also exerts a physical influence on indigo, and the same is also true of the indigo-gluten and indigo-brown. The presence of these ingredients makes the Indigo hard; the smaller the quantities of these materials in the Indigo, the softer and the more readily powdered and reduced will the product be.

‡ The redness noticed in heavy shades of Indigo is not due to the presence of indigo-red, but is due to the physical form of the Indigo particles deposited in the fiber.

indigo-brown, indigo-gluten and some mineral matters.* In the plant itself the coloring matter is supposed to exist in the form of a glucoside called **indican**. The process of extraction of the dyestuff from the plant is both interesting and complicated. The indigo plant, which is a shrub growing 3 to 4 ft. in height, is cut in summer.† The cut plants are tied up in bundles and packed into long vats, which are then filled with water; in a short time fermentation sets in which is allowed to continue for ten to fifteen hours. This process converts the indican of the plant into soluble matters which are extracted from the plant by the water and pass into solution.‡ The liquor is then run into another vat, placed at a lower level, and here it is churned and beaten up either by hand or mechanically for the purpose of exposing it to the oxidizing action of the air, whereby the insoluble indigotine is formed and precipitated out. This collects at the bottom of the vats in the form of a paste or mud which is washed, filtered, pressed into cakes, and dried. This constitutes the raw indigo of trade, and comes in the form of large cubical blocks. The best natural Indigo comes from Java and Bengal, and contains from 60 to 75 per cent of coloring matter. Madras Indigo is usually somewhat inferior, while that from Guatemala, China, Africa, and Egypt is very variable.

The raw indigo of trade is a dark blue, earthy-looking substance. When scratched with the finger nail good qualities will exhibit a coppery streak. At the present time a great deal of the crude Indigo undergoes a refining process, for the purpose of eliminating the many impurities liable to occur in the raw product; it also comes into trade ready ground either as a powder or a paste in order to facilitate its use by the dyer.§

* In the first competition of synthetic Indigo with the natural product, it was claimed that the presence of these other bodies in the latter gave it more desirable properties than the synthetic. Careful and unprejudiced examination of these claims, however, has demonstrated the fact that these associated bodies must be regarded solely as impurities and have little influence on the resulting color, as they are practically all eliminated in the wash waters after dyeing or are decomposed into inert bodies in the vat. This fact is also apparent in that refined Indigo (from which these bodies have been removed) is preferred by the dyer to the crude material. It seems to be amply demonstrated that the sole value of Indigo is in the indigotine that it contains. Synthetic Indigo, being of a very high degree of purity, usually gives somewhat clearer and brighter colors than the natural dye.

† Two crops are usually gathered from the same plants each year.

‡ The Indigo is extracted chiefly from the leaf of the plant; this contains, on the average, about 0.5 per cent of coloring matter.

§ Before Indigo can be used by the dyer for purposes of reduction it must be ground to a very fine impalpable powder. In former times where the natural Indigo was bought in the form of blocks or lumps it had to be ground in special indigo mills for a long time. This accounts for the fact that it is now so much used in the form of a 20 per cent paste (with water or glycerin). Synthetic Indigo is practically altogether marketed in the form of such a paste, as it is then ready for direct use in preparing the stock solution of indigo-white.

The principle of indigo dyeing has always differed entirely from that of other classes of dyestuffs, and has constituted an art by itself. Indigo is perfectly insoluble in water, and hence cannot be applied in dyeing in this form.

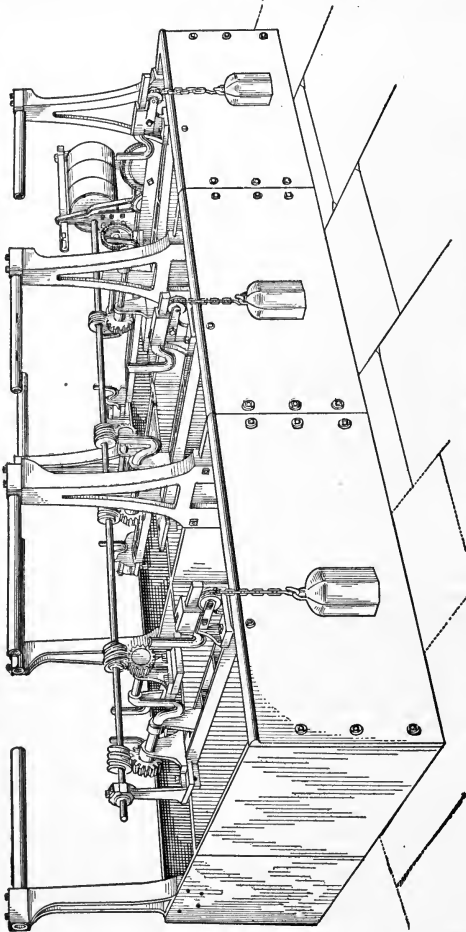

FIG. 216.—Skein Dyeing Machine for Indigo. (Spencer.)

By the action of various reducing agents, however, it may be converted into a substance known as **indigo-white**, which is soluble in alkalis; in this form it is applied to the fiber, and by subsequent oxidation by simple

exposure to the atmosphere, the indigo-white is readily converted back to the insoluble blue indigotine, which thus remains permanently fixed in the fiber.* Indigo may also be converted into a soluble blue coloring matter by treatment with strong sulphuric acid. This body, known as **Indigo Carmine**, or indigo sulphonate, may be classed as an ordinary acid dye-stuff, being applied in the usual form of acid dyebath; but it does not possess the great fastness and other valuable properties of Indigo itself.

3. Methods of Dyeing Indigo.—Indigo is extensively used for both wool and cotton dyeing, though it is being used proportionately less for the dyeing of wool since the introduction of the fast alizarine and anthracene blue dyes. It is not much employed for the dyeing of silk. In calico printing it has an extensive application, principally for discharge styles. The vats used for cotton dyeing are generally more strongly alkaline than those for wool, while the proportion of Indigo used in them is also higher. In cotton dyeing, too, the vats are usually worked cold. Indigo dyeing is known as “vat” dyeing because it is carried out in a specially prepared vat. According to the character of the reducing agent employed, these vats are classified as follows:

Zinc vat,	Fermentation vat,
Hydrosulphite vat,	Copperas vat.

The fermentation vat is the oldest form of indigo dyeing, and is still used to a considerable extent for wool dyeing. Its action depends on the chemical activity of certain ferments which reduce the indigotine to the soluble indigo-white. This vat is used warm, while the other vats are usually worked cold.†

The copperas vat was the earliest form of chemical vat; it was exclusively adopted for cotton. At the present time, however, it is almost obsolete. The reducing agent employed was copperas, or ferrous sulphate.

The zinc vat was formerly the favorite one employed for cotton, and even at the present time it is quite largely used. The reducing agent employed is an alkaline solution of zinc dust.

* Indigo is apparently fixed on the fiber mechanically; that is to say, the coloring matter is deposited in the fiber in a fine state of division; if the color is deposited too rapidly it will lack fastness, especially to rubbing. Hence it is not advisable to use concentrated vats for dyeing heavy shades of Indigo, but to build up the color by means of several successive dips in weaker vats.

† Wool reacts somewhat differently with the reduced Indigo in the vat than cotton. The former, on account, perhaps, of its somewhat alkaline character, has considerable affinity for the acid indigo-white and consequently fairly deep shades of good fastness can be obtained with one dip on wool. Cotton has much less attraction for the reduced indigo and takes up a much smaller quantity of the dye. It is customary, therefore, to dye wool in the warm (fermentation) vat, while cotton is dyed in a cold vat as its affinity for the dye decreases as the temperature rises.

The hydrosulphite vat is the one of latest origin; it is employed very largely at the present time for all classes of indigo dyeing both on wool and cotton. The reducing agent employed in this vat is sodium hydrosulphite, NaHSO_2 , prepared by the action of zinc dust on sodium bisulphite. It is gradually replacing the other forms of vats as it is the most simple and scientific and the most easily regulated.*

The alkali used for dissolving the indigo-white is the same for all forms of vats; it may be either lime or caustic soda, or a mixture of the two, depending upon whether the vat is to be employed for wool or cotton dyeing. Ammonia does not appear to dissolve indigo-white very readily, and the alkaline carbonates are still less suitable.

Indigo-white behaves like a very weak acid, and it requires an excess of rather strong caustic alkali to bring it into solution, and it is readily precipitated again by the addition of any acid. On this account the vat must always be kept alkaline.

Before Indigo is introduced into the vat (of whatever variety) it must be in a very finely divided state, otherwise the reduction will always be incomplete. The grinding of Indigo is a rather important consideration; it is usually first ground in the dry state, and then ground a second time with a little water (to which a small amount of alkali may be added) to the form of a paste. Indigo paste of this character may be purchased in the market by the dyer, and may be added to the vat directly; it should contain 20 per cent of indigotine.

During the reduction of Indigo in the vat, the process is usually accompanied with secondary chemical reactions varying in their nature and degree with the character of the vat. This results in the conversion of smaller or larger amounts of the dyestuff into substances other than indigo-white and a resultant loss of coloring matter. This is especially large in the copperas vat, it also amounts to considerable in the fermentation and zinc vats; in the hydrosulphite vat it is reduced to a minimum of about 2 per cent.

Indigo vats when used for dyeing should not have a concentration of more than 3 parts of indigotine per 1000 parts of liquor. More than this tends to the production of shades which are liable to crock and also lose in washing. The vat must also possess an excess of reducing agent. This may act in several ways. It prevents the premature oxidation of the indigo-white arising from the vat liquor coming in contact with the air or water in the pores of the material being dyed, and so prevent or retard the

* The time required for the reduction of the Indigo in the various vats is about as follows:

Copperas vat.....	two to three hours
Zinc-lime vat.....	four to five hours
Hydrosulphite vat.....	one-half to one hour

penetration of the indigo-white. Again, the more thoroughly the indigo-white in the vat is reduced the more completely will it work its way into the material and the faster will be the color. A certain excess of reducing agent is also of advantage in the subsequent oxidation of the indigo-white to indigo-blue, as then the action of the oxygen is slower and more uniform, giving better penetrated colors and also causing the dyestuff to be precipitated in a finer state of division, which results in faster and better colors. If there is not sufficient excess of reducing agent in the vat, on washing after dyeing and oxidizing a large part of the color will be removed, whereas if more reducing agent were present, the loss on washing should be very little.

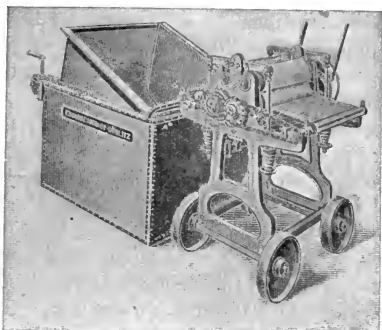

FIG. 217.—Machine for Dyeing Loose Stock with Indigo and Vat Colors.

The fastness of Indigo is said to be improved by an after-treatment with bluestone and acetic acid. The use of glue in the vat also has the same effect.*

Indigo is frequently bottomed by first dyeing with certain substantive or sulphur dyes; and indigo blue on cotton may be topped by dyeing with basic colors; the goods after dyeing in the vat being mordanted with tannin, fixed with tartar emetic and dyed.

Redder shades may be obtained with Indigo on cotton by steaming after dyeing in the vat, but this somewhat decreases the fastness to washing. Heavier shades may be obtained by first mercerizing the cotton

* Treatment with bluestone causes the shade to become somewhat greener. In using the glue treatment it is recommended to pad the cloth previous to dyeing with a solution of glue ($1\frac{1}{2}$ to $2\frac{1}{2}$ ozs. per gallon). This causes the shade to be brighter and redder and increases the fastness to rubbing.

By passing the cloth before dyeing through a solution of Turkey-red oil and alumina the fastness to alkali and chlorine is much increased.

by treatment with a strong solution of caustic soda.* The mercerized fiber shows a greater attraction for the Indigo than the untreated cotton. In order to save Indigo it has been suggested to mercerize only one side of the cloth to be dyed, and when this is run through the vat the mercerized side will dye up much darker than the other.†

With improvements in mechanical devices it has become possible to dye Indigo on cotton in the form of cops, tubes, cheeses, beamed warps, etc. In such machines the material remains stationary and the indigo vat liquor is forced through the fiber. Only the hydrosulphite vat can be used for this purpose as there must be no sediment or undissolved particles, because the cotton material in this case acts as a filter to the liquid. Therefore great care must be taken in preparing the vat for this method of dyeing. Special apparatus must be used for dyeing Indigo (and the other vat dyes as well) differing from that employed for the ordinary dyestuffs, as provision must be made to draw air through the dyed material in order to oxidize the color.

In piece dyeing two forms of indigo vats are used: (a) immersion vat, and (b) continuous vat. In the first form of vat sinking frames are used on which the goods are spirally attached by means of hooks. These frames are immersed in the vat for the required time, then lifted out and exposed to the air for oxidation, when another dip is given until the required depth of color is obtained. Usually between each dip the frame is turned bottom up so as to get even dyeings. Immersion vats are chiefly used for heavy goods that do not readily dye through, for the frame may be left in the liquor for any length of time necessary, whereas in continuous dyeing machines this is not possible. Heavy linens, moleskins, and such fabrics are often left in the vat overnight, or even for several days in order to obtain proper penetration. Immersion vats are also used for goods to be dyed on one side of the piece only; in such a case two pieces are fixed back to back on the frame. When the dyed pieces are exposed to the air only the outer sides are oxidized and the Indigo is chiefly developed there, the other side being dyed a considerably lighter shade. For dyeing on immersion frames the zinc vat is more suitable than the hydrosulphite vat, as the

* To produce full shades of blue the Höchst Co. recommend passing the goods, before dyeing in the vat, through a solution containing 1 to 1½ lbs. of starch to 100 gallons of water.

† For producing very heavy shades of Indigo cotton is sometimes first dyed with a weak Aniline Black, as follows: For 100 lbs. of cotton yarn, work for one hour at 100° F. in a bath containing 3½ lbs. aniline salt, 3½ lbs. sodium bichromate, and 7 lbs. of hydrochloric acid; wring out well and treat in a fresh bath with 1½ lbs. of soda ash for one-half hour at 100° F. Then rinse twice and hydro-extract and dye in the indigo vat. In this way very coppery shades of blue may be obtained with very little Indigo. Instead of using Aniline Black a light shade of manganese bronze may also be employed as a bottom.

latter contains hydrosulphite and caustic soda, which cannot be squeezed out in this case after dyeing, and consequently uneven colors are liable to result.*

In continuous machines the pieces are run through successive vats and exposed to the air for oxidation between the dips. Usually four to six vats are employed in one range so as to obtain heavy shades. The hydrosulphite vat liquor is most generally employed for this form of continuous dyeing, as there is no sediment and the vat is easily regulated. The

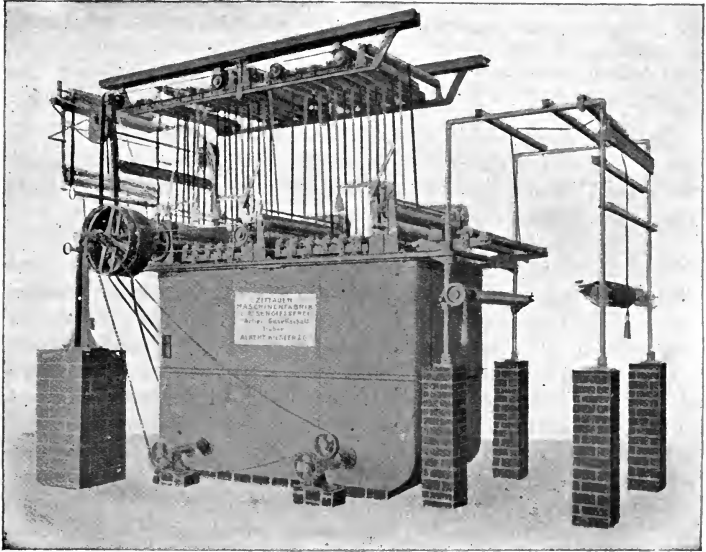

FIG. 218.—Dyeing Machine for Indigo and Vat Dyes. (Zittauer.)

depth of color may be regulated by varying the speed of running and the number of immersions. It is always preferable to enter the goods in the wet state. By drying the goods first after dyeing and then souring and washing heavier shades of blue are obtained.

4. Fermentation Vat.—The essential ingredients of the fermentation vat are: Indigo, lime, woad, bran, and madder. The woad furnishes the proper kind of ferment for the reduction of the Indigo, the bran and mad-

* In dyeing carbonized wool or shoddy in the indigo vat care must be had to have the goods thoroughly neutralized with soda before entering the vat, as any acid in the wool may cause disturbances in the vat by neutralizing the alkali.

der serve as nourishment for the growth of the ferment, while the lime serves to neutralize the acids liberated during the fermentation and also furnishes the alkali necessary for the solution of the reduced Indigo.

There are, however, a large variety of substances used in the preparation of the fermentation vat, and almost every indigo dyer has his own special formula, but the essential ingredients are those given. According to the make-up of its constituents, the fermentation vats are classified as follows:

Woad vat, constituted as above outlined.

Urine vat, containing urine as an active source both of fermentation and alkalinity; at present almost obsolete.

Potash vat, in which potash is used as the chief alkali.

Soda vat, also known as the German vat, in which soda is the chief alkali used.

In Eastern countries all manner of substances are added to the indigo vat for purposes of aiding the fermentation or supplying nourishment to the ferment; among some of these substances may be enumerated dates, raisins, honey, plant seeds, glucose, etc.*

(a) *Saxon vat*.—This is one of the earliest forms of Indigo dyeing in Europe, and is still practiced in the same primitive manner by the peasants of Saxony, where the celebrated Saxon blue is dyed. The following experiment will illustrate this method: Take 10 grams Indigo paste (20 per cent) and mix with 10 grams potash dissolved in 50 cc. water; place 50 grams raw unscoured wool in a wooden or earthenware vessel, and pour over it the above solution, sufficiently diluted to just cover the wool. Set aside in a warm place for a week or ten days. A moderate fermentation sets in which causes the reduction of the Indigo, which is absorbed by the wool, and thus the dyeing is accomplished. When sufficiently colored, remove the wool, squeeze, allow to oxidize in the air, and finally wash in a soap solution. The shades obtained in this manner are especially beautiful, and they are highly prized on account of their fastness to rubbing.

(b) *Woad vat*.—It is very difficult to obtain any very satisfactory results on a small experimental scale with the fermentation vat, but the following will illustrate the method of setting this vat: Place 6 liters of water in a wooden or stoneware vessel and heat to about 160° F.; add 50 grams of woad previously broken up and soaked for several hours in a little warm water; next stir in 20 grams bran, 8 grams soda ash, 3 grams lime, 20 grams madder, and 12 grams Indigo paste (20 per cent). Stir well, and then cover with a cloth and allow to stand in a warm place for twenty-four hours. During this time the fermentation has become quite active; the liquor should be yellowish in color and be covered with a light

* Cotton dyed in the fermentation vat acquires a peculiar "indigo smell" which is insisted upon by buyers in some countries.

blue froth. It should now be stirred up well, and if any large quantity of gas is given off, a little lime should be added; after which it is again covered and left to ferment for a few hours more. When the reduction of the Indigo is complete, the liquor of the vat will be yellow in color with the surface covered with a dark blue layer, which if skimmed off should be granular in appearance. During dyeing the vat should be maintained at a temperature of 120° F. If the vat does not have a satisfactory appearance, a little more lime should be added, the liquor stirred up, and then covered and allowed to stand for a couple of hours.

When the vat has been brought to a proper condition, steep a handful of well-scoured wool in the liquor for a few minutes. On being taken out the wool should be of a greenish yellow color; squeeze and expose to the air until the blue color is completely developed, then wash in a warm soap bath. The latter treatment should cause the wool to lose but a small amount of color. In dyeing, care should be taken not to disturb the sediment in the vat, otherwise streaked and uneven colors will result. The vat may now be used for dyeing a variety of woolen material (loose wool, tops, yarn, and woven pieces). Heavier shades may be produced by giving several dips in the vat, squeezing and oxidizing in the air after each dip. Care should be taken not to agitate the liquor too much, as otherwise it will rapidly oxidize and turn blue, and no longer be fit for dyeing. The vat should be contained in a tall-shaped vessel, as about one-third of the vat is made up of the sediment which it is not desirable to disturb while dyeing.

The vat may be maintained continuously for a long period of time. After being worked for some time it becomes partially exhausted and oxidized; then a little glucose (syrup), bran, madder, and lime may be added together with more Indigo paste. It is well stirred up, covered over, and allowed to stand for several hours or overnight, when it is again ready for dyeing. For good results the amount of Indigo in the vat should not rise above 3 parts per 1000.

The woad vat is also known as the "bastard" vat, and the proportion of its ingredients may vary considerably. On a large scale the following proportions are recommended:

Content of vat 600-800 gallons.

- Woad.....	50 lbs.
Bran.....	20 lbs.
Soda ash.....	8 lbs.
Lime.....	3 lbs.
Madder.....	20 lbs.
Indigo paste (20 per cent).....	12 lbs.

If solid Indigo is used only about 2¼ to 4 lbs. should be used; but in this case the dyestuff should be very carefully ground in a ball or roller mill

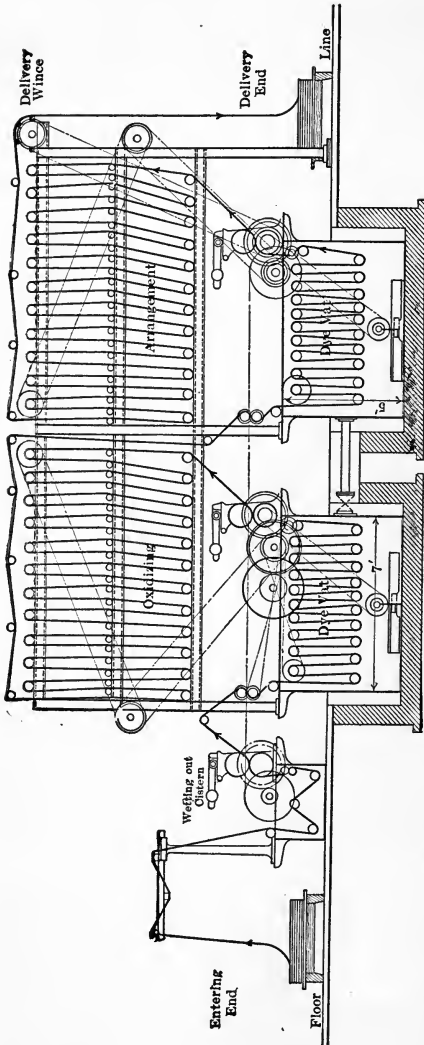

FIG. 219.—Indigo Dyeing Range with Overhead Oxidizing. (Mather & Platt.)

for twenty-four to forty-eight hours together with a little caustic soda and water. This is to insure its being converted into an impalpably fine powder, otherwise its reduction in the vat will be difficult and incomplete.

(c) The *soda vat* does not make use of woad, but otherwise it is very much the same as the preceding. Although the amount of its constit-

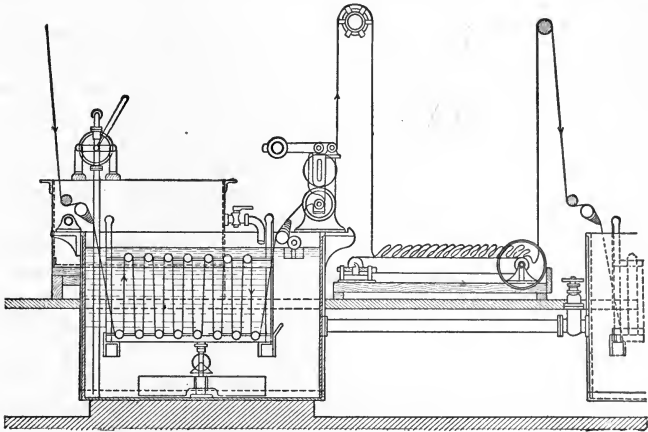

FIG. 220.—Indigo Dyevat and Oxidizer. (Mather & Platt.)

uents will vary largely among different dyers, the following proportions have been recommended:

Contents of vat 690–800 gallons.

Syrup.....	8 lbs.
Bran.....	20 lbs.
Soda ash.....	14 lbs.
Lime.....	3 lbs.
Madder.....	6 lbs.
Indigo paste (20 per cent).....	12 lbs.

The methods of preparing and working this vat are in general the same as for the woad vat. The objection to this vat is the presence of caustic soda, formed as a result of the action of the soda ash on the lime. It does not give as full colors for the same amount of Indigo as the woad vat; the shades, however, are brighter, and this vat is said to be better suited for the dyeing of light blues.

(d) The *potash vat* is analogous to the soda vat, with the exception that potassium carbonate is used in place of soda ash.

(e) The *urine vat* is practically obsolete at the present time; it was

prepared from stale urine, salt, madder, and Indigo, the alkali being supplied by the ammonium carbonate present in the stale urine.

Properly to prepare and maintain a fermentation vat requires considerable skill and experience, especially with regard to the proper amounts of and the proper times for adding the lime. The fermentation must be regulated in such a manner as to reduce the Indigo sufficiently by the generation of the proper amount of hydrogen, and yet kept sufficiently under control as to prevent the danger of putrid fermentation setting in, which will result in the rapid destruction of the Indigo. When putrid fermentation starts, the vat is said to have "gone sick," and lime must be added and the vat well stirred up. If the secondary fermentation, however, has gone too far and cannot be stopped in this manner, the vat must be boiled up in order to prevent a total loss of the Indigo therein. After this, of course, the vat must be set all over again. The addition of lime always tends to reduce the fermentation, if too much is added the fermentation may be lessened beyond that point necessary for the complete reduction of the Indigo. If the fermentation is proceeding too slowly it may be increased by the addition of bran. If too little lime is present, the acids liberated by the fermentation will throw the Indigo out of solution, hence the vat will become weak, and bluish in color.

In dyeing heavy shades with Indigo it is best to build up the color with several successive dips in weaker vats, rather than to dye it to the full shade by a single dip in a very strong vat. In this manner the pigment is more thoroughly absorbed by the fiber and will not be so liable to crock off as otherwise.

In using synthetic Indigo the following fermentation vat is recommended: Use 25 lbs. of Indigo paste (20 per cent), 12 lbs. of bran, 12 lbs. of soda ash, and 8 lbs. of madder. The dye will be reduced in about twenty-four to thirty-six hours. The liquor at first has a muddy appearance, this gradually becomes greenish, and after the addition of lime shows a golden yellow color. The fresh vat has a sickly smell, but this gradually disappears, giving place to a pungent odor. In order to keep up the fermentation in the vat after use an addition of 5 ozs. of molasses to each pound of indigo used is made.

5. The Copperas Vat.—This form of indigo vat is not much used at the present time, as it is not very suitable for continuous dyeing on account of the large amount of sediment it contains.* The essential ingredients of this vat are ferrous sulphate and slaked lime; these react in the following manner:

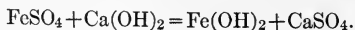

* The copperas vat was chiefly used for dyeing skein yarn. Its chief advantage was that it was easily set and kept in condition. A considerable amount of Indigo is always lost in the copperas vat, due to over-reduction and combination of the dye with the hydrate of iron.

The ferrous hydrate thus formed acts as a reducing agent in the presence of water:

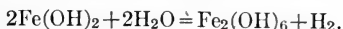

The indigo-white formed by the reduction dissolves in the excess of lime present.

The vat employed should be narrow and deep to accommodate the large amount of sediment formed. The temperature of the vat should be kept at about 70 to 75° F.

To prepare the copperas vat proceed as follows:* 36 grams of quicklime are slaked to a thin paste with water; while warm stir in 30 grams Indigo paste (20 per cent). Then add 30 grams ferrous sulphate (copperas) dissolved in about 100 cc. water at 140° F. Then dilute with water to 500 cc.

Have this solution in a covered flask; allow to stand for four to six hours with occasional stirring, in which time the liquid should have become yellow in color with a coppery-looking bead. Before adding the stock vat to the dyevat, 1 lb. of ferrous sulphate and 1½ to 2 lbs. of quicklime should be added per 100 gallons of water.

The copperas vat is also known as the vitriol vat. As a rule it is not replenished, but is worked three times a day, being well stirred after each dyeing. In about ten days the vat should be exhausted. It is mostly used for yarn dyeing and "resist" dyeing.

When cotton is dyed in a vat containing lime and which has considerable sediment, the material must always be washed with acid (1 to 2 per cent of sulphuric or hydrochloric acid is used) after dyeing in order to remove all particles of lime from the fiber, which would otherwise tender the cotton on drying. After the acid treatment the cotton must be thoroughly washed.

Darker shades are obtained in this vat if the yarn is dried before acidifying, and redder shades can be produced by drying at a high temper-

* In practical dyeing various proportions have been suggested by different authorities, as follows:

Indigo, Natural 60 per cent. Pounds.	Indigo, Synthetic 20 per cent. Pounds.	Quick Lime. Pounds.	Ferrous Sulphate. Pounds.	Vat. Gallons.
20	80	80	400
20	25-50	30-40	400
20	70	70	400
20	20	15-19	400
	30	36	24	60
	16	20	16	40
	8	12	10	20
	25	25	20	50

ature. Also by steaming the shade is made more violet and bloomy. These remarks hold true for cotton dyed in any form of vat.* This coppery appearance, however, is changed by washing towards black.

It is probable that Indigo forms a chemical compound with ferrous sulphate and lime, and this entails a considerable loss of dyestuff, for under the most favorable conditions only 75 to 80 per cent of the Indigo placed in the vat can be found again. A part of the Indigo remains in the sediment probably combined with ferrous hydrate.

In setting the copperas vat it is customary to put the Indigo and copperas into the bath first, and then to add the milk-of-lime. To save time, however, and to obtain a better reduction of the Indigo it is advisable to prepare a stock vat. This may be prepared conveniently by mixing 25 lbs. of Indigo paste (20 per cent) with 20 lbs. of copperas previously dissolved in hot water, and then add 25 lbs. of lime in the form of a thin cream. Have the temperature of the vat at about 120° F., stir up well and allow to stand until fully reduced, which will require about three hours. In practice the vat is usually prepared in the evening and allowed to stand overnight.

The dyevat is usually a stone or wooden circular vat 6 to 9 ft. deep and 2½ to 5 ft. in diameter, and generally sunk into the floor of the dye-house so as to make it convenient for working. In starting a new vat the necessary amount of water is run in, and then for each 100 gallons 1 lb. of copperas and 2 lbs. of lime are added in order to counteract the effect of the oxygen in the water. The necessary amount of the stock vat is then added, the liquid stirred up and left for two to three hours. The liquor should then be clear and of a brownish amber color, and on gently stirring it, dark blue streaks should appear with a coppery scum or flurry float on the surface. Before entering the goods to be dyed this flurry should be skimmed off and added to the stock vat.

If the liquor is greenish it indicates that part of the Indigo is not reduced, and more copperas has to be added. If it has a darkish appearance more alkali is needed and additional lime is added. An excess of either copperas or lime, however, should be avoided. After a day's working the vat should be well raked up and if necessary replenished by additions from the stock vat. The sediment in the copperas vat contains a considerable amount of Indigo, hence this should be saved and the Indigo recovered by treatment with hydrochloric acid.

* According to the Badische Co. bright reddish shades may be obtained by previously treating the cotton goods with bone glue. For this purpose the goods are run in a solution containing 2 to 5 parts of glue per 1000 parts of water, squeezed and dyed. Better results are said to be obtained if the goods are dried before dyeing. This method of treatment is especially recommended for dyeing in the hydrosulphite vat.

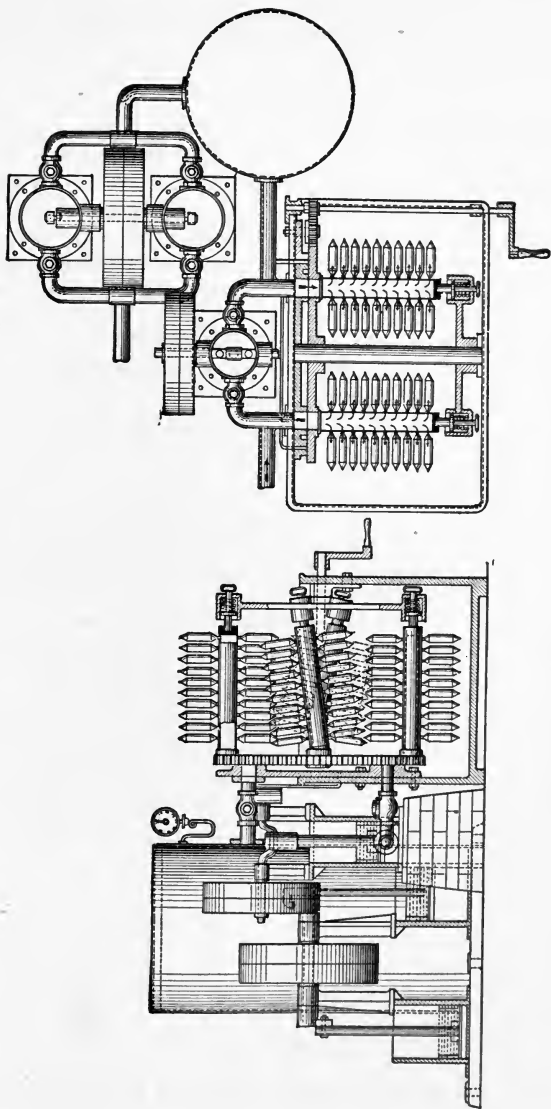
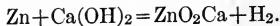

FIG. 221.—Cop Machine for Indigo Dyeing. (Krantz.)

6. The Zinc Vat.—The principle of this vat depends on the property of zinc dust to react with slaked lime to form a calcium zincate and hydrogen:



The hydrogen thus liberated reduces the Indigo to indigo-white, which dissolves in the excess of lime present. There are evidences, however, which go to show that secondary reactions take place which make the chemical process a more complicated one than that above outlined.

The zinc vat is still quite largely used for the dyeing of cotton. It possesses less sediment than the copperas vat, and hence may be used for continuous dyeing. The copperas vat contains about five times as much sediment as the zinc vat.

The zinc vat is run at a temperature of 110 to 120° F. which considerably helps in the reduction of the Indigo, without injury to the dye.

The zinc vat may be prepared as follows:

20 grams Indigo paste (20 per cent) are stirred well with
4 grams zinc dust and
40 cc. water at 110° F.

Then add 10 grams quick-lime, previously slaked to a soft paste and allowed to cool to about 115° F. Then dilute with water at 115° to 200 cc. and put in a covered flask.* Allow to stand for a few hours with occasional stirring until the liquor is yellow.† If necessary, it may be left overnight. Under these conditions the vat should keep in good condition for a long time. During the dyeing process it is necessary to sharpen the vat from time to time by further addition of zinc dust and lime. No fixed rule for this can be given, but for a vat of 100 gallons about $\frac{1}{2}$ to 1 lb. of lime and $\frac{1}{4}$ to $\frac{1}{2}$ lb. of zinc dust will be required each evening. Narrow and deep cement vats or wooden vats lined with cement are best for use. Iron vats may also be employed. A standard solution of reduced Indigo may

* The following proportions have been suggested for practical dyeing.

Indigo, Natural 60 per cent. Pounds.	Indigo, Synthetic 20 per cent. Pounds.	Quick-lime. Pounds.	Zinc Dust. Pounds.	Vat. Gallons.
2	1	1	100
4	5	2	100
2	3½	1½	100
1	2½	1	100
½	1½	½	100
	10	4-5	1½	100
	12½	5-6	1½	100

† The stock vat should contain 2 to 2½ per cent of actual dyestuff, while the vat used in dyeing should contain 2 to 3 parts of Indigo per 1000 parts of dye liquor.

be prepared from which the vat is fed from time to time as it becomes exhausted. During the working of the vat it should be kept at a temperature of about 70° F.

The dyeings should be acidified with water containing 2 grams sulphuric acid per liter (2 lbs. per 100 gallons water), then well rinsed and soaped.

In preparing a stock vat with synthetic Indigo it is recommended to mix 25 lbs. of Indigo paste (20 per cent) with 20 lbs. of slaked lime made into a thin cream, and then to add 3 lbs. of zinc dust previously mixed to a fine paste with 2 gallons of water at 120° F. Stir well and allow to stand for five to six hours. The initial temperature should be 115° F. In preparing the dyevat first add 5 ozs. of zinc dust and 1 lb. of lime for each 100 gallons of water; stir up and allow to stand for one hour and then add the necessary amount of the stock vat. Sometimes iron turnings are added to the vat to liberate the hydrogen retained in the sediment, and to accelerate the clearing of the liquor. If an excess of zinc is present the vat will be muddy and frothy, due to too much hydrogen being generated; under such circumstances the vat should be raked up and more Indigo added. When in good condition the zinc vat looks very similar to the copperas vat, the liquor being clear and of an amber-yellow color with flurries and blue streaks showing when disturbed.

7. The Hydrosulphite Vat.—When zinc dust acts on a solution of sodium bisulphite, the following reaction takes place:



The body represented by the formula NaHSO_2 is known as sodium hydrosulphite and is a strong reducing agent, being itself thereby oxidized to sodium bisulphite, NaHSO_3 , and finally to sodium bisulphate, NaHSO_4 . Sodium hydrosulphite in alkaline solution very rapidly reduces Indigo giving a clear solution of indigo-white. The sodium hydrosulphite liquor is usually prepared as occasion requires for adding to the indigo vat.

(a) *Concentrated hydrosulphite liquor* may be prepared in the following manner:

130 grams zinc dust.
55 cc. water.

Make into a paste and mix with 1000 cc. sodium bisulphite solution of 72° Tw. As the mixture becomes very warm, the temperature should be kept down to 100° F. by the addition of ice or cold water; after the action has ceased dilute to 2 liters. Allow to stand for one hour; then stir in 600 cc. of 20 per cent milk-of-lime cold and allow to stand for two hours.*

* The following process is also recommended for the preparation of hydrosulphite liquor: To 100 liters of sodium bisulphite solution (72° Tw.) add 60 liters of water; then

This causes the precipitation of all the dissolved zinc as zinc hydrate. The liquor is now strained to free it from sediment, and preserved in a closed bottle. The hydrosulphite solution thus prepared will keep intact for several weeks, and the addition of a small quantity of caustic soda will cause it to keep better.

(b) *Preparation of the standard Indigo solution.*

75 grams Indigo paste (20 per cent).
40 cc. hot water.
90 cc. caustic soda, 42° Tw.
200 cc. hydrosulphite liquor.

Stir gently and keep the temperature at about 110° F.* To complete the process thoroughly it may be necessary to add a little more of the hydrosulphite solution. The liquor should then be clear and yellow in color, and a drop running on a sheet of glass should require about twenty-five seconds to turn blue.†

(c) *Preparation of the vat.*—To 1 liter of water at about 70° F. add 10 cc. of the hydrosulphite solution; allow to stand for a short while, then run in about 100 cc. of the standard Indigo solution by means of a long-tubed funnel;‡ stir gently, and allow to stand for one-half hour, when the vat is ready to be used for dyeing. The liquor should be clear and yellow in color.

The hydrosulphite vat is especially well adapted for the dyeing of piece-goods in the continuous vat and the machine dyeing of cops, etc., as there is no sediment formed in the vat, and excess of hydrosulphite does not destroy the Indigo. It is not as much used for skein yarn.§ There is less

slowly stir in this 13½ kilos. of zinc dust which has previously been made into a paste with 15 liters of water. The temperature should be kept below 85° F., using ice if necessary. Allow to stand for two hours; then mix into the clear solution 50 liters of milk-of-lime (20 per cent), and allow to stand for six to twelve hours. Decant the clear liquor for use; it should show a density of 25 to 26° Tw.

* In practice it is best to mix the Indigo with the caustic soda lye, heat to about 120° F., and then add the hydrosulphite.

† The Badische Co. recommends the following proportions: 100 lbs. Indigo (20 per cent), 6 gallons caustic soda lye (76° Tw.) and 17 lbs. hydrosulphite conc. powder. Or if the dyer wishes to make his own hydrosulphite, 100 lbs. Indigo (20 per cent), 8 lbs. zinc dust, 8 gallons sodium bisulphite (57° Tw.) and 30 lbs. quicklime (or 6 gallons caustic soda lye, 76° Tw.) for 100 gallons stock solution.

‡ In preparing a 200-gallon vat, first add to the water 2 ozs. hydrosulphite conc. powder (or 2 lbs. Hydrosulphite O), stir and allow to stand for a few hours. Then run in the stock Indigo solution. The vat exhausts very slowly if an excess of either hydrosulphite or caustic soda is present.

§ The Badische Co. recommends a special hydrosulphite-ammonia vat for dyeing cotton skein yarn, as it has no injurious action on the workmen's hands. It forms no sediment and the yarn requires no souring after dyeing. To prepare a vat for 100 lbs. of cotton yarn to be dyed a medium blue in two dips: Dye liquor 180 to 220 gallons;

Indigo wasted in the hydrosulphite vat than in the other forms of indigo dyeing. The following shows the amount of Indigo lost in the different vats used in cotton dyeing:

Copperas vat.....	25 per cent
Zinc vat.....	10 per cent
Hydrosulphite vat.....	1 to 2 per cent

The Höchst Co. recommends the following method for preparing a stock vat: Mix 25 lbs. of Indigo paste (20 per cent) with 1 gallon of luke-warm water, then add $1\frac{1}{2}$ gallons of caustic soda lye (76° Tw.); stir well, heat to 120° F. and then add 6 lbs. of hydrosulphite conc. powder previously dissolved in cold water. The temperature of the vat should be kept at about 120° F., and if the color of the liquid does not become

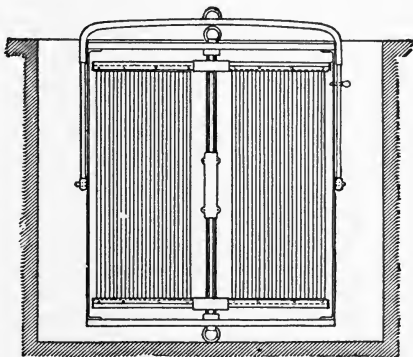

FIG. 222.—Dipping Apparatus for Indigo Vat

yellow after standing one hour a further addition of hydrosulphite must be made. In starting a new dyevat first add $1\frac{1}{2}$ ozs. of hydrosulphite for each 100 gallons of water, stir up and allow to stand for two hours, then add

the cold liquor is previously "sprung" with 4 ozs. hydrosulphite conc. powder, $\frac{1}{2}$ pint caustic soda (42° Tw.), 1 gallon Turkey-red oil, and 9 lbs. salt. The stock vat to be added is prepared as follows: 24 lbs. Indigo (20 per cent), 9 gallons boiling water, $1\frac{1}{2}$ gallons caustic soda (42° Tw.), $5\frac{1}{2}$ ozs. hydrosulphite conc. powder and 2 pints of ammonia water. The mixture is allowed to stand for one-half hour, and dyeing may be commenced as soon as the stock vat is stirred into the dyevat. The skeins should be suspended on bent iron rods so as to be completely beneath the surface of the liquor. The hanks are turned several times during about one-half hour and then taken out. Each hank should be wrung out separately, allowed to oxidize in the air, then rinsed but not soured. The liquor should be of a yellow or greenish yellow color, and should always smell slightly of ammonia. The common salt causes the Indigo to go more quickly on the fiber. This vat is also suitable for dyeing loose cotton.

the required quantity of the stock vat; stir again and allow to stand for three hours, after which the dyeing may be commenced.*

A modification of the hydrosulphite vat is known as the *Zinc-Bisulphite Vat*. In this vat, instead of using the ready-made hydrosulphite, the latter is formed in the vat itself. The stock vat may be made as follows: Mix 25 lbs. of Indigo paste (20 per cent) with 2 gallons of water, and add $1\frac{1}{2}$ gallons of sodium bisulphite solution (72° Tw.); stir well and add $2\frac{1}{2}$ lbs. of zinc dust, previously made into a thin cream with warm water. Stir for one-half hour and after standing for one-half hour add $1\frac{1}{2}$ gallons of caustic soda lye (76° Tw.), then make up to about 16 gallons. The initial temperature of this stock vat should be about 120° F. The reduction is complete as soon as the liquor shows a golden-yellow color, which requires about one-half hour after the soda has been added. In preparing a fresh dye vat first add for 500 gallons of water a mixture of 1 pint of sodium bisulphite solution (67° Tw.), 3 pints of water, and 2 ozs. of zinc dust. Stir up for ten minutes and allow to stand for twenty minutes, when the odor of sulphurous acid will have disappeared. Add this to the vat; stir and add $\frac{1}{4}$ pint of soda lye (76° Tw.). After raking allow to stand for one hour, then add the necessary quantity of stock vat.

The hydrosulphite vat is also free from sediment and the reducing agent is in the solution itself and not in a bulky precipitate at the bottom of the vat, as is the case with all other vats.† If the vat becomes oxidized and turns blue owing to precipitation of indigo, all that is necessary is to add a fresh amount of hydrosulphite liquor; to maintain the proper strength of the vat, fresh additions of the standard indigo solution are made from time to time as needed. As the vat is free from sediment the dyed pieces do not require to be passed through an acid bath before washing.

Cotton yarn is mostly dyed with Indigo in the form of warps in special forms of machines suited to this purpose. Cotton piece-goods are also largely dyed with Indigo in special machines. These machines are so arranged that the goods are run beneath the liquor until thoroughly impregnated, after which they are exposed to the air for oxidation and then washed. In continuous dyeing machines arrangement is made for several dips with alternate air oxidation.

* A quick process for the dyeing of Indigo on cotton is given by Brown (*Jour. Soc. Dyers & Col.*, 1913, p. 71). A hydrosulphite vat is used but much less caustic soda is employed than is usually considered necessary, and an addition of common salt or Glaubersalt is made. The vat is prepared as follows: For 100 lbs. of yarn use 200 gallons water, 44 lbs. Indigo solution (20 per cent), $4\frac{1}{2}$ pints caustic soda (42° Tw.), $4\frac{1}{2}$ lbs. hydrosulphite powder, conc., 7 pints Monopol soap and 9 lbs. common salt (or 22 lbs. Glaubersalt).

† It is very important properly to adjust the amount of alkali in the vat; as an excess of alkali prevents the absorption of the Indigo by the fiber, while a deficiency of alkali may cause dull and uneven shades.

The largest use of Indigo is for the dyeing of warps for blue denim for over-alls and other cheap cotton fabrics.

8. Indigo Extract.—As previously shown, when Indigo is treated with strong sulphuric acid, a soluble sulphuric acid of Indigo is formed. This product is used as a blue acid dyestuff under the name of Indigo Extract, Indigo Carmine, Indigotine, etc. The action of the sulphuric acid on the Indigo is to form mono- and disulphonic acids; when a moderate proportion of acid is used and allowed to act for a short time, the mono-sulphuric acid is the principal product. This compound, after being converted into its sodium salt is known as *red or purple indigo extract*. The disulphonic acid, however, is the one which finds the most extended application; it may be prepared in the following manner: Mix 10 grams of Indigo powder with 40 grams of weak fuming sulphuric acid, or 80 grams of sulphuric acid 168° Tw. Do not allow the temperature to rise over 120° F. After careful stirring allow the mixture to stand for twelve hours at a temperature of 120° F. The thick liquid mass so obtained is soluble in water, and may be used in this form as a dyestuff, it being known as *chemic or Saxony Blue*. Usually, however, it receives further treatment; dilute with twice its volume of water, and add a saturated solution of common salt to precipitate the coloring matter. Filter off the product, which is known as *acid indigo extract*. By dissolving this in water and repeating the operations several times in order completely to remove the free acid, a *neutral or sweet extract* of indigo is obtained. The best extract is obtained from purified or synthetic Indigo; that prepared from raw Indigo gives dirty greenish gray shades. *Soluble Indigo* is the best refined extract; it should freely dissolve in water without leaving any residue, and should be free from any green impurities. The raw Indigo used for the manufacture of extracts is first refined by reducing with a concentrated copperas-lime vat, allowing all insoluble matters to subside, and then allowing the clear liquor to pass through shallow troughs, which again reprecipitate the Indigo from solution by oxidation.

9. Synthetic Indigo.—Owing to the great importance of Indigo as a dyestuff it was long the ambition of chemists to produce it synthetically. Its composition and chemical constitution were the subject of extensive and numerous investigations by many chemists. By a study of its chemical reactions and the decomposition products obtained from it under various treatments, its chemical constitution finally became known. The chemical formula of Indigo is rather complicated, but it has been definitely established as

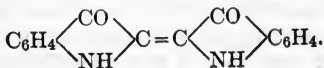

Having once established its proper constitution it was not long before Indigo was synthetically prepared in the laboratory. Then followed a long number of years of the closest investigation in order to discover a

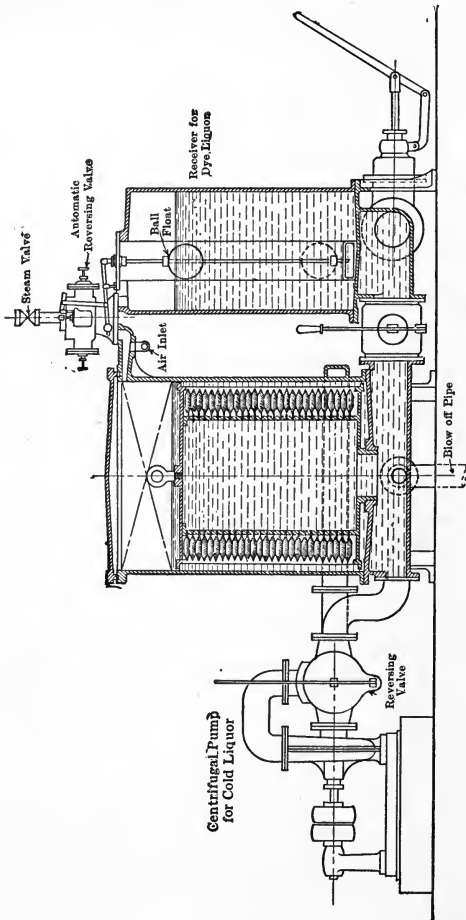

Fig. 223.—Patent Cop Dyeing Machine for Vat Dyes and Sulphur Dyes. (Mather & Platt.)

suitable process of manufacture which would be commercially available. In the year 1897 synthetic Indigo first came upon the market as a commercial commodity, and since then it has gradually displaced the natural

Indigo from trade. With the outbreak of the European War and the consequent cutting off of the main supplies of synthetic Indigo, resource was once more had to the natural product; but at the present time with the large production of the synthetic dye in all the principal countries, it would seem that the cultivation of natural Indigo was surely doomed to early extinction.

The first commercially successful process for the production of synthetic Indigo was that employing naphthalene as the starting point, converting this into phthalic acid by oxidation, which is then converted into a phenylglycine derivative and thence into Indigo.* More recently, however, aniline has been used as the starting point, the phenylglycine being prepared from this. The Indigo manufactured in this country and England is all made by the aniline method.

Synthetic Indigo can be made cheaper, purer and more uniform than the Indigo derived from the plant and it is identical with the natural product in all its properties and qualities. It is nearly always marketed in the form of a 20 per cent paste for the convenience of the dyer, as in this form it is ready for use in the preparation of the vat, whereas if in the solid dry form it would have to be subjected to a long and tedious grinding operation.

A reduced solution of Indigo has been brought out on the market consisting really of a concentrated stock vat of indigo-white. It is known as Indigo Solution, Indigo White, or Indigo Vat.† It was prepared in this form for the convenience of the dyer, who was thus relieved of the burden of reducing the Indigo first. The preparation of the vat when using these products is much simplified,‡ but owing to the extreme readiness with which the reduced Indigo oxidizes it is difficult to keep these products in a satisfactory condition.§

* In the conversion of phenylglycine into Indigo much better yields are obtained by the use of sodamide. This may be prepared by the action of ammonia on sodium, or directly in the reaction mixture of sodium and the sodium salt of phenylglycine. Sodium anilide (C_6H_5NHNa) is also used in the Indigo synthesis in the same manner as sodamide.

† Indigo Solution and Indigo White are preparations containing 20 per cent of Indigo, whereas Indigo Vat contains 60 per cent.

‡ The following is an example of a 1000-gallon vat of medium strength: the water is heated to 120° F. and there is added 4 pints of ammonia water, and $2\frac{1}{2}$ lbs. of hydrosulphite powder. When this has been well stirred up 3 gallons of glue solution (1:10) and 19 pints of Indigo Solution (=26 lbs.) are added. The vat is well stirred and allowed to stand for fifteen minutes, when the liquor should be of a clear greenish yellow color with a blue scum on the surface. When the vat on working becomes bluish green in color, stir in $\frac{1}{2}$ lb. more of hydrosulphite powder. The strength of the vat is replenished as required by adding the necessary amount of Indigo Solution. When working regularly a daily addition of 1 to 2 pints of ammonia water is made, and a gallon of the glue solution is added twice weekly.

§ Indophenol is a product which may also be classed as a vat dye, as it may be

Indigo Salt is a product which was formerly used somewhat in calico-printing. It is a bisulphite compound of ortho-nitro-benzaldehyde, which on treatment with dilute caustic soda is converted into indigotine.

Indophor is another indigo product which had some vogue in printing.

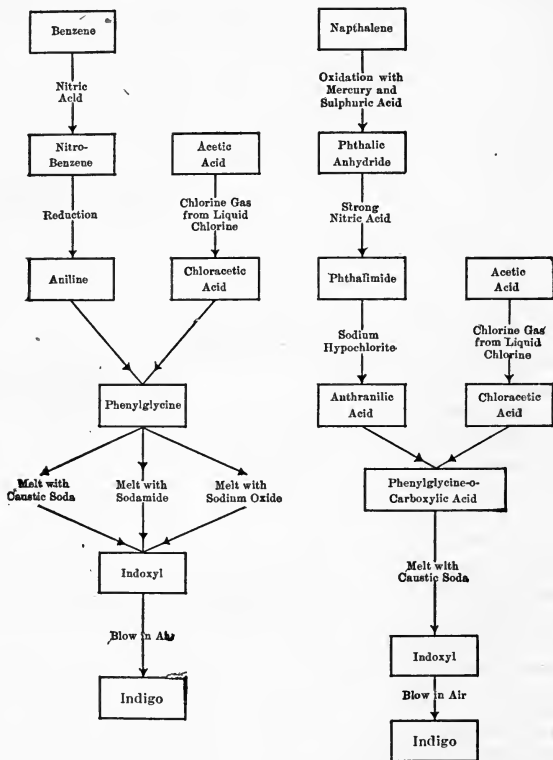

FIG. 224.—Syntheses of Indigo. (Ramsey & Weston, *Artificial Dyestuffs*.)

It is a mixture of indoxyl and indoxylie acid; when steamed it is converted into Indigo.

reduced like Indigo and dyed from a vat. At the present time it has but little use, though formerly it was used somewhat as an addition to the indigo vat, chiefly in the copperas vat. It is made by the action of alpha-naphthol on nitroso-dimethylaniline. When treated with an alkaline reducing agent it is converted into indophenol white. The blue color is developed by oxidation in the air or by treatment with a dilute solution of chrome.

When Indigo is treated with oxidizing agents (nitric acid, chromic acid, etc.), it is converted into isatin. This reaction is employed technically in the discharging of Indigo on printed cloth, and in the analysis of Indigo (by titration with permanganate).

10. Testing for Indigo on the Fiber.—As Indigo is a substantive dye-stuff, and requires no mordant, a pure dyed indigo fabric should not show the presence of any of the common mordant metals in the ash obtained by ignition. The presence of the oxides of chromium, aluminium, iron, or tin, etc., in the ash would indicate that the fabric also contained Logwood or other mordant dyestuff. Indigo Extract may readily be distinguished from vat-dyed Indigo by boiling a sample of the dyed woolen material with a one-half per cent solution of sodium carbonate, whereon the extract will have its color partially removed, and on acidifying the solution with acid the color becomes intensified; and finally the latter may be decolorized with potassium permanganate. A fabric dyed with pure vat Indigo is not affected by hydrochloric acid, dilute sulphuric acid, soap, alkalis, or cold alcohol. Hot alcohol extracts a little of the blue color which it deposits on cooling. Hot aniline, amyl alcohol, chloroform, and nitrobenzene extract the color to a greater extent. Cold concentrated sulphuric acid gives a yellow liquid, which quickly becomes olive, and slowly changes from a green to a deep blue, due to the formation of Indigo Extract; on adding water the solution remains blue, and will dye a piece of white wool.

Table of Tests.—(a) Take a sample of cloth dyed with vat Indigo and place on it a drop of concentrated nitric acid; a yellow spot will be formed surrounded by a green ring. If the spot appears more or less red, it is usually a sign that other coloring matters are present. This nitric acid test, so generally employed by merchants for the testing of Indigo dyed material, has not the great value usually attached to it, as there are a number of other dyestuffs now made which will yield the same reaction practically, though some, such as Alizarine Blue and Azo Acid Magenta, give the yellow spot without the green ring; but it is hard to discriminate closely between them.

(b) Take a sample of vat-dyed Indigo cloth and immerse it in a hot dilute solution of hydrochloric acid; it will remain blue. Repeat the test, using a piece of cloth dyed with Logwood, and the sample will become red. This serves as a good test to distinguish between Indigo and Logwood, but as a general test for Indigo it is not accurate, as there are a number of other blue dyes which behave in a similar manner.

(c) Boil a sample of Indigo-dyed cloth in a clear solution of aniline oil; a blue solution will be obtained, if the oil is very clear, or a bluish green solution if the aniline has a yellow color. The color appears red in gaslight. On adding hydrochloric acid to the solution and diluting with water, the Indigo will be precipitated. There are a few of the aniline dyes which are also extracted with aniline, but Alizarines and the wood colors are not dissolved by this reagent.

(d) Treat a piece of Indigo-dyed cloth with some concentrated sulphuric acid; an olive-green solution results. Warm and the solution will turn blue; dilute with water and the blue color remains, but on neutralizing with caustic soda the solution becomes yellow.

(e) Heat a piece of Indigo-dyed cloth in a test-tube in a careful manner so as not to

ignite the material; violet-colored vapors of Indigo will be noticed which will give a deposit of Indigo on the cooler part of the tube. This test must be carefully carried out, but when properly done is an excellent crucial test for Indigo, and is especially applicable to cotton goods containing only a small amount of Indigo.

(f) Woolen material dyed with vat Indigo only should satisfy the following tests: When steeped in cold or hot water for ten hours no color should be extracted. Alcohol of both 50 per cent and 95 per cent strength should not extract any color even on gently warming. A cold saturated solution of oxalic acid even on boiling should have no effect; Logwood will be turned red. A saturated solution of borax should have no effect even on boiling; Indigo Extract will be extracted. A 10 per cent solution of alum on boiling should not be colored. Also ammonium molybdate dissolved in 2 parts water should extract no color. Prussian Blue is indicated by boiling with borax and adding ferric chloride when a blue color will be formed. The blue color of Indigo should be completely destroyed on warming with a hydrochloric acid solution of stannous chloride or ferric chloride. Glacial acetic acid will entirely remove Indigo from the fiber by repeated extraction hot; on treating the solution so obtained with twice its quantity of ether, and adding a sufficient amount of water to cause the ethereal layer to separate, the latter will be distinctly blue and a deposit of Indigo will appear at the junction of the two layers. The lower acid layer should be colorless and should remain so when a little hydrochloric acid is added to it.

(g) In compound shades Indigo may usually be detected by boiling several times with dilute hydrochloric acid, washing with water, and then boiling with $\frac{1}{2}$ per cent solution of soda ash. This treatment will remove most other dyestuffs. The fabric is then dried, and the tests which have already been described may be applied to it. To detect small amounts of Indigo in compound shades, the sample is treated as just described with acid and alkali, and then gently warmed with a solution of sodium hydrosulphite. This is then poured on a piece of filter paper and exposed to the air, when a blue color will form on the paper in a few minutes, if Indigo is present.

(h) Sometimes Indigo on cotton is topped with Methyl Violet or some substantive reds for the purpose of obtaining brighter and redder shades. Methyl Violet may be detected by boiling the sample with alcohol, allowing the solution to cool, and filtering; the violet solution so obtained may be diluted with water and a piece of wool dyed in it. Substantive reds are indicated by boiling a piece of white cotton in a slightly alkaline solution with a sample of the material, when the white cotton will be stained red.

11. Indigo Derivatives: Thio-Indigo Dyes.—There are a number of indigo derivatives which have been prepared by synthetic means and which are dyed in the same general manner as Indigo itself. This entire group may be considered as Indigoid dyes, as distinguished from other anthraquinone vat dyes of a different chemical constitution.* Thio-indigo dyes are very similar to Indigo in chemical structure, having, however, sulphur in the molecule. The simplest one corresponding to Indigo is known as Thio-indigo Red B, and from this there are a number

* The indigoid dyes all sublime when heated, giving colored vapors. This distinguishes them from the anthraquinone and sulphurized vat dyes, which do not sublime (except Anthraflavone G). While all of the vat dyes are insoluble in water and the common solvents, the indigoids in general are more readily dissolved than the anthraquinone and sulphurized vat dyes; thus Indigo itself is soluble in boiling glacial acetic acid, pyridine, phenol, aniline, benzaldehyde, nitrobenzene. etc.

of derivatives which are also vat dyes. Helindone Gray BR and Helindone Violet are chlorine derivatives; Thio-indigo Scarlet G, Ciba Red G, Ciba Violet B, Ciba Gray G, Ciba Heliotrope, Ciba Bordeaux B,* and others are bromine derivatives of Thio-indigo.† The chemical formula for Thio-indigo Red is

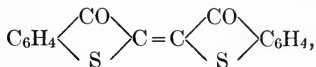

from which its relation to Indigo may be readily seen.‡ These dyes

* The manufacturers recommend the following method of using the Ciba dyes: For the purpose of dissolving the Ciba dyes, 1 lb. of the dyestuff is made into a paste with 1½ lbs. of caustic soda lye (66° Tw.) and a small quantity of hot water. Mix 1¼ lbs. of caustic soda lye (66° Tw.) with 1½ gallons of cold water, and to this is slowly added with constant stirring 3½ lbs. of hydrosulphite powder. This solution is added to the dyestuff paste along with about 4 gallons of hot water, and the temperature is slowly raised to the boil. Ciba Red G should be reduced at 140 to 160° F., and Ciba Scarlet G at 100 to 120° F. The addition of ½ lb. of Turkey-red oil or Monopol oil per 100 gallons of dye liquor is recommended in order to obtain better penetration. The material should be squeezed or wrung after dyeing and allowed to oxidize in the air for fifteen to thirty minutes, and then soaped at the boil for one-half hour with 2 to 4 lbs. of soap and 1 to 2 lbs. of soda ash per 100 gallons of liquor. Ciba Red and Ciba Scarlet may be developed by passing through a cold solution of bleaching powder of 0.7 to 1.4° Tw. The goods should then be rinsed and treated with a dilute solution of sodium bisulphite. Cops, tubes, etc., which have been dyed in special apparatus should be treated for one-half hour at 175° F. with a bath containing ½ to 3 per cent of chrome and ½ to 2 per cent of acetic acid, and afterwards thoroughly rinsed.

† The following is a list of the principal Thio-indigo vat dyes:

Thio-indigo Red BG	}	5-5'-dichlor-thio-indigo.
Helindone Red B		
Ciba Red B		6-6'-dichlor-thio-indigo.
Thio-indigo Red 3B	}	5-5'-dichlor-6-6'-dimethyl-thio-indigo.
Helindone Red 3B		
Helindone Fast Scarlet R		5-5'-dichlor-6-6'-diethoxy-thio-indigo.
Helindone Gray BR		Dichlor-7-7'-diamino-thio-indigo.
Helindone Violet 2B	}	Dichlor-dimethyl-dimethoxy-thio-indigo.
Thio-indigo Violet 2B		
Ciba Bordeaux B		5-5'-dibrom-thio-indigo.
Helindone Pink BN	}	6-6'-dibrom-dimethyl-thio-indigo.
Thio-indigo Pink BN		
Helindone Orange D		Dibrom-6-6'-diamino-thio-indigo.
Helindone Orange R	}	6-6'-diethoxy-thio-indigo.
Thio-indigo Orange R		
Thio-indigo Scarlet S	}	6-6'-dithioxyl-thio-indigo.
Helindone Scarlet S		
Helindone Gray 2B	}	7-7'-diamino-thio-indigo.
Thio-indigo Gray 2B		

‡ Thio-indigo is not made directly from Indigo, but is synthesized in a manner analogous to that of Indigo itself. Anthranilic acid is treated with sulphur to form thio-

come into the market in the form of pastes containing 20 per cent of coloring matter, and are dyed in vats prepared about in the same manner as for Indigo. Thio-indigo Red is also soluble in sodium sulphide with reduction, and hence may be used in practically the same manner as a sulphur dye, but the color so obtained is not as satisfactory as when produced from the vat.*

The stock vat for Thio-indigo Red B may be prepared as follows: Mix 50 lbs. of the dye paste with 25 gallons of water; then add 31 gallons of hydrosulphite liquor (25° Tw.); heat to 100° F. and stir for one-half hour. Then add 10 pints of caustic soda lye (76° Tw.) or 15 lbs. of soda ash dissolved in 12 gallons of water. Stir until the dye is reduced, when the solution should be of a yellow color. Then dilute with water to 120 gallons. For a dyevat of 500 gallons use 400 gallons of water, 2 gallons of hydrosulphite liquor (25° Tw.) and 100 gallons of the stock vat. Stir up gently and allow to stand for one-half hour. When in use as a continuous vat successive quantities of the stock vat and hydrosulphite must be added from time to time. Thio-indigo Red may also be dyed in a copperas vat,† and may also be used in a mixed vat with Indigo. Besides the red and scarlet there are also Thio-indigo Orange and Thio-indigo Yellow; these are all dyed in the same manner, which is also true of the other dyes of this same class.

The colors obtained with Thio-indigo Red and related dyes are very fast to washing, light and to chlorine bleaching.‡ It is possible to obtain a range of colors from a delicate pink to a full bluish red with these dyes.§

salicylic acid, and this with monochlor-acetic acid is converted into phenylthioglycine-ortho-carboxylic acid, corresponding to the phenylglycine of Indigo. On melting this with caustic soda Thio-indigo is obtained. Thio-indigo Scarlet is not a direct Thio-indigo derivative, but stands in the same relation to indirubin as Thio-indigo does to Indigo.

* This dye may also be reduced with other alkaline-reducing agents such as copperas, zinc, and caustic soda, or even glucose and caustic soda.

† The copperas vat for Thio-indigo Red may be prepared as follows: Stir 50 kilos of the dyestuff with 200 liters of water; add 50 kilos of copperas dissolved in 200 liters of water and 300 kilos of milk-of-lime (20 per cent) and 200 liters of water; make up to 1000 liters. Stir until solution is complete. A dyevat of 1000 liters is made by mixing 200 liters of this stock vat with 800 liters of water.

‡ Thio-indigo Red has a remarkable resistance to oxidizing agents. It may be boiled in strong hypochlorite solution without being destroyed. It is not even destroyed by boiling chromic acid solution.

§ The manufacturers of the Helindone dyes recommend the following procedure in dyeing: Hard water should be corrected by adding 3 to 5 oz. of soda ash and 3 oz. of hydrosulphite conc. powder to each 100 gallons of water; allow to settle and use the clear water. The stock vats are prepared by making the dyestuff (1 part) into a paste with warm or cold water (20 to 50 parts), then adding 2 to 10 parts of caustic soda lye (76° Tw.) and $\frac{1}{2}$ to 2 parts of Turkone Oil N (a soluble sulphonated oil). The 1 to 4 parts of hydrosulphite conc. powder are added with constant stirring. The vat is best prepared

12. Substituted Indigo Derivatives.—Besides the group of Thio-indigo dyes there are other vat dyes consisting of halogenated substitution products of Indigo itself. Indigo R and RR, for instance, are bromine derivatives and give redder shades than Indigo. Indigo 2B, 4B, and 6B are respectively di-, tetra- and penta-brom-indigo, and range in shade from a bright blue to a greenish blue resembling Methylene Blue.* Indigo RB and RBN, Brom-indigo FB, Ciba Blue B and 2B, Midland Blue R are also brom-indigos. Indigo T and G are di-methyl indigos, and give greener shades than Indigo and are faster to bleaching. The famous Tyrian Purple of the ancients has been proved to have been a di-brom-indigo. Ciba Yellow G is also a brom derivative and Indigo Yellow 3G Ciba is a derivative of dibenzoyl-indigo. All of these are vat dyes and are dyed in the same manner as the other vat colors by the use of a hydro-

at a temperature of 100 to 140° F. and it should be ready for use in from fifteen to thirty minutes. The following table gives the proportions required to reduce 10 parts of the dyestuff:

Helindone Dye Paste.	Water.	Caustic Soda 76° Tw.	Turkone Oil N.	Hydro- sulphite Conc. Powder.	Temp.° F.	Temp. for Dyeing F.
Yellow 3G, N.....	40	7	4	60-100	60- 80
Orange R.....	20	1½	1	140	90-110
Orange G, NR.....	70	5-6	3	70	70
Scarlet S.....	20	2¼	½	1¼	140	80
Fast Scarlet R.....	30	2¾	1	1½	160	140
Red B, 3B.....	50	5½	2	2½	140	140
Pink B.....	50	10	7	4	140	110
Pink AN, BN.....	120	5½	3	2	160	120
Brown G.....	40	2¾	1	1¼	120	110
Brown 3G, N.....	40	7	4	100	80
Brown RR, 5R.....	50	2¾	1	1½	104	140
Brown AN.....	50	8	2	140	140
Green G.....	50	4	2	140	140
Blue 3G, N.....	50	2¾	1½	120
Violet B, R.....	200	5½	3	4	140	120
Violet BB, B.....	100	4	6	3	160	110

When dyeing with different dyes in the same vat, the stock vats should be prepared separately and mixed in the dyevat. The solution of the dye is added through a fine sieve to the dyevat which should have a temperature of 60 to 140° F. After dyeing, wring the yarn back into the vat, allow to oxidize in the air, and soap at the boil.

* When Indigo is suspended in nitrobenzene and treated with bromine at elevated temperatures, tri- and tetra-brom-indigos are formed; the corresponding chlorine compounds may be made in a similar manner. All of these compounds dye reddish blue colors. By suspending Indigo in concentrated sulphuric acid and treating with bromine without heating, penta- and hexa-brom-indigos are formed which dye greenish shades of blue.

sulphite vat. They are principally used for the production of fast cotton colors.

Certain amino derivatives of Indigo give brown vat dyes; Ciba Brown, for instance, is a brominated diamino-indigo, and gives a reddish brown color fast to light and washing, but not fast to bleaching. Naphthalene indigos have also been prepared from alpha and beta-naphthylamine; they furnish green dyes, which, however, are of little value, as they have no special fastness. On bromination, however, the beta-compound gives a valuable dye (Ciba Green G and Helindone Green G).

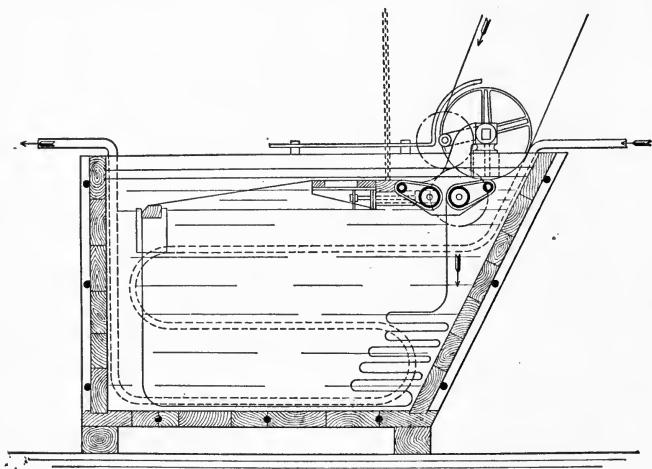

FIG. 225.—Hydrosulphite Vat for Piece-Goods.

Indigo Yellow 3G is of special interest in that it may be dyed in combination with Indigo to give uniform green shades. Usually when the indigoid dyes are applied in mixtures they give uneven colors, owing to the difference in the affinities of the dyes for the fiber and the particular conditions of temperature and amount of alkali that are required for the individual dyes.

Indirubin is red indigo derivative which occurs in natural Indigo; it may also be prepared synthetically by condensing isatin with indoxyl. It occurs in the manufacture of synthetic Indigo when air is admitted to the caustic melt. In the vat it is largely converted into indigo blue, but as a dye of itself very little is fixed on the fiber and its color is of little value as it is not fast to washing. Certain halogen derivatives of indirubin.

however, are useful vat dyes, such as Ciba Heliotrope B, which is a tetra-brominated indirubin.

There are also vat dyes of Indigo derivatives which are obtained by the condensation of isatin with naphthol, anthranol, or similar compounds. Alizarine Indigo 3R is obtained from dibrom-isatin condensed with alpha-naphthol, while Helindone Blue 3GN and Alizarine Indigo G are anthranol derivatives with isatin.

13. Anthraquinone Vat Dyes.—These dyes are derived from amino-anthraquinone compounds,* and include the Indanthrene, Algol, Cibanone, and some of the Helindone dyes. Indanthrene itself (which is also known as Indanthrene Blue RS) may be considered as an azine condensation product of di-anthraquinone, and has the formula:

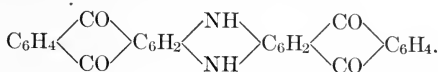

This will dye a blue color on cotton from a hydrosulphite vat, giving shades very fast to light and washing but not to hypochlorite bleaching. By forming halogen substitution products, however, dyes fast to chlorine are obtained. Indanthrene Blue RC is the mono-brom derivative; Indanthrene Blue GC and GCD are respectively the di-brom and the dichlor-derivatives. Indanthrene Blue CE and Algol Blue CF are similar products. Dihydroxy-indanthenes are also known including Algol Blue 3B, Indanthrene Blue 3G and 2GS; these give bright greenish shades of blue.

Other related dyes of this same group are as follows:

Algol Blue 3G	Algol Brilliant Orange FR	Algol Gray B
Algol Blue K	Algol Brilliant Red 2B	Algol Green B
Algol Blue 3R	Algol Brilliant Violet 2B	Algol Olive R
Algol Bordeaux 3B	Algol Brilliant Violet R	Algol Orange R

* The discovery of the anthraquinone vat dyes is the latest important development in tinctorial chemistry. Anthraquinone is a cheap raw material and is capable of a large number and variety of reactions, consequently there has been great activity in the preparation of vat dyes derived from this product. Many of these compounds, however, are useless as dyes as they possess no affinity for the fiber. These anthraquinone dyes are characterized by a high molecular weight and a very complex chemical constitution, and apparently this goes hand in hand with their great fastness. Some are also peculiar in that they contain no nitrogen in the molecule; such a dye, for instance as Indanthrene Violet R has the empirical formula $\text{C}_{31}\text{H}_{16}\text{O}_2$, which approaches that of a hydrocarbon. The anthraquinone vat dyes usually require a more strongly alkaline vat than the indigo dyes, and consequently are applied almost exclusively to cotton dyeing. They may be used for wool if the fiber is first treated with formaldehyde to lessen its sensitiveness to alkalis. A new class of anthraquinone vat dyes has been obtained by the action of diazo-anthraquinone on certain aromatic amines after the manner of preparing the azo dyes.

Algol Pink R	Cibanone Green B	Indanthrene Maroon
Algol Red B	Cibanone Orange R	Indanthrene Olive G †
Algol Red 5G	Cibanone Yellow R	Indanthrene Red BN
Algol Red R	Helindone Yellow 3GN	Indanthrene Red G
Algol Scarlet G	Indanthrene Black B	Indanthrene Scarlet G
Algol Violet B	Indanthrene Blue R *	Indanthrene Violet R
Algol Yellow 3G	Indanthrene Bordeaux B	Indanthrene Violet RN
Algol Yellow R	Indanthrene Dark Blue BO	Indanthrene Violet RT
Algol Yellow WG	Indanthrene Golden Orange G	Indanthrene Yellow
Anthraflavone G	Indanthrene Golden Orange R	Leucole Brown B
Cibanone Black B	Indanthrene Gray B	Leucole Dark Green B
Cibanone Blue 3G	Indanthrene Green B †	

It will be noticed that these vat dyes now cover a wide range of colors. They are very fast to light and washing and many of them are also very

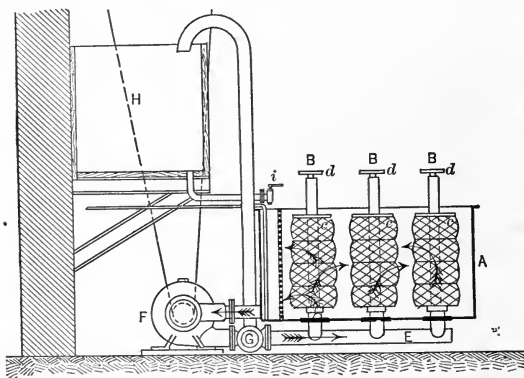

FIG. 226.—Indigo Dyeing Machine for Slubbing. (Obermaier's System.)

fast to bleaching, though this quality varies with the individual dye, and in order to obtain bleaching-fast shades a proper selection of dyes must be made for the purpose.

These vat dyes are brought into solution in caustic soda by reduction with sodium hydrosulphite. In a vat thus prepared, however, they act

* Indanthrene Blue R is one of the oldest and is still one of the most important of the vat dyes. It is prepared by heating beta-aminoanthraquinone with caustic alkali and potassium nitrate. It gives a dark blue vat which dyes bright blue colors.

† Indanthrene Green B is an interesting product; it is a nitration product prepared from Indanthrene Blue BO. When dyed on cotton and treated with oxidizing agents a fast black color is obtained (Indanthrene Black B).

‡ Indanthrene Olive G, together with the Cibanone dyes, are obtained from anthracene by heating with sulphur, after the manner of making sulphur dyes. These colors are fast to light and washing but not to bleaching.

very much after the manner of substantive dyes on cotton, some of them being dyed almost at the boil, the dyeing and development of the color taking place almost simultaneously, and the dyebath becoming practically exhausted. Some of these dyes, however, must be applied at lower temperatures, and require subsequent oxidation in order to develop the color. The vat dyes are brought into trade in the form of pastes containing from $8\frac{1}{2}$ to 20 per cent of coloring matter. For the production of heavy shades large proportions of the pastes must be taken.

For the application of the vat dyes the Badische Co. recommend the following procedure for cotton yarn: The yarn is first boiled out with soda ash with or without the addition of Turkey-red oil. For dyeing 100 lbs. of yarn use a dye-vessel with 225 gallons of water; add $4\frac{1}{2}$ gallons of caustic soda lye (53° Tw.) and heat to 140° F. (when using Indanthrene Blue GC, GCD and RC heat only to 120° F.), skim off any precipitate, add the necessary quantity of hydrosulphite (previously dissolved in ten times its weight of cold water), and finally add the dyestuff as a thin paste made up with ten times its weight of hot water. Allow the vat to rest until the dye has been completely dissolved. The yarn should be immersed in the liquor on bent iron sticks. The vat should be kept at 140° F. or 120° F. as the case may be. In dyeing light shades, however, 105° F. is all that is necessary. After dyeing heavy shades the yarn should be drained and then rinsed in a bath containing 2 ozs. of hydrosulphite conc. per 100 gallons of water. When preparing a fresh bath 2 gallons of caustic soda lye (53° Tw.) should be added per 100 gallons of water, and the amount of hydrosulphite conc. should be about one-fourth that of the dyestuff used; in no case, however, should it be less than 1 lb. nor more than 4 lbs. per 100 gallons.

A hydrosulphite solution that will keep for some time may be prepared by slowly adding 10 lbs. of hydrosulphite conc. (anhydrous sodium hydrosulphite) to 9 gallons of cold water, and when dissolved add 4 pints of caustic soda lye (53° Tw.). Of the ordinary paste dyes, from $\frac{1}{2}$ to 50 per cent may be used (calculated on the weight of the cotton); but when employing the dry powder brands, from 10 to $12\frac{1}{2}$ per cent will give heavy shades. The dyebath is usually not exhausted when dyeing heavy colors, and it may be used as a continuous vat, only one-sixth to one-fifth of the caustic soda originally added should be used, and afterwards the necessary amounts of dyestuffs and hydrosulphite.

After dyeing the colors may be brightened by soaping at 140° F. with 3 to 5 lbs. of soap per 100 gallons.

Cotton piece-goods should be dyed in an under-water jigger,* and

* Piece-goods may also be dyed with the vat dyes in the dipping vat. For this purpose the goods are well boiled, dried, and stretched on the dipping frame and immersed in the well-stirred vat at 160 to 180° F. for ten to twenty minutes. The frame is then raised and placed in water without delay. After the goods have been slightly

after dyeing rinse in a bath containing $2\frac{1}{2}$ ozs. of hydrosulphite per 100 gallons; then wash free from soda, and sour with 1 to 2 pints of sulphuric acid per 100 gallons, rinse, and soap at the boil. In order to oxidize the dyestuff more rapidly after dyeing, 5 to 8 ozs. of sodium bichromate should be added per 100 gallons of the souring liquor. This aids in producing more uniform shades and also increases the fastness to soaping. Piece-goods may also be dyed by padding.*

14. The Carbazol Vat Dyes.—Certain vat dyes of great importance are obtained from carbazol† by treatment with sodium polysulphide, somewhat after the manner of making the sulphur dyes. These dyes include the Hydron Blues and Indocarbon S. The are applied in hydrosulphite vats in the usual manner and give colors which are very fast to light, washing and bleaching.

For the dyeing of Hydron Blues on cotton yarn the following method is recommended by the manufacturer: ‡

	Starting Bath, Per Cent.	Additions, Per Cent.
Dyestuff (20 per cent paste).....	2 to 30	2 to 24
Hydrosulphite conc. powder.....	2 to 15	1 to 12
Caustic soda lye (75° Tw.).....	2 to 15	1 to 8
Proportion of yarn to liquor, 1 : 20.		

Heat the bath to about 120 to 140° F., add the caustic soda and the dyestuff, gradually stir in the hydrosulphite (either in powder form, or better dissolved in cold water) and stir well until the dye has been completely reduced. Dye for one-half hour at 120 to 140° F., preferably on bent sticks, squeeze or wring, oxidize in the air, and rinse. The yarn should be finally soured with sulphuric acid solution, thoroughly washed and

rinsed they are removed from the frame and soured with $\frac{1}{2}$ gallon sulphuric acid per 100 gallons of water, rinsed well and soaped at the boil. To produce deep shades several dips should be given.

* The padding liquor may be prepared as follows: 1 to 20 lbs. of the dyestuff paste are carefully mixed with $12\frac{1}{2}$ to 15 lbs. or gum thickener (1 : 1) and made up to 10 gallons with water. Filter through cotton cloth; pad and develop for one-half to three-quarters of an hour in an ordinary jigger nearly filled with water, containing $2\frac{1}{2}$ gallons caustic soda lye (53° Tw.) and $1\frac{1}{2}$ to $1\frac{1}{2}$ lbs. of hydrosulphite powder per 100 gallons of water. The goods are finally given two ends in water containing 3 ozs. hydrosulphite powder per 100 gallons, rinsed, soured, rinsed again, and soaped at the boil.

† Carbazol is a product occurring in coal-tar in association with anthracene, and is obtained in the purification of the latter.

‡ Hydron Blue is often dyed in a vat made up with sodium sulphide, caustic soda, and hydrosulphite, better penetration being obtained by the use of the sodium sulphide. This dye may also be dyed like a sulphur color by dissolving in sodium sulphide alone, but the colors obtained this way are not so good.

soaped. Piece-goods may be dyed on the jigger, which should be provided with squeezing rollers; dyeing for one-half to three-quarters of an hour at 140° F., squeeze, pass through the air to oxidize, rinse first in acidulated water and then in pure water.

15. Experimental. Exp. 150. Preparation of Indigo Solution.—Mix 75 grams of Indigo paste (20 per cent) with 40 cc. of hot water, and 90 cc. of caustic soda * solution (42° Tw.) and 50 grams of hydrosulphite powder (Blankit T) dissolved in 200 cc. of water. Stir gently and keep the temperature at about 110° F. In a short time the liquor should be of a clear amber-yellow color with a film of blue on the top. The liquid now contains indigo-white and serves as a stock Indigo solution for the preparation of the dyevat. The hydrosulphite powder (Blankit T) is an anhydrous compound of sodium hydrosulphite and is a fairly stable body compared with most hydrosulphite

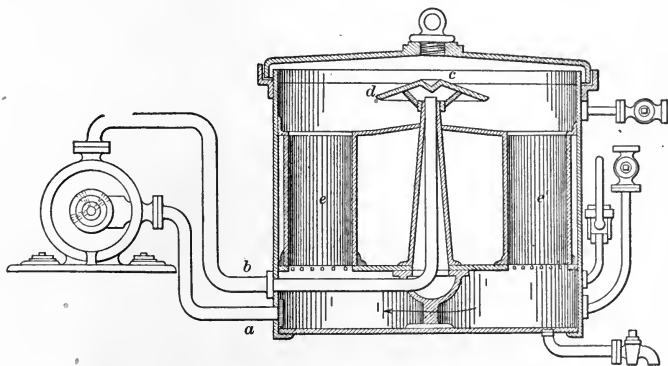
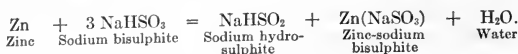

FIG. 227.—Dyeing Machine for Slubbing. (Simonis.)

derivatives. It is a strong reducing agent and converts the indigo-blue into indigo-white. In place of this prepared form of hydrosulphite the solution of sodium hydrosulphite itself may be used, in which case it may be prepared as follows: 130 grams of zinc dust are made into a paste with 55 cc. of water, which is then mixed with 1000 cc. of sodium bisulphite solution of 72° Tw. As the mixture is liable to become heated, the temperature should be kept below 100° F. by the addition of ice or cold water; when the chemical action has ceased, dilute to 2 liters and allow to stand for one hour. Then stir in 200 cc. of a 20 per cent milk-of-lime solution, cold, and allow to stand for two hours. This causes the precipitation of all the zinc as zinc hydrate. The liquor is then strained to free it from sediment and preserved in a closed bottle. The hydrosulphite solution thus prepared, if kept in a cool place, will last for several weeks, and its keeping quality will be enhanced by the addition of a small quantity of caustic

* The caustic soda may be replaced by 140 cc. of milk-of-lime (20 per cent). The latter, however, is objectionable on account of the sediment in the vat. Where lime is used in the vat it is also necessary to acidify the dyed material to remove traces of lime.

soda solution. When zinc dust reacts with a solution of sodium bisulphite the following chemical change takes place:



Sodium hydrosulphite is a strong reducing agent, being itself oxidized finally to sodium bisulphate, NaHSO_4 . Its use forms a very convenient means for the preparation of dyeing solutions of Indigo as well as the other vat dyes. The sodium hydrosulphite solution is usually prepared by the dyer as a stock solution, and used as occasion requires for the reduction of the dyestuff to be added to the vat.

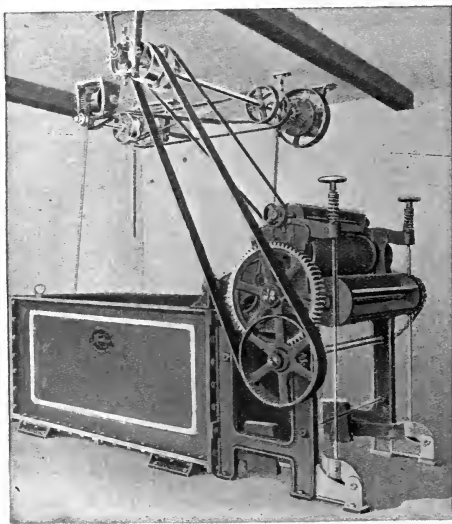

FIG. 228.—Indigo Dyeing Machine. (James Hunter Machine Co.)

Exp. 151. Dyeing Indigo with Hydrosulphite Vat.—Prepare the dyevat as follows: to one liter of water (120° F.) add 2 grams of hydrosulphite powder (or 10 cc. of the above prepared hydrosulphite liquor); 0.5 cc. of ammonia water, and 4 cc. of glue solution (1:10); allow to stand for fifteen minutes, then run in 100 cc. of the stock Indigo solution by means of a long-tubed funnel. Stir gently and allow to stand for thirty minutes. When the liquor is clear and of an amber-yellow color it is ready for use. Take a test skein of cotton yarn which has been boiled out and squeezed (but not dried) and pass it through this indigo vat without heating. Take care to manipulate the dyeing so as to disturb the liquor as little as possible, as much exposure to the air will cause undue oxidation and considerable Indigo will be precipitated in the vat. When the skein has become thoroughly and evenly saturated with the liquor, squeeze it out well, and

then expose the skein to the air for five to ten minutes. When the skein first comes from the vat it should be of a yellowish green color; on exposure to the air it soon turns blue. The dyed skein is then washed well in water and afterwards in a warm soap solution in order to remove all alkali and unfixed dyestuff. Dye a second test skein of cotton yarn in a similar manner, but after oxidizing in the air give it a second passage through the indigo vat and oxidize again, after which wash and soap. This will represent the color obtained by two dips. In the same manner dye a third skein, giving it four dips. Also dye skeins of woolen yarn in the same manner, giving one dip, two dips and four dips. For the woolen yarn use a first wash water acidulated with a little sulphuric acid in order to neutralize the alkali; then wash well again in plain water and finally soap. If the dyevat turns bluish owing to oxidation a fresh quantity of hydrosulphite must be added, the liquor stirred gently and allowed to stand for fifteen minutes. When the vat is maintained for some time a little ammonia and glue solution are occasionally added. To maintain the proper dyeing strength of the vat fresh additions of the stock solution of Indigo are made from time to time as needed. If too much hydrosulphite is present in the vat the color will not be well taken up and the blue will not develop quickly on exposure to the air.

The hydrosulphite vat for Indigo is the simplest and the most popular method of applying this dyestuff at the present time. Other forms of vats, depending on the nature of the reducing agent, have been used. The *fermentation vat* is the oldest form of Indigo dyeing and is still used to a considerable extent in wool dyeing. Its operation depends on the reducing action of certain ferments, and it is prepared with bran, woad, and madder. The woad is supposed to furnish the particular ferment while the bran and madder serve as nourishment for the growth of the ferment. The alkali employed is lime, which serves the double purpose of neutralizing the acid liberated in the fermentation and providing the alkali necessary for the solution of the reduced Indigo. The fermentation vat is difficult to prepare and also difficult to maintain in proper working condition. The warm fermentation vat is employed where the work is regularly continuous; where rapid dyeing is desired or where the dyeing is irregularly carried on, the hydrosulphite vat is more advantageous. The cold fermentation vat is largely used in Oriental countries, where time is not an essential factor in the operation. The *copperas vat* employs ferrous sulphate as the reducing agent and lime as the alkali.* It is a cumbersome and unsatisfactory method and is not used at present. The *zinc vat* uses zinc dust for the reducing agent and either lime or caustic soda as the alkali. It is quite an efficient form of vat and is still employed considerably

* A copperas vat of medium strength may be prepared as follows:

20 lbs. Indigo paste.
25 lbs. quick-lime.
20 lbs. copperas.

Make up to 40 gallons and allow to stand for four to six hours with occasional stirring. When the color of the liquor is yellow it is ready for use. This forms the stock vat and the liquor is poured off from the sediment into the dyeing vat as needed. As long as the sediment is yellow in color the vat is in proper condition, and if the liquor becomes blue during working, on stirring up and settling it will turn yellow again. When the reducing power of the sediment becomes exhausted more copperas and lime must be added. In the copperas vat a considerable portion of the Indigo is destroyed by over-reduction or by the formation of a useless iron compound. This loss generally amounts to 25 per cent, though this may be increased if the stock-vat is kept too long. The advantage the copperas vat possessed over the old form of fermentation vat was that it was comparatively easy to set and did not easily get out of order.

in cotton dyeing.* All of these vats, however, contain a large amount of sediment, and care must be taken in dyeing not to disturb this sediment or it will get into the goods being dyed. There is also considerable loss of Indigo in these vats, whereas in the hydrosulphite vat there is no sediment, and the loss of Indigo is exceedingly small.

Test the fastness of the Indigo dyeings to light, washing, fulling, acids, and chloring (on cotton).

Exp. 152. Reactions of Indigo.—(1) Take about 1 cc. of Indigo paste in a small test tube, and 1 cc. caustic soda solution, then fill the tube with hydrosulphite solution, stop with a cork and shake well until the Indigo is all reduced and a clear yellow solution results. The following reaction has taken place:

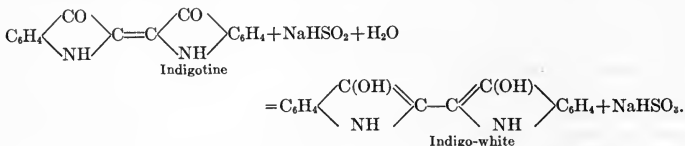

Now add a few drops of hydrochloric acid to the solution of indigo-white, taking care to avoid the introduction of any air, which will cause the formation of indigo blue. As the solution becomes neutralized a white flaky precipitate of indigo-white separates out.

(2) Place a drop of Indigo paste in a test tube, shake with a little water, and then add several drops of a solution of potassium permanganate. The Indigo will be decolorized due to the strong oxidizing action of the potassium permanganate. On this is based the method of analysis of Indigo samples.

(3) Repeat this test, using a few drops of potassium bichromate solution instead of permanganate. The Indigo will also be decolorized. This reaction is used very largely in the discharge of Indigo in calico printing.

(4) Repeat the test, using instead of potassium bichromate a solution of hydrogen peroxide. The same effect will be obtained.

(5) Repeat the test, using an acid solution of stannous chloride and apply heat. The color of the Indigo will be rapidly discharged.

(6) Place a small quantity of Indigo powder in a test tube; add a few cc. of clear aniline oil and warm carefully (vapors of aniline are inflammable). The Indigo will pass into solution giving a bluish or greenish blue liquid (greenish on account of the yellowish color of the aniline oil).

* The zinc-lime vat may be prepared in the following manner:

20 lbs. of Indigo paste.

2½ lbs. of zinc dust.

8 to 10 lbs. of quicklime previously slaked to a uniform paste.

16 gallons of hot water.

This mixture is stirred occasionally during three to five hours, when it should be yellow in color and ready for use. This forms the stock solution. The dyevat (for 200 gallons) is set with ½ lb. of zinc dust and 2 lbs. of lime (slaked), stirred up and allowed to stand for some hours. The stock liquor is then added. This vat is in good working condition when its sediment is yellow in color. It is freshened up by additions of ½ to 1 lb. of zinc dust and 1 to 2 lbs. of lime. In the zinc vat the loss of dyestuff is less than 10 per cent, in which respect it has an advantage over the copperas vat. The sediment is also not so large, hence it may be maintained in use for a much longer period of time.

(7) Repeat this test, using a few cc. of glacial acetic acid, which will also be found to dissolve the Indigo. On adding water the Indigo will be reprecipitated. Indigo is also soluble in nitrobenzene, but not in alcohol or ether.

(8) To a small quantity of Indigo powder in a test tube add a few cc. of concentrated sulphuric acid and warm gently. A deep blue solution results; dilute with a large amount of water, bring to a boil and dye a skein of wool therein. The Indigo has been converted into Indigo Extract, an acid dye.

(9) To a small quantity of Indigo powder in a test tube add a few cc. of concentrated nitric acid. The Indigo is decolorized, and becomes yellow. This is the basis of the nitric acid test for Indigo.

(10) To a small quantity of Indigo paste in a test tube add a few cc. of a solution of chloride of lime. The Indigo will soon be decolorized.

Exp. 153. Indigo Extract.—(1) Starting with 100 grams of powdered Indigo, prepare a sample of Saxony Blue as described on page 431. Using a small quantity of this as a dyestuff, dye several samples of loose wool, yarn, and cloth. The dyebath will not require the addition of any acid, as the extract itself contains considerable excess of sulphuric acid; add, however, 20 per cent of Glaubersalt to the bath, and dye in the usual manner for acid colors.

(2) Take about one-fifth of the Saxony Blue paste, dilute with twice its volume of water, and pour into a saturated solution of salt; filter off the precipitate formed, and preserve as a sample of *acid indigo extract*. Dye several samples of wool with a small amount of this extract, in the manner above described.

(3) Take another fifth part of the Saxony Blue paste, dilute with twice its volume of water, and pour into a saturated solution of salt; filter off the precipitated coloring matter. Dissolve in a small amount of water; add a solution of sodium carbonate until effervescence ceases; then pour into a saturated solution of salt again, and filter. Test the precipitate for acid, and if not perfectly neutral repeat the operations again. Preserve this sample as *sweet extract of indigo*; and dye several samples of wool therewith, employing the usual acid dyebath of 4 per cent sulphuric acid and 20 per cent Glaubersalt. Compare with the several samples for purity and clearness of tone. Also compare these colors obtained with Indigo Extract with those prepared from vat Indigo. It will be found that the extract gives much brighter shades, and that the tone is somewhat different. Make tests on samples of the two colors for light (thirty days' exposure); washing, fulling, acids, and alkalies. It will be found that vat dyed Indigo is a great deal faster than the extract.

Exp. 154. Use of Thio-Indigo Red.—Stir 50 grams of Thio-indigo Red B paste with 200 cc. of water, add 10 cc. of caustic soda solution of 76° Tw., then gradually stir in 10 grams hydrosulphite powder (Blankit T). Heat to 120° F. and allow to stand for two hours, or until the reduction is complete and the solution is of a yellow color. Dilute to one liter and preserve as a stock solution for dyeing. For the dyevat take 400 cc. of water of a temperature of about 100° F., add 20 grams of salt, a small quantity (0.1 gram) of hydrosulphite powder and a few drops of caustic soda solution (76° Tw.). Stir well, allow to stand for fifteen minutes and then add 100 cc. of the stock dye solution. Stir gently and allow to stand for one hour, when the vat should be of a clear yellow color and ready for dyeing. Steep a test skein of cotton yarn in this vat for fifteen minutes, then squeeze and oxidize in the air for thirty minutes. Dye another skein in the same manner, giving it three dips, and a third skein, giving it five dips. The addition of salt is for the purpose of causing a more rapid fixation and better exhaustion of the dyestuff. The bath may be strengthened by further additions of the stock solution. If the bath becomes red and loses its clear yellow color a little more hydrosulphite powder should be added, and the liquor stirred gently and allowed to stand for fifteen to thirty minutes to allow it to become thoroughly reduced again.

Prepare a vat with Thio-indigo Scarlet R in the same manner as above and make dyeings with one dip, three dips and five dips.

When the dyeings have been exposed to the air sufficiently to become thoroughly oxidized, they should be well washed in water and then in warm soap solution to remove all unfixed dyestuff and chemicals.

Test the fastness of the two dyestuffs to light, washing, and bleaching.

Exp. 155. Use of Indanthrene Blue.—Prepare a dyebath with 400 cc. of water, 8 cc. of caustic soda solution (53° Tw.), and 8 grams of Blankit T. Heat to 120° F., and then stir in 2 grams (20 per cent) of Indanthrene Blue GCD. When the liquor is clear and shows no undissolved particles (test by dropping on a piece of filter paper), the bath is ready for dyeing. Dye a test skein of cotton yarn in this bath for one hour at 120° F. Keep the cotton beneath the liquor and expose the bath as little as possible to the action of the air. After dyeing rinse well in water, then in water slightly acidulated with sulphuric acid, and finally in a dilute soap bath. Test the fastness of this color to light, washing, and bleaching.

The Indanthrene colors are best applied in mechanical dyeing apparatus so that the liquor during circulation comes into contact with the air as little as possible. The Indanthrene dyestuffs are somewhat different in their behavior than the Indigo dyes, as they exhaust very well from the bath and the color dyes up directly on the fiber and does not require a subsequent oxidation. On this account the amount of coloring matter to be used may be based directly on a percentage of the material dyed.

Exp. 156. Use of Indanthrene Yellow.—Prepare a dyebath as above, using 10 per cent of Indanthrene Yellow G, and dye a test skein of cotton yarn for one hour at a temperature of 140° F. It will be noticed that this dyestuff on reduction gives a blue solution and that the cotton is blue in color when first taken from the dyebath. For the better development of this color, after dyeing, squeeze, rinse in water, and then pass through a very dilute cold solution of chrome (0.1 gram per liter). This facilitates the oxidation of the color very materially. Finally wash well and soap as usual. Test this color for fastness to light, washing, and bleaching.

Exp. 157. Production of Fast Pink with Indanthrene Dyes.—Prepare a dyebath as in Exp. 155, using 3 per cent of Indanthrene Red B, and dye a test skein of cotton yarn for one hour at 140° F. Wash well and rinse in dilute acid, and finally soap. This color gives a rather bright pink when used in small percentages and the color is very fast to light, washing, acids, and bleaching. By combining with small amounts of Indanthrene Yellow R, bright yellowish pinks may be obtained.

Exp. 158. Use of Ciba Blue.—Prepare the dyevat as follows: Make a paste with 0.5 gram of Ciba Blue 2B (powder), 1 cc. caustic soda (76° Tw.) solution, and some hot water; also dissolve 2 grams of hydrosulphite powder (Blankit T) in 15 cc. of cold water and 1 cc. of caustic soda solution. Then add this hydrosulphite solution to the dyestuff, dilute to 400 cc. with hot water and slowly boil. The dyevat should then be completely reduced and be of a golden-yellow color. Dye a test skein of cotton yarn in this bath for thirty minutes at 170° F., squeeze well, and allow to oxidize in the air for fifteen minutes; then rinse well in cold water, and finally work in a boiling dilute soap bath. The treatment with the boiling soap bath very materially brightens the color, and also gives it greater fastness to washing and bleaching. A still greater fastness to bleaching may be obtained by an after-treatment with bluestone in the usual manner.

CHAPTER XIX

ANILINE BLACK

1. Chemistry of Aniline Black.—The method of dyeing with Aniline Black was discovered by Lightfoot in 1863.* It is a dyestuff formed on the fiber by the proper oxidation of aniline, and gives a very fast black color. It is used almost exclusively on cotton, although it may be applied by special means to both silk and wool. Its principal use is for the dyeing of fast blacks on hosiery, and for the dyeing of blacks in calico printing.

When aniline (also its homologues toluidine and xylydine) is treated with strong oxidizing agents a black substance is obtained known as *nigraniline*, though there is said to be an intermediate product formed called *emeraldine*, which is a green compound. The chemical composition and constitution of Aniline Black have never been satisfactorily solved, although the properties of both emeraldine and *nigraniline* have been thoroughly investigated.† Besides the two products mentioned, it is claimed that a third, called *ungreenable black*, is also formed in the production of Aniline Black.‡ Unless the aniline is completely oxidized, the black obtained is subject to the defect of turning green on exposure to the air; it is therefore important to secure complete oxidation.

The theory of Aniline Black dyeing is to impregnate the cotton material with aniline salt and an oxidizing agent, and then by ageing or by treatment

* A full account of Lightfoot's work on this subject may be found in his book entitled "Chemical History and Progress of Aniline Black." His first patent on Aniline Black was Eng. Pat. 151 of 1863.

† See Willstätter and Moore, *Berichte*, 1907, p. 2665; Willstätter and Dorogi, *Berichte*, 1909, pp. 2148, 4118; Willstätter and Cramer, *Berichte*, 1910, p. 2976; 1911, p. 2162; Nover, *Berichte*, 1907, p. 288; A. G. Green, *Jour. Soc. Dyers and Col.*, 1909, p. 189; Green and Wolff, *Jour. Soc. Dyers and Col.* 1913, p. 105; Green and Woodhead, *Jour. Chem. Soc.*, 1910, p. 2388; 1912, p. 1117; Green and Johnson, *Jour. Soc. Dyers and Col.* 1913, p. 338.

‡ The oxidation of aniline oil to Aniline Black is said to proceed in three well-defined stages: (a) the formation of *emeraldine*, the free base of which is blue though its acid salts are green (this being the color of the dyed cotton as it comes from the ager); (b) the conversion of emeraldine into *nigraniline*, of which both the free base and salts are dark blue, but which are reduced by sulphurous acid to the green, emeraldine; (c) the conversion of the *nigraniline* into the *ungreenable Aniline Black* which is not reduced by sulphurous acid to emeraldine.

with an acid solution of potassium bichromate, to develop the black dye-stuff in the fiber. Potassium chlorate is the favorite oxidizing agent used. The action of this on the aniline whereby nigraniline is produced appears to be rather complex. Chloric acid itself does not convert aniline into Aniline Black, as a solution of aniline chlorate can be boiled without decomposition, but if a small amount of acid is added the black is immediately formed. The same result is produced by the presence of certain metallic salts the chlorates of which are readily decomposed; such as copper, manganese, iron, vanadium,* and cerium. These salts act as catalyzers, bluestone being the one chiefly employed. The bichromate of aniline acts in the same manner as the chlorate.

In the dyeing of Aniline Black on cotton there is precipitation of a considerable amount of pigment in the fiber, as the weight of the cotton is increased about 10 per cent.

Of recent years a new process for dyeing Aniline Black without the use of oxidizing agents has been patented by A. G. Green. In this method there is used a small proportion of para-phenylene-diamine or para-aminophenol and ageing (oxidation) in the air is resorted to; this method gives a very fine black that is ungreenable and there is little danger of tendering the fiber.†

The number of methods employed for the dyeing of Aniline Black are legion, almost every dyer of this color having his particular formula and method of operation. In general, however, the different methods may be divided into three classes as follows:

(1) *Single-bath Black*.—This is principally used for dyeing yarn‡ (either as warp or skein). Frequently a bottom of Sulphur Black is used and the Aniline Black is dyed over this. Chrome is used for the oxidation.

(2) *Aged or Oxidation Black*.—This is chiefly used for dyeing piece-goods (either as woven cloth or knitted fabrics like hosiery), the dye liquor being padded into the goods. Sodium chlorate and bluestone are used as the oxidizing agents; though with Green's process para-phenylenediamine and bluestone are so used. The oxidation is effected by ageing the goods in a warm-air chamber, and is usually completed by giving a bath of chrome.§

* It is said that 1 part of vanadium (as ammonium vanadate) is sufficient to effect the oxidation of 270,000 parts of aniline salt when mixed with sodium chlorate.

† The catalytic agent in this case is the para-phenylene-diamine and bluestone.

‡ The single-bath method is the simplest to dye, but the color obtained is not fast to light or fulling; it also crocks more or less badly and is not fast to light bleaching. It is also turned green by sulphurous acid. It is most used for black yarn for the export trade.

§ The production of Aniline Black by the ageing process is chiefly employed for the dyeing of hosiery; it gives a fine shade of black fast to light, washing and bleaching; it is not turned green by sulphurous acid.

(3) *Steam Black*.—This is used chiefly in cloth dyeing and in printing. Potassium ferrocyanide is usually employed as the catalyzer for this method; the cloth being padded with a solution of aniline salt, sodium chlorate, and ferrocyanide, then steamed for a few minutes in an ager. If an alkaline paste is printed on before steaming the black does not develop and thus white resists may be obtained.

2. Dyeing of Aniline Black; One-bath Method.*—A large number of methods or recipes for this process of dyeing are available, among which the following have been selected (based on the dyeing of 100 lbs. of cotton yarn).

(1) Prepare the bath with 5 lbs. aniline oil, 12 lbs. hydrochloric acid, and 6 lbs. chrome; or use 3.6 lbs. aniline oil, 3.6 lbs. hydrochloric acid, 2 lbs. sulphuric acid, 9.8 lbs. chrome and $\frac{1}{2}$ lb. bluestone. Enter the goods cold, work one hour, then raise to boil in one hour and dye at boil for one-half hour. Rinse and soap † (Höchst).

(2) Make two solutions as follows: (a) 12 lbs. aniline, 18 lbs. hydrochloric acid, 24 lbs. sulphuric acid, 45 gallons water; and (b) 24 lbs. chrome in 45 gallons water. Allow to cool; mix in equal parts and steep the yarn therein in small lots (2 lbs. at a time) for a few minutes; a bronzy black is developed, wring out and steam for twenty minutes at $3\frac{1}{2}$ lbs. pressure ‡ when a jet black that is ungreenable will be produced, wash and soap at the boil. If hydrochloric acid alone is used a bluish black will be obtained, and sulphuric acid alone gives a reddish black; but a mixture of the two gives a jet black § (Noelting).

(3) Prepare a bath with 10 lbs. chrome, 2 lbs. sulphuric acid and 3 lbs.

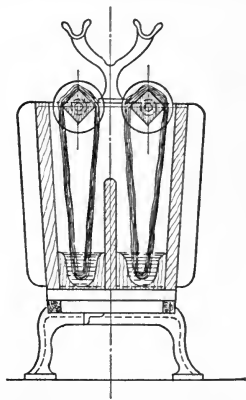

FIG. 229.—Vat for Dyeing Yarn With Aniline Black.

* The one-bath method is also known as "dyed black." The dye is not as well fixed in this process as with an aged black; also the color usually rubs badly and has a dead flat appearance. But the fiber is not so liable to be tendered as with an aged black.

† For soaping use 5 to 10 lbs. of soap per 150 gallons of water. It is also beneficial to add 1 to 2 ozs. of olive oil to the soap bath as this gives increased softness and brightness. The soaping also increases the fastness of the color; this can also be improved by steaming.

‡ If the black is not steamed at this rather high temperature the color is liable to turn green.

§ Logwood may be used for topping Aniline Black to influence the tone and to make the color more bloomy. The Logwood is fixed directly as there is already sufficient chrome on the fiber to act as a mordant.

hydrochloric acid in 80 gallons water; stir well and add 5 lbs. aniline salt previously dissolved. Work the yarn in the cold bath for $1\frac{1}{2}$ hours; heat to 120° F., in one hour raise to 175° F. Rinse well and soap (Badische).

(4) Prepare a bath with 13 lbs. aniline salt, 20 lbs. hydrochloric acid, 14 lbs. chrome (previously dissolved in hot water) and 200 gallons water.* Work the yarn cold for one hour; raise slowly to 175° F. for one-half hour. Rinse and soap (Oehler).

(5) Prepare a bath with 14 lbs. aniline salt, 13 lbs. chrome, 2 lbs. blue-stone, 2 gallons hydrochloric acid and 200 gallons water. Work the yarn in cold bath for one and one-half hours, then raise to boil in forty-five minutes. Then work in fresh bath containing 4 lbs. copperas and 6 lbs. sulphuric acid for ten minutes at 200° F. The second bath removes the bronzy appearance of the black. Finally wash and soap.

(6) For a cold process prepare the following solutions: (a) 8 lbs. aniline oil, 16 lbs. hydrochloric acid, 4 gallons water; (b) 20 lbs. sulphuric acid, 4 gallons water; (c) 14 lbs. chrome, 4 gallons boiling water; (d) 10 lbs. copperas,† 4 gallons water. Use a dyebath of 300 gallons cold water; add one-half of the solutions in the order given; work the yarn cold for one hour; lift and add remainder of solution; work yarn for one and one-half hours more. Rinse and soap ‡ at the boil.

(7) According to Hummel Aniline Black may be dyed in the form of a vat like Indigo.

The Aniline Black is first prepared separately, namely, by heating a solution containing aniline hydrochloride, potassium chlorate, ammonium chloride, and copper sulphate. The black pigment thus produced is purified by boiling with water, and afterwards with alcohol. It is then heated with a solution of caustic potash, and the color-base of the black thus liberated is washed, dried, and dissolved in fuming sulphuric acid. This solution is poured into cold water, and the greenish black precipitate thus produced is dissolved in caustic alkali, and reduced by heating with the addition of glucose, hydrosulphite of soda, or zinc powder. Ferrous sulphate and lime are inoperative. If cotton be steeped in the brownish yellow solution thus obtained, and then exposed to the air, it acquires gradually a blue color. By submitting this color to a supplementary oxidation it changes to a light gray or deep black, according to the concen-

* The aniline salt should be dissolved first, then the acid is added and afterwards the cold solution of the chrome.

† The use of the copperas is for the purpose of rendering the black less liable to turn green; in the bath it is changed to ferric sulphate, and this acts as an oxidizing agent.

‡ By adding a small amount of soda ash to the soap bath the color is given a bluer tone. The same effect may also be produced by using a small amount of Methyl Violet, and this also makes the color faster to greening.

tration of the vat. A judicious combination of the aniline black vat with an indigo vat may yield very fast deep blues.*

(8) Whittaker furnishes the following formula: 20 lbs. sodium bichromate are dissolved in hot water and added to the cold dyebath; then add 10 lbs. of iron liquor, then 10 lbs. sulphuric acid, and stir up the bath well. Next mix up 10 lbs. aniline oil with 10 lbs. hydrochloric acid in a bucket with a little water to prevent fuming; stir until the aniline is completely dissolved, and add the solution to the dyebath just before the yarn is entered. Work the yarn for one hour cold, then slowly raise to the boil. Wash off well, soap at the boil and treat with an emulsion of oil.

3. Aged or Oxidation Black.—In this method the oxidation is principally effected by exposure to warm moist air, though it is necessary to have present with the aniline on the fiber some form of catalyzer, or “carrier” of oxygen, as the oxygen of the air does not act directly.†

The dye liquor with its various ingredients is made up in a rather concentrated form, and in the case of cloth, the liquor is padded on in a suitable padding machine. In the case of hosiery (which is very largely dyed by this process) the liquor is padded into the made-up hose in a tramping machine which is known as a “tom-tom,” the liquor being forced into the fiber by the blows of wooden hammers that rise and fall. After thorough saturation and removal of the excess of liquor, the goods are dried and aged in a suitable room or apparatus in which a moist heat can be maintained.‡

* Aniline Black is sometimes used in connection with substantive blue or black dyes on cotton in order to obtain a deep fast black. After the cotton has been dyed with the substantive color it is treated with a cold bath prepared as follows: 4 per cent chrome, 2 per cent copper sulphate, 3 per cent aniline salt, and 4 per cent sulphuric acid. The goods are worked in the cold bath for one-half hour, and then the bath is gradually heated to 160° F. and run at that temperature for one hour. Squeeze, allow the goods to cool down in the open air, wash, soap, and dry. In preparing the bath the chrome and bluestone should be dissolved separately in as little hot water as possible, so as not to increase the temperature of the cold aniline bath, and both of these solutions should be added directly to the bath just before entering the cotton. The black obtained in this manner is much faster than that produced by the substantive dyes alone, also the fiber is better preserved than when oxidation Aniline Black is used, and the color is faster to rubbing than when the single-bath Aniline Black process is used.

† In the oxidation there are four essential ingredients: (a) aniline (either oil or salt); (b) oxidizing agent (usually sodium chlorate); (c) an oxygen carrier (copper sulphide, copper sulphate or vanadium salt); (d) a hygroscopic substance (ammonium chloride). The latter also acts by its dissociation at the high temperature of ageing in starting the reaction.

‡ When the goods are squeezed or hydro-extracted, they should contain about their own weight of liquor. Sometimes the padding liquor is made more viscid by the addition of starch or dextrin. This favors a more even distribution and penetration of the dye liquor. A recipe of this kind especially suitable for padding yarn is as follows: (a) 3 lbs. aniline oil are mixed with 3 lbs. hydrochloric acid; (b) 1½ lbs. bluestone, 1½ lbs. ammonium chloride and 1½ lbs. potassium chlorate are dissolved in water; (c)

The proper regulation of the temperature and moisture is very important in order to prevent tendering, as much acid fume is developed in the ageing. Special ageing machines are built so as to permit of accurate regulation of air, heat, and steam. The ageing is usually done at a temperature of 110 to 115° F. Provision should also be made to keep the goods in motion; in the case of cloth the material is generally slowly passed through the ager continuously; with hosiery, a large rotating cage is usually provided which tumbles the goods about so as to expose all parts uniformly to the air and steam. Unevenness of treatment is to be carefully avoided, otherwise streaks and stains will result.

When the goods have been sufficiently aged they show a dark green or blackish green color. The time of ageing is important, and can be told only by experience with the special form of goods, formula of dye, and the conditions of ageing. It is also important that proper moisture be maintained during the ageing, as this is very essential, not only to the development of a good black, but also to prevent tendering of the cotton.* Experienced workmen can usually tell when the ageing is properly completed by the color of the goods. After ageing, the goods are chromed in a bath containing 4 ozs. chrome and 1 oz. sulphuric acid per 10 gallons water at 160° F. They are finally soaped hot in a solution containing 4 ozs. soap per 10 gallons water, then rinsed and dried. If the chroming is done at a higher temperature the black will show a redder shade.

The following are some recipes recommended for the ageing method of dyeing Aniline Black:

(1) For 1000 parts of liquor of 15° Tw., use 126 parts aniline salt, 40 parts sodium chlorate, 150 parts aluminium acetate (22° Tw.), 5.7 parts ammonium chloride, and 3 parts bluestone. The dye liquor for padding is diluted to 12° Tw. and refreshed with additions of above standard solution of 15° Tw. After impregnation, drying, and ageing chrome for one-half hour at 140° F., in a bath containing 2½ per cent chrome, ½ per cent aniline salt and ¼ per cent sulphuric acid. Rinse well and soap. (Höchst.)

(2) Pad with the following liquor, which is made from the solutions prepared separately, mixed cold and made up to 100 gallons with water: 120 lbs. aniline salt in 30 gallons water; 5¼ lbs. bluestone in 10 gallons water; 38 lbs. sodium chlorate in 8 gallons water; 4 lbs. ammonium chloride in 3 gallons water; 5 gallons aluminium acetate solution (150° Tw.). ½ lb. starch is boiled up with water and diluted. When cold, (a) is mixed with (b) and then (c) is added and made up to 5 gallons with water. Pad in this liquor, age at 90° F., chrome, wash, and soap.

* The goods should not be washed between the ageing and the chroming. The ageing usually lasts from six to eight hours. During the ageing it is important that drops of water do not come in contact with the goods, as gray spots will be formed. Also alkali must not come in contact with the material before ageing, as this will form a resist to the development of the black and make a white spot.

Impregnate so that cloth retains own weight of liquor; dry at 100° F.; age for several hours at 100° F., then chrome and soap. (Oehler.)

(3) Green's method (Eng. Pat. 16189, of 1907), which is said to be very successful, is as follows: The padding liquor consists of a solution of 48 parts cupric chloride, 140 parts ammonium chloride, and 14 parts sodium meta-bisulphite in 500 parts cold water; this is added to a solution of 50 parts aniline, 2 parts para-phenylene-diamine, 15 parts hydrochloric acid, and 15 parts formic acid in 1500 parts cold water. The material is padded with this solution, dried, aged, and chromed as usual.



FIG. 230.—Impregnating Machine for Yarn. (Haubold.)

(4) Vanadium salt is sometimes used as a catalyzer as follows: Prepare a liquor with 90 parts aniline salt, 20 parts aniline oil, 40 parts sodium chlorate; 5 parts vanadium chloride solution (1 : 100), and 845 parts water. Pad the material with this solution, dry, age, and chrome as usual. The vanadium chloride solution is prepared with 10 parts ammonium vanadate, 70 parts hydrochloric acid, 40 parts water, 7 parts glycerin; make up to 1000 parts with water and heat until the solution becomes blue in color. Vanadium black is more used in printing than in dyeing, as in using it there is great danger of tendering the fiber.

Whittaker gives the following formulas for aged Aniline Black:

(5) For a black fast to bleaching on yarn, using bluestone, dissolve 60 parts aniline salt in 320 parts water and make perfectly neutral, if necessary, by the addition of aniline oil; $2\frac{3}{4}$ parts copper sulphate in 50 parts of water, 19 parts sodium chlorate in 37 parts of water, 2 parts ammonium chloride in 12 parts water, and 24 parts aluminium acetate 15° Tw. On mixing these together the resulting liquor should stand at about 12° Tw. Pad the yarn in this liquor 2 lbs. at a time, and wring out so that it holds its own weight of liquor. Dry in a hot room at 95° F. on sticks which

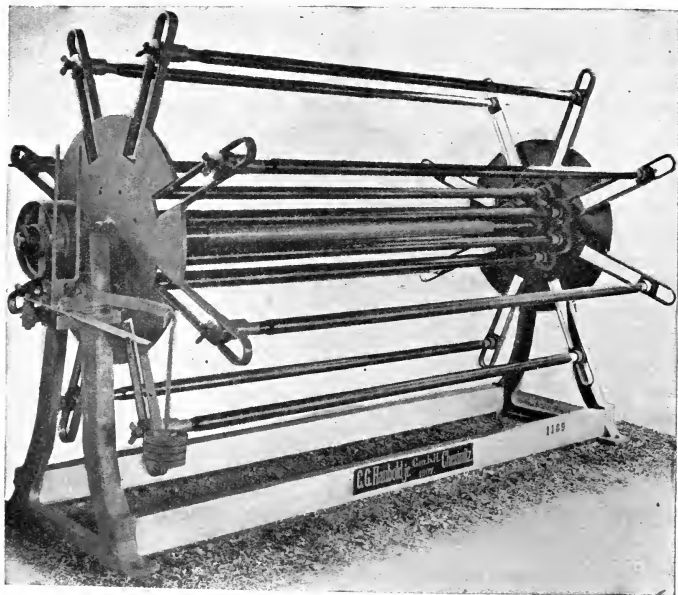

FIG. 231.—Yarn Drying Machine. (Haubold.)

have been saturated with the above liquor to avoid stick marks. Turn the yarn every two hours (the workmen should have dry hands, as wet hands will make finger marks). When dry turn steam into the hot room till the dry bulb shows 95° F. and the wet bulb 86° F. Keep at this temperature for six hours, when the yarn shows a dark bottle-green color. Then chrome for fifteen minutes at 180° F. with 4 per cent of chrome and 1 per cent of sulphuric acid. This gives a jet black color. Wash well and soap for fifteen minutes at 180° F.

(6) In another recipe copper sulphide in the form of a paste is used as the oxygen carrier. It is made as follows: $37\frac{1}{2}$ parts copper sulphate are dissolved in 150 parts water; add 39 parts sodium sulphide (crystals) in 100 parts water; filter and press to 54 parts, in which form it is used. The dye liquor is made with 15 parts aniline salts made neutral with aniline oil, 5 parts copper sulphide paste, 5 parts sodium chlorate and 75 parts water. Cloth is padded with this liquor and then squeezed till it retains its own weight of the solution. Dry and give a three-minute passage through an ager at 140° F. Then chrome, wash, and soap.*

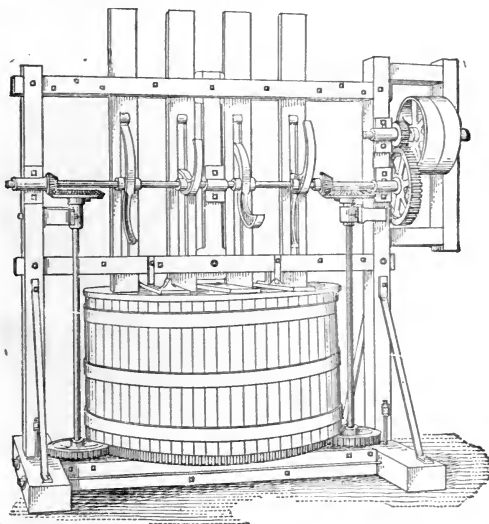

FIG. 232.—Tom-Tom Machine for Hosiery. (Delahunty Dyeing Machine Co.)

4. Steam Black with Aniline.—This is really a rapid method of ageing the Aniline Black by steaming and ferrocyanide of potash is used as the carrier of oxygen. The ageing is carried out in a steam chamber through which the goods pass continuously.† The method is principally used for black on piece-goods and for printing. After impregnation of the material with the dye liquor, the pieces are dried rapidly, steamed for about three

* The copper method is used more than the vanadium process because with the latter the liquor oxidizes more quickly, and hence it is not as stable.

† It is said that the steam black gives a color less liable to turn green than the black obtained by the ageing process. Also the danger of tendering the fiber is less. As the color is not developed so far in the steaming the after-chroming must be more thorough.

minutes, chromed, washed, and soaped. The following are typical recipes for padding liquors:

(a) Prepare a liquor with 75 parts aniline salt, 35 parts sodium chlorate, 40 parts potassium ferrocyanide, and make up with water to 1000 parts.

(b) Use 40 lbs. aniline salt in 6 gallons water, 26 lbs. potassium ferrocyanide in 15 gallons water, and 15 lbs. sodium chlorate in 3 gallons water. For light delicate goods, it is well to make the padding liquor slightly alkaline with ammonia (Oehler).

5. Aniline Black on Other Fibers.—Owing to the reducing action of wool and silk Aniline Black does not develop on these fibers as on cotton, also owing to the very satisfactory blacks available for wool there is no



FIG. 233.—Oxidizing Machine for Hosiery.

especial call for Aniline Black in this field.* A special application of Aniline Black, however, is made to a class of silk and mohair pile fabrics used for making imitation chinchilla, giving the goods a black color with white tips. The process is carried out as follows: Work the goods for fifteen minutes in a cold bath containing 5 parts potassium permanganate, 7 parts magnesium sulphate,† and 100 parts water. Gradually raise the temperature to 120° F. for one-half hour, then wash and dry. The fiber now has a dark-

* Lightfoot (in 1865) showed that by chlorinating the wool before dyeing or printing the fiber could be so prepared as to take the color of Aniline Black. Many other processes have also been suggested for the application of Aniline Black to wool, but none of these has had any commercial success.

† The magnesium sulphate is used to neutralize the caustic alkali that is liberated from the permanganate and so prevent its action on the fiber.

brown color due to the oxide of manganese. To make the white tips a "cutting" liquor is prepared as follows: 3 qts. hydrogen peroxide, 1 pint acetic acid and 1 oz. oxalic acid in 1 pint water. This is suitably thickened with British gum to make a paste which is brushed on the goods in any desired design. The cloth is then dried and the black developed by washing for ten minutes in a cold bath of 1000 parts water, 5 parts aniline oil and 5 parts sulphuric acid. The color is then further developed by soaping at 100° F. with the addition of a little ammonia. The cutting paste acts as a resist and leaves the fiber white.

6. Diphenyl Black.—This is an oxidation black similar to Aniline Black, but uses para-amino-diphenylamine in place of aniline. It is dyed in

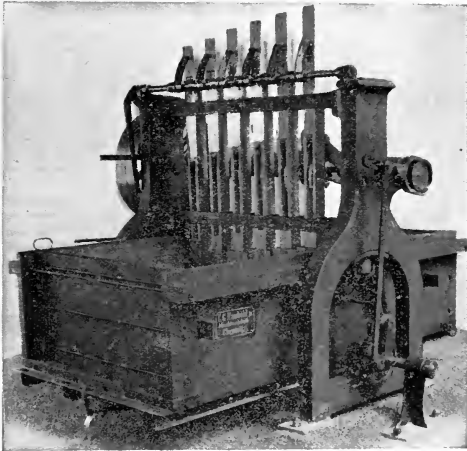

FIG. 234.—Tom-Tom with Reciprocating Motion. (Haubold.)

practically the same manner by the ageing process, but an after-chroming is not necessary. It is also claimed to be ungreenable, and not to injure the fiber. It is chiefly employed on piece-goods and for suiting. The padding liquor is made up as follows: (Höchst.) (a) 6 lbs. gum tragacanth gum (1:10) and 1 gallon water, 4 lbs. Diphenyl Black Base dissolved warm in 5 lbs. lactic acid (50 per cent) and 13 lbs. acetic acid (40 per cent); add water to make up to 50 lbs.; (b), 2½ lbs. aluminium chloride (53° Tw.), 6.4 ozs. cupric chloride (77° Tw.), and 4 gallons water; then add 3 lbs. sodium chlorate dissolved in 1 gallon boiling water and 1 lb. oil of turpentine; dilute with water to 100 lbs. After padding, age for one-half

hour and steam in a Mather-Platt steamer for two minutes; soap at 140° F., rinse and dry.*

7. Paramine Brown.—This is a color produced on the fiber by the oxidation of para-phenylene-diamine.† It is dyed in a manner similar to that of steam Aniline Black. It is dyed in the following manner (Badische): Dissolve 20 parts Paramine (para-phenylene-diamine) in 300 parts hot water and dilute with 450 parts cold water; add 1½ parts Rongalite C, and then add successively 20 parts sodium chlorate dissolved in 50 parts water, 10 parts ammonium chloride dissolved in 50 parts water, 15 parts ammonium vanadate solution (1:1000) and 40 parts tartar emetic solution (prepared by dissolving 40 parts tartar emetic in 620 parts water

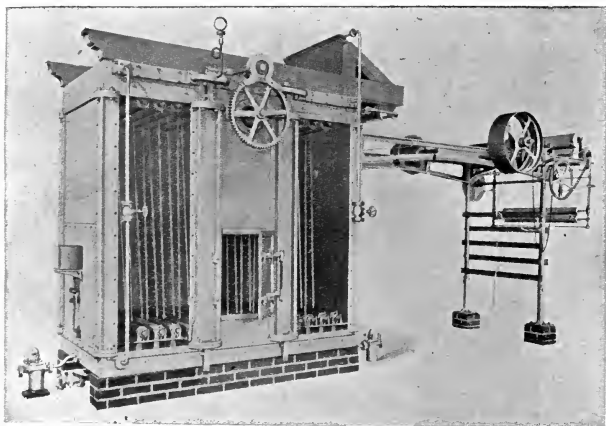

FIG. 235.—Ageing Machine for Cloth. (Zittauer.)

and 340 parts glycerin). Dilute to 1000 parts. In one hour the solution should become colorless. Pad the cloth in this liquor, dry at 105 to 115° F., steam for five minutes in the ager, rinse and soap. Instead of steaming the goods may be passed through a warm solution of 3 parts chrome to 1000 parts water. The tartar emetic is used for the purpose of delaying the oxidation, and is chiefly important when making resist prints.

* Diphenyl Black Base was para-amino-diphenylamine while Diphenyl Black Oil DO consisted of 1 part amino-diphenylamine dissolved in 3 parts aniline oil.

† *Paramine* is the name under which para-phenylene-diamine is sold when used for this purpose. *Fuscamine* is a more yellowish brown obtained by using para-amino-phenol in place of Paramine. It is also known as *Bistramine Brown*. A similar color known as *Ortamine Brown* is prepared from ortho-dianisidine.

8. Experimental. Exp. 159. After-Chromed Method for Aniline Black.—Prepare a bath containing the following: 15 grams potassium chlorate; 10 grams bluestone; 26 grams aniline hydrochloride; 200 cc. water. Use a test skein of cotton which

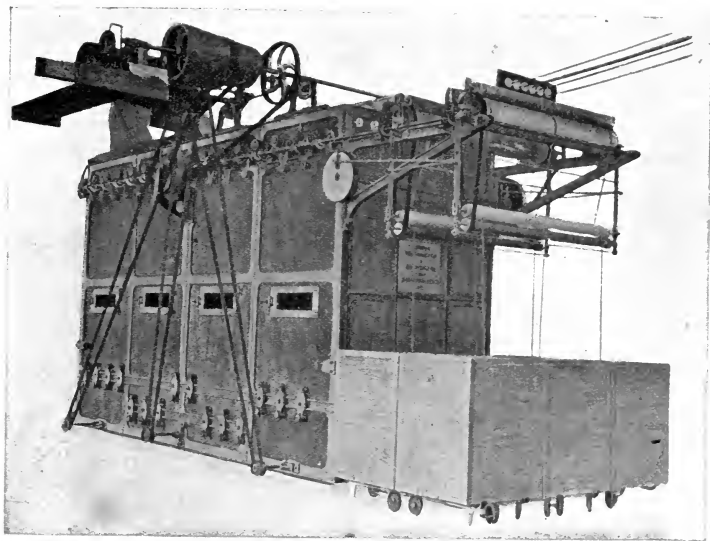

FIG. 236.—Drying and Ageing Machine for Warps. (Zittauer.)

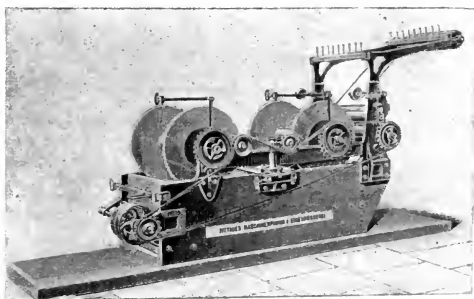

FIG. 237.—Machine for Dyeing Warps with Aniline Black.

has been well wet out, and saturate it thoroughly with the above solution; squeeze, and dry in a hot-air chamber until the cotton is of a uniform green color; then work for one-half hour at 180° F. in a bath containing: 3 grams potassium bichromate; 2 grams sulphuric acid; 300 cc. water. Finally soap and wash.

Exp. 160. One-bath Process.—Prepare a bath as follows: 300 cc. water; 10 grams aniline salt; 3 grams potassium bichromate. The aniline salt is dissolved in the water, after which the potassium bichromate is dissolved in a little water and also added. The cotton is worked in this solution cold for one hour, then the temperature is gradually raised to 150° F.

The process may be varied somewhat by adding to the bath only one-half the above ingredients at a time. The more concentrated the solution, and the greater its acidity the more rapidly will the dyeing take place. Excess of acid and prolonged heating tend to give bronzy-colored blacks, and much of the coloring matter will only be superficially fixed. If, however, the heating has been of only short duration, the black will have a bluish tone, and is liable to turn green when treated with acids. The temperature of

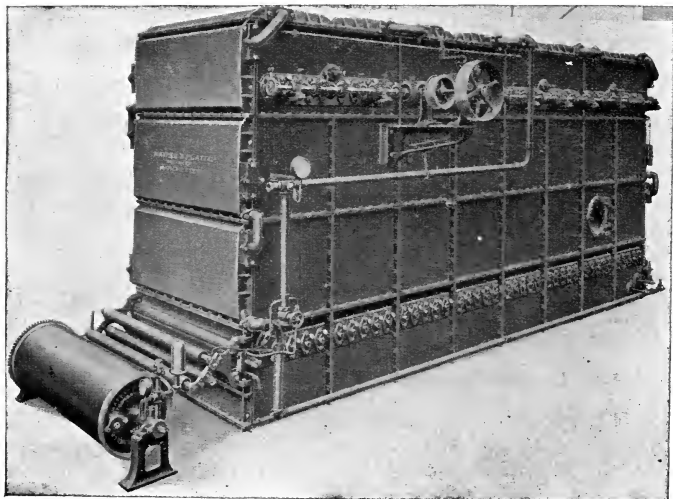

FIG. 238.—Aniline Black Ageing Machine. (Mather & Platt.)

the bath should be raised very gradually, else there will be a considerable loss of coloring matter by precipitation in the bath. After dyeing the cotton should be well washed in water, and then in a boiling soap solution containing 5 to 10 grams of soap per liter, to which a little soda ash may also be added. Due to the strong acidity of the bath unless the process is conducted very carefully the cotton will be liable to become tendered.

Exp. 161. Cold Process for Aniline Black.—In this method the operation is conducted entirely in the cold. Prepare a bath containing: 16 cc. hydrochloric acid; 12 cc. sulphuric acid; 10 grams aniline oil; 20 grams potassium bichromate; 10 grams copperas; 200 cc. water. Work the cotton in this bath cold until a full black color is developed, which will require from one to two hours. Hydrochloric acid alone tends to produce bluish blacks, while sulphuric acid gives a reddish hue, hence a mixture of the two acids gives a more pleasing tone to the color finally produced. The ferrous sulphate is added for the purpose of rendering the black less liable to turn green; in

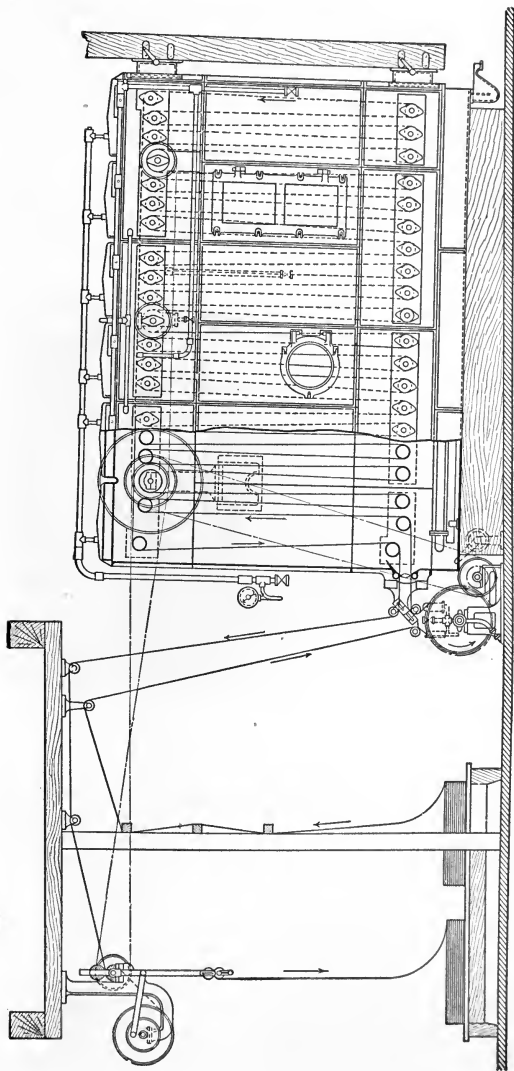

FIG. 239.—Diagram of Aniline Black Ageing Machine. (Mather & Platt.)

the bath it is changed to ferric sulphate, which acts as an oxidizing agent. After dyeing cotton must be washed and well boiled in a soap solution. The use of soap alone gives blacks of a violet tone, while if soda ash is added a bluer tone results.

In order to render the black obtained either by this method or the preceding ungreenable, it is necessary to give the cotton a further oxidation. For this purpose the following bath is used: 20 grams copperas; 5 grams chrome and 18 cc. sulphuric acid; 70 cc. water. To 500 cc. water add 5 cc. of this solution and work the cotton therein for three-quarters of an hour at 170° F., then wash well and soap.

Another method for preventing the black from becoming green is to dye it in a weak solution of Methyl Violet, which may be done in the soap bath. This basic dyestuff evidently combines with the cotton by reason of the fiber having been more or less converted into oxycellulose. The effect of the green and violet produces a bluish black, hence the color appears to remain unchanged.

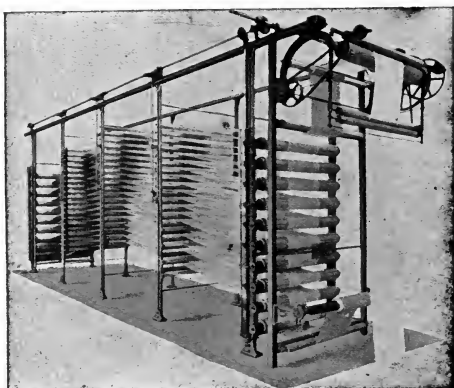

FIG. 240.—Machine for Oxidizing in Hot Flue. (Zittauer.)

Exp. 162. Use of Bluestone in Aniline Black.—This is a very common ingredient in formulas for the dyeing of Aniline Black. Make a solution as follows: 25 grams aniline hydrochloride, 3 grams bluestone, 5 grams ammonium chloride, and 100 cc. of water. Work a test skein of cotton in this bath cold until thoroughly impregnated; squeeze, and oxidize in a fresh bath containing 10 grams chrome, 1 gram sulphuric acid, and 200 cc. water. Wash well and finally soap.

Exp. 163. Ageing Process for Aniline Black.—The best blacks are obtained with aniline which has been aged for some time in a hot-air chamber containing the proper amount of moisture. Make three solutions as follows:

- a. Dissolve 12 grams potassium chlorate in a small amount of water.
- b. Dissolve 22 grams potassium ferrocyanide in 100 cc. water.
- c. Dissolve 35 grams aniline hydrochloride in 100 cc. water.

Mix these three solutions cold. Work a test skein of cotton in the bath for one-half hour cold; squeeze, and age in a hot-air chamber at about 175° F., the air of which is not too dry. The material should turn a dark green during this treatment; then work

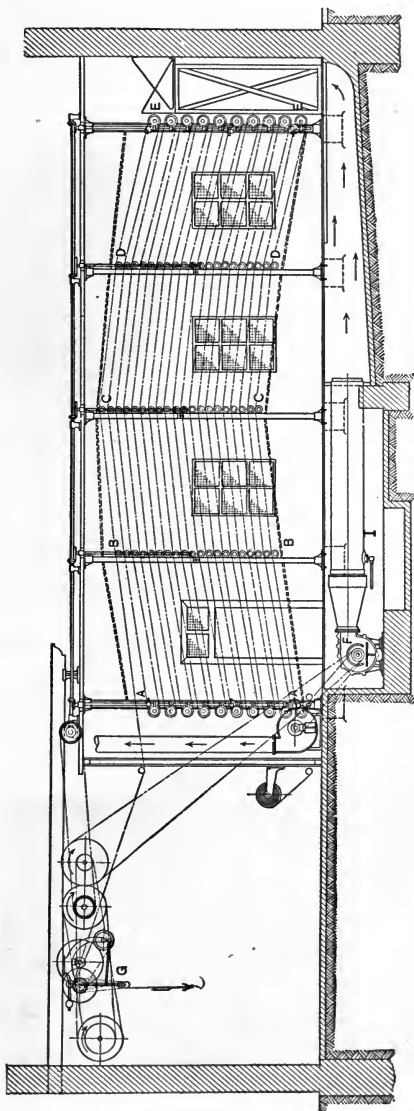

Fig. 241.—Arrangement for Hot Flue.

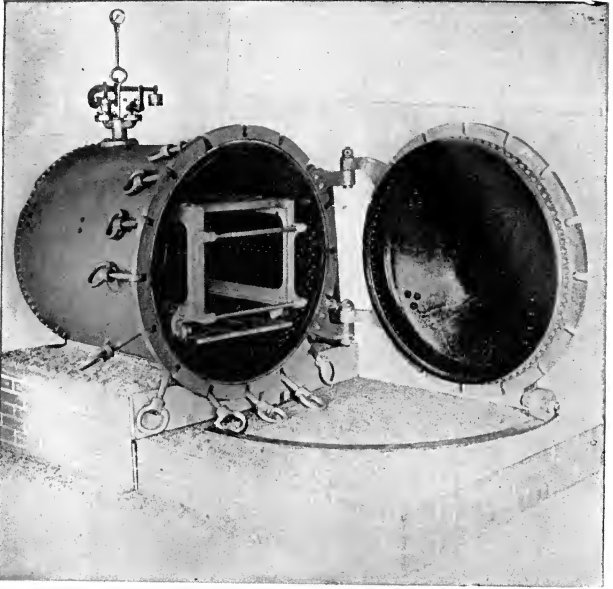

FIG. 242.—Steaming Cottage for Hank Yarn, the Carriage Provided with Wooden Bars.

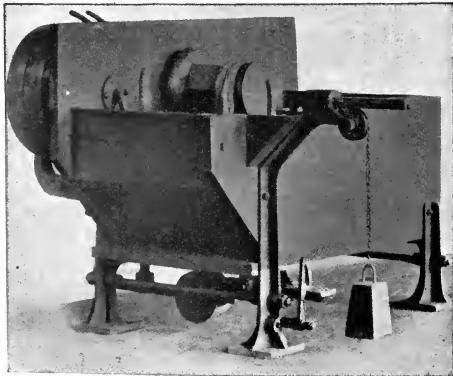

FIG. 243.—Yarn Impregnating and Wringing Machine. (Haubold).

for one-half hour at 160° F. in a bath containing 2 per cent chrome. Finally wash and soap.

Exp. 164. Use of Manganese Chloride in Aniline Black.—This salt may be used for the production of the oxide of manganese on the fiber, which acts as an oxidizing agent with aniline and thereby produces the black. Work a test skein of cotton in a cold bath containing 10 per cent manganese chloride; squeeze, and pass through a bath containing 5 per cent caustic soda cold for fifteen minutes. This causes the lower oxide of manganese, MnO, to be precipitated on the cotton; rinse, and work for fifteen minutes cold in a bath of chloride of lime at 2° Tw. in order to oxidize the manganese compound to the higher oxide, Mn₂O₃. Rinse, and pass through a solution containing 10 grams aniline hydrochloride in 200 cc. water, acidified with 2 cc. hydrochloric acid.

Exp. 165. Use of Vanadium in Aniline Black Dyeing.—The salts of this element appear to act as good carriers of oxygen in Aniline Black dyeing, but their expense has prohibited their general use. Prepare a bath containing: 10 grams aniline hydrochloride, 0.1 gram ammonium vanadate, and 100 cc. water; impregnate a test skein of cotton with this solution; squeeze, age in hot-air room as before described, and then oxidize in chrome bath. Finally wash well and soap.

CHAPTER XX

USE OF LOGWOOD IN DYEING

1. General Use of Natural Dyes.—Previous to the discovery of the coal-tar dyes the textile colorist had to rely upon either the mineral pigments or the dyestuffs derived from the various vegetable substances for the production of his effects. The vegetable dyes nearly all belong to the mordant class of dyestuffs, though a few such as Turmeric, Safflower, and Annatto exhibit substantive properties to a certain degree, and may be dyed directly on cotton. In general, however, in using the natural dyewoods on either wool or cotton it is first necessary to mordant the material in the usual manner with metallic salts.*

The coloring matters present in the dyewoods were usually extracted by the dyer himself by simply boiling the rasped wood in water and using this solution as a dyebath. Under these conditions, however, the coloring matter so obtained was never in a pure condition, but was contaminated with more or less resinous and tannin matter which acted frequently in a deleterious manner in the dyeing. The first application of chemical science to the art of dyeing was the attempt to manufacture purer and more homogeneous dye products from the extracts of the various dyewoods or other vegetable coloring matters. At the present time the use of the natural dyewoods has almost disappeared with the exception of Logwood, Fustic, Quercitron, and Indigo; and even the latter is now a coal-tar product which is rapidly driving the natural article from the market. Logwood still holds its own for the production of cheap blacks on wool and cotton, and it is also largely used in the black dyeing of silk. Fustic is used to some extent in connection with the foregoing to tone the shade of the black obtained but even its use in this manner is growing less and less, being replaced by other yellow coloring matters which possess a greater degree of fastness. Cutch is still used for the production of brown shades on cotton, but it is more used as a tannin mordant than as a self color.

* The affinity of the natural dyestuffs for wool is based upon the same general principles as in the case of the coal-tar dyes. The majority of the natural dyes belong to the mordant class, though a few will combine with wool directly after the manner of acid dyes, and a limited number act in the same manner as substantive dyes.

The natural dyewoods yield coloring matters from which may be dyed black, red, brown, yellow, blue, violet, etc.; there is, however, no good green dye among the list of natural dyestuffs. The colors obtained with the natural dyes, as a rule, are rather dull in appearance, and many of them are of questionable fastness, there being many of the mordant coal-tar dyes which are far superior in this respect.

2. Logwood.—Logwood is obtained from the Campeachy wood, known botanically as *Hæmatoxylin Campechianum*; it is a large tree and grows principally in tropical and sub-tropical America.* The wood itself is really a red-wood, but the color-lake as finally developed is black or blue depending on its intensity. When freshly cut the wood is colorless or looks about like that of any other tree; on exposure to the influence of the oxygen of the air, however, the outside of the wood becomes of a dark reddish brown color, due to the development of the coloring matter. The coloring principle of Logwood is called **hematoxylin** † and this on oxidation yields **hematine**, which is the real coloring matter of the prepared Logwood. ‡ In order to prepare the wood for use by the dyer, the logs, after having the outer sapwood stripped off, are either rasped or chipped, the chips being placed in large heaps and moistened with water. These heaps are turned over from time to time to allow the oxygen of the air free access to the wood. Fermentation occurs, which results in the formation of the hematine. § The dyewood in this state may now be used by the dyer,

* Logwood was not introduced into dyeing until after the discovery of America.

† Hematoxylin may be prepared from Logwood by extracting the freshly prepared aqueous solution of the wood with ether, and subsequently crystallizing. The purified crystals are white and prismatic in form. On exposure to the air they soon become oxidized to hematine, which is of deep cherry-red color. The fresh wood contains about 8 to 10 per cent of hematoxylin.

‡ The coloring matter, as it exists in the wood, is probably in the form of a glucoside. When freshly cut the wood is colorless, and looks like any other tree; but soon, on exposure to the influence of the oxygen of the air, the wood on the outside becomes of a dark reddish brown color, while on the inside it is a pale yellow or orange. The form in which the coloring matter exists in the wood is still a mooted question, however, and some claim that the hematoxylin is present as such.

§ Gardner has shown that the ageing process in the preparation of Logwood chips is not essential, as the unaged chips may be used with equal results if an oxidizing mordant is employed (chrome alone or chrome with sulphuric acid). This is on account of the fact that in the fresh chips the coloring matter exists principally as hematoxylin, which requires to be oxidized in the dyeing to develop the full advantage of the color; whereas in the aged chips the coloring matter is principally hematine, and this is most advantageously dyed on a reduced mordant (chrome and tartar). The idea that ageing was necessary in preparing the chips was no doubt a result of the times before an oxidizing mordant like chrome was known, and when only non-oxidizing mordants like copperas were used. Hummel has shown that when dyeing with fresh Logwood chips the addition of chalk or calcium acetate to the dye-bath develops the coloring power to a remarkable extent, and has the effect almost as if hematine were used. This is probably due to the formation of a salt of the coloring matter with the lime.

but at the present time it is customary to carry the manufacture of the dyestuff still further and prepare an extract either in the solid or the liquid form.*

Logwood is about the only natural coloring matter which is still extensively used (with the exception of Indigo and Quercitron). Its principal use at the present time is for the black dyeing of silk and leather; its use on cotton is decreasing, and on wool it is used only for very cheap blacks.

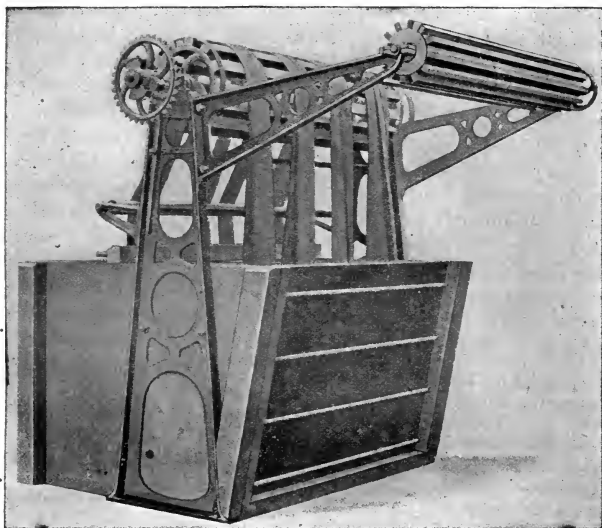

FIG. 244.—Reel Dyeing Machine for Logwood.

This is due to the fact that there are several blacks for both wool and cotton which are much faster than Logwood.

*The chipped or rasped Logwood as it occurs in trade often contains an abnormal amount of water, sometimes as high as 50 per cent, while the normal amount in well-matured wood is only about 30 per cent. In the natural unmaturred wood the amount is only about 14 per cent. The appearance of well-matured chips is a dark brownish red color, which when dried assumes a greenish bronze appearance.

Logwood extract occurs in trade in a liquid form of various densities, but usually standing between 40 and 51° Tw. The specific gravity, however, is no guide as to the value of the extracts, as inferior extracts are often brought up to a high specific gravity by the addition of glucose, salt, or more generally, by the addition of molasses, which makes a convenient, cheap, and difficultly detectable adulterant. Solid extracts are often sophisticated with salt, and sometimes with farina and various tannin extracts.

In combination with the various mordants Logwood gives colors as follows:

With iron.....	gray to black
With copper.....	green-blue to black
With chromium.....	blue to black
With aluminium.....	violet-gray.
With tin.....	purple

The fastness to light of colors obtained with Logwood varies somewhat with the nature of the mordant on which they are dyed. The logwood-chrome lake is fairly fast, but fades to a greenish tone; the iron lake is about equally fast and fades to a gray tone; the tin and aluminium lakes are not especially fast, fading rather rapidly to a gray tone; the copper lake is the most permanent to light.* There are black coal-tar mordant dyes which are faster to light than Logwood; Diamond Black, for instance, together with the black dyes of its same general class, have largely superseded Logwood for the dyeing of blacks on high-grade woolen and worsted fabrics, especially those which require an excellent fastness to light. In former years, when Logwood blacks were principally employed for the dyeing of men's suitings and overcoat cloth, it was quite customary to notice the faded greenish coat or hat; but at the present time such a defect is very seldom seen if the fast coal-tar black dyes have been used.

Logwood extract (51° Tw.) is usually about three to four times as strong as the chip Logwood (aged).† The former consists of a mixture of hema-

*The fastness of Logwood black to light may be increased by using a fast red or violet dyestuff in the Logwood bath; the result being that as the Logwood turns to a greenish tone, the red coloring matter will neutralize this green, thus preserving the true black. Alizarine Red is largely used for this purpose, taking the place of the madder which was formerly used. Gallocyanine, Archil, and the red-woods have also been used, but as they are not as fast as Alizarine Red, they are not so satisfactory, though Gallocyanine gives very good results, especially as the black it gives in connection with Logwood is of a rich bloomy tone.

† Logwood extract is usually made from the unaged wood, as in the first place the hematoxylin is much more soluble and more readily extracted than the hematine, which is present in the aged wood. In the second place, in the process of extraction and concentration there is always a certain amount of unavoidable oxidation, and if hematine were present this might lead to the destruction of considerable coloring matter. Furthermore, it is mostly required in the preparation of Logwood extracts to have a low degree of oxidation. There are two general methods of extraction; the French method treats the chips in open pans with boiling water, whereas the American method extracts in a closed kier with steam under 15 to 30 lbs. pressure. The American method gives a yield about 25 per cent greater than the other process, but it is said that the extra amount consists mostly of extractive matters other than coloring matters, so that the apparent advantage of having a larger yield is discounted. It is also claimed that the French method gives an extract which yields brighter and purer colors in dyeing, owing to the presence of less brown extractive matters. A good wood will yield by the French process about 16 per cent of extractive matters and by the American process about 20 per cent.

toxylin and hematine, whereas the latter consists almost entirely of hematoxylin. According to the degree of oxidation the extracts (either liquid or solid) are known as "Logwood Extract" or as "Hematine Extract." The solid hematine extracts are usually known as "Hematine Crystals." A good Logwood extract will show about 20 per cent oxidation; that is to say, about 20 per cent of the hematoxylin has been converted into hematine. On the other hand, a good sample of hematine usually shows an 80 per cent oxidation.

Cheap grades of Logwood extract are frequently mixed with chestnut extract for cotton dyeing; as this extract runs high in tannin, and it is

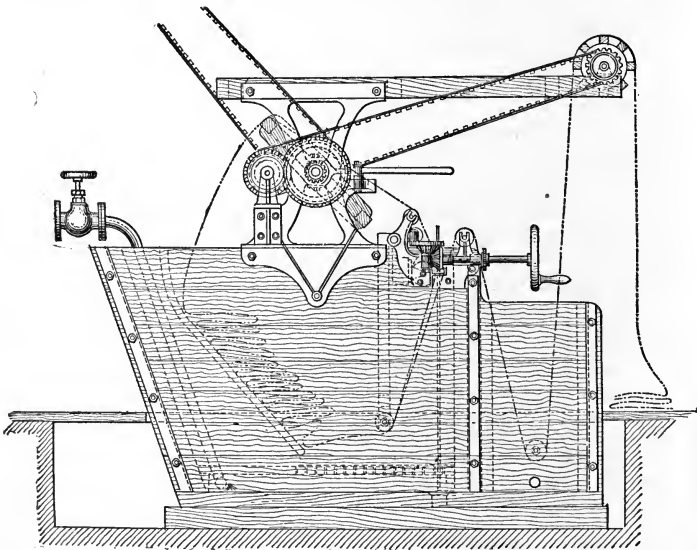

FIG. 245.—Open Width Dyeing Machine for Logwood. (Haubold.)

sometimes difficult to tell from a dyeing test that the Logwood is weaker, owing to the tannin giving a black color with the iron mordant used in the dyeing of the cotton, and also on account of the coloring matter of the chestnut extract.

Hematines are made from Logwood extracts by air oxidation (usually blowing of air through the extract until the proper degree of oxidation has been reached.* Quicker and more complete oxidation may be obtained

* The bronzy appearance to be noticed on aged Logwood chips is often supposed to be due to the formation of hematine; but this is not the case, as the bronzy appearance is due to the presence of an ammonia compound.

by the addition of sodium nitrite or of copper sulphate. In this same connection it may be stated that in the dyeing of Logwood extract on the fiber the addition of a small amount (1 per cent) of sodium nitrite to the bath when the dyeing is almost completed will produce a much fuller shade of black with the same quantity of Logwood. Copper sulphate may also be used in the same manner.*

In the valuation of Logwood chips and extracts (including also the hematine extracts) there has always been more or less confusion. This is particularly true of those who are not familiar with the dyeing properties and practical use in dyeing of the various Logwood products. But much of the same confusion also exists even among the dyers themselves. This is chiefly due to the presence in the Logwood of the two ingredients, the hematoxylin and the hematine, which behave differently in dyeing, depending on the character of the mordant employed. A sample, for example, rich in hematoxylin and of high color value, may show up poorly if tested against a sample rich in hematine yet of lower color value if dyed on a reduced mordant (of chrome and tartar). Furthermore a sample consisting mostly of hematine might be considered poor by a dyer who is accustomed to using an oxidizing mordant (of chrome alone or chrome with sulphuric acid), as the oxidizing mordant may cause overoxidation of the color and the consequent production of a pale shade. It is necessary, therefore, thoroughly to understand the difference in the nature and behavior of the hematoxylin and the hematine, and to regulate the testing and comparison of samples accordingly. The full tinctorial power of the extract or the wood may generally be obtained by testing on wool mordanted with 3 per cent of chrome alone; whereas the tinctorial power due principally to the hematine present may be tested by dyeing on wool mordanted with 3 per cent of chrome and 4 per cent of tartar.

The possible presence of impurities in Logwood extracts must also be taken into consideration. In the case of Logwood for cotton dyeing, for example, the addition of tannin (such as chestnut extract) to as much even as 20 per cent may not cause a lower tinctorial value in the Logwood owing to the fact that the tannin combines with the iron mordant used in cotton dyeing to give a black color somewhat similar to the Logwood itself. If used in wool dyeing, however, such an extract would show up much inferior to one possessing the same amount of actual Logwood, but not containing tannin, as here an iron mordant is not used and furthermore the tannin reduces the dyeing power of the wool. If the adulterant, however, were molasses or glucose such a difference would not be noted on the wool.

* According to a patent of Lepetit, Dollfus and Gannser (*Jour. Soc. Dyers and Col.*, 1905, p. 251), the addition of 15 to 20 per cent of magnesium sulphate to Logwood extract has the effect of producing a much deeper black. The effect, however, is more due to the bluestone which is also employed than to the magnesium sulphate.

3. Dyeing on Wool.—On wool Logwood is now almost entirely used on a chrome mordant, and the color obtained is a bluish black. About 15 per cent of Logwood extract is required for the production of full shades. To neutralize the bluish tone of the straight Logwood, it was formerly the custom to use some Fustic (a yellow wood color) in connection with the Logwood. Fustic is still used in this manner, but as it is rather fugitive, it is better to employ a faster mordant yellow dyestuff for this purpose. In the dyeing of Logwood it is to be noticed that an excess of chrome in the mordanting bath is injurious to the color. Sometimes Logwood black on wool is after-chromed for the purpose of making the color faster to washing and fulling. Stannous chloride is at times added to the dyebath for the purpose of giving a violet tone to the black. Logwood extract is sometimes mixed with copperas and bluestone and sold in the form of a paste as a direct Logwood black for wool; it is dissolved by adding oxalic acid to the bath.* A direct chrome black can also be prepared by precipitating a solution of Logwood with chrome and dissolving the precipitate in oxalic acid. Sometimes wool is first dyed in the indigo vat to a blue, and then topped off with Logwood, giving a bluish black; this is known as a "woaded" black.†

Formerly Logwood black was dyed on wool with an iron mordant, copperas being employed for this purpose. This was previous to the

* Bonsor's Fast Direct Black was a paste consisting of a Logwood lake with copperas and a small amount of bluestone. The dye is insoluble in water, but is brought into solution by the addition of oxalic acid, giving an amber-brown solution; the amount of oxalic acid to be added can be determined only by trial. To dye the wool the material is simply boiled in the oxalic acid solution for about two hours, then a small amount of soda ash is added to neutralize the acidity of the bath and help to further develop the color. The bath may be used continuously with additions of dye and oxalic acid as required. Too much acid should be avoided, as this retards the dyeing and gives thin colors. Many acid dyes may be used in the bath to modify the shade. A black obtained in this manner is quite fast to light. The following one-bath process for Logwood on wool is given by Gardner: Use a bath containing

6 to 8 per cent of chrome alum,
3 to 4 per cent of oxalic acid,
1 per cent of chalk,
10 to 25 per cent of Logwood extract.

The dyeing must be carefully conducted, as otherwise the color will come up uneven or speckled in appearance. Other one-bath blacks for wool are as follows: Dye with a mixture of 15 per cent of Logwood extract, 6 per cent of ferrous sulphate and 3 per cent of oxalic acid; start the dyeing lukewarm and gradually heat to boiling. A greenish shade of black may be obtained by using the following: 15 per cent of Logwood extract, 4 per cent of copper sulphate and 1 per cent of oxalic acid.

† The blue obtained by dyeing Logwood in small amount (1 to 5 per cent) on wool with a chrome mordant is somewhat similar in color to Indigo, but is not nearly as fast to light. During the war when there was a great shortage of Indigo, Alizarine Blues, and other blue dyes for wool, Logwood was used for this purpose to a very considerable degree.

knowledge of chrome and its properties as a mordant. When properly dyed, it is said that the copperas black on wool is superior in many ways to the chrome black, being less liable to turn green on exposure to light and it also gives the dyed cloth a softer or "kinder" handle, the chrome mordant making it more harsh to the feel. The copperas black was usually dyed by after-mordanting, the cloth being first boiled for one to two hours in a bath containing the Logwood decoction together with a little Fustic for shading; then 5 per cent of copperas and 2 per cent of bluestone are added to the bath and the wool boiled for one hour longer. Or a separate bath may be used for the mordant. This process was known as "saddening." The addition of the copper salt helps to develop the full color of the Logwood by its catalytic action in the oxidation of the hematoxylin. It also makes the color somewhat faster to light. If hematine (liquid or crystal) is used the bluestone is not so essential.*

Sulphuric acid is usually employed as the assistant in the chrome bath, and care should be taken that its amount should not exceed one-third that of the chrome (usually 3 per cent of chrome and 1 per cent of sulphuric acid), in order to prevent dull colors. This use of sulphuric acid is especially necessary when the Logwood chips or the unoxidized Logwood extract are used. With chrome and sulphuric acid, an "oxidizing" mordant is obtained, as it is probable that the mordant consists of a yellowish chromate of chromium. This mordant in connection with Logwood oxidizes the hematoxylin to hematine and thus utilizes completely the coloring matter. If the ordinary chrome and tartar mordant is employed a green reduced chromium oxide is obtained on the fiber which has no oxidizing properties; consequently, on dyeing with Logwood, the color obtained is chiefly due to the hematine combining with the mordant and the hematoxylin is not completely utilized. This accounts for the fact that different dyers may obtain entirely different results with the same lot of Logwood extract. In case where the Logwood extract used contains a large amount of hematine, the reduced mordant of chrome and tartar may be used. It

* Logwood black on wool obtained with a chrome-copper mordant, though fast to fulling is not so to light, and is apt to turn green. The chrome logwood black is fast to fulling and rather faster to light than the chrome copper black, but it is more liable to turn green. The iron logwood black is faster to light than either of the foregoing and is less apt to turn green, but it is not so fast to fulling. The best copper-chrome black is dyed by first mordanting with $1\frac{1}{2}$ to $2\frac{1}{2}$ per cent chrome and 1 to 2 per cent bluestone and $\frac{1}{2}$ to $1\frac{1}{2}$ per cent sulphuric acid. After mordanting the goods should be well washed and then freed from any trace of chromic acid by means of a cold bath of a dilute solution of sodium hyposulphite. This is very important, as the presence of free chromic acid is the chief factor in the color turning green. Lactic acid or lactolin may be used with the mordant in place of sulphuric acid. The goods are next dyed as usual with Logwood and Fustic. By treatment with ferrous sulphate after dyeing, a deeper black faster to light is obtained. This black has but a slight tendency to turn green and is fast to fulling.

is said that this method of dyeing gives brighter and faster colors than when an oxidizing mordant is used with Logwood; but this is a mooted question, and the difference in the results may depend on other factors.

Wool may also be mordanted previously to the dyeing, in which case tartar is used in connection with the copperas. Alum and bluestone are also frequently added with the copperas to vary the tone. The dyebath is prepared with Logwood and a little Fustic for shading; it is also recommended to add a small amount of calcium acetate as it increases the intensity of the color, this, however, need be done only in cases where a very soft water (free from lime salts) is used in dyeing. It is also considered beneficial to let the mordanted wool lie overnight before dyeing. It is

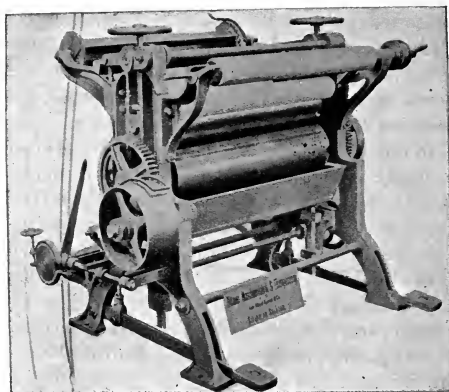

FIG. 246.—Sizing Mangle for Cotton and Linen Pieces. (Zittauer.)

probable that under these circumstances some of the iron oxide is converted into the higher oxide (ferric oxide), and this acts as an oxidizing mordant with the Logwood. When bluestone is used with the copperas, or when hematine is employed in place of the regular Logwood decoction, it cannot be seen what advantage the ageing may have. In former days, when only the wood decoction was used in the dyeing it was always necessary to have some oxidizing effect in order to convert the hematoxylin into hematine so that the full color might be developed. This will often account for some of the rather lengthy processes to be noted in the old recipes for the dyeing of Logwood. Also many other natural dyewoods were frequently added with the Logwood in varying amounts in order to modify the tone of the black obtained and also to increase its fastness; madder, archil, and sumac were much used for this purpose.

In order to obtain a Logwood black which is perfectly fast to washing and rubbing, it must be borne in mind that after coming from the dyebath there is always some unfixed dyestuff in the fiber, which cannot be readily removed by simple washing in water. Hence the goods are given an after-mordanting treatment (called "back-chroming") in a third bath with a small amount of chrome (not over 1 per cent) and at a temperature of about 180° F. Especial attention must here be drawn to the fact that if too much chrome is used in this finishing bath, the black so obtained, though fast to washing, will be liable to turn green on exposure to light. Instead of using a back-chroming bath for the purpose of fixing the excess dyestuff, copperas (3 per cent) may be added directly to the dyebath after dyeing. This will give a dead black and one not so "clean" as when chrome is employed. In place of copperas, stannous chloride (2 per cent) may be used, which will give a rich violet black.

Navy blue on wool is frequently dyed with Logwood on a chrome mordant with the addition of Indigo extract to the Logwood bath (also some sulphuric acid must be added). Such a blue, however, is not fast to light, as it soon fades to gray.

4. Dyeing on Cotton.—Logwood is chiefly dyed on cotton in connection with an iron mordant, "nitrate of iron" being principally used. The iron salt is generally fixed on the cotton by tannin preliminary to dyeing, but at times the fixation of the iron is accomplished by the tannin naturally present in the Logwood extract. As the iron mordant gives a brownish or rusty black, it is advisable to chrome the color obtained to produce a clearer and more desirable black. The development of the rusty appearance on an iron-logwood black on cotton may also be prevented more or less by soaping the dyed color. By the addition of bluestone to the dyebath the color is also said to be improved in appearance.

By using a tannin and iron mordant which develops a gray to black color itself, less Logwood is required than when an iron mordant alone is used. Logwood extracts used for the dyeing of cotton usually have considerable tannin in them, as this is beneficial in fixing the iron; Logwood extracts for wool dyeing, on the other hand, should contain but little tannin, as tanned wool becomes less absorptive of the dyestuff. The amount of tannin in the extract is regulated by the method of extraction of the coloring matter from the wood. The better blacks are dyed on cotton by first steeping in tannin (sumac, myrabolam^s, etc.), fixing with "nitrate of iron," giving a bath of lime water (to neutralize the acid and further fix the iron), dyeing with Logwood and Fustic, then "saddening" in the dyebath with 2 per cent of copperas, and finally finishing off by soaping. A cheap method for the dyeing of piece-goods is to pad the cloth with pyrolignite of iron, dry, give a bath with lime water, and dye with Logwood. A method for the dyeing of cotton-warp unions is to pad with

tannin, then pass through a bath of copper sulphate, and finally dye with Logwood.

A chrome Logwood black may be dyed in one bath on cotton in the following manner: Dissolve $1\frac{1}{2}$ lbs. chrome in a small amount of water, mix with a solution of 15 lbs. of Logwood extract, and then add $3\frac{1}{2}$ lbs. hydrochloric acid. Start the dyeing cold and gradually raise the bath to a boil. The cotton at first will acquire a deep indigo blue color which becomes a bluish black on washing with calcareous water (Hummel). Another one-bath method is to use 20 lbs. of solid Logwood extract, 4 lbs. of bluestone, and 4 lbs. soda ash. Heat to 180° F. and pass the cotton through rather rapidly, then "smother" for five to six hours to allow to

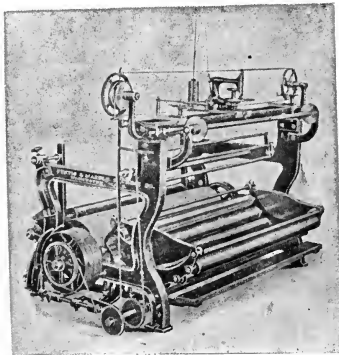

FIG. 247.—Railway Sewing and Rolling Machine for Sewing Pieces to Make a Continuous Roll. (Curtis & Marble.)

oxidize. In order to get a good black it is necessary to repeat the operations one or more times. This black is rather expensive but stands fulling with soap very well.

A Logwood black for loose cotton to be fast to fulling is as follows (Hummel):

Wet out the cotton well in boiling water, then boil in a strong solution of about 30 per cent of solid Logwood extract, drain, and allow it to lie exposed to the air for some time; complete the oxidation thus begun by working it one hour in a cold solution of 8 per cent of bichromate of potash and 6 per cent of copper sulphate; wash and complete the dyeing in a bath containing 10 per cent of Logwood extract; enter the cotton cold and raise the temperature gradually to the boiling point. Wash, soap, and dry.

In the first bath the cotton simply absorbs the coloring matter of the Logwood; in the second this is oxidized, and at the same time combined with a sufficient amount of the mordant, copper, and chromic oxide, to enable it to take up still more coloring matter in the third bath. The first Logwood bath is analogous to the tannin bath alluded to in a previous process.

5. Dyeing on Silk.—Logwood is still used extensively for the black dyeing of silk, both unweighted and weighted. It is used in connection with a tannin-iron mordant, the tannin employed usually being cutch. Logwood seems to make the silk fiber opaque, which is a necessary condition for the production of a full deep black; the coal-tar blacks, as a rule, do not make the silk sufficiently opaque.*

Logwood black on silk is not only dyed for the color, but also for the purpose of weighting the silk. This is accomplished by using a heavy mordant of tannin and iron in connection with the Logwood. The weighting is usually about 100 per cent, though it frequently ranges up to as high as 400 per cent. By alternate and successive treatments of the silk with solutions of tannin (cutch, gambier, chestnut extract, etc.) and iron salts (pyrolignite of iron, "nitrate" of iron, yellow prussiate) a heavy deposit of iron tannate can be fixed in the fiber. In sufficient amount this iron tannate alone would furnish a black color (and, in fact, this was the manner in which black was dyed on silk in ancient times) on silk but it gives a rather unpleasant and harsh shade; whereas by dyeing with Logwood, a pleasing bloomy shade of black is obtained.

The number of various recipes recommended for dyeing silk black with Logwood is legion, depending upon the character of fiber (whether completely boiled-off or not), the tone of color desired, and the degree of weighting required. The general outline of the process, however, is to first steep the silk for several hours in a rather concentrated (10 to 15° Tw.) solution of gambier or chestnut extract at 120° F.; then steep in a solution of pyrolignite of iron at 12 to 15° Tw. at 140° F. Squeeze and expose to the air for one or two hours, then wash. One such treatment will increase the weight of the silk about 20 to 30 per cent. Higher degrees of

* Logwood is especially valuable in the black dyeing of silk, because it renders the fiber opaque and thus produces a full and brilliant black. This is probably due to the pigment nature of the color-lake and its combination with the metallic mordants in the fiber. The various coal-tar black dyes on silk nearly all have a slaty faded appearance when their color is compared with a Logwood black. This is by reason of the silk fiber being so translucent that the full black color is diluted with an excess of transmitted light. With the exception of Logwood, however, there is perhaps no branch of dyeing in which the natural vegetable dyes are now used to a lesser extent than in that of silk dyeing. The very nature of the silk fiber militates against the use of dyestuffs requiring metallic mordants and severe and complicated processes of dyeing. Even Indigo is but little used in the dyeing of silk on account of the dyevat containing lime, and the treatment being injurious to the softness and luster of the fiber.

weighting are obtained by repeating the treatments in the tannin and iron liquors. Nitrate of iron may also be used. A treatment with yellow prussiate of potash is at times given which not only adds weight, but also gives a blue color (Prussian Blue) on the fiber, which is beneficial to the appearance of the ultimate color. After the mordanting has been carried to the desired point the silk is washed and dyed with Logwood extract together with a little Fustic (depending on the shade desired). The dye-bath is usually not run at over 160° F. temperature. After dyeing the silk is generally aged by exposure to the air for an hour, it should then be soaped, adding to the soap bath a small amount of oil (2 to 4 per cent) for the purpose of softening and brightening the fiber.

Black silks that are not weighted are known as "pure dye" black. Such a color is usually produced by first treating the silk in a bath at 160° F. with Logwood extract (15 per cent); Fustic (5 per cent); copperas (5 per cent) and copper acetate (3 per cent). Allow to age in the air for one hour and then dye again in a fresh bath with 15 per cent of Logwood extract and 15 per cent of soap for one hour at 160° F. In the case of silk for pile fabrics (plushes, etc.), where it is desired to have a blue over-cast, the silk may be mordanted with alum and dyed without the use of Fustic. Sometimes Logwood black is dyed on raw silk which is to be used for pile fabrics or for the backing of satins, etc., and it is desirable not to remove any more of the silk gum than necessary. In this case the temperature of the baths should not go over 140° F. and soaping should be omitted.

6. Reactions of Logwood.—A solution of Logwood according to its strength, possesses an orange-yellow to a dark reddish brown color. It gives the following characteristic reactions:

Dilute hydrochloric acid.—Solution becomes paler.

Strong hydrochloric acid.—Blood red color, becoming orange-yellow on dilution.

Sulphuric acid gives the same reactions as the above.

Sodium carbonate.—Purple color, becoming blue and then brown.

Sodium hydrate gives same reaction as above.

Ammonia.—Deep reddish purple, quickly turning brown.

Lime water.—Violet-black precipitate.

Alum solution.—Rich plum color slowly developing.

Lead acetate.—Dark violet precipitate.

Basic acetate of lead.—Bluish black precipitate.

Ferrous sulphate.—Violet-black precipitate.

Ferric sulphate.—Same, but redder.

Copper sulphate.—Dark red precipitate, becoming violet.

Stannous chloride.—Reddish violet precipitate.

Silver nitrate.—Yellowish brown precipitate.

Potassium bichromate.—Black color slowly developing, on boiling a black precipitate.

7. Detection of Logwood on the Fiber.—If a sample of fabric dyed with Logwood on a chrome mordant is thoroughly ignited to a complete ash the

color of the residue should be yellowish or brownish green. On fusing with a little potassium chlorate a bright yellow mass will be obtained; on dissolving this in water and adding a little acetic acid and lead acetate solution, a bright yellow precipitate of lead chromate will be formed. Chrome-mordanted Logwood will also give the following tests:•

- Concentrated hydrochloric acid—reddish violet color, slowly forming.
- Concentrated sulphuric acid—olive-brown color becoming yellow on dilution.
- Caustic soda (10 per cent)—violet color, slowly forming.
- Concentrated ammonia—little action, slowly violet.
- Stannous chloride solution—reddish violet.

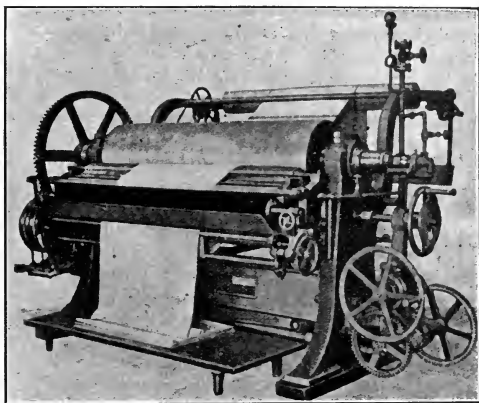

FIG. 248.—Rotary Pressing Machine.

These tests should all be made cold and most conveniently in small porcelain dishes in order that the developed color may be readily seen.

Logwood dyed on an iron mordant when ignited to an ash gives a reddish brown residue; on dissolving this in hydrochloric acid and adding a few drops of potassium ferrocyanide solution a blue color is produced, confirming the presence of iron. When the dyed cloth is tested with above-mentioned reagents the color is more crimson and more easily extracted with hydrochloric acid than when a chrome mordant is in question; also with caustic soda the color is more rapidly developed, while with stannous chloride the color is light red, otherwise the tests are the same.

Boiling alcohol has no effect on a dyed sample of Logwood, and the same is true of a boiling solution of soap or a dilute ($\frac{1}{2}$ per cent) solution of soda ash. When boiled with dilute hydrochloric or sulphuric acid the color is partially removed and the solution becomes red, the fiber being left

a purplish color. Caustic soda in excess added to the acid solution turns it a violet color, which gradually disappears with the formation of a brown precipitate. If this test is made with Logwood black containing Alizarine, the alkaline solution remains purple after the Logwood has been precipitated, and on adding dilute acid, the purple, if due to Alizarine, will turn a deep yellow.*

8. Experimental. Exp. 166. General Method of Dyeing Logwood on Wool.—Mordant four test skeins of woolen yarn in the usual manner with 3 per cent of chrome and 1 per cent of sulphuric acid; wash well. Dye the first skein in a bath containing 2 per cent of Logwood extract (solid); enter at 140° F., gradually raise to the boil, and dye at that temperature for three-quarters of an hour, then wash well and dry. Dye the second skein in a bath containing 5 per cent of Logwood extract in the same manner. Dye the third skein in the same way with 15 per cent of Logwood extract. The lower percentages of Logwood give bluish shades on a chrome mordant, which deepen into a bluish black in the heavy percentage. Dye the fourth skein in a bath containing a decoction made by boiling 50 per cent of chipped Logwood in 300 cc. of water. Notice that at first the dyebath is of a reddish color, but that the black develops on boiling. Logwood extract requires an oxidizing mordant (chrome and sulphuric acid, which gives chromic acid on the fiber) in order properly to develop the color, as it is necessary to oxidize the hematoxylin to hematine to form the color-lake. To show the difference in the use of an oxidizing and reduced mordant, mordant one skein with chrome and sulphuric acid and another chrome and tartar; then dye both with 5 per cent of Logwood extract.

Exp. 167. Effect of Over-chroming.—Mordant a test skein of woolen yarn with 10 per cent of chrome and 5 per cent of sulphuric acid in the usual manner; wash well, and dye in the manner described above with 15 per cent of Logwood extract. It will be found that only a gray color is produced; this is the result of employing too much chrome, whereby the fiber becomes oxidized and loses its affinity for the dyestuff. It may also be probable that the excess of chrome has some injurious action on the Logwood itself.

Exp. 168 Dyeing with Hematine.—This requires the use of a reduced mordant (i.e., chrome and tartar instead of chrome and sulphuric acid) as hematine is already oxidized. Mordant two test skeins of woolen yarn with 3 per cent of chrome and 4 per cent of tartar. Dye the first in a bath containing 2 per cent of hematine crystals

* Logwood when dyed in connection with Alizarine Blue or Gallocyanine, may be detected in the following manner: Treat the dyed sample with cold concentrated sulphuric acid; if dyed with Logwood, as already stated, a brownish red solution will be obtained which becomes yellow on dilution with water; Alizarine Blue gives a deep violet-blue solution, becoming red-violet on dilution; Gallocyanine gives a violet solution becoming redder on dilution; Indigo gives a green solution which turns blue, and remains blue on dilution. With a mixture of Indigo and Logwood the solution is green after adding sulphuric acid and diluting with water, but after filtering the solution several times, the Indigo is retained on the filter, and the yellow of the Logwood only is obtained in the filtrate. The delicate pink given by small amounts of Alizarine Blue or Gallocyanine, becomes red, orange, to orange-yellow in the presence of Logwood, depending upon the amount of the latter present. Logwood may at once be detected in an Indigo-dyed fabric by boiling with a 5 per cent solution of sulphuric acid, which removes the Logwood, giving a reddish solution, and leaves the Indigo on the fiber. Material dyed with Indigo and Logwood colors hydrochloric acid red and a 10 per cent solution of caustic soda violet, whereas pure Indigo yields no color with either solution.

and the second with 6 per cent of Hematine crystals, compare these dyeings with those of Logwood extract.

Exp. 169. Shading with Fustic.—Mordant a test skein of wool with 3 per cent of chrome and 2 per cent of sulphuric acid, rinse and dye with 15 per cent Logwood extract (paste) and 5 per cent Fustic extract (paste). It will be found that the black so obtained has not the bluish cast of the preceding, but is more on the order of a dead black, the yellow color of the Fustic having neutralized the blue tone of the Logwood.

Exp. 170. Shading Logwood with Alizarine Yellow.—This is for the purpose of obtaining a deep black without the bluish tone of the straight Logwood black. Mordant a skein of woolen yarn in the usual manner with 3 per cent of chrome and 4 per cent of tartar; wash, and dye in a bath containing 15 per cent of Logwood extract and $\frac{1}{4}$ per cent of Alizarine Yellow AW. Enter at 100° F., gradually raise to the boil, and dye at that temperature for three-quarters of an hour; then wash well and dry. Compare the color of this skein with that dyed with Logwood alone.

Exp. 171. After-chroming Logwood on Wool.—This method is practiced in order to give a black which is faster to washing and fulling, the result probably being that the outermost layer of Logwood in the dyeing of the wool is only incompletely fixed by the underlying mordant, and the after-mordanting serves to more thoroughly fix this layer and hence furnishes faster colors than would otherwise be the case. Mordant a test skein of wool in the usual manner with chrome, dye with 15 per cent of Logwood extract (paste), and finally finish off in a bath containing 1 per cent of chrome; work for a half hour at 180° F., and then wash well. If too much chrome is used in the last bath the black will be apt to turn green on exposure. Instead of using chrome, other salts may be employed for the after-fixing, such as: (a) Mordant a test skein of wool with chrome in the usual manner, dye with 15 per cent of Logwood extract (paste), and fix by adding to the bath 3 per cent copperas, work for one-quarter hour longer. A dead black is obtained in this manner and the excess of coloring matter is fixed, but the color has not the same purity or cleanness as the foregoing. (b) Mordant a test skein of wool with chrome in the usual manner, dye with 15 per cent of Logwood extract (paste), and then add to the dyebath 2 per cent stannous chloride, and work for one-quarter hour longer. This fixes the coloring matter and gives a rich violet black.

Exp. 172. Logwood Black on Wool with Iron Mordant.—This method of producing blacks on wool was formerly very largely used, but at the present time it has mostly given place to the use of Alizarine and other mordant blacks, such for instance as Diamond Black. (a) Mordant a test skein of wool in a bath containing 8 per cent copperas and 10 per cent tartar; enter at 140° F., gradually bring to the boil and continue for one-half hour. Wash well and dye with 2 per cent Logwood extract (paste). Repeat the test, using 5 per cent, 10 per cent, and 15 per cent of Logwood extract (paste). With small amounts of Logwood only slaty blue or bluish gray colors are produced, but with the last test a full black color should be obtained. Usually alum and bluestone are also added to the mordant bath, in order to prevent the rather rusty appearance which the iron salt alone imparts.

(b) Mordant a test skein of wool with 5 per cent copperas, 2 per cent bluestone, and 2 per cent alum, and 10 per cent tartar. Dye with 15 per cent Logwood extract. In order to produce a fuller shade of dead black, a little Fustic is sometimes added to the dyebath as in the test with chrome blacks. The copperas black with Logwood is said to be superior to the chrome black, as it is less liable to turn green and the handle of the goods remains softer. Instead of mordanting before dyeing, the process may be reversed and the copperas bath may be used last. This method is said to give better results than the foregoing.

(c) Dye a test skein of wool in a bath containing 15 per cent of Logwood extract and 2 per cent of Fustic extract, add 5 per cent copperas and 2 per cent bluestone to the dye-

bath, and boil for three-quarters of an hour longer. This method is known as the "saddening" process. The addition of bluestone appears to make the black faster to light, and it is also probable that it assists in the development of the black by reason of its oxidizing action on the Logwood. The wool must not be washed between the operations of dyeing and mordanting, as a large part of the dyestuff would be removed, as it is not yet fixed in the fiber.

The addition of a small amount of calcium acetate to the dyebath with Logwood is said to be beneficial, in that it gives a greater intensity of color; the addition of this salt, however, is only necessary where the water employed is deficient in lime salts. Better results are also obtained when the mordanted wool is allowed to "age" for several hours before being dyed; this is probably due to the oxidation of the ferrous oxide in the fiber to the ferric condition, and this no longer exerts a reducing action on the Logwood.

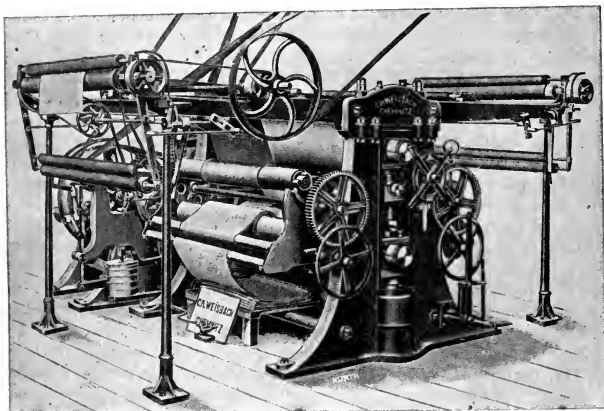

FIG. 249.—Hydraulic Mangle. (Weisbach.)

Exp. 173. Direct Chrome Black for Wool.—By boiling a solution of Logwood with potassium bichromate a black precipitate is obtained which may be used by the dyer as a direct chrome black. The paste is mixed with water and dissolved in oxalic acid, and the wool is then dyed in this solution. The results obtained by this direct black, however, are not as good as those produced with the preceding direct dyestuff prepared from iron and copper salts. Take 10 grams of Logwood extract (paste), boil up with a little water, and add 3 grams of potassium bichromate previously dissolved in a little water; boil the mixture for one-half hour; filter. With a portion of the precipitate so obtained, prepare a dyebath by mixing the pasty precipitate with water and adding sufficient oxalic acid to dissolve it. Dye a test skein of wool in this bath at the boil for one hour.

Exp. 174. Wooded Black on Wool.—This is the name applied to a black obtained by first dyeing the wool a blue in the Indigo vat, then topping off with Logwood, either with the copperas or chrome method. Take a test skein of wool which has been dyed a medium shade of blue in the Indigo vat, mordant it in the usual manner with 2 per cent

of chrome and 4 per cent of tartar; then dye with 10 per cent Logwood extract (paste). The purpose of the Indigo bottom is to give a richer and bloomier black, and one which is faster to light. Also, Logwood black on exposure is liable to become somewhat rusty in appearance, whereas if dyed over an Indigo blue, this rusty appearance is prevented. The mordanting of the wool with chrome must be done without the use of acid, otherwise the Indigo will be oxidized and destroyed, and even if carried out in the manner given above, it is very probable that a considerable amount of Indigo is removed from the wool. If only a small amount of Indigo is used in the first place the chances are that scarcely any Indigo will be left in the fiber, consequently its effect will be negligible. Sometimes the Indigo is not dyed on the fiber until after the chroming, in order to prevent loss of Indigo. Although woaded blacks have a good name, [it is doubtful if they are as good as blacks obtained by the use of Logwood, Fustic, and Alizarine.

Exp. 175. Logwood with Aluminium Mordant.—Logwood in connection with an aluminium mordant gives a violet-blue color. Mordant a test skein of wool with 6 per cent alum and 6 per cent tartar in the usual manner; wash well and dye with 2 per cent Logwood extract (paste). Repeat the experiment, using 5 per cent, 8 per cent, 10 per cent, and finally 15 per cent of Logwood extract. Unless the water of the dyebath contains considerable lime, there should be added 4 per cent calcium acetate, as this will give brighter shades. Water Blue may be added to the mordant bath in order to brighten the ultimate color.

Exp. 176. Logwood with Tin Mordant.—Logwood in connection with a tin mordant on wool gives a purple. The color is seldom used as a self shade, but Logwood blacks are frequently given a purplish tone by the addition of a small amount of stannous chloride. Mordant a test skein of wool in the usual manner with 4 per cent stannous chloride and 4 per cent oxalic acid; wash well, and dye with 2 per cent Logwood extract. Also dye skeins mordanted in the same manner with 5 per cent, 8 per cent, 10 per cent, and 15 per cent of Logwood extract. This color is not especially fast, and the tin mordant also imparts a harsh feel to the wool.

Exp. 177. Logwood Black on Cotton with an Iron Mordant.—The principal use of Logwood on cotton is for the production of blacks and grays in connection with an iron mordant. The chief salt used for this purpose is the so-called "nitrate of iron." The mordant is fixed by means of tannin. Steep a test skein of cotton yarn in a bath containing 4 per cent of tannic acid; enter at 180° F., work for fifteen minutes at that temperature, then allow to steep under the liquor without further heating for one hour. Squeeze, and pass through a bath of nitrate of iron at 4° Tw. for fifteen minutes cold; then squeeze and pass through a weak bath of lime-water cold for ten minutes, and finally wash well. The tannate of iron thus formed on the fiber imparts to the cotton a dark gray color. Now dye the skein in a bath containing 15 per cent of Logwood extract (solid) and 2 per cent soda ash; enter at 160° F., gradually raise to the boil, and dye at that temperature for three-quarters of an hour. Wash well and dry.

Exp. 178. To Obtain a Faster and Clearer Black.—Mordant a test skein of cotton yarn in the same manner as above with 4 per cent of tannic acid, and then fix by passing through the baths of nitrate of iron and lime-water. Then dye as before with 15 per cent of Logwood extract. After dyeing, work the skein in a bath containing 1 per cent of chrome; enter at 180° F., work for fifteen minutes at that temperature, then squeeze and wash well, and finally soap off in a warm dilute soap bath. Instead of using the chrome bath the dyed material may be passed back into the nitrate of iron bath. This after-treatment and scouring with soap have the effect of preventing the rusty appearance liable to develop when Logwood is dyed with an iron mordant. It is sometimes the practice to pass the cotton through a weak lime bath after coming from the tannin bath and before entering the bath of nitrate of iron; this causes the formation of tannate

of lime, and prevents a large amount of the unfixed tannin from passing into the iron bath and precipitating tannate of iron.

Exp. 179. Dyeing Logwood without Tannin.—Cotton may also be dyed with iron and Logwood without the intervention of tannin. Steep a test skein of cotton yarn in a bath containing nitrate of iron at 8° Tw., cold, for one-half hour; squeeze and work for fifteen minutes in a bath containing 5 grams of soda ash at 140° F. This causes a precipitation of ferric oxide or iron buff in the fiber. Wash, and dye as previously described in experiment 1 with 15 per cent of Logwood extract.

Exp. 180. Logwood on Cotton with Copperas.—This salt is usually employed for mordanting inferior qualities, while nitrate of iron is used for better qualities of black.

(a) Steep a test skein of cotton in the sumac bath as before described; pass through a bath containing 10 per cent copperas at 140° F., then through a weak bath of lime water.

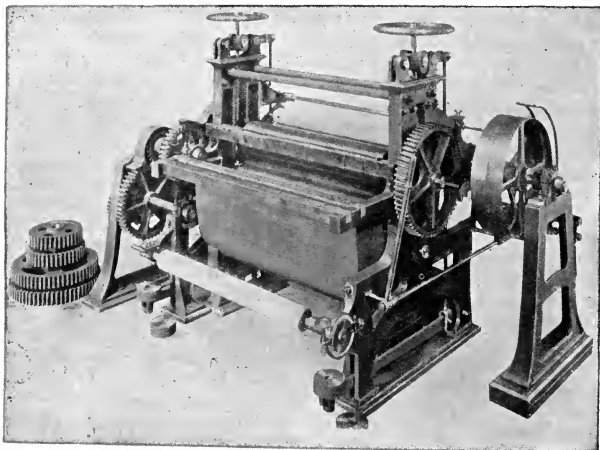

FIG. 250.—Friction Mangle and Sizing Machine for Heavy Goods.

Wash and dye with 15 per cent Logwood extract. After dyeing pass back into copperas bath for a short time to fix any excess of coloring matter; finally soap off.

(b) Sometimes bluestone is added together with the copperas as a mordant for the purpose of improving the tone of the black obtained and also to increase its fastness to light. Mordant a test skein of cotton with sumac as before described; pass through a bath containing 10 per cent copperas and 5 per cent bluestone at 140° F., then through a weak bath of lime water. Wash and dye with 15 per cent Logwood extract and 3 per cent Fustic extract; after dyeing add to the dyebath 5 per cent copperas, and boil for fifteen minutes longer. Finally soap off.

(c) In order to give a purplish cast to the black obtained, alum may be added with the iron as a mordant. Mordant a test skein of cotton with sumac as before; pass through a bath containing 10 per cent copperas and 5 per cent alum at 140° F., then through a weak bath of lime water. Wash and dye with 15 per cent Logwood, and finally soap off.

Exp. 181. Chrome Black on Cotton.—Although there are a number of methods

whereby this black may be obtained on cotton, it is not as satisfactory a black as that obtained with the iron mordant.

(a) Boil a test skein of cotton in a bath containing 100 per cent Logwood extract for one hour; squeeze and expose to the air for two hours, then work cold for one hour in a solution containing 6 per cent chrome and 5 per cent bluestone; wash, and next work in a bath containing 10 per cent Logwood extract; enter cold, and slowly raise to the boil. Although a very strong solution of Logwood is required for this method, the liquors may be kept for subsequent lots of cotton, and only slight additions of dyestuff need be made to the bath each time.

(b) *Chrome Black in One Bath.*—Dissolve 1.5 grams potassium bichromate in a small quantity of water, and mix with 300 cc. of a solution of Logwood extract at 3° Tw., then add 3.5 cc. of hydrochloric acid. Dye a test skein of cotton in this solution for one hour, entering cold and slowly raising to the boil. The cotton is at first dyed a deep blue color. Next work for one-half hour in a bath containing 5 per cent calcium acetate, and the color will change to a blue black. A modification of this process is to work the cotton in a solution containing at first only the chrome and hydrochloric acid, and adding the Logwood to the bath in small portions at a time, slowly raising the temperature to the boil.

A composition prepared by boiling together a solution of Logwood and chromium acetate has been sold under the name of Indigo Substitute. It is a purplish blue liquid, and cotton is dyed by simply working it in a hot solution of the mixture.

Chrome black on cotton is less affected by acids than the iron black, and it may be distinguished by spotting with strong sulphuric acid when it becomes of a dark olive color, whereas the iron black turns reddish brown. Chrome black is also quite fast to scouring and fulling, but it is not very fast to light, as it assumes a greenish cast. This bad effect, however, may be more or less overcome by adding to the dyebath a small amount of a suitable red dyestuff, such as Alizarine.

Exp. 182. Logwood with Copper Mordant.—Cotton may be dyed with Logwood in one bath with this mordant.

(a) Dye a test skein of cotton in a bath of Logwood extract at 3° Tw. and 6 per cent copper acetate, entering cold and slowly bringing to the boil, and continuing for one hour. Wash in a weak hot bath of lime water.

(b) Another method is the following: Prepare a bath of Logwood extract at 3° Tw., and add 4 per cent bluestone and 4 per cent soda ash. Dye a test skein of cotton in this bath at 180° F. for one hour; squeeze and age in the air for several hours. In order to obtain a deep full black the operation must be repeated two to three times. The method is not a very economical one, but it is said to give a color which is very fast to fulling. Instead of using the mixture of bluestone and soda ash, copper carbonate itself may be used.

Exp. 183. Logwood Gray on Cotton.—This may be produced in a variety of ways by using small amounts of the coloring matter.

(a) *One-bath Method.*—Dye a test skein of cotton in a bath containing 5 per cent Logwood extract and 1 per cent copperas at 150° F. for one hour. After dyeing the first skein, use the same bath for dyeing three other skeins successively. Comparatively little precipitate is produced in the bath, and the color is fully developed only after exposure to the air for some time and washing.

(b) Another method is the following: Dye a test skein of cotton in a bath containing 5 per cent Logwood extract at 150° F. for one-half hour; squeeze, and work in a second bath containing 1 per cent chrome at 150° F. Finally wash and soap. Instead of using chrome a bath of copperas may be used.

By adding to the Logwood bath small amounts of Fustic or other coloring matters, a large variety of different shades of gray may be obtained.

Exp. 184. Logwood Purple on Cotton.—This is obtained by mordanting the cotton with stannous chloride, washing and then dyeing with Logwood.

Steep a test skein of cotton in a bath containing 5 per cent stannous chloride (brought into solution by the addition of the necessary hydrochloric acid); wash, in cold water; this will cause the precipitation of the oxychloride of tin on the fiber. Then dye in a bath containing 10 per cent Logwood extract in the usual manner. The color so obtained is rather fast to washing but is not fast to light.

Exp. 185. Logwood Blue on Cotton.—This is obtained by the use of a copper mordant, but is seldom used at the present time, as it is not at all fast.

Dye a test skein of cotton in a bath containing 10 per cent Logwood extract and 5 per cent copper acetate; enter cold and slowly raise the temperature to 140° F. The color produced in this manner has a strong resemblance to vat Indigo blue.

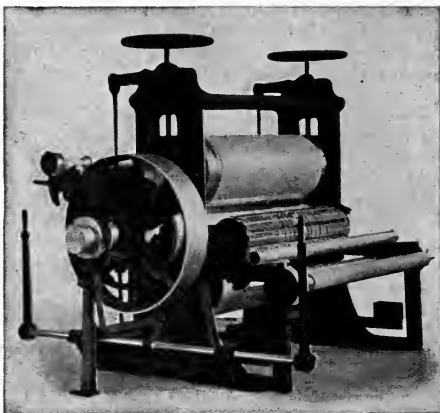

FIG. 251.—Three-Roll Calendar with Expander. (H. W. Butterworth & Sons Co.)

Exp. 186.—Dyeing Silk a Pure Black with Logwood.—By “pure” black is meant one which does not contain any weighting materials. Mordant a test-skein of silk yarn in a bath containing 150 cc. of water and 20 per cent of cutch; enter at 120° F., and gradually bring to the boil, then allow to cool in the bath for one-half hour; next rinse the skein slightly and pass into a bath of nitrate of iron at 10° Tw., work at 120° F. for fifteen minutes, then pass through a dilute bath of soda ash, and wash well. Next dye in a bath containing 150 cc. of water and 25 per cent of Logwood extract (solid) and 5 per cent of soda ash; enter at 140° F., gradually bring to the boil, and dye at that temperature for one-half hour, then wash well and dry.

Exp. 187. Valuation of Logwood and Logwood Extracts.—The only reliable method for judging the tinctorial power of Logwood chips or extracts is to make a comparative dye-test, using skeins of woolen yarn which have been previously mordanted with 3 per cent of chrome and 1 per cent of sulphuric acid. To conduct the test 20 grams of the chips are taken and boiled up for fifteen minutes with 200 cc. of water; the extract is run off into graduated flask of 500 cc. capacity, and the residue is again boiled for fifteen minutes with 100 cc. of water, and the liquid poured into the flask. This is continued until the

flask is filled to its mark. In the case of extracts, 10 grams of the pastes are taken or 5 grams of the solids, and dissolved in water, and diluted to 200 cc. The standards for comparison are made up in the same way and of the same strength. The dye-tests are performed in the usual manner; that is to say, matching the sample to be tested against the standard and noting the relative amounts of the two which are required.

In order to determine the relative proportion of hematoxylin and hematine (in other words the degree of oxidation) it is well to proceed as follows: Mordant one test skein of wool with 3 per cent of chrome and 1 per cent of sulphuric acid and a second skein with 3 per cent of chrome and 4 per cent of tartar. Dye each of these test skeins with 2 per cent of the extract under examination, and compare them for the depth of color developed. The first skein will show the entire color present (both the hematoxylin and the hematine) whereas the second skein will show principally the hematine. By comparing the results with tests on known standards of oxidation it will be possible to arrive at a close approximation of the degree of oxidation.

CHAPTER XXI

THE MINOR NATURAL DYES

1. Fustic.—This coloring matter is obtained from the wood of a tree botanically known as *Morus tinctoria*. It is also known as Cuba wood or yellow wood. It is obtained in the West Indies and Central and South America, the best varieties being obtained from Cuba and Tampico. Fustic gives a bright yellow color with an alum mordant, with chromium an olive-yellow, with iron a dark olive, with copper an olive, and with tin a bright orange-yellow. Fustic may be used either in the form of the chipped wood or as the extract, the latter being obtainable either as paste or solid. At present it is seldom used as a self color, but it still finds considerable use in connection with Logwood for the dyeing of dead-black shades.

Fustic appears to contain two coloring matters, morintannic acid and morin. The former, known also as maclurin, is readily soluble in water, and may be crystallized from solution in the form of light yellow microscopic needles. It has the composition $C_{13}H_{10}O_6$; when heated with strong caustic alkali it is decomposed into phloroglucin and protocatechuic acid. It dissolves in cold concentrated sulphuric acid with a yellow color and is reprecipitated on dilution with water. If the strong acid solution is allowed to stand for some days it deposits brick-red crystals of rufimoric acid. If a solution of morintannic acid is treated with zinc and sulphuric acid, the solution becomes red and then orange, and contains phloroglucin and machromin; the latter crystallizes in slender needles which become blue on exposure to the air. Hydrochloric acid gives a blue precipitate, and the alkaline solution also becomes blue on exposure to the air. A solution of machromin with ferric chloride gives a violet color gradually becoming blue; mercuric chloride gives the same result. A solution of morintannic acid with gelatin gives a yellow precipitate, with ferro-ferric sulphate a greenish precipitate, acetate of lead a yellow precipitate, and stannous chloride an orange precipitate. Morin, on the other hand, is almost insoluble in cold water, and only slightly soluble in boiling water.

It is also known as moric acid, and has the formula $C_{12}H_{10}O_6$. It is soluble in alkalies, with a yellow color, from which solution it is reprecipitated by the addition of acids. It is soluble in alcohol, and this solution with ferric chloride gives an olive-green color. Morin appears to give much deeper shades with chromium and aluminium mordants than morintannic acid, but it gives lighter shades with iron mordants. Morintannic acid may be prepared from commercial Fustic extract by allowing the concentrated syrupy solution to stand for some days, when an abundant crystalline deposit will be formed; this is washed rapidly with a little cold water and strongly pressed. The resulting mass is boiled twice with water, whereon a solution containing morintannic acid will be obtained, the residue consisting of moric acid and morate of lime. The aqueous solution is con-

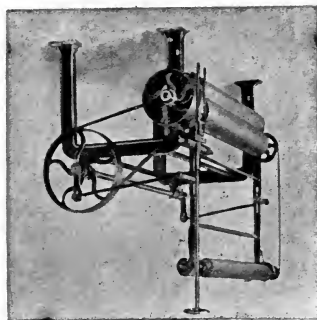

FIG. 252.—Overhead Folding Attachment. (Curtis & Marble.)

centrated by evaporation, and precipitated by the addition of hydrochloric acid. Pure moric acid may be obtained from the residue by treating with dilute hydrochloric acid (to decompose the calcium morate) and dissolving in alcohol. On diluting with water this solution deposits moric acid in the form of yellow needles.

A solution of Fustic gives the following reactions:

Alkalies: Orange to brown color.

Weak acids: Pale yellow precipitate.

Alum: Bright yellow precipitate.

Lead acetate: Orange precipitate.

Copper acetate: Brownish yellow precipitate.

Ferrous sulphate: } At first olive color, then brownish olive precipitate on standing.

Ferric sulphate: }

Stannous chloride: Brownish yellow precipitate.

Copper sulphate: Dark green precipitate.

Gelatin: Yellow flocculent precipitate.

Fustic occurs in commerce in the form of log, chipped, rasped, ground, or as an extract. The extract is frequently sophisticated with glucose and Quercitron bark extract, and varies in its specific gravity from 40 to 51° Tw. The specific gravity, however, like that of Logwood, is of no guide to its value, on account of it being increased by the addition of adulterants.* The best method of making a valuation of Fustic in any of its forms is to conduct a series of comparative dye-tests on skeins of woolen yarn which have been previously mordanted with 3 per cent of chrome and 4 per cent of tartar, as in the case of Logwood, or with 3 per cent of stannous chloride and 5 per cent of oxalic acid. The tests are carried out in the usual manner.

Fustic is more used on wool than on cotton, and the general mordant employed is chrome, though when bright yellow colors are desired aluminium or tin mordants are used.† The color obtained with the latter, however, is not very fast to washing and is quite fugitive to light, becoming duller and browner on exposure. Even on a chrome mordant, however, the color cannot be classified as fast to light. In the dyeing of Fustic prolonged boiling must be avoided, as this causes the color to be dull and brownish, probably due to the presence of considerable tannin matter in the dyestuff which by protracted boiling and oxidation suffers decomposition into brownish coloring matters. The addition of some glue solution to the dyebath is said to obviate this defect.‡

* By treating Fustic with a diazotized solution of aniline (in hydrochloric acid) a paste product is obtained known as *Fustin* or Wool Yellow. It is an acid dye, but can also be used on a chrome mordant. It gives a more intense but redder shade than Fustic, but the colors obtained are not so fast. Osage Orange gives the same product in this respect as Fustic. As there are many other yellow dyes of better quality than this product, it has little or no use at the present time.

† The different metallic mordants give the following colors with Fustic:

Chromium.....	brown-yellow
Aluminium.....	yellow
Iron.....	olive
Tin.....	Bright yellow
Copper.....	olive

‡ **Detection of Fustic on the Fiber.**—As the most common mordant for Fustic is chromium, where this dye has been used, the ash of the fabric will generally contain chromium. In bright yellows or oranges, tin is liable to be found. Fustic is difficult to distinguish on the fiber from Persian Berries or Quercitron bark, as the reactions of these are very similar. The presence of Fustic in compound shades is also very difficult to detect. In the case of browns obtained with Logwood, Alizarine and Fustic, the dye should be fast to soap, give no color to alcohol, and if the fabric is boiled in a solution of aluminium acetate a yellow solution with a green fluorescence should be obtained; this

Another coloring matter similar to Fustic, and which once had considerable use, is the so-called *Young Fustic*. This dyestuff consists of the ground wood of the sumac tree, *Rhus cotinus*. It was employed in practically the same manner as Fustic (which was known as *Old Fustic*), but was a much inferior dyestuff, owing to its fugitive character. It has now practically disappeared from trade.

2. Osage Orange is a yellow dyestuff apparently almost identical with Fustic. It is the extract obtained from the wood of the osage orange tree which is found in great abundance in the southwestern districts of the United States. It also is known under the trade name of *Aurantine*, and occurs in commerce both as the liquid extract of 51° Tw. and the solid or powdered extract. This dye was commercially developed to a large extent during the War, and now bids fair to be a permanent feature in the dyestuff trade. Osage Orange is used in exactly the same manner as Fustic and shows the same reactions and qualities as to color. It yields

solution on evaporation with nitric acid becomes red. The following table gives the reactions of wool dyed with Fustic on a chromium and on a tin mordant:

Reagent.	Chromium.	Tin.
Hydrochloric acid.	<i>Nil.</i>	Yellow solution; colorless on dilution.
Sulphuric acid.	Little change; solution yellow; on dilution fiber lighter, solution colorless.	Solution yellow, remaining so on dilution.
Nitric acid.	Brown; on adding soda, red.	Brown; on adding soda, red.
Stannous chloride.	Little action.	Little action.
Caustic soda.	Fiber brown; solution colorless.	Browner; solution yellow, decolorized on adding HCl.
Boiling alcohol.	<i>Nil.</i>	<i>Nil.</i>
Boiling soap (1 per cent)	Fiber redder; solution faint yellow.	Fiber straw; solution deeper yellow.
Boiling soda ash ($\frac{1}{2}$ per cent)..	Fiber redder; solution orange-yellow.	As with soap.
Boiling sulphuric acid (5 per cent).	Fiber lighter; solution yellow.	Fiber hardly changed; solution yellow.

shades which are slightly redder in tone and somewhat brighter than most samples of Fustic.

Fustic is still employed to a very large extent for the dyeing of heavy woollens, principally in compound shades with other mordant and natural dyes such as Logwood, Red-woods, Archil, Alizarines, etc. It is always used with a chrome mordant, and it is best that the mordant be applied first rather than after dyeing. It is used in the production of brown and drab shades fast to fulling. Some dyers still consider it the best yellow coloring matter available for wool, though it is not as fast to light as some other yellow dyes. Fustic is seldom used as a self color for the production of yellows.

In silk dyeing, Fustic is used to some extent for the shading of Logwood black; but beyond this it has little or no application to silk, at least in this country. It was formerly used for the dyeing of olive and brown shades in connection with other dyewoods.

3. Madder.—This dyestuff was formerly of very great importance, and was largely cultivated in the southern part of Europe and Asia Minor. It was used for the production of Turkey Red on cotton and the dyeing of red on wool. Madder, however, has long been replaced by the coal-tar *Alizarine* which is identical in composition and properties to the natural product.

Madder is the ground root of the plant known as *Rubia tinctorum*; the principal coloring matters yielded by the madder root are *alizarine*, *purpurin*, *pseudo-purpurin*, *xanthin*, and *chlorogenin*; the aqueous extract also contains from 10 to 15 per cent of *sugar*. The most important of these constituents is the Alizarine, the other coloring matters, especially the xanthin and chlorogenin, have a deleterious effect in dulling the color produced by the Alizarine. The coloring matters exist in the root in the form of glucosides, which are split up into the dyestuffs and a sugar through the action of a particular ferment.

Alizarine which is the principal coloring matter of the Madder, may be obtained therefrom by extracting the ground root with alcohol, evaporating the solution to dryness, powdering the residue, spreading it on a filter paper on a heated plate; the extract melts and the paper absorbs the brown resinous matters, while the alizarine sublimes on the surface of the mass as large orange-red crystals.

Alizarine possesses the characteristics of a phenol, and is readily soluble in alkalies, with red color; it is only slightly soluble in boiling water with a yellow color. Its solution gives the following reactions:

Alkalies: Bluish claret color.

Acids: Brownish yellow color.

Alum: Brownish red precipitate.

Stannous chloride: Brownish red precipitate.

Iron salts: Dark brown precipitate.

Copper salts: Reddish brown precipitate.

Barium and calcium chlorides: Violet precipitates.

Lead acetate: Reddish violet precipitate.

When Alizarine is distilled with zinc it gives anthracene, from which reaction its synthetic preparation from the latter body was finally discovered.

Purpurin, which also exists in the madder root, resembles Alizarine but is more yellow in color. It may be prepared from Alizarine by heating the latter with manganese dioxide and sulphuric acid.

Madder was used principally in the form of the ground root, but there were also numerous extracts and preparations made for the use of the dyer. *Garancin* was obtained by treating the wet paste of Madder with concentrated sulphuric acid; 100 parts of Madder gave from 30 to 40 parts of *Garancin*, but this possessed four to five times the dyeing power of the original Madder. It is supposed that other bodies which detracted from the good color of the Alizarine in the Madder were removed by this treatment, and also any coloring matter which may have been combined as metallic salts was liberated and rendered more active in dyeing. *Garanceux* was obtained from spent Madder by the same process as the above; its coloring power, however, was only about one-third that of good *Garancin*. *Fleurs de garance*, or *flowers of madder*, was prepared by treating Madder with dilute sulphuric acid, whereby any yellow coloring matters were removed. To prepare it, mix 100 parts of Madder with 1 part sulphuric acid and 1000 parts water, and allow the mixture to macerate for ten hours; filter, wash the paste, press and dry. The acid liquors from this process were used for the manufacture of alcohol, as they contained considerable sugar; 100 parts Madder yielded about 10 parts alcohol.

Madder gives the following colors with the different mordants:

Chromium: Bluish red to crimson.

Aluminium: Pink to scarlet.

Iron: Maroon to reddish brown.

Copper: Yellowish brown.

Tin: Reddish orange.

Madder is still used in the woad indigo vat, but in this case it is more employed for its fermenting properties than for any coloring power.

The chief varieties of Madder are Dutch, Alsatian, Avignon, and Turkish. Dutch Madder is coarsely ground, and if kept in a moist place tends to cake together. *Crop Madder*, which is the ground inner portion of the root, is considered as the best quality, while the outer part is known as *mulle madder*, and is the poorest. Alsatian Madder is very like the Dutch. Avignon Madder is known in two varieties, the *palus* and the *rosée*. The former is much the darker in appearance, due to the nature of the soil on

which it is grown. Avignon Madder does not require to be matured by storage for as long a time as Dutch and Alsatian Madders, which should be stored in casks for two years before use. Turkish Madder is exported chiefly from Smyrna and is very rich in coloring matter.

The color solution of Madder is best prepared by boiling the rasped wood in water and straining through cheesecloth, making use of the clear solution for the dyebath. The colors obtained on the various mordants are not as clear and bright as those produced from Alizarine. The use of calcium acetate in the dyebath serves the purpose of brightening the color; in case the water contains considerable lime this addition need not be made, but sufficient acetic acid should be added. Madder may be dyed in a single bath, using 5 per cent of alum, 4 per cent of tartar, 4 per cent of calcium acetate, and 10 per cent of Madder; enter the material cold and

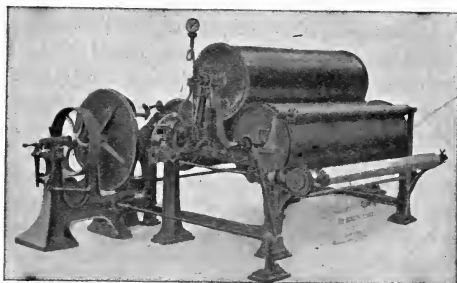

FIG. 253.—Lustering Machine for Wool, Unions, Silk and Half-Silk Goods.

slowly bring to the boil, and maintain at that temperature for one hour. This method is used only for the dyeing of light colors, as otherwise there would be considerable precipitation of coloring matter in the dyebath. A pale brownish drab stain on wool may be produced by boiling with a decoction of Madder without the use of any mordant whatever. This method, in fact, has been used in practice. The colors produced with Madder on either a chromium or an aluminium mordant may be considerably brightened by the addition of a small amount of tin crystals to the mordanting bath. In order fully to develop the coloring power of Madder it is necessary that the temperature of the dyebath be gradually and regularly elevated to the boiling point. The addition of a small amount of sumac (or other tannin extract) to the dyebath serves to give better exhaustion of the coloring matter.

4. Archil.—This coloring matter is obtained from certain species of lichens, the principal varieties of which are *Roccella tinctoria*, *Roccella*

fuciformia, and *Variolaria orcina*.* The dyestuff occurs in the form of a paste, and is prepared by treating the lichens to a process of oxidation in the presence of ammonia. The principal color-producing compounds existing in the lichens are *erythrin*, *lecanoric acid*, and *evernic acid*. The lichens are torn up into small fragments, placed in iron drums provided with stirrers, and mixed with a dilute solution of ammonia. The temperature is kept at about 100° F. for several days, during which time the mass undergoes a fermentation which causes the development of the coloring matter. When the latter ceases to increase (which is determined by making tests from time to time) the fermentation is stopped. The product so obtained is **Archil paste**; **Archil liquor** is prepared by removing the fibrous matter of the plant. **French purple** is a preparation of Archil which is said to give faster shades than the ordinary product; it is made by treating the lichens with a dilute solution of ammonia, acidulating the resulting liquid with hydrochloric acid, which precipitates the coloring matters. This precipitate is washed, dissolved in strong ammonia, and kept for about three weeks at a temperature of 160° F., during which time a fine purple color is developed; calcium chloride is added and a purple lake is precipitated. When used for dyeing this lake is mixed with an equal weight of oxalic acid and dissolved in water.

A solution of Archil gives the following reactions:

Acids: Solution yellower.

Alkalies: Solution bluer.

Lead acetate: Crimson precipitate.

Calcium chloride: Red precipitate.

Stannous chloride: First redder, then yellower.

Alum: Solution redder.

Basic alum: Crimson-red precipitate.

The coloring principle of prepared Archil is known as *orcein*.

Archil, or Orchil, was formerly prepared by treating the lichens with water containing putrid urine, and at a subsequent stage with slaked lime. Archil is chiefly employed for the dyeing of carpet yarns. Archil is a substantive dye and may be used on wool or silk in a neutral, acid, or slightly alkaline bath. It dyes very slowly and evenly and in heavy shades it has great depth and body which cannot be matched advantageously with any of the coal-tar dyes. Both Archil and Cudbear dye best in a neutral bath and when used alone they give bluish red or magenta shades. In acid baths the shade is redder and brighter. Silk is usually dyed in a soap bath broken with acetic acid.

* These lichens are found in large quantity in Mediterranean districts; also in Scotland and Norway. They are also found in certain portions of Lower California, and attempts have been made during the past few years to develop an Archil industry in that country. The quality and exact color produced by Archil varies considerably with the source of the lichen from which the dye is obtained.

Archil* occurs in trade in three forms: (1) as a thick liquor called Archil; (2) as a paste called **Persis**; and (3) as a reddish brown or purple powder termed **Cudbear**. The liquor varies in specific gravity from 8 to 20° Tw.; the paste is usually a 35 per cent one, but is sometimes as low as 20 per cent. Archil is sometimes adulterated with other vegetable coloring matters such as Logwood, Sapan, Brazil-wood, etc., and also with coal-tar dyes, especially Magenta. Pure Cudbear is obtained from a lichen known as *Lecanora tartarea*. It is prepared and used in exactly the same manner as Archil, and gives the same colors; it also yields the same reactions. In fact, the two dyes commercially are not distinguished.

5. Quercitron.—This dyestuff is from the inner bark of a species of oak, the botanical name of which is *Quercus citrina* or *Quercus tinctoria*. It is found principally in Pennsylvania, Georgia, and the Carolinas. Its dyeing properties are due to two principles, *quercitrin*, $C_{36}H_{38}O_{20}$, and *quercetin*, $C_{22}H_{24}O_{11}$. The best varieties are shipped from Philadelphia, New York, and Baltimore; the Philadelphia variety being the most highly prized.† It is principally used in calico printing for the production of compound shades in conjunction with mordants of aluminium, tin chromium, and iron. It is also employed in woolen printing and leather dyeing. In the dry condition, Quercitron is of a yellow or buff color, being a mixture of the fibers with a fine powder of a bitter and astringent taste. The extract when freshly prepared is nearly transparent and of a dull orange-red color, which on standing deposits a yellow crystalline powder, and becomes turbid and considerably thicker. The extract is adulterated chiefly with molasses. In the form of extract it is known as **Bark Extract** and is usually sold at a density of 51° Tw.

Patent Bark is prepared by boiling ground Quercitron bark with dilute sulphuric acid, the product being washed and dried. Its chief use is as a substitute for Flavine in wool dyeing.

Flavine is a very pure dry extract of the coloring matter of Quercitron bark.‡ The best varieties contain a large proportion of quercetin, and yield yellow colors of great brightness.§ Flavine is still somewhat used in

* Archil is also still used to a considerable extent for "bottoming" Indigo on wool. It is also used in the dyeing of browns, maroons, clarets and similar compound shades on wool.

† Quercitron is essentially an American dye-product, it has long been made in large quantities in this country, and strange to say, has been extensively exported to Germany. Quercitron is not much used in this country for the dyeing of textiles, but it still has considerable vogue in calico printing and leather dyeing.

‡ The coloring power of Flavine is from twelve to twenty times that of Quercitron bark.

§ When dry Quercitron extract is treated with concentrated sulphuric acid a sulphonic acid derivative is apparently formed. This acts as a yellow acid dye for unmordanted wool.

conjunction with Cochineal for the production of bright yellowish scarlet colors.*

The colors obtained from Quercitron and Flavine are dulled by prolonged boiling in the dyebath owing to the presence of considerable tannin. The addition of glue solution is beneficial in this respect.

6. Cutch.—Cutch, or Catechu, is the dried extract obtained from several Indian trees, a species of *Acacia*, the chief variety being *Acacia catechu*. The principal varieties are Bombay, Bengal, and Gambier Cutch. Bombay Cutch is obtained from the fruit and wood of the *Arcea catechu*, a kind of palm. Bengal Cutch is obtained from the twigs and unripe pods of the *Mimosa catechu*. The above two varieties are very similar in appearance, coming into commerce in the form of large blocks of a dark brown color, weighing from 30 to 40 lbs. and packed in leaves. They are hard but brittle, and are imported from Java, Singapore, Peru, and the East Indies. Gambier Cutch, called also cubical or yellow cutch, is obtained from the leaves of the *Uncaria gambier*, and occurs in trade in the form of small cubes. It is much more yellow in appearance than the two other varieties and is also much less soluble in cold water. It has a dull, earthy fracture and is porous. The best variety is grown in Rhio, in the Isle of Brittany, and is imported from Singapore. Another variety of Cutch is *kino*, or *gum kino*, which is obtained from the *Pterocarpus marsupium*. It has a reddish brown color and a highly lustrous fracture.

Cutch contains two principal coloring matters, *catechin*, $C_{19}H_{20}O_2$, and *catechu-tannic acid*, $C_{38}H_{36}O_{16}H_2O$. It is chiefly used in cotton dyeing and in calico printing for the production of brown shades or as a tannin mordant to be topped with basic or other colors. Good qualities of Cutch should not contain more than 5 per cent of ash on ignition, nor more than 12 per cent of matter insoluble in alcohol. It is frequently adulterated with starch, dried blood, sand, and clay. Starch is detected by treating the sample with alcohol, filtering, and dissolving the residue in hot water, cooling, and testing for starch with an iodine solution. Pure Cutch gives a decided green color with solutions of ferric salts, so the addition of other tannin matters may be recognized by the modified color given with ferric salts. Sand, clay, etc., are easily detected by making up a decoction of the sample and observing the amount of insoluble residue which remains, as pure samples should be almost entirely soluble in hot water. Blood may be detected in a similar way as starch, by treating the sample with alcohol, the

* Neither Quercitron nor Fustic are equal to certain of the mordant dyeing coal-tar dyes in respect to purity and brightness of shade or fastness to light. Tartrazine is an acid yellow of great brightness and intensity which is much superior to these natural yellow dyes in fastness to light. Milling Yellow O is a mordant dye which is faster both to light and fulling. Chrysophenine is a substantive dye which gives bright yellow shades on wool of great fastness to light.

residue being dried and heated in a test tube, when, if blood is present, ammonia and offensive odors are given off.

As already mentioned, Cutch contains two coloring principles; the one is soluble in cold water and is termed catechu-tannic acid, or *mimotannic acid*; the other is nearly insoluble in cold water and is termed catechin or *catechuic acid*, a brown amorphous substance. Catechu-tannic acid may be obtained by boiling pulverized Cutch with water, allowing the solution

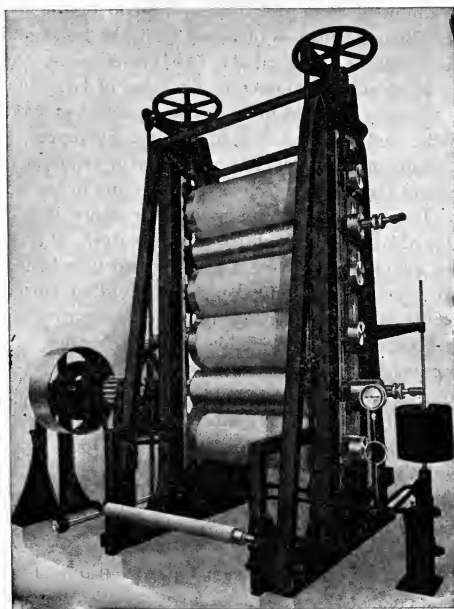

FIG. 254.—Six-Roll Calender Hydraulic. (H. W. Butterworth & Sons Co.)

to stand for several days, when the catechin separates out and may be filtered off. The filtrate is evaporated to dryness and treated with alcohol to remove impurities. The product is a reddish brown powder soluble in water and alcohol, but not soluble in dry ether. With ferric salts it gives a grayish green precipitate, and gives no reaction with ferrous salts. Its aqueous solution is precipitated by gelatin, albumin, and sulphuric acid. Cutch may contain from 35 to 55 per cent of catechu-tannic acid, according to its source. With alkalis catechu-tannic acid forms soluble salts, the

solutions of which rapidly oxidize on exposure to the air and become of a reddish color.

Catechin forms that part of Cutch insoluble in cold water. It is obtained in the pure state by taking the solid which separates out after boiling Cutch with water and cooling; it is purified by redissolving in hot water, boiling with animal charcoal to decolorize it, filtering hot, and allowing to cool. These operations may have to be repeated several times. The product obtained is in the form of white silky crystalline needles, which are very slightly soluble in water. Catechin precipitates albumin, but not gelatin. When dissolved in concentrated sulphuric acid it gives a purplish colored solution. Though sometimes called catechuic acid, catechin has no acid properties, and is neutral to litmus. When dissolved in solutions of alkaline carbonates it rapidly absorbs oxygen from the air and becomes dark red in color; and on the addition of an acid dark red *rubinic acid* is precipitated. If caustic alkalies are used as the solvent, then a very dark brown, nearly black, precipitate of *japonic acid* is obtained under similar conditions. This same substance is formed when a decoction of Cutch is oxidized with potassium bichromate; and, in fact, it is on this property that the dyeing powers of Cutch depend.

Dyers utilize the coloring properties of both catechin and the catechutannic acid, but the calico printer requires chiefly the catechin. In general, Cutch is used in cotton dyeing for the production of browns and as a tannin mordant; it is, however, somewhat used in woolen and silk dyeing, being employed in the latter chiefly as a weighting and mordanting agent in the production of blacks. It is also used for the dyeing and preserving of sails and fishing nets, as well as in medicine as an astringent, and also in the tanning of leather.

Cutch is best applied to cotton by boiling the goods in a decoction of the dyestuff and then allowing to stand for some time after which the cotton is taken out, squeezed, and worked in a hot bath containing potassium bichromate, which acts on the soluble catechin, and catechu-tannic acid to produce insoluble japonic acid on the fiber.* Some dyers enter the cotton into a hot bath of Cutch, then work it for some hours without further application of heat, and treat it as before with chrome. It is possible to use bluestone instead of chrome, and if the color is developed by the former it appears much yellower and not quite so full in shade as the colors produced by the latter. If bluestone is used, it is the better plan to add it directly to the bath containing the Cutch, and afterwards to develop in

* *Detection of Cutch on Dyed Fabrics.*—Generally speaking, the color of Cutch is but little changed by reagents. Sulphuric and hydrochloric acids have but little action. With nitric acid the color is changed to orange. Ammonia has no action. Boiling solutions of bleaching powder destroy the color more or less. The ash will be found to contain chromium, and very often a little copper.

the usual way with chrome. In the latter case, the shades are fuller and faster to light than would be the case if no bluestone were used. Copperas may also be added to the bath for the purpose of darkening the shade. It is advisable when dyeing very dark Cutch browns to first work in a fairly weak bath, develop in the chrome and afterwards work in the Cutch bath again, and again develop with chrome, and repeat this until the required depth of shade is obtained. By this means, darker, fuller, and more level shades may be obtained than by using very strong solutions of Cutch. This method is especially applicable to the dyeing of warps and cotton pieces. It should be noted that the presence of copper in the color-lake appears to make it faster to light. Instead of using the copper sulphate directly in the Cutch bath, as is usually done, the cotton may be worked in a cold solution of the salt, either on coming out of the Cutch bath or after being developed. Though chrome and bluestone are the chief metallic salts employed for fixing Cutch in cotton dyeing, other salts may also be used. Aluminium salts give a yellowish brown color, while tin salts give a still yellower color; copperas gives a brownish gray. Cotton dyed with Cutch has the property of being afterwards dyed with the basic and with alizarine (or natural) dyestuffs. In the former case it is the catechutannic acid, or the products formed from it by oxidation, that act as the mordant; in the latter case it is the chromium or copper fixed in the fiber which acts as the mordant. It is apparent, therefore, that if the tone of a Cutch brown has to be altered this may be accomplished by any suitable dyestuff of the above groups. In the case of the coloring matters requiring a metallic mordant, the dyestuff may be added directly to the Cutch bath, when, of course, the color produced by it would be developed at the same time as the Cutch. With the basic colors, however, it would be necessary to first dye the Cutch brown and then top off in a separate bath with the basic color.

At the present time Cutch is very little used as a dyestuff for wool, although for the production of certain brown shades it might be employed with advantage. The objections to the use of Cutch are several: (a) The wool acquires a harsh feel; this might be remedied to a certain extent by using only the catechin, but this is too expensive. (b) The best and fastest shades are produced by the so-called "saddening" process; that is, first boiling the wool with the coloring matter and then fixing in a fresh bath with a solution of a metallic salt. As this process is not a very convenient one for dyeing to shade, it is easy to understand why Cutch is not much used. The manner of dyeing wool with Cutch is very similar to that for the dyeing of cotton, except that boiling solutions are used. Cutch may also be used on wool in conjunction with such dyes as Barwood and Camwood. By first mordanting with chrome or other metallic salt (bluestone or copperas), lighter shades are obtained than when the sadden-

ing method is used. The colors obtained with chrome are fairly fast to light and milling, and by the addition of a little bluestone to the Cutch bath these properties are increased.

In silk dyeing cutch is used for two purposes. One is for the dyeing of silk plush an imitation of sealskin; in which case the silk is dyed in a similar manner to cotton. The second is the use of Cutch in black dyeing, when the method is to first mordant the silk with nitrate of iron, and dye with Prussian Blue, after which the silk is worked in a strong decoction of Cutch, or better, gambier, to which may be added a small amount of tin crystals. The silk absorbs a large percentage of catechin, and is then mordanted with pyrolignite or nitrate of iron and dyed in the usual manner. This method is used in the production of the so-called "Lyons" black, where it is desired to weight the silk about 10 per cent.

7. Cochineal.—This coloring matter is derived from an animal source. It consists of the bodies of the female insects known as *Coccus cacti*; they are found in Mexico and Central America and other tropical and subtropical countries, and grow on certain kinds of cactus. At the proper time the insects are collected and killed by being steamed or dried in hot stoves; the former gives the *black cochineal* and the latter the *silver cochineal*.

The coloring principle of Cochineal is *carminic acid*. The aqueous solution of Cochineal yields the following reactions:

Acids: Yellowish color.

Alkalies: Violet color.

Lime water: Violet precipitate.

Alum: Slowly forms red precipitate.

Aluminium chloride: Reddish violet precipitate.

Stannous chloride: Violet precipitate.

Stannic chloride: Bright scarlet color.

Ferrous sulphate: Violet gray precipitate.

Copper sulphate: Violet precipitate.

Lead acetate: Violet precipitate.

Zinc sulphate: Violet precipitate.

Oxalic acid: Red precipitate.

Cochineal was formerly very extensively employed for the production of bright scarlets and reds on wool; it is still used to some extent for this purpose, but has been largely replaced by the acid scarlets. The scarlet cloth for the English army, however, is still dyed with Cochineal. In cotton dyeing Cochineal has no application, though small quantities are used in printing. Cochineal gives the following colors with the different mordants:

Chromium: Purple.

Aluminium: Crimson.

Iron: Purple.

Copper: Claret.

Tin: Scarlet.

The principal colors are the crimson with alum and the scarlet with tin. Cochineal scarlet is faster to light than the acid scarlets; it is also quite fast to washing and fulling, but becomes a little bluer, though it does not bleed. The solution of the coloring matter for dyeing is best prepared by boiling the powdered cochineal insects in water and straining the solution.

Ammoniacal Cochineal is a preparation obtained by steeping ground Cochineal in ammonia water for several days, three parts of ammonia being used for one part of Cochineal. A chemical reaction takes place resulting in the formation of a carminamide from the carminic acid. The mixture is then heated to drive off the excess of ammonia, and hydrated aluminium

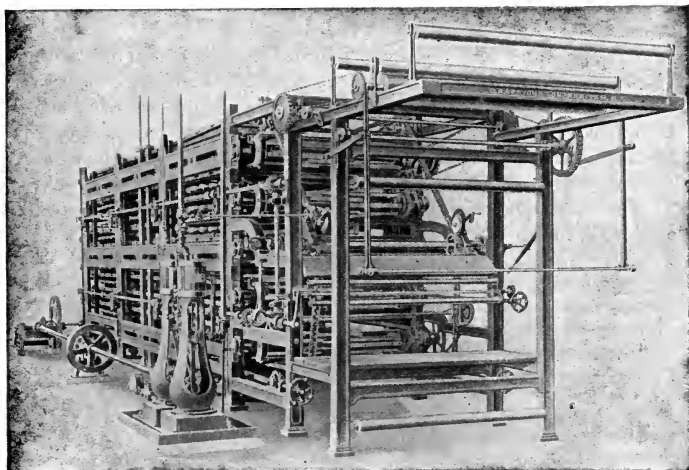

FIG. 255.—Tentering and Drying Machine for Finishing Cloth. (D. R. Kenyon & Son.)

oxide is added, and the heating continued until all of the ammonia is removed; then the mass is pressed into cakes. It is used for dyeing purple and crimson, and for rose reds in connection with ordinary Cochineal. Its color is not as readily affected by acids as that of the other Cochineal. It also gives a fine purple precipitate with oxychloride of tin.

A good quality of Cochineal should not give more than 1 per cent of ash on ignition. It is frequently adulterated with half-exhausted Cochineal which is made to resemble white or silver Cochineal by drying and agitating with barium sulphate, white lead, etc. Black Cochineal is also adulterated with black iron, sand, graphite, and black oxide of manganese. These mineral adulterants are easily detected by powdering the sample and

treating with water, when the mineral matters will in most cases fall to the bottom. Occasionally, adulteration is practiced by adding extract of Brazil-wood. This may be detected by treating the sample with water, adding an excess of lime water, which completely precipitates the coloring matters of the Cochineal, while if Brazil-wood is present the filtered liquid will have a purple or violet color. The value of different samples of Cochineal is best estimated by dissolving a given weight of the powdered samples in water and observing the amount of standard alum solution necessary to precipitate the coloring matters completely. A more accurate method, perhaps, is to conduct a series of comparative dye-tests, using test skeins of woolen yarn previously mordanted with tin or alumina.

Cochineal carmine or **carmine lake** is a brilliant red pigment produced by precipitating a decoction of Cochineal with alumina. Its manufacture, however, is still maintained as a trade secret. It contains a large amount of alumina and lime, combined with a certain amount of nitrogenous matter, which seems to be essential to its formation. It is chiefly used by paper stainers and calico printers. Cochineal carmine is liable to be adulterated with starch, china clay, vermilion, and various pigment colors. These additions may be detected by treating the sample with dilute ammonia water, which will readily and completely dissolve pure samples, while if any of the above-named substances are present they will be left as insoluble matters. The ash should be under 10 per cent and the water should not be over 20 per cent. The ash should be examined for tin, which, if present, in any considerable amount indicates the presence of Biebrich Scarlet lake, which closely resembles Cochineal carmine in many of its properties, and is somewhat difficult to detect in small quantities.

Besides the usual two-bath process of dyeing Cochineal a one-bath method may also be used, as follows: The dyebath is prepared with 6 per cent of oxalic acid, 6 per cent of stannous chloride, and 20 per cent of Cochineal. The oxalic acid should be added before the tin crystals, otherwise a precipitate of stannous oxychloride will occur which will cause loss of coloring matter. A deficiency of tin causes the color to be dull and bluer, while an excess of tin gives a paler scarlet. The one-bath method gives yellower and more brilliant shades than the two-bath process, though more Cochineal is required. The presence of iron or copper in the dyevat should be avoided, otherwise the scarlet will be much dulled. To obviate this defect arising from the use of copper steam-pipes in the dyevat a piece of clean tin should be placed in the bath; this prevents the copper from being dissolved. For the production of very yellow tones of scarlet it is necessary to use some suitable yellow dyestuff in connection with Cochineal. Flavine was generally employed for the purpose.

8. Weld.—This dyestuff is obtained by drying a small herbaceous herb of a variety of mignonette, the botanical name of which is *Reseda*

luteola. This plant is indigenous to Europe. Its coloring principle is known as *luteolin*, $C_{20}H_{14}O_8$, and may be obtained as small yellow needles of a bitter astringent taste. It was formerly employed in the dyeing of wool and silk in yellow shades, but is not used to any extent at present.

9. Persian Berries.—This dyestuff is also known as yellow berries, and consists of the fruit of the buckthorn and other species of *Rhamnus*, the principal and true varieties being *Rhamnus amygdaline*, *R. oleoides*, and *R. saxatilis*. The fruit is usually gathered when not quite ripe and on drying gives small berries of a peculiar shriveled appearance. The best varieties come from Smyrna and Alleppo. The color principle existing in the berries is a glucoside known as *xanthorhamnin*, $C_{48}H_{66}O_{29}$. Persian Berries are chiefly used in calico printing for the production of steam yellow and orange colors.* Persian Berries as they occur in trade are shriveled in appearance and of a yellowish green color. If too yellow they are of an inferior quality, while if brown or black, they are valueless, being either overripe or injured by dampness or long storage. The extract of Persian Berries is very liable to ferment and so deteriorate; when freshly prepared it is of a brownish yellow color.

10. Turmeric.—This dyestuff is the tuber or underground stem of the *Curcuma tinctoria*, and grows principally in China and the East Indies. The chief varieties on the market are the Chinese, Bengal, Java, and Cochin. The coloring principle is known as *curcumin*.† It was used as a direct dye on cotton, wool, and silk, but may also be dyed in conjunction with metallic mordants.‡ In preparing Turmeric, the roots are dried and ground, giving a bright orange powder. It is sometimes adulterated with starch and mineral matters. Good qualities of the roots should be of a dull waxy appearance, the external color being a yellowish gray, while on fracturing, the internal color should be bright and more orange. The ash of

* At the present time Persian Berries are principally used in the form of extracts. On a copper mordant they give olive shades that are exceedingly fast to light. With different metallic mordants they yield the following colors:

Chromium.....	brown
Aluminium.....	bright yellow
Iron.....	dark olive
Copper.....	yellow-olive
Tin.....	orange

† The coloring matter may be isolated by first extracting the ground root with carbon disulphide (to remove volatile oils and resins), and treating the residue with dilute caustic soda. The solution so obtained is acidulated with hydrochloric acid when the dye is precipitated in the form of yellow flakes. It may be further purified by recrystallization from ether.

‡ In dyeing Turmeric, a little alum or acetic acid should be used, as if the dyebath is at all alkaline the fiber will not take up the color. It is also important that the temperature should not be over 140° F.

Turmeric should not be more than 5 to 6 per cent and should be examined for common salt, which is often added to give the powder a brighter appearance. The best method of valuing Turmeric is to make comparative dye-tests on unmordanted woolen skeins. The dyeings should be done at fairly low temperatures as the color becomes dulled if the temperature of dyeing is too high.*

11. Kermes.—This is the product of a female insect *Coccus ilicis*, which lives on a shrub *Quercus coccifera*, that grows in tropical climates. Good qualities have a rich deep-red color, and are in grains about the size of a pea. It was employed for the same purposes as Cochineal, but is very little used at present. †

12. Lac Dye.—This is the product of a small insect, *Coccus lacca*, which lives on the twigs of the banyan (*Ficus religiosa*) and other trees of the genus *Ficus*, which grow principally in Bengal and British Burma. The coloring principle is *laccainic acid*, $C_{16}H_{12}O_8$. It was formerly employed for the dyeing of scarlet and crimson colors on wool. ‡ The stick-lac of trade simply consists of the twigs of the banyan tree which have been coated to the depth of about $\frac{1}{4}$ in. by propagation of the insect, which are then collected, dried and ground. Such a powder contains about 10 per cent of coloring matter and about 70 per cent of resin. The stick-lac is treated with water containing a little alkali, which dissolves out the coloring matter, which is then precipitated from its solution by the addition of alum, and the precipitate is collected and dried. The residue left after treatment with water is known as seed-lac, which if melted and filtered gives the shell-lac of trade. A good quality of Lac dye should be soft enough to be broken easily, and should also powder readily. The lumps should be homogeneous and free from resinous matter. Samples that are hard and have a resinous appearance are usually of a low and inferior

* Turmeric is extensively used in chemical analysis as an indicator for boric acid, as it gives with this acid a very characteristic reaction. Turmeric paper is filter paper stained with a solution of Turmeric. If this be moistened with boric acid and dried it shows a brownish red color, and on the addition of a drop of caustic soda it turns blue or green.

† In the Mediterranean countries Kermes is still used to some considerable extent for the dyeing of leather and woollens. It is also used by the natives for dyeing the manes and tails of horses. Kermes is a very ancient dye, having been used in the East as far back as history goes. The coloring principle of Kermes is carminic acid, apparently identical with that of Cochineal. Owing to the fact that Kermes was formerly supposed to consist of grains, dyeings with Kermes were known as "grain" or "ingrain" colors, and this name passed on to those colors obtained with Cochineal, and later to the red color obtained with Primuline.

‡ This dye is a by-product in the manufacture of shellac, and is still available in considerable quantity. It is still used extensively in India and Persia for the dyeing of bright reds and scarlets on wool. It is used very much in the same manner as Cochineal. It gives colors that are somewhat faster than Cochineal but not so bright.

quality. The amount of water in Lac dye should be about 10 per cent and the ash about 15 per cent.

13. Experimental. Exp. 188. Use of Fustic.—Mordant a test skein of woolen yarn with 3 per cent of chrome and 4 per cent of tartar in the usual manner. Dye for forty-five minutes in a bath containing 10 per cent of Fustic extract, entering at 140° F. and gradually raising to the boil. Wash well and dry. Mordant a second skein with 5 per cent of stannous chloride and 5 per cent of oxalic acid, and dye in the same manner as above with 10 per cent of Fustic extract. Mordant a third skein with 6 per cent of ferrous sulphate and 8 per cent of tartar, and dye as before with 10 per cent of Fustic extract. Note the difference in color obtained from the Fustic by the use of different

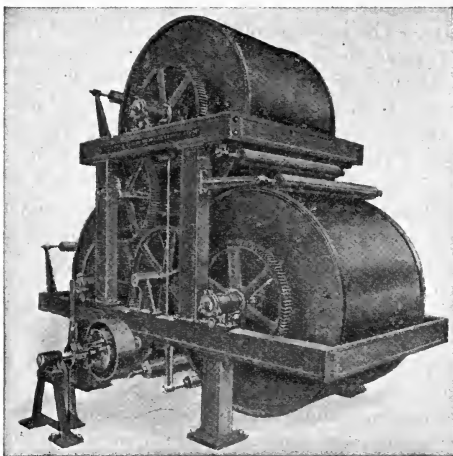

Fig. 256.—Three-Cylinder Back Drying Machine. (Textile-Finishing Machinery Co.)

mordants. Test the fastness of the color to washing and light, and compare the results with those given by Alizarine Yellow. Mordant a fourth skein with chrome and tartar as above, and a fifth skein with tin and oxalic acid; then dye with 10 per cent of Aurantine powder (Osage Orange). Compare these dyeings with those obtained with Fustic.

Exp. 189. Use of Madder.—This dyestuff was formerly very extensively employed but has now been replaced almost entirely by the synthetically prepared Alizarine, which is the coloring principle of Madder. Madder consists of the ground root of *Rubia tinctorum*, and is applied as a mordant dyestuff. Mordant a test skein of woolen yarn with 3 per cent of chrome and 4 per cent of tartar, and dye for forty-five minutes in a bath prepared by boiling 25 per cent of Madder in water and straining. Also add 4 per cent of calcium acetate to the dyebath. This mordant yields a reddish brown color with Madder. In a similar manner dye a test skein which has been mordanted with 10 per cent of aluminium sulphate and 8 per cent of tartar. This mordant yields a dull

red color. Dye a third test skein mordanted with 5 per cent of stannous chloride and 5 per cent of oxalic acid and notice that an orange-red color is obtained.

Madder may be dyed in a single bath as follows: Prepare a bath containing 5 per cent alum, 4 per cent tartar, 10 per cent Madder, and 4 per cent calcium acetate; enter cold and slowly bring to the boil, dyeing at this temperature for one hour. This is used only for light shades, as otherwise there would be considerable precipitation in the dyebath.

Exp. 190. Use of Archil.—This dye, together with the related coloring matter Cudbear, is but little used at present. It possesses the character of a substantive dye towards wool and yields a dull magenta shade. It can be applied in a neutral bath, though the addition of acid makes the color redder and brighter. The color is not fast to light or fulling, and only fairly so to washing. Dye a test skein of woolen yarn in a neutral bath containing 20 per cent of Archil paste, entering at 120° F. and raising to the boil for forty-five minutes. Dye a second skein in a bath containing 20 per cent of Archil paste and 4 per cent of sulphuric acid. Notice the difference in the color caused by the use of the acid in the dyebath. Archil at the present time is not used as a self color, but in combination with various acid dyes for the production of browns, maroons, and clarets; it is also employed as a bottom for Indigo. It is not used for the dyeing of cotton. Silk may be dyed with Archil in a soap bath, with or without the addition of acetic acid.

Exp. 191. Use of Quercitron.—This is a yellow coloring matter obtained from the bark of a species of oak. Quercitron itself consists of the ground bark, while *Flavine* is the pure dry extract of the coloring matter. Mordant a test skein of woolen yarn with 3 per cent of chrome and 4 per cent of tartar in the usual manner, and then dye with 10 per cent of Quercitron bark, boiling for forty-five minutes. On this mordant Quercitron gives an olive-yellow color. Mordant another test skein with 4 per cent of stannous chloride and 2 per cent of oxalic acid; remove the skein from the mordanting bath, add 1 per cent of Flavine extract, boil up for five minutes, then re-enter the wool and continue boiling for forty-five minutes. This method of dyeing should yield a bright canary-yellow. By increasing the amount of Flavine the color becomes orange-yellow. Quercitron and its products are but little used for wool dyeing at present, though they are still employed to some extent in both cotton and wool printing. The color is not particularly fast to either light or scouring.

Exp. 192. Use of Cutch.—This brown dyestuff is also a tannin, and in this latter connection it has already been considered. As a dyestuff it was formerly very extensively used on cotton, and for the production of certain tones of brown it is still employed quite largely in cotton dyeing. It is not used for the dyeing of wool, as the fiber is made too harsh. In silk dyeing it is largely used, but only as a tannin in connection with Logwood black. Prepare a bath containing 15 per cent of Cutch and dye a test skein of cotton yarn for one hour at 195 to 210° F. Then squeeze the skein and treat for thirty minutes at 160° F. in a bath containing 5 per cent of chrome, and finally give a thorough washing. Darker shades of brown are obtained by the addition of bluestone to the dyebath as follows: Dye a test skein of cotton yarn in a bath containing 15 per cent of Cutch and 2 per cent of bluestone; squeeze and treat with chrome solution as above.

Exp. 193. Dyeing Wool with Cochineal.—The solution of the coloring matter is best prepared by boiling the cochineal bugs in water and straining the solution.

(a) Mordant a test skein of wool with 3 per cent chrome and 4 per cent tartar; wash, and dye with 20 per cent Cochineal.

(b) Mordant two test skeins of wool with 6 per cent of alum and 4 per cent tartar; wash, and dye with 20 per cent and 10 per cent respectively of Cochineal. The shade obtained is a crimson. A one-bath method may also be used: Dye a test skein of wool in a bath containing 6 per cent of alum, 5 per cent oxalic acid, and 20 per cent Cochineal. The crimson may be given a bluer shade by adding a little soda ash to the bath.

(c) Mordant two test skeins of wool with 6 per cent of stannous chloride and 6 per cent oxalic acid; wash, and dye respectively with 20 per cent and 10 per cent Cochineal. The process may also be carried out in one bath, which method in fact is the most used: Dye a test skein of wool in a bath containing 6 per cent stannous chloride, 6 per cent oxalic acid, and 20 per cent Cochineal. The oxalic acid should be added before the stannous chloride, otherwise a precipitate of stannous oxychloride will occur which will cause loss of coloring matter.

A deficiency of tin causes the color to be dull and bluer, while an excess of tin gives a paler scarlet. Instead of oxalic acid, tartar may be used as the assistant, an excess of tartar giving a yellower tone to the scarlet. As a rule, a small amount of yellow dye is used in order to intensify the scarlet. The one-bath method gives yellower and more

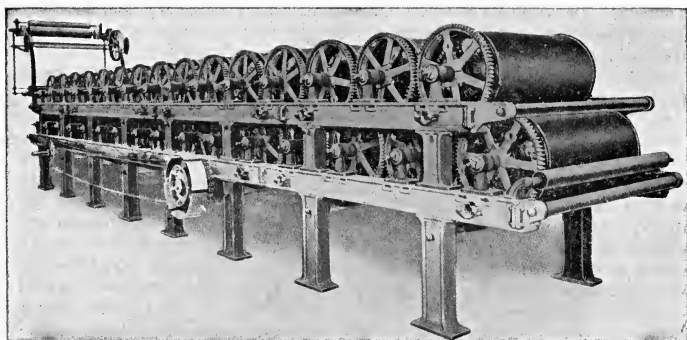

FIG. 257.—Thirty-one Cylinder Horizontal Dryer. (Textile-Finishing Machinery Co.)

brilliant shades than the two-bath process, though more Cochineal is required to give the same shades, as in the single-bath method some of the coloring matter remains in the dyebath in combination with the mordant. The presence of iron or copper in the vats should be avoided, otherwise the Cochineal scarlet will be much dulled.

(d) Dye a test skein of wool in a bath containing 5 per cent tin nitrate, 4 per cent tartar, and 20 per cent Ammoniacal Cochineal. The mordant here given is the one which works best with this form of Cochineal. Compare this color with the one obtained from ordinary Cochineal and tin mordant. A good rose pink may be obtained as follows: Dye a test skein of wool in a bath containing 2 per cent Ammoniacal Cochineal, 2 per cent Cochineal, 4 per cent tin nitrate, and 4 per cent tartar. The tin nitrate may be prepared by dissolving 1 part tin in 8 parts nitric acid.

CHAPTER XXII

THE MINERAL DYESTUFFS

1. General Use of Mineral Dyes.—There are a few mineral compounds which are capable of being used for the dyeing of textile fabrics. Though formerly of considerable importance, this class of colors is now nearly obsolete in dyeing. They differ very radically from the vegetable and coal-tar colors in that they are of mineral nature and are not organic bodies. As a rule, they are exceedingly fast to light, and are also very fast to washing. The general method of dyeing these colors is to impregnate the fiber with a solution of some metallic salt, and subsequently to treat it with a solution of another compound capable of yielding a colored precipitate with the metal already present. Lead salts, for instance, when added to potassium bichromate give a bright yellow precipitate of Chrome Yellow (lead chromate); if this precipitation is produced within the fiber itself, then the latter will become dyed with the Chrome Yellow.

Cotton is the fiber mostly used for the application of the mineral colors, the only color which is applied to wool being Prussian Blue. All the mineral dyes make the fabric more or less harsh and stiff; this may be remedied somewhat by after-soaping, or by using a cotton softener of oil, but it can never be removed entirely. Many of the mineral compounds used in the preparation of these colors are of a poisonous nature, which is a great drawback to their use; lead, copper, arsenic, mercury, and antimony compounds are all poisonous. As many of the metals forming the basis of these colors also serve as mordants with Alizarine and many acid dyes, the colors obtained with the metallic pigments may be shaded and modified by the use of suitable coal-tar dyestuffs. Loose cotton is seldom dyed with the mineral colors, as it then becomes difficult to card and spin. The mineral colors, though now but little used in actual dyeing, are still employed rather extensively in calico-printing.* In the latter they are

* The mineral pigment dyes are still used in the dyeing of window-shade cloth and awning cloth, the colors of which require great fastness to light. Khaki, which is obtained by dyeing with Iron Buff and Chrome Green, is largely used for tent and tarpaulin cloth for the army. It was formerly much in vogue for uniform cloth, but was abandoned as too harsh for comfort in wearing. During the recent war most of the khaki cotton uniform cloth was dyed with sulphur colors. The vat dyes are best and **fastest** for this purpose, but were not available during the war.

used in connection with albumin in the color pastes, and this on steaming becomes coagulated and rendered insoluble, and at the same time serves to fix the color on the cloth.

The mineral colors differ in the principle of their dyeing from that of the coal-tar dyes in that they are strictly of a pigment character. There is no combination between the coloring matter and the fiber itself; there is only a uniform precipitation of the finely divided insoluble pigment throughout the cells of the fiber, caused by the chemical double decomposition between the two soluble salts employed.* The metallic salt is absorbed by the fiber from its solution by osmosis into the cells of the latter; as the osmotic action is comparatively slow, in order that the final dyeing be thoroughly penetrated, it is advisable to allow the cotton to steep in the solution of the metallic salt for a considerable time, and before being entered in the bath the yarn or cloth should be thoroughly wetted out, else the fiber will not become completely impregnated with the salt. After thorough saturation the goods may even be rinsed in fresh water without fear of washing out the metallic salt held in the pores or cells of the fiber; in fact, a moderate rinsing may be considered beneficial, as it serves to remove the excess of solution adhering to the outside of the fibers and between the interstices of the fibers themselves, as this is not removed by a simple squeezing or wringing. This portion of the metallic salt solution not held osmotically by the fiber would come off to a certain extent in the succeeding bath wherein the pigment is formed, thus causing an unnecessary consumption of chemicals, and the contamination of the second bath with a precipitate. There would also be formed a loosely adherent precipitate of pigment in the interstices between the fibers, which would not prove fast to washing or rubbing, and in the case of yarn would also dust off in the handling thereof, besides adding considerably and unnecessarily to the harshness of the cotton. The action of the second or precipitating solution is also by osmosis. Taking the formation of Chrome Yellow as an example, the solution of potassium bichromate gradually passes by osmosis into the pores of the fiber, where it comes in contact with the lead acetate already present; the insoluble chromate of lead separates out, and thus is held securely in the pores of the fiber while the second member of the reaction, the potassium acetate, being a soluble salt, passes back into the bath again by osmosis.

* The so-called *pastel colors* on woolen piece-goods may be considered as a form of mineral dyestuff. These colors are generally dyed on bleached woolen pieces in the rinsing machine. For each piece about 6 to 9 lbs. of pure whitening are sifted into the washer containing a minimum quantity of water, the pieces are run a few times, then a dyestuff solution is added, and the pieces run for several times cold, and finally rinsed. For the production of pearl-gray shades zinc white may be used in place of whitening. The following dyestuffs are adapted to this method: Auramine, Orange II, Rhodamine, Acid Violet, Neptune Green.

Most of the mineral colors are very cheap in their application, but it is rather difficult to dye them to a matched shade. Their exceptional fastness to light and washing is their principal advantage.

2. Mineral Khaki on Cotton.—Khaki is a brown color with a greenish or drab tone which is used very largely on army cloth for various purposes. The color is supposed to approximate that of dry ground and so blend in with the country environment that the object thus colored has but slight visibility from the distance. The name is derived from an East Indian term meaning "dirt." Mineral khaki as dyed on cotton consists of a mixture of the oxides of iron and chromium in such proportion as to furnish the desired color. There are many different formulas in use for the production of this color; one which has proven very satisfactory is as follows: The cloth is first scoured and then treated with a solution standing at 36° Tw. and containing a mixture of the acetates of iron and chromium. The chromium acetate is prepared by the reduction of sodium bichromate with glucose and sulphuric acid in the presence of acetic acid. The solution is usually applied in a padding machine and hot so as to obtain good penetration. The cloth is dried over hot cans, and then steamed for four minutes in a rapid ager where the steam and air are at a temperature of 220° F. After steaming the goods are treated with a boiling solution standing at 12° Tw. and containing 1 part caustic soda and 3 parts of soda ash. When properly dyed mineral khaki is a very fast color, especially to light, washing, alkalis, and weather conditions; it is not fast to acids, which dissolve off the iron oxide.

3. The Minor Pigment Colors.—There are a number of metallic pigment colors which may be produced in the fiber besides the ones which have been mentioned in the foregoing pages. They are, however, of only theoretical value and possess no practical importance to the dyer. A brown color may be dyed on wool by working it in a bath containing lead acetate and lime; the sulphur present in the wool combines to form lead sulphide. A gray color on cotton may be produced by working the latter in a bath containing mercury nitrate, squeezing, and passing through a bath containing sodium sulphide. Cotton may be dyed with red oxide of lead by steeping in a bath of lead acetate and then passing through a bath containing a mixture of caustic soda and chloride of lime. A blue color on

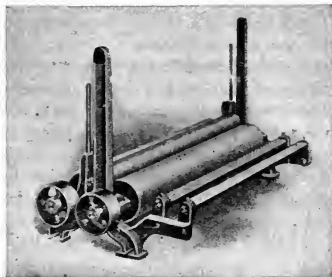
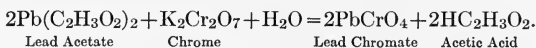

FIG. 258.—Rolling Machine.
(Curtis & Marble.)

cotton may be obtained by working in a bath containing ammonium molybdate and developing in a bath containing stannous chloride and hydrochloric acid. A yellow color on cotton or wool may be obtained by the use of titanium salts (see the application of these salts in mordanting). Cadmium Yellow may be precipitated in cotton by first steeping in a solution of cadmium nitrate or chloride and passing through a bath containing sodium sulphide. Scheele's Green may be dyed by first steeping the material in a solution of copper sulphate, then passing through a bath of caustic soda, whereby copper hydrate is formed, and finally treating with a solution of arsenious acid, resulting in the formation of green copper arsenite. Another green may be made in the fiber by steeping in a solution of chrome alum, passing through a bath of caustic soda and finally through a bath of sodium arsenite. Both of these green colors are very poisonous.

4. Experimental. Exp. 194. Chrome Yellow on Cotton.—Steep a test skein of cotton yarn for thirty minutes in a cold bath consisting of a 5 per cent solution (5 grams per 100 cc.) of lead acetate. Squeeze evenly, and pass into a second bath consisting of a 1 per cent solution (1 gram per 100 cc.) of chrome; work cold for thirty minutes. Squeeze and wash in fresh water, then soften by working in a dilute solution of a cotton softener or glycerin and soap. Finally squeeze and dry. In order to obtain heavier colors the alternate passages through the baths of lead acetate and chrome may be repeated several times. In place of using the ordinary acetate of lead (sugar of lead) the subacetate is preferred by some. This is prepared by boiling together 10 parts of lead acetate and 6 parts of litharge (lead oxide) with 40 parts of water; filter, and use the liquor so obtained, diluting in accordance with the depth of color desired.*

Chrome Yellow is formed in accordance with the following reactions:



Chrome Yellow may be applied to wool, silk, or any other fiber in the same manner as above described for cotton, but it is seldom if ever used on these fibers. In the dyeing of Chrome Yellow it is necessary to first apply the lead salt and then the chrome; if the reverse procedure is followed the pigment will be precipitated on the outside of the fibers in a loosely adherent

* The following method has been recommended for dyeing Chrome Yellow in practice: Prepare a stock liquor by boiling 100 lbs. of brown sugar of lead and 50 lbs. of litharge with 18 gallons of water, and allow to settle; the liquor should stand at 125° Tw. Give the yarn a passage through lime water (1½° Tw.), wring and then work in lead salt bath prepared by diluting the stock liquor with cold water to 10° Tw.; wring, and pass through lime water (1½° Tw.) again. The lead bath may be used continuously, being freshened up by additions of the stock liquor. Next prepare a chrome bath containing 6 lbs. of sodium bichromate per 100 gallons. Pass the yarn through the chrome bath, and then rinse by giving a few turns in water containing 1 part of hydrochloric acid to 300 parts of water. Finally wash well and dry. The chrome bath may also be used continuously, being freshened up from time to time with additions of chrome solution. Some recommend the addition of 12 ozs. of zinc sulphate to the chrome bath in order to improve the quality of the color.

condition, and will not be fast to washing. In dyeing heavy shades, in order to get the most even results and the fastest color, it is best not to use more concentrated solutions but to give the cotton several dips successively in the two solutions until the desired depth of shade is obtained.* To obtain the purest shades of yellow, it is best to have the chrome bath slightly acid, for if the latter becomes at all alkaline the resulting pigment will acquire an orange tone. On this account it is better to employ the bichromate of potash rather than the neutral chromate. Chrome Yellow, though extremely fast to light, washing, and acid, is quite sensitive to the action of sulphuretted hydrogen, turning dark, owing to the formation of black lead sulphide. As the air of cities, especially in the vicinity of factories, and the air of houses heated by burning coal, always contains more or less sulphuretted hydrogen, this accounts for the gradual darkening of Chrome Yellow on exposure. This discoloration can be prevented to a considerable extent by incorporating with the lead salt a salt of zinc or cadmium, the sulphide of the former being white and that of the latter yellow in color.

Exp. 195.—In order to show this action, add to the bath of lead acetate used in the above experiment 1 per cent of cadmium nitrate; then dye a second skein of cotton in the same manner as the previous one. Take small samples of the two skeins and place them in a bottle, the air of which contains a minute quantity of sulphuretted hydrogen. After some time it will be found that the first sample, dyed with the lead salt alone, has become perceptibly darkened, whereas the second sample, containing the addition of cadmium salt, is not altered. Though unaffected by acids, Chrome Yellow is changed to an orange by the action of alkalies; even lime water will serve this purpose. The orange color is due to the formation of a basic compound of lead chromate. To illustrate this action, take a small sample from the skein dyed with Chrome Yellow and boil it in a weak solution of soda ash; then wash and dry. It will be found to have changed to an orange color. Treatment with acid will in turn destroy the orange tone and restore the original yellow color; this may be shown by steeping the sample above tested in a dilute solution of sulphuric acid, when the color of the original Chrome Yellow will again be formed.

By the action of strong caustic alkalies, Chrome Yellow may be completely discharged or dissolved from the fiber, as may be shown by taking a small sample from the skein dyed with this color and boiling it in a solution of caustic soda, when it will be found to become rapidly decolorized. This reaction is very useful in printing, as by its means discharge effects may be obtained.

Exp. 196. Chrome Orange on Cotton.—As already indicated in the previous experiment, this color may be obtained by forming the basic chromate of lead in the fiber

* Yarn dyed with Chrome Yellow is quite heavily weighted, the increase in weight sometimes amounting to as much as 40 per cent, and sometimes this is of advantage. There are limitations on the use of Chrome Yellow, however, on account of its poisonous character, the dust from materials dyed with it being injurious to the health of the workmen.

by the use of lead chromate and an alkali. Proceed as follows: Work a test skein of cotton yarn for thirty minutes in a cold bath consisting of a 5 per cent solution of lead acetate; squeeze, and pass into a second bath consisting of a 1 per cent solution of chrome and a small quantity of caustic soda. Enter cold and gradually raise to the boil for a few minutes. Wash in a warm dilute soap bath.

A modification of the above method is to use the basic acetate of lead prepared in the manner prescribed in the previous experiment from lead acetate and litharge.

The Chrome Orange obtained as above indicated may be brightened somewhat by working in a boiling bath containing lime. Dye a second skein of cotton in a manner similar to the first, repeating the treatment in the two baths three times. Squeeze and wash, then work for fifteen minutes at the boil in a bath containing 10 per cent of lime (quicklime). Finally wash and soap as before.

By a stronger or weaker treatment with alkali, Chrome Orange may be made to vary in shade from a bright yellowish orange to a scarlet-red

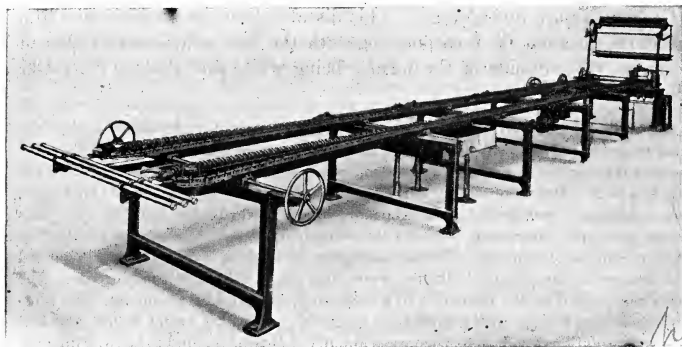
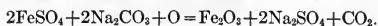

FIG. 259.—Automatic Clip Tenter. (Textile-Finishing Machinery Co.)

The remarks made under Chrome Yellow as to its fastness and reactions with various agents are also applicable to Chrome Orange.

Both Chrome Yellow and Chrome Orange are poisonous substances, and may give rise to cases of poisoning among operatives handling cotton dyed in this manner, or even to wearers of such fabrics. These dye may be tested for on the fiber by boiling a sample in caustic soda solution and then adding a few drops of ammonium sulphide solution, when a black precipitate of lead sulphide will be formed.

Exp. 197. Iron Buff on Cotton.—This color is produced by precipitating a hydrated oxide of iron ($\text{Fe}_2\text{O}_3 \cdot \text{H}_2\text{O}$) in the fiber. Proceed as follows: Work a test skein of cotton yarn for thirty minutes in a cold bath consisting of a 5 per cent solution of copperas (ferrous sulphate, FeSO_4). Squeeze, and pass into a bath containing 5 per cent on the weight of the cotton of soda ash; work for fifteen minutes at 180°F . Wash and pass through a warm dilute soap bath. The reaction takes place as follows:



The oxidation of the iron from the ferrous to the ferric condition is effected by the atmospheric oxygen. By repeating the treatment with the two baths several times heavier shades of brown may be obtained. Instead of using copperas a solution of "nitrate of iron" (basic ferric sulphate) may be substituted, or a solution of ferric chloride. Another method of procedure is as follows: Work a skein of cotton as above in the same bath of copperas; squeeze, and pass through a cold weak solution of chloride of lime containing a little caustic soda for ten minutes. Squeeze, and repeat the passage through the two baths twice. This should give quite a heavy shade of brown. Wash well, and soap as before. The chloride of lime oxidizes the ferrous salt very rapidly to the ferric condition; it also forms a certain amount of oxycellulose with the cotton which takes up the iron compound more energetically than the unmodified cotton. Another method of producing Iron Buff on cotton is to impregnate the material with the solution of the iron salt as before, then to pass it through a bath containing milk-of-lime, after which it is squeezed and exposed to the air overnight. This latter operation is termed "ageing."

The light brown shade obtained with iron oxide is also known as *nanking* and *chamois*. The brown color of the natural Nanking cotton is said to be due to its containing oxide of iron though this view is subject to some doubt. Iron Buff on cotton is exceedingly fast to light, washing, and alkalis, and also to exposure; it is decolorized, however, with acids, which may be shown by steeping a small sample of the dyed skein in a warm dilute solution of hydrochloric acid. In calico printing Iron Buff may be discharged white with citric acid or with a solution of stannous chloride in hydrochloric acid.

As iron oxide forms a good mordant with the Alizarine and natural dyestuffs, Iron Buff on cotton may be topped off with these dyestuffs and quite an extensive variety of shades produced thereby.

Exp. 198. In order to illustrate this procedure, dye three skeins of cotton a light shade of Iron Buff in the manner above indicated. Top off the first one in a bath containing 2 per cent Alizarine Red, the second one with 2 per cent Alizarine Blue, and the third one with 5 per cent Fustic extract (solid). Enter at a low temperature and gradually raise to the boil. Wash and soap in the manner before described.

Exp. 199. Iron Gray on Cotton.—This color is obtained by precipitating tannate of iron within the fiber. Proceed as follows: Work a skein of cotton for thirty minutes in a cold bath of nitrate of iron at 2° Tw.; squeeze, and pass into a bath containing 5 per cent of tannic acid; work cold for fifteen minutes. Wash and soap in the usual manner. Deeper shades of gray and slate may be obtained by repeating the treatment several times. The operations may also be reversed and the treatment with the tannic acid may take place first, as in the usual manner of mordanting cotton for the purpose of dyeing heavy colors with the basic dyes. Besides tannic acid itself the various natural tannins may be employed, such as sumac, cutch, chestnut extract, etc., in which cases the resulting color will be modified by the addition of the natural color of the tannin. By using rather concentrated baths and repeating the operations several times, cotton may be dyed black by this method. In fact, before the introduction of Logwood, this was the chief method for the dyeing of black on cotton.

Iron Gray on cotton is quite fast to light and washing; on long exposure it turns rusty, owing to the gradual formation of iron oxide; it also turns

brown on treatment with alkalis for the same reason. Like Iron Buff it is also decolorized by the action of acids.

Exp. 200. Manganese Brown on Cotton.—This color is also known as "Bistre," and is formed by precipitating an oxide of manganese in the fiber. Proceed as follows: Work a skein of cotton for thirty minutes in a cold bath consisting of a 5 per cent solution of manganese chloride; squeeze and pass into a cold bath containing 10 per cent of caustic soda; work for fifteen minutes; wash in fresh water, and then pass into a dilute bath of chloride of lime (about 1° Tw.); finally wash well and soap in the usual manner.

In the treatment with caustic soda there is precipitated in the fiber a hydrate of manganese; a dilute bath of soda ash may also be used for the same purpose. The final treatment with chloride of lime is for the purpose of oxidizing the compound to the higher oxide of manganese. The resulting compound is probably Mn_2O_3 and consists of a mixture of manganese dioxide, MnO_2 , and manganous oxide, MnO . Bistre was formerly a very important color for cotton and extensively used both in dyeing and printing. It is very fast to light, washing, and alkalis; it is also fast to dilute acids but strong acids decolorize it, as also do reducing agents.

Bistre may also be dyed on cotton by passing the material saturated with the solution of manganese chloride into a bath containing a mixture of caustic soda and chloride of lime, an operation which then dispenses with the use of a third bath. The use of soda ash in place of the caustic soda cannot be recommended, as the precipitate produced contains manganese carbonate, which is not as readily oxidized as the hydrate. The final dyeing is also apt to come out rather uneven.

Exp. 201.—Bistre can also be produced on cotton by the use of potassium permanganate, as may be shown in the following manner: Work a skein of cotton for fifteen minutes in a cold bath containing 2 per cent of potassium permanganate. The cotton will be found to turn brown rapidly on exposure to the air; squeeze, wash, and soap in the usual manner.

Manganese Brown is decolorized by treatment with either hydrogen peroxide or sulphurous acid; wherein it differs from the brown obtained from iron oxide. In order to show this behavior, take a small sample each of Iron Buff and Bistre and steep them for several hours in a solution of hydrogen peroxide; also steep two similar samples in an acidified solution of sodium bisulphite. It will be found that the samples of Bistre are more or less completely decolorized, while the samples of Iron Buff are not much altered.

Bistre may be employed as the basis for the production of Aniline Black on cotton, proceeding as follows: Take a skein of cotton dyed a full shade of brown with Bistre in the manner above described, and work it in a cold bath containing 10 per cent of aniline salt; then gradually bring to the boil. Squeeze, wash thoroughly, and soap in the usual manner. This black is very fast to washing. By using paraphenylene-diamine or beta-naphthylamine, a very good shade of brown may be obtained which does not differ much in color from the original Bistre, but it is fast to acids. With alpha-naphthylamine a plum color is produced.

Cotton cloth dyed with Bistre has the property when subsequently dyed in the Indigo vat of taking up a greater amount of Indigo and fixing

it faster to washing than ordinary cotton. Bistre is sometimes used in dyeing of mohair plush in order to give a fabric in imitation of a natural fur pelt, the cotton back being dyed with Cutch brown in the yarn, while the mohair pile is woven from undyed yarn. The plush is then treated with a solution of potassium permanganate, which rapidly dyes the mohair brown and also colors the cotton back a fuller shade. As soon as the desired shade is obtained the material is washed and dried. Then by the use of rotating brushes a suitably thickened solution of sodium bisulphide is applied to the ends of the mohair pile, which causes the brown color to become discharged, and thereby imitate more closely the appearance of the natural pelt.

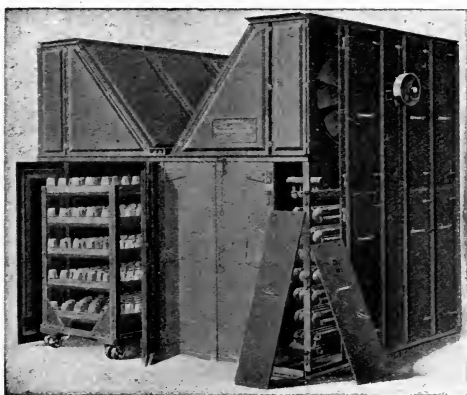

FIG. 260.—Dryer for Dyed Cones. (Philadelphia Drying Machine Co.)

Exp. 202.—In order to show the use of Bistre on woolen material, take a skein of wool and pass it through a cold bath containing 2 per cent of potassium permanganate; work for fifteen minutes; then squeeze and wash well.

According to certain chemists, the irregularity which sometimes arises in dyeing Manganese Brown is due to the physical condition of the precipitate itself. In order to overcome such defects, it has been recommended, after impregnating the cotton with the manganese salt, to pass it through a bath containing ammonia and potassium bichromate, whereby a rather unstable manganese chromate is precipitated in the fiber; this gradually decomposes, and the chromic acid liberated reacts with manganous hydrate, forming the higher oxide of manganese. The oxidation is completed by passing the cotton through a dilute bath of bleaching powder.

Exp. 203. Chrome Green on Cotton.—A pale dull shade of green can be obtained on cotton by precipitating on the fiber oxide of chromium, Cr_2O_3 . Proceed as follows:

Work a test skein of cotton for thirty minutes in a cold bath consisting of a 10 per cent solution of chrome alum; squeeze, and pass into a bath containing 10 per cent of soda ash; enter cold and gradually bring to the boil. Wash well and soap in the usual manner. By repeating the operations several times fuller shades may be obtained.*

Chromium oxide gives a sea-green color on cotton which is exceedingly fast to light, washing, and alkalis; it is also fast to exposure, but is decolorized by the action of acids. The color of Chrome Green may be brightened somewhat by passing the dyed cotton through a bath of dilute copper sulphate (the bath should be very dilute and warm). Chrome Green is seldom used at the present time as a self color on cotton, but it has had extensive use in conjunction with Iron Buff for the production of the so-called *khaki* color with which the heavy cotton goods of the army are dyed.

Exp. 204.—In order to obtain this khaki color proceed as follows: Work a test skein of cotton in a cold bath consisting of a 5 per cent solution of ferric chloride with a 5 per cent solution of chrome alum, then pass into a bath containing 10 per cent of soda ash; enter cold and gradually bring to the boil. Wash well, and soap as usual. By varying the relative amounts of iron and chromium salts, or by the addition of a small amount of manganese salt, the shade of this khaki color may be varied in order to obtain any tone desired.

Exp. 205. Prussian Blue on Cotton.—The production of this color depends on the precipitation of a ferrocyanide of iron within the fiber. On cotton it is dyed as follows: Work a test skein of cotton in a boiling bath of nitrate of iron (32° Tw.) also containing 5 per cent of stannous chloride; steep for thirty minutes, squeeze, and pass into a bath containing 10 per cent of potassium ferrocyanide (yellow prussiate of potash); work warm for fifteen minutes; then pass back into the bath of nitrate of iron again; finally squeeze, wash, and soften in a soap bath.

Heavier shades may be obtained by repeating these operations several times; the cotton, however, should always be worked last in the bath of nitrate of iron in order to prevent the formation of a soluble variety of Prussian Blue.

Exp. 206. Prussian Blue on Wool.—For dyeing wool proceed as follows: Work a test skein of wool in a bath containing 10 per cent of potassium ferricyanide (red prussiate of potash), 20 per cent of sulphuric acid, and 1 per cent of stannous chloride; enter cold and gradually raise to the boil, when the wool will turn green and finally become blue. After boiling for ten minutes, lift, and add 1 per cent more of stannous chloride, and work for fifteen minutes longer. Finally wash well in fresh water. The depth of shade may be varied by employing greater or less amounts of potassium ferricyanide. If the blue color does not develop properly a few drops of nitric acid may be added to the bath for the purpose of accelerating the oxidation. Another method of dyeing this

* A color known as Chrome Green is sometimes dyed on cotton by topping a light shade of Indigo Blue with a Chrome Yellow. It is a color, however, which has not much use at the present time except for window-shade material and awning cloth. A Chrome Green can also be obtained by precipitating chromium hydrate or oxide in the fiber but this only gives a light shade of sea-green. Before the discovery of the coal-tar green dyes, it was customary to use chromium arsenite as produced on the fiber by the interaction of chrome and arsenite of soda. This gave a rather rich and fast shade of green, but it was very poisonous and at the present time is not used at all. Wall-paper was frequently dyed green in this manner (or printed) and many cases of arsenical poison were traced to this pigment. Its use for this purpose is now forbidden.

color on wool is to use 15 to 20 per cent of potassium ferrocyanide with the addition of a small amount of alum and tartar to the bath.

Prussian Blue also goes by the name of Berlin Blue; it was formerly a very important color, both for cotton and wool, and is even still used to a considerable extent, especially in printing. Before the introduction of Alizarine Blue it was extensively employed for the dyeing of army uniforms. Prussian Blue appears to be a complicated cyanogen compound of iron, the exact tone of which varies considerably with the manner of its production. Though not now employed as a self color in dyeing of silk, Prussian Blue, however, is still used as a bottom color in the dyeing of weighted black on this fiber.

Prussian Blue is fast to light, washing, and exposure; it is also fast to dilute acids, but is dissolved by stronger acids, also by a concentrated solution of oxalic acid. With caustic alkali it is decomposed into potassium ferrocyanide and brown oxide of iron. This latter reaction is still used for discharge work in printing. The action of stannous chloride in the dyeing of Prussian Blue is to brighten and give a reddish tone to the shade, probably due to the formation of a tin ferrocyanide.

Exp. 207.—A bright green color on cotton may be produced by the combined and simultaneous use of Prussian Blue and Chrome Yellow in the following manner: Work a test skein of cotton in a cold bath containing 10 per cent of ferrous acetate and 10 per cent of lead acetate for thirty minutes; squeeze, and pass into a bath containing 5 per cent of potassium ferrocyanide and 2 per cent of potassium bichromate. Squeeze, wash well, and soap as usual.

Boiling soap solutions decompose Prussian Blue, leaving the brown oxide of iron on the fiber. On prolonged exposure to sunlight, the color becomes somewhat lighter, but the original tone is restored on being kept in the dark for some time.

The theory of the application of Prussian Blue to wool is that when a mineral acid is added to a solution of potassium ferricyanide, the corresponding hydro-ferricyanic acid is liberated; this under the influence of heat and oxidation is decomposed with the precipitation of Prussian Blue. If nitric acid is employed in the bath, the shade of blue is somewhat greener than when the other mineral acids are used. Yellow prussiate of potash may be used instead of the red, in which case it was the custom of dyers to use a mixture of the three mineral acids, under the name of "royal blue spirits," or simply "blue spirits." Nitric acid is the best acid to employ in connection with potassium ferrocyanide on account of its oxidizing action. The stannous chloride was formerly used by the dyer in the form of a solution known as "muriate of tin" or "finishing blue spirits." The solution in this form often contained sulphuric and oxalic acids.

CHAPTER XX

DYEING OF FABRICS CONTAINING MIXED FIBERS

1. Character of Material.—There are a number of fabrics which are made up of mixed fibers; that is to say, instead of being composed entirely of wool or cotton or silk as the case may be, they contain two or more of these fibers together. Most frequently the warp is made of yarn from one kind of fiber while the filling is made of yarn of a different fiber, though in some cases the two fibers may be mixed in the same yarn. The most important of these materials may be grouped as follows:

(a) *Wool-cotton fabrics*, known as “union goods” or “half-wool” goods.

(b) *Wool-silk fabrics*, known chiefly as “gloria.”

(c) *Silk-cotton fabrics*, such as ribbons, satins, etc.

In place of cotton we may also have artificial silk or mercerized cotton or linen; in place of wool we may have mohair or other animal-hair fiber.

It is sometimes required to dye these goods in a solid color; that is to say, both classes of fibers are to be the same shade. In other cases two-color effects are desired; that is one fiber is dyed one color and the other fiber another color. As each kind of fiber reacts somewhat differently with the various dyes and the many chemicals employed by the dyer, and as different methods of application must be considered, depending on the nature and character of the material, it will be realized that the dyeing of goods of mixed fibers entails processes quite different from those used in the dyeing of fabrics where only one kind of fiber is concerned.

The use of mixed fabrics is on the increase, and they are being adapted to many classes of goods both for wearing apparel and for general fabric use. Consequently the application of dyes to mixed fibers has come to be a very important branch of dyeing, and the properties of the various dyes with reference to their use in this connection has been carefully studied.

2. Fabrics of Wool-cotton or Union Goods—Fabrics of wool-cotton materials are to be met in different stages of manufacture and while their treatment as far as dyestuffs is concerned is more often in the form of the woven fabric, yet there are instances where the material comes to the dyer in the form of yarn or even in a form intermediate to that of the spun yarn itself.

Fabrics consisting of various mixtures of wool and cotton yarns or fibers are frequently known as "union" goods, although the exact designation of the fabric or material will vary with the character of the goods or the usages of the trade in which they are current. For example, in knit-goods for the underwear trade, a yarn composed of a mixture of wool and cotton fibers is commonly known as "worsted," while the knitted fabric composed of these yarns is known as "merino." A well-known suiting fabric made up of a cotton warp and a worsted filling is known as

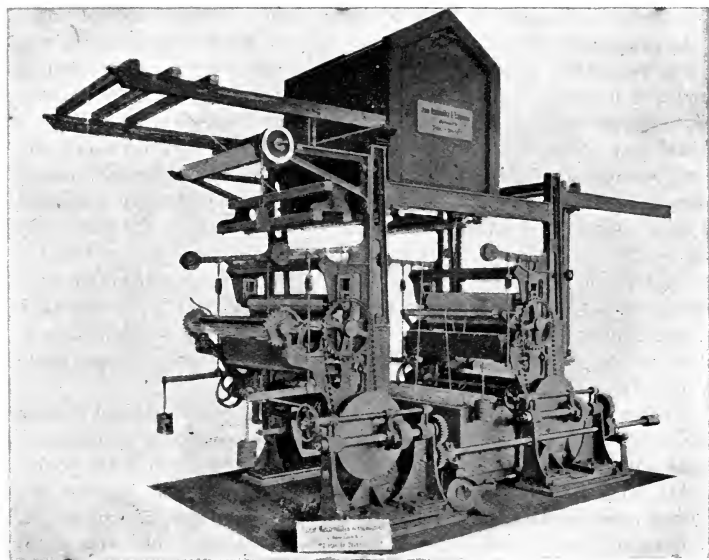

FIG. 261.—Apparatus for Chloring and Washing Union Goods to Clear White Cotton.

"cotton worsted"; a much-used lining fabric composed of wool and cotton yarns is called "Italian Cloth." And thus the wool-cotton fabric is to be met with under the guise of a variety of names depending upon the make-up and weave of the goods. The best class name, perhaps, for all of these goods, as far as the dyer is concerned, is union or half-wool material.

The use of cotton in connection with wool in the preparation of fabrics is generally considered to be chiefly for the purpose of producing a cheaper class of goods while imitating as far as possible the make-up and appearance of all-woolen goods. While this is true to a certain extent, there are many instances where the use of the cotton is chiefly for the purpose of

obtaining a fabric with certain required properties which could not be obtained with wool alone. In the case of knitted underwear, for example, if an all-wool yarn were used, the resulting fabric would shrink so much in washing as to be unsatisfactory to the consumer; also it would be rather unpleasant to wear next to the skin on account of the rather irritating and scratching effect of the wool fiber. By the use of the proper amount of cotton in the make-up of the yarns used for the knitting of this class of garment, a fabric can be obtained which does not have the bad effect of excessive shrinking and is also soft to the skin, at the same time possessing more warmth and porosity than a fabric made entirely of cotton. Also in the preparation of many fabrics, a mixed cotton-wool yarn is used, or a cotton warp yarn, or a yarn in some other form of weave construction is employed in order to produce a cloth having certain desirable qualities due to the presence of the cotton. From this, however, it is not to be concluded that cotton is always used in connection with wool for these perfectly legitimate purposes. There are many fabrics that attempt to masquerade as all-wool that contain more or less cotton cleverly concealed in their construction solely for the purpose of deceiving the consumer, who very frequently in good faith purchases the cloth with the idea that it contains nothing but wool and the cheaper fiber is employed for the purpose of sophistication. This, perhaps, is less true at the present time than it was formerly, owing to the fact that cotton has risen tremendously in value and the margin of difference in the price of the two fibers is now much less than it used to be.

Cotton is very largely used in connection with recovered wool (known also as extract wool, shoddy, mungo, etc.) for the production of low-grade cheap suitings and other fabrics within the purchasing power of the poorer classes. These fabrics, of course, do not possess the good qualities and wearing power of the all-wool fabrics of which they are a cheaper imitation. On the other hand, however, it may be argued that were it not for the use of cotton and the cheaper forms of recovered wool, the cost of such fabrics would be largely beyond the power of the poorer classes to buy, and they would thus be deprived of materials which are very needful and useful to them. This does not, however, warrant the description of such goods as all-wool for the purpose of wantonly deceiving the purchaser into buying with the deluded idea that in doing so he is acquiring a great bargain. Such goods have a distinct field of usefulness of their own, but should be marketed for what they are and not for what they imitate.

Sometimes the shoddy is more or less colored by a previous dyeing, and in this case it may be necessary to strip the material where a light shade is to be dyed on the union goods. The stripping is usually done by boiling the goods for one-half hour with 10 per cent of sulphuric acid and 3 per cent of chrome, though in the case of light shoddy boiling with sul-

phuric acid alone will usually be sufficient. In stripping the shoddy a prolonged boiling must be avoided, as otherwise the stripped color may again feed onto the wool. Also after stripping the goods must be washed in water containing a little alkali, preferably ammonia, in order to neutralize all of the acid, as otherwise the affinity of the cotton for the substantive dyes will be lessened and also there will be danger of the cotton becoming tendered by the action of the acid.

It is sometimes possible to strip shoddy union goods after the cotton has been dyed and in the same bath that the acid dye is applied to the wool.

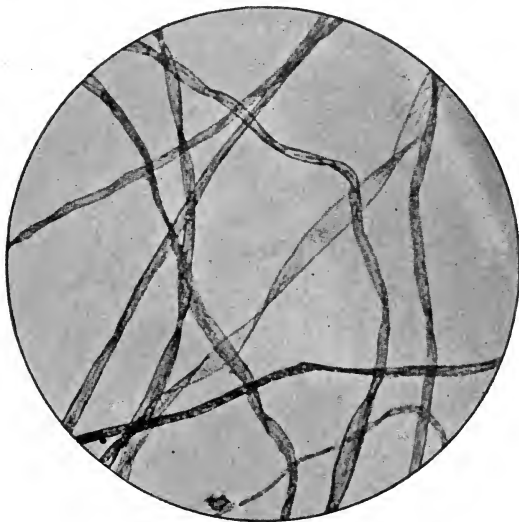

FIG. 262.—Cotton under the Microscope. (×140.)

This is done by adding the acid dye and the chrome together to the acid bath, so that the stripping and the dyeing of the wool is thus carried on simultaneously. Of course, in such a process it is necessary to use only such dyes on the cotton as will stand this treatment. It may be employed, for instance, where Columbia Black (or a similar black substantive dye) has been used for the cotton. It is also necessary to use only such acid dyes as are fast to the action of the chrome.*

* Such acid dyes are as follows:

Ponceau R, 4G
 Victoria Scarlet
 Guinea Red 4R
 Acid Magenta S

Mandarine
 Naphthol Yellow
 Azo Acid Yellow
 Curcumeine

Guinea Green
 Water Blue RC
 Wool Blue 5B, 2B
 Guinea Violet 4B

3. Detection and Estimation of Cotton and Wool in Mixed Fabrics.—

When the cotton and wool threads exist in the cloth as separate and distinct yarns their detection and estimation is a comparatively simple matter. If the separate yarns are picked out from the cloth and untwisted and pulled apart into a mass of the individual fibers the difference between the appearance and behavior of the two will be easily appreciated. The cotton fibers give a mass which is denser, flatter, and of a different "handle" from that of the wool. The latter is spongier, more curly and resilient.

On examining the two masses of fibers under a strong magnifying glass or microscope, the specific differences in appearance and structure will

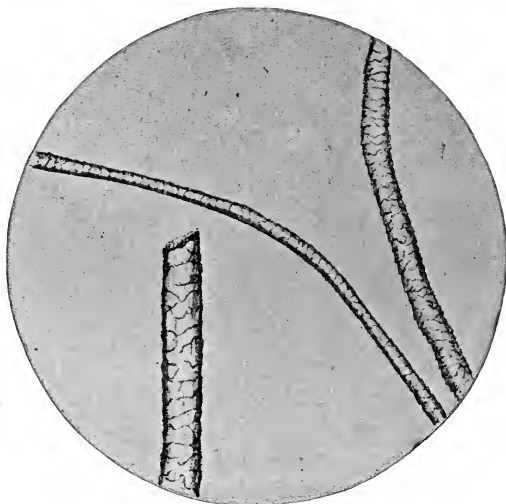

FIG. 263.—Wool under the Microscope. (x140).

become at once apparent to the eye. The cotton fiber has the appearance of a twisted, collapsed tube of a ribbon-like form and comparatively smooth on the surface (see Fig. 262), while the wool fiber is a rounded rod-like filament, usually rather curly, and exhibiting a very characteristic scaly surface (see Fig. 263). These scales are arranged in an overlapping manner, somewhat like shingles on a roof, and usually the edges protrude slightly from the surface of the fiber in a saw-tooth arrangement. It is this latter feature that causes the felting property of wool, and also which causes it to feel somewhat raspy when worn in close contact with the skin.*

* After a little experience in the examination of wool and cotton it becomes an easy

Other tests, however, are also available, based on the radical difference in the behavior of cotton and wool with a solution of caustic soda. When boiled with a weak solution (5 per cent is sufficient) of this reagent wool is very quickly dissolved, whereas cotton is scarcely affected. Consequently in cases where the two fibers are intimately mixed together so that they cannot be readily separated from each other by simple mechanical means, the procedure is to take a weighed sample and boil it for about ten minutes in a weak solution of caustic soda. The wool will be dissolved out of the yarn or cloth used, leaving the skeleton of cotton. This is washed to free it from the alkaline liquor, and is then dried in the air and reweighed. The weight so obtained gives the amount of cotton present, while the difference between this weight and that of the original sample

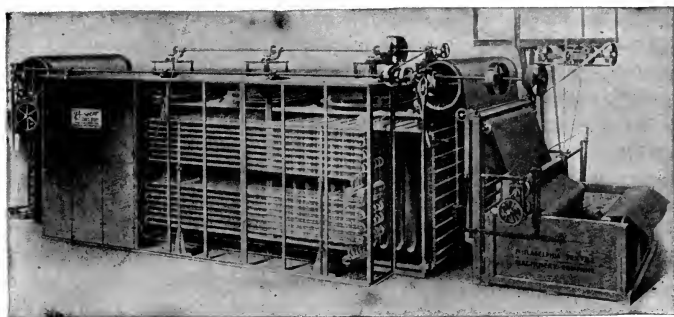

FIG. 264.—Shrinking Machine for Cloth. (Philadelphia Textile Machinery Co.)

gives the amount of wool. This test will also serve as a mere qualitative test for the two fibers, the suspected sample of cloth being boiled in the solution of caustic soda. If it dissolves completely only wool is present, whereas if any cotton is present, it may readily be seen in the residue that is left after boiling.

matter for one to readily distinguish between the two when they are in separate masses, even by a casual examination with the naked eye unaided by the microscope; also the feel and general handle of the fibers are very characteristic and allow them to be easily distinguished by anyone who has had a little practice in the matter. When the two fibers, however, are intimately mixed together by being carded and spun into one yarn, for instance, the detection and estimation of the relative quantities of the two fibers becomes a somewhat more difficult matter. Under such circumstances it usually becomes necessary to unravel the yarn and tease out the fibers so as to separate them individually, and then examine the mass under the microscope. This will at once show the fibers in contradistinction to one another, and by noting the amounts of the two in a representative sample a rough idea of their relative proportions may be obtained.

4. Properties of Union Goods.—As cotton and wool possess very different properties in their behavior towards dyestuffs, mordants, and the various chemical agents employed in dyeing, bleaching, and finishing of fabrics, and also as these two fibers are distinctly different in their physical properties and characteristics, it is to be expected that the processing of union goods involves many differences in operation from those where the material treated consists of the one fiber only. Owing to this variation in the nature of the two fibers, the processes of dyeing union goods are rather more complicated and more difficult than is the case when handling woolen or cotton goods alone. A knowledge of the relative behavior of the two fibers is essential, and considerable ingenuity must sometimes be employed in order to obtain the results desired. Certain facts must be clearly borne in mind; as already pointed out above in the testing of wool and cotton, the former fiber is very susceptible to the action of alkalis, especially in hot solutions; therefore it is not permissible to subject union goods to processes involving the use of strongly alkaline liquors, such as are frequently employed in connection with cotton. On the other hand, cotton is quite sensitive to the action of acids or solutions of certain salts of an acid nature, especially if such solutions are allowed to dry into the fiber. Under such conditions the fiber becomes weakened and rotten and in time totally destroyed. Wool is not sensitive in this manner to acids, and many dyeing operations where wool alone is in question, make free use of acid liquors; but such conditions must be avoided where union goods are involved, or the process must be so modified as to protect the cotton from the action of the acid.

Wool rather easily takes up certain metallic salts which act as mordants for the fixation of dyestuffs, whereas cotton is very weakly reactive towards such salts, and does not absorb them in sufficient amount to be useful as mordants for dyes. Again, wool combines with certain dyes readily, while cotton is practically inert towards the same dyes; and furthermore certain dyes require special methods for their proper fixation on cotton which combine directly with wool. It may be seen, therefore, that dyeing processes which might be suitable for the dyeing of wool would not be available for the dyeing of union goods.

5. Bleaching of Union Goods.—Bleaching processes are seldom employed in connection with union goods, as it is very seldom required that such fabrics be marketed in the white condition. Also it is very seldom that they are dyed in light shades or tints for which a bleached bottom would be necessary. Dark colors are more often used, such as blues, browns, and blacks. If it should be required, however, to bleach a fabric composed of wool and cotton the most convenient and satisfactory process would be to employ the peroxide method, the goods being steeped for several hours in a 1 per cent solution of hydrogen peroxide, prepared

either directly from a strong hydrogen peroxide solution by proper dilution or indirectly by the use of sodium peroxide dissolved in water containing a sufficient quantity of sulphuric acid to neutralize the alkali. The usual method of bleaching cotton with solutions of chloride of lime cannot be employed, as the wool would be discolored and weakened. Also the usual method of bleaching wool by the action of fumes of burning sulphur or with solutions of sodium bisulphite is not available, as these agents do not satisfactorily bleach the cotton while the acid developed in the process is liable to seriously injure the cotton fiber.

6. Action of Dyestuffs on Union Goods.—Before proceeding to a consideration of the specific methods of dyeing various kinds of wool and cotton mixtures, it will be well to first discuss the behavior of the different classes of dyestuffs on this character of material. For this purpose it will be sufficient to classify the different dyes under the following groups: (a) basic dyes; (b) acid dyes; (c) substantive dyes; (d) sulphur dyes; (e) mordant dyes; (f) vat dyes; and (g) vegetable dyes.

The *basic dyes* have but little affinity for the cotton fiber, and in consequence cannot be dyed on this fiber directly, but require the use of a mordant, such as tannic acid fixed with tartar emetic; these dyes, however, are dyed very readily on wool directly from neutral baths, and usually their affinity for this fiber is so strong that in order to produce even colors it is necessary to retard the dyeing by the use of a small amount of acid in the dyebath.

The *acid dyes* have even less affinity for cotton than the basic dyes, and only give stains on this fiber when used directly; there is even no very satisfactory method for mordanting the cotton whereby it may be dyed with acid colors having a satisfactory fastness to washing, consequently these dyes have little or no use in this connection. The acid dyes, however, have a strong affinity for the wool fiber, and are used very largely for this fiber, being dyed directly from baths containing acid. In the dyeing of union goods, therefore, the acid dyes are employed chiefly for shading the wool while leaving the cotton undyed. As it is not a very good thing to use hot acid baths in connection with cotton, recourse is generally had to those acid dyes which will be taken up by the wool even from neutral baths or from baths acidulated with such weak organic acids as acetic or formic acids, as these have but little effect on cotton, and their use is not attended with any special danger to this fiber.

The *substantive dyes* are perhaps the most important class of colors for the dyeing of union fabrics, as these dyes are taken up by both the cotton and the wool from neutral or slightly acid baths. Even here, however, a proper selection of the dyes must be made, as some of the substantive dyes have a greater affinity for the cotton than the wool, some have about the same affinity for both fibers, while others have a stronger attraction for

the wool. In most cases, however, the tone of the color is somewhat different on the cotton than it is on the wool, even where the dye possesses the same affinity for both fibers. In such cases it is necessary to tone the wool to match the cotton or special methods of dyeing are employed so as to regulate the relative amounts of the dye taken up by both fibers respectively. This is generally accomplished by a proper regulation of the temperature of the dyebath or by having it slightly acid or alkaline. Most of the substantive colors dye better on the wool at temperatures near the boil, whereas they dye better on the cotton in lukewarm baths. In weakly alkaline baths the attraction of the dye for the wool is lessened, while that for the cotton is somewhat increased. By using a slightly acid bath the opposite effect may be obtained.

The *sulphur dyes* are primarily cotton dyes, as they have to be applied from baths rather strongly alkaline with sodium sulphide in order properly

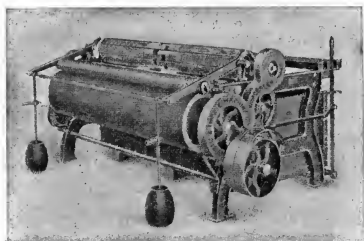

FIG. 265.—Cloth-Spreading and Rolling Machine with Hot Water Box. (Curtis & Marble.)

to dissolve the dyestuff. As this alkali exerts a strong dissolving action on wool, it is not possible to dye union goods in such a bath, and in consequence this class of dyes has little or no use for this class of goods. There are some special methods which make it possible to use these colors to some extent, such as the use of ammonium sulphide in place of sodium sulphide, and keeping the bath at a low temperature, and also using glucose in the bath. But none of these methods is of any very practical importance, and possesses little more than academic interest.*

* A large quantity of union goods, however, is made up by first dyeing the cotton in the yarn (either as skein or warp) with a sulphur color, such as Sulphur Black, Brown, or Blue, then weaving with the wool and subsequently dyeing the woven piece with acid colors. The sulphur dyes are especially suitable to this style of dyeing, as they are fast to the boiling acid bath that is used for dyeing the wool, and are in consequence often spoken of as "cross-dye" colors, as this process of dyeing is known to the dyer as cross-dyeing. Also sulphur dyes may be applied to loose cotton which is subsequently spun up with undyed wool to form a mix or blend. The wool may be afterwards dyed to

The *mordant dyes* require the use of a metallic mordant for their proper fixation of the fiber, whether of cotton or of wool. As cotton cannot readily be mordanted for this purpose, these dyes have but little application to union goods. The further fact that the mordanting operations required for wool would apt to be injurious to the cotton also considerably limits the possibilities of using the mordant dyes in this connection. For the production of certain fast colors, however, and especially blacks (as for example of hosiery), it is possible to first dye the cotton in the loose stock with a sulphur color, and after the hosiery has been knitted with the wool in the undyed state, the piece is dyed with an after-chromed wool black to produce a uniformly dyed fast black color. The sulphur dye in this case is not affected by the after-chroming dyeing process. In cases where a single thread of all-cotton together with another single thread of all-wool is used in the construction of the garment, it is possible first to dye the cotton with the sulphur color in the yarn form.

The *vat dyes*, although including the fastest dyes known for cotton, are not employed to any extent in the dyeing of wool-cotton materials, as the special methods required for the application of these colors are not well adapted to union goods.

Of the class of *vegetable dyes*, Logwood is about the only one used to any extent in the dyeing of union fabrics. This dye is chiefly used in connection with a metallic mordant (chrome, iron and bluestone) for the production of a black color. Sometimes Logwood is used as a one-bath dye for union goods, in which case the Logwood is used in a bath containing iron, bluestone and oxalic acid (the latter to prevent the precipitation of the color-lake in the bath) and subsequently adding soda ash to develop the color by neutralizing the acid. Also Logwood is considerably used for what is known as "speck" dyeing. This relates to the covering up of undyed vegetable fibers in woolen or worsted cloths.

7. Preparation of Union Fabrics for Dyeing.—A large number of wool-cotton fabrics do not require any special preparation previous to dyeing; articles like knit-goods, hosiery, etc., for instance, will generally only require a slight scouring in a lukewarm, dilute soap bath. Woven cloths, however, and especially those containing cotton warps, will have to be given a more severe scouring in order to remove the sizing materials always employed on the warps; also in order to remove completely the oil and dirt in the wool yarns. In this process the wool will shrink somewhat, while the cotton practically does not shrink at all, or to a much less extent. On

match the cotton (this is almost entirely limited to the case of blacks), but more often the wool is left in the undyed condition, thus giving a gray or "Oxford" mix, or if only a small proportion of the dyed cotton is used, a silver mix is obtained. Mixed yarns of this character are quite extensively used for knitting yarns for underwear, sweaters, and even many kinds of woven fabrics.

this account the cloth will cockle up, and has to be put through a special process known as "crabbing." Crabbing consists really in treating the cloth with boiling water so as to soften up the wool fiber and make it plastic, and then subjecting the cloth to heavy pressure or tension while it is being cooled with cold water. The wool is thus "set" in its fixed position and does not shrink, so that the cloth afterwards presents a smooth, even appearance.

Sometimes the cloth is singed previous to crabbing for the purpose of burning off the loose fuzzy protruding fibers in order to obtain a smoother and cleaner-looking surface. This, however, depends on the character of the cloth and the nature of finish to be obtained.

When it is desired to give the cloth a high luster in the finish a process of steaming (or decatizing) is frequently given after the crabbing. In this operation the cloth is tightly wound on a perforated cylinder and treated with dry steam, and then cooled. This gives the wool a high luster. Sometimes the decatizing is not done until after the dyeing, in which case the dyes used must be fast to this process. In decatizing it is important that the steam used is dry (does not contain any condensed water, which would cause spotting of the goods). Usually steam of 1 to 2 atmospheres pressure is used. Also the cloth as rolled on the cylinder should be well enveloped with a cloth cover in order to prevent the outside layers from cooling off too rapidly. The treatment with the steam usually lasts only from five to eight minutes, after which the cloth is unrolled on to another similar cylinder and then steamed again so as to avoid possible uneven action, as the end which was first inside now becomes the outside end. After steaming the cylinder of cloth should be placed in a horizontal frame and turned slowly for about half an hour in order to permit of an even cooling.

After decatizing the goods are ready for dyeing, and for such goods the dyeing should be done in machines permitting of running the cloth in the open width to prevent the development of crease marks. Goods that are not decatized may be dyed in the rope form very often, though this will naturally depend upon the particular character of the goods being handled.

8. The Dyeing of Union Fabrics.—From the previous consideration of the different behavior of wool and cotton towards the various classes of dyestuffs it may be readily presumed that there is little difficulty to be experienced in dyeing one fiber while leaving the other practically undyed. If an acid dye, for example, is used, and a strongly acid boiling bath is employed, the wool will be dyed while the cotton will be left practically undyed. On the other hand, the cotton alone may be dyed by using a fiber mordanted with tannin and tartar emetic and dyeing with a basic color in a cold bath; or certain substantive dyes may be used (such as

Heliotrope, Congo Rubine, Diamine Pure Blue, etc.) in a cool bath, and the wool will be left practically white.

In practice, however, it is far more often required that both fibers should be dyed as near as possible the same shade in order to furnish a uniform piece of goods. Usually the cotton should be dyed a little bit darker than the wool, as this will cover it up better and its presence will not be so noticeable. It is frequently necessary to dye each fiber irrespective of the other; for instance the wool may first be dyed in an acid bath, leaving the cotton undyed; then the cloth is mordanted with tannic acid and fixed with tartar emetic, washed and dyed in a cold bath with a

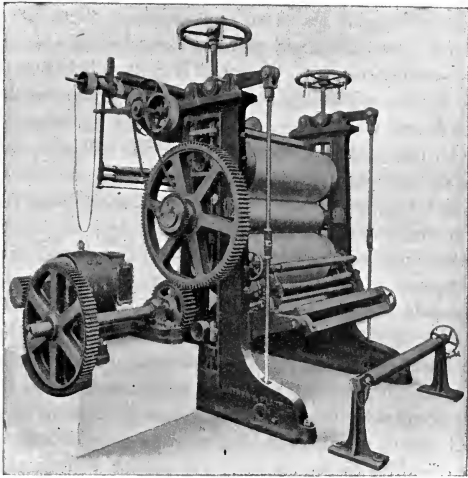

FIG. 266.—Four-bowl Water Mangle. (Mather & Platt.)

basic dye. During the latter operation the color of the cotton must be sampled from time to time to see if it has acquired the correct tone and the proper depth of shade. It is necessary to use a cold bath, since the basic dyes will dye on the wool in a warm bath. Such a process, however, requires the use of four separate baths, which makes it both complicated and costly. On this account it is seldom employed except for certain special kinds of material.

A simpler process, requiring only the use of two baths, is first to dye the wool as before with an acid dyestuff and then to dye the cotton in a second bath with a substantive dyestuff, using, if necessary, a slightly alkaline bath at a moderately low temperature in order to prevent the

wool from becoming dyed. Also, of course, care must be exercised in the proper selection of the dyestuffs to be used. In using this process the order of dyeing the two fibers may sometimes be reversed; that is to say, the cotton may first be dyed in a cold or lukewarm bath with a substantive dye, and then the wool may be dyed in a boiling acid bath with an acid coloring matter. It is necessary, of course, to use only such substantive dyes in this process as will not be affected by the acid bath. This method of procedure is used quite frequently for the dyeing of suitings and dress-goods having a cotton warp and a wool filling; the cotton warp being dyed previous to weaving, and the wool being subsequently dyed in the woven piece. The sulphur dyes are especially adapted to this method, as they will stand the wool cross-dyeing; there are also certain of the substantive dyes which will stand a cross-dyeing operation.*

Another two-bath process to be noted is that which has to do chiefly with the speck dyeing of black pieces; in order to cover up the cotton (or other vegetable fibers) which may be on the surface of the goods the pieces may be treated with sumac and copperas, which will give an iron black. A better method, perhaps, is to use certain substantive black dyes (such as Direct Black VT, Pluto Black F and Diamine Milling Black), which will dye well on the cotton in a cold bath.

There are also single or one-bath methods for the dyeing of union goods. These chiefly depend on the use of substantive dyes so selected as to dye both fibers as nearly alike as possible. By properly varying the temperature and alkalinity of the bath it is often possible to adjust the absorption of the color on the two fibers as to obtain the results desired. The cloth is usually dyed for ten to fifteen minutes in a boiling bath so that the wool will take up most of the color; then the steam is shut off and the bath is allowed to cool down, when more dye solution is added and the color is thus allowed to feed on to the cotton. By proper adjustment of the conditions it is often possible to obtain very satisfactory uniformity of color. Unfortunately, however, it is seldom the case that one dye will give exactly the same tone of color on both fibers, so that it is usually necessary to shade either the cotton or the wool with other dyes. When the cotton is to be shaded, this is usually done by adding the required dye in the cooled bath. When the wool is to be shaded a suitable acid dye is added, or certain special dyes may be used (such as the Sulphon dyes) which only dye the

* For the better classes of half-woolen fabrics the cotton is usually dyed in the form of warps previous to weaving; this is particularly true of blacks, browns, and other heavy colors. By this means there is less injury and alteration of the wool and the goods can be given a softer and better handle. Furthermore, clearer and brighter colors can be obtained. There is also a greater diversity possible in the selection of the dyestuffs to be employed. In the case of the lower grades of half-wool fabrics, especially those containing shoddy and recovered wool with cotton warp, it is more customary to dye both fibers in the piece after weaving. This is especially true where light colors are used.

wool in a hot bath.* Rhodamine and other similar acid dyes that will take up on the wool from a neutral bath are very useful for shading purposes (such as Fast Red A, Croceine Scarlet, etc.). This shading may be carried out in the same bath, but requires considerable skill and experience in order to obtain the desired results. This is especially the case where it is necessary to match a given shade or particular tone of color.

Since the introduction of the substantive cotton dyes the use of the one-bath process for the dyeing of union goods has been greatly extended and improved. It has gradually come to be the one most favored by dyers, as it is now possible to obtain almost any desired effect with a minimum handling of the goods and a great simplicity of process, so that there is little difficulty experienced in matching of shades to sample and in bringing up the color of both fibers to the same tone and depth. As a consequence, the older and more complicated processes of dyeing union goods have been more and more abandoned.

9. Dyeing Processes for Union Goods.—The details for the processes for wool-cotton goods may now be considered with special reference to the different classes of dyes to be employed.

(a) *Two-bath Process.*—The wool portion is first dyed with the suitable acid dyes in the customary manner using a dyebath to which is added 4 per cent of sulphuric acid and 10 per cent of Glaubersalt. The necessary dye or mixture of dyes is first dissolved in hot water and then added to the bath. The goods are dyed for about an hour at a temperature of about 200° F. Instead of using acid and Glaubersalt, 10 per cent of sodium bisulphate may be employed. The material is then washed in order to remove the excess of acid and dye solution and the cotton is mordanted by passing into a bath containing 2 to 10 per cent of tannin (depending on the depth of color to be dyed). The goods are entered at a temperature of about 200° F., the heat shut off and the cloth run in the cooling bath for one hour. In order to fix the tannin in an insoluble form the cloth is then run through a cold bath containing 2 per cent of tartar emetic. This is an antimony salt and forms an insoluble antimony tannate with the tannin. Rinse and finally dye in a bath containing a suitable basic dyestuff together with 2 per cent of acetic acid. The dyeing should be done cold, or at least not over lukewarm, in order to prevent the color being taken up by the wool. The dyeing in this bath should be so manipu-

* In matching of union goods in dyeing to a sample it must be remembered that by prolonged boiling the substantive dyes tend to feed off from the cotton onto the wool, and that after having matched the sample with respect to the cotton, and then trying to boil on more color to the wool, it is possible to let down the color on the cotton so that the latter no longer shows a match. Therefore superfluous boiling of the bath should be avoided. It should also be noted that either stripped or unstripped shoddy takes up the dye more readily than pure wool, therefore in dyeing such material only those substantive dyes should be selected which stain the wool least.

lated by additions of dyestuff solution that the cotton is dyed a slightly heavier shade than the wool.

(b) *Two-bath Process*.—The wool is first dyed with an acid dye as above described and then rinsed and dyed in a second bath with a suitable substantive cotton dye in a cold or lukewarm bath with the addition of 10 to 20 per cent of Glaubersalt.

(c) *Two-bath Process*.—The wool is first dyed with an acid dye as above described, rinsed, and the cotton is mordanted with tannin or sumac and then fixed with copperas or the so-called nitrate of iron (which is really a basic sulphate of iron). The tannin and the iron salt give a bluish black or dark slate color, so this process is used only for dark blues or blacks..

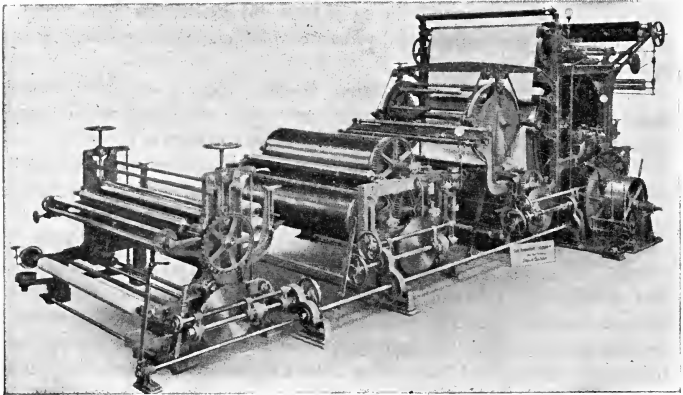

FIG. 267.—Palmer Machine for Finishing Cashmeres, etc.

After fixing with the iron salt it is recommended to rinse the goods in a bath containing some lime water.*

(d) *Two-bath Process*.—The wool is first dyed with an acid dye as before; the goods are rinsed and the cotton is dyed in a cold bath with suitable substantive black dyestuffs. This method is used chiefly for "speck" dyeing of black colors.†

* For the dyeing of blacks the following method is frequently employed: The cloth is first given a treatment with a tannin bath to mordant the cotton, followed by a fixing bath with copperas and bluestone; the wool is then mordanted with chrome and the dyeing is done with Logwood (properly toned with Fustic).

† This method is frequently employed where the wool in the union material will not stand a long boiling in a neutral bath, and it is also preferred when it is desired to give the wool a firmer feel. The process is also called "burl" dyeing, and is intended chiefly for the purpose of covering up the cotton so that it will not be easily apparent. After

(e) *Two-bath Process*.—The cotton is first dyed in a cold bath with suitable substantive dyes which are fast to cross-dyeing. The dyeing is usually done on the jigger in a short bath. The goods are rinsed and then the wool is dyed with Sulphon dyes or other suitable acid dyes that may be used in a bath with ammonium acetate instead of sulphuric acid.*

(f) *One-bath Process*.—The material is dyed in a bath with suitable substantive dyes with the addition of 30 to 60 per cent of Glaubersalt. †

The bath is heated to a boiling temperature and the goods are run for about half an hour, and then a sample is taken for matching; if the wool is too light, ‡ or if it does not have the proper tone of color, it is matched up by adding the necessary color and continuing the boiling for a short time. If, on the other hand, the cotton is too light, the steam is shut off and the goods are run in the cooling bath and if necessary an addition of the proper cotton dyestuff is made. After dyeing the goods are rinsed and dried. The dyebath is preserved for subsequent lots with the necessary additions of dyes and a small quantity more of Glaubersalt.

the acid dye has been applied to the wool, the goods should be rinsed in a bath containing a little ammonia or soda, and then the cotton is dyed with such cotton colors as may be applied in a fresh cold bath. An addition of about 10 lbs. of Glaubersalt per 100 gallons of liquor is made, both the dye and the salt being first dissolved in boiling water and then added to the cold bath.

* This method is often employed for the dyeing of blacks on shoddy material which does not require the cotton warp to be dyed exactly the same shade as the wool as long as it is covered in a manner that conceals its presence. The cotton is first dyed with Columbia Black (or other suitable substantive black dye which is fast to treatment with dilute acid at a boiling temperature). The bath is made up as concentrated as possible with 6 per cent of Columbia Black, 20 per cent of Glaubersalt and 3 per cent of soda ash, and the goods are dyed at 140 to 160° F. until the cotton is sufficiently covered. Then rinse and dye the wool in a fresh bath with acid dyes with the addition of 10 per cent of Glaubersalt and 5 to 10 per cent of sulphuric acid. In this second bath it is necessary to enter the goods at a low temperature and gradually raise to the boil in order to first completely fix the black on the cotton, as otherwise the wool may become stained.

A modification of this process in order to save time on goods that are to be fulled is to dye the cotton with the black during the fulling operation. This is especially suitable for cheap shoddy materials where the cost of operation must be reduced to a minimum. There is added to the fulling liquor (according to the amount of cotton present) 3 to 5 per cent of Columbia Black FBW. Shortly before the fulling is finished a little Glaubersalt may be added. The goods are then rinsed and dyed with acid dyes, taking care that the bath is sufficiently acid before entering the goods in order to avoid the staining of the wool by the cotton dye.

† While the amount of Glaubersalt (or common salt) used depends on circumstances, an excess should be avoided, as this may produce a precipitation of the dyestuff in the bath which may lead to cloudy and bronzy dyeings. The amount of salt in the liquor should be such that it does not show a hydrometer reading of over 3° Tw.

‡ Care should be taken not to get the wool too dark, for if this occurs the cloth had best be set aside to dye a darker shade, and if this is not possible the goods will have to be stripped down in a fresh bath.

Not only is the regulation of the temperature of the bath necessary to secure the desired results, but the concentration of the dyebath also plays an important rôle. The higher the concentration of the bath the more readily will the desired shade be obtained on the cotton. It is best to employ a rather short bath (1:25) and to use 5 to 20 lbs. of Glaubersalt per 100 gallons of liquor (depending on the depth of color required). For the dyeing of blacks and heavy browns a larger addition of Glaubersalt may be required. It is also best to heat the bath with a closed steam coil rather than with direct steam so as to avoid unduly diluting the bath. The addition of a small quantity (about $\frac{1}{2}$ per cent) of soda will cause the dye to be taken up less on the wool, whereas the addition of a little acetic acid will make the dye feed onto the wool better. Furthermore, as the quantity of the dye taken up by the cotton in the material depends to a large extent on the concentration of the dyebath, it will be necessary to use the same amount of dyestuff irrespective of the proportion of the cotton. As the many union materials contain cotton and wool mixed in all possible proportions it will be found that those containing a small percentage of cotton will require relatively more dyestuff than those containing a high percentage of this fiber. This will be understood in considering the fact that whereas the most advantageous proportion of liquor to cotton is about 1:25, in goods containing equal parts of wool and cotton, this quantity of liquor would amount to only a proportion of 1:50 on the weight of the cotton, consequently to make up for this relative dilution of the bath a larger proportion of dyestuff will be required.

(g) *One-bath Process.*—The dyebath is prepared with boiling water and the solution of the dyestuff and sufficient cold water is added to bring the temperature down to about 140° F., then enter the goods, run for half an hour, bring to the boil, and take a sample for matching. If the cotton is dark enough but the wool is too light, add a neutral dyeing acid color to match up on the wool.

(h) *One-bath Process.*—The dyeing is done in a warm bath, using the required substantive dyes for the cotton and the proper neutral dyeing acid colors for the wool with 20 to 30 per cent of Glaubersalt and dyeing at the boil until the shade is matched.*

The selection of which process to employ must be left to the judgment of the dyer, depending on the nature and character of the goods being dyed. Considerable ingenuity must often be exercised in order to obtain the proper results without disastrous effects on the fabric. It is usually best to make a test dyeing first in order to determine which process and what dyestuffs are the best to employ in any given case.

(i) *Process for Two-color Dyeings.*—Certain kinds of half-wool material

* This process is also adapted to burl dyeing for the purpose of covering the cotton especially when only a small amount of this fiber is present.

are sometimes dyed so as to produce a two-color effect, with one color on the cotton and another color on the wool. When it is necessary to match these colors to a given sample the problem is at times quite difficult, but by the use of suitable dyeings with the substantive cotton colors and the neutral dyeing acid colors for wool a great variety of effects are possible.

10. Two-color Effects.—For the production of two-color effects it is best to employ the two-bath method, dyeing the wool first in an acid bath and then dyeing the cotton in a fresh cold bath with suitable substantive colors. It is advisable to rinse the goods after dyeing the wool, using a bath containing a small amount of ammonia or soda ash. One-bath

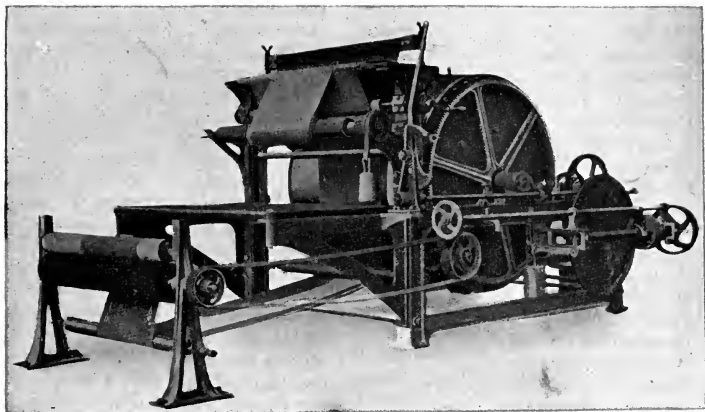

FIG. 268.—Silk Finishing Machine.

methods may also be employed, using acid dyes which may be applied in a neutral bath together with substantive dyes; but this method gives less brilliant colors, though it is possible to obtain fairly good effects if the neutral dyeing acid color is first added alone to the boiling bath, and subsequently the cotton colors after the bath has cooled down.

11. Classification of Dyes for Union Goods.—With respect to their behavior in the dyeing of union goods, the substantive dyes may be classified as follows, according to their action in a boiling neutral salt bath:

- (a) Dyes which color the cotton darker than the wool.
- (b) Dyes which color both fibers approximately alike.
- (c) Dyes which color the wool darker than the cotton. And for auxiliary dyes for purposes of toning there may be mentioned:

(d) Acid dyes which color the wool satisfactorily in a boiling neutral bath, leaving the cotton white or practically undyed.*

The following is a list of the principal dyes in these different classes:

(A) Dyeing the Cotton Darker than the Wool

Acetylene Blue 3B, 6B	Diamine Jet Black CR
Benzo Azurine G	Diamine New Blue G, R
Benzo Brown D3G	Diamine Nitrazol Brown G
Benzo Fast Blue	Diamine Orange G
Benzo Fast Scarlets	Diamine Pure Blue A
Benzo Fast Violet R	Diamine Sky Blue FF
Benzo Sky Blue	Diamine Violet N, BB
Benzo Violet R	Dianil Black PR, PG, HW
Brilliant Azurine B	Dianil Blue G, B, R
Chloramine Orange	Dianil Browns
Chloramine Yellow	Dianil Dark Blue R, 3R
Chlorantine Orange	Dianil Fast Brown B
Chlorantine Yellow	Dianil New Black LB
Columbia Blue G and R	Dianil Orange G
Columbia Brown R	Diazo Black BHN
Columbia Fast Blue 2G	Direct Blue 2B
Columbia Green	Direct Brown V
Columbia Yellow	Direct Rose T
Congo Fast Blue HW	Direct Violet N
Cupranil Brown B, R	Direct Yellow R, T
Cureumine S	Heliotrope BB
Diamine Bengal Blue R	Mikado Golden Yellow 8G
Diamine Black BH	Mikado Orange G
Diamine Blue BB, BG	Mikado Orange GO, 4RO
Diamine Bordeaux B	Mikado Yellow
Diamine Brilliant Blue R	Oxy Diamine Black KW, A, D
Diamine Brown ATC	Oxy Diamine Blue G, B, R
Diamine Catechine B	Oxy Diamine Brown RN
Diamine Dark Blue B	Oxy Diamine Violet B, R, G
Diamine Deep Blue B, R	Para Diamine Black B
Diamine Fast Black F	Pluto Black CR, F
Diamine Fast Blue FFB, G, BN	Solamine Blue FF
Diamine Fast Brown G, R	Union Blue Black
Diamine Fast Scarlet GG, 4BN, 6BS	Zambesi Black B and R
Diamine Fast Yellow A	Zambesi Brown G and 2G
Diamine Heliotrope B. G	

* All of the substantive cotton dyes when dyed in a bath at temperatures below the boiling point have a tendency to dye the cotton more than the wool. It appears that by reducing the temperature their affinity for the wool decreases to such an extent that even those dyes which in a boiling bath dye the wool more than the cotton, in a cold bath will leave the wool almost undyed and dye almost exclusively the cotton.

Sometimes, after boiling the dyebath the cotton will not show the required depth of shade, in which case the steam must be turned off and the goods run in the cooling bath for some time, or suitable dyes may be added for purposes of shading. In this connection those substantive dyes mentioned in the list (B) are especially adapted, as they dye the cotton well in a cold bath.

(B) Dyeing Both Fibers Alike

Benzo Azurine 5G	Diamine Fast Yellow 2F, B M
Benzo Blue RW	Diamine Green G, B, CL
Benzo Bordeaux	Diamine Green J
Benzo Brown 5R	Diamine Orange B
Benzo Chrom Browns	Diamine Purpurine B, V
Benzo Cyanine C, R	Diamine Red B
Benzo Dark Green	Diamine Red 3B, 5B, 10B, D
Benzo Fast Orange	Diamine Rose GD, BG
Benzo Fast Red	Diamine Steel Blue L
Benzo Fast Yellow	Diamine Violet J
Benzo Green	Diamineral Brown G
Benzo Orange R	Diaminogene B
Benzo purpurine 4B	Dianil Black N, E
Benzo Red	Dianil Blue BX
Benzo Rhoduline Red	Dianil Brown 3GO, 3R
Brilliant Benzo Blue	Dianil Claret Red G, B
Brilliant Congo R	Dianil Copper Brown B
Brilliant Geranine G	Dianil Indigo O
Brilliant Orange G	Dianil Orange N
Brilliant Purpurine 10B, R	Dianil Red R, 4B
Carbide Black S, E	Dianil Yellow 3G, R
Chicago Blue 6B, 4B, B	Diazo Black
Chromanil Black 2BF	Diazo Blue Black
Chromanil Brown 2G, R	Direct Black CR
Chrysamine G	Direct Blue B
Chrysophenine G	Direct Blue Black
Columbia Black, FB, F2B, FBW	Direct Brown M
Columbia Black Blue G	Direct Deep Black EW
Columbia Violet R	Direct Fast Brown
Congo Brown G and R	Direct Gray B, R
Congo Corinth G and B	Direct Gray J
Congo Orange G, R	Direct Green B, J
Congo Red	Direct Indigo Blue
Congo Rubine	Direct Orange GR
Congo Sky Blue	Direct Sky Blue
Cotton Brown RN	Erie Black
Cotton Red A	Half-wool Black K, S
Cotton Yellow R	Half-wool Blue WG
Cupranil Brown G	Half-wool Brown M
Delta Purpurine 5B	Orange TA
Diamine Azo Blue 6B	Oxamine Blue 3R
Diamine Bengal Blue	Oxamine Claret M, B
Diamine Black HW	Oxamine Copper Blue 2R
Diamine Blue RW	Oxamine Dark Blue BG, R
Diamine Bordeaux VRO	Oxamine Fast Red F
Diamine Brilliant Bordeaux R	Oxamine Red, 3B
Diamine Brown 3G, R, M, S	Oxamine Violet
Diamine Catechine G	Oxy Diamine Black JE, JW
Diamine Dark Green N	Oxy Diamine Brown G, 3GN
Diamine Fast Red F	Oxy Diamine Orange G, R

Oxy Diamine Red S	Union Black S, P, BG, 2B
Oxy Diamine Yellow 2G, TZ	Union Blue BJ, RJ, 2B
Pluto Black BS, 3B, TG	Union Brown TD
Pluto Brown NB	Union Dark Brown A
Pluto Orange G	Union Fast Black J
Pyramine Orange 3G	Union Jet Black B
Thiazol Yellow	Union Navy Blue J
Thioflavine S	Zambesi Black D
Tolamine Violet	Zambesi Black F
Toluylene Orange G	

(C) Dyeing Wool Darker than Cotton

Acetylene Blue 3R	Diamine Scarlet B, 3B
Acid Congo R	Diamine Violet Red
Benzo Fast Black	Diamine Yellow CP
Brilliant Congo R	Diaminogene extra
Brilliant Dianil Red R	Dianil Black T
Brilliant Geranine 3B	Dianil Green G
Chicago Blue RW	Dianil Scarlet G, 2R
Chlorantine Red 4B, 8B	Dianil Yellow G
Chlorantine Rose	Direct Blue R, W
Columbia Orange R	Direct Blue Black 2B
Congo Blue BX	Direct Brown R
Congo Orange R, G	Direct Rose GN, BN
Congo Rubine	Direct Safranine G, B
Cotton Red, 4B, 10B	Direct Violet, C, CB
Cotton Yellow CH	Direct Yellow CR
Cresotine Yellow G	Erica
Diamine Bordeaux S	Geranine G, 2B
Diamine Brown B	Nyanza Black B
Diamine Gold	Pluto Brown G, R
Diamine Jet Black OO	Toluylene Orange R
Diamine Orange F	Wool Brown R and G
Diamine Rose BD	

(D) Acid Dyes Leaving Cotton White

Acid Alizarine Blue 2B	Alkali Blue 6B, 3R
Acid Alizarine Green G	Alkali Violet LR, O
Acid Alizarine Grenade R	Alkaline Blue 6B, 3R
Acid Black 5B	Alkaline Fast Red R
Acid Black HA, NN	Alkaline Violet CA
Acid Brown G, B, V	Alphanol Black BG, R
Acid Green 3B	Alphanol Blue BR
Acid Magenta	Anthracene Acid Green
Acid Rhodamine R	Anthracene Red
Acid Violet HW, 4RS, 3BN, 7B	Archil Substitute G
Alizarine Blue SKY	Azo Acid Black B, G, BL
Alizarine Green SS	Azo Acid Blue B
Alizarine Red WS	Azo Acid Carmine B

- Azo Acid Magenta G, 6B
 Azo Acid Yellow
 Azo Carmine
 Azo Flavine
 Azo Red A
 Benzyl Blue B, S
 Benzyl Green B
 Benzyl Violet 4B, 10B
 Brilliant Acid Green 6B
 Brilliant Black B
 Brilliant Croceine 3B
 Brilliant Milling Blue B
 Brilliant Milling Green B
 Brilliant Sulphon Azurine
 Brilliant Wool Blue G
 Brilliant Wool Blue RB
 Chromogen I
 Chromotrope FB, 8B
 Chromotrope G, 2R, 2B
 Citronine OO
 Cloth Fast Blue R, G, B
 Cloth Red BA
 Cochineal Red A
 Cochineal Scarlet PS
 Croceine AZ
 Croceine Orange G
 Croceine Scarlet 3B
 Curcumeine
 Cyanine B
 Diamond Black F, NG
 Eosin
 Fast Green CR
 Fast Red A
 Fast Scarlet B
 Fast Yellow Y
 Flavazine T
 Formyl Blue B
 Formyl Violet S4B, 10B
 Guinea Green B
 Guinea Violet 4B
 Indian Yellow G, R, FF
 Indocyanine, B
 Indigo Carmine
 Lanacyl Blue 2B, R
 Lancy Navy Blue B
 Lancy Violet B
 Lazuline Blue R
 Light Green SF
 Mandarin G
 Martius Yellow
 Metanil Yellow
 Milling Red G
 Mordant Yellow O
 Naphthalene Blue B, D
 Naphthalene Green V
 Naphthaline Acid Black 4B
 Naphthaline Yellow
 Naphthol Blue G, R
 Naphthol Blue Black
 Naphthol Dark Green G
 Naphthol Red O, S
 Naphthol Yellow S
 Naphthyl Blue Black N, FB
 Naphthylamine Blacks
 Neutral Blue for Wool
 Neutral Wool Black G, B
 New Victoria Blue B
 Orange II, ENZ, R
 Orange GT, G
 Palatine Black 4B
 Palatine Red A
 Patent Blue A, V, N, L
 Phenylamine Black 4B, T
 Phloxine
 Ponceau 3R, 3RB
 Quinoline Yellow
 Red Violet 4RS
 Rhodamine B, G
 Rocelline
 Scarlet R, 6R
 Silk Red G
 Sorbine Red
 Sulphon Acid Blue B, R
 Sulphon Azurine D
 Sulphon Black R, 4BT
 Sulphon Blue Black
 Sulphon Brown R
 Sulphon Cyanine G, GR
 Sulphon Cyanine Black B
 Tartrazine
 Thiocarmine R
 Tropaeoline G, OO
 Victoria Rubine O, G
 Victoria Scarlet 2R, 6R
 Victoria Violet 4BS
 Wool Black 6B, 4FB, GR, N4B
 Wool Blue 5B, 2B, R and G
 Wool Blue N, R, SR, S
 Wool Green S
 Wool Jet Black 2B, 3B
 Wool Red B, BG
 Wool Violet 10B, 6B

(E) Substantive Dyes Which Dye Cotton in a Cold Bath and Leave the Wool White

Anthraquinone Black	Diamine Red 10B
Benzo Blue 2B, 3B, RW	Diamine Rose GD
Benzo Chrome Browns	Diamine Sky Blue FF
Benzo Cyanine 3B	Diamine Violet Red
Benzo Dark Green	Dianil Black PR, PG, CR
Benzo Fast Scarlet 4BS	Dianil Blue G, B, R
Benzo Sky Blue	Dianil Orange G
Benzo Violet R	Dianil Brown R
Brilliant Azurine B	Dianil Yellow 2R
Brilliant Benzo Blue 6B	Diazo Black B, BHN
Brilliant Geranine G	Direct Black VT
Brilliant Orange G	Direct Deep Black E
Brilliant Purpurine R	Direct Yellow R
Chicago Blue 6B	Erica BN, 2GN
Chloramine Orange G	Grounding Black for Cotton
Chloramine Yellow	Heliotrope 2B
Chrysophenine G	Melanogene Blue B
Columbia Black HWD	Mikado Orange G
Columbia Blue G, R	Oxamine Blue 3R, A, B
Congo Red	Oxamine Brown M
Congo Rubine	Oxamine Claret M
Cotton Red A	Oxamine Garnet M
Cotton Yellow R	Oxamine Red
Curcumine S	Oxamine Violet
Diamine Black BH, HW	Oxy Diamine Red S
Diamine Blue 2B	Oxy Diamine Violet B, G, R
Diamine Brown S	Phenamine Blue G, B, R
Diamine Fast Blue FFB	Pluto Black BS, G, FR, F
Diamine Fast Yellow A, B	Pyramine Orange R
Diamine Green G	Salmon Red
Diamine Heliotrope G, B, O	Sulphine A, N
Diamine Nitrazol Brown G	Thiazine Brown G, R
Diamine Orange, G, D	Thiazole Yellow R
Diamine Pure Blue A	Zambesi Black D
Diamine Purpurine 6B	

12. After-treatment of Union Dyeings.—Where substantive dyes are used on union goods it is sometimes possible to obtain an increased fastness to light and washing by giving the dyed goods an after-treatment with a bath containing bluestone or chrome or a mixture of the two salts. This after-treatment is carried out by treating the rinsed goods for one-half hour in a fresh boiling bath with 1 to 3 per cent of bluestone, $\frac{1}{2}$ to 1 per cent of chrome, and $\frac{1}{2}$ to 1 per cent of acetic acid.

The wool in union goods dyed with substantive colors may at times be topped with basic dyes in order to increase the brilliancy of the shade. This is usually done in a fresh cold or lukewarm bath with the addition of a little acetic acid, and not using over $\frac{1}{2}$ per cent of the basic dye, as other-

wise the color will probably rub. It will generally also be found that some of the basic dye will go on the cotton and brighten its color.

13. The Dyeing of Wool-plush.—Wool-plush is a half-wool fabric consisting of a cotton backing and a wool pile and the construction of the fabric requires cotton in both the warp and the filling. This cotton is usually dyed in the warp and skein previous to weaving, and the wool is dyed afterwards in the piece. For the latter purpose acid dyes are generally employed, or certain of the natural wood dyes (in the case of certain brown shades Archil and Sandal-wood are employed). In some of these plush fabrics the wool is woven in pattern effect so that the cotton backing is not entirely covered. In such cases the cotton must be dyed the same color as the wool, and consequently is not dyed until after the piece is

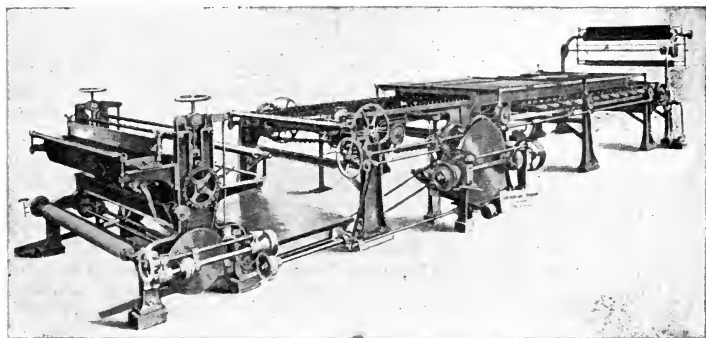

FIG. 269.—Machine for Sizing and Finishing Silk.

woven. For this purpose one of the two-bath dyeing processes given above may be employed. The dyes used should be easily leveling colors and have good fastness to rubbing and light.

Wool-plush is mostly dyed in an open-width machine so as not to injure and crease the pile surface, though sometimes in the case of light-weight plush the dyeing is done in the rope form, and the ordinary dye-tub and winch may be used running the goods with the pile surface uppermost.

14. Experimental. Exp. 208. Action of Acid Dyes.—Take a skein of wool-cotton yarn and place it in a bath containing 2 per cent of Formyl Violet S4B, 4 per cent of sulphuric acid and 10 per cent of Glaubersalt; boil for one-half hour, wash and dry. It will be found that the acid colors only dye the wool in an acid bath.*

* The skeins of union yarn (wool-cotton) to be employed in these experiments may be conveniently made by simply taking a 5-gram test skein of woolen yarn and a 5-gram test skein of cotton yarn and dyeing them together as a 10-gram skein. Or the skeins may be made in a rather better manner by reeling together a strand of wool

Exp. 209. Action of Basic Dyes.—Dye a skein of wool-cotton yarn in a bath containing 2 per cent of Methylene Blue and 10 per cent of Glaubersalt; boil for one-half hour, then wash and dry. It will be found that the basic colors dye only the wool in a neutral bath, the cotton only being slightly tinted. Mordant a skein of wool-cotton yarn in a bath containing 4 per cent of tannin; work at 180° F. for fifteen minutes, then leave in the bath without further heating for one-half hour, then squeeze and pass into a bath containing 2 per cent of tartar emetic, work cold for fifteen minutes, then wash well, and pass into a bath containing 2 per cent of Methylene Blue and 10 per cent of Glaubersalt; boil for one-half hour, then wash and dry. It will now be found that both the wool and the cotton have become dyed. Observe if both of the fibers are dyed to the same shade and same tone of color.

Exp. 210. Action of Substantive Dyes.—(a) *Dyeing the Wool and Cotton Alike.* Dye a skein of wool-cotton yarn in a bath containing 2 per cent of Thioflavine S and 10 per cent of Glaubersalt. Boil for one-half hour, then wash and dry. Compare the color obtained on the wool with that on the cotton.

(b) *Dyeing the Cotton Darker than the Wool.* Dye a skein of wool-cotton yarn in a bath containing 2 per cent of Diamine Fast Yellow A, 10 per cent Glaubersalt, and 1 per cent of soda ash, at 160° F. for one-half hour, then wash and dry. Notice if the two fibers are the same in color, or if the cotton is darker than the wool. The use of an alkaline bath causes the color to go on the cotton better than the wool, as a rule. Borax may also be used for making the bath slightly alkaline, instead of soda ash, and with less injury to the wool fiber in the boiling bath.

(c) *Dyeing the Wool Darker than the Cotton.*—Dye a skein of wool-cotton yarn in a bath containing 2 per cent of Diamine Gold and 10 per cent of Glaubersalt. Boil for one-half hour, then wash and dry, and compare the color obtained on the cotton and wool. These colors, as a rule, dye better on the wool at the boil than on the cotton, while they are taken up in larger proportion by the cotton at lower temperatures.

Exp. 211. Acid Dyes which Leave the Cotton White.—Use a skein of wool-cotton yarn in a bath containing 10 per cent of Glaubersalt, 4 per cent of sulphuric acid, and 1 per cent of dyestuff indicated below; enter at 140° F., gradually raise to the boil and dye for one-half hour at that temperature.

Acid Magenta	Azo Acid Black
Acid Violet 4RS	Guinea Violet 4B
Patent Blue V	Cloth Red GA
Naphthol Yellow S	Alizarine Blue SAE
Orange G	Azo Fuchsine G
Acid Green	Fast Light Yellow G

After dyeing at the boil for one-half hour, add 2 per cent more of sulphuric acid and continue boiling for fifteen minutes. The material should be washed directly after being dyed in order to prevent bleeding into the cotton.

Exp. 212. Dyeing Wool and Leaving Cotton White with Mordant Color, Using Chromium Fluoride.—Dye a union skein of wool and cotton in a bath containing 10 per cent of Glaubersalt, 4 per cent of sulphuric acid, and 2 per cent of Alizarine Red WS; enter at 140° F., gradually raise to the boil and dye for one-half hour; then add 2 per cent

yarn and one or more of cotton yarn to make up a 5-gram or 10-gram test skein as desired. The number of strands of the two fibers should be so selected that about equal amounts of both wool and cotton are present in test skein, unless for special reasons a different proportion is desired. Strips of undyed white cloth containing woolen and cotton yarns may also be used for making the tests.

of chromium fluoride and continue boiling for fifteen minutes. Wash well and dry. Several of the acid alizarine colors may be dyed in this manner.

Exp. 213. Developing with Chrome.—Dye a skein of union yarn in a bath containing 10 per cent of Glaubersalt, 4 per cent of sulphuric acid and 4 per cent of Chromotrope FB; enter at 140° F., gradually raise to the boil and dye for one-half hour; then lift the material from the bath and add 1 per cent of chrome and continue dyeing for fifteen minutes at the boil. Dye another skein in the same manner as the first, but instead of adding the chrome to the dyebath directly, rinse the skein and pass into a fresh bath containing 2 per cent of chrome and oil for fifteen minutes; then wash and dry. Compare the two methods for the amount of color tinting the cotton and the shade obtained on the wool.

Exp. 214. Acid Dyes Taken up by the Wool in a Neutral Bath and not Dyeing the Cotton.—Dye a skein of union yarn in a bath containing 1 per cent of Alkali Blue and 10 per cent Glaubersalt and 2 per cent of borax; enter at 140° F., raise to the boil and dye for one-half hour; rinse slightly and pass into a bath containing 5 per cent of sulphuric acid, and boil for fifteen minutes. Wash well and dry. Dye a second skein of union yarn in a bath containing 10 per cent of Glaubersalt and 1 per cent of Blue for Half-wool. Dye as usual for one-half hour then wash and dry. Dye a third skein of union yarn in a bath containing 10 per cent of Glaubersalt and 1 per cent of Chrome Black B; dye in the usual manner for one-half hour; then wash well and dry. Dye a fourth skein of union yarn in the same manner with 1 per cent of Orange II. These dyes tint the cotton but very little even in neutral baths.

Exp. 215. Substantive Dye Applied in an Acid Bath.—Dye a skein of union yarn in a bath containing 1 per cent of Chrysophenine, 10 per cent of Glaubersalt, and 4 per cent of acetic acid; enter at 140° F., and gradually raise to the boil and dye for one-half hour. Wash and dry and it will be found that both the wool and the cotton are dyed. Such colors are useful for dyeing in connection with the acid dyes which have to be used in an acid bath.

Exp. 216. Production of Two-color Effects in Two Baths with Acid and Substantive Dyes.—Take a skein of wool-cotton yarn and dye it in a bath containing 15 per cent of sodium bisulphate and 1 per cent of the following dyestuffs:

Naphthol Yellow S	Acid Green
Lanafuchsine SG	Naphthol Black (use 6 per cent of this)
Rhodamine B	Azo Red
Formyl Violet S4B	Cyanole
Alizarine Lanacyl Blue B	Brilliant Cochineal 2R

After dyeing these skeins, rinse them in a bath containing a small amount of ammonia; then wash and dye in a second bath containing about 300 cc. of water, 20 per cent of Glaubersalt and 1 per cent each of the following dyes:

- Diamine Fast Yellow A on Lanafuchsine SG.
- Diamine Fast Yellow A on Formyl Violet S4B.
- Diamine Fast Yellow A on Acid Green.
- Benzo Blue 2B on Naphthol Yellow S.
- Benzo Blue 2B on Rhodamine B.
- Diamine Orange D on Alizarine Lanacyl Blue B.
- Diamine Orange D on Naphthol Black.
- Diamine Violet N on Azo Red.
- Diamine Violet N on Cyanole.
- Diamine Catechine G on Brilliant Cochineal 2R.

The second bath is to be used cold. After dyeing rinse in a bath containing a small amount of acetic acid, then wash in fresh water.

Exp. 217. Another Method of Producing Two-color Effects with Two Baths.—(a) Dye two skeins of wool-cotton yarn with 1 per cent of Thioflavine S and 10 per cent Glaubersalt in the usual manner. Wash, and dye one of the skeins in a bath containing 1 per cent of Formyl Violet 10B, and dye the second skein in a bath containing 1 per cent of Azo Rubine. In neutral baths these acid dyes tint the cotton slightly but dye the wool.

(b) Dye two skeins of wool-cotton yarn with 1 per cent of Diamine Sky Blue in the usual manner; wash, and dye one of the skeins in a bath containing 1 per cent of Orange II, and the second skein in a bath containing 1 per cent of Naphthol Yellow S.

(c) Dye two skeins of wool-cotton yarn in a bath of 1 per cent of Diamine Bordeaux, wash, and dye one of the skeins with 1 per cent Naphthol Yellow S, and the second skein with 1 per cent of Formyl Violet 10B.

Exp. 218. Producing Two-color Effects in One Bath.—Prepare a bath containing 300 cc. of water, 20 per cent of Glaubersalt, and 1 per cent of Alizarine Lanacyl Blue R; dye a skein of wool-cotton yarn in this bath at 140° to boil for one-half hour. Then lift the skein, remove the heat and add to the bath 1 per cent of Diamine Fast Yellow A, and dye for one-half hour more without raising the temperature of the bath. Wash and dry. Repeat this experiment, using Naphthol Yellow S, Orange ENZ, Azo Rubine, and Rhodamine for the wool colors, and Diamine Brown M, Diamine Blue 2B, Diamine Orange D, and Diamine Black RO respectively for the cotton color.

Exp. 219. Production of Two-color Effects with Developed Dyes.—Prepare a bath containing 6 per cent of Primuline, 20 per cent of common salt, and 2 per cent of soda; dye a skein of wool-cotton yarn in this bath in the usual manner; rinse, and pass through a cold bath containing 6 per cent of sodium nitrite and 5 per cent of sulphuric acid for fifteen minutes; rinse slightly and pass through a third bath containing 1 per cent of beta-naphthol solution; work cold for ten minutes. Then wash well and soap in a warm dilute soap bath. Next dye the wool in a bath containing 1 per cent of Cyanole and 15 per cent of Glaubersalt and 4 per cent of sulphuric acid; enter at 140° F., raise to the boil and dye for one-half hour. Wash and dry. To obtain a blue on the cotton, dye in the same manner as above but use 1 per cent Diamine Black BH, diazotize, and develop with 1 per cent of Naphthylamine Ether. Wash and soap, and dye the wool as before with 1 per cent of Naphthol Yellow S. To obtain a black on cotton, dye as before with 6 per cent of Diamine Black BH, diazotize, and develop with 1 per cent of phenylene diamine. Wash and soap, and dye the wool with 1 per cent Azo Rubine as before.

Exp. 220. Dyeing Wool Black and Cotton in Colors.—Dye five skeins of wool-cotton yarn with 5 per cent of Acid Black 4BL, 4 per cent of sulphuric acid and 20 per cent of Glaubersalt; boil for one-half hour and then add 2 per cent more of sulphuric acid and boil for fifteen minutes longer. Wash well and squeeze.

(a) Dye the first skein in a bath containing 1 per cent Mikado Orange and 10 per cent of Glaubersalt at 160° F. for one-half hour; then wash well and dry.

(b) Dye the second skein in a bath containing 1 per cent of Brilliant Benzo Blue 6B and 10 per cent of Glaubersalt for one-half hour at 160° F. Wash well and dry.

(c) Dye the third skein in a bath containing 1 per cent of Direct Yellow R and 10 per cent of Glaubersalt for one-half hour at 160° F. Wash well and dry.

(d) Mordant the fourth skein in a bath containing 2 per cent of tannic acid at 160° F. for one-half hour; squeeze and work in a cold bath containing 1 per cent of tartar emetic for fifteen minutes. Wash and dye in a bath containing $\frac{1}{2}$ per cent Brilliant Rhoduline B and $\frac{1}{2}$ per cent of Auramine and 3 per cent of alum. Dye for one-half hour at 180° F. Wash well and dry.

(e) Mordant the fifth skein with tannic acid and tartar emetic as above described; wash, and dye in a bath containing $\frac{1}{4}$ per cent of Turquoise Blue G and 3 per cent of alum for one-half hour at 180° F. Wash well and dry.

Exp. 221. Dyeing Fancy Shades on Wool and Leaving Cotton White.—Take test skeins of wool-cotton yarn and dye them in a bath containing 300 cc. of water, 20 per cent of Glaubersalt, 4 per cent of sulphuric acid, and the respective amounts of the dyestuffs named; enter at 140° F., gradually raise to the boil, dye at that temperature for one-half hour, then add 2 per cent more of sulphuric acid, and continue boiling for fifteen minutes. Finally wash well and dry. Use the following combinations of dyes:

- (1) 0.05 per cent Alizarine Blue SAE;
0.15 per cent Fast Light Yellow G;
0.07 per cent Azo Crimson S;
- (2) 0.03 per cent Alizarine Blue SAE;
0.25 per cent Fast Light Yellow G;
0.15 per cent Azo Crimson S;
- (3) 0.50 per cent Alizarine Blue SAE;
1.00 per cent Fast Light Yellow G;
0.70 per cent Azo Crimson S;
- (4) 0.32 per cent Alizarine Blue SAE;
0.14 per cent Fast Light Yellow G;
0.18 per cent Azo Crimson S;
- (5) 0.30 per cent Alizarine Blue SAE;
0.75 per cent Fast Light Yellow G;
0.20 per cent Azo Fuchsine G;
- (6) 0.50 per cent Alizarine Blue SAE;
0.03 per cent Orange II;
0.02 per cent Fast Light Yellow G;
- (7) 2.50 per cent Victoria Navy Blue B;
0.15 per cent Orange II;
- (8) 6.00 per cent Acid Black 4BL;
- (9) 0.10 per cent Alizarine Blue SAE;
0.08 per cent Azo Fuchsine G;
0.07 per cent Fast Light Yellow G;
- (10) 0.08 per cent Alizarine Blue SAE;
0.17 per cent Fast Light Yellow G;
0.08 per cent Azo Crimson S.

Exp. 222. Dyeing Cotton in a Cold Bath and Leaving Wool Undyed.—Take test skeins of wool-cotton yarn and dye them in baths containing 300 cc. of water, 10 cc. of soap solution (50 grams per liter) and 1 per cent each of the following dyes:

Erica BN	Heliotrope 2B
Brilliant Orange S	Columbia Black HWD
Chrysophenine	Zambesi Black D
Chicago Blue 6B	Columbia Blue G

Enter cold and work for one-half hour without heating. Then wash well and dry.

By this method the cotton becomes dyed almost as well as if in a boiling bath, while the wool is only dyed to a very slight degree.

Exp. 223. Dyeing the Cotton Black and the Wool in Colors.—Dye test skeins of wool-cotton yarn in baths containing 250 cc. of water, 6 per cent of Columbia Black FB, 20 per cent of Glaubersalt, and 3 per cent of soda ash; dye for half an hour at 140 to 160° F., then rinse well and squeeze. Dye five skeins in this manner. Now dye the wool with acid colors, as follows: Use a bath containing 300 cc. of water, 10 per cent of Glaubersalt, 6 per cent of sulphuric acid, and 1 per cent each of the following dyes:

Formyl Violet 10B
Acid Violet

Naphthol Yellow
Acid Green

The fifth skein is to be left with the wool undyed.

Exp. 224. Dyeing Cotton in a Cold Bath with Substantive Colors, and Subsequently Dyeing the Wool with Basic Colors.—Dye five test-skeins of union yarn in baths containing 300 cc. of water, 10 cc. of soap solution (containing 50 grams of soap per liter), and 1 per cent of Chrysophenine. Enter cold, and work for one-half hour without heating; then wash well. This will dye the cotton a yellow color and leave the wool practically white. Now dye these skeins in baths containing 300 cc. of water, 3 per cent of acetic acid, and the following respective dyestuffs; enter cold and gradually raise to 180° F., and continue at that temperature for one-half hour, then wash well and dry.

(1) Use $\frac{1}{2}$ per cent of Methylene Blue.

It will be found that the basic color at this percentage is mostly taken up by the cotton, the substantive dyestuff on the cotton acting as a mordant towards the basic color.

(2) Use 1 per cent of Methylene Blue.

It will be found that the wool is now dyed to some extent by the basic color as well as the cotton.

(3) 2 per cent of Methylene Blue.

This should dye the wool a blue and the cotton a green color.

(4) Use $\frac{1}{2}$ per cent of Methyl Violet 4R.

(5) Use 2 per cent of Methyl Violet 4R.

Dye another set of five union skeins in the same manner as above described, using 1 per cent of Chicago Blue 6B in the first bath for the dyeing of the cotton, and then in the second baths use respectively:

(1) $\frac{1}{2}$ per cent Safranine.

(2) 2 per cent of Safranine.

(3) $\frac{1}{2}$ per cent of Auramine.

(4) 2 per cent of Auramine.

(5) 2 per cent of Rhodamine.

Exp. 225. Dyeing the Cotton in a Cold Bath with Substantive Colors, and Subsequently Dyeing the Wool with Acid Colors.—Dye five test skeins of union yarn in baths containing 300 cc. of water, 10 cc. of soap solution (containing 50 grams of soap per liter), and 1 per cent of Chrysophenine. Enter cold and work for half an hour without heating, then wash well. This will dye the cotton a yellow color and leave the wool practically white. Now dye these skeins in baths containing 300 cc. of water, 4 per cent of sulphuric acid, and the following respective dyestuffs; enter at 140° F., gradually raise to the boil, and continue at that temperature for one-half hour; then wash well and dry.

(1) Use $\frac{1}{2}$ per cent Alizarine Blue SAE.

(2) Use 2 per cent of Alizarine Blue SAE.

(3) Use 1 per cent Azo Crimson S.

(4) Use 1 per cent Azo Fuchsine G.

(5) Use 2 per cent Acid Black 4BL.

Dye another set of five union skeins in the same manner as above described, using 1 per cent Chicago Blue in the first bath for the dyeing of the cotton, and then in the second baths use respectively:

(1) 1 per cent of Naphthol Yellow.

(2) $\frac{1}{2}$ per cent Alizarine Blue SAE and $\frac{1}{2}$ per cent Naphthol Yellow.

(3) 1 per cent Acid Black 4BL.

(4) $\frac{1}{2}$ per cent Orange II.

(5) 1 per cent Azo Crimson S.

Exp. 226. Dyeing Two-color Effects in One Bath with Substantive and Acid Dyes.—

(1) Dye a skein of union yarn in a bath containing 300 cc. of water, 20 per cent salt, 2 per cent of Mikado Yellow and 2 per cent of Guinea Violet; enter at 140° F., gradually raise to the boil and dye at that temperature for one-half hour; wash well and dry.

(2) Repeat the above test, but dye at a temperature of 160° F. for one-half hour; wash and dry.

(3) Dye a skein of union yarn in a bath containing 300 cc. of water, 20 per cent of salt, 2 per cent of Curcumine S, and 2 per cent of Ponceau 2RB; enter at 140° F., gradually raise to the boil, and dye at that temperature for one-half hour; wash well and dry.

(4) Repeat the above experiment, using as the dyestuffs 2 per cent of Curcumine S and 1 per cent of Rhodamine.

(5) Repeat the above experiment, using as the dyestuffs 2 per cent of Guinea Green B and 2 per cent Mikado Yellow.

Exp. 227. Dyeing Single Shades on Both Wool and Cotton in One Bath.—(1) Dye a skein of union yarn in a bath containing 300 cc. of water, 20 per cent of Glaubersalt, 2 per cent of Benzopurpurine 4B, 0.8 per cent Congo Rubine, and 2 per cent of Fast Red A; enter at 140° F., gradually raise to the boil, and dye at that temperature for one-half hour; wash well and dry.

(2) Dye a skein of union yarn in the same manner as above using as the dyestuffs 0.15 per cent Curcumine S, 0.15 per cent Zambesi Black D, and 0.03 per cent Curcumine extra.

(3) Use 0.45 per cent Curcumine S, 0.45 per cent Zambesi Black D, and 0.09 per cent Curcumine extra.

(4) Use 1.4 per cent Curcumine S, 1.4 per cent Zambesi Black D, and 0.3 per cent Curcumine extra.

(5) Use 0.15 per cent Zambesi Black D, 0.15 per cent Columbia Fast Blue 2G, 0.10 per cent Wool Blue 2B, and 0.04 per cent Wool Black 6B.

(6) Use 1.2 per cent Columbia Violet R, 0.2 per cent Columbia Blue R, and 0.28 per cent Guinea Violet 4B.

(7) Use 0.8 per cent Zambesi Black D, 1.2 per cent Mikado Orange 4RO, 0.3 per cent Curcumine S, 0.15 per cent Mandarin G extra, and 0.12 per cent Curcumine extra.

(8) Use 1.8 per cent Columbia Brown R, 2 per cent Mikado Orange 4RO, and 0.4 per cent Mandarin G extra.

(9) Use 0.5 per cent Curcumine S, 0.1 per cent Zambesi Black D, and 0.1 per cent Curcumine extra.

(10) Use 2 per cent Curcumine S, 0.4 per cent Zambesi Black D, and 0.2 per cent Curcumine extra.

15. Dyeing of Wool-silk Materials.—Wool and silk fibers are not spun together into yarns owing to the very different physical characters of the two fibers, but there are quite a variety of fabrics made from separate yarns of wool and silk. Sometimes plain woven fabrics of this character are to be met with in which the warp is of wool and the filling of silk (or vice versa) or again, the two fibers may be used to produce pattern effects, and there are fabrics for suitings and dress-goods made principally of wool (or worsted) with silk effect threads. Knitted fabrics are also made from wool and silk for underwear and hosiery.

A widely used fabric of wool and silk is known under the name of *Gloria*, and it is largely employed in the making of umbrella cloth, rain-

coat material, and ladies' dress-goods. Another fabric known as *Poplin* has a silk warp and a fine wool filling; there is also a half-silk *Cashmere* and *Bombazine*, both of which have silk warp and wool filling. *Crêpe de Chine* is a similar fabric of great popularity.

Frequently the silk yarn employed in such fabrics has not been completely boiled-off previous to weaving, so that it still contains a considerable amount of silk-glue. On this account it becomes necessary to boil-off the goods before dyeing, and this is done in a strong neutral soap bath at a temperature of about 190° F. The use of alkali and a high temperature must be avoided in order to preserve the wool from injury. If spun silk has been used or if the silk has been boiled-off previous to weaving, of course, the process of boiling-off the piece is to be omitted.

The dyeing properties of wool-silk materials are far different from those of wool-cotton goods, owing to the fact that both wool and silk possess approximately the same relations to dyestuffs. That is to say, those dyes which can be applied to silk are also applicable to wool and in about the same manner; there are, however, certain dyes which are satisfactory for wool which do not dye well on silk. In most cases both the wool and the silk are dyed, though one fiber may receive a heavier or a somewhat different tone of color. Then there are certain cases where the wool takes up the dye alone, leaving the silk practically unstained.

In the dyeing of wool-silk goods the temperature of the dyebath plays an important part in the production of uniform colors; as a general rule, the wool dyes best in a boiling bath while the silk dyes better at lower temperatures or even in a cold bath, so that by dyeing in an unheated bath it is sometimes possible to dye the silk while leaving the wool practically undyed.

For the dyeing of wool-silk materials the acid, basic, and substantive colors are the principal ones employed at the present time. In former years the natural dyewoods were used considerably, but such satisfactory dyes are now available among the above-named classes that it is seldom that the mordant dyes are used for this class of material. The following dyeing processes come into consideration:

(1) *Dyeing with Acid Dyes to Produce a Uniform Color on Both Fibers.*—Prepare a dyebath containing the well-dissolved color with the addition of 5 to 10 per cent of Glaubersalt and 1 to 3 per cent of sulphuric acid (5 to 10 per cent of sodium bisulphate may be used instead). Run the goods for one hour, starting at 160° F. and gradually bringing to the boil. If the color does not come up to a match on the silk it may be shaded with a basic dye by allowing the bath to cool down, add the necessary well-dissolved basic dyestuff and run the goods for fifteen minutes, then rinse well.

(2) *Dyeing with Acid Dyes, Leaving the Wool Undyed.*—Prepare the bath with 5 per cent of acetic acid and run the goods in the cold bath for

one-half to one hour. In carrying out this process a proper selection of dyes must be made to obtain the best results.

(3) *Dyeing with Alkali Blue.*—Prepare the bath with 10 per cent of borax and dye for one hour at 180 to 195° F. Then rinse and run the goods through a lukewarm bath containing 5 per cent of sulphuric acid.

(4) *Dyeing with Acid Dyes, Leaving the Silk Undyed.*—Prepare the bath with 20 per cent of acetic acid and dye at the boil for one hour. Rinse well and then treat the goods for one-half hour at 100° F. in a bath containing wheat bran, which serves to clear up the silk. Then rinse well again and scroop by passing through a bath containing 5 per cent of acetic acid

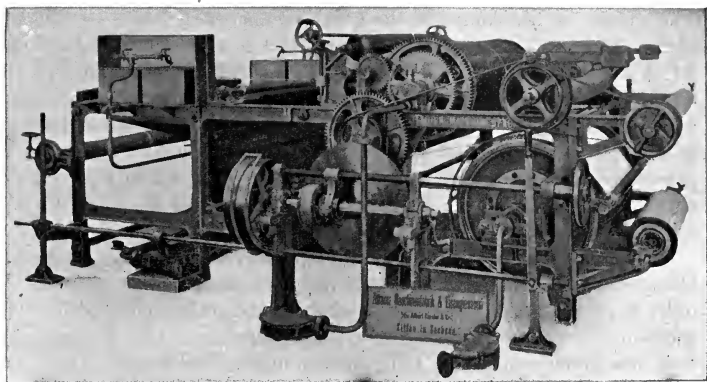

FIG. 270.—Machine for Finishing Half-silk Pieces.

and drying without washing. In this case also it is necessary properly to select the dyestuffs in order to obtain good results.

(5) *To Produce Two-color Effects.*—Dye the wool as above described, leaving the silk white, and then dye the silk in a different color by the use of suitable basic or acid colors, employing a bath containing 3 to 5 per cent of acetic acid at a temperature of 70 to 80° F.

(6) *Dyeing with Basic Dyes to Produce a Uniform Color on Both Fibers.*—Use a neutral bath and dye at the boil for one hour. Most of the basic colors (exceptions are Magenta and Chrysoidine) dye the silk much heavier than the wool if an acid bath is used (3 per cent of sulphuric acid and 10 per cent of Glaubersalt), so this latter process may be used either for shading the silk or for the production of two-color effects.

(7) *Dyeing with the Substantive Colors.*—Use a bath containing 10 to 20 per cent of Glaubersalt and dye at the boil for one hour. To obtain a

uniform shade it is necessary to make a proper selection of the dyes to be used, and in some cases it is necessary to boil the goods for a considerable time in order to even up the color. Should the wool come up too light add 1 to 2 per cent of acetic acid and continue the boiling.

In the dyeing of suiting cloths with white silk-effect threads, in order to obtain the silk clear and bright it is essential that the dyebath should have a low acidity and a high temperature. In this class of goods owing to the high degree of fastness usually required the number of dyestuffs which are suitable is rather limited. The acid chrome colors are to be recommended for this purpose, especially those which dye by the one-bath meta-chrome method, though the clearest silk-effect threads are probably obtained by first chroming the goods and then dyeing in a separate bath. The goods are mordanted in the usual manner with 2 to 3 per cent of chrome and 2 to 3 per cent of tartar, or with 1 to 2 per cent of chrome and 1 to 3 per cent of formic acid, then rinsed and dyed in a fresh bath with the addition of 2 to 5 per cent of acetic acid or of 5 per cent of ammonium acetate in the case of light shades. The goods are entered at 100° F., gradually raised to the boil and boiled for two hours. With heavy shades it is usually required after boiling for one hour to add 2 to 4 per cent of acetic acid in order to exhaust the bath. After dyeing the goods are well rinsed and soured off with acetic or formic acid.

Where heavy shades are dyed, and especially in the case of black, it is almost impossible to prevent the silk from becoming slightly stained. In order to clear the silk a number of methods are recommended. The goods may be run in a fresh bath for twenty minutes at 175° F. containing 1 oz. ammonium oxalate per 100 gallons of liquor, then rinsed. Or a more effective stripping may be obtained by using a bath containing 2 ozs. ammonium acetate per 10 gallons of liquor. By this method, however, some of the color on the wool will also be stripped and this must be allowed for. In the case of some blacks the silk assumes a slightly bluish gray shade, which may be removed by treatment with hydrosulphite as follows: Use a bath containing 3 gallons acetic acid (30 per cent) and 5 gallons hydrosulphite solution (prepared from 1 gallon of sodium bisulphite 66° Tw., 1 gallon cold water, and 1 lb. zinc dust; stir, settle and use clear solution) for 100 lbs. of goods. Run in this bath at 120 to 140° F. for one-half hour, then rinse well and sour off in a bath containing 5 per cent of sulphuric acid and rinse again.

16. Classification of Dyes for Wool-silk Fabrics.—Most of the acid dyes give approximately the same color on both fibers, but certain of these dyes behave differently on the two fibers. The following may prove of practical interest:

- (a) Acid dyes which only slightly stain the silk in a boiling acid bath.
- (b) Acid dyes which dye only the silk in an acid bath at 120° F.

(c) Substantive dyes which dye both silk and wool approximately alike in a boiling bath.

(d) Substantive dyes which only slightly stain the silk in a neutral boiling bath.

(e) Basic dyes useful for dyeing or shading the silk to produce shot effects in an acetic acid bath at 120° F., the wool being scarcely stained.

(A) Acid Dyes not Dyeing the Silk in Boiling Acid Bath

Acid Green	Fast Light Yellow 3G
Acid Magenta	Fast Red NS
Acid Violet 3RS	Fast Yellow S
Acid Yellow G	Flavazine T
Acid Yellow AT	Guinea Red 4B
Alizarine Blue SAP	Indigo Extract
Amaranth	Indigo Carmine
Azo Acid Carmine B	Lanafuchsine SG
Azo Cochineal	Mars Red G
Azo Crimson L, S	Metanil Yellow
Azo Fuchsine B, G	Naphthol Green B
Azo Rubine SG	Naphthol Red C, O
Azo Wool Blue C	Naphthol Yellow
Azo Wool Violet 7R	Naphthylamine Black
Benzyl Red S	New Coccine
Bordeaux S	New Fast Yellow R
Brilliant Cochineal 2R	Orange II
Brilliant Scarlet 4R	Orange G
Chromotrop 2R, 2B	Ponceau S for Silk
Cochineal Scarlet PS	Sorbine Red
Crystal Scarlet 6R	Tartrazine
Cyanole FF	Victoria Rubine O
Direct Rose BN, GN	Victoria Scarlet 3R
Eosamine B	Victoria Violet 4BS
Eosin 3G, BN	

(B) Acid Dyes not Dyeing the Wool in Cold Acid Bath

Acid Green	Fast Acid Magenta G
Acid Magenta	Fast Acid Phloxine A
Acid Violet 4B, 6BN, HW	Fast Blue B, R
Acid Violet 6BS	Fast Red extra
Alkali Violet LR	Formyl Blue B
Amaranth B	Formyl Violet S4B, 10B
Azo Acid Yellow	Guinea Green B
Azo Orseille 2B	Guinea Violet 4B
Brilliant Croceine	Lanafuchsine SG
Brilliant Milling Blue B	Mandarine G
Brilliant Milling Green B	Methyl Blue
Croceine AZ	Milling Red FR
Fast Acid Eosine G	Milling Yellow OO
Fast Acid Green BN	Naphthalene Green V

Naphthol Blue Black	Tropeoline RPN
Naphthol Blue G	Victoria Rubine O
Naphthol Red O	Violamine G, R, B
Naphthylamine Black ESN	Water Blue B
Ponceau 10RB, 4RB, 2GB	Wool Blue
Rosazeine B	Wool Blue TB
Tetra Cyanole V	

(C) Acid Dyes Which Dye Wool and Silk about the Same Shade in a Strongly Acid Bath

Acid Rhodamine R	Formyl Violet S4B
Acid Rosamine	Gloria Black B
Acid Violet 4RN, 3BN, 7B	Guinea Green B, G
Agalma Green B	Guinea Violet 4B
Alkali Blue	Indian Yellow
Alkali Violet LR	Indocyanine B
Anthracene Red	Irisamine G
Anthracite Black BR	Light Blue for Silk
Azo Acid Yellow	Light Green SF
Azo Cardin 1 G	Mandarine G
Azo Carmine G	Martius Yellow
Azo Cocchine 2R	Metanil Yellow
Azo Flavine	Naphthylamine Black 4B
Azo Orseille 2B	Neptune Blue R, B, BG
Azo Yellow O	Neptune Green S, SG
Benzyl Green B	Neutral Wool Black B, G, 4F
Bordeaux extra	Orange II
Brilliant Acid Green 6B	Orange EN
Brilliant Croceine	Palantine Black 4BS, MZ
Brilliant Millin Blue B	Patent Blue, A, V
Brilliant Milling Green G	Phloxine
Brilliant Silk Blue 10B, 7B	Ponceau 3RB
China Yellow B	Quinoline Yellow
Chinaldine Yellow	Resorcine Brown
Chrysoin	Rhodamine B
Cloth Red 3GA	Rocceline
Croceine AZ	Rosazeine B
Curcumeine	Silk Black 4BF
Cyanole Fast Green G	Silk Red N, G, R
Double Brilliant Scarlet G	Sulphon Cyanine Black
Emin Red	Tetra Cyanole A
Fast Acid Violet R, B	Victoria Black B, G
Fast Blue B, R	Victoria Blue B
Fast Brown G, GR	Victoria Yellow C
Fast Light Green	Wool Black GR
Fast Light Yellow G	Wool Blue SL
Fast Red	Wool Green S
Fast Scarlet	Wool Violet 10B
Formyl Blue B	

(D) Substantive Dyes Dyeing Silk and Wool Alike

Acetylene Blue 6B	Diamine Fast Yellow FF
Benzo Chrome Brown B, R	Diamine Gray G
Benzo Dark Green B, 2G	Diamine Green B, G, CL
Benzo Fast Black	Diamine New Blue R, G
Benzo Fast Orange S	Diamine Orange B, F
Benzo Fast Red L, GL	Diamine Red B
Benzo Fast Scarlet GS	Diamine Red 4B
Benzo Green 2B, G	Diamine Rose BB, GD
Benzopurpurin 4B	Diamine Scarlet B, 3B
Benzo Rhoduline Red B	Diamine Sky Blue FF
Benzo Sky Blue	Diamine Steel Blue L
Benzo Violet R, RL	Diamine Yellow CP
Brilliant Benzo Blue 6B	Diamineral Brown G
Brilliant Benzo Green B	Dianil Black CR, N, R, E
Brilliant Congo R	Dianil Blue G, B, R
Brilliant Diamine Bordeaux R	Dianil Brown 3GO, R, BD
Brilliant Purpurine R	Dianil Claret Red G, B
Carbide Black E	Dianil Orange G
Chicago Blue 6B, B, RW, R	Dianil Red 4B
Chloramine Violet R	Dianil Yellow 3G, R, 2R
Chloramine Yellow M	Diazo Blue Black
Chlorantine Lilac B	Direct Brown R
Chrysophenine G	Direct Deep Black E, EW, R
Congo Blue BX	Direct Light Blue
Congo Brown G, R	Direct Orange G, R
Congo Orange, G, R	Direct Sky Blue
Congo Orange R	Geranine G
Congo Sky Blue	Oxy Diamine Black JW, JB
Cotton Yellow CH	Oxy Diamine Black SOOO
Cupranil Brown B	Oxy Diamine Blue, B, R, G
Delta Purpurine 5B	Oxy Diamine Brown G, 3GN
Diamine Black HW	Oxy Diamine Violet B, R
Diamine Blue RW	Oxy Diamine Yellow TZ
Diamine Bordeaux S	Pluto Brown R
Diamine Brilliant Blue G	Pluto Orange G
Diamine Brown 3G, R, V, M	Silk Black
Diamine Cutch G	Sulphon Cyanine G, GR, 3R
Diamine Dark Green N	Thioflavine S
Diamine Fast Brown G, R	Zambesi Black D
Diamine Fast Red F	

Prolonged boiling causes these dyes to go more strongly on the wool, while the silk is dyed to best advantage at about 140° F.

(E) Substantive Dyes not Dyeing the Silk

Erica BN	Columbia Violet R
Columbia Blue G, R	Heliotrope 2B

(F) Basic Dyes for Shading the Silk, not Dyeing the Wool

Auramine	Methylene Green
Bismarck Brown	Methylene Violet
Brilliant Green	New Blue D
Brilliant Rhoduline Red B	New Methylene Blue N
Brilliant Safranine	Paraphosphine G
China Green	Rhodamine B, G, 6G
Chrysoidine F	Rhoduline Blue R
Cotton Green	Rhoduline Heliotrope B
Ethyl Green	Rhoduline Red B, G
Janus Black O	Rhoduline Sky Blue 2B
Janus Blue G, R	Rhoduline Violet
Janus Brown R, B	Rosolane O, T
Janus Gray B	Rubine
Janus Green G, B	Safranine
Janus Red B	Solid Green
Janus Yellow G, R	Tannin Heliotrope
Jute Coal Black F, R	Tannin Orange R
Malachite Green	Thioflavine T
Methyl Violet	Turquoise Blue 2B G
Methylene Blue	Victoria Blue

17. Silk-cotton Materials.—There are a large variety of silk fabrics which are constructed in part with cotton yarns. The fabric is usually so woven that the cotton appears only on the back, thus leaving an all-silk surface on the other side. Familiar examples of such fabrics are ribbons,

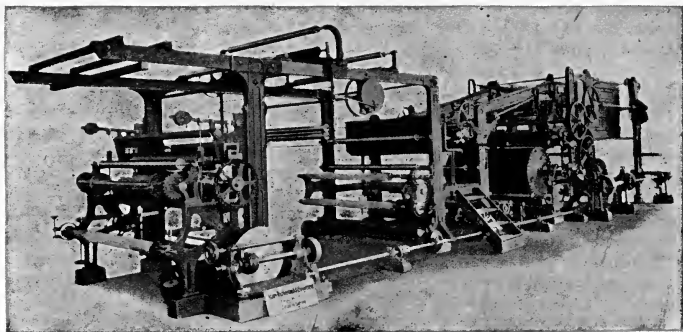

FIG. 271.—Machine for Fouldarding, Stretching and Drying.

satins, brocades, silk upholstery materials, etc. Silk knitted goods are also made up with considerable cotton at times; hosiery and underwear, for instance, may have a cotton thread spliced with the silk and knitted

together; or in the case of hosiery, part of the fabric may be all-silk (the leg part) while other parts are of cotton (the foot and upper portion). The cotton used with the silk may be the ordinary variety or more generally it may be mercerized cotton. In the latter case the distinction between the two fibers is less apparent, as the mercerized cotton has considerable luster and silky feel. Artificial silk is also very largely used in admixture with true silk both in knitted fabrics and in a wide variety of fancy fabrics. As artificial silk is a cellulose fiber, and its dyeing properties are practically the same as cotton, it will be considered in this same connection.

Silk-cotton fabrics are more generally required to be dyed so that both the fibers have the same color, though at times the object is to produce two color effects, the silk being dyed one color while the cotton may be dyed in a strongly contrasting color. On referring to the relations of these two fibers to the various classes of dyes it will be noticed that the basic colors dye the silk directly, leaving the cotton undyed unless it has been previously mordanted with tannin and tartar emetic. The acid dyes also dye the silk directly from acid baths, in some cases even in the cold, while they leave the cotton less stained even than with the basic dyes. The substantive colors, on the other hand, in many cases dye both fibers alike, though some of the substantive colors may be dyed on the cotton while leaving the silk practically undyed. Some of the diazotized and developed colors also may be used as they dye both fibers practically alike. The mordant dyes have no application for silk-cotton fabrics.

18. Dyeing of Silk-cotton Fabrics.—Material of this character usually comes into the hands of the dyer in a form all ready to be dyed; if, however, the fabric has been prepared from raw silk, it will be necessary to first boil-off the silk before dyeing. This is done in the customary manner by boiling in a bath containing about 30 per cent of soap, and according to the amount of gum on the fiber the treatment should last from one-half to two hours. In cases where light delicate colors are to be dyed it may be necessary to bleach the goods, and this is usually done by steeping in a bath of hydrogen peroxide in the customary manner of bleaching silk by this process.

In the dyeing of silk-cotton materials the character of the fabric has much to do with the method to be employed. In the case of satins, atlas cloth, etc., in which only the silk appears on the right side of the goods, the dyeing of the silk is the most important feature, the color of the cotton is of subsidiary importance, and it often matters very little as to whether the cotton is exactly the same shade as the silk or not. In fabrics in which the silk appears as a pattern on a cotton background, or as silk-effect threads in an otherwise all-cotton fabric, the lustrous silk fiber will show a contrasting effect even if dyed the same shade with the dull-appearing cotton,

and this contrast can be further accentuated by dyeing the two fibers in different colors. In some cases even one of the fibers may be left undyed as a pattern of effect thread.

If it is desired to dye only the silk and leave the cotton white, the dyeing is best carried out with suitable acid colors in a strong acetic (or formic) acid bath cold or lukewarm. If, on the other hand, it is desired to leave the silk white and dye only the cotton, then suitable substantive dyes are selected which dye only on the cotton in a strongly alkaline bath. At the present time, owing to the simplicity of the methods of application, the substantive dyes are by far the most important colors for use on silk-cotton goods; next to these are the acid dyes, while the basic dyes are of very minor importance. Formerly this material was quite extensively dyed by mordanting the cotton with tannin and tartar emetic, rinsing, and dyeing with basic colors, first cold and then warm, so that both fibers will be evenly covered. This method, however, is now scarcely ever employed in practice.

Another process devised by Moyret was as follows: The fabric was padded with Turkey-red oil neutralized with ammonia and then dried for twenty-four to forty-eight hours. The excess of oil was then removed by treatment with a cold dilute bath of soda ash, after which the goods were washed and brightened with hydrochloric acid and well washed again. On dyeing the material now with basic colors it will be found that the cotton will take up the color as well as the silk; also the oil gives the goods a desirable feel. After dyeing, the goods are dried without washing, as the color on the cotton is not fast to washing.

19. Dyeing Processes.—While the one-bath process of dyeing silk-cotton goods is probably the one most in vogue at the present time, there are besides a variety of other processes which may be enumerated as follows:

(1) *Dyeing only the Silk, Leaving the Cotton White.*—Use a bath containing a suitable acid dyestuff, together with 10 per cent of acetic acid; run the goods for about one hour at about 175° F. Wash well, and if necessary to whiten up the cotton and free it from stains pass through a very weak cold bath of chloride of lime, then sour in weak acetic acid and wash thoroughly.

(2) *Dyeing with Substantive Colors so that both Fibers are of the Same Shade.*—Prepare a bath containing dyestuff, 10 to 20 per cent of Glaubersalt and 5 to 10 per cent of soap; run for one hour at 180° F., then rinse and brighten with acetic acid. A proper selection of dyes must be made in this case to produce the desired effect, as many of the substantive colors dye best on the silk, while a few give heavier shades on the cotton. In many cases it will be necessary to shade the silk in a second bath containing a suitable acid dyestuff with the addition of 5 per cent of acetic acid.

(3) *Dyeing with Substantive Colors so that the Silk is Left Undyed.*—Prepare the dyebath with the properly selected dyestuff with the addition of 20 per cent of soap and 5 per cent of soda ash, and dye for one hour at 190° F. Rinse well and brighten with acetic acid. Only certain of the substantive dyes are suitable for this process.

(4) *Production of Two-color Effects.*—The cotton may first be dyed as described above with a substantive dye in an alkaline bath, and then

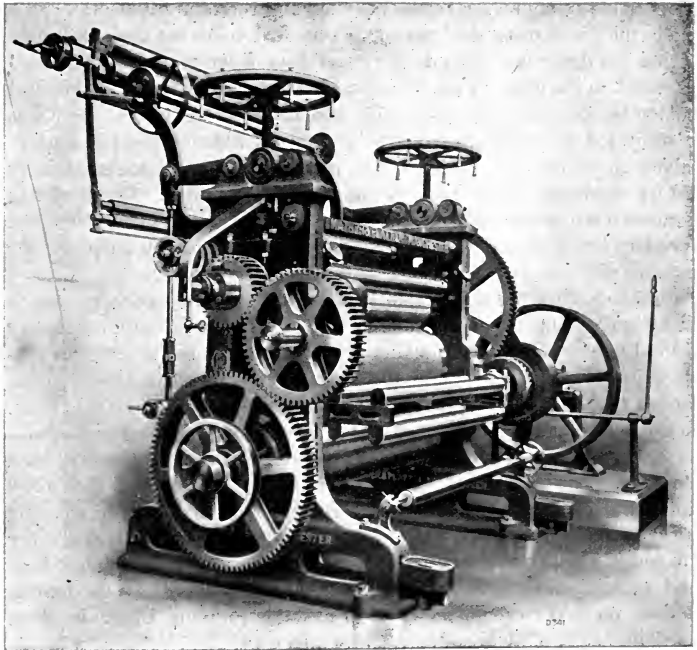

FIG. 272.—Three-Bowl Heavy Friction Calender. (Mather & Platt).

the silk is dyed with a suitable basic dyestuff at 85° F. in a bath containing 4 ozs. acetic acid per 10 gallons of liquor. The basic color will also be taken up to some extent by the dyed cotton, as the substantive dye will act as a mordant for the basic color, so that due allowance must be made for this fact in the production of the effects desired. In another process the cotton may be dyed first with the proper substantive color and then the silk is dyed in a fresh bath with an acid dye in a boiling bath containing 5 per

cent of sulphuric acid. Of course in this case it will be necessary to use a substantive dye for the cotton that is fast to acid (cross-dyeing). Also the goods must be well washed after dyeing and soaped in order to neutralize the acid, which might otherwise tender the cotton.

Plush fabrics consisting of a silk pile surface and a cotton backing form one of the most important silk-cotton materials. These goods usually have to be dyed in special apparatus in order to preserve the silk pile from injury and streaks. In this case the cotton is very often first dyed in the warp with suitable sulphur dyes before weaving, and then the silk is afterwards dyed in the piece, using acid dyes or if very fast colors are desired, Indigo or other vat dyes may be used, or even certain of the mordant colors may be applied to the silk. A similar fabric is made from a tussah silk pile and a cotton backing and after dyeing (or sometimes before dyeing) the goods are subjected to certain mechanical treatments whereby the pile surface is given an effect resembling a fur or pelt. These goods are extensively used for cloakings, trimmings, etc., as artificial fur cloth. Goods of this character often present difficult problems to the dyer and finisher in order to produce a uniform and satisfactory color and also to obtain the particular character of finish on the pile surface that is desired.

Blacks are sometimes produced on silk-cotton goods (especially ribbons and satins) by the use of the sulphur colors. The color obtained is very fast and is almost equal in quality to that of Aniline Black. The dye-bath is prepared as follows: For 10 gallons of liquor use 1 to 2 lbs. Sulphur Black, 1 to 2 lbs. sodium sulphide, 3 to 4 lbs. glucose, 3 ozs. soda ash, 3 ozs. Turkey-red oil and $\frac{1}{2}$ to 1 lb. glaubersalt (desiccated). Dye the goods for one to one and one-half hours at a temperature just under the boil, then squeeze, rinse in cold water containing a little soda ash and then rinse again in warm water. Then treat the goods for one-half hour in a boiling bath containing 3 per cent of chrome, 2 per cent lactic acid and 5 per cent acetic acid; rinse and dye in a fresh boiling bath containing Log-wood extract and soap, using a little Fustic if necessary for toning. Another method recommended is to use the Sulphur Black in a vat containing sodium hydrosulphite and glaubersalt.

Attempts have also been made to dye Aniline Black on silk-cotton goods such as ribbons and satins, and more or less success has been achieved, but the conditions of dyeing have to be so accurately regulated in order to obtain proper results and prevent injury to the silk that the processes have never proved to be of practical value.

20. Classification of Dyes for Silk-cotton Materials.—The following tables of dyestuffs give the principal colors and their properties with respect to the dyeing of silk-cotton fabrics:

(A) Substantive Dyes Which Leave the Silk Undyed at 200° F.

Acetylene Blue 3B, 6B	Diamine Sky Blue FF
Benzo Blue 2B	Dianil Blue G, B, R
Benzo Chrome Black Blue B	Dianil Dark Blue R
Benzo Fast Pink 2BL	Dianil Direct Yellow S
Benzo Fast Scarlet 5BS, GS	Dianil Orange G
Benzo Sky Blue	Diazo Black BHN
Brilliant Azurine B, 5G, 5R	Diazo Blue Black
Brilliant Benzo Blue 6B	Direct Blue 2B
Chicago Blue 6B	Direct Gray R, B
Chloramine Orange G	Direct Indigo Blue BN, BK
Chloramine Yellow GG	Direct Light Blue
Chlorantine Blue B	Direct Sky Blue
Chlorantine Lilac B	Direct Violet N
Chlorantine Orange TR	Direct Yellow R
Chlorantine Pure Blue	Direct Yellow T
Chlorantine Red 4B, 8B	Erica
Chlorantine Rose	Mikado Golden Yellow 8G
Chlorantine Yellow JJ, JG	Mikado Orange
Columbia Black, HWD	Mikado Orange GO, 4RO
Columbia Blue G, R	Mikado Yellow
Columbia Fast Blue 2G	Oxamine Black
Columbia Fast Scarlet 4B	Oxamine Blue B, GN
Congo Fast Blue HW	Oxamine Brown 3G
Congo Sky Blue	Oxamine Copper Blue 2R
Cotton Brown RN	Oxamine Dark Blue BG
Cotton Orange RG	Oxamine Pure Blue 5B
Cotton Red 4B	Oxy Dianil Yellow O
Curcumine S	Phenamine Blue G
Diamine Black BH	Pluto Black F
Diamine Blue 2B	Pluto Black G (dev.)
Diamine Fast Scarlet 2G, 4BN, 6BS	Pyramine Orange R
Diamine Fast Yellow A	Solamine Blue B, R
Diamine Orange D, G	Solamine Blue FF
Diamine Pure Blue A	Thiazine Brown G, R
Diamine Rose T	Zambesi Black BR

(B) Substantive Dyes Which Dye Cotton and Silk alike in a Bath with Glaubersalt and Soap at 200° F.

Aurophenine O	Benzopurpurine 4B
Benzo Blue RW	Benzo Rhoduline Red
Benzo Bordeaux 6B	Benzo Violet RL
Benzo Brown D3G	Brilliant Benzo Green B
Benzo Chrome Brown B, 3R	Brilliant Geranine B
Benzo Cyanine B	Brilliant Purpurine 10B
Benzo Dark Green B, 2G	Chicago Blue 2R
Benzo Fast Black	Chloramine Violet R
Benzo Fast Blue 5R	Chloramine Yellow M
Benzo Fast Red GL	Chrysamine G, R
Benzo Fast Yellow 5GL	Chrysofenine G

Columbia Black 2BW	Diamine Scarlet B, 3B
Columbia Black EA, WA	Diamine Steel Blue L
Columbia Black Green D	Diamine Violet Red
Columbia Orange R	Diamine Yellow CP, N
Congo Corinth B, G	Diamineral Blue B
Congo Orange R	Diamineral Brown G
Congo Orange R, G	Diaminogene B, BR
Congo Rubine	Dianil Brown 3GO
Cotton Red 12B, 4B	Direct Deep Black E, EW
Cotton Yellow CH	Direct Green C, G, J
Cresotine Yellow G	Direct Orange G, R
Cupranil Brown B, R, G	Direct Rose BN, GN
Delta Purpurine 5B	Direct Yellow CR
Diamine Bengal Blue G	Geranine G
Diamine Black BH	Half Silk Black
Diamine Black HW	Janus Brown R
Diamine Blue RW	Janus Red B
Diamine Brown 3G, R, M	Janus Yellow R, G
Diamine Bordeaux B, S	Orange TA
Diamine Brilliant Bordeaux R	Oxy Diamine Black JE, JB, JW
Diamine Catechine G, R, 3G	Oxy Diamine Brown G, 3GN
Diamine Dark Blue B	Oxy Diamine Orange G, R
Diamine Fast Brown R, G	Oxy Diamine Yellow 2G, TZ
Diamine Fast Red F	Oxy Diaminogene OT, FFN, EM
Diamine Fast Yellow B, M, FF, 3G	Pluto Black BS
Diamine Gray G	Pluto Brown R
Diamine Green G, B, CL	Pluto Orange G
Diamine Orange B, F	Salmon Red
Diamine Purpurine B, V	Thioflavine S
Diamine Red B	Thiazol Yellow
Diamine Red 5B, 10B, D	Toluylene Orange G
Diamine Rose BD, GD, BG	Union Black S

Some of these colors give somewhat different tones on the two fibers.

(C) Developed Dyes Giving the Same Color on Silk and Cotton

Columbia Brown R with toluylene-diamine.
 Diamine Black BH with beta-naphthol or phenylene-diamine.
 Diaminogene B, BR with beta-naphthol or phenylene-diamine.
 Diazo Black 2B with beta-naphthol.
 Naphthogene Blue 2R, 4R with beta-naphthol.
 Oxy Diaminogene OT, FFN with beta-naphthol or phenylene-diamine.
 Primuline with beta-naphthol.
 Zambesi Black D with Nèrogene D.
 Zambesi Black D with toluylene-diamine.
 Zambesi Black 2G with toluylene-diamine.
 Zambesi Brown G, 2G with toluylene-diamine.
 Zambesi Indigo Blue R with beta-naphthol.

(D) Acid Colors Which Dye only the Silk in a Boiling Acid Bath

Acid Green BB, G	Formyl Blue B
Acid Green extra	Formyl Violet S4B
Acid Magenta	Flavazine S, T
Acid Maroon O	Indian Yellow G, R, FF
Acid Violet 6B, 3RS	Induline B
Alkali Violet LR	Ketone Blue 4BN
Amaranth G, B	Metanil Red 3B
Azo Fuchsine G	Milling Red G, R
Azo Orseille BB	Milling Yellow O
Azo Rubine A	Naphthol Black 2B
Azo Yellow	Naphthol Blue R
Benzyl Violet 4B	Naphthol Yellow S
Blue B for Silk	Naphthylamine Black S
Brilliant Acid Green 6B	New Patent Blue B, GA
Brilliant Croceine	Nigrosine
Brilliant Milling Blue B	Orange II, ENZ, GG
Brilliant Milling Green B	Patent Blue V
Brilliant Orseille C	Roccecline
China Yellow B	Rosazecine B
Croceine Orange G, R	Scarlet FR
Croceine Scarlet B	Scarlet R
Crystal Scarlet 6R	Solid Blue R
Cyanole extra	Tartrazine
Fast Acid Violet 10B	Victoria Black B, G
Fast Green CR, W	Victoria Rubine O
Fast Light Orange G	Water Blue RB
Fast Light Yellow 3G	Wool Blue N, R
Fast Red S	

21. Experimental. Exp. 228. Dyeing the Cotton and the Silk in One Color.—Prepare a dyebath containing 300 cc. of water, 0.5 gram of olive oil soft soap, 0.1 gram of soda ash, and 1 gram of salt, together with the following percentages of the respective dyes:*

2 per cent Thioflavine S	2 per cent Dianil Brown 3GO
2 per cent Diamine Orange B	2 per cent Janus Red B
1 per cent Diamine Rose BD	2 per cent Benzopurpurin 4B
1 per cent Chrysophenine	2 per cent Chicago Blue 4R

Enter at 140° F., and gradually raise to the boil, and continue at that temperature for one-half hour. Wash well, and dry. Chicago Blue will perhaps give a slightly redder color on the silk than on the cotton.

In dyeing light shades a bath containing only glaubersalt may be used; but for medium and heavy shades it is best to use the soap and a little soda ash.

This one-bath method for dyeing the two fibers alike is a very popular one and is largely used. As the number of substantive dyes which will dye the cotton and the silk exactly the same shade in the one bath is rather limited, a modification of this

* Ribbon material undyed and consisting of cotton warp and back with silk filling and face may be conveniently used on which to dye the tests. Or if desired a mixed test skein of 5 grams may be prepared by reeling together strands of cotton and silk yarns.

method is to dye the cotton to the shade desired and somewhat darker than the silk, and then to dye the latter to the right shade in a fresh bath with the necessary acid or basic dyes.

It is said that the brightness of the silk is lessened when salt is used in the dyebath, but the addition of the salt only be dispensed with in the case of light shades. The effect of the salt on the silk, however, may be lessened if not entirely remedied, by adding a sufficient quantity of soap and by not boiling. It is also said that common salt has less effect on the luster of the silk than Glaubersalt.

Instead of employing soda ash in the bath, sodium phosphate may be used with like effect.

The best results, probably, are obtained by dyeing just below the boiling temperature (about 195 to 200° F.)

When standing baths are used, only one-third the original amount of soap and one-fourth of the soda ash or salt should be added for succeeding lots.

After dyeing and washing, in order to produce a better scroop and to brighten the silk, the goods may be passed through a bath made weakly acid with acetic or tartaric acid at a temperature of about 80° F. squeezed, and dried.

Exp. 229. Dyeing the Cotton with Substantive Dyes and Leaving the Silk Undyed.—Use the same kind of dyebath as in Exp. 228, but employ the following dyes:

1 per cent Diamine Fast Yellow A	2 per cent Erica
2 per cent Benzo Sky Blue	2 per cent Mikado Orange GO
6 per cent Diazo Black BH	1 per cent Zambesi Black BR

Exp. 230. Dyeing the Silk with Acid Dyes and Leaving the Cotton White.—Prepare a bath containing 300 cc. of water, 5 per cent of acetic acid, together with the following dyes; enter at 140° F., gradually raise to the boil, and continue at that temperature for one-half hour:

2 per cent Acid Magenta	2 per cent Acid Violet
2 per cent Naphthol Yellow	2 per cent Patent Blue
2 per cent Orange II	

Exp. 231. Production of Two-color Effects on Satin.—Prepare a dyebath containing 300 cc. of water, 1 per cent of Chrysophenine, 1 per cent of Acid Magenta, and 4 per cent of acetic acid. Dye at the boil for one-half hour. In the same manner dye with the following combinations:

1 per cent Chrysophenine and 1 per cent Formyl Violet.

1 per cent Chrysophenine and 1 per cent Patent Blue.

Exp. 232. Production of Two-colored Effects.—A two-bath process may be carried out as follows: (a) Dye three samples of satin with 2 per cent of Diamine Orange B as described in Exp. 228; rinse, and top the silk in a fresh bath containing 2 per cent Acid Violet and 4 per cent of sulphuric acid; boil for one-half hour and wash. Top the second sample in the same manner with 2 per cent Acid Green, and the third sample with 5 per cent Naphthol Blue Black. (b) Dye three samples of satin with 2 per cent Diamine Sky Blue as described in Exp. 229, so that the cotton alone is dyed; then top the silk in a fresh bath containing 4 per cent acetic acid and 1 per cent Thioflavine T; dye for one-half hour at 120° F.; top the second sample in the same manner with 2 per cent Methyl Violet, and the third sample with 2 per cent Magenta.

Exp. 233. Production of Two-colored Effects.—Dye eight samples of satin in a bath containing 300 cc. of water, 10 grams Sulphur Black, 10 grams sodium sulphide, 10 grams dextrin, 1 gram soda ash, and 10 grams Glaubersalt; dye for one hour at about 100° F., then squeeze and rinse. This will dye the cotton a bluish black and leave the

silk almost white. Keep sample 1 without further dyeing. Dye sample 2 in a fresh bath with 2 per cent Formyl Blue B and 4 per cent acetic acid at the boil for one-half hour. Dye sample 3 in the same manner with 2 per cent Brilliant Cochineal 2R. Dye sample 4 with 1 per cent Acid Yellow and 1 per cent Acid Green. Dye sample 5 with 2 per cent Orange II. Dye sample 6 with 2 per cent Acid Magenta. Dye sample 7 with 2 per cent Cyanide Green. Dye sample 8 with 2 per cent Formyl Violet S4B.

CHAPTER XXIV

APPLICATION OF DYES TO THE MINOR VEGETABLE FIBERS: LINEN, RAMIE, HEMP, JUTE, AND ARTIFICIAL SILK

1. **The Minor Vegetable Fibers.**—Besides cotton, there are several other vegetable fibers used in the construction of textiles, and these are frequently dyed. As the basis of all vegetable fibers is cellulose (including also artificial silk), the general dyeing properties of all these fibers are very similar to that of cotton, and the dyestuffs and methods of dyeing employed for the latter fiber are also applicable to the other members of this group. Differences in physical structure and properties, however, usually entail some differences in the methods of handling and treating the goods.

Linen ranks next to cotton in importance as a vegetable fiber for fabric purposes. This fiber has been used from time immemorial for the weaving of a great variety of fabrics, and in fact it has only been since the last two centuries that cotton has displaced it and taken first rank. Ramie (or China Grass) has long been used in China and is highly prized on account of its great durability and strength; it has been used to any extent only for the past quarter of a century in Europe and America. Hemp is a rather indeterminate name applied to fibers, as it is used to designate quite a wide variety of vegetable fibers which differ considerably in their quality and physical properties. The kind most used for fabric purposes is Italian hemp, which is a fine light-colored fiber that can be satisfactorily spun into yarns for weaving. Manila hemp and other varieties of hems are rather coarse in structure and are used chiefly for the making of twine and cordage, and consequently are seldom dyed. Jute is a rather coarse fiber of a dark brown natural color, grown principally in India; its chief use is for making gunny sacks and bagging, for which purpose, of course, it is not dyed. It is also used, however, to a considerable extent for making fabrics for wall covering, upholstery, and draperies. Jute yarns are also used largely as a backing for carpets and rugs. When used for such purposes, they are largely dyed. Artificial silk is also considered in this connection, for though it is an artificial fiber, it consists of cellulose, and hence comes under the same general class as the other vegetable fibers.

2. The Dyeing of Linen.—Linen is distinguished from cotton chiefly in its physical appearance and properties. Cotton is a seed-hair and consists of a single elongated cell, varying from about $\frac{1}{2}$ to 2 ins. in length. Linen, on the other hand, is a bast fiber; that is, it is obtained from the stalk of the flax plant. The commercial fiber may reach several feet in length, and consists of a bundle of smaller fiber cells. As obtained from the plant, linen has a grayish or brownish color and contains a considerable amount of vegetable gums and impurities. It is also a harder fiber than cotton, having thicker cell walls, and consequently is not as

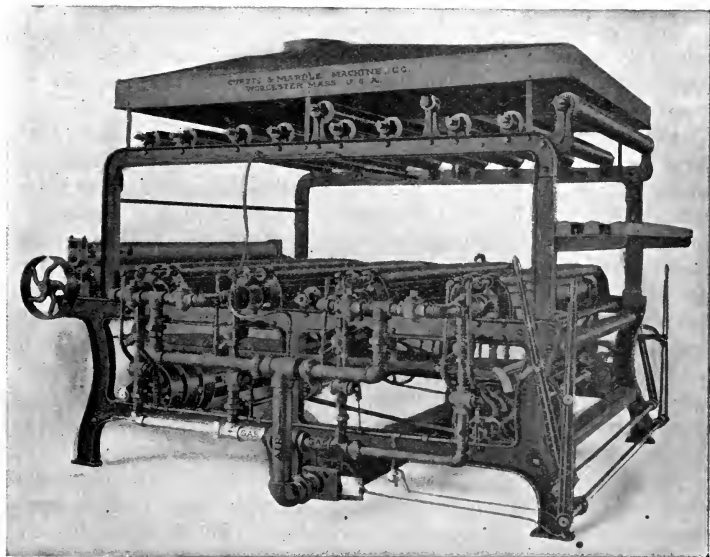

FIG. 273.—Gas Singeing Machine. (Curtis & Marble).

easily penetrated by solutions of dyestuffs and mordants. It is also harder to bleach on account of the high color and many impurities present in the raw fiber. Furthermore, since the commercial long fiber consists of a number of small cells cemented together, severe treatment with strong chemical agents (such as chloride of lime) is liable to cause damage to the material, therefore the bleaching must be conducted more carefully even than with cotton.

Linen may come to the dyer either in the form of yarn or of the woven fabric. In either case, it will usually be necessary to boil out the goods

with alkaline solutions in order to remove most of the material impurities. In the event of dyeing light shades it will also be necessary to bleach the goods before dyeing.*

The action of chemicals on linen is practically the same as on cotton; it being somewhat more resistant to acids and slightly more affected by alkalis; it is also more affected by the usual bleaching agents than cotton. It is quite inert towards solutions of metallic salts and consequently the application of metallic mordants presents the same difficulties as with cotton. It absorbs tannic acid, however, and consequently can be mordanted with tannin and antimony in the same manner as cotton.

With dyestuffs, linen readily combines with the substantive colors; it may be dyed with the basic colors if previously mordanted with tannin. Towards the acid and mordant dyes, it is inert; with the sulphur and vat dyes it combines in the same manner as cotton.

Before dyeing the raw linen fiber it is necessary to remove most of the incrusting impurities. This is done by boiling the goods in a bath containing 5 per cent of soda ash; this is usually done in open tubs and not in pressure kiers, as boiling with alkali under pressure is liable to weaken the fiber. To obtain a well-purified fiber, it is usually necessary to repeat the alkali boiling three times with intermediate rinses. The first treatment with alkali causes the raw linen to become darker in color; the alkali bath also becomes dark colored and foul. After the third alkali boil the fiber is of a light brownish yellow color. The amount of impurities in raw linen is about 15 to 30 per cent, varying with the quality of the fiber and the nature of the retting process. After complete boiling out there still remains about 7 per cent of impurities in the linen, which can only be removed by bleaching. †

The principal dyes used at the present time for linen are the substantive colors, and to a lesser extent the sulphur and basic dyes. Linen is somewhat harder to dye than cotton, it being more difficult to obtain well-penetrated colors, therefore the dyebath is generally used at a higher temperature, it usually being necessary to boil the goods vigorously in the dyebath. Also it is necessary to use more concentrated dye liquors.

* Linen goods include a wide variety of fabrics such as heavy sail-cloth and drills, sheetings, toweling, dress goods, batistes, shirtings, damask, hangings and draperies, upholstery fabrics, buckram, bookbinders' cloth, etc. Owing to the relatively high cost of linen during late years, cotton is being used more and more to replace it, cotton yarns being spun and finished in such a way as to closely imitate the characteristic appearance of linen, and many staple fabrics which, in former years, were made exclusively of linen are now made from cotton.

† According to Schott's process for boiling-out raw linen yarn, the goods are boiled in a weak solution of sodium bisulphite, it being claimed that the impurities in the fiber are converted by the sulphurous acid into soluble compounds; the yarn is then thoroughly washed, treated with a weak hypochlorite bath and then well washed again.

The following processes are of interest in the dyeing of linen:

(1) Prepare the dyebath with 10 to 20 per cent of common salt and the necessary amount of well-dissolved substantive dyes, and dye for one hour at a boiling temperature.

(2) When it is particularly difficult to obtain good penetration of the color, prepare the dyebath with 3 to 5 per cent of soap and 1 to 2 per cent of

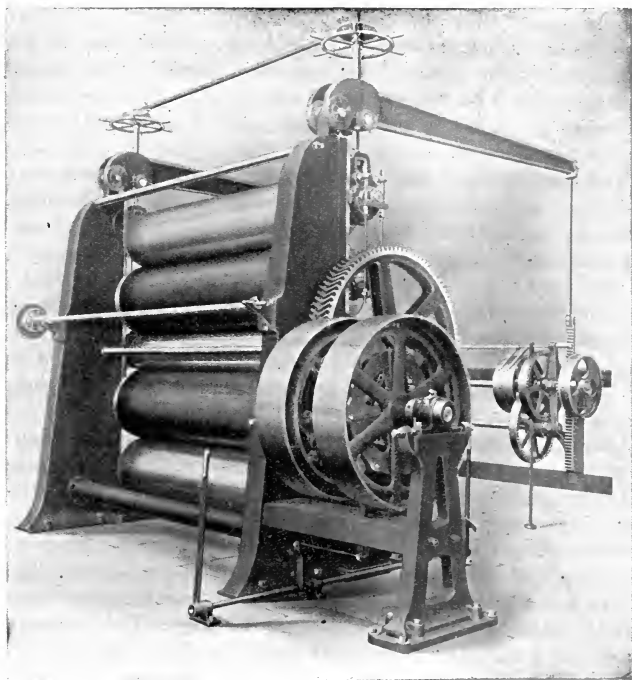

FIG. 274.—Jute Calendar.

soda ash; dye at the boil for one-half hour and then add 5 to 20 per cent of Glaubersalt. An addition of Turkey-red oil is also of advantage.

(3) To dye with basic colors, first mordant with 2 to 4 per cent of tannic acid (or a corresponding amount of sumac extract); boil for one hour and steep in the cooling bath overnight. Squeeze and fix in a fresh bath containing 1 to 2 per cent of tartar emetic; run at 140° F. for one hour. Wash, and dye in a bath containing the well-dissolved basic dye and 4 per cent of alum; enter the goods cold and slowly raise the temperature

to 180 to 190° F. Care must be taken in dyeing the basic colors to obtain even and well-penetrated shades. The basic dyes may also be used for topping linen dyed with the substantive colors.*

(4) The sulphur dyes are used on linen in the same manner as for cotton, though usually the quantity of salt added to the bath must be decreased and the amount of sodium sulphide somewhat increased in order to obtain well-penetrated and level colors. It is also beneficial to add some Turkey-red oil to the bath. The sulphur dyes are now used quite largely for the dyeing of blue, black, and brown on linen yarns and piece-goods. The sulphur dyes on linen may also be topped with basic dyes in a fresh cold bath with the addition of acetic acid or alum. Considerably less sulphur dye is also necessary in dyeing linen as compared with cotton to produce the same shade.

(5) Indigo is largely used for dyeing fast blue on linen, and the other vat dyes are also used where colors of great fastness to light, washing, and even bleaching (for towel headings, etc.) is desired. At the present time the hyposulphite vat is principally used, and is prepared and employed in the same manner as for cotton. It must always be borne in mind, however, that linen is harder to penetrate, and especial care must be exercised on this account.

(6) The alizarine and chrome mordant dyes are not adapted for the dyeing of linen, but these colors are extensively used in the printing of linen piece-goods.

After dyeing linen yarn is usually lustered by treatment in a yarn mangle or cylinder. Linen cloth is lustered by treatment on a calender machine.

At the present time, there are many fabrics made up of half linen; that is to say, part linen and part cotton. In dyeing such goods, the same methods are employed as for cotton, the substantive or sulphur dyes being principally used. Owing to the harder nature of the linen fiber and its resistance to the penetration of the color, great care must be exercised in order to obtain uniform shades on both the fibers. It is recommended to use some Turkey-red oil in the dyebath.

Fabrics are also woven of part linen and part wool (usually a linen warp and a wool filling), and these dyed in the same manner as union goods of cotton and wool.

The apparatus used in linen dyeing is comparatively simple. Skein yarn is generally dyed by hand on sticks hung in long rectangular tubs. These tubs usually have to be deeper than those used for cotton, as the linen hanks are wound longer. Skein dyeing machines may also be

* The basic colors chiefly employed for dyeing linen are:

Rhodamine B and G
Safranine
Auramine

Brilliant Green
Methylene Blue

employed with good results. Linen cloth is generally dyed in the jigger or in an open-width dyeing machine rather than on a winch machine in rope form.

3. The Dyeing of Ramie.—This material is also a bast fiber. It is long, quite white in color and lustrous in appearance. It is rather smooth and therefore does not lend itself very well to spinning like cotton, and where used in this country for fine yarns it is usually mixed with some other fiber such as cotton or wool. Ramie as obtained from the plant contains a large amount of vegetable gums, but in order to bring it into a condition proper for spinning these impurities have to be removed, so that when the dyer gets ramie yarns or fabrics for dyeing no previous scouring operation is necessary. Furthermore, the fiber is so white in color that it does not have to be bleached except when dyeing very bright and delicate shades. The dyeing and bleaching of ramie materials is carried out precisely as in the case of cotton, the same dyes and processes being employed. As the fiber is considerably harder and thicker than cotton, due allowance must be made in order to procure even and well-penetrated colors.

Ramie is also known as China Grass, Nettle Fiber or Rhea Fiber. In this country it is seldom used by itself for the making of fabrics, being mostly employed for effect threads or patterns in wool goods. There are some decorative and upholstery fabrics, however, made from ramie alone, but these are rather scarce.

4. The Dyeing of Jute.—Jute is also a bast fiber of rather coarse character and dark color. By proper methods of decortication and treatment, however, it is possible to obtain a jute fiber which is quite fine and of good appearance, and which makes a yarn and fabric of pleasing appearance. Jute is chiefly used by itself for making rather coarse fabrics for draperies, upholstery goods, wall-coverings, and as a base for carpets and rugs. Jute differs somewhat from the preceding vegetable fibers and cotton in that it is rather strongly lignified, and therefore instead of consisting of practically pure cellulose, it contains compounds bearing a close resemblance to the vegetable tannins. On this account jute may be dyed directly with the basic dyes as well as the substantive and sulphur dyes. Also the acid dyes are taken up by jute far better than by the other vegetable fibers, and these dyes are useful for the dyeing of this fiber.

On account of the rather dark-brown color of jute it is necessary to bleach it before dyeing unless dark heavy shades are desired. The cleaning and bleaching of jute may be carried out in the following manner: Steep the material overnight in lukewarm water in order to soften up the fiber and the hard impurities; rinse and boil for one-half hour with a solution containing $\frac{1}{2}$ oz. soda ash and $\frac{1}{2}$ oz. sodium silicate per gallon. This will remove most of the glutinous and greasy matters; rinse well, and then

bleach in a bath containing a solution of sodium hypochlorite at 1° Tw., cold, for ten hours. A solution of chloride of lime may also be used. Rinse well and sour with sulphuric acid at 1° Tw., after which rinse well again and dye. A somewhat clearer white may be obtained when desired by bleaching with permanganate of potash and sodium bisulphite in addition to the treatment with the hypochlorite. Care must be taken in the bleaching not to injure the fiber. After bleaching it is advisable to soap the goods both for the purpose of neutralizing any residues of acid and also to soften the fiber and give it a desirable luster.

The acid dyes are much used for the dyeing of jute, as they give colors with good penetration and of good fastness to light. To dye with the acid colors prepare the bath with 2 to 5 per cent of alum and dye for one hour at the boil, then allow to cool down in the bath for another half hour. The colors so obtained have not much fastness to washing, but this character of fastness is seldom necessary on fabrics made from jute. In dyeing jute it must be borne in mind that the fiber has a great affinity for lime compounds, consequently the water used in the dyebath should be as free from lime as possible, and if only hard water is available for use this should be corrected by the addition of acetic acid in sufficient quantity.*

The basic dyes, as already mentioned, dye jute directly without the necessity of a previous mordanting with tannin. The dyebath † is prepared with the well-dissolved color solution and $\frac{1}{2}$ to 2 per cent of alum is added; the dyeing is started cold or lukewarm and the temperature is gradually raised to 180° F. In cases where the dye shows a tendency to uneven shades it is best to add the color solution to the bath in several portions. In dyeing bright red shades it is recommended to add to the bath 1 to 2 per cent of oxalic acid.‡

The substantive colors on jute are usually dyed in a bath containing 10 to 20 per cent of Glaubersalt or common salt, the former being preferred.§

* For the production of particularly bright pink colors on jute it is necessary to use Eosin or Rhodamine on bleached material. Eosin is dyed in a concentrated bath with the addition of 25 to 50 per cent of common salt, starting lukewarm and slowly bringing to the boil; then shut off the heat and dye for a further one-half hour. The pink obtained with Eosin, though brilliant, is not fast to light. Rhodamine gives a bright pink of good fastness to light. It is dyed with the addition of acetic acid. If necessary it may be shaded with Auramine.

† Hard water should be corrected by the addition of acetic acid. For moderate hardness (5 to 7°), for instance, use one-half gallon of acetic acid (9° Tw.) to 100 gallons of water.

‡ Colors on jute which are faster to crocking and water may be obtained with the basic dyes by giving an after-treatment in a lukewarm bath containing 1 per cent of tannic acid.

§ When dyeing heavy shades with the substantive colors the jute should be left in the cooling bath for some time in order that it may take up the maximum amount of color.

The colors obtained have good fastness to water and crocking; the dye penetrates well and the fiber is left with a good soft handle. Basic dyes may be used for topping the substantive colors for the purpose of obtaining brighter shades.

The sulphur dyes are not so well adapted for the dyeing of jute, as the strongly alkaline baths tend to weaken the fiber. However, for certain purposes, especially for black, the sulphur dyes may be used with sodium sulphide but without the addition of soda ash, as is customary with the

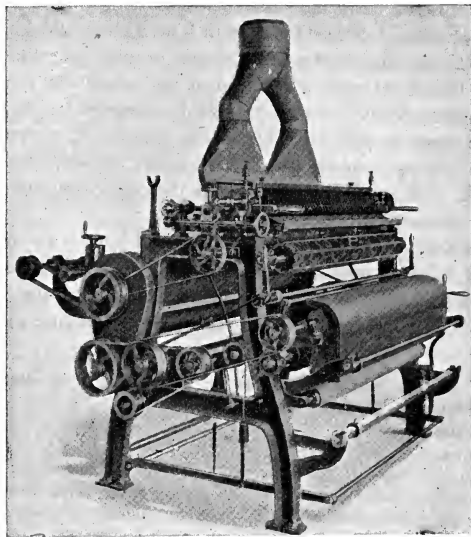

FIG. 275.—Picking and Shearing Machine for Silk Goods. (Curtis & Marble).

dyeing of cotton. Also the temperature of the bath should be kept below the boiling point.*

5. Dyeing of Coir Fiber.—This fiber is obtained from the husk of the cocoanut and is a coarse brown-colored fiber. It is used somewhat for mattings and rugs and is sometimes required to be dyed. The character of the fiber is very similar to that of jute and it may be dyed in practically the same manner with the acid, basic, and substantive dyes.†

* It is best not to run the dyebath at a temperature over 130° F.

† Coir may be dyed either raw or bleached. The bleaching may be done in the same manner as for jute with the use of bleaching powder, potassium permanganate, etc. Or it may be bleached with the use of hydrosulphite products such as Deeroline, according

6. Dyeing of Hemp.—This fiber when used for textile purposes is rather soft and fine in structure and of a light-brown color; it also possesses a good luster, and closely resembles linen. It is also closely related to this fiber in its dyeing properties. It is chiefly dyed with the substantive colors, though for bright shades the basic dyes are used on a mordant of tannin and antimony.*

7. Dyeing of Artificial Silk.—This is a cellulose fiber with properties closely resembling the other vegetable fibers and is prepared by forcing thick solutions of cellulose through very fine orifices or spinnerets. There are three varieties of artificial silk: (a) *Chardonnet* or *Collodion Silk*, made from a solution of nitrated cotton in a mixture of alcohol and ether; the fiber so obtained consists of a fine filament of nitrated cellulose which is denitrated by treatment with a solution of ammonium sulphide or other suitable denitrating agent, so that the final commercial fiber is cellulose.

(b) *Cuprammonium Silk*, also known as Glanzstoff, prepared from a solution of cotton in ammoniacal copper oxide. After spinning the filament is treated with a weak acid solution that dissolves out the copper, leaving a fiber of pure cellulose.

(c) *Viscose Silk* is prepared from a compound known as viscose, which is obtained by treating cotton or purified wood-pulp with strong caustic soda and carbon disulphide. The filaments, after spinning, are treated so as to remove the sulphur compounds and salts, leaving pure cellulose as the fiber.†

to the following method (Badische). Steep the coir overnight in a bath containing 2 pints hydrochloric acid (30 per cent),

1½ lbs. Decroline,

70 gallons water,

then rinse well in fresh water. The bleaching bath is not exhausted and may be freshened up for use with further lots by adding 14 gallons water, ½ pint hydrochloric acid and 6 ozs. Decroline. Sulphuric acid (3 ozs. per 10 gallons) may be used in place of hydrochloric acid.

In dyeing coir with the acid dyes it is well to allow the material to cool down in bath in order to better absorb the color.

* Colors for hemp twines are sometimes required that will not mark off on to white.

The following dyes are suitable for these colors:

(a) Acid dyes:

Pure Blue

Orange X

Erythrine P

Cotton Scarlet

Eosin

(b) Basic dyes:

Auramine

Rhodamine B, G, 6G

Safranine

Methyl Violet

Jute Black

Methylene Blue

Diamond Green G, B

Magenta

Victoria Blue

(c) Substantive dyes: almost all of this class.

† Besides the three varieties of artificial fiber there are other forms in which this

Viscose silk is manufactured on a very large scale in this country and is gradually supplanting the other varieties also in Europe. Artificial silk, by whatever method prepared, consists of practically pure cellulose, or rather a hydrated cellulose. The filaments are very fine and of great length, being drawn out in practically a continuous fiber in the same manner as real silk. It has a high degree of luster, surpassing in this respect even real silk itself. It does not, however, have the strength or elasticity of real silk, and when wetted with water it becomes seriously weakened and softened, while treatment with alkalis, especially in hot solutions, causes the fiber to disintegrate owing to the solvent action of the alkali. On this account great care must be exercised in dyeing and bleaching artificial silk to avoid any undue handling when the fiber is wet and also the solutions employed must be as cold as possible, and the use of strong alkalis must always be avoided. Fortunately, however, artificial silk is very absorptive, and takes up dyestuffs very readily from solutions without the need of much heating of the bath, so that most of the dyeing is done cold or at a lukewarm temperature. The bleaching of artificial silk is usually done in the process of manufacture, but sometimes the fiber comes to the dyer in the raw state, having a slight yellowish brown color, and the dyer is required to bleach it either for the purpose of white goods or for dyeing bright and delicate shades. In this case the bleaching is done with a weak solution of chloride of lime in practically the same manner as with cotton, after which the goods are soured with a bath of weak acid and then soaped in a lukewarm solution.

The dyes principally employed for artificial silk are the substantive colors. These are dyed for one hour at 120 to 140° F. in a short bath with the addition of 5 to 20 per cent of Glaubersalt. When dyeing light shades it is recommended to use 10 per cent of Glaubersalt and 5 per cent of soap.* As the fiber takes up the color very rapidly care must be used in obtaining even and level dyeings.† Sometimes lack of uniformity is caused by uneven density in the fiber itself, due to imperfections in the spinning, and this is very hard (and sometimes impossible) for the dyer to overcome.

Owing to the great absorptive power of artificial silk it may also be dyed directly with most of the basic dyes ‡ and some of the acid dyes, material is sometimes met, such as Viscolline yarn, which is a cotton yarn coated with artificial (viscose) silk; also artificial horse-hair, which is a very coarse variety of artificial silk.

* When dyeing with Chrysamine 5 per cent of sodium phosphate must also be added.

† Soluble oil (Monopol Oil) is frequently added to the dyebaths for artificial silk in order to promote level dyeings and also to give the fiber a softer handle.

‡ The Chardonnet silk possesses a greater affinity for the basic dyes than the other forms of artificial silk, probably due to slight residue of nitrogenous matter in the fiber. On the other hand, it has a lesser affinity for the substantive dyes. The euprammonium silk has great affinity for the substantive and but little for the basic dyes. The viscose silk stands midway between the other two.

though the latter do not yield colors that are fast to washing.* In dyeing with the basic dyes, the artificial silk is first wet out in water at 100° F. and then dyed for one hour in a neutral bath † at 85° F., or not higher than 100° F. The basic dye should be very carefully dissolved and filtered and the solution is added to the bath in several lots in order to obtain level colors. Also if hard water is used in the dyebath it should be corrected by the addition of acetic acid. When dyeing in hand-tubs the skeins should be hung on glass or enameled sticks and turned with great care to prevent

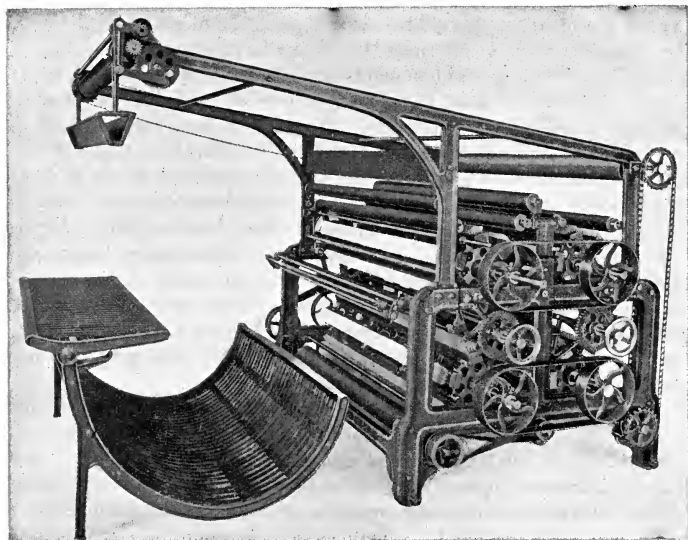

FIG. 276.—Machine for Polishing and Sanding Worsteds. (Parks & Woolson.)

breakage of the silk. After dyeing the goods are rinsed but not wrung out as this would injure the fiber. The excess of water should be removed by a hydro-extractor. When the silk is dry the skeins are given a glossing by slight stretching, as in the case of real silk. A scroop may also be given by treating with a bath of weak acetic or tartaric acid and drying without rinsing.

* The phthalein dyes (Eosin, Erythrosine and Rose Bengale) may be dyed on artificial silk by using a short bath at 100° F. with the addition of 2 lbs. common salt per 10 gallons of liquor. The goods are whizzed and dried without rinsing. Methyl Blue and Water Blue may be dyed at 100° F. with the addition of 10 per cent of alum.

† To obtain a more level dyeing 2 to 5 per cent acetic acid may be added to the bath.

To obtain heavier shades with the basic dyes and also when fast colors are desired, the goods should be first mordanted with tannin and tartar emetic in the same manner as with cotton. Steep the goods in a bath containing 2 to 5 per cent of tannic acid and 1 per cent of hydrochloric acid at 120° F. for several hours; then hydro-extract and fix in a fresh bath with 1 to 2 per cent of tartar emetic. Dye with the addition of 2 to 3 per cent of acetic acid and at a temperature of 85 to 100° F.* The basic colors may also be used for brightening the shades obtained with the substantive dyes by topping in a fresh cold bath with the addition of a small quantity of acetic acid.

The sulphur colors may also be used to some extent in the dyeing of artificial silk, preparing the dyebath with the same quantity of sodium sulphide as dyestuff, 5 to 25 per cent of Glaubersalt and 1 to 4 per cent of soda ash; dye for one hour at 100 to 120° F.†

Artificial silk is very extensively used at the present time for hosiery, generally in connection with cotton feet and tops; also the artificial silk is frequently spliced with a thread of real silk and knitted together. Artificial silk is also used largely for silk-effect threads in shirtings and blouse material and in pattern effects in connection with cotton, mercerized cotton, or real silk in the weaving of various dress goods, necktie material and fancy fabrics for passementerie and trimmings, braids, upholstery goods, draperies, etc. When dyeing in the piece together with other fibers great care and ingenuity are required to obtain uniform colors on both fibers. Usually it is necessary to dye the material in the yarn before weaving in order to obtain the effects desired.

Good deep blacks on artificial silk are usually dyed with the developed colors, first dyeing with a Diazo Black, then diazotizing with sodium nitrite and hydrochloric acid and finally developing with beta-naphthol or phenylene-diamine. The process is carried out in the same manner as with cotton. After dyeing the fiber is generally brightened by treatment in an emulsion of glue, oil, and acetic acid, as this increases the luster and improves the handle of the goods.‡

* To obtain dyeings fast to acids for effect threads to be used in woolen goods, the dyed silk should be again run through the old mordanting baths of tannin and tartar emetic, recharging the baths with about two-thirds of the original quantities.

† After dyeing the cuprammonium or viscose silks with the sulphur colors the goods should be soaped lukewarm, rinsed, and then soured in a weak acetic acid bath. In the case of Chardonnet silk the soaping should be omitted and only the acid bath used. This is for the purpose of removing all of the alkali, which would otherwise cause a rotting of the fiber. In dyeing with Sulphur Blacks it is recommended by some to after-treat in a bath containing 1 lb. of sodium acetate or formate to 10 gallons. Also in the dyebath it is of advantage to add some soluble oil..

‡ Brown shades of good fastness to washing and cross-dyeing (for effect threads) may be obtained by the use of Primuline and a Diazo Black diazotized and developed with resorcine or phenylene-diamine. The brown shades obtained with the sulphur colors are also very fast to light.

CHAPTER XXV

THEORY OF DYEING

1. General Theory of Dyeing.—There have been three main theories to explain the general process of dyeing. The *chemical theory* supposes that dyeing involves a chemical reaction between the fiber and the dyestuff and that a definite chemical compound known as the *color-lake* is thus produced. The *mechanical theory*, on the other hand, considers the effect of dyeing to be simply a deposit of colored particles in the substance of the fiber* and the combination so formed to be merely a mechanical mixture. The *solid solution theory* advocates the view that the coloring of the fiber in dyeing is due to the fact that the substance of the fiber (or any other body which may be so dyed) dissolves the coloring matter or color-lake much in the same manner that molten glass, for example, dissolves various pigments and becomes colored thereby.

The chemical theory is supported by the facts that the animal fibers (wool and silk) exhibit well-defined chemical reactivities of an acid and a basic character, and that these fibers readily dye with the acid and basic dyestuffs; whereas cotton, which is practically inert as far as chemical reactivity is concerned, shows no pronounced attraction for these dyes; but if an acid mordant is added to the cotton fiber, then the latter exhibits the power of combining with basic dyes, or if a basic mordant (a metallic oxide) is added the cotton will be able to combine with the acid dyes. Furthermore, in the case of mordant dyes, the combination between the dyestuff and the mordant may be made independent of the fiber, and a chemical reaction undoubtedly takes place in the formation of such a color-lake. On the other hand, it may be shown that the substantive colors

* This mechanical theory may hold with reason in the case of dyeing the various mineral colors on cotton; for instance, where the colored pigment resulting from the double decomposition between two solutions is merely precipitated within the cells of the fiber; or in the dyeing of Indigo where the dyestuff is of a pigment character. But in the usual forms of dyeing, there is no differentiation possible between the substance of the cell-wall of the fibers and the particles of coloring matter, for even under the highest powers of the microscope the fiber appears to be uniformly colored just like an ordinary solution and there is no separation of pigment matter to be noticed. Hence the mechanical theory can only be held to be true within certain narrow limits.

dye cotton quite readily without any evidence of a chemical reaction. Also almost any porous substance (even such substances as unglazed porcelain, finely divided silica, etc.) will take up a dyestuff from solution (especially the basic dyes) and become truly dyed thereby. Even unmordanted cotton will dye with many of the acid and basic dyes if concentrated solutions are employed, and the colors so obtained have a certain degree of fastness.

Advocates of the mechanical theory of dyeing often compared the action of the fiber in dyeing to that of animal charcoal in its decolorizing effect on solutions of dyestuffs. Though this comparison, at first thought, may appear to be very apt and to be a strong point of evidence in favor of the mechanical theory, nevertheless, on closer scrutiny and consideration the similarity in this comparison becomes somewhat doubtful.* Of course,

* The chemical theory was primarily objected to by the partisans of the mechanical theory on the ground that there was no definite proportion to be observed between the amount of the fiber and the amount of dyestuff with which it combines. As true chemical reactions take place only between definite proportions of the reacting substances this objection would seem to vitiate the chemical theory right at the start. But on more closely inspecting this question the objection loses considerable of its apparent value, because it is very probable that the reaction between the dyestuff and the substance of the fiber is only a partial one and may be more or less superficial, as the fiber may become considerably changed in its chemical properties by reason of combining with the dyestuff. That there is any molecular ratio between the masses of the dyestuff and the fiber taking part in the reaction would be very difficult to demonstrate or to disprove. For as Vignon has pointed out (*Bull. Soc. Mulhouse*, 1893, page 407) it is no doubt very probable that the textile fibers possess very high molecular weights in comparison with the corresponding weights of the dyestuffs; so that if a fiber with a molecular weight of, say, 4000 units combines with one or two molecules of a dyestuff having a molecular weight of only 200, it is evident that it would be very difficult to establish the law of definite molecular proportions in the combination, especially where it is furthermore considered that the fibers are very likely far from being chemically homogeneous. In order to illustrate this point, Rosenstiehl (*Bull. Soc. Mulhouse*, 1893, pages 413, 417) offers the following example: If a piece of silver is exposed to the action of sulphureted hydrogen gas it will rapidly become blackened. This coloring effect is due to the formation of silver sulphide, which is black, and, of course, it is well understood and recognized that a chemical combination has occurred between the metallic silver and the sulphureted hydrogen gas; that is to say, a definite number of molecules of silver have combined with a definite number of molecules of sulphur (contained in the sulphureted hydrogen gas), and if the amount of silver sulphide formed is determined it will be found that the weights of the silver and the sulphureted hydrogen entering into the composition of the silver sulphide are in definite proportions to one another. But if the total weight of the piece of silver were taken and the total weight of the sulphureted hydrogen likewise, this definite proportion between the weights of the two would not be found to hold, for the simple reason that the chemical union between the silver and the sulphureted hydrogen has only been a partial one, as the formation of the black silver sulphide has been merely a superficial one, a fact which may easily be shown by rubbing the blackened surface of the silver, when the thin layer of silver sulphide will be removed and a surface of the bright metal will again be exposed. This same idea may be applied to the theory of dyeing by supposing that the chemical

it is a well-known fact that when some liquids containing coloring matters in solution are filtered through a layer of animal charcoal they become decolorized, the coloring matter being either absorbed or destroyed by the charcoal. But it has also been found that the solutions of many dyestuffs which dye the fibers well are but very slightly acted on by animal charcoal, while, on the other hand, there are many colored solutions which are readily and completely decolorized by animal charcoal, but from which the fibers do not take up any color at all. It has furthermore been shown that the action of animal charcoal on solutions of those coloring matters which it decolorizes is probably that of strong oxidation, causing the chemical decomposition and destruction of the dyestuff. This, of course, is a totally different action from that of the fiber which combines with the coloring matter without destroying it. The oxidizing action of the charcoal is caused by the great porosity of its particles, which brings the oxygen of the air into very intimate contact with substances which may be in the solution treated with the charcoal. This action of the charcoal is very similar to that of finely divided platinum, which is a strong oxidizing agent. In consequence of these facts it may be said that the dyeing process of fibers can hardly be compared with the action of charcoal in decolorizing solutions; or at best, the comparison is badly chosen.

The mechanical theory of dyeing supposes that the particles of the dyestuff which are held in solution are taken up by the fiber by the force of capillary action, and are then held by the fiber in the interstices between its molecules. Though, as already pointed out, this may be the condition in some instances of dyeing, yet it cannot apply to all processes of dyeing, otherwise there would be no reason why all dyestuffs should not dye all kinds of fibers indiscriminately. In contradistinction to this, of course, union between the dyestuff and the coloring matter is superficial and incomplete and similar to that between the silver and the sulphureted hydrogen. But in this case the layer of colored substance (the silver sulphide) may easily be removed by rubbing; and furthermore, if a cross-section of the silver piece were made, it would show but a minute layer of the colored substance, the rest of the section being metallic silver. On the other hand, it does not appear that mere rubbing will remove the color in the case of dyeing a fiber; though, of course, it may be said that here the deposition of the layer of colored substance is not only on the external surface of the fiber as a whole, but is also on the internal surfaces of the cells of which the fiber is composed. But again, if cross-sections of dyed fibers are examined microscopically it will be found that no differentiation can be made between a surface layer of colored substance and an internal portion of substance without color, such as would naturally be the case if the dyeing of the fiber were analogous to the blackening of the silver piece. In the case of dyed fibers, a microscopic examination will show that the substance of the fiber is uniformly colored throughout its cross-section, much after the manner of a solution. It is at this point that the chemical theory is somewhat weak. There have been numerous attempts made to observe any quantitative proportions existing between the mass of the fiber and the mass of the coloring matter with which it combines, but none of these has turned out at all satisfactory.

it is well known that if a certain coloring matter dyes wool it does not necessarily dye cotton. This mechanical theory also would not explain why the same dyestuff gives two quite different shades on different fibers, or why some dyestuffs give colors relatively fast to light on one fiber while on another fiber the colors are comparatively fugitive. Owing to the many discrepancies existing in the mechanical theory it has gradually lost its adherents and at the present time has been almost entirely discarded.

With the present knowledge of dyeing, it seems more reasonable to assume that the substance of the fibers is capable of *dissolving* such bodies as dyestuffs and mordants, bringing about a condition which we know as *solid solution*, which merely means that one solid substance is dissolved in another solid. According to this view of regarding the phenomena of dyeing, the dissolved coloring matter in its water-solution passes into a fiber-solution. There are many factors influencing the degree and rapidity of this form of solution, among which the most important appear to be the chemical activity existing between the dyestuff (or mordant) and the fiber, the heating of the dyebath, the presence of various chemicals in the dyebath or fiber, and the mass relations between the fiber and dyebath, and the dyestuff.

Limited to the consideration of the chemically active groups of dyestuffs, there is no doubt but that the chemical theory has much of truth in its conception.* There are a number of experimental facts which

* The dyeing of substantive colors on cotton is one of the greatest difficulties in the way of the purely chemical theory. These dyes fix themselves on cotton from solutions of a neutral character, though slightly alkaline baths may also be employed. In the practical dyeing of this class of colors an addition of common salt is made to the dye liquor, but this addition is merely for the purpose of lowering the solubility of the dyestuff in the water and thus causing more color to be taken up by the fiber, it does not effect the relation between the coloring matter and the fiber. By those who try to force the chemical theory on every case of dyeing it is claimed that the cotton really does combine in some chemical manner with the dyestuff; it being supposed that the "hydroxyl" groups, which are known to be present as constituents of the cellulose molecule, have sufficient chemical activity to unite with definite groups present in the dyestuff molecule. It is rather remarkable, however, that the chemical activity of the hydroxyl groups in cellulose should appear to be so meager towards strong bases and acids and other chemically active groups while they are able to exert a selective power of attraction for the very weak chemical groups which may be present in the substantive dyes. If the theory held, cotton should also dye with many acid and basic dyes, even more readily than with the substantive colors. On the other hand, it must be borne in mind that most of the substantive dyes are derived from a common fundamental molecule known as benzidine, and there may be a particular chemical affinity between these benzidine compounds and the cellulose molecule which may furnish a real chemical basis for the explanation of the dyeing phenomena exhibited by this class of compounds; but as these substantive dyes also color wool and silk about as well (and in some cases better) as they do cotton, it is hardly likely that such an explanation is reasonable. From the consideration of the facts as observed in connection with the dyeing of substantive colors it is pretty much admitted by all, at the present time,

support it. Let us take, for example, the dyeing of wool with Magenta. This dyestuff belongs to the basic class, and consists of *rosaniline* (the color-base) combined with hydrochloric acid, so that the dyestuff itself is a *salt* (a chemical combination between a base and an acid). The solution of Magenta (the salt) is colored red, and it is this color which is also produced on the wool in dyeing with this dyestuff. The color-base of Magenta (*rosaniline*), however, is colorless and gives a colorless solution. This color-base can easily be prepared from the color salt by saturation of its solution with caustic soda. If wool, however, is boiled in a solution of *rosaniline* (colorless) it will become dyed red in the same manner as if a solution of Magenta (the salt) itself had been used. This would seem to indicate very positively that the color-base has united with some acid constituent of the fiber to give a salt, and it is therefore necessary to assume that a chemical reaction has taken place between the fiber and the dyestuff, and that the color-lake so formed is a definite chemical compound.

There are other instances of a similar character which may be cited in favor of the chemical theory. Following out more observations in connection with the same dyestuff Magenta, it has been found that when wool is dyed in a solution of Magenta (*rosaniline* and hydrochloric acid) the dyebath contains free hydrochloric acid, which means that the color-base has combined with the fiber, leaving its previously combined acid back in the bath. There is, however, another point of view from this phenomenon which may be observed. If a strip of porous paper (such as filter paper or blotting paper) be hung so that it dips into the solution of Magenta, it will be found that the solution is drawn up into the paper above the surface of

that the dyestuff merely passes from its solution in water into solution in the fiber being dyed, for it has been shown that if cotton be dyed with Benzopurpurin, for example, and then be placed in a boiling bath of fresh water some of the color will bleed off on the cotton and redissolve in the water, and this may be repeated several times by treating with successive baths of fresh boiling water. Of course, if the dyeing were altogether simply a question of the solution of the dyestuff in the fiber, it should be possible to again remove all of the dyestuff from the fiber by repeated boilings in water. This reverse operation, however, I have never succeeded in accomplishing; for though a considerable amount of the coloring matter may be stripped from the cotton by such a means, a limit is soon reached. Furthermore, in the case of wool and silk many of the substantive dyes give colors which are eminently fast to washing. Such facts would seem to indicate that besides the mere solution-factor of the fiber for the dyestuff, there must be some other determining factor which influences and conditions the fixation of the coloring matter by the fiber. It appears that most of the substantive dyes are present in the dyed fiber in the form of their alkali-salts, a fact which can be proved by showing the presence of the alkali in the ash of the fiber. This same thing is true of quite a number of coloring matters dyed on wool and silk, such as many of the azo dyes, and more especially the general class of phthalein dyes including the Eosins and Rhodamines. This fact would seem to indicate that the form of union between the fiber and the dyestuff, if of a molecular nature at all, must be additive in character and probably without material modification of the molecules of either the fiber or the coloring matter.

the liquid by means of capillary action, and it will furthermore be noticed that after a time two distinct areas will be noticed on the strip of paper, the one, next to the surface of the liquid, will be colored (the same as the solution itself), while the second, located above the first area, is colorless. If the proper tests are applied it will be found that the liquid of this second area is acid; and, in fact, the presence of free hydrochloric acid in this

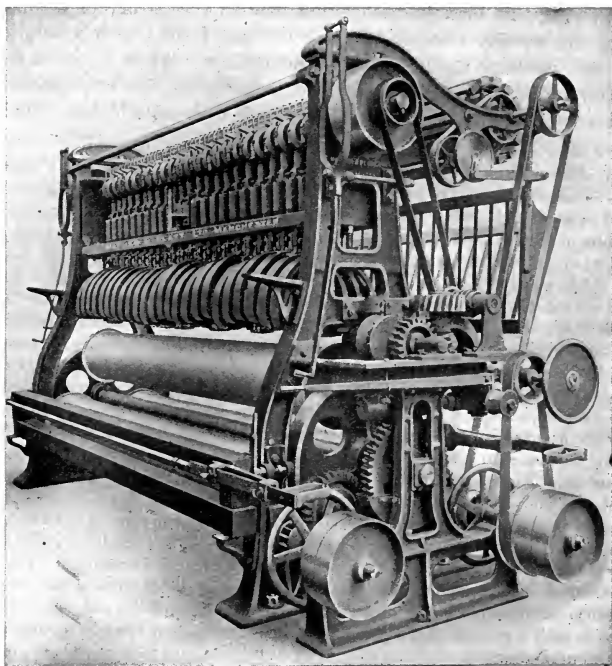

FIG. 277.—High-speed Spring Beetling Machine. (Mather & Platt.)

portion may readily be shown. This fact would seem to vitiate (to a great extent at least) the testimony offered above in favor of the chemical theory; i.e., that in dyeing wool with a solution of Magenta, the color-base was taken up by the fiber, leaving the free hydrochloric acid remaining in the residual bath.

A study of this condition, together with many others of a similar character which are found to occur very extensively in the ordinary processes of dyeing, led Knecht (*Berichte*, 1888, p. 1537, 2803) to propose a

theory of dyeing based on the idea of *dissociation* of the molecules of the dyestuff when in solution.* This theory of Knecht, in fact, brings the various facts of the chemical theory of dyeing into harmonious accord with the more widely generalized solution theory. The dissociation of dissolved substances comes directly under the consideration of the properties of solutions, and the chemical functions of solution depend to a great extent on this condition.

Applying this idea of dissociation now to the theory of dyeing, and taking the already cited case of the dyeing of wool with a solution of Magenta, we have the following considerations. When Magenta (rosaniline and hydrochloric acid) is dissolved in water the dyestuff is dissociated into its components, viz., rosaniline and free hydrochloric acid. This fact

* In order clearly to understand this factor in the discussion, it will be necessary to explain in some detail just what is meant by *dissociation*. As an illustrative example on which to base the discussion, let us take the case of a solution of common salt, chemically known as sodium chloride. This substance in its molecular constitution is made up of one atom of sodium and one atom of chlorine; these two atoms being held together in a chemical union to form a distinct molecule of sodium chloride. If sodium chloride is dissolved in water it passes into a form evidently different from that which it possessed in the solid state. Whether this state is a liquid one or not is a question still under the consideration of physical chemistry; but whatever it may be, sodium chloride in this condition exhibits chemical properties quite different from that which it possessed in the solid state. For instance, the characteristic reaction for chlorine is its avidity for combining with silver to yield a highly insoluble white compound known as silver chloride; if powdered sodium chloride is mixed with powdered silver nitrate, both being in a dry condition and all possibilities of the presence of moisture being excluded, no chemical reaction will take place leading to the formation of silver chloride; the two substances, sodium chloride and silver nitrate, will exist side by side without any tendency to react and change their forms of chemical combination. If, however, these two substances are employed in the form of their respective solutions, and a mixture of the two is made, there will be immediately formed a white precipitate of the insoluble silver chloride while a corresponding amount of sodium nitrate will be left in solution. The fact of the chemical reactivity of a substance when in solution, after much careful study and experimentation, has been attributed to the decomposition of the molecules of the substance in such a manner that the separate atoms are more or less free to combine with other atoms in a similar condition which may be brought into their immediate proximity. When the sodium chloride is dissolved in water, it is supposed that the molecule is split up—*dissociated*—into the separate atoms of sodium and chlorine, and these are held in some physical manner by the solvent; the solution of silver nitrate may be considered in the same manner, and when the two solutions are brought together we may suppose that the atoms of chlorine and silver are free to combine; and as fast as they combine, as the resulting compound (the silver chloride) is insoluble in the solvent, the former is precipitated; this process goes on until all of the silver or all of the chlorine (depending upon which one is in excess) has been used up. Dissociation, then, with respect to dissolved substances (and this is the only phase of the question which comes under our consideration in this connection) really means that the forces which hold the constituent atoms of the molecule together as a distinct physical unit are more or less broken down, so that the atoms are much freer to enter into other combinations if the other conditions for such are favorable.

is evidenced by the experiment of the selective capillary absorption of the dyestuff solution by the strip of blotting paper. Now when wool is placed in this solution it combines with the rosaniline base, and according to Knecht, this combination is a truly chemical one, because he claims that there is to be found in the dyebath an amount of ammonium chloride equivalent to the amount of rosaniline base taken up by the wool. This point of the hypothesis, however, needs to be substantiated by further work in quantitative experiments before it can be accepted without modification. Knecht supposes that the rosaniline base reacts with the wool in such a manner as to displace an equivalent amount of the base (ammonia) naturally existing in the fiber; hence the occurrence of the ammonia compound in the dyebath after the dyeing operation has been concluded. Some coloring matters, it is claimed, are not very greatly dissociated when dissolved in water, and hence these do not dye wool as readily as others which are more completely dissociated. The dyeing properties of such dyes, however, may be considerably enhanced by the addition of an alkali (such as borax, soap or soda ash) to the dyebath, whereby the color base is liberated from its combination with the acid; or the same effect may be obtained by increasing the acidity of the wool fiber itself by chlorination. As silk possesses acid properties of a more pronounced character than wool, it will combine more readily with the general class of basic dyestuffs in a neutral solution. In the case of the acid dyes, it is supposed that most of them are not very highly dissociated in solution, hence the necessity of adding a strong mineral acid (such as sulphuric acid) to the dyebath, which considerably increases the dissociation of the dissolved dye salt. On the other hand, there are a few of the acid dyes which possess a much greater degree of dissociation in solution, and it is consequently possible to dye wool with these in neutral baths.*

While many of these theories may explain certain examples of dyeing, none of them offers a satisfactory and complete explanation of the whole general field of dyeing. This may be accounted for by the fact that the dyestuffs employed are of varied chemical composition and properties, and a theory which would satisfactorily explain the behavior of one dyestuff would be wholly inadequate to explain that of another possessing entirely different chemical characteristics. Again, even if we confine our attention solely to the consideration of the textile fibers as the substance to be dyed, we meet with variations in chemical characteristics

* There are also certain dyes, such as the general class of phthaleins, which appear to be taken up by the wool fiber in the form of their alkali salts, rather than as the color acids; this is shown by the fact that the alkali may be detected in the ash of the dyed fiber. In such a case, the chemical theory again fails to account for the facts as observed; though it is perfectly permissible for us to suppose that the fiber dissolves the dye salt *in toto* rather than any component, such as the color-acid.

as well as wide differences in physical properties and structure; and hence it may easily be understood that a theory which would explain the manner of applying dyestuffs to one fiber would not necessarily be the proper one to explain the dyeing of another kind of fiber.* Wool, for example, is very different from cotton in both its chemical characteristics and physical properties, and though the chemical theory of dyeing with respect to wool with acid and basic coloring matters might be quite acceptable, nevertheless, it would not serve in any manner to explain the relation between cotton and the substantive dyestuffs.

Though we cannot regard the chemical activity of the fiber toward the dyestuff as primarily the cause of dyeing, nevertheless there can be no doubt but that this factor often exerts a determining influence in the process. This is especially true when we consider the chemical relations between the acid and basic dyes and the animal fibers wool and silk. The chemical combination possible between the fiber and the dyestuff in this case no doubt determines the fixation of the solution of the coloring matter in the substance of the material dyed.†

* Owing to the very diverse materials employed in dyeing and their various relations to the different fibers, it is hardly possible that any one theory will be general enough to explain all cases of dyeing, and it is probable that any one of the theories briefly outlined above may properly account for a certain set of phenomena while failing to fit in with the demands of other reactions in dyeing. The explanation of any particular dyeing process must take into account the known facts, and it is foolish to attempt to fit all processes into the terms of a single academic theory that may only partially represent the actual facts.

† If a substance is soluble in two solvents, and both of the latter are present simultaneously, the substance will be distributed between the two solvents in amounts depending on the relative solubilities in the latter. Applying this law to the conception of the dyeing process, we have the water and the fiber as the two solvents and the dyestuff as the substance to be dissolved. If the dyestuff is much more soluble in the water than in the fiber we will find that in dyeing the latter it will take up the color until a certain point is reached, and then no more color will go on, although there may still be a large amount of color left in the dyebath. A point of equilibrium has been reached between the solubility of the dyestuff in the fiber and in the water and it will only be possible to dissolve more of the dyestuff in the fiber by altering the conditions determining the solubility of the color in the water. The relative solubility of the coloring matter in the fiber is commonly known as the "exhaustion" of the dyebath; consequently if the dyestuff is much more soluble in water than it is in the fiber the exhaustion of the bath will be small, whereas if the opposite is the case the exhaustion will be great. In some cases, the exhaustion of the bath is almost perfect; that is to say, practically all of the color is taken up by the fiber. This would indicate that the solubility of the dyestuff in the water is almost negligible compared with its solubility in the fiber. It is also probable that in such cases, a chemical reaction between the dyestuff and the fiber (or some mordant on the fiber) may exert considerable influence; for if such a chemical union did take place there may be the formation of an insoluble compound which would leave the fiber free to dissolve more of the coloring matter from the water, which in turn would be precipitated and fresh amounts would again be dissolved by the fiber, and this process would keep up until all of the dyestuff had been removed

The process of dyeing may be said to be a phenomenon primarily dealing with solutions, for in all cases of true dyeing the coloring matter, or the substances which eventually go to make up the coloring matter, are employed in the form of solutions. As dyeing has more especial reference to the coloring of the textile fibers in one form or another, and as the coloring matters are practically used solely in a solution in water, it will be unnecessary for us to go beyond the consideration of these two factors. As far as any relations which may exist between the water solvent and the dyestuff, it may be said that they would all fall under the proper considerations of the theory of solutions; and furthermore, any relations which may exist between the fibers and the solvent would also be considered under the same general subject; the last set of relations we have to deal with (that between the fibers and the coloring matter) would naturally be considered as relations existing between two solids, or rather a solid and a dissolved substance.

In the first place, let us consider for a while the nature of the textile fibers * without reference to any connection it may have with the theory of solution. All of the textile fibers may be considered as substances of a colloidal nature—that is to say, they are not crystalline in structure. It may be said that they somewhat resemble a solid jelly; in the case of the animal fibers this is especially so, for both silk and wool are of a gelatinous nature in the water or until the chemical action between the dyestuff and fiber had become complete. This condition probably holds in the case of dyeing Alizarine colors on mordanted wool, as in this case, without doubt the dyestuff forms a chemical compound with the mordant; hence we find that these dyes give a very thorough exhaustion of the bath. On the other hand, in the dyeing of cotton with substantive colors, there is no reason to suspect any chemical union between the fiber and dyestuff, and we find that the exhaustion is relatively poor.

* That the chemical nature of the fiber, however, does enter as a considerable factor into the dyeing process is also shown by the fact that often the fiber may be so altered in its chemical properties as to exhibit quite a marked change in its relation to the dyestuff. When wool, for instance, is chlorinated (that is, treated with a solution of bleaching powder,) it exhibits a largely increased affinity for many coloring matters, especially towards certain basic and substantive dyes. The cellulose of vegetable fibers is rather easily oxidized by certain substances, such as chlorine, chromic acid, hypochlorites, etc. Probably the substance known as *oxycellulose* is formed, and this possesses the property (not possessed by ordinary cellulose) of dyeing directly with many basic coloring matters, while its reactivity with many of the substantive dyes is noticeably diminished. In the same manner, by the nitration of cellulose it acquires a strong affinity for the basic dyes. The cellulose of artificial silk, for example, may be readily dyed with such basic colors as Methylene Blue, Malachite Green, Magenta, etc. By treating wool with a solution of sulphuric acid and then washing thoroughly to remove all uncombined acid, we find that the fiber possesses a considerably increased affinity for most acid dyes. According to the chemical theory the combination of the wool with the acid should decrease the basicity of the fiber, and consequently should lessen its affinity for acid dyes; but on the contrary, we see that the "acidified" wool dyes better with acid dyes than ordinary wool. No doubt the acid colors are more soluble in the acidified wool.

inous nature; and even with cotton, and the vegetable fibers in general, the fiber consists of a membrane or vegetable tissue which may be said to resemble physically a dried starch filament. In both the animal and vegetable fibers, therefore, it may be seen that this colloidal nature is very marked, and is really the one physical property which both classes of fibers possess in common. Now a jelly or gelatinous-like substance,

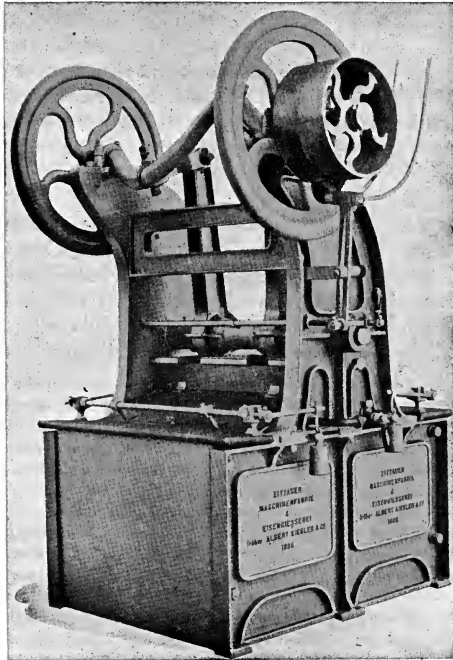

FIG. 278.—Small Fulling Washer for Flannels, etc.

though it is really a solid, nevertheless possesses some of the characteristics of a liquid, especially with reference to the property of dissolving substances. Starch paste, jellies made from vegetable gums, or animal gelatin, or albumin, all have the power of dissolving various substances such as metallic salts or other inorganic materials, as well as dyestuffs or similar organic substances. Therefore it may be said that the fibers themselves possess some of the same kind of properties which we know to be

characteristic of similar colloidal bodies. It may be perfectly proper then to say that wool, silk, and cotton are capable of dissolving mordants or dyestuffs in the same general manner that any other solvent would.

If we take a stiff jelly prepared from animal gelatin or a vegetable gum such as agar-agar, for example, and place it in a solution of ferric chloride, the jelly will absorb some of the metallic salt from its aqueous solution and form with it really a solution itself, which may be evidenced by placing the jelly into a solution of potassium ferrocyanide, when soon the whole mass of jelly will be colored blue by the formation of Prussian Blue due to the combination of the ferrocyanide with the ferric salt. In the same way, if the jelly be placed in a solution of a dyestuff, it will be found that the coloring matter will gradually be absorbed and dissolved in the jelly. This illustration may be taken to represent in some degree the phenomena which occurs in the dyeing of the various textile fibers. The dyestuff may be considered as being dissolved in the substance of the fiber, just as a solution of the dyestuff consists of the solid coloring matter dissolved, in water. And the same conception may be held as to the relation between the fiber and the various metallic or other mordants with which it may be treated previous to dyeing.

The difference in the behavior of the same dyestuff towards different fibers may be explained by supposing that the various fibers exert a different solvent action, just as different liquids exert a different solvent action on the same solid material. For instance, if wool is boiled in a solution of Orange II, the color will be rapidly taken up and the fiber becomes dyed; if cotton, however, is used, the fiber will only become slightly tinted. In other words, the wool has a strong solvent action with regard to this coloring matter while the cotton hardly dissolves it at all. On the other hand, if Mikado Yellow is used as the dyestuff, the wool will be left practically undyed while the cotton will be deeply colored; so in this case it may be said that the Mikado Yellow is insoluble in wool though readily soluble in cotton. As a rule, the animal fibers, wool and silk, exhibit solvent properties which are very similar, and on the other hand, cotton, linen, and the vegetable fibers in general, exhibit similar properties. This may no doubt be conditioned very largely by the chemical nature of the two classes of fibers, though we also have cases where there appear to be distinctive properties between wool and silk. For instance, if silk is dyed in an acidulated bath with Indigo Carmine, it will take up the coloring matter quite readily, but if a mixture of silk and wool be dyed in such a solution, it will be found that the wool will take up the color almost exclusively, the silk only becoming slightly tinted. This is explained by supposing that the wool dissolves the dyestuff much more readily than the silk.

There are several factors which may influence considerably the solvent action of the fiber for the coloring matter. Heat is one of the principal

of these.* As a rule, dyestuffs are much more soluble in the fibers at a boiling temperature than at lower ones; on this account, the dyeing process is mostly carried out in a boiling solution. If wool, for instance, is dyed in a cold solution of Naphthol Yellow it will take up but very little color; but, if it is dyed in a boiling solution of this dyestuff, it will become colored an intense yellow. This is explained by supposing that at low temperatures, the dyestuff is only slightly soluble in the fiber, whereas at higher temperatures its solubility in the fiber becomes much increased.

The presence of certain chemicals in the dyebath also has an important influence in the regulation of the dyeing. In the case of acid dyes, the presence of acid (such as sulphuric or acetic) liberates the free color-acid from the dyestuff salt and thus promotes and accelerates the dyeing by allowing of the ready and complete combination between the fiber-base and this color-acid. We may represent this reaction somewhat in the following graphical manner:

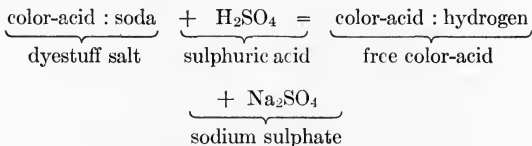

If wool, for example, is boiled in a solution of Ponceau it will only take up a rather limited amount of the color, however long the boiling may be prolonged; but if a small quantity of sulphuric acid is added to the solution, the wool will become dyed quite a heavy color and practically all of the dye is taken up by the fiber. It might be possible to explain this case of dyeing in another way than having resort to the chemical theory of the combination of the color-acid with the wool-base; it might be claimed that the addition of the acid simply increased the solubility of the dye in the substance of the fiber and was not necessarily evidence of any chemical combination on the part of the wool. But owing to the fact that it has been found that the addition of acid to the dyebath is necessary in cases of a large number of the dyes belonging distinctively to the color-acid group of dyes, it is more reasonable to suppose that the chemical explanation is a

* Heat appears to play an important role in dyeing as it does in all forms of solution. By elevating the temperature the mobility of the molecular aggregates of both the dyestuff and the fiber is increased so as to allow of a more intimate mixture of these molecules with one another. The rapidity and degree of dyeing is nearly always greater in a hot dyebath than in a cold one; and the proper regulation of this temperature permits the dyer to so regulate the taking-up of the color by the fiber as to obtain even and well-penetrated dyeings.

closer approximation to the truth. In this connection, however, it is to be observed from the other point of view that there are some of the acid dyes which dye on wool very well from a neutral bath; it is true that the number of these is rather limited, and the dyeing may be explained by the fact that the dyestuff when dissolved in the bath is more or less dissociated into the free color-acid and the sodium salt, and the reaction, therefore, is still a question of the chemical combination between the color-acid and the wool-base. But it is not well to be too certain that this represents the whole truth; it is quite possible that with the acid dyes both the chemical reaction of the color-acid and wool-base and the solution reaction between the fiber and the coloring matter come into play. It may be simply that the free color-acid of the dye is more soluble in the fiber than the dye itself.*

In some cases the addition of alkalies to the dyebath somewhat increases the solubility of the dyestuff in the fiber; this is particularly true, for example, in the case of certain substantive dyes with relation to the cotton fiber. If cotton is dyed in a neutral solution of Benzopurpurin 4B it will be found that only a relatively small quantity of the color is taken up by the fiber while most of the dye will remain in solution in the dyebath. The addition of some soda ash to the bath, however, will cause more of the dye to be absorbed, and this notwithstanding the fact that the dye is more soluble in the alkaline liquor than in the neutral bath. The addition of neutral salts that will decrease the relative solubility of the dye in the water will also serve the same purpose. If, for instance, in the case of Benzopurpurin 4B, some common salt is added to the dye solution the color will feed on to the fiber much better. It is not probable here that the solvent action of the fiber is increased, but simply that the solvent action of the bath is decreased, causing a new equilibrium to be established between the relative solubilities of the fiber and the bath.

The use of Glaubersalt in the dyeing of acid and basic dyes presents a different problem from that of salt (or even Glaubersalt itself) in the dyeing of substantive dyes. The Glaubersalt, as we know, is used for the purpose of obtaining more level colors and seems to retard the absorption of the dye by the fiber and also to increase its solubility in the dyebath. The last statement is borne out by the fact that wool dyed with an acid color is more or less stripped when boiled in a solution of Glaubersalt, while it might not be so affected when boiled in plain water. One explanation of the

* Some of the color-salts are much more soluble in wool than others, and this explains why certain of the acid dyes may be applied to this fiber comparatively well in neutral baths. It may also be remarked that the free color-acids of the acid dyestuffs are much less soluble in water than their salts, and as the exhaustion of the color from the dyebath by the fiber is really dependent on the relative solubilities of the coloring matter in the water and the fiber, it may be seen that the addition of the acid to the bath also decreases the solubility of the coloring matter in the water, and hence increases its relative solubility in the fiber.

action of Glaubersalt is that its presence serves to distribute more perfectly the dyestuff molecules through the fiber substance; it may be said to impede the progress of the dyestuff molecules in their passage from the water solution to that of the fiber. The number of Glaubersalt molecules is very large compared with the number of the dyestuff molecules, and hence its action may be compared to that of a large crowd of people impeding the progress of a man walking towards a definite point. This explanation, however, is not perfectly satisfying. From another point of view it may be considered that the effect of the Glaubersalt is to retard the action of the acid in breaking up the dye into the color-acid and also to diminish the solubility of the dye in the fiber.

The basic dyes appear to become dissociated when dissolved in water; that is to say, the color-base of these dyes becomes spontaneously separated from the acid with which it is combined in the form of its dyestuff-salt; and the free color-base thus formed combines readily with the acid component of the fiber to form the color-lake. Therefore the basic dyes can be applied to the animal fibers in a neutral dyebath. As a rule, however, they are taken up too rapidly by the fiber to allow of even dyeing, so the bath is usually made slightly acid (with acetic acid) in order to retard the dyeing action.

The mass-relations existing between the fiber, the dyebath, and the dyestuff also have an important influence in the dyeing reaction. It would be natural to expect that the greater the concentration of the dyebath, that is, the greater the mass of the dyestuff in proportion to the mass of the water, the more color will be taken up by the fiber. The same, of course, is true when the mass of the fiber is greater in proportion to that of the water.*

2. Theory of Dyeing in Relation to Pigment Colors.—The views on the theory of dyeing which have been so far given cover those problems which have to do with the general classes of coal-tar dyes. We have, however, other classes of dyeing to which a somewhat different interpretation must be given. If a skein of cotton yarn is steeped in a solution of lead acetate there will naturally be a considerable amount of the solution absorbed by the fiber through capillary action; the lead salt, however, has not dissolved in the fiber or become at all permanently fixed therein, as it may practically all be removed by repeated washings in water. If, how-

* As already pointed out, this amount is dependent on the relative solvent power of the water and the fiber; hence, other things being equal, if there is a large amount of fiber, the latter will take up much less color than if the conditions were reversed; that is to say, the fiber will be dyed more deeply in concentrated solutions than in dilute ones, a result which would naturally be expected. In using dyes which are very soluble in water, therefore, it is customary to employ "short" dyebaths; that is, as small a quantity of water as possible is used; whereas, when the dyestuff is much less soluble, it is customary to employ more dilute dyebaths.

ever, the skein of yarn is not washed after being so impregnated with the solution of lead acetate, but is simply squeezed so as to remove the surface liquor, and is then passed into a solution of bichromate of potash, it will become dyed a beautiful deep yellow, and the coloring matter consists of Chrome Yellow. The dyeing process in this instance cannot be regarded in any other way but as a deposition of an insoluble pigment in the pores of the fiber. If a solution of lead acetate is mixed with one of bichromate of potash, irrespective of the presence of any fiber at all, the same yellow pigment will be formed by a double decomposition between the two chemicals resulting in the formation of an insoluble lead chromate. If this reaction takes place in the presence of the fiber, the insoluble pigment will be precipitated in such a manner that it will be contained in the pores and interstices in the fiber with the result that the latter will become uniformly colored. If, however, a fiber dyed in such a manner be examined under the

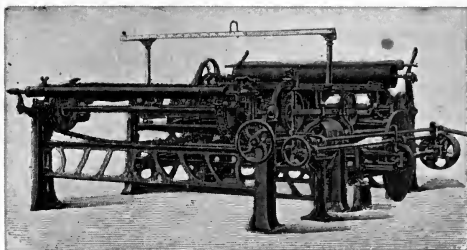

FIG. 279.—Expanding and Equalizing Machine.

microscope, it will be observed that the particles of precipitated pigment may be readily observed; a condition which will not be found in the case of a fiber dyed with the usual dyestuffs.

The general process of dyeing of which Chrome Yellow is the type, extends to practically all cases of mineral or pigment dyes, such as Iron Buff, Manganese Brown, etc. In all such cases there is simply a precipitation by chemical reaction between two soluble salts in the fiber of an insoluble pigment. The same is also true of Indigo dyeing. In this case the fiber is impregnated with a solution of indigo-white, which is subsequently oxidized and the resulting insoluble blue Indigo is precipitated as a pigment in the fiber. This process of dyeing may be called dyeing by "impregnation," and is essentially different in its nature from the ordinary processes of dyeing where the true dyestuffs are employed. There are also other cases where the coloring matter is built up or formed in the fiber by chemical means; such, for instance is the dyeing of cotton with Parani-

traniline Red, and other colors of this same class. In this case, the cotton is first impregnated with a solution of one of the eventual components of the dyestuff to be formed; i.e., beta-naphthol. The material so prepared is then brought in contact with the second ingredient of the dyestuff; i.e., the diazotized solution of paranitraniline. The resulting compound is an insoluble red pigment, and consequently this method of dyeing must be regarded as coming under the "impregnation" process.

3. Theory of Dyeing in Relation to Compound Shades.—So far we have only considered the case of the relation between the fiber and one single coloring matter. When several dyestuffs are employed simultaneously the relations are more complex. If the dyes employed possess equivalent "affinities" for the fiber, they will be taken up or dissolved by the fiber uniformly; but if, however, their "affinities" are different, as is more generally the case, then the coloring matter possessing the strongest attraction for the fiber will be taken up from the dye solution first, other things being equal; and those dyes having a weaker attraction will be taken up in proportionately smaller amounts during the same period of dyeing. From this it is evident that the dyestuffs having the greatest affinity for the fiber will be exhausted from the dyebath more quickly and more completely. Suppose, for instance, that a reddish brown is to be dyed on wool, there being used for this purpose Fast Red A, Fast Yellow and Patent Blue V, as the dyestuffs. In the first period of the dyeing operation most of the Fast Red A will be taken up by the fiber together with small quantities of the yellow and blue dyestuffs. On continuing the dyeing process in a short while the red coloring matter will be almost completely exhausted from the bath, and the color of the dye liquor, which at first was brown, becomes olive, then green, and finally as most of the yellow is slowly taken up by the fiber, the bath becomes almost pure blue in color, due to the residue of Patent Blue which is left.

The inter-relations, however, between the affinities of several dyes when applied simultaneously does not hold for different proportions among the amount of dyes that may be present. For instance, in the above example, if the amount of Fast Red is decreased, the fiber, of course, will no longer take up the same actual quantities of yellow and blue dyes as before, but it is likely that it will absorb more. In other words, the masses of the several dyes present in varied colors have a considerable influence on the relative affinities of the dyes for the fiber. This idea may be illustrated in the following manner: Suppose we have the following combination of dyes:

1 per cent of Fast Red A
1 per cent of Fast Yellow
1 per cent of Patent Blue V

The respective amounts actually taken up by the fiber may be as follows:

1 per cent of Fast Red A
 $\frac{3}{4}$ per cent of Fast Yellow
 $\frac{1}{4}$ per cent of Patent Blue V

Whereas, if the following combination of dyes had been used:

$\frac{1}{10}$ per cent. of Fast Red A
 1 per cent of Fast Yellow
 1 per cent of Patent Blue V

there would be taken up by the fibers:

$\frac{1}{10}$ per cent of Fast Red A
 1 per cent of Fast Yellow
 $\frac{1}{2}$ per cent of Patent Blue V

In other words, a change in the proportion of dyestuffs present will seriously alter the proportion of coloring matter absorbed by the fiber.

4. Theory of Dyeing in Relation to Mixed Fibers.—Another phase of the dyeing process is in the consideration of the relative affinities when one dyestuff is applied in the same bath simultaneously to two different fibers. This question comes up in a practical manner in the dyeing of union goods composed of wool and cotton, or of half-silks composed of silk and cotton, or of gloria composed of wool and silk. A good example, in this connection, is the behavior of Curcumin S; this coloring matter is readily taken up by wool from an acid bath and by cotton from a neutral bath. If both of these fibers, however, are present even in an acid bath, the cotton will take up the color almost exclusively, while the wool is left practically undyed. This curious result is to be explained by the fact that the cotton fiber has a much greater affinity for this dyestuff than has wool, and this is sufficient to almost neutralize the action of the dyestuff on the latter fiber. Another example is that of Purpuramine; this dyestuff is a substantive coloring matter and gives a rose-red color on cotton in a neutral bath. If, however, wool is present in the same bath with the cotton, nearly the whole of the coloring matter is taken up by the wool and the cotton remains almost white. Furthermore, this same result is obtained if cotton and silk are dyed together in the same bath with Purpuramine, the silk being strongly colored, while, as before, the cotton is scarcely tinted. From this it may be seen that though Purpuramine is classed as a substantive or direct dye for cotton, it has a much greater affinity for the animal fibers. An example of the reverse action is that of Benzo Pure Blue; this dyestuff when dyed in a single bath on wool-cotton or silk-cotton material, is taken up only by the cotton, leaving the wool or the silk almost white.

Indigo Carmine dyes both wool and silk in an acid bath when either fiber separately is used; but when both of these fibers are dyed simul-

taneously in the same bath the wool takes up nearly all of the dyestuff and the silk is only slightly tinted. These examples are sufficient to show the complex nature of the relations between one dyestuff and two fibers, and the influence the presence of one fiber has on the affinity of a dyestuff for another fiber.

We may extend the consideration of these relations still further to the distribution of two dyestuffs between two or more fibers. As an example of this may be given the dyeing of a mixture of wool and cotton in a single bath with Curcumin S and Purpuramine. In this case, the cotton will be dyed yellow and the wool red. The same result will also be obtained if a mixture of cotton and silk is dyed with this combination of dyestuffs, the animal fiber being dyed red while the cotton is dyed yellow. In a similar manner, if a mixture of Purpuramine and Benzo Pure Blue is used, the cotton will be dyed blue and the animal fiber will be dyed red. If a mixture of the above three dyes is used, the cotton will be dyed green, while the animal fiber will be red. Of course, the mass action of the dyestuff used as well as that of the fibers will also come into play and influence the results more or less.

5. Different Factors in the Theory of Dyeing.—In summing up the consideration of the theory of dyeing, it may be said that the following factors enter into the question:

(1) The *solution factor*, which may be defined as the difference existing between the degree of solubility of the coloring matter in water and that of its solubility in the substance of the fiber. This might be called the "affinity" of the dyestuff for the fiber.

(2) The *fiber factor*, depending on the nature and condition of the material being dyed.

(3) The *dyestuff factor*, depending on the chemical nature of the dyestuff used.

(4) The *chemical factor*, which includes any chemical reaction which may occur between the fiber and the dyestuff.

(5) The *temperature factor*, which describes the effect of the temperature of the bath on the relations between the dyestuff and the fiber.

(6) The *salt factor*, which relates in a similar manner to the effect of the presence of certain neutral salts in the bath on the dyeing process.

(7) The *mordant factor*, or the influence of the presence of certain metallic compounds in the fiber on its affinity for the dyestuff.

(8) The *capillarity factor*, a physical property of the dye solution which has to do with the force with which the dyestuff solution is absorbed by the fiber mechanically.

(9) The *osmosis factor*, another physical relation between the dye solution and the fiber, it being the force with which the dissolved dyestuff tends to pass through the cell-wall of the fiber.

(10) The *concentration factor*, depending on the strength or concentration of the dyebath with reference to the amount of dissolved dyestuff per unit volume.

(11) The *bath factor*, or the ratio between the amount of fiber being dyed and the amount of dye liquor.

(12) The *surface-tension factor* existing between the dye solution and the colloidal substance of the fiber.

(13) The *dyestuff mass-action factor*, being the influence of the relative amounts of two or more dyes in the same bath.

(14) The *fiber mass-action factor*, or the influence of the relative amounts of two or more fibers in the same bath.

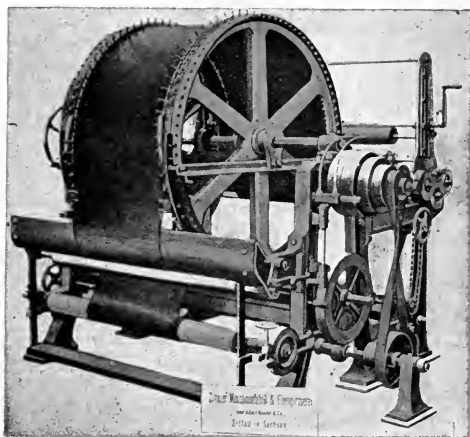

FIG. 280.—Revolving Tenter and Equalizing Machine.

6. Theory of the Mordanting Process.—Fibers which are indifferent towards certain dyes may usually be so changed in their properties by the use of suitable mordants as to have their affinity towards these dyes so increased that they may be dyed thereby. For instance, cotton has no affinity of itself for the basic or acid dyes, but if it is saturated with an acid mordant such as tannic acid or a fatty acid it may then be dyed with the basic colors; or if it is mordanted with a basic mordant, such as alumina or sodium stannate, then it may be dyed with acid colors. Wool and silk have no affinity for most of the Alizarine class of dyes, but if these fibers are mordanted with metallic oxides, such as the oxides of chromium, aluminium, iron, tin, etc., then they may readily be dyed with Alizarines. The mordanting of cotton with tannic acid or fatty acids is probably a

purely mechanical process; although the proper fixation of these mordants in the fiber by means of tartar emetic or alum is a chemical process. The mordanting of the animal fibers with metallic salts is probably for the most part a chemical process, the metallic salts or oxide forming a chemical compound with the substance of the fiber. It is usually considered in the case of mordanting wool, for instance, with metallic salts, that the metal is precipitated in the fiber as the oxide or hydroxide; in certain methods of printing, this may be a fact, but in the ordinary processes of mordanting wool for dyeing, it cannot be considered that the oxide of the metal is directly precipitated in the fiber. It is possible, for instance, to mordant the wool by boiling in a bath containing a solution of alum, squeezing, and then passing through a bath containing ammonia water; this would cause the precipitation of aluminium hydrate on and in the fiber as an insoluble body. As an actual fact, however, the mordanting is not done in this manner, but is carried out by boiling the wool with a solution of alum and tartar, which it cannot be presumed would lead to the precipitation of aluminium hydrate. A similar condition also holds in the mordanting of wool with chrome; chromium hydrate is a greenish blue body, and if this substance were precipitated in the fiber by the usual methods of mordanting, the wool should have a greenish blue appearance; but as a matter of fact it has a yellow color, which is a certain indication that chromium hydrate has not been precipitated in the fiber. Indeed, it would be difficult to explain, in a chemical manner, just how chromium hydrate could be formed by boiling wool in a solution of potassium bichromate and tartar or lactic acid, and more so as it is well known that certain organic bodies, such as sugar, glycerol, organic acids, etc., prevent by their presence the precipitation of chromium salts.

In mordanting cotton the case is somewhat different for the metals employed as mordants are usually in the form of basic salts, and the solutions of these by great dilution, by long exposure to the air, or by warming may become dissociated and there may be precipitated either the hydroxide of the metal or a strongly basic salt, for example, in mordanting cotton with acetate of aluminium a hydrate or basic acetate is formed. This, however, cannot be considered as "precipitation" in the chemical sense of the term. Although it may be shown that when cotton is steeped in a readily dissociated solution of aluminium acetate, a portion of the aluminium is withdrawn from the bath, it cannot be shown, however, that aluminium hydrate as such has been precipitated in the fiber. If such were the case, washing with lukewarm acetic or hydrochloric acid would remove all the hydroxide from the fiber again; but this does not happen, which is an indication that the aluminium must be fixed in the fiber in some other form.

A properly mordanted fiber requires that the metallic compound with

which the fiber is mordanted must be held by this in such a form and with sufficient energy that the mordant cannot be removed by water or even by dilute acids or alkalis. According to Witt's theory of solid solution, the metallic mordant is dissolved in the solid fiber. Another explanation is that the metallic salt may enter into chemical combination with the fiber forming a metallo-organic compound.

If wool is mordanted in a bath containing copper sulphate and sulphuric acid, the blue color of the liquor on boiling soon becomes lessened, and the wool is colored at first yellowish and then canary-green. After twenty or thirty minutes' boiling the bath becomes perfectly clear; the copper has been taken up by the wool quantitatively, and the presence of copper can no longer be detected in the liquor by testing with ammonia. That the copper is not contained in the wool as hydrate is apparent by reason of the presence of free sulphuric acid in the bath; and besides, the color of copper hydrate is bluish gray, while the wool is of a yellowish green color. This latter color is similar to that of the basic acetate of copper and other salts of copper with organic acids. This would seem to indicate that the wool had formed a chemical compound with the copper. If wool is boiled in a bath containing copper sulphate and tartar, even after two hours' heating, the greater part of the copper will still be left in the bath and is not taken up by the wool. It is probable that the addition of tartar in this case hinders the reaction between the wool and the copper by changing the compound at the moment of its formation into copper tartrate. The same considerations naturally enter into the mordanting of wool with alum and tartar. The use of tartar is only reasonable in the case of chrome mordanting, for here it acts as a reducing agent; also in mordanting with ferrous sulphate, which eagerly takes up oxygen and precipitates the hydrate, or at least, a basic sulphate, the action of tartar is useful, as it prevents the formation of the oxidized salt, and hence acts in this case also as a reducing agent. But with copper sulphate and with alum there is nothing to reduce; hence why use the tartar. As a matter of fact, in mordanting with alum, better results are obtained by the addition of sulphuric acid than by the addition of tartar. It is true, the bath is not quantitatively exhausted, but the wool takes up a greater quantity of the aluminium compound in a shorter time than when tartar is used.

Furthermore, if wool is mordanted with chrome and lactic acid, the bath at first is yellow, then green, and finally colorless, while the wool becomes only slightly colored, in spite of the fact that all the chrome has been taken up by the fiber. If chromium hydrate were in the fiber, the color of the latter should be bluish green, and if a salt of chromium oxide as such were in the fiber, the latter would be green. As this is not the case, however, the chromium must be combined in the fiber in some other form.

Even more striking is the case of wool mordanted with iron; if wool

is boiled with ferrous sulphate and oxalic acid, the fiber remains almost white and retains this color even on drying in the air. Freshly precipitated ferrous hydrate is generally at first pure white; in a few seconds, however, it becomes green, then dark green, black-green, black, and finally reddish brown. If ferrous hydrate had been precipitated on the fiber it would rapidly show this alteration in color; but such is not the case.

All these facts appear to show that in mordanting with metallic salts the metal is combined with the fiber in the form of a metallo-organic compound, and the fiber thus chemically changed then possesses the proper affinity for dyeing with the mordant dyes.

This explanation of the mordanting process, of course, is not applicable to cases where the mordanting takes place in two baths in such a manner that in the first bath the fiber is simply mechanically impregnated with the solution of a substance which will yield a precipitate with a solution of a metallic salt. When cotton, for example, in the dyeing of Turkey Red, is impregnated with Turkey-red oil, and after drying, is mordanted with a solution of aluminium acetate, there is formed a sulphoricinoleate which is precipitated uniformly through the cotton fiber as an insoluble compound. Furthermore, in the waterproofing of cloth, the wool is first treated with a warm solution of a neutral soap, then squeezed out and treated with a warm solution of copper sulphate; whereby in a similar manner, copper palmitate is formed, which is an insoluble body, and is not taken up by the wool chemically. To the same class belongs the mordanting of cotton with tannin and antimony; there is at first simply an impregnation of the cotton with the tannin solution, and secondly a treatment with tartar emetic which converts the tannin into a difficultly soluble antimony tannate, which is mechanically held by the cotton fiber.

7. Experimental. Exp. 234. Study of the Factors in the Dyeing Process.—These factors are: The *fiber*, the *dyestuff*, the *water*, and the *temperature*. In order that dyeing may take place it is necessary that the *affinity* of the dyestuff for the fiber be greater than its affinity for the water. Place wool in a hot solution of Acid Green, and it becomes dyed an intense color. Cotton in an acid solution of Orange II even on prolonged boiling is scarcely tinted. Dye wool in a *boiling* acid bath of Naphthol Yellow and it is well dyed; while in a cold bath it is only slightly tinted. The affinity for the fiber is greater at high temperatures than at low temperatures.

Exp. 235. Showing Condition of Equilibrium in the Dyebath.—Dye wool in a bath with 4 per cent of Ponceau and 1 per cent sulphuric acid, until the color on the fiber becomes no deeper. Test bath for acidity with Congo Red. Show that acid is exhausted and that considerable color is still left in the bath. Take a sample from the skein; add 1 per cent more of acid and continue the dyeing. It will be found that the point of equilibrium is disturbed and that the fiber will take up more dyestuff.

Dye a skein of cotton with 2 per cent of Benzopurpurin 4B, and no salt until color on skein becomes no heavier—a point of equilibrium in the dyeing has been reached. Take a sample from the skein, add 20 per cent of salt to the bath and continue the dyeing. It will be found that more color is now taken up. The addition of salt to the

bath has lessened the affinity of the dye for the water and so changed the conditions of equilibrium.

Exp. 236. Difference in Affinity Measures the Exhaustion of the Dyebath.—Dye a skein of wool with 1 per cent of Indigo Extract and 4 per cent of sulphuric acid; the bath is practically completely exhausted. Dye another skein with 1 per cent Patent Blue V and 4 per cent of sulphuric acid, and the bath is only slightly exhausted.

Exp. 237. Showing Effect of Difference in Affinity in Mixed Colors.—Dye a skein of wool with

1 per cent Fast Red
1 per cent Fast Yellow
1 per cent Patent Blue
4 per cent sulphuric acid.

Take a sample of the dye liquor before dyeing. After dyeing for five minutes take a sample from the skein and also a sample of the dye liquor. Dye ten minutes longer and take another sample from the skein and from the dye liquor. Dye for fifteen minutes

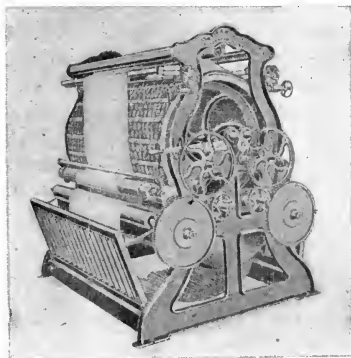

FIG. 281.—Double-acting Gig. (Curtis & Marble.)

longer and take samples again. Show the gradual change in color of the skein and the reverse change in the color of the solution, due to the rapid absorption of the red, the gradual but rather complete absorption of the yellow and the slow and very imperfect absorption of the blue.

Exp. 238. Showing How the Mass Relations of the Fiber and the Water Affect the Affinity.—Dye a skein of cotton in a neutral bath with 1 per cent Purpuramine; a rose-red color is obtained. Then dye a skein of cotton together with one of wool in a neutral bath with 1 per cent Purpuramine; it will be found that only the wool becomes dyed while the cotton remains practically white. Furthermore, dye a skein of cotton together with one of silk with 1 per cent Purpuramine in a soap bath; only the silk will be dyed. Although this dyestuff is classed as a substantive dye for cotton, in the presence of animal fibers, it no longer dyes the cotton.

Dye a skein of wool in a bath with 1 per cent Benzo Pure Blue, also dye a skein of silk in the same manner. Now dye wool-cotton and silk-cotton with this dye, when it

will be found that the cotton only will have become dyed, leaving the animal fibers white.

Dye a skein of silk in an acid bath with 1 per cent Indigo Carmine; it gives a fairly heavy shade. Now dye a skein of wool-silk in a similar manner, and it will be found that the wool dyes heavily, while the silk is only tinted.

Dye a skein of wool-cotton in a bath with a mixture of 1 per cent Curcurmine S and 1 per cent Purpuramine; the cotton will be dyed yellow and the wool red. Repeat using a skein of cotton-silk, when the cotton will come out yellow and the silk red. Dye another skein of wool-cotton with a mixture of 1 per cent Purpuramine and 1 per cent Benzo Pure Blue, when the cotton is dyed blue and the wool red. Then dye a skein of wool-cotton with a mixture of 1 per cent Curcurmine S, 1 per cent Purpuramine, and 1 per cent Benzo Pure Blue; the cotton will be dyed green and the wool red.

CHAPTER XXVI

TESTING THE FASTNESS OF COLORS

1. Fastness of Dyes.—In Chapter IX, brief methods have already been given for the testing of dyed colors to various agencies. The present chapter is intended to be a more extended discussion of this subject.

By the "fastness" of a dye is meant its resistance to the action of various agencies to change it in color or appearance.* The fastness of dyes differs very widely even among the same class; some acid dyes, for instance, are very fast while others are fugitive; and the same is true in general of the basic and substantive dyes. The mordant dyes are to be regarded as having the greatest fastness when taken as a class; and the basic dyes, as a class, are probably the most fugitive. Again, dyes may be fast to one agency and not to others; for instance, Thioflavin T dyed on cotton is very fast to washing and to fulling, but not at all fast to light.† Further, a dye may be fast on one fiber and not on another; and may be

* The fastness of a dye is more or less a relative term, as no color is absolutely fast to all agencies, therefore fastness becomes a matter of comparison with some standard which represents a satisfactory and high degree of resistance to change. Furthermore, fastness is a rather variable term and may be differently interpreted depending upon conditions. For example, when speaking of fulling we may have hot acid fulling on the one hand, as in the manufacture of hat felts; or soap and alkali fulling on the other hand, as in the finishing of flannels and buckskins, or in the more severe fulling of heavy meltons and military cloths; furthermore we may have very light fulling with plain hot water, as in the finishing of certain kinds of ladies' dress goods and worsted suitings. It may readily be understood that a dyestuff may be quite fast to water or acid fulling and yet quite useless for soap and alkali fulling. Or a dyestuff in light shades may satisfactorily withstand the fulling operation, yet bleed badly in heavy shades. Frequently the character and cleanliness of the dyed material and the method of dyeing may have considerable influence on the fastness to fulling, as well as the make-up of the liquor used in fulling. Therefore, it may be seen that no general statement of the fastness of a certain dye in this respect could be properly made without some understanding of the modifying conditions.

† Benzopurpurin, for instance, and other substantive dyes, when dyed on wool, are much faster to light and washing than when dyed on cotton. On the other hand, Methylene Blue when dyed on cotton with a tannin-antimony mordant, is much faster than when dyed directly on wool. In fact the basic colors are all faster to light when dyed on a tannin-antimony mordant than when applied in connection with other mordants.

fast when dyed by one method (or mordant) and not fast when dyed by another method (or mordant).*

2. Testing Fastness of Colors Dyed on Wool.—The chief agencies to which colors on wool are tested, together with the means of so testing them, are as follows:

(1) *Fastness to Light.*—A sample of the dyed wool is placed in a suitable frame in such a manner that only a part is exposed. The frame is then placed in such a position that it receives as strong sunlight as possible, but is shielded from exposure to the atmosphere by glass. A window with southern exposure is a good location in which to hang the frame containing the samples.† At the end of one week's exposure the samples are

* It must be borne in mind in judging the value of a dye with respect to its qualities of fastness that the degrees of fastness to different agencies are not equally important under different conditions. The kinds of fastness to be sought for depend on the use and manner of wear to which the dyed material is to be subjected. For instance, in choosing a dyestuff for application to hosiery good fastness to light is not essential whereas proper fastness to washing and perspiration is very necessary. On the other hand, in selecting dyestuffs for use with carpet yarns, attention should be given to the fastness of the color to crocking and light, while the fastness to washing and perspiration may be neglected.

† The fading of colors in light depends to a very large degree on the quality and intensity of the light to which they are subjected. Bright direct sunlight has a strong fading effect, whereas with indirect reflected light the degree of fading may be quite small. A dyed fabric, for example, exposed to the effect of direct sunlight in a window may show a distinct fading in a few days, while the same fabric at the inner part of an ordinary dwelling-room with indirect light from a north exposure may not show an equal fading until the lapse of several months or a year.

The effect of most artificial light on colors is far less than sunlight. Gas, oil lamps, and incandescent electric lighting have but little fading effect on most colors. The electric arc lamp and the ultra-violet lamp, however, if in close proximity to the color, will cause a rapid fading. Ultra-violet light, in fact, may be employed for testing the comparative light fastness of dyed colors, as close exposure of the sample to this light will give results in a much shorter time than testing in sunlight. A few hours' exposure under the ultra-violet lamp will be equivalent, perhaps, to a week's exposure to ordinary direct sunlight.

FIG. 282. — Quartz Ultra-Violet Lamp for Testing Fastness of Colors to Light. (Hanovia.)

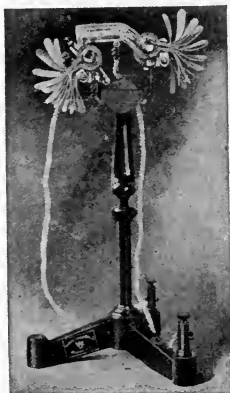

The color of the light to which the dyed material is exposed also has much influence on its fading. Dyed colors exposed to the action of red light show practically no fading at all; exposed to yellow light the fading is slight, while exposure to blue light shows the greatest fading effect. It is probably the ultra-violet or actinic rays present in light which cause the breaking down of the dyestuff and the consequent fading of the color.

examined and note made of those which show any appreciable fading; these are to be classified as **not fast**. At the end of the second week another examination is made and those samples noted which show an appreciable fading; these are to be classified as **fairly fast**. At the end of four weeks the samples are once more examined and the colors fading in this period are noted and classified as **fast**.* The samples which show no fading at the end of four weeks are classified as **very fast**.†

Dye test skeins of woolen yarn with 2 per cent each of the ten following dyes, and test samples of the colors for fastness to light in the manner above described.

1. Magenta (in neutral bath).
2. Eosin (in acetic acid bath).
3. Acid Violet (in usual acid bath).
4. Tartrazine (in usual acid bath).
5. Patent Blue V (in usual acid bath).
6. Light Green SF (in usual acid bath).
7. Diamine Scarlet 3B (ammonium acetate bath).
8. Cloth Red GA (acid bath and after-chromed).
9. Alizarine Red WS (on alum mordant).
10. Alizarine Blue NG (on chrome mordant).

In making the test for fastness to light, as the nature and amount of sunlight obtainable day by day is very variable,‡ a more accurate method is to expose, with the samples to be tested, control samples of dyes representing the four degrees of fastness to light, such as:

1. Very fast, Alizarine Red WS (on a chrome mordant).
2. Fast, Lanacyl Blue R (in usual acid bath).

* The fastness to light of some dyestuffs on wool and cotton may be materially improved by an after-treatment of the dyed color with bluestone or copper sulphate (see page 281). The exact cause for this increase in light fastness is not definitely known. By some it is supposed that the cells of the fiber become coated with a film of copper salt which acts as a protective light filter in cutting off the actinic rays. This theory, however, has little or no experimental evidence in its favor. Another explanation is that the copper forms a combination with the dyestuff, and the color-lake so produced has more stability towards light. This, however, is also a mere theory with no known data in its support.

† According to the calculations of Sir Wm. Abney the fading power of one month's direct sunshine on a color is equal to a hundred years of ordinary diffused daylight in a room.

‡ Other conditions besides the light also effect the fading of colors. It has been shown that dyed colors exposed in a vacuum fade very much less than the same colors exposed in air under the same conditions of light. Colors exposed in moist air fade a great deal more than the same colors similarly exposed in dry air. Furthermore colors do not fade to the same extent under the influence of differently colored rays of light. Violet and blue rays appear to have the strongest action, whereas the red rays are weakest. The yellow and green rays have an effect between these two extremes.

3. Fairly fast, Alkali Blue R (in neutral bath and developed with acid).
4. Eosin (in weak acetic acid bath).

The samples are examined from time to time, and those colors fading in the same periods as the control samples are noted and classified accordingly. In this manner the variable effect due to the inconstant degree of light is eliminated, and the tests made comparable to certain fixed standards.

Another light relation with respect to dyed colors to be observed is the change in tone which sometimes occurs when the color is viewed in artificial light as compared with the tone as seen in daylight. The color of many dyes changes quite considerably under these conditions, and frequently this is very undesirable when the color is applied to fabrics used for evening wear. The colors on different parts of a suit or gown may match satisfactorily in daylight, but when seen in artificial light objectionable differences may be apparent. This is especially to be noticed in the case of blacks and blues, which under the influence of artificial light may change to prune or violet tones. These changes in tone were more noticeable formerly than at present owing to improvements in artificial illumination whereby the light now used (tungsten filaments) has more the color balance of daylight than the former very yellow gas and oil lighting.

(2) *Fastness to Washing.*—This test is to represent the fastness of a dye to washing or scouring with soap and water. Dyed woolen material of almost any character should be capable of standing a more or less severe scouring, as such an operation is always necessary in the cleansing and finishing of woolen goods in the course of their manufacture. Material dyed as loose stock must afterwards stand a rather severe scouring in order to remove the oils added for purposes of spinning; yarn-dyed material also accumulates considerable grease and dirt in handling and weaving and must also be scoured.* Goods dyed in the piece are usually scoured before dyeing; hence colors in this latter case need not be especially fast to scouring, unless the character of the goods requires them to be subsequently scoured either in manufacturing or in wearing. The best manner of conducting the washing or scouring test is as follows: Plait together a few strands of the dyed test skein with an equal portion of white wool yarn and white cotton yarn. Scour this sample for ten minutes in a miniature scouring bath (about 50 cc.) containing 5 grams of soap per liter at a temperature of 140° F. Squeeze, wash off in fresh water, and dry. Note if the dye tints the soap solution, and if it tints either the white wool or the white cotton. The latter is used in the test as cotton threads are frequently employed in the weaving of woolen goods. Some dyes may tint

* Dyed cotton yarns intended to be used as lists for raw silk goods which are subsequently boiled off in the piece, must possess a very high degree of fastness to washing; about the only colors which are suitable for this purpose are some of the sulphur dyes.

the soap solution without staining the white yarns, but this may result in the staining of other colors, hence such dyes cannot be considered fast; again, some dyes may stain the white wool, and not the white cotton, or *vice versa*; in either case, the color must be classed as not fast. As to degrees of fastness, an arbitrary classification may be made as follows:

1. Fast; does not tint the soap liquor, nor either of the white yarns.
2. Fairly fast; tints the soap liquor, but not the white yarns.
3. Not fast; tints either of the white yarns; the soap liquor may or may not be tinted.

Make up plaited test samples from each of the ten colors given above, and test them as to fastness to washing in the manner described; it is needless to add that a fresh portion of soap liquor must be used for each sample tested.

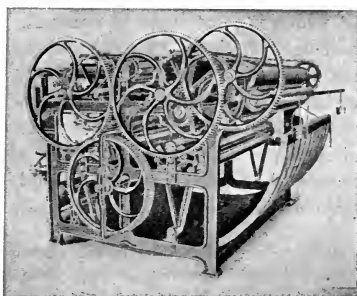

FIG. 283.—Double-cylinder Gessner Gig with Reverse Motion. (Curtis & Marble.)

(3) *Fastness to Fulling*.—This is also called milling, and refers to the process whereby woolen cloth is felted more or less in order to make a denser fabric or to otherwise finish the goods. The felting is carried out in fulling mills or stocks, in which the material is saturated usually with an alkaline soap liquor and then rubbed and squeezed together until the desired degree of felting is obtained. The process of fulling is a very severe test on colors, and the mordant dyes are about the only ones which will stand a hard fulling; there are, however, certain acid and substantive colors on wool which will stand a fair degree of fulling. The basic dyes will not stand fulling.*

* Change in tone of the color is generally due to the action of the alkali, but if the color loses in strength it indicates that the dyestuff is either dissolved or is rubbed off the fiber. In the case of Alkali Blue, it is decolorized, but the color is restored on treatment with acids. Bleeding in the fulling process may be due to superficial fixation of the dyestuff which is easily rubbed off, or it may be due to actual solution of the dyestuff in the fulling liquor. Goods intended for fulling should always be thoroughly

The fulling test may best be carried out as follows: Make a loose plait containing several strands of the dyed yarn mixed with strands of white woolen and cotton yarns, and treat with a solution containing 10 grams of soap and 2 grams of soda ash per liter at 140° F. Soak the sample in this solution and rub between two pieces of board until the wool yarns are well felted together. Then wash in fresh water, and dry. Note if the color has lost in intensity or if it has bled into either the white wool or cotton. In such case the dye cannot be considered fast to fulling. According to the degree of bleeding, the color may be classed as **not fast** or as **fairly fast**. If the dye neither loses in color nor bleeds, it may be classed as **fast**. Prepare test samples from each of the ten dyes given and test them in manner described for fastness to fulling.

(4) *Fastness to Rubbing*.—This is also termed “crocking,” and refers to whether or not the dye will mechanically rub off, and thus stain white or other colors with which it may come in contact. Heavy shades are more apt to rub than light shades. As a rule, the acid and substantive dyes on wool do not rub; the basic dyes frequently show this defect; heavy shades of mordant (or pigment dyes in general) will frequently rub off to some extent whereas lighter shades do not.* Heavy shades of Indigo (a pigment dye), for instance, rub off considerably, whereas the Chrome Blues producing the same shades are very fast to rubbing.† The test for fastness to rubbing is easily and simply carried out by rubbing a portion

washed after dyeing in order to remove all trace of adhering dye liquor. Colors will sometimes bleed if allowed to lie for a long time in a wet state which would otherwise be satisfactory if the fulling is not prolonged unduly. As fulling is a very variable operation, both in character and severity, depending on the nature of the goods, fastness to fulling must be described advisedly and with reference to the particular conditions to be met with. The method of testing as herewith described will furnish a general statement of relative fastness to fulling; but in the practical application of dyestuffs, the fulling test should be carried out under conditions simulating those the dyed goods will meet with in practice. In this way the fastness can be judged with reference to the particular purpose in hand. In fact, whenever the question of using a new and untried dyestuff is under consideration, it is best to send a dyed sample through the entire process of manufacture, and thus judge at first hand of the possible effect on the color.

* The colors produced in garment dyeing are usually less fast to rubbing than those produced in ordinary dyeing, owing to various limitations imposed by the dyeing process, and also on account of absence of finishing treatment.

† Dyed colors may at times show the defect of crocking when the fault is not primarily with the dyestuff. Dirty and badly scoured goods, the use of hard water and imperfect methods of dyeing and washing will often cause a color to crock which would otherwise be perfectly fast in this respect. Washing woolen goods with fuller's earth will frequently remedy crocking by removing the imperfectly fixed dyestuff from the fiber. A slight sizing on cotton goods at times gives the same result. Union goods, where the cotton warp is dyed with basic colors, will often crock. This defect may usually be remedied by washing with soap bark (Quillaya) or with a little glue.

of the dyed sample on a piece of white calico, and noting if a stain is left.* Test the ten dyed samples in this manner, and classify as **fast** or **not fast** to rubbing.

(5) *Fastness to Water*.—The object of this is to discover if the dye will bleed into white yarn on boiling in water or on prolonged steeping in cold water.† Test as follows: (a) Plait several strands of the dyed yarn with some white wool and white cotton yarns, and boil with water for one hour. Squeeze and dry. Note if the white yarns become stained. (b) Use another plaited sample as above, and steep in cold water for twelve hours. Note if the white yarns become stained. If the dye does not bleed at all in boiling water it may be classed as **fast**; if it bleeds slightly in boiling water, but not in cold water, it is **fairly fast**; and if it bleeds in the cold water test, it is **not fast**. Carry out tests on the ten dyed samples in the manner described, and classify these dyes with respect to their fastness to water.

(6) *Fastness to Weather*.—By this is meant fastness to the varying conditions of exposure to the atmosphere, such as alternate wetting by rain or dew and drying by the heat of the sun, etc.‡ The best and most practical method of applying this test is to expose a sample of the dyed material to the action of the weather for two weeks or more. But the results may

* If a very severe rubbing test is desired the dyed sample should be rubbed on a damp piece of white calico.

† Fastness to water is required of colors on garment materials liable to be wet by rain. It is also required of colors while the goods are passing through certain manufacturing and finishing operations; for instance, colored yarns intended for fancy weaving must not bleed when sized, as the other yarns may be stained; also colored woolen goods must not bleed in steaming when drops of hot water fall; light-weight dress goods are usually subjected to a slight fulling in hot water and the colors must not bleed; also suitings are often put through a potting (steaming) process where they are also treated with water and under these conditions of wetting the colors should not bleed. Colored yarns will frequently show bleeding into white when the two are woven together in close contact, though no bleeding might be apparent if the yarns are treated with water but not in actual contact with one another. Soap and alkaline residues in the goods may also cause bleeding in water with colors that would otherwise be fast. By after-treating the dyed material with alum, it is sometimes possible to prevent the bleeding of a color in water. Also in water fulling (or in potting) bleeding may be prevented by slightly acidulating the water.

‡ This effect is far different from that of sunlight alone; in fact, continued weather exposure is, perhaps, the severest treatment to which colors may be rationally exposed. A dyestuff may have excellent fastness to light and be eminently suitable for curtains and window shades, and yet be useless for the dyeing of awning material or flags. It may be said that as far as organic dyes are concerned, whether of natural or of synthetic origin, all are eventually destroyed by continued exposure to weather conditions. The mineral pigment dyes alone will retain their color under such treatment, and even many of these suffer considerable deterioration owing to chemical changes brought about by the oxidizing influence of sunlight and rain.

be approximately represented by the following test: (a) Steep a sample of the dyed yarn in a solution containing 2 parts of hydrogen peroxide (10-volume strength) and 10 parts of water for one hour. Dry and compare with the original sample. (b) Repeat the test, using a hydrogen peroxide solution of 10-volume strength undiluted with water; steep for one hour, and on drying compare with the original sample. If no alteration in the color is appreciable after test (b), the dye may be classed as **fast**; if test (b) shows an alteration in the color, but not test (a), the dye may be classed as **fairly fast**; if test (a) shows an appreciable alteration, the dye is **not fast**. By combining this test with the one to sunlight, a fair idea of the fastness of the dye to weather exposure may be gained. It is probable that in the wetting of material by rain or dew and subsequent evaporation by the heat of the sun, a trace of hydrogen peroxide is formed which has a bleaching action on colors.

(7) *Fastness to Acids and Carbonizing*.—In many cases dyed woolen materials are treated with moderately strong solutions of acids and dried in order to decompose any particles of vegetable matter which may be present; this process is known as carbonizing. To test the fastness of a dyestuff to this operation, proceed as follows: Immerse a sample of the dyed yarn in a solution of sulphuric acid of 4° Tw. at 175° F. for half an hour; squeeze and without washing dry in a hot-air flue. Then wash out and neutralize the acid in a bath containing about 1 gram of soda ash to 100 cc. of water; finally rinse well, and dry.* Compare with the original color, and note if the carbonizing process has altered the shade in any manner. According to the extent of change in the shade classify as **not fast**, **fairly fast**, and **fast**. Test in this manner each of the ten dyed samples.†

(8) *Fastness to Perspiration*.—This is required of all dyed clothing material that is worn next the skin; also of material used for making horse-blankets, etc. The most reliable test is to wear a sample of the dyed wool in such a manner as to expose it to the action of perspiration.‡ This

* Sometimes in carbonizing the dyed color may undergo an alteration in tone due to the action of the acid, but the original color is restored when the goods are properly neutralized with soda.

† Sometimes when dyed goods are stored in warehouses or shops for a long period the colors may suffer some change. As the goods are usually sufficiently protected from light the change is usually due to the action of acid gases in the air. These acids may arise from the products of combustion (gas lights) or from coal gas. In some cases, however, the alteration in shade may be due to an oxidation of the dyestuff. Sulphur colors are often liable to exhibit this effect.

‡ The action of perspiration is, perhaps, chiefly due to the effect of certain weak organic acids, such as acetic and lactic, but apparently other influences also come into operation, so that the only reliable test is to actually wear the sample so that it comes into direct contact with perspiration. A good practical test is to put the sample under the saddle cloth of a horse.

action, however, may be well represented by the following test: Plait a sample of the dyed yarn with white woolen and cotton yarns, and immerse for one hour in a solution of lactic acid of 4° Tw. at 100° F. Squeeze, and dry without washing in the air. Note if the color has suffered any alteration in shade or if it has stained either of the white yarns. According to the extent of change or staining classify as **not fast**, **fairly fast**, or **fast**.*

(9) *Fastness to Alkali*.—In order to remove the fatty matters from woolen goods a washing with dilute soda ash solution is frequently given. This is especially true of material which is fulled. To discover if the color will withstand such a treatment, a test is made as follows: A sample of the dyed yarn is plaited with white wool and white cotton, and steeped for one hour in a solution of soda ash of 3° Tw. at 120° F., then washed in fresh water and dried. Note if the color suffers any alteration, or if either of the white yarns is stained. According to the extent of change in color or staining the dye is to be classified as **not fast**, **fairly fast**, or **fast**.

(10) *Fastness to Lime or Street Dust*.—Dyed clothing materials such as ladies' dress goods and gentlemen's suitings have to withstand the action of street dust, mud, etc. This action is best represented by a test with lime as follows: Spot a sample of the dyed yarn with a solution containing 20 grams quicklime and 10 cc. ammonia per liter. Allow this to dry on the material, and then brush off. Note if the color has suffered any alteration.

(11) *Fastness to Sulphuring or Stoving*.—In some cases dyed woolen yarn is woven together with white and the cloth subsequently bleached by the action of sulphurous acid gas. To discover if the dye will withstand the action of the sulphurous acid test as follows: Take a small sample of the dyed yarn, moisten it with water, and hang it for six hours in a closed

* Our knowledge concerning the action of perspiration on coloring matters is as yet very imperfect. Perspiration, like every organic secretion, is very complex in its composition. According to Landois, it is acid in reaction during repose and alkaline during exertion. Neumeister claims that the acidity is due to free fatty acid which becomes neutralized when the secretion increases in quantity. Trumphy and Luchtinger, however, have more recently shown that normal perspiration is always alkaline, and that the acid reaction proceeds not from the sweat, but from the decomposition of the grease from the skin. The cause of the alkalinity is not known with certainty. Trumphy and Luchtinger consider it due to carbonate of soda, though it may be due to carbonate of ammonium formed from urea. Perspiration contains neutral fats, such as palmitin and stearin, and also formic acid, butyric acid, and various higher fatty acids. Among its inorganic constituents are sodium chloride, potassium chloride, and small amounts of the alkaline phosphates. Formerly the fastness of a color to the action of perspiration was tested by acetic acid. At the present time treatment with lactic acid has been substituted. Actual exposure to perspiration itself is, of course, the best test. Next to this it is recommended to treat the dyed samples for ten minutes with a solution containing 5 grams of Castile soap and 3 cc. of ammonia water per liter. The amount of bleeding which occurs will be a fair test of the fastness to perspiration.

bottle filled with sulphurous acid gas (obtained by burning a piece of sulphur in the bottle). Note if the color undergoes any alteration, and corresponding to the extent of change classify the dye as **not fast, fairly fast, or fast.**

(12) *Fastness to Steaming.*—In the various finishing operations, dyed woolen fabrics may be subjected to a steaming operation in order to give the surface of the goods a luster and a certain finish. This process is frequently called “decatizing” or “potting.”* The same operation is carried out on goods composed of wool and cotton yarns in order to prevent crinkling, in which case it is called “crabbing.” To test a dyestuff to the influence of such an operation proceed as follows: Prepare a plaited sample containing the dyed yarn together with white wool, and cotton. Steam the sample for one-half hour under about 5 lbs. pressure. Note if the color suffers any alteration, or if it stains the white yarns. According to the extent of change or staining classify the dye as **not fast, fairly fast, or fast.**

(13) *Fastness to Hot Pressing or Ironing.*—Woolen material employed in the manufacture of suitings, etc., requires to be hot pressed or ironed. To discover if a dyestuff will withstand such a treatment, test as follows; (a) Moisten a sample of the dyed yarn and press with a hot iron till dry. Note if the color undergoes any alteration on cooling. (b) Moisten a sample of the dyed yarn and cover with a piece of white muslin, then press with a hot iron until dry. Note if the color suffers any alteration or if it stains the white muslin. If no change takes place under (a) class the dye as **fast**; if it changes under (a) but not under (b), or stains the white slightly without any other perceptible change, class as **fairly fast**; if the color is altered by both (a) and (b) class as **not fast.**

3. Testing the Fastness of Colors Dyed in Cotton.—In many cases dyeings on cotton materials are tested in the same manner as on wool; but there are deviations from the latter, owing to the different character of the fiber. The following are the chief tests to be applied to dyed cotton material:

- (1) *Fastness to Light.*—Tested in the same manner as with wool.
- (2) *Fastness to Washing.*—Tested in the same manner as with wool.
- (3) *Fastness to Fulling.*—Tested in the same manner as with wool.
- (4) *Fastness to Rubbing.*—Tested in the same manner as with wool.†

* In the potting process the use of moist steam should be avoided, as there are but few dyes that can withstand the simultaneous action of steam and water.

† The substantive colors on cotton are ordinarily very fast to rubbing especially when dyed with the addition of soap or soluble oil. The use of too much salt in the bath, too concentrated a bath or dyeing at too low a temperature may produce shades that crack. Also colors that are dyed on the padding machine are very liable to rub. The basic dyes show a rather inferior fastness to rubbing. The same is true with Para

(5) *Fastness to Water*.—Tested in the same manner as with wool.

(6) *Fastness to Acid*.—It is frequently the practice to weave dyed cotton yarn with white wool and subsequently to dye the wool with acid colors. This is termed "cross-dyeing." To discover if the dyed cotton will withstand the action of the boiling acid dyebath, test as follows: Plait a sample of the dyed yarn with white wool and cotton, and boil for one hour in a solution containing 1 cc. sulphuric acid and 2.5 grams Glaubersalt per liter. Then wash and dry. Note if the color sustains any alteration or if it bleeds into the white yarns,* and classify the dye as **not fast**, **fairly fast**, or **fast**.

(7) *Fastness to Weather*.—Tested with hydrogen peroxide in the same manner as with wool.

(8) *Fastness to Perspiration*.—Tested with lactic acid in the same manner as with wool.

(9) *Fastness to Alkali*.—This is tested in the following manner: (a) Steep a sample of the dyed yarn for two minutes in cold ammonia water (full strength), and observe if the color undergoes any alteration. (b) Steep a similar sample in a solution containing 10 grams of soda ash to 100 cc. of water for two minutes, and dry without washing. Note if the color undergoes any alteration. (c) Plait a sample of the dyed yarn with white wool and cotton, and boil for one-half hour in a solution containing 2 grams of soda ash per liter; rinse and dry. Observe if the color suffers any change, and if the white yarns become tinted. From these tests classify the color as **fast**, **fairly fast**, or **not fast**.

(10) *Fastness to Mercerizing*.—In some cases cotton is mercerized after being dyed; and as the mercerizing process consists in treating the material with strong solutions of caustic soda, it is necessary that the dyed color should not be affected by this treatment in order to be employed on this class of material. Carry out the test as follows: Steep a sample of the dyed yarn in a solution of caustic soda of 50° Tw. for five minutes; wash well in cold water, then in hot water, and finally in water acidulated with acetic acid; dry, and observe if the color has undergone any alteration, and classify accordingly as **fast**, **fairly fast**, or **not fast**.

(11) *Fastness to Chlorine, or Bleaching*.—Cotton fabrics containing white interwoven with colored yarns are frequently bleached more or less thoroughly in order to clear the white; such material as cotton toweling containing colored borders is also bleached quite thoroughly.† To dis-
Red, Turkey Red Aniline Black, and Logwood. The sulphur and vat dyes when properly applied are fast to crocking.

* Many dyes are fast to cross-dyeing with respect to any alteration in the color by the action of the acid, and yet will bleed into white yarns owing to lack of fastness to hot water.

† In modern laundry methods hypochlorite solutions are nearly always employed for whitening cotton and linen goods, consequently fastness to light chlorine bleaching

cover if a dye will withstand the action of bleaching which is done with solutions of chloride of lime, the following test should be made: Steep a sample of the dyed yarn in a cold solution of chloride of lime of $1\frac{1}{2}^{\circ}$ Tw. for one hour. Rinse in water slightly acidulated with hydrochloric acid, then in dilute soap solution, and finally dry. Observe if the color has undergone any alteration in shade, and classify accordingly as **fast**, **fairly fast**, and **not fast**.

(12) *Fastness to Lime or Street Dust.*—This is determined in the same manner as with wool.

(13) *Fastness to Steaming.*—This is determined in the same manner as with wool.

(14) *Fastness to Ironing or Hot Pressing.*—This is determined in the same manner as with wool.*

Dye ten test skeins of cotton with 2 per cent of the following dyestuffs, and test each color with respect to fastness to the different agencies as above described:

1. Benzopurpurin (substantive dye).
2. Chrysophenine (substantive dye).
3. Diamine Blue RW (substantive dye after-treated with bluestone).
4. Dianil Direct Yellow S (substantive dye).
5. Dianil Brown 3GO (substantive dye after-treated with chrome).
6. Methyl Violet (basic dye on tannin-antimony mordant).
7. Magenta (basic dye on tannin-antimony mordant).
8. Methylene Blue (basic dye on tannin-antimony mordant).
9. Cotton Blue (acid dye on "blue mordant").
10. Rhodamine (basic dye on oil-aluminium mordant).

4. Testing Fastness of Colors Dyed on Silk.—Dyeings on silk, as a rule, do not require as great a degree of fastness as those on wool and cotton. The chief qualities of fastness are to light, rubbing, and water. Certain dress goods fabrics of silk or part silk also require fastness to washing; the same is also true of colors for silk shirtings.

(1) *Fastness to Light.*—Tested in the same manner as with wool. Also colors on silk should not change shade in artificial light.

combined with fastness to soap scouring may be described as a test for *fastness to laundering*. Unfortunately there are a very few cotton dyes which are fast in this respect; even the sulphur colors which are quite fast to scouring are destroyed by hypochlorite bleaching. About the only colors which will successfully withstand this combined treatment are the vat dyes. On this account they have become of great importance for cotton dyeing, wherever the goods are subject to laundry treatment.

* The substantive dyes, as a rule, are very sensitive to alteration in shade under the influence of dry heat, red dyes becoming yellowish, yellows bluish, and blues reddish. In other words, heating appears to cause a displacement of the color towards the violet end of the spectrum. There appears to be some connection between the chemical constitution of the dyestuff and its sensitiveness toward heat. Dyes containing the sulphonic acid group are all affected by ironing (see Friedländer, *Chem. Zeit.*, 1900, p. 1159).

- (2) *Fastness to Rubbing*.—Tested in the same manner as with wool.
- (3) *Fastness to Water*.—Tested in the same manner as with wool.
- (4) *Fastness to Washing*.—Tested in the same manner as with wool.

TABULATION OF TESTS FOR FASTNESS OF WOOL DYES.

Test.	1.	2.	3.	4.	5.	6.	7.	8.	9.*	10.
Light										
Washing:										
Soap sol.										
Wool										
Cotton										
Fulling:										
Wool										
Cotton										
Rubbing										
Water:										
Cold										
Boiling										
Weather:										
H ₂ O ₂ dil.										
H ₂ O ₂ conc.										
Acid and carbonizing										
Perspiration:										
Wool										
Cotton										
Alkali:										
Wool										
Cotton										
Lime and street dust										
Stoving										
Steaming:										
Wool										
Cotton										
Hot pressing or ironing:										
Color										
White										
Light										

5. Tabulation of Fastness Required on Various Classes of Materials.—

(a) *Wool*.—(1) *Loose Wool*.—Fastness to light, fulling, and potting; the dyes recommended are mordant colors first (including the acid chrome and meta-chrome dyeing colors), and substantive dyes next. The latter are quite fast to scouring on wool, and fairly fast to fulling; they are especially recommended for dyeing in machines on account of their good solubility.

(2) *Shoddy, Mungo and Carbonized Rags*.—Fastness to fulling and cheapness in dyeing; fastness to light is seldom required. The dyes

recommended are the mordant and substantive colors in the first place, and secondly the basic colors. The latter are only fast to very light fulling, but do not stain white cotton, and are valuable on account of their great brilliancy.

TABULATION OF TESTS FOR FASTNESS OF COTTON DYES

Test.	1.	2.	3.	4.	5.	6.	7.	8.	9.	10.
Washing:										
Soap sol.....
Wool.....
Cotton.....
Fulling:										
Wool.....
Cotton.....
Rubbing.....
Water:										
Cold.....
Boiling.....
Acids and cross-dyeing:										
Color.....
Wool.....
Cotton.....
Weather:										
H ₂ O ₂ dil.....
H ₂ O ₂ conc.....
Perspiration:										
Wool.....
Cotton.....
Alkali:										
Ammonia.....
Soda, cold.....
Soda, boiling.....
Mercerizing.....
Chlorine or bleaching.....
Lime and street dust.....
Steaming:										
Wool.....
Cotton.....
Hot pressing or ironing:										
Color.....
White.....

(3) *Slubbing and Tops*.—The fastness required and the dyes recommended are the same as for loose wool.

(4) *Weaving Yarns (Worsted, Cheviot and Carded Yarns)*.—As these are chiefly used for scouring and fulling purposes, the fastness required and the dyes recommended are the same as for loose wool.

(5) *Worsted Knitting Yarns and Hosiery Yarns.*—These require fastness to scouring, perspiration, and rubbing. Substantive and mordant dyes are recommended; also the faster acid dyes.

(6) *Yarns for Flannels, Rugs, Blankets, Plaids, etc.*—These require a moderate fastness to fulling; also fastness to perspiration and rubbing, and for rug yarns fastness to stoving is frequently desired. Substantive and mordant dyes are recommended as well as the faster acid colors, especially those which are after-treated.

(7) *Carpet and Tapestry Yarns.*—These require fastness to light, cold water, and rubbing; dyes possessed of good leveling properties are

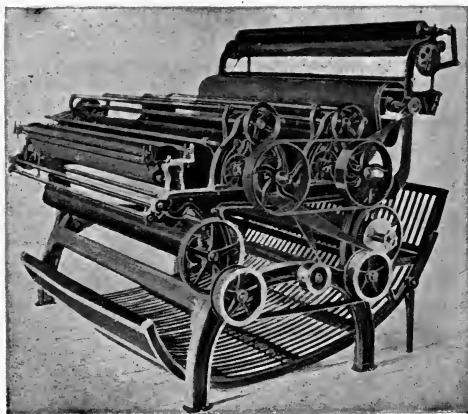

FIG. 284.—Two-cylinder Brushing Machine with Steam Box, Flock, Back Folder and Scray Beneath. (Parks & Woolson.)

also desired. The best dyes are acid colors fast to light, then the mordant dyes, and the substantive dyes which are after-treated with bluestone.

(8) *Worsted Braids.*—These require dyes that penetrate well, and that are fast to light and rubbing. The same colors as for the preceding are recommended.

(9) *Fancy Yarns.*—Fastness to stoving and clear brilliant colors are usually desired. The best dyes to use are the level dyeing acid colors and the basic colors.

(10) *Piece Goods consisting of Woolen Cloths (Beavers and Meltons), Gentlemen's Suitings, Worsted Coatings, Cheviots, Carded Woolen Cloths, Braids for Army and Navy Cloths, Billiard Cloth.*—In such goods it is desirable that the dyes be level and penetrate well; fastness to light, pot-

ting, hot pressing, and rubbing are also required, and in some cases, fastness to carbonizing. The dyes best to use are the faster acid colors and the mordant colors, and secondly the substantive dyes.

(11) *Dress Goods, Ladies' Cloths, Doeskins, Cashmeres, Crêpons, etc.*—These require the same fastness as the preceding, and also fastness to street dust. The same dyes are used as with the preceding.

(12) *Flannels.*—These principally require fastness to washing and light; the dyes chiefly used are the acid and substantive colors, the latter being largely employed for red shades.

(13) *Velvets and Plushes.*—These require fastness to light and rubbing; acid dyes are principally used.

(14) *Woolen Felt.*—Good penetration and level dyeing is the first consideration; the fastness required will vary with the particular use to which the goods are put. The dyes mostly used are the easily soluble acid colors and the substantive colors.

(15) *Hats of Wool and Hair.*—In this case fastness to light, potting, and rubbing is required; also the color must penetrate well. The dyes principally used are mordant colors, and readily soluble acid colors fast to light.

(b) **Cotton.**—(1) *Loose Cotton and Slubbing.*—These require to be fast to fulling and light, though the requirements vary greatly, according to the use to which the material is to be put. The dyes mostly used are the substantive colors, dyed direct, diazotized and developed, or after-treated; also substantive dyes topped with basic colors, and even basic colors alone.

(2) *Fancy Weaving Yarns, Cotton Warps for Union Goods, Knitting Yarns, Hosiery Yarns.*—These require fastness to scouring (and sometimes fulling) to cross-dyeing, to light, and generally to perspiration, though the degree of fastness will necessarily vary considerably with the use to which the yarn is to be put. The dyes recommended are the diazotized and developed and the after-treated substantive colors, sulphur colors, basic colors, and substantive colors topped with basic; for light shades, the direct dyed substantive colors. For cop dyeing the substantive colors of ready solubility are principally used.

(3) *Yarns for Draperies, Upholstery, etc.*—These chiefly require fastness to light and rubbing. The dyes mostly used are the substantive colors, the basic colors, and some of the acid colors.

(4) *Sewing Cotton.*—This requires fastness to light and rubbing. The substantive and basic dyes are chiefly used.

(5) *Cotton Hosiery and Knit-goods.*—These require fastness to washing, perspiration, rubbing, and sometimes light. The dyes must also penetrate well. The colors used are the same as for knitting yarns; also Aniline Black and the sulphur colors.

(6) *Piece Goods consisting of Moleskins, Cotton Worsteds, Beavers, Fus-*

tians, Flannelettes, Sateens, Plushes, Velvets, Corduroys, etc.—These usually require fastness to perspiration, light, rubbing, hot pressing, and in some cases also fastness to washing. The dyes mostly used are the substantive colors dyed direct, also diazotized and developed, and after-treated; also the sulphur dyes; also substantive dyes topped with basic colors, and at times basic dyes alone.

(7) *Cotton Linings, Bobbinnet, Tulle, etc.*—These require fastness to rubbing, perspiration, and frequently hot pressing. The dyes chiefly used are the substantive colors dyed direct, diazotized and developed, or topped with basic dyes; the sulphur dyes; and the basic dyes. Bobbinnet is frequently dyed in the sizing.

(8) *Bookbinders' Cloth.*—About the only fastness required is to light. The dyeing is frequently done in the sizing, using acid dyes, basic dyes, and substantive dyes.

(c) **Union Goods.**—(1) *Thread Waste, Shoddy, etc.*—Moderate fastness to fulling is usually required together with cheapness of dyeing. The dyes mostly used are the substantive colors, either alone or in conjunction with neutral dyeing acid colors; also after-treated substantive colors.

(2) *Merino and Angola Yarns, Braids, etc.*—The requirements for fastness vary with the application. The dyes used are those given above, also substantive dyes topped with basic colors.

(3) *Hosiery Yarns.*—These require fastness to perspiration, washing, and rubbing. The dyes employed are those given above.

(4) *Piece Goods consisting of Cotton Warp Suitings, Woolens, Dress Goods, Shawls, Crewels, Astrachans, Italian Cloth, Serges, Hosiery, Felt, and Flannels.*—The requirements for fastness vary with the nature and use of the material; in general, fastness to washing and rubbing is desired; fastness to light is of minor importance with linings and hosiery. The dyes mostly used are the substantive dyes either alone or in combination with the neutral dyeing acid colors.

(5) *Ladies' Cloths, Presidents, Whitneys, Moscows, Beavers, Worsted Coatings, etc.*—The only important requirement is sufficient fastness to light, water, rubbing, and hot pressing. The dye should cover the cotton well, be level dyeing, and have good penetration. The substantive dyes are principally used, either alone or in combination with neutral dyeing acid colors.

CHAPTER XXVII

APPLICATION OF DYES TO VARIOUS MATERIALS

1. The Dyeing of Leather.—Leather is a fibrous material composed of animal tissue possessing chemical characteristics very similar to those of wool, consequently it would be natural to expect that this material would react towards dyestuffs in a manner somewhat analogous to that of wool. Leather is also a porous tissue capable of absorbing by mere capillary action various materials from solution and thus becoming dyed or mordanted. Furthermore, leather must also be considered as a colloid with respect to its constituent fibers and therefore having colloid reactions like other fibers, such as forming solid solutions with dyes and other similar bodies.

The properties of leather with respect to dyeing depend to a large extent on the method employed in its tanning and also somewhat upon the character of the skin from which the leather has been made. There are four general methods of tanning used in the preparation of leather: (a) *Vegetable tanning*, by the use of tannic acid or vegetable extracts rich in tannic acid, such as sumac, hemlock, oak-bark, quebracho, etc. (b) *Chrome tanning*, where the leather is formed by the action of chromium compounds on the skins. (c) *Alum tanning*, obtained by the action of alum solutions giving a light-colored leather. (d) *Oil tannage*, by the action of certain oils giving a leather product such as chamois. Vegetable tanning is used principally for the preparation of heavy leathers, and it must be borne in mind that the tannin compounds influence the reaction of the leather with dyestuffs. Chrome tannage is now extensively employed for lighter weights of leather such as kid and sheepskins; the dyeing properties are influenced by the presence of chromium compounds, which also give the leather a green color and serve the purpose of a chromium mordant. Alum tanning is used for light-weight leathers, chiefly to be of a white color or to be dyed in light shades, such as leather for glove material and such like. This leather contains alum compounds and this influences its reaction with dyes, as it may be considered as mordanted with alum. Chamois, or oil-tanned leather, is a very porous, soft leather of a light creamy color. Though it may have formerly been made from the skins of the chamois it is now made from the skins of goats and sheep.

In the dyeing of leather the basic, acid, and substantive dyes are the principal ones employed, the other classes of dyes not coming into consideration at all for this purpose. The preparation of leather for dyeing consists principally of freeing it as far as possible from foreign substances adhering to it from the tanning process, and this is usually accomplished by allowing the skins to lie for some time in running water in order to wash off the impurities. This operation is generally carried out in a drum, which consists of a closed rotating wooden vat or tank in which the leather is placed, together with sufficient water, and the drum is then run for

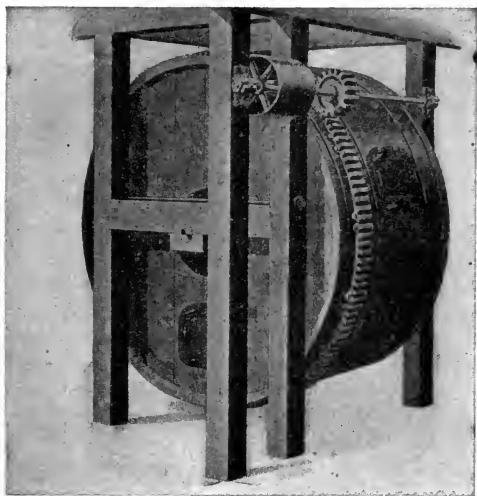

FIG. 285.—Drum Machine for Dyeing Leather.

three to four hours, then fresh lukewarm water is added and the leather is drummed for ten minutes longer; it should then possess a characteristic slippery handle.

Leather prepared with vegetable tanning must be freed from all excess of tannin material, as if this is not done dye spots are liable to be formed, especially when dyeing with the basic colors. For the preparation of vegetable-tanned sheepskins the following method is recommended: Scour in the drum with a weak solution of soda ash (containing about 1 lb. of soda ash to 25 gallons of water) for the purpose of removing any unfixed tannin and greasy matters; then rinse again in the drum for one-half hour with lukewarm water, and afterwards run for five minutes in a bath con-

taining 1 part of sulphuric acid to 60 parts of water at a temperature of 60° F. for the purpose of removing dirt and grease. Finally rinse in cold water to wash out the sulphuric acid. When very dark colors are to be dyed it may not be necessary to give the treatment with sulphuric acid. The leather thus prepared is now ready for dyeing, which is carried out in the drum with a dyebath starting at a temperature of 100 to 120° F. and running until the liquor is cold.

In the dyeing of sumac-tanned leather with the basic colors the following method is recommended: After thorough cleaning dye with a solution containing the well-dissolved dyestuff with the addition of 1 to 2 pints of acetic acid per 100 gallons of water (for the correction of the hardness).

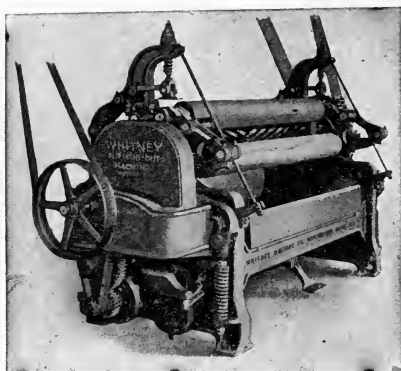

FIG. 286.—Putting-out Machine Used in Leather Dyeing.

There are two methods adopted in the application of the dyebath: (a) Brushing, where the color solution is applied to the surface of the leather by means of a brush, the temperature of the dye liquor being maintained at 75 to 120° F. (b) Dipping, where two skins are paired together with the flesh-side in and then drawn through the dyebath in a tray at a temperature of 120 to 140° F. In the dipping method it is customary to employ two baths, the color solution being prepared by dissolving 4 ozs. of dyestuff in $\frac{1}{2}$ gallon of water. For the first bath use $\frac{1}{2}$ pint of this dye solution diluted with three to four times its amount of water. The diluted color solution is used for dyeing the first pair of skins and these are subsequently dyed to the proper full color in a small amount of the undiluted dyestuff solution, rinsed in cold water and then dried in the open air. The strong color solution for the last bath is used for the preliminary dyeing of

the next pair of skins, which are then subsequently brought to the proper shade in the strong color solution, and so on. The purpose of dyeing first in the weak dye liquor is to prevent uneven colors, as the dyestuff is very rapidly and greedily taken up by the leather, and consequently if the color solution is not sufficiently diluted spots and streaks will result. After dyeing the skins should be rinsed in lukewarm water, stretched, and softened with linseed oil, dried, rubbed with diluted milk, then albumin and finally dried again. These after-treatments are necessary to prevent the dyed skins from becoming hard and tough on drying out. Many of the basic colors when applied in very heavy shades produce a metallic luster on the leather, and this is usually removed by running the skins through a bath of dilute acetic acid. When it is necessary to darken or sadden the color a treatment with acetate of iron or chrome may be given. When the skins have a hard grain so that the colors are not fixed well, better results may be obtained by mordanting previously with tartar emetic (or other suitable antimony salt). The use of a solution of borax is also serviceable in softening the grain (particularly in the case of kid and goat skins) when the leather still contains residues of greasy matters. When necessary grease may also be removed by a treatment with carbon tetrachloride or benzene.

Vegetable-tanned leather may be dyed with the acid colors by using the dye liquor at 130° F. containing the well-dissolved color with the addition of $\frac{1}{2}$ pint of sulphuric acid to 100 gallons of water. When using a mixture of acid dyes to produce a compound shade it is best not to mix the dyes in one bath, but to use them one after the other, as by this means much clearer tones of color will be the result.

Dyestuffs Suitable for the Dyeing of Vegetable Tanned Leather.

(A) Basic Colors

Auracine G	Induline L (water sol.)	Methylene Gray O, NF
Auramine	Janus Black I	Methylene Green
Azo Phosphine GO, BRO	Janus Blue B	New Blue R
Bismarck Brown F, M, R	Janus Brown R	New Fast Blue
Brilliant Green	Janus Green G	New Magenta
Brilliant Phosphine G	Janus Red B	Paper Scarlet G, B
Brilliant Rhoduline Red B	Janus Yellow G, R	Patent Phosphine G, M
Brown for Leather O	Leather Black V, T, G	Phosphine O, P
Canelle	Leather Brown 2G	Red for Leather O, R, G
Cardinal G, R	Leather Green O	Rhodamine B
Cherise GO, R	Leather Yellow GO. 2G	Rhoduline Violet
China Green	Malachite Green	Russia Red D
Chrysoidine G, R	Maroon O	Saffron Red O
Coriophosphine O	Methyl Green I	Safranine FF
Diamond Fuchsine	Methyl Violets	Turquo se Blue 2B, G
Grenadine O, R	Methylene Blue 2B	Vesuvine

(B) Acid Colors

Acid Anthracene Brown R	Claret Red G, R, B	New Acid Green
Acid Brown B	Cotton Blue	New Patent Blue
Acid Cerise O	Croceine Orange G, R	Nigrosine (water sol.)
Acid Green 2B, 2G	Croceine Scarlet 2BN, 8B	Orange II, R
Acid Magenta	Eosi 1	Orselline R, B
Acid Maroon O	Fast Blue O, R, 5B	Patent Blue V, A
Acid Phosphine JO	Fast Brown	Phenylemine Black 4B
Acid Violet 4B	Fast Green	Phloxine G, 5B
Azo Yellow	Fast Red A	Pure Blue O
Bordeaux extra, G	Imperial Scarlet 3B	Quinoline Yellow
Brilliant Croceine 3B	Indian Yellow G, R	Resorcine Brown
Brilliant Orange G, O, R	Induline	Rosazeine 4G, O
China Blue	Lyons Blue	Victoria Yellow
Citronine	Naphthol Yellow S	Wool Blue N

For the dyeing of chrome-tanned leather, basic, acid, and certain of the substantive dyes may be employed. In the dyeing of basic colors the chrome-tanned leather should first be treated with a suspension of chalk or a solution of borax or ammonia in order to neutralize and remove all the acid in the leather. The skins are then drummed in a tannin bath (sumac or gambier) for one-half hour, and then well washed and dyed in the drum with the solution of the basic color at a temperature of about 120° F. The dipping method of dyeing may also be employed.

Acid colors are usually employed on chrome-tanned leather where a good penetration of the dyestuff is desired. The dyebath is prepared simply with the solution of the acid dyestuff and applied either in the drum or by dipping at 110 to 120° F. for one-half hour, finally adding a small amount of acetic acid to the bath to obtain better exhaustion.

Dyestuffs Suitable for the Dyeing of Chrome-Tanned Leather.

(A) Basic Colors

Auracine G	Fast Blue for Cotton	New Fast Blue 3R
Auramine	Grenadine O	New Magenta
Azo Phosphine GO, BRO	Janus Colors	Phosphine O, P
Brilliant Green	Leather Black T	Red for Leather
Brown for Leather	Magenta	Russia Red D
Cardinal G	Malachite Green	Saffron Red O
Cerise G, R	Methyl Violet 2B	Safranine FF
Chrome Leather Yellow	Methylene Blue	Vesuvine 4BG
Chrysoidine G, R	Methylene Green	Yellow for Leather
Coriphosphine O		

(B) Acid Colors

Acid Cerise O	Claret Red G, R, B	Nigrosine (water sol.)
Acid Green	Croceine Orange G	Orange II
Acid Magenta	Eosin	Orseiline R, B
Acid Maroon O	Fast Blue O, R	Patent Blue V, A
Azo Yellow	Fast Brown	Phloxine
Bordeaux extra, G	Fast Red A	Rosazeine
Brilliant Croceine 3B	Indian Yellow G, R	Scarlet G, R
Brilliant Orange G, O, R	Induline B	Victoria Yellow
China Blue	Lyons Blue	

(C) Substantive Dyes

Acetylene Blue 3B	Cupranil Brown G	Direct Deep Black RW
Benzo Fast Blue BN	Dianil Blue G, B	Direct Olive
Chlorantine Red 4B	Dianil Brown R	Leather Black C, E
Chlorantine Yellow 2J	Dianil Orange G	Pluto Black BS
Chrome Leather Brown	Dianil Yellow 3G, R	

The substantive colors are applied to chromed leather by running at a temperature of 150 to 160° F. for one-half hour. When suitable dyes are employed the bath is almost completely exhausted.

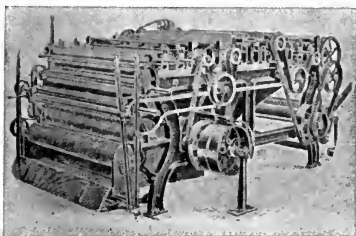

FIG. 287.—Cotton Shearing and Brushing Machine. (Curtis & Marble.)

After chrome-tanned skins have been dyed they should be treated in the drum for one-half hour with an emulsion of olive-oil soap and neatsfoot oil or egg-yolk, then stretched and oiled with neatsfoot oil or linseed oil and allowed to dry. Afterwards lay the leather in damp sawdust, stake it and wet out with a strong solution of albumin.

Alum-tanned leather is first rinsed well, in order thoroughly to remove any excess of alum, and is then dyed at a temperature of 115° F. either by the dipping or the brushing method, using the basic colors in a neutral bath or the acid colors in a weak sulphuric acid bath or the phthaleine colors (Eosin, etc.) in a weak bath of acetic acid. The dyes employed and the baths are prepared in practically the same manner as with chrome-tanned leather.

Besides the coal-tar dyes, some of the natural vegetable dyes are still used to a considerable extent for the dyeing of leather. Logwood is used for blacks and for toning other colors such as browns and tans; Quercitron and Flavine also find extensive use as yellow dyes, both as self-shades and as components in the production of browns and tans. Quebracho, which is so largely used as a tannin agent for leather, also dyes the leather a reddish brown color. The same is true of nearly all the other tannins used for leather, they not only cause a tanning of the skin, but also dye it various shades of brown depending on the origin and nature of the tannin.

2. The Dyeing of Paper.—Paper may be considered as a web or fabric of interlaced vegetable fibers made by enmeshing them on a screen from a broth or suspension of these fibers in water. Its properties with respect to dyestuffs are about the same as cotton and the other vegetable fibers. Paper may be dyed either in the form of pulp (which consists of a suspension of the fibers in water) previous to being converted into paper or in the form of the prepared paper. In the former case the pulp is contained in a mixing tank or beater and the dyestuff solutions and other necessary ingredients are added directly to the pulp and thoroughly incorporated with it by mixing. The dye is either taken up directly by the fiber or is precipitated in and on the fiber by suitable mordants. In the case of dyeing the prepared paper itself the latter in open width is run through a solution of the dyestuff, which it takes up either by combination with the fiber or by simple absorption and becomes dyed thereby. In some cases where the paper is heavily coated and dyed on one side only the coloring matter in the form of a proper paste or solution is brushed on the surface of the paper or applied by means of rollers, in which case it is more of a painting operation than a real dyeing one.

Paper may consist of various kinds of fibers possessing somewhat different characteristics as far as their dyeing properties are concerned. These different fibers may be roughly classified as follows: (a) *mechanical wood pulp*, consisting of woody tissue reduced to the fiber form by mechanical disintegration; (b) *chemical wood pulp*, consisting of fibers prepared from woody tissue by treatment with proper chemical agents, such as sodium (or calcium) bisulphite, giving *sulphite pulp*, or caustic soda giving *soda pulp*, or sodium sulphide giving *sulphate pulp*; (c) *rag pulp* made from rags and miscellaneous waste of cotton and linen fabrics; (d) pulp made from various grasses or straws such as *esparto*. In this country paper is principally made from mechanical wood pulp, sulphite pulp, and rag pulp, either employed singly or in mixtures in various proportions depending upon the quality of the paper desired. Mechanical wood pulp gives the lowest grade of paper and is principally used for newspaper stock, cheap printing papers, paper for linings, wall paper, etc. It contains a considerable amount of lignin matter and other matters differing from pure cel-

lulose. Sulphite pulp is of a much higher grade and is used for making the better class of printing and book papers and writing papers. It consists of rather pure cellulose and may be bleached to a fine white stock. It is largely mixed with mechanical wood pulp to produce varying grades of paper stock. Rag pulp is used chiefly in admixture with more or less sulphite pulp for the production of high-grade writing papers and other grades of paper requiring cotton or linen fibers in order to obtain a special quality. Sulphate pulp gives a tough fiber which is rather highly hydrolyzed cellulose, and it is used principally for the production of tough wrapping papers and similar stock. Jute waste and butts are also employed extensively as a basis for paper pulp as are also various other vegetable fiber wastes.

The dyes that are principally used for the coloring of paper are the basic, acid, substantive, and to a lesser extent some of the sulphur colors as well as some of the vat dyes where the production of colors or tints of great fastness to light is desired.

Paper pulp is dyed in the beater with the basic dyes in the following manner: There is first added to the pulp in the beater 2 to 4 per cent of aluminium sulphate dissolved in water and the beater is allowed to run for ten minutes; then add the solution of the basic dye and allow the beater to run for another ten minutes; next add a solution of 4 per cent of resin soap (prepared by saponifying 1 lb. of resin with 4 ozs. of soda ash in 1 gallon of water), and run for fifteen minutes, when the back waste water should show clear, indicating that all the dye has been taken up by the pulp. In this method of dyeing the dyestuff is thrown down by the precipitate of aluminium resin soap incorporated with the fiber pulp. When dyeing colors involving the use of a mixture of several dyes it is best not to add the mixed dye solution, but to add the several colors in solution separately. The dyestuff solutions as well as the other solutions employed should be rather dilute in order to enhance the uniformity of their distribution as far as possible.

The acid dyes are applied in the same manner as above described for the basic colors. When mixtures of mechanical and sulphite pulp are used (as is most frequently the case) the two fibers often do not come up the same color with the acid dyes; therefore it is recommended that paper pulp dyed with the acid colors should be topped with basic dyes as these come up evenly on both fibers. The solution of the basic dye should be added after that of the acid color has been properly and thoroughly worked in.

The substantive and sulphur colors are also applied in the same manner as the basic dyes with the use of aluminium sulphate and resin soap. Some of the substantive dyes may be applied without any additions of these chemicals, but the color is apt to bleed out into water and cause

stains. The sulphur dyes must be first dissolved in the necessary quantity of sodium sulphide.

The dyeing of made-up paper (so-called staining) is done almost entirely with the acid and basic dyes. The colors should be well dissolved in water and the solutions filtered. The color solution is brushed on the paper either by hand or by the use of suitable brush machines. Tissue paper is also extensively dyed for use in making paper flowers and other ornamental objects; in this case acid, basic and substantive dyes may be employed and the dyeing is usually done in a dyeing machine in which the paper is run through the concentrated dye solution and then on to hot cylinders for drying. Wall paper and coated paper are usually dyed by an operation similar to that of padding, the strong color solution together with suitable sizing and filling agents being applied to one surface of the paper in a padding machine by means of rollers and then dried. In the dyeing by this method pigment colors may also be used, as well as the coal-tar color-lakes made by precipitating the dyestuff on a metallic base.

3. The Dyeing of Furs.—The dyeing of furs is a rather special art, for in this case the dyer is not only interested in the production of a certain color on the material, but must also be concerned with certain other qualities of the fur in order that it may have value and beauty. The luster, the lay of the fiber, the gradation of the color from the outer to the inner portion of the fur, the color and appearance of the tips of the fibers, the character and quality of the skin holding the fur as well as its color, have all to be considered in the process of fur dyeing, and this requires intelligent and carefully trained art as well as dyeing technique. Furthermore, the dyeing of furs is rather limited in range of colors; browns of various shades are mostly used, blacks to some extent, and to a far less degree the fancy colors. The production of dark browns and blacks are the chief consideration in fur dyeing, and these colors are produced principally with a few special materials or preparations consisting of meta-phenylene-diamine, para-phenylene-diamine and amino-phenol, either alone or in mixtures. The dyeing resembles that of the application of Aniline Black, in that these preparations are oxidized on the fiber in the same manner as aniline, thus building up the dye directly in the fiber.

In the dyeing of furs the materials are first well scoured in lukewarm water containing olive oil soap and ammonia, and then rinsed well.*

* This is for the purpose of removing the oil and grease from the fur and is technically known as "killing" the fur. The chief methods of scouring are as follows: (a) steep for two hours in a cold 2 per cent solution of soda ash; (b) wash in a solution containing 1 gram of soap and 1 cc. of ammonia per liter of water for one to two hours at 120° F.; (c) wash in milk-of-lime prepared with 2 liters of water, 60 grams of powdered ammonium chloride, 15 grams of aluminium sulphate dissolved in water, and then adding with constant stirring 200 grams of quicklime made into a milk with 4 liters of water.

The fur is then steeped for six hours in a solution of chrome containing 5 grams of sodium bichromate per liter. Rinse well and place in a solution containing 3 grams of meta-phenylene-diamine and 2 grams of para-phenylene-diamine per liter of water with the addition of a small amount of hydrochloric acid or vanadium chloride (to act as a carrier of oxygen). After thoroughly working the solution into the fur allow it to steep in the liquor for about six hours. Then remove the fur, rinse well, and dry. This process should give a satisfactory black on the fur; for the production of brown shades lesser quantities of the above ingredients should be used, either alone or together. Amino-phenol may also be used for the same purpose. The proper shade can be obtained only by careful experiment with a sample of the fur to be used. After the fur has been dyed it is of advantage to rub in neatsfoot oil on the flesh side of the skins in order to keep the leather part soft and pliable. Meta-phenylene-diamine and para-phenylene-diamine and amino-phenol are to be met with in trade under a variety of names such as Furrol, Furrine, etc. These dyes are frequently specially prepared mixtures adapted to the production of various tones of color.

Various basic dyes may also be employed in the dyeing of fur, being applied in a lukewarm neutral bath, the fur being steeped in dye liquor for one to two hours. Most of the basic dyes may be used for this purpose, and they may be applied for the purpose of shading the brown or black colors obtained with the phenylene-diamine and amino-phenol dyes. In applying the Furrol dyes the colors are usually developed by an after-treatment with hydrogen peroxide, or the peroxide may be added to the dyebath, which is then prepared as follows: For 10 gallons of dye liquor use $1\frac{1}{2}$ to 6 ozs. of Furrol dyestuff dissolved in hot water, neutralize and then add twelve times the quantity of hydrogen peroxide (3 per cent solution) as dyestuff. Steep the skins in this solution until the fur has assumed the desired shade. Instead of hydrogen peroxide, sodium perborate may be used, in which case one-half the quantity of perborate as dyestuff is taken. Immediately before use the perborate is neutralized with formic acid.

Many different shades may be obtained on furs with the use of these dyes by using various mordants either alone or in combination with one another. Copperas, bluestone, and chrome may be used, but it must be remembered that chrome and copperas cannot be mixed together, though all other combinations of these three may be made. Tartar is recommended as an addition to the mordanting bath; for 10 gallons of mordanting solution use 5 ozs. of chrome, bluestone or copperas with $2\frac{1}{2}$ ozs. of tartar. This is a strong enough mordant for the heaviest shades or even black, and for the lighter shades it may be proportionately diluted. For the production of blacks it is well to use some copper sulphate.

After dyeing furs, especially in the case of heavy shades, the skins should be washed in lukewarm water and then to remove adhering unfixed dyestuff wash in a weak cold soap solution. This also prevents the tendency of the color in heavy shades of coming up bronzy.

A field of fur dyeing in which fancy colors are often used is the dyeing of sheep, goat and angora skins for use as rugs. For this purpose basic dyes may be used in a weak soap bath at 110° F. In order to preserve the flesh part of the skin from being dyed it is first coated with tallow or a mixture of fat having a higher melting-point than the temperature of the dyebath, or paper may be pasted on the flesh side and removed after dyeing. When the hair is hard and stiff and will not absorb the dyestuff readily the skins must be chlorinated by steeping the hair portion of the skins first in a

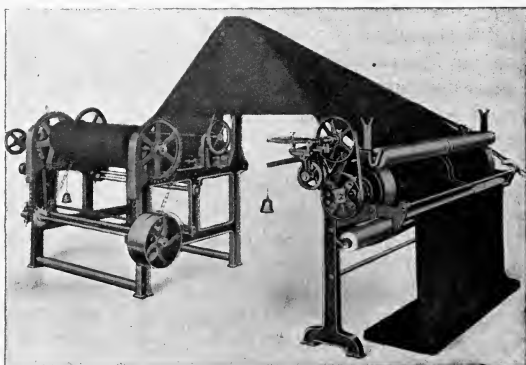

FIG. 288.—Cloth Doubling and Winding Machine. (Parks & Woolson.)

solution containing 1 gallon of hydrochloric acid per 100 gallons of water. This bath should be used cold for fifteen minutes. Then without rinsing place in a bath containing the clear solution from 10 ozs. of chloride of lime in 10 gallons of water; use cold for one hour, then run through the first acid bath again for fifteen minutes. Rinse in lukewarm water containing a small quantity of sodium hyposulphite or sodium bisulphite for the purpose of neutralizing the last traces of chlorine.

For the dyeing of skins the acid colors may also be used, in which case the dyebath is made up with the addition of 2 to 5 per cent of acetic acid. After dyeing and rinsing it is well to soften the hair by treating the skin in a bath containing 1 lb. of olive oil soap, 2 ozs. of olive oil and 1 oz. of ammonia to 10 gallons of water. After steeping in this liquor for fifteen minutes hydro-extract and dry without rinsing.

4. The Dyeing of Feathers.—Feathers consist of animal tissue of a nature very similar to that of wool, and they react with dyestuffs in much the same manner as that fiber. It must be remembered, however, that feathers consist of two parts, the fine fibrous-like portion and the hard quill, which is of a horn-like tissue; also the quality and properties of feathers differ very widely in their origin from the soft, delicate ostrich plume to the hard, stiff goose-quill. Many feathers are also possessed of a natural color which often varies through a wide range of shades even in the same class of feathers. The feathers that are mostly dyed are the natural white feathers, though at times colored feathers are also dyed, chiefly to a black color.

The principal dyes employed for feathers are the acid colors and to a much smaller extent the basic colors.* Before dyeing it is necessary to clean the feathers of the miscellaneous dirt and the natural grease they contain, and this is generally done with a lukewarm (100 to 120° F.) weak solution of soap or ammonia or ammonium carbonate. Sometimes the cleansing is done in cold water containing a little soda ash and some powdered starch. After scouring, the feathers should be well rinsed in lukewarm water. In the treatment of feathers care should be taken not to have the solutions too hot or too strongly alkaline, as these conditions would much impair the quality of the material.

In addition to cleansing, it is also frequently necessary to bleach feathers, either to obtain a good white color or for the purpose of subsequently dyeing a delicate bright shade. This may be best done by using a bath of hydrogen peroxide in a manner similar to the bleaching of wool or silk. Sometimes a satisfactory bleaching may be done with hydrosulphites (Hyraldite, Blankit, etc.).†

In dyeing with acid colors the feathers are treated in a bath for one to two hours just under the boil with the requisite amount of well-dissolved acid dyestuff together with 2 to 5 per cent of sulphuric acid (or 10 to 15 per cent of sodium bisulphate). As the material of the feather is rather difficult to penetrate it is well to employ only those dyes having good leveling properties and also to add the dyestuff solution in several portions to the bath, also do not use too short a bath.‡ After dyeing the feathers

* Substantive colors are seldom used for the dyeing of feathers, as the shades are rather dull for this class of work.

† Bed feathers may be bleached with hydrosulphites as follows (Badische): Pour fresh water over the well-washed feathers, and add in portions while stirring slowly and constantly 5 per cent of Blankit on the weight of the feathers. Leave the material for one to two hours in the bleaching bath stirring up every now and then with a wooden stick. Then rinse in pure water, hydro-extract and steam. The hydrosulphite solution may be used for bleaching further lots by freshening up with 1 to 3 per cent of Blankit.

‡ Wherever possible it is best to use a rotary dyeing machine for the dyeing of feathers, though where dyeing small lots (especially fancy feathers) the dyebath is usually made up in pails or small dyevats.

are well rinsed first in cold water and then in water containing a small quantity of sulphuric acid. In dyeing with colors like Eosin, Phloxine, Alphanol Blue, etc., use a small amount of acetic acid in the bath in place of sulphuric acid. After rinsing the feathers are dried in a rotating machine and usually mixed up with sawdust of powdered starch.

In dyeing blacks such colors as Feather Black, Acid Black, Wool Black, Naphthylamine Black, etc., are employed, using as short a bath as possible, containing 6 to 10 ozs. of the dyestuff and $1\frac{1}{2}$ to 2 ozs. of sulphuric acid per 10 gallons of liquor and dyeing at the boil for one to two hours. Ostrich feathers may be dyed black with 10 to 16 ozs. of dyestuff and 3 to 4 ozs. of formic acid per 10 gallons of liquor. A good black may also be obtained by dyeing with Anthracene Acid Black with the addition of 1 to 2 per cent of formic acid, boiling for one hour, then mordanting for one to two hours in a fresh boiling bath with 3 per cent of chrome and 3 per cent of bluestone and 1 per cent of formic acid; then rinse and top in a boiling bath with Logwood and Fustic extract. After dyeing brighten in a hot soap bath containing a little oil.

In dyeing basic colors on feathers use a weak soap bath at 100° F. in the case of light shades. When heavy shades are to be dyed add to the bath 3 to 5 per cent of acetic acid and dye at 175° F. Only the following basic colors are well suited for feather dyeing:

Rhodamine B and G
Methyl Violet B
Magenta
Janus Dyes

Bismarck Brown
Brilliant Green
Auramine
Methylene Blue

5. The Dyeing of Straw.—Straw is essentially a vegetable fiber but it is covered with a hard silicious tissue and usually has a pronounced yellowish color. Before dyeing it is necessary to scour the material in order to remove the waxy and fatty matters and dirt and also to soften up and wet-out the fiber so that the dyestuff solution may penetrate.* In the case of light and bright shades it will also be necessary to bleach the straw so as to remove most of the yellowish or brownish color of the natural fiber. The straw may be scoured by boiling in a soap bath containing a small amount of soda ash and then rinsing. For the purpose of wetting-out the material it should be steeped for several hours (or overnight) in boiling water or in a solution of sodium bisulphite of 1 to 3° Tw. Bleaching straw is usually done by stoving (treating with sulphur dioxide gas) or by steeping in a solution of hydrogen peroxide. Another method of bleaching is to

* For the wetting-out of straw and straw-braid it is recommended to boil the material for two hours in water containing $\frac{1}{2}$ lb. of sodium acetate per 100 lbs. of straw. While the sodium acetate materially assists in the boiling-out of the goods it also makes the straw more yellow in color. The use of a small amount of tartaric acid in boiling-out has a contrary effect, giving a lighter color to the material.

use a bath containing 10 gallons of water, $1\frac{1}{2}$ lbs. of oxalic acid and then slowly adding with constant stirring 1 lb. of sodium peroxide and then $1\frac{1}{2}$ lbs. of silicate of soda so that the bath shows an alkaline reaction with litmus paper. Steep in this bath until the yellow tint is removed. Then rinse in a weak solution of tartaric acid (or in a bath containing 1 oz. of sulphuric acid to 4 gallons of water), and finally washing well in fresh water.*

The classes of dyes employed for straw and straw-plait are the basic, acid and substantive colors. The first are mostly used for bright full shades and blacks on material that is easy to penetrate, while the acid dyes are used for all manner of colors and on straw that is more difficult to penetrate; the substantive dyes are used mostly for blacks.

In dyeing with the basic colors the well-wetted and still hot material is placed in a lukewarm dyebath containing 2 to 5 per cent of acetic acid and dyed at a gently boiling temperature for two to three hours. Good penetration of color may be facilitated by increasing the amount of acetic acid in the bath. In the case of dark shades it is well to allow the material to cool down in the dyebath overnight.†

The acid dyes are applied to straw in a concentrated bath with the addition of some acetic acid and boiling for three to four hours. The acid dyes are not very well taken up by the fiber and hence the baths do not exhaust.

The substantive dyes (it is seldom that any other dye but black is used in this case) are applied in a neutral boiling concentrated bath, or in a bath containing 5 per cent of soap.

Two-color effects may be obtained on split straw by dyeing the material first with Sulphur Black, Sulphur Brown, Sulphur Green or Sulphur Blue, using a bath containing 1 to 3 lbs. of the sulphur color and an equal quantity of sodium sulphide to 10 gallons of liquor; dye for twenty minutes at 70° F. To the bath may also be added 8 ozs. of soda ash and 2 lbs. of glauber salt. The dyeing must be carried out quickly, and then the goods are rinsed off well in cold and lukewarm water, and if the split is to be left white steep for one hour at 175° F. in a bath containing 4 ozs. of sulphuric acid and 4 ozs. of sodium bisulphite (64° Tw.), and finally rinse well. Or if

* Straw may also be bleached with hydrosulphite compounds, such as Blankit, in combination with hydrogen peroxide, as follows (Badische): Steep the material for several hours in the peroxide bath (prepared as described above), rinse and steep for several hours in a cold bath containing 10 lbs. of Blankit per 100 gallons of water. Rinse well and dry at a low temperature. The hydrosulphite bath may be used for further lots by freshening with one-third the original quantity of Blankit.

† To obtain well-penetrated colors with the basic dyes add all of the acid at the beginning and add the dye solution in several portions. Where Auramine is employed with other colors it must be added only after the boiling is finished, as this dye is decomposed at a boiling temperature.

a two-color effect is to be produced over-dye the straw with a suitable acid color in the manner already described.

In wetting-out, scouring, dyeing, or bleaching of straw materials the water employed should be as soft as possible, for if water is used containing lime salts the latter combine with the silicious compounds of the straw to form a sort of water-resisting cement which seriously impedes the action and penetration of the solutions used.

6. The Dyeing of Wood Chip and Plait.—This material differs somewhat from straw in that it consists of strips of wood, thin and tough, but more brittle than straw. It is used for the manufacture of hat materials, baskets, etc. Before dyeing the material must first be well wetted-out in water. For dyeing bright shades the basic dyes are used, while the acid

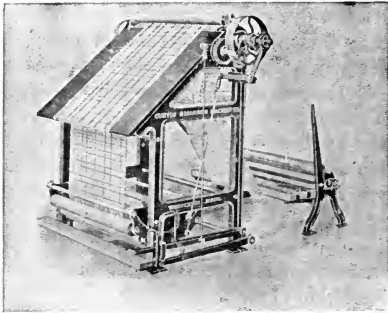

FIG. 289.—Cloth-inspecting Machine with Cradle, Reverse Motion, and Rolling Head. (Curtis & Marble.)

dyes are employed for light, clear colors, and some of the substantive colors are used for dyeing deep shades and blacks on goods that are difficult to penetrate. The basic colors are dyed in the same manner as for straw. The acid colors are applied in a dilute liquor at the boil for one hour with the addition of 2 to 5 per cent of acetic acid, and subsequently rinsing the goods thoroughly and drying at a moderate temperature. The substantive colors are dyed at the boil for one to two hours with the addition of 5 to 20 per cent of Glaubersalt (desiccated), and if the material is difficult to penetrate add 1 per cent of soda ash or borax.* When acid is used in any solution for dyeing wood chip the material must subsequently be washed very thoroughly to remove all trace of acid, as otherwise the chip will develop brittleness on drying. The sulphur dyes may also be used on this material, oftentimes with good advantage for the production

* In order to obtain the maximum depth of shade with any class of dyestuff it is well to allow the material after dyeing to steep for one to two hours in the cooling bath.

of fast shades. After dyeing with the sulphur colors the wood chip should be well washed and then acidulated with acetic acid in a dilute bath. The colors may be brightened by topping with the basic dyes. By this method shades of good fastness to light may be produced.

Wooden match sticks are mostly dyed with Rhodamine or Eosin. Fast Green also is sometimes used for this purpose.

7. The Dyeing of Horse-hair and Bristles.—These are animal fibers closely analogous to wool in their general characteristics and dyeing properties. Physically, however, they are much harder and more resistant to the penetration of dyes and solutions. The material must first be well cleaned by scouring in a lukewarm bath with 2 to 3 ozs. of soda ash or ammonia or ammonium carbonate and 8 ozs. of soap per 10 gallons of liquor. After scouring the goods are well washed to remove all soapy residues.

The principal colors used for the dyeing of horsehair and bristles are the acid dyes, but not all of the acid dyes are suited to this purpose. Those best adapted are the following:

Acid Black 4BL	Formyl Violet S4B
Acid Green	Indian Yellow R
Agalm: Black	Orange extra
Alizarine Blue SAP	Naphthylamine Black
Azo Rubine A	Palatine Black
Brilliant Croceine	Phenylamine Black 4B, T
Cyanole extra	Roccelline
Formyl Blue B	

These dyes are applied in a bath containing 2 to 3 per cent of sulphuric acid, starting at 120° F., gradually raising to the boil and boiling for one hour.* When dyeing blacks it is best to add the dyestuff solution to the bath in several portions in order to obtain better penetration. After dyeing the goods are lustered by treating with a lukewarm soap bath. A black may also be obtained by using the substantive dye Direct Deep Black E, EW, dyeing at the boil for one hour with the addition of 20 per cent of Glaubersalt and 2 per cent of soda, and then adding 2 per cent of acetic acid and continuing the boiling for one-half hour.

Cow-hair felts may be dyed in the same general manner as horsehair.

8. The Dyeing of Human Hair.—The human hair referred to in this connection is not that growing on the heads of living persons, but the hair that is brought into trade for the making of plaits, wigs, switches, and toupes. This hair is mostly obtained from China, Japan, and Russia and is usually black in color. The variety of colors to be obtained on hair are

* For the production of very fast colors the after-chromed acid dyes are suitable. Some of the substantive dyes may also be used.

naturally somewhat limited, consisting of various shades of brown for the most part, though gray and even red colors are sometimes required.

Owing to the black color of the natural product it is necessary to first bleach the hair before it can be dyed. This is usually done with a solution of hydrogen peroxide or sodium perborate. First the hair, which is usually very dirty, is scoured in a bath containing 10 gallons of water, 8 ozs. potassium carbonate, $\frac{1}{2}$ lb. of sodium perborate and 1 to 2 lbs. of soap, using a lukewarm bath (120° F.) and leaving the hair overnight in the cooling bath. Then wash well in soft water, and the hair should then possess a chestnut-brown color. It must now be further bleached with hydrogen peroxide (or sodium peroxide), the bleaching bath containing about 1 part of hydrogen peroxide (12 vols.) with 2 parts of water. The goods are steeped in this solution at a temperature of 140° F. and then left overnight. Afterwards they are well washed in a bath containing a small amount of oxalic acid. The bleaching may also be carried out with the use of sodium perborate, as follows: Dissolve 2 lbs. of sodium perborate in 10 gallons of water at 70° F. and add sufficient sulphuric acid to give a slight acid reaction with litmus paper (this is for the purpose of neutralizing the caustic alkali that is liberated when the perborate is dissolved in the water); then bring the bath to a slightly alkaline condition by the addition of ammonia. The well-scoured hair is entered in this solution at 85° F.; the temperature is gradually raised to 165° F. and the goods are left immersed in the liquor for one to two days.

After the hair is bleached it is soured in a bath for a few hours containing 10 lbs. of nitric acid per 10 gallons of water, and then well rinsed in fresh water and dried at a moderate temperature.

Oriental hair is considerably coarser than the hair of Americans or Europeans, and this requires that the hair be reduced in diameter. This is done between the bleaching and the souring with nitric acid by steeping the goods in a solution of chloride of lime of 0.2° Tw. for about two days. This makes the hair thinner and also gives it a high luster. After this treatment the hair is well washed, and then soured with nitric acid.

For the dyeing of human hair the acid colors are largely used, especially those which are fast to light, such as Acid Yellow AT, Alizarine Sapphire, Orange GG, Ponceau 4GB, etc. Also the chrome dyeing colors may be used (the chromate or mono-chrome dyes). The acid colors are dyed in a bath containing 5 per cent of Glaubersalt and 1 per cent of sulphuric acid, starting lukewarm and raising to the boil for one-quarter hour. The chrome colors are dyed with the addition of one-half the weight of chrome as of dyestuff, starting at 110° F., gradually raising to the boil, and after dyeing for one-half hour adding 2 to 3 per cent of acetic acid to exhaust the bath. Colors obtained in this manner are fast to light, wear, per-

spiration, and washing. By proper combination of the dyestuffs available suitable shades of brown, etc., may be produced.

Para-phenylene-diamine and amino-phenol are also used for the dyeing of fast dark brown shades on hair in the same manner as for fur. The natural dye Henna is also extensively employed for this purpose.

9. The Dyeing of Artificial Flowers.—Artificial flowers are made from various fabrics consisting of cotton, silk, satin (silk-cotton goods) and velvets as well as paper. The various parts of the flowers are cut out of the cloth by means of suitably shaped dies, and from these the flowers are built up by the deft handling of skilled workers. For some purposes the cloth is dyed in the piece previous to cutting up, and this is especially true in case very brilliant colors are required.* For most purposes, however, the cut pieces are dyed either in small packages or single, or in some cases by means of an air spray. Considerable skill and ingenuity must be exercised in order to obtain the proper shading and blending of the colors to imitate the natural coloring of the flowers.

The dyes employed for this purpose are those soluble in alcohol, though sometimes the dye is used dissolved in water and the solution diluted with an equal volume of alcohol. The object of using an alcohol solution is to have the dye in a form in which it will dry quickly on the cloth. The following dyes are soluble in alcohol and are suitable to this method of application:

Auracine G	Methyl Violet
Auramine	Methylene Blue
Bismarck Brown	Methylene Green
Brilliant Green	Methylene Violet
Chrysoidine	New Methylene Blue
Crystal Violet	Nigrosine (spirit sol.)
Diamond Fuchsine	Phosphine
Eosin	Rhodamine B, C
Indazine (spirit sol.)	Safranine
Irisamine G	Tannin Heliotrope
Janus Dyes	Thioflavine R
Lake Black	Vesuvine
Magenta	Victoria Blue

The dye solution is prepared by dissolving from 1 to 16 ozs. of the dyestuff in 1 gallon of lukewarm alcohol and the dyeing is done by dipping the cut forms of cloth into the cold or lukewarm solution, squeezing, then rubbing with a little oil or glycerin and drying.

Among the water-soluble dyes, the acid colors are the principal ones employed, though a few of the substantive dyes may also be used with satisfaction. It must be always borne in mind that the colors for arti-

* Where considerable fastness to light is desired it is best first to mercerize the cloth with caustic soda, bleach with chloride of lime, and dye with the acid colors.

ficial flowers must be bright and clear in tone and hence only the brightest acid dyes are suitable for the purpose. The following acid dyes are those mostly employed:

Acid Green 2G	Metanil Yellow
Acid Violet 4B	Naphthol Green B
Acid Yellow AT	Naphthol Yellow S
Alkali Blue	New Patent Blue
Brilliant Milling Green B	Orange ENZ
Brilliant Croceine	Rosazeine
Eosin	Rose Bengale
Erythrosine	Tartrazine
Formyl Violet S4B	Water Blue
Indian Yellow	

and the following substantive dyes:

Benzo Fast Black	Benzopurpurin 4B
Benzo Green G	Pluto Black BS
Benzo Sky Blue	

The required dyestuff is dissolved in warm water and then diluted with an equal volume of alcohol. It is also recommended to add some acetic acid or alum (4 ozs. per 10 gallons of solution).

Varied colored effects may be produced by dipping first in a solution to produce a light shade and then dipping again in a solution of another color. Very effective results are also obtained by using the air-brush (aerograph) with an alcoholic solution of the dyestuff, as in this manner the color may be sprayed wherever desired and delicate shading and blends may be obtained; also pattern effects may be produced with the aid of stencils and the air-brush. In some cases it is necessary to use insoluble color-lakes and these are applied in a medium of starch paste.

Natural flowers are sometimes colored artificially, the freshly cut flowers with the stem being used. The acid colors are mostly used in the form of a very dilute solution in pure soft water (distilled water is best), the flowers being simply dipped in these solutions and the color is absorbed through the plant tissues by capillary action. By using white or light-colored flowers and by properly selecting the dyestuffs peculiar and odd effects may often be produced in this manner. The dyes chiefly recommended for this purpose are

Acid Magenta	Fast Acid Yellow
Cyanole	Orange II
Acid Green	Acid Violet

Natural leaves and grasses and palm fronds are also dyed for the production of the so-called "everlasting" plants, largely used for decorative purposes and for funeral wreaths. These are mostly dyed with basic

colors in a water solution with the addition of a small quantity of glycerin and some acetic acid, the dyeing being carried out at the boil. After dyeing the goods are steeped for some time in a solution of 1 to 2 lbs. of glycerin to 1 gallon of water; or the leaves are steeped in a solution of magnesium chloride (or calcium chloride) of 15° Tw. with the addition of a small amount of emulsified oil, and then dried in the air.*

10. The Dyeing of Wood.—Wood may be dyed by two methods; in one the color solution is simply brushed on and allowed to penetrate as far as possible into the fiber of the material. Either a solution in water or alcohol may be used and only the most soluble dyes are employed. By this method it is only possible to obtain a rather superficial dyeing of the surface, as the color will not penetrate to any great depth. It is possible,

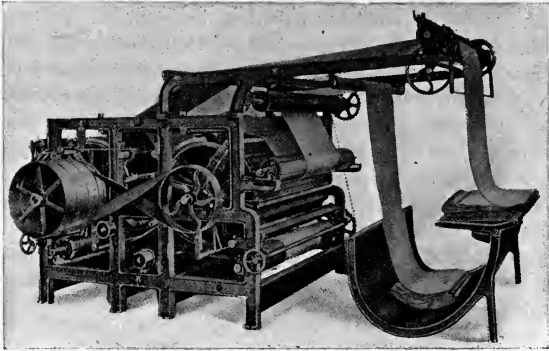

FIG. 290.—Two-cylinder Teasel Gig. (Parks & Woolson.)

however, by this means to dye veneers or thin split wood. Sometimes, instead of brushing on the solution the wood is steeped in the dye solution which may be employed either hot or cold. The second method of dyeing wood is to place the material in the dye liquor in a pressure tank and the apparatus is then put under a high pressure (80 to 120 atmospheres) for a period of two to twelve hours without heating. By this means large pieces of wood may be dyed throughout and with very uniform colors. Better results are obtained if the air is removed from the wood first by heating it in a vacuum chamber and then forcing in the dye solution. Usually this is carried out in the same apparatus as employed for the pressure dyeing.

In dyeing wood by the brushing or steeping method those basic, acid

* This treatment is for the purpose of making the goods soft and pliable, otherwise on drying the material would become brittle and lifeless.

or substantive dyes which are fast to light are principally employed. Dyes of good solubility are also of importance in this connection. For some purposes dyestuffs soluble in alcohol are used, in which case the basic colors are employed. For the dyeing of wood surfaces in connection with varnishes special products of spirit soluble dyes are manufactured. Some of the dyes which are insoluble in water (and hence useless for the ordinary purposes of dyeing) are used for this process; also spirit-soluble lakes made by precipitating certain dyes with rosin soap are used.

In dyeing wood by the pressure impregnation method the easily soluble acid dyes and some of the basic dyes are used. Pure water must be used for the solutions and they should be carefully filtered to obtain as perfect a solution as possible.

11. The Dyeing of Celluloid.—Celluloid is dyed in two forms, either during the process of manufacture when the celluloid material is still in the dough form and the dyes or their solutions are simply incorporated with the mass and worked in; or the celluloid may be dyed when manufactured in the form of films, in which case alcohol solutions of the dyes are employed. For dyeing the celluloid dough either coal-tar color-lakes or mineral dyes may be employed or spirit solutions of suitable dyes may be used which will amalgamate with the celluloid mass. By processes of mixing and blending the celluloid various color effects may be obtained for the production of fancy articles.

For the dyeing of celluloid films spirit-soluble colors are used as the celluloid is not penetrated by water solutions. The following dyes are suitable for this purpose:

Auramine	Metanil Yellow
Bismarck Brown	Methyl Violet
Brilliant Croceine R	Methylene Blue
Brilliant Green	Methylene Green
China Green	Naphthaline Yellow
Chrysoidine	Nigrosine (spirit sol.)
Crystal Violet	Quinoline Yellow
Cyanosine	Rhodamine B, G
Eosin	Rhoduline Violet
Irisamine G	Rosazeine
Janus Dyes	Safranine
Lake Black	Spirit Blue
Magenta	Tropaeoline G
Malachite Green	Victoria Blue
Marine Green	Victoria Yellow

The dyestuff is dissolved in alcohol (use 95 to 98 per cent) at 140 to 160° F., and the goods are dyed by steeping them in the solution or by spraying with the air-brush. When deep colors are dyed it is advised to rub the material with a little vaseline after dyeing.

For the dyeing of picture films containing a gelatin film on a celluloid base, and when the gelatin surface only is to be colored, the easily soluble acid dyes may be used in a water solution. The dyes are dissolved hot and well filtered, and the dyeing is carried out by dipping in the cold solution to which a little acetic acid may be added. As the gelatin is very absorptive of dye solutions, good colors may also be obtained by using various basic dyes or many of the substantive colors, and if proper care is exercised, the dyebaths may be used warm in order to obtain good penetration and development of the color. After dyeing the material should be well rinsed in running water and then carefully dried in the air. Rapid drying in hot air is to be avoided.

12. The Dyeing of Button Material.—Buttons are made from a variety of materials, the principal product used, perhaps, being what is known as Vegetable Ivory. This is a hard nut (Corozo) obtained in South and Central America. It is a hard ivory-like material, white in color with a slight yellowish tint, and consists of hardened vegetable tissue containing also substances of a nitrogenous character. Horn and mother-of-pearl are also used extensively for the manufacture of buttons, and to a lesser extent, ivory. Synthetic plastics such as Gallalith, Bakelite, and Celluloid are also used.

Buttons of vegetable ivory may be dyed with almost any of the substantive or basic colors dissolved in water, the buttons being steeped in the boiling solutions for several hours, the basic colors probably giving the best penetration while the substantive colors have the best fastness to rubbing. The color at best, however, penetrates only a slight distance below the surface. The mordant dyes and the natural dyewoods (or their extracts) are also largely used for the dyeing of vegetable ivory buttons. In this case it is necessary to fix the dye by treating with a boiling solution of a mordanting salt such as chrome or bluestone or copperas. The matching of colors on vegetable ivory is quite difficult, owing to the hard working qualities of the material, and much care and patient skill must be exercised in order to obtain the desired results.

Dyeing on vegetable ivory buttons is frequently done in a style to produce pattern effects and mottled colors where several different tones of color are desired. These effects are produced by using cut zinc stencils to cover the buttons contained in trays and applying the dyestuff by means of an air-brush or sprayer. The dye solution is made up with some China clay for purposes of thickening, is sprayed on hot in pattern effects, using the dyes for the lighter shades first and afterwards the heavy colors. The buttons are then dried and the paste removed from the surface by drumming with damp sawdust. The mordant dyes are largely used for this purpose, so the colors must afterward be fixed by boiling with a mordant, chrome being the chief salt employed for this purpose.

The substantive dyes are applied to vegetable ivory buttons by dyeing for one hour in a boiling bath containing 1 oz. soda ash and 1 lb. of glauber-salt per 10 gallons of liquor. Then the goods are allowed to cool down in the bath and finally rinsed well. The basic colors are dyed in a boiling bath containing 3 to 8 ozs. of acetic acid per 10 gallons of liquor. When dyeing heavy shades with the basic colors it will be necessary to first mordant the buttons with tannic acid and tartar emetic in the same manner as that employed for the mordanting of cotton.

After dyeing and rinsing the buttons are usually dried slowly in the air, as rapid dyeing in hot air is to be avoided or the buttons will warp and crack. Or the wet buttons may be dried by drumming in sawdust, which



FIG. 291.—Atherton Cloth Trimmer. (Curtis & Marble.)

is gradually warmed. After drying the materials are polished by drumming with fine abrasives such as powdered button waste, emery, etc.

Horn buttons are dyed best with the basic colors, using a bath at 120° to 140° F. containing a small amount of acetic acid. These colors exhaust well at the low temperature and the material is not affected. Acid dyes may be also used, but these require the dyeing to be done in a boiling bath, which usually causes the buttons to become softened and misshaped, which is a great disadvantage. For solid shades of brown and various mode colors the so-called fur dyes may be used to advantage. For this purpose the buttons must be mordanted with bluestone, copperas, or chrome by soaking the goods in a solution of 4 to 6 ozs. of the mordanting salt in 10 gallons of water. Start the process hot and allow to cool down in the liquor for eight to ten hours (overnight). Then rinse well in cold water and dye in a solution of 1 to 6 ozs. of the dye per 10 gallons, starting at

the boil and allowing to cool down in the liquor. Then add hydrogen peroxide (12 vol.) to the extent of about twelve times the weight of dyestuff used, and then leave in the solution until the shade is completely developed, which will usually require about six hours. In the dyeing of all button material the goods must be frequently stirred up during the process. After dyeing wash well in water and then in a weak soap solution.

Ivory buttons may be dyed in practically the same manner as those of horn. This also applies to the dyeing of ivory billiard balls or other objects of ivory.

Mother-of-pearl buttons are cut from shells of sea mollusks, and it is frequently required to dye them. In this case the basic dyes are mostly employed, and the dyeing is done either in an alcoholic solution or in a water solution to which an equal volume of alcohol is added, as the alcoholic liquor penetrates the mother-of-pearl material and stains it better than water alone. Before dyeing the material is prepared by steeping in a solution of potassium carbonate at 120° F. Then wash well and dry. The goods are then dyed by steeping in the color solution for several hours or until the desired shade is obtained. After dyeing rinse well in cold water and dry slowly to prevent cracking. Blacks and dark browns are frequently produced by staining the buttons with a solution of silver nitrate and allowing to oxidize.

Gallalith buttons are made from an artificial product prepared by treating casein with formaldehyde. The substantive and acid dyes are chiefly employed for the coloring of this material.

Bakelite (also Condensite and Redmanol) is a synthetic plastic obtained by the condensation of certain phenols with formaldehyde. It is usually of a yellowish brown color, but may be dyed with rather good effect by using basic colors in the same manner as in the dyeing of buttons of vegetable ivory.

CHAPTER XXVIII

APPLICATION OF DYESTUFFS IN THE PREPARATION OF LAKES, INKS, ETC.

1. **Preparation of Color-lakes.**—Lakes are insoluble compounds produced with dyestuffs and suitable metallic salts or bases. They are used extensively in the preparation of printing inks, lithographic inks, paints, and in the printing of wall-paper and such materials. In the preparation of lakes there are three factors to be considered: (a) the mineral bases or carriers, on which the colors are precipitated, the most important of which are aluminium hydrate paste, barytes, white fixing clay, China clay, and green earth, it being essential that these substances are of a very finely divided impalpable nature, so that when suitably mixed with water they furnish a smooth, non-gritty paste of a colloidal character;* (b) the precipitating agents; the chief ones being barium chloride, lead acetate, tannic acid and rosin soap; (c) the dyestuffs; which may consist of the acid, basic, phthalein or alizarine dyes, and such dyes prepared *in situ* as Paranitraniline Red. †

* There are a large number of carriers used in the making of lakes, including alumina, artificial barytes, natural barytes, lead sulphate, zinc white, lithopone, gypsum, whiting, China clay, precipitated chalk, starch, barium carbonate, magnesium carbonate, calcium phosphate, natural clays, ochre, umber, green earth, red lead, and others. The selection of the carrier depends greatly upon the use to which the lake is to be put. Lakes intended for ordinary painting to be mixed with varnish, oil, or spirit, and to have good covering power, should have carriers like lead sulphate, zinc white, lithopone, barytes, or red lead. In the making of colors for spirit varnishes artificial barytes will answer. Lakes intended for printing wall-paper are usually of a cheap grade and are made with alumina, artificial or natural barytes whiting, clay, starch, and the white and colored clays. Lakes for printing fancy papers must be of a better grade and have good covering power and give a uniform coating, and the carrier used may be alumina, artificial barytes, China clay, precipitated chalk, magnesium carbonate, and sometimes whiting. Printing inks, lithographic inks, and artists' colors require lakes of the finest character; if desired as transparent pigments these are made with alumina, either alone or mixed with more or less artificial barytes; if desired to be opaque the carrier used may be lead sulphate, zinc white, or lithopone. Lakes known as lime colors are made with green earth, white or colored clays, barytes, or gypsum, the two latter always forming the principal part.

† The following classification of dyestuffs for lake-making purposes is given by Zerr

Lakes from the acid dyes, as a rule, are prepared by precipitating the dyestuff solution in conjunction with aluminium hydrate either prepared previously as a paste or precipitated during the making of the lake by the interaction of aluminium sulphate and soda ash. The precipitated dye is carried down in intimate combination with the alumina forming an insoluble lake compound. The basic dyes are usually precipitated on China clay or barytes by the addition of tannic acid or rosin soap; or some of the basic dyes may be fixed directly (without the use of a precipitating agent) on green earth (especially used for the basic greens) or on white fixing clay. The alizarine dyes are precipitated with alum, soda ash, Turkey-red oil and calcium acetate. Of rather recent years there is a class of insoluble azo dyes which is largely used in the preparation of lakes. There are quite a number of these dyes at present known, some of the more important being Helio Fast Red G, Lithol Red, Autol Red, Pigment Orange, etc. These colors are prepared in the form of pastes and the lakes are made by simply mixing the dyestuff with suitable carriers by mechanical means. These colors are largely used in the making of lithographic inks, paints, and some artists' colors.

In the preparation of lake colors the various reagents are usually employed in solutions of the following strengths:

Aluminium sulphate.....	1 : 20
Soda ash.....	1 : 20
Barium chloride.....	1 : 20
Acetate of lead.....	1 : 20
Dyestuffs.....	1 : 50 or 1 : 100

Aluminium hydrate paste for use as a carrier in the preparation of lakes may be prepared as follows:*

and Rübenkamp (*Treatise on Color Manufacture*); the classification being based on the methods of precipitation:

(1) Dyes precipitated by the aid of barium chloride (really barytes, as the barium salt is precipitated as sulphate)—all the acid dyes.

(2) Dyes precipitated by the aid of lead salts—principally the resorcine or eosin colors.

(3) Dyes precipitated by tannin or tannin and tartar emetic—all the basic colors.

(4) Dyes precipitated by aluminium hydrate—the rosaniline and alizarine colors only.

(5) Dyes produced directly by precipitation—the insoluble azo or ice colors.

(6) Dyes absorbed directly by clays—the basic dyes alone.

This classification, however, must not be taken too rigidly, as dyes of one group are often precipitated by the medium for another group. For example, some azo dyes may be precipitated by lead salts, and some of the basic dyes form suitable lakes under certain conditions with barium chloride (Magenta, Rhodamine, Methyl Violet, etc.).

* Aluminium hydrate is probably the most important carrier used in the making of lakes and is always present in the best colors. It may either be used as such (and for this purpose prepared in the above manner) or it may be produced at the same time that

3 lbs. of aluminium sulphate dissolved in
 3 gallons of water, and add
 1½ lbs. of soda ash dissolved in
 1½ gallons of water.

Both solutions should be heated to 160° F., and the soda ash solution should be added to that of the aluminium sulphate with constant stirring. Allow to settle, wash, filter and press between cloths to a weight of 7 lbs., which will furnish a 10 per cent paste of aluminium hydrate.

The following methods for the precipitation of lakes have been recommended by the various color makers:

(1) Suitable for the preparation of lakes for colored papers and wall-papers:*

60 lbs. aluminium sulphate (1 : 20), are mixed with
 20 lbs. soda ash (1 : 20), then add
 100 lbs. barytes, then add
 15 to 30 lbs. dyestuff (1 : 50), and then precipitate at 85° F.
 75 to 90 lbs. barium chloride (1 : 20).

This method is employed with the various acid dyes.

(2) Suitable for use with certain acid dyes, such as Acid Green, Naphthol Green B, Cyanole, Fast Acid Yellow and China Yellow B, as a clearer waste water results than with the preceding method:

24 lbs. aluminium sulphate (1 : 20) are mixed with
 12 lbs. soda ash (1 : 20), then add
 100 lbs. barytes, then add
 10 to 25 lbs. dyestuff (1 : 50), and precipitate at 85° F. with
 105 lbs. barium chloride, and then precipitate the whole again with
 30 lbs. aluminium sulphate (1 : 20) hot and
 10 lbs. soda ash (1 : 20).

the lake is precipitated. It is only for the highest grade of lakes (for printing and lithographic inks and artists' colors) that aluminium hydrate is used alone; for other lakes it is always mixed with more or less barytes, the more barytes the lower the grade of the lake. The artificial barytes is customarily prepared at the time the lake is precipitated by the interaction of sodium sulphate and barium chloride, as this gives better results than if the ready-made barytes was added to the mixture. In making aluminium hydrate care must be had not to precipitate it with caustic alkali, as then a gelatinous and slimy mass is obtained which dries to a hard and horny material; it is also soluble in excess of the precipitating agent, therefore is unsuitable for the making of lakes. It is on this account that the precipitation of the aluminium hydrate is made with soda ash, as it is then insoluble in excess of the reagent, is less gelatinous, and when prepared from dilute solutions and at a higher temperature is opaque, white, and when dry is soft and easily powdered.

* The best types of wall-paper lakes should not contain a predominating amount of barytes, especially if the lake is sold in the paste form, for such lakes settle down quickly owing to the high gravity of the barytes, and this causes trouble in the printing machines. Also lakes containing barytes are not suited for coloring fancy papers, as the lake is stiff and has low covering power, and the coating becomes hard and rough.

(3) Suitable for the precipitation of certain of the substantive dyes, such as Benzo Sky Blue, Diamine Blue RW, and some of the substantive brown dyes;* also suitable for the preparation of lakes for use on colored paper and cheap lithographic inks, using the acid dyes:

75 lbs. aluminium sulphate (1 : 20) are mixed with
 35 lbs. soda ash (1 : 20), then add
 100 lbs. barytes, then add
 10 to 25 lbs. dyestuff, and precipitate at 85° F. with
 90 lbs. barium chloride (1 : 20)

(4) Suitable for most of the acid dyes and somewhat cheaper than (1) while at the same time yielding somewhat brighter lakes:

100 lbs. barytes are mixed to a paste with
 6 lbs. soda ash (1 : 20), then add
 10 lbs. dyestuff (1 : 50) and
 20 lbs. barium chloride (1 : 20) and
 13 lbs. aluminium sulphate (1 : 20)

(5) Suitable for lakes used in the finer lithographic inks, using the acid dyes:

150 lbs. aluminium hydrate paste (10 per cent) are mixed with
 10 lbs. dyestuff (1 : 50) and precipitated with
 10 to 15 lbs. barium chloride (1 : 20)

(6) Suitable for lakes for wall-papers, using certain acid dyes such as Acid Green, Naphthol Green, Cyanole and Lake Blue:

60 lbs. aluminium sulphate (1 : 20) are mixed with
 30 lbs. soda ash (1 : 20) and
 100 lbs. barytes, wash three times and then add
 15 to 30 lbs. dyestuff (1 : 50) and precipitate with
 12 to 25 gallons lead acetate solution (52° Tw.)

* The following are two examples of the preparation of lakes from the substantive dyes (Bayer):

For a pink lake.

5 parts Geranine G dissolved in
 500 parts hot water with
 100 parts aluminium hydrate paste, and precipitate with
 6 parts barium chloride dissolved in
 60 parts water

For a yellow lake

5 parts Chloramine Yellow M dissolved in
 500 parts water and add
 15 parts aluminium sulphate dissolved in
 150 parts water, and add
 7 parts soda ash dissolved in
 70 parts water, and add
 24 parts barium chloride dissolved in
 240 parts water, precipitating cold.

(7) Suitable for making lakes from the Eosin dyes:*

50 lbs. aluminium sulphate (1 : 20) are mixed with
 25 lbs. soda ash (1 : 20) and
 80 lbs. barium chloride (1 : 20), wash three times and add
 100 lbs. barytes and
 24 lbs. dyestuff (1 : 50), and precipitate with a cold solution of
 30 lbs. lead acetate or lead nitrate (1 : 20)

(8) Another method for making the Eosin lead lake is as follows:

100 parts aluminium hydrate paste are mixed with
 15 parts Eosin dissolved in
 1500 parts water, then precipitate cold with
 12 parts sugar of lead dissolved in
 120 parts water.

(9) Suitable for use with most of the basic dyes:

100 lbs. barytes and
 50 lbs. China clay are mixed to a good paste, then add
 5 lbs. dyestuff (1 : 100) and precipitate with a warm solution of
 7.5 lbs. tannic acid dissolved with
 7.5 lbs. sodium acetate in 30 gallons water.

Better precipitation may be obtained by the addition of 3 to 4 lbs. tartar emetic or antimony salt (1 : 20) after the tannic acid, and it will be unnecessary then to add the sodium acetate.

(10) The following is another method for making lakes from basic dyes by precipitation with tannic acid † (Bayer):

150 parts aluminium hydrate paste in water mixed with
 10 parts basic dyestuff, dissolved in
 1000 parts water, and add
 10 parts tannic acid dissolved in
 100 parts water, then add
 5 parts tartar emetic dissolved in 100 parts water.

* Lakes from the Eosin colors give finer shades when precipitated cold than when the solution is warm. When drying the temperature should be kept as low as possible and never over 120° F., otherwise the color will turn brownish. The Eosin lakes are very susceptible to acids and the shades may be made yellower or bluer, depending on the more or less acid reaction of the carrier employed. A cheap imitation of Vermilion may be obtained by using red oxide of lead as the carrier.

† In precipitating lakes from basic dyes with tannic acid, to obtain bright shades it is very necessary that all of the ingredients should be free from iron, as small traces of iron will cause a considerable dulling of the color. When the lake is intended for use for lithographic inks it is best to complete the precipitation by the addition of tartar emetic. Lakes from basic dyes may be saddened or darkened by adding some copperas with the tartar emetic.

(11) Suitable for use with the basic colors and giving especially brilliant lakes:

180 lbs. aluminium sulphate (1 : 20) are precipitated with
 90 lbs. soda ash (1 : 20) and stirred up with
 100 lbs. barytes, wash 3 times and add
 20 lbs. dyestuff (1 : 100) and precipitate with
 80-100 gallons rosin soap and
 30 lbs. white vitriol.

The rosin soap is prepared by boiling together 100 parts rosin, 26 parts soda ash and 500 parts water.

(12) Good lakes from the rosaniline basic dyes may be prepared with:

80 lbs. aluminium hydrate paste (10 per cent)
 20 lbs. blanc fixe and
 2 lbs. dyestuff (1 : 50).

(13) A process recommended for the basic dyes in general is:

20 grams dyestuff (1 : 100) stirred with
 100-400 grams kaolin and add
 200 cc. tannic acid solution (20 per cent) and
 200 cc. aluminium sulphate solution (20 per cent).

(14) Suitable for use with green basic dyes to make a cheap and fast green lake:

100 lbs. green earth are mixed with water and add
 2 lbs. dyestuff dissolved in 40 gallons water.

These lakes are fast to light and lime, but not so bright in tone as those produced by methods (8) and (9). By substituting white fixing clay for the green earth and using such basic dyes as Magenta, Methyl Violet, Methylene Blue, Auramine, and Chrysoidine, bright cheap lakes of good fastness to lime may be prepared.

(15) Lakes produced with the acid dyes or Para Red may be brightened or toned by topping with basic colors. The freshly precipitated lake is washed and mixed with

5 to 10 lbs. basic dye (1 : 50) and precipitated with
 6 to 15 lbs. tannic acid dissolved in 30 gallons water with
 6 to 15 lbs. sodium acetate.

Another process of shading with the basic dyes is to add the basic color immediately after the acid color and then precipitate both simultaneously with barium chloride after the methods given for use with the acid dyes.

The preparation of the lake colors necessitates very careful operation, and many factors play an important part in the successful outcome of the process in order to have the different lots of the same color match accurately

in shade and to maintain the proper brightness. The purity of the chemicals used is very important and all of them should be carefully examined and maintained constant in type. The degree of alkalinity and acidity, the concentration of the solution, the temperature, the sequence and duration of the mixing, and even the manner of stirring also play a considerable part in the results obtained.

When barium chloride is employed as the precipitating agent it forms with the dyestuff an insoluble barium compound which dyes the carrier or base. In the reaction common salt is formed in considerable amount and remains in solution, and this must be washed out of the precipitated lake in order that it may have the proper purity.

(16) A process given for use with the acid dyes is:

20 grams dyestuff dissolved in
2 liters water and stirred with
100 to 400 grams kaolin and add
200 cc. barium chloride solution (20 per cent) and
200 cc. aluminium sulphate solution (20 per cent).

(17) A process for Alkali Blue and Fast Green is as follows:

20 grams dyestuff dissolved in
3 liters water and stirred with
100 to 400 grams kaolin and add
12 grams stannous chloride dissolved in
20 cc. water.

(18) A process for the Eosin dyes is the following:

20 grams dyestuff dissolved in
2 liters water and stirred with
100 to 400 grams kaolin and add
200 cc. lead acetate * solution (20 per cent).

(19) A process which may be used for the substantive dyes is:

20 grams dyestuff dissolved in
2 liters water and stirred with
100 to 400 grams kaolin and add
200 cc. barium chloride solution (20 per cent).

When the lakes are to be used for lithographic purposes it is generally to use aluminium hydrate paste as the carrier instead of kaolin, blanc fixe, barytes, etc.

Alizarine lake colors are precipitated with alum, soda, Turkey-red oil, and very often in conjunction with line salts so that a double lake-color

* Nitrate of lead may also be used, but it must be remembered that the acetate of lead gives a more yellow tone to the lake than the nitrate.

with alumina and lime is formed which has a better tone than that prepared from alum alone. The alizarine lake-colors are very fast to light and water, and consequently are largely used for paints, water colors, lithographic inks and other purposes where a fast color is desirable. Some of the alizarine dyes may be precipitated cold with barium chloride, but most of them have to be boiled with an addition of alumina and Turkey-red oil so as to develop the color. The precipitated lake is washed well in hot water, filtered, pressed, and dried at a moderate temperature. Some of the lakes (especially those from Alizarine Red) are brightened by boiling with steam under pressure.

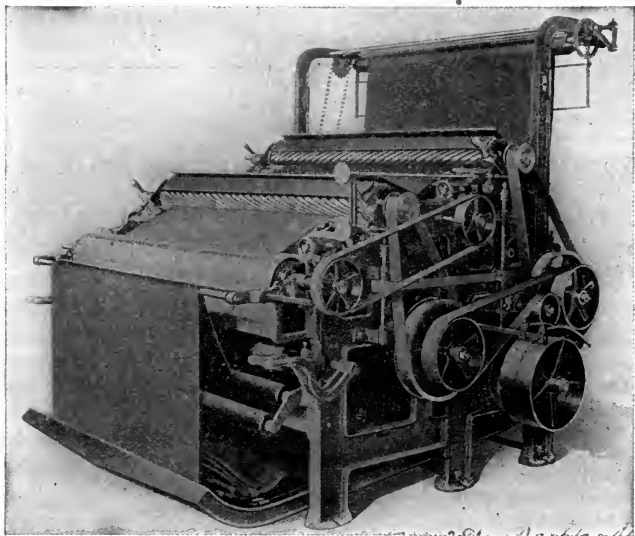

FIG. 292.—Double Woolen Shear. (Parks & Woolson).

(20) A typical method for the preparation of an alizarine lake is as follows:

- (a) Precipitate 243 cc. aluminium sulphate solution (1 : 10)
with 125 cc. soda ash solution (1 : 10) wash three times
Precipitate 30 cc. calcium chloride solution (1 : 10)
with 70 cc. sodium phosphate solution (1 : 10)
wash twice and add 3 cc. acetic acid solution (1 : 10).
- (b) Stir up 30 grams alizarine dye paste with
5 grams Turkey-red oil and
5 cc. calcium chloride solution (1 : 10) and
2 liters water.

Then add (a) to (b) and allow to remain for several hours and then gradually bring to the boil and boil for several hours until the color is completely developed.

The chemicals employed as well as the water and the vessels used must be as free from iron as possible in order to produce a clear bright lake. By using chromium, tin, or iron salts in place of or together with the alum salt, the colors of the lakes may be correspondingly altered. By using perchloride of tin with Alizarine Red, for example, a much brighter and more fiery color may be obtained.

(21) Another process for the making of alizarine lakes gives the following proportions of the ingredients:

75 lbs. sodium phosphate
20 lbs. soda ash
10 lbs. Turkey-red oil
35 lbs. alizarine dye paste
5 lbs. acetate of lime.

Valuable and beautiful lakes may also be prepared from the insoluble azo dyes, such as Paranitraniline, Nitrotoluidine Orange, and many others of that class. The Para Red lake is a brilliant red lake having very good fastness to light, water and lime, and also possessing great tinctorial power.

(22) To prepare Para Red lake proceed as follows (Bayer):

Solution A.

200 grams Paranitraniline S (or 100 gr. of Paranitraniline base) are stirred up well with 150 cc. hydrochloric acid (32° Tw.), in a few minutes stir in 2 liters boiling water. Boil for a short time until the Paranitraniline has become perfectly dissolved; then pour this solution in a fine stream into

4 liters water as cold as possible with constant stirring.

The temperature of the liquor thus mixed should not be above 50° F.

Then pour in quickly in a heavy stream into

55 grams sodium nitrite dissolved in
500 cc. cold water.

After a short time a clear diazo solution results. Should the solution be turbid it indicates either that the temperature was too high, or that the nitrite solution was not added quickly enough, or that there was not sufficient nitrite. The latter fact is easily ascertained by testing the solution with a piece of iodide-starch paper, which should turn blue, showing a slight excess of nitrite.

Solution B

115 grams beta-naphthol are stirred up with
265 cc. caustic soda solution 72° Tw., and dissolve in
50 cc. boiling water, then add
60 grams Turkey-red oil and
125 grams soda ash.

Solution C

243 grams aluminium sulphate dissolved in
2500 cc. water.

Pour solutions A and C simultaneously in a fine stream into solution B. Wash the precipitated lake several times with water and filter and dry at a low temperature.

Instead of using alumina as the carrier barytes may be employed, in which case the latter may be mixed directly with the beta-naphthol solution. By substituting up to 8 per cent of the beta-naphthol with Naphthol R (beta-naphthol-7-sulphonic acid) a lake possessing a much bluer shade may be obtained and having equally as good fastness.

By using Nitrotoluidine in place of Paranitraniline a brilliant orange lake is obtained having about the same fastness as Para Red. A good blue lake may be prepared from dianisidine and beta-naphthol, and a brown lake from alpha-naphthylamine and beta-naphthol or from benzidine base and beta-naphthol.

The basic and acid dyes may also be employed for the purpose of brightening or dyeing the ordinary mineral colors. There are several different processes for this purpose, the simplest being that of staining the pigment by stirring it up in a solution of the dyestuff. The pigment being in a very fine state of division will absorb (or perhaps more properly speaking *adsorb*) some of the dyestuff and will have its color altered thereby. It is probable that the dyestuff is simply held on the surface of the fine particles of the pigment. The colors produced in this way are not true lakes of the dyestuffs and have no special fastness, especially to water. Almost any of the usual acid or basic dyes may be employed for this purpose.

The following is a list of dyestuffs that are particularly well adapted to the making of lakes:

Acid Alizarine Blue BB	Beta-naphthol R	Chloranisidine P
Acid Blue B, R, G	Beta-naphthylamine base	Cotton Scarlet
Acid Green L	Bismarck Brown	Croceine
Acid Magenta G	Bordeaux G	Croceine Scarlet 10B
Acid Violets	Brilliant Black B	Crystal Scarlet 6R
Alkali Blues	Brilliant Carmine L	Crystal Violet
Alizarine Orange N	Brilliant Croceine 3B	Curcumeine
Alizarine Red	Brilliant Croceine M	Eosin O, C, B, 2G, A, S
Alpha-naphthylamine salt	Brilliant Green	Eosin Acid L
Amaranth Red	Brilliant Orange G, R	Erythrosine
Astacine Red	Brilliant Red G, R	Excelsior Scarlet for Lakes
Auramine	Brilliant Rhoduline Red B	Formyl Violet S4B
Autol Orange	Brilliant Scarlet G, R	Gold Orange
Autol Red	Brilliant Sky Blue	Green PL
Azarine	Brilliant Violet 5BO	Guinea Green G, B
Azo Yellow O	Bromofluoresceine	Guinea Violet 4B
Beta-naphthol	Capri Blue GON	Helio Azurine R1, BL

Helio Fast Blue BL, SL	New Red L	Pyramine Yellow G for Lakes
Helio Fast Red G	New Solid Green 2B	Pure Blue O
Helio Orange RM	New Victoria Blue	Quinoline Yellow
Helio Purpurine B	Nile Blue 2B, R	Rhodamine B, S, G, 6G
Lake Blue, I, CB, RT	Nitrosamine Red	Rhoduline Red G
Lake Bordeaux B	Nitrotoluidine	Rose Bengale NT
Lake Green BW	Opal Blue	Rubine N, W
Lake Orange ON	Orange II, ENL, A, 2R, 2L	Safranine T, MN, BS, 2RA
Lake Reds	Palatine Lake Scarlet G	Scarlet GRL, 4BG, BO
Lake Scarlets	Paper Yellow 2G, A, 3G	GVL, GL, RL, 4R
Lake Violet	Paranitraniline	Sky Blue
Lithol Red R, 2G	Patent Blue L	Solid Green FII
Malachite Green	Permanent Red 6B	Thioflavine T
Manchester Brown 2E	Phosphine 3R, 2G	Turquoise Blue G, GL
Methylene Blue 2B, R	Phloxine BA, 2BN	Vesuvine BL, 4BG
Methyl Green SF	Pigment Bordeaux R, N	Victoria Blue R, B, 4R
Methyl Violet MB, 2B, 5B	Pigment Chlorine 2G	Victoria Yellow
Milling Yellow O	Pigment Chrome Yellow L	Victoria Pure Blue B
Mordant Yellow R, G	Pigment Fast Yellow R, G	Water Blue R, 3R
Naphthol Yellow S	Pigment Orange R	Wool Blue N
Naphthol Green B	Pigment Purple A	Xylene Blue AS
Neptune Green	Pigment Red B, G	Xylidiae Scarlet
New Magenta	Pigment Scarlet 3B	
New Methylene Blue F, 2G	Pluto Orange G	

The following dyes produce lakes which have great fastness to light:

Alizarine Orange N	Helio Fast Blue BL, SL	Permanent Red 6B
Alizarine Red 2A, RX, PS, V	Helio Fast Red G	Pigment Chrome Yellow L
Astacine Red	Lake Bordeaux B	Pigment Orange R
Citronine G, A	Lithol Red R, 2G	Pigment Red B
Fast Navy Blue R	Naphthol R	Pigment Scarlet 3B
Fast Orange O	Naphthol Yellow S	
	Naphthol Green B	

2. Preparation of Spirit Lakes.—These lakes are soluble in alcohol (or amyl alcohol) and the solution is used by brushing on the surfaces of metals, wood, glass, bronze, celluloid, or other suitable material and then dried at a moderate temperature. These lakes are prepared mostly from the basic colors and the dyes used must be readily soluble in alcohol (or methyl alcohol or amyl alcohol)*. From 5 to 30 grams of the dyestuff (depending on the depth of shade desired) are dissolved in 1 liter of alcohol, the solution filtered if necessary to obtain a clear liquor, and then mixed with 1 liter of what is known as capsule lake, which is prepared by dissolving 625 grams of Gum Sandarac and 175 grams of Venice Turpentine in 1 liter of alcohol at a moderately warm temperature. The lake is employed in the form of

* The introduction of a sulphonic acid into a dyestuff usually makes the dye insoluble in methyl alcohol; though there are certain exceptions to this rule, such as the sulpho-**ated rosaniline blues** (Soluble Blue and Water Blue).

its solution obtained in this manner. Other varieties of spirit varnish may be used for this purpose in the same manner.

The following dyes are suitable for this purpose:

Auramine	Janus Dyes	Phosphine
Bismarck Brown	Leather Yellow	Rhodamine
Brilliant Croceine R	Magenta	Rhoduline Violet
Brilliant Green	Malachite Green	Rosazeine
Cerasine Dyes	Metanil Yellow	Safranine
China Green	Methyl Violet B, R	Tannin Heliotrope
Chrysoidine	Methylene Blue	Tannin Orange R
Eosin	Methylene Violet	Thioflavine T
Induline (spirit sol.)	Naphthylamine Yellow	Victoria Blue B
Irisamine	Nigrosine (spirit sol.)	Victoria Yellow

3. The Dyeing of Soap.—Soap may be dyed according to two different methods: (1) The color solution is added directly to the refining pan con-

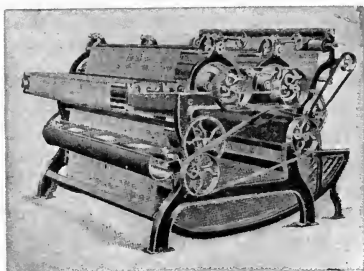

FIG. 293.—Two-cylinder Double-acting Brushing Machine with Steaming Apparatus. (Curtis & Marble.)

taining the melted soap, or (2) the color solution may be added to the dry soap shavings and the mixture worked in a suitable mixing or kneading machine until the color is thoroughly incorporated with the soap. The dyestuffs employed for the first method are somewhat limited in number as the color must be capable of withstanding the action of the boiling alkaline soap solution. Sometimes the dye may be changed on boiling but comes back to the proper color again on cooling. In applying the color the dye is dissolved in as small an amount of water as possible with the addition if necessary of some alcohol and a little caustic soda. When hot saponification is used (curd soap, etc.) the solution of dyestuff should not be added until after the saponification is complete, but when cold saponification is employed (cocoanut oil soap, etc.) the dyestuff solution may be added during the process.

The following dyes are suitable for the coloring of soap:

Acid Brown B, G	Croceine Orange G, R	Orange IV
Acid Congo R	Direct Green	Paper Red E
Acid Violet HW	Eosin	Paper Scarlet G, R, B
Alkali Fast Green B	Erythrosine	Patent Blue A, V
Azo Yellow O, R	Ethyl Blue	Quinoline Yellow
Bismarck Brown	Fast Acid Violet A2R	Rhodamine B, G
Brilliant Croceine 3B	Fast Brown	Rosazeine
Brilliant Orange G, O, R	Fast Green	Safranine
Chlorantine Blue B	Fast Light Yellow G	Scarlet (various brands)
Chlorantine Brown B	Fast Red O	Soap Dyes
Chlorantine Orange	Indian Yellow G, R	Soluble Blue
Chlorantine Red	Induline B	Tartrazine
Chlorantine Rose	Ketone Blue	Transparent Brown O
Chlorantine Yellow	Mandarine G	Transparent Green O
Coriphosphine	Metanil Yellow	Transparent Violet
Cotton Blue	New Patent Blue	Vesuvine 4BG
Cotton Red C	Night Blue	Victoria Yellow
Cotton Yellow	Orange II	Wool Blue N

4. Dyestuffs for Inks.—In former times black inks were made principally from tannic and gallic acids and iron salts or soluble Prussian blue, but at the present time with the very extensive use of fountain pens it is necessary to have a completely soluble ink which will not settle out in the least, and many of these inks are now prepared with suitable coal-tar dyestuffs, either alone or in combination with tannin-iron inks. For ordinary writing inks dyes that are fast to light and very soluble in water are selected and the ink consists of the dyestuff solution in water to which is added a small quantity of gum arabic and alcohol. In the preparation of copying inks some hydroscopic agent must be added, such as glycerin, glucose, sugar, dextrin, etc. Hectograph inks require a larger quantity of glycerin. In all inks a small quantity of carbolic acid or salicylic acid is added as a preservative. Colored inks other than black are nearly always made at the present time from dyestuffs.

The following methods recommended by different dye manufacturers will illustrate the process of ink making.

(1) Method of preparing aniline ink:

- $\frac{1}{2}$ to 2 lbs. of dyestuff are dissolved with
- 6 to 8 ozs. gum arabic in
- 10 gallons water, and add
- $\frac{1}{4}$ pint alcohol solution salicylic acid (1 : 10).

To prepare a copying ink the above method may be used with the addition of 4 to 5 lbs. of glycerin.

(2) Method of preparing red ink:

- 1 oz. Eosin S (yellow shade) dissolved in
- 5 pints distilled water, and stir slowly into hot
- 1 oz. gum arabic dissolved in
- 2½ gallons distilled water.

(3) A violet hectograph ink is made as follows:

- 100 grams Methyl Violet dissolved in
- 50 grams acetic acid (9° Tw.)
- 100 grams alcohol
- 100 grams distilled water
- 50 grams glycerin.

(4) A black ink not affected by water is made as follows:

- A. 2½ lbs. tannic acid dissolved in
- 1 gallon water
- 2½ lbs. copper sulphate dissolved in
- 1 gallon water
- 2½ pints acetic acid
- $\frac{4}{10}$ pint hydrochloric acid
- Make up to 10 gallons with water;
- B. 2½ lbs. Naphthol Black L 115
- $\frac{3}{4}$ pint alcoholic solution salicylic acid (1 : 10)
- Make up to 10 gallons with water.

Then mix the two solutions together.

(5) Tannin ink shaded with a dyestuff: (so-called alizarine ink):

- 23.4 parts tannic acid
- 7.7 parts gallic acid
- 7.2 parts hydrochloric acid
- 10 parts gum arabic
- 30 parts copperas
- 1 to 3 parts dyestuff
- $\frac{1}{2}$ part salicylic acid (or 1 part carbolic acid)
- 937 parts water.

The tannic and gallic acids are dissolved in warm water and the gum arabic in cold water, mixing the two solutions when cold, then add the hydrochloric acid and the copperas dissolved in cold water, and finally the salicylic acid.* The solution is then allowed to settle for four to five days, is filtered, and then the dyestuff ($\frac{1}{10}$ to $\frac{1}{2}$ per cent) in solution is added to the filtered liquid. Soluble Blue is mostly used for this purpose, with slight additions of such dyes as Cyanole, Acid Green, or Naphthol Black.

* Many inks at the present time are supplied in powder form, the ink being made up simply by addition of cold water. Ink powders usually consist of the properly proportioned mixture of tannin, copperas, and dyestuff, with a small amount of salicylic acid as a preservative.

Patent Blue, Ketone Blue, Naphthalene Green, Nigrosine, Night Blue, New Patent Blue, and Dianil Black may also be used.*

(6) Method for preparing stamping inks:†

1 to 1½ lbs. dyestuff dissolved in
6 lbs. glycerin and
3 pints water in which are previously dissolved
2½ lbs. gum arabic.

A very good ink may be prepared by the use of a special dyestuff known as Hydra Black, as this possesses great fastness to light and excellent solubility. The solution is made with 40 grams per liter for ordinary writing inks and 80 to 100 grams per liter for copying inks.

The following dyes are suitable for the preparation of inks; as they resist the action of metallic salts and acids and may be used for the better quality of aniline inks, shading tannin inks, and the so-called alizarine inks:

Acid Green	Naphthalene Green V	Patent Blue A, V
Brilliant Cochineal 2R	Naphthol Black L	Pure Soluble Blue
Cotton Blue	Naphthol Blue Black	Tetra Cyanole V
Cyanole extra	New Patent Blue B	Water Blue
Ketone Blue 4BN	Nigrosine	

The following dyes are affected by metallic salts and acids and therefore are only suitable for producing aniline inks, stamping inks, and hectograph inks:

Acid Violet	Diamond Fuchsine	Methyl Violet
Amaranth G, B	Eosin	Methylene Blue
Auramine	Eosin Scarlet B	Nerazine G
Bismarck Brown	Erythrosine	New Magenta
Brilliant Green	Induline	Orange II
Carbon Black	Jute Black	Rhodamine B, G, 6G
China Green	Magenta	Rosazeine
Crystal Violet	Malachite Green	

* The use of the dyestuff in this case is for the so-called "sighting" of the ink; that is, making the writing clearly visible until the oxidation of the iron tannate by the atmosphere leads to the full development of the color of the ink. Nearly all of the better quality inks depend for their final color on the development of iron tannate. Soluble Blue is especially suitable, as it is not precipitated on long standing with tannin, whereas many other dyes are.

† Marking inks for laundry use are now mostly made on a bases of Aniline Black. The following formula is given by Whittaker:

Solution A

85 parts copper chloride
106 parts sodium chlorate
53 parts ammonium chloride
600 parts water

Solution B

30 parts glycerin
20 parts gum
40 parts water
60 parts aniline salts
90 parts water

Mix 1 part A with 4 parts B just before use. The ink takes twelve to twenty-four hours to develop.

5. Dyestuffs for Typewriter Ribbons.—The inks used for typewriter ribbons are made from basic dyes rubbed down to a fine paste with vaseline oil and this is used for impregnating the ribbons. Glycerin may also be used in place of mineral oil, using 5 lbs. of dyestuff rubbed up with 25 lbs. of glycerin and then dissolving by heating to 195° F. Should any

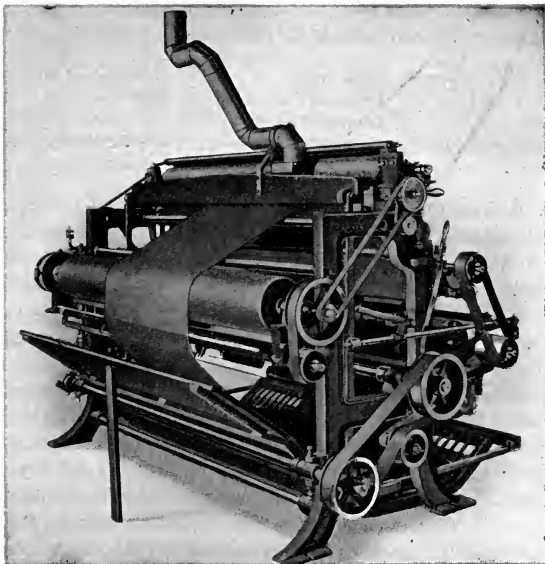

FIG. 294.—Velvet and Plush Shear. (Parks & Woolson.)

dyestuff separate during cooling a little water is added and the mixture heated again. The following dyes are mostly used:

Carbon Black
Jute Black

Methyl Violet
Methylene Blue

Safranine G
Scarlet for Cotton

6. Dyeing of Perfumes.—As perfume materials are dissolved in alcohol the dyestuffs employed for tinting the perfumes must be soluble in alcohol. The dyes mostly employed are:

Eosin
Rhodamine B,G, 6G

Metanil Yellow
Quinoline Yellow

Induline B
Bismarck Brown

7. Dyeing of Candles, Oils, and Waxes.—In dyeing these materials dyestuffs must be employed which are soluble in oil. There are many

special dyes prepared by combining the bases of basic dyes with a fatty acid, such as stearic acid, by melting the base with the acid. The combination thus obtained is soluble in oils and waxes. These special dyes are known under various names, such as Cerasine, Ceres, Fat Dyes, Sudan Dyes, etc. Many of the basic dyes may also be used directly. To dye the material the color is warmed up with the grease or wax and thoroughly mixed.

The following dyes are suitable for this purpose:

Alizarine Blue SKY (oil sol.)	Ceres Dyes	Indazine (oil sol.)
Alizarine Green, C, V	Diamond Fuch sine	Nigrosine Base
Brilliant Green	Diamond Orange	Oil Soluble Dyes
Brilliant Scarlet (oil sol.)	Eosin S	Rhodamine B, G, 6G
Cerasine Dyes	Fat Dyes	Safranine

8. Use of Dyestuffs for Coloring Food Products.—Coloring matters have long been used for the tinting or dyeing of various food products. In former times many natural dyes were employed for this purpose, a good example being the coloring of butter yellow by the use of Annatto. In preserving fruits and vegetables, it often happens that the natural colors with which we are familiar in the fresh material are lost or changed, and in order to give the preserved product a more natural appearance, recourse is had to addition of suitable coloring matters. With the advent of the coal-tar dyes, it was not long before many of them were used in the coloring of food products, confections, liquors, etc. The practice became so widespread that considerable opposition was aroused in this country over the use of "poisonous aniline dyes" in materials used for food purposes. As a result the U. S. Government had a very thorough investigation of the matter made with the result that it authorized the use of certain coal-tar dyestuffs for the coloring of such products. At the present time these dyes comprise the following:

Amaranth	Light Greer. SF, yellowish	Sudan I
Butter Yellow	Naphthol Yellow S	Tartrazine
Erythrosine	Orange I	Yellow AB
Indigo Carmine	Ponceau 3R	Yellow OB

These colors have been selected for permitted use in foods and beverages on account of their known harmless character, and furthermore their methods of manufacture are such that pure products, free from any poisonous ingredients, can be obtained.

All of the colors belong to the class of acid dyes with the exception of the last two, which are fat soluble dyes.

The number of food products which are customarily artificially colored is very large, including butter and cheese, liquors, wines, distilled liquors, egg powders, custard, blanc-mange, jellies, chocolates, candies and con-

fections of all sorts, cakes, lemonades and soft drinks of various kinds, mustard, pickles, ices, preserved and canned fruits and canned vegetables. Dyes used for coloring food products must be very soluble, and the solutions must not show turbidity on standing. Besides the coal-tar dyes specified above, there are also a number of preparations from various natural dyes used in coloring foods and beverages.

9. Use of Dyestuffs as Indicators.—Some of the dyestuffs may be used as indicators in chemical analysis by reason of their sensitiveness to alkalies or acids. Congo Red, for example, is very sensitive to acids, turning from a bright red color to a dark blue in the presence of acid. Some dyestuffs, in fact that have no value for purposes of dyeing, are very useful as indicators, such as Methyl Orange or Orange III. Other dyes useful as indicators are as follows:

Acid Magenta	Croceine	Malachite Green
Alizarine Red	Erythrosine	Methyl Green
Alizarine Blue S	Fast Red	Methyl Orange
Alizarine Green	Fluoresceine	Methyl Violet
Alkali Green	Indigo Carmine	Phenolphthalein
Benzo Purpurine B	Magdala Red	Tropaeoline
Congo Red		

10. Use of Dyestuffs in Medicine.—Many dyestuffs have been used in clinical analysis as microscopic stains, and specially purified products have long been manufactured for this purpose. Also some dyes or dyestuff intermediates have been used as drugs on account of their specific physiological effects, as for example, Methylene Blue and Phenolphthalein. Recently it has been shown that certain dyes possess strong antiseptic properties and may be used to excellent advantage in the treatment of wounds to prevent gangrene, or in certain diseases where strong antiseptics are needed, as when dealing with the invasion of streptococcus, gonococcus, and parasitic bacilli. An acridine dye known as Flavine is particularly valuable, as are also Malachite Green, Brilliant Green and Acid Scarlet R.

CHAPTER XXIX

TESTING OF DYESTUFFS

1. To Obtain the Money Value of a Dyestuff Sample.—In the testing of a dyestuff sample for its money value it is, of course, necessary to test it in comparison with another sample of the same (or a strictly similar) dyestuff of a known or established money value. Take two samples of Wool Blue and prepare solutions of the same containing 2.5 grams per liter, labeling them "A" and "B." Prepare two dyebaths containing the same amount of water, acid, and glaubersalt, and add 10 cc. of the respective dyestuff solutions. Then dye two test skeins of woolen yarn identical in character and weight in these baths, maintaining carefully the same conditions as to temperature and time of dyeing in both cases. After dyeing in the usual manner for forty-five minutes, remove the two skeins, squeeze the excess of liquor back into the respective dyebaths, and then dry up portions of the two skeins. Now compare these for depth of color and set aside the heavier shade for comparison; continue dyeing the weaker shade, adding to the dyebath sufficient of its respective color to bring the shade to a match with the other sample. The amounts of the two dyestuff solutions used to produce the same depth of shade will be inversely proportional to the values of the respective dyes, so if the actual money value of one of the samples is known it is a simple matter to calculate the relative value of the second. For example, suppose that on the first dyeing, sample "A" proved to be strongest dyestuff; on continuing the dyeing of "B," it was necessary to use 2.5 cc. more dye solution to match "A"; further, suppose that sample "A" was priced at 42 cents per pound. What would be the relative money value of "B"?

Dye solution used for "A," 10 cc.

Dye solution used for "B," 12.5 cc.

Then $12.5 : 10 = 42 : x$

and $x = \frac{10 \times 42}{12.5} = 33.6$ cents per pound.

This method of testing the comparative strength or value of dyestuffs may be carried to a rather high degree of accuracy, but it is necessary that

the comparative dyetests be made under exactly the same conditions in every respect, and also that the eye be trained to match the depth of colors with great accuracy. The amounts of the dye solutions should be accurately measured by means of a graduated pipette, and exactly the same amounts of sulphuric acid and glaubersalt should also be taken by means of definitely measured solutions; and further the total volume of each dyebath should be the same. To insure the most accurate results, it is best to carry out a second dyeing of the weaker sample, using the required amount of its solution added to the bath all at one time. This is especially desirable if the second sample has been brought to a match by a number of successive additions of the color solution. For instance, in the sample quoted above, suppose the several additions of the color solution of " B " to have been as follows:

First,	10 cc.	Fourth,	0.5 cc.
Second,	1 cc.	Fifth,	0.3 cc.
Third,	0.5 cc.	Sixth,	0.2 cc.

making in all 12.5 cc. It would be better then to dye another skein, using 12.5 cc. as a first addition to the dyebath. It will frequently be found that a slightly increased amount of the dye solution will be required to bring this second test to a match. This is accounted for by the fact that the prolonged dyeing necessitated by the numerous additions to the bath will cause an abnormal absorption of dyestuff.

If properly carried out, this method of analysis is capable of giving results accurate to within at least 5 per cent, provided the samples being tested are the same kind of dyestuff. If, however, the dyes are not quite of the same tone of color, some difficulty may be experienced in judging accurately the point at which the samples are matched and considerable skill in matching will be required to arrive at their proper valuation. The matching in this case may be usually rendered somewhat easier by observing the colors through red, blue, or yellow glasses, which have the effect of cutting out certain undesirable tones. Furthermore, the eye is more sensitive to differences in intensity of some colors than in others; for instance, it is quite difficult to detect small differences in the depth of yellow colors, whereas in blues or reds small differences are easily detected. Violet colors and reddish tones of blue are also rather difficult to match accurately; and dull and broken tones of any color are harder to approximate than clear and bright tones. It is not well to employ too heavy shades for comparison, or the accuracy of the method will be much impaired.

As sometimes one dyestuff may exhaust better in the first bath than another corresponding dye, or even with the same dyestuff it is at times possible to mix with it some chemical to cause it to exhaust better than when pure, in the practical testing of dyes it is best to make an *exhaust test*.

This is done by diluting the dyebath used for the first dyeing to its original volume, and without the further addition of dyestuff or reagents, to dye a second test skein. The intensity of the dyeing thus obtained will measure the degree of exhaustion of the dyestuff in the first bath.

It is not well to employ too heavy shades for comparison; as a rule, from $\frac{1}{2}$ to 1 per cent dyeings will be found quite satisfactory for most colors. In the case of black dyes, however, where it is necessary to obtain a comparison of the tone of black produced, it will, of course, be necessary to use more than 1 per cent of dyestuff.

In cases where the test skeins must be mordanted or otherwise treated before or after the dyeing, care must be taken that the several skeins employed in the tests receive exactly the same manner and degree of treatment. In order to insure the proper conditions it is best to mordant all the test skeins used simultaneously and together in the same bath; and this should also be done where any after-treatment of the dyeing is required.

Make a comparative test of two samples of a substantive cotton color; two samples of a basic color for cotton, mordanting with tannin-antimony; two samples of an alizarine color for wool on a chrome mordant; and two samples of an anthracene color for wool, after-mordanting with chrome. In all these cases make exhaust tests in the same dyebath.

2. To Determine if a Dyestuff is Simple or Mixed.—A large number of the dyestuffs on the market are not simple or single coloring matters, but consist of two or more dyestuffs mixed together. This mixing of colors is practiced for the purpose of altering the tone of the dyestuff; or for the forming of various colors, such as the production of a green by mixing a blue and a yellow dye. It is also practiced for the purpose of adulterating various dyes with others of cheaper quality.

The presence of mixtures in a dyestuff, however, must not always be taken as evidence of sophistication. In the manufacture of dyestuffs it often happens that successive lots of the same coloring matter do not exhibit precisely the same tone, but it is very desirable to the dyer that the dyestuff as sold should always be of exactly the same tone. The manufacturer, therefore, adopts a standard, and tones the various lots to match this standard by the proper addition of suitable but similar dyes. Therefore a dyestuff may be a perfectly true article and yet show evidence of mixed colors. The amount of mixture, however, under these circumstances is very small; whereas admixture for purposes of sophistication is usually rather large.

A simple test of considerable practical value for detecting a mixture of dyes is as follows: Moisten a small sheet of paper with water, place a little of the dyestuff on one end of the paper and then blow the breath across it so as to scatter the dyestuff in fine particles over the paper. A mixture of dyes will generally give a mottled appearance of several colors. A modi-

fication of this test, which at times will yield better results, is to place some concentrated sulphuric acid in a porcelain dish, and then sprinkle a little of the suspected dyestuff over the surface of the acid. If particles of different dyes (even though they may be of the same color originally) are present they will generally show different colors on contact with the acid, causing them to be easily detected. Prepare a green dyestuff by making an intimate mixture of one part Naphthol Yellow and three parts Wool Blue, and test the mixture so obtained by the two methods just given.

A further method of testing depends on the difference in the capillaryties of the two dyestuffs when in solution. A portion of the suspected dyestuff is dissolved in water and a single drop of the solution placed on a piece of filter (or blotting) paper. If the dyestuff is a mixture, two rings of color will generally be observed as the drop of solution spreads out over the paper. Test the green mixed dyestuff, as prepared above, in this manner, and observe the result. Sometimes this test may be rendered more distinct by using an alcoholic solution of the dyestuff. Make this test with a drop from an alcoholic solution of a mixture of Methyl Violet and Safranin.

3. To Determine the Class to which a Dyestuff Belongs.—It is often desirable to ascertain the chemical character of a sample of unknown dyestuff; that is to say, the classification of a coloring matter with reference to its dyeing properties. With reference to these properties, nearly all dyes may be broadly classified into four general groups, as follows:

(a) Acid dyes, including those that are dyed in an acid bath and which consist of the salts of color acids.

(b) Basic dyes, including those that are dyed in neutral or alkaline baths, and which consist of the salts of color bases.

(c) Substantive dyes, including those that dye both animal and vegetable fibers, and which consist principally of benzidine and allied derivatives.

(d) Mordant dyes, including those that do not dye either the animal or vegetable fibers directly, but which form color-lakes with various metallic oxides. These dyes consist mostly of anthracene derivatives and allied compounds of an phenolic nature. This classification, however, must not be taken as absolute and rigid, as one class may merge into another in almost an imperceptible manner, and there are dyestuffs which exhibit the characteristics of more than one; for instance, there are dyes which may be dyed in an acid bath, and would consequently be considered as acid dyes, but which also dye on metallic mordants, and hence would also be included among the mordant colors.

Again, basic dyes may also be dyed in baths more or less strongly acid; and substantive dyes may be dyed (on wool, for instance) from neutral, acid, or alkaline baths, or may even be dyed on mordants. So it may be seen that it is not such a simple matter, after all, to quickly decide as to

what class a dyestuff is to be referred. This problem can only be solved by a series of systematic tests, which should be carried out in the following manner:

A solution of the dyestuff should be made of a strength of about 5 grams per liter, using distilled water as the solvent. The solution is best made by first boiling the coloring matter with about 200 cc. of the water for ten to fifteen minutes, and then diluting the solution to 1 liter by the addition of cold water. The following dye-tests are then carried out with this solution:

(a) A test skein of scoured woolen yarn is mordanted by boiling for one-half hour in a bath containing 3 per cent of chrome and 4 per cent of tartar; washed well, and then dyed in a bath containing 1 per cent of the dyestuff. If a skein of woolen yarn becomes dyed, and especially if most

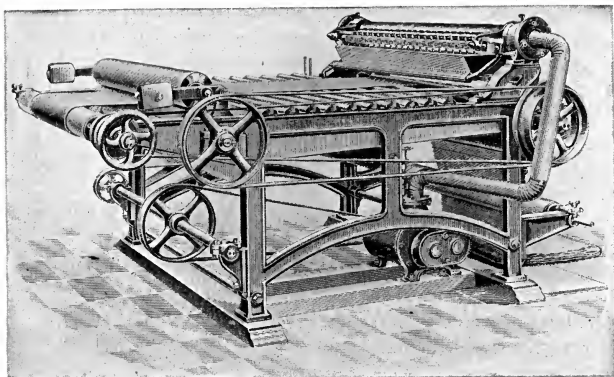

FIG. 295.—Spray Moistening Machine for Finishing Cottons and Linens.

of the color is extracted from the bath, the dyestuff in question may belong to the mordant-dyeing class, though the certainty of this can only be ascertained by the succeeding tests. If, however, the skein in this test does not become dyed, which is hardly likely, then it is positively known that the coloring matter under examination is not a mordant dye.

(b) A second test skein of woolen yarn is dyed in a bath containing 10 per cent of glaubersalt and 4 per cent of sulphuric acid, together with 1 per cent of the dyestuff; the material is boiled for one-half hour, then squeezed out and washed well. If the wool remains undyed in this case, but was dyed in a test (a), almost positive assurance is afforded that the coloring matter in question is a mordant dyestuff. If, however, the wool is dyed, the coloring matter may be either an acid dyestuff belonging to the

after-chromed variety, or it might also be a basic or a substantive dye. This must be determined by the subsequent tests.

If the result of these two tests leads to the indication of a mordant dyestuff, this may be confirmed by boiling a few cubic centimeters of the dye solution with separate solutions of chromium acetate and aluminium sulphate; if the dyestuff belongs to the mordant class, there will be a precipitate of a color-lake in each case. If there is no precipitate, this would indicate that any dyeing obtained on the mordanted wool in test (a) does not proceed from the presence of a mordant dye. If the skeins are dyed in both tests (a) and (b), and the dyestuff solution also causes the precipitation of a color-lake with the salts of chromium and aluminium, then it may reasonably be concluded that the coloring matter in question is a mordant dyestuff which also dyes wool from an acid bath. If no color-lake, however, is formed with the metallic salts, then the dyestuff is probably an acid color.

(c) A test skein of woolen yarn is dyed in a bath containing 1 per cent of the dyestuff and 10 per cent of Glaubersalt, being boiled for one-half hour then squeezed and washed well. If the wool remains undyed in this case, it indicates a mordant dye, as in the previous test (there are, however, certain substantive dyes which leave wool practically undyed under such conditions, and consequently, before judging definitely that the dyestuff belongs to the mordant class, the fact should be confirmed, as before described, by the precipitation of the metallic color). If the skein remains undyed in this test, but was dyed in test (b), the dyestuff is probably an after-treated mordant dye. If the skein is dyed in test (c), it may be either an acid, substantive, or basic dye. If the first, it would also have been dyed in test (b).

(d) A skein of cotton yarn is dyed in a bath containing 1 per cent of the dyestuff and 10 per cent of common salt; boil for one-half hour, then squeeze, and wash well in water, and then in a dilute lukewarm soap bath. If the cotton is not dyed, the dye may belong to either the mordant, the acid, or the basic class. If to the first, its nature would have already been indicated by the previous test. If to the second, it would also have dyed the wool in test (b), and probably in test (c). If to the third, the wool in test (c), and probably also in test (b), would have been dyed. If the cotton skein, however, in this test is well dyed and retains its color after soaping, it indicates that the dyestuff under examination belongs to the substantive class.

(e) A skein of cotton yarn is worked in a bath containing 4 per cent of tannic acid for one-half hour at 180° F., then squeezed and worked for ten minutes in a cold bath containing 2 per cent of tartar emetic, then squeezed and well washed. This mordanted cotton skein is then dyed in a bath containing 1 per cent of the dyestuff for one-half hour at 160° F.

after which it is squeezed and well washed. If the cotton becomes dyed in this test, and the dyebath is rapidly and rather completely exhausted, the dyestuff may be regarded as a basic dye, in which case the wool in test (c) would also be dyed, though with some basic dyes only slightly so, and the cotton in test (d) would remain practically undyed. If the cotton skein in this test remains undyed or is only slightly dyed, the dye may be either an acid or a mordant color, the distinction between which would have already been made in the previous tests.

4. Chemical Method of Distinguishing between Acid and Basic Dyestuff.—These two classes of dyes may be rather easily distinguished by certain chemical tests as follows:

(1) Basic dyes are not removed from an acidulated aqueous solution by agitation with ether, whereas acid dyes are taken up by the latter. Carry out the test as follows: Take a small quantity of Acid Violet (a portion the size of a grain of wheat is sufficient), and dissolve in about 5 cc. of dilute sulphuric acid; then add 5 cc. of ether and shake well. After settling, notice that the layer of ether has taken up the coloring matter, showing the presence of an acid dye. Repeat the test, using Methylene Blue, and notice that the ethereal layer is not colored. A sample containing a mixture of acid and basic dye (which, however, is hardly likely, as dyes of different classes are seldom mixed together) may be completely separated by this test, the acid dye being completely extracted by the ether.

(2) Caustic soda precipitates most basic dyes from their aqueous solutions (the safranin class excepted), whereas acid dyes are not so precipitated. Take about 5 cc. of an aqueous solution of Acid Violet in a test-tube, add about 5 cc. of caustic soda solution (1 : 10) and warm gently. Notice that the solution remains clear. Repeat the test, using a solution of Magenta, and notice that a precipitate is formed. Repeat the test again, using a dilute solution of Safranin, and notice that no precipitate is produced. (In the latter test, if a concentrated solution of Safranin is used, a precipitate will form.)

(3) Aqueous solutions of basic dyes are precipitated by addition of the so-called "tannin reagent," whereas acid dyes are not so precipitated. This is probably the best means of separating basic from acid dyes. The tannin reagent is prepared by dissolving 25 grams of tannic acid and 25 grams of sodium acetate in 250 cc. water. Add a few drops of this reagent to a dilute (1 per cent) solution of Acid Violet and warm gently; notice that no precipitate is formed. Repeat the test, using a dilute solution of Magenta; the latter will produce a precipitate.

Test several samples of unknown dyes in order to determine whether they belong to the acid or the basic class.

5. Detection of Adulterations in Dyestuffs.—Commercial dyestuffs are frequently adulterated with common salt (sodium chloride), Glaubersalt

(sodium sulphate), soda ash (sodium carbonate), dextrin, starch, sugar, and Epsom salts. The presence of such substances, however does not always indicate intentional adulteration; for in their manufacture many dyes are "salted out" from solution, or precipitated by strong brine solutions, and therefore would nearly always show the presence of varying amounts of common salt. Again in the manufacture of dyestuffs, it is desirable to prepare products of uniform strength, and as the different lots of manufactured dye seldom show exactly the same strength, a definite standard must be adopted to which weaker lots are brought up by the addition of a stronger dye while too strong a lot of dyestuff is diluted to the standard by the addition of suitable neutral salts. The occurrence of a large proportion of the above-mentioned salts in the dyestuff must, however, be taken as indicating intentional adulteration. For basic dyes sodium chloride and dextrin are chiefly used; for the acid dyes sodium sulphate is employed, and for the substantive dyes either sodium chloride or sulphate may be used. Dextrin in some cases is added to increase the solubility of the dyestuff.

(A) *Detection of Sodium Chloride*.—As silver nitrate forms an insoluble white precipitate of silver chloride when added to a solution of common salt, this reagent is used for the test. In many cases the test may be carried out by simply dissolving a small quantity of the dyestuff in water, adding a few drops of nitric acid (to prevent the precipitation of any other salt of silver besides the chloride), and then a few drops of a solution of silver nitrate, when the production of a white precipitate will indicate the presence of a chloride. This method, however, is not always reliable, as many dyestuffs are hydrochlorides of color-bases (basic dyes), or give insoluble salts of silver, in which cases the formation of a white precipitate would not necessarily indicate the presence of common salt. It is best to ignite a portion of the dyestuff in a porcelain crucible, so as to burn off all volatile and organic matter, leaving only mineral matter in the ash. Dissolve the ash in water, add a few drops of nitric acid and then the silver nitrate; a white precipitate of silver chloride will be formed if common salt is present. A few dyes, such as the Eosins, leave chlorides (or bromides or iodides) in the ash after ignition; hence this test would not be satisfactory. For such dyes, the aqueous solution of the coloring matter should be acidulated with dilute sulphuric acid, then shaken up with ether. The dyestuff will be dissolved out by the ether, leaving any common salt which may be present in the aqueous layer. The ether may be removed and tested with silver nitrate as described above. If the dyestuff is soluble in alcohol, the coloring matter may first be extracted by warming with this solvent, and the test for common salt may then be made with the residue.

(1) *Testing for Salt in Acid Yellow*.—Dissolve a small portion of the pure dyestuff in water, add a couple of drops of dilute nitric acid and a few

drops of silver nitrate solution; no precipitate will be produced. Repeat the test, using a sample of the dyestuff containing common salt, and notice the formation of a white precipitate of silver chloride (which will be more or less colored by the dyestuff).

(2) *Testing for Salt in Magenta.*—Dissolve a small quantity of the pure dye in water, and test with silver nitrate as above. As the dye itself is the hydrochloride of the color-base, a precipitate of silver chloride will be formed, though no common salt is present. Place a small quantity of the dyestuff in a porcelain crucible, and ignite until all organic matter is completely burned away; dissolve the ash in a small quantity of water acidu-

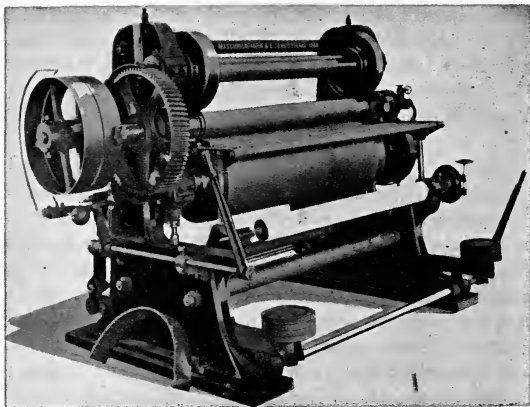

FIG. 296.—Gaufring and Embossing Machine.

lated with a few drops of nitric acid, and test with silver nitrate; no precipitate will be produced. Repeat this test, using a sample of Magenta containing common salt and note the formation of a precipitate of silver chloride.

(3) *Testing for Salt in Eosin.*—Place a small quantity of pure Eosin in a porcelain crucible and ignite as above described; on dissolving the ash in water and testing with silver nitrate in the usual manner, a precipitate will be formed though no common salt is present. Next take a small quantity of the Eosin, dissolve in 10 cc. of water in a test-tube (or better, a stoppered separatory funnel), add 5 cc. of ether (be sure the solution is cold before adding the ether), shake well and allow to stand. The ethereal layer, containing the dyestuff in solution will collect on top, while the aqueous layer will remain at the bottom. If the color is not well extracted

from the bottom layer pour off the ethereal layer and repeat the extraction with fresh ether. Withdraw the aqueous layer by means of a pipette, and test it with silver nitrate as usual; no precipitate will be produced. Repeat this test, using a sample of Eosin containing common salt, and notice that a precipitate of silver chloride will be formed.

(4) *Testing for Salt in Orange II.*—Place a small sample of the pure dye in a test-tube and dissolve in 10 cc. of warm alcohol; it should be completely soluble. Repeat this test, using a sample of the dye containing common salt; notice that a residue is left. Dissolve this in water and test with silver nitrate as usual; a precipitate of silver chloride will be produced.

(B) *Detection of Sodium Sulphate.*—Sulphates in general are detected by the addition of barium chloride to their solution, whereby an insoluble white precipitate of barium sulphate is formed. The presence of sulphates in the ash of a dyestuff does not necessarily indicate adulteration with glaubersalt, as many dyes are themselves sulphonated compounds, and on ignition leave sodium sulphate in the ash. The best procedure for testing for glaubersalt in a dyestuff is as follows: Dissolve some pure Benzopurpurine in a small amount of water, add a few drops of dilute hydrochloric acid (to prevent other compounds of barium being precipitated), then a solution of barium chloride as long as a precipitate forms. This precipitate, which consists of barium sulphonate, is filtered off, washed, and boiled with a solution of ammonium carbonate. This converts it into barium carbonate; filter again, and wash the residue of barium carbonate, and then add dilute hydrochloric acid to the latter, when it should be completely dissolved. Repeat the test, using a sample of Benzopurpurine containing glaubersalt. The precipitate obtained with barium chloride, in this case, consists of a mixture of barium sulphonate and barium sulphate. On boiling this with ammonium carbonate, only the sulphonate is converted into barium carbonate, and on finally dissolving in hydrochloric acid, the barium sulphate will be left as an insoluble residue, thus showing the presence of glaubersalt in the original dye. Another method for testing for sulphates is to precipitate the dyestuff from its aqueous solution by the addition of pure common salt to complete saturation. The precipitated dyestuff with excess of salt is filtered off, the filtrate acidulated with a few drops of hydrochloric acid and tested with barium chloride solution. The formation of a white precipitate will indicate the presence of glaubersalt in the original dyestuff. This method, however, is not very satisfactory, as it is usually difficult to precipitate the dyestuff completely from its solution. Another method of testing for sulphates is to dissolve the dyestuff in strong warm alcohol (where this is possible), and as glaubersalt is insoluble in alcohol it will be left as a white residue (as in the case of common salt). This is to be dissolved in water and tested with barium chloride in the usual manner.

(C) *Detection of Soda Ash.*—This substance is frequently added to Eosins, and sometimes to substantive dyes. It is detected by dissolving a sample of the dye in water, and adding hydrochloric acid to the solution when an effervescence will be produced due to the liberation of carbon dioxide gas from the carbonate present. For example: Dissolve some pure Eosin in a little water and add a few drops of dilute hydrochloric acid; no effervescence will occur. Repeat the test, using a sample of Eosin containing sodium carbonate; a vigorous effervescence will be noted.

(D) *Detection of Epsom Salts.*—This consists of magnesium sulphate, and is occasionally added as an adulterant to dyes. The presence of the sulphate is detected in the manner described under the test for sodium sulphate. The presence of the magnesium is shown in the following manner: Place a portion of Methyl Violet containing magnesium sulphate in a porcelain crucible; ignite until all carbon and volatile matter is burned away. Dissolve the ash in hot dilute hydrochloric acid, and filter, if necessary. Neutralize the filtrate with ammonia water and add a solution of sodium phosphate. After standing for a short time a crystalline precipitate (of magnesium ammonium phosphate) is formed, showing the presence of a magnesium salt in the original dyestuff.

(E) *Detection of Dextrin.*—This impurity can usually be recognized by the peculiar odor dextrin gives on dissolving the dye in warm water. It may best be tested for as follows: Take a small sample of Methyl Violet containing dextrin; extract the coloring matter with absolute alcohol; the dextrin will be left as a residue. Dissolve the latter in a small quantity of warm water and notice the peculiar odor of the dissolving dextrin. Dextrin is frequently added to paste dyes and to basic dyes.

(F) *Detection of Starch.*—This impurity may be separated from the dyestuff by treating with cold water, in which the starch is insoluble. It may then be recognized as follows: Take a sample of Eosin containing starch; extract the coloring matter with cold water; dissolve the residue of starch in a little boiling water, and add a few drops of a solution of iodine in potassium iodide. A deep blue color will be produced, indicating the presence of starch.

(G) *Detection of Sugar.*—This impurity is frequently added to crystalline dyes, as it occurs in the crystalline form itself. Its presence may be shown as follows: Take a sample of Magenta containing sugar; extract with absolute alcohol. The dyestuff passes into solution, whereas the sugar remains practically insoluble, and becomes nearly colorless. Heat the residue in a test-tube and notice the odor of caramel, indicating the presence of sugar.

6. Determination of the Capillary Speed of Dyestuffs.—By the capillary speed of a dyestuff is meant the height to which its solution will rise in a given time through porous paper (filter or blotting paper). This factor

is only a relative number, and is usually compared with pure water as a standard.

Take five strips of blotting paper measuring 5 ins. in length and $\frac{1}{2}$ in. in width; make a mark on each strip 1 in. from the end. Immerse one of these strips in a small beaker containing pure water so that the surface of the water comes exactly to the 1-in. mark on the paper. Sustain the strip in a perpendicular position, and allow it to remain in the water for just one minute. Then measure the height to which the water has risen on the paper. Repeat the test with a fresh strip of paper, using a 1 per cent solution of Magenta, and after one minute measure the height to which the color has ascended. Repeat the test further on 1 per cent solutions of Naphthol Yellow, Acid Violet, and Malachite Green. Tabulate the results obtained as follows:

Solution.	Distance Color Rises.	Compared with Water as = 100.
Water.....		100
Magenta.....		
Naphthol Yellow S.....		
Acid Violet.....		
Malachite Green.....		

CHAPTER XXX

MISCELLANEOUS TESTS IN DYEING

1. The Amount of Dyestuff Necessary for a Full Shade.—This factor may be determined by dyeing test skeins with increasing amounts of dyestuff until no further increase in shade is observed. Proceed as follows: Use six test skeins of woolen yarn (No. 1 to No. 6) of the same weight, dye them respectively with the following amounts of Acid Violet, employing the usual acid bath and method of dyeing:

- No. 1, with 1 per cent of dyestuff
- No. 2, with 2 per cent of dyestuff
- No. 3, with 3 per cent of dyestuff
- No. 4, with 4 per cent of dyestuff
- No. 5, with 5 per cent of dyestuff
- No. 6, with 6 per cent of dyestuff

After dyeing the samples are compared, and note is taken at which point the shade ceases to show a perceptible increase. The same method may be employed in other classes of dyes, using their respective methods of dyeing.

2. To Determine the Degree of Exhaustion of the Dyebath.—By the *exhaustion* of the dyebath is meant the relative quantity of color absorbed by the fiber during the dyeing process. Proceed as follows: Dye a test skein of woolen yarn with 3 per cent of Acid Violet, 4 per cent of sulphuric acid, 20 per cent of Glaubersalt, making the dyebath up to exactly 300 cc. and taking out 25 cc. of the solution before dyeing to preserve for comparison in a test-tube. Carry out the dyeing operation in the usual manner; squeeze the excess of liquor from the skein back into the dyebath so as not to lose any of the solution. Make up the bath again to exactly 275 cc.; fill a graduated colorimetric tube with this solution; take 1 cc. of the original dyebath in another similar colorimetric tube, and dilute the latter with water until it exhibits the same intensity of color as the first tube. The degree of dilution required measures the degree of exhaustion of the dyebath. For example: 1 cc. of the original solution required to be diluted to 8.5 cc. to show the same intensity of color as the exhausted bath; hence the relative amount of dye left in the bath is $1 \div 8.5 = 0.12$, and the amount

absorbed must have been 0.88 or 88 per cent. Therefore the degree of exhaustion in this case would be 88 per cent.

Pour the liquor taken from the exhausted bath back into the dye-bath, and without further addition of dyestuff or chemicals, dye another test skein of woolen yarn. After dyeing dry a portion and compare it with the first skein. The difference in intensity of the two dyeings will represent in a rough manner the degree of exhaustion. Now continue the dyeing of the second skein by adding to the bath sufficient dyestuff to bring the shade up to that of the first skein. Besides the dyestuff also add 2 per cent more of sulphuric acid, as some of the acid originally added will have been removed by the first dyeing. Note the amount of dyestuff added, and this will represent the amount originally absorbed from the first bath. For example: it required the further addition of 2.5 per cent of Acid Violet to match the second dyeing to the first; hence, the degree of exhaustion would be $2.5 \div 3 \times 100 = 83.3$ per cent, which is a rather close approximation to the result obtained by the first method. The first method is the more accurate, but in some cases the bath after dyeing has a different color from that of starting, and, again, some dyes (mordant colors) give solutions which do not accurately represent the color obtained by dyeing; in which cases the latter method only could be used.

3. To Determine the Correct Amount of Mordant to Use.—Mordant six test skeins of woolen yarn each with 4 per cent of tartar and the following amounts of chrome:

- | | |
|----------------|-----------------|
| (1) 1 per cent | (4) 5 per cent |
| (2) 2 per cent | (5) 8 per cent |
| (3) 3 per cent | (6) 12 per cent |

Enter at 140° F., raise to boiling, and mordant for forty-five minutes; wash, and dye the skeins all together with 3 per cent of Alizarine Red in the usual manner. Rinse and dry. Compare the several skeins, and by selecting the best color thus determine which percentage of chrome is the proper one to use. For nearly all purposes of mordanting it has been found that about 3 per cent of chrome gives the best results. A larger amount of chrome appears to oxidize the wool and causes bad shades in dyeing; this is known as over-chroming and the wool becomes harsh and brittle.

4. To Determine the Degree of Exhaustion of the Mordant Bath.—Mordant a test skein of woolen yarn in a bath containing 300 cc. of water, 3 per cent of chrome, 4 per cent of tartar. Enter at 140° F., raise to boiling, and mordant for forty-five minutes. Squeeze back the liquor from the skein into the bath and wash well. Add sufficient water to the mordant bath to bring its volume up to 300 cc. again, and without further additions, mordant a second skein in a similar manner. Repeat in the same way with

a third skein. Then dye the three skeins together with 3 per cent Alizarine Red in the usual manner, and finally compare the skeins for depth of shade in order to determine the relative exhaustion of the mordant bath.

Repeat this test, using a mordanting bath of 300 cc. of water, 3 per cent of chrome, 2 per cent of lactic acid, 2 per cent of sulphuric acid. Mordant three test skeins successively in the manner above described and dye again with 3 per cent of Alizarine Red. Compare these for depth of shade to determine the relative exhaustion of the bath and also to determine if the exhaustion is the same in the second case as in the first.

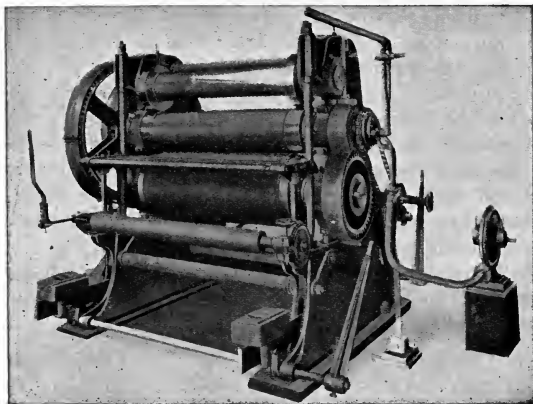

FIG. 297.—Calender for Giving Silk Finish on Cotton Cloth.

5. To Show the Dichroic Property of a Dyestuff.—Coloring matters are known as “dichroic” when they change their tone with change of intensity. Magenta, for instance, in heavy shades is a red color, while in light tints it changes to a bluish pink. To show this property proceed as follows: Dye six skeins of woolen yarn with Magenta, using 10 per cent of Glaubersalt in each dyebath together with the following amounts of dyestuff:

- | | |
|----------------|-------------------|
| (1) 3 per cent | (4) 0.5 per cent |
| (2) 2 per cent | (5) 0.1 per cent |
| (3) 1 per cent | (6) 0.01 per cent |

Enter at 100° F., raise to 180° F., and dye for thirty minutes. Observe the different tones in the colors obtained with change of concentration.

The dichroic nature of a coloring matter may also be observed with its solution. Take a small quantity of Magenta and dissolve in 5 cc. of water

in a test-tube; pour out half of this solution into a second test-tube and dilute with an equal quantity of water. Pour out half of the second solution into a third test-tube, and dilute again with four times the amount of water. Compare the colors of the three solutions, and notice the effect of dilution on the tone of the original color. In the same manner test the dichroic properties of Eosin, Methyl Violet, and Malachite Green.

6. Effect of Dichroism in the Compounding of Shades.—Dye a test skein of woolen yarn with 3 per cent of Auramine, and another with 3 per cent of Magenta. Then dye two more skeins, the one with $\frac{1}{10}$ per cent of Auramine and the other with $\frac{1}{10}$ per cent of Magenta. Notice that the Auramine is not especially dichroic, whereas the Magenta is markedly so. Now dye a skein with a mixture of 2 per cent of Auramine and 3 per cent of Magenta, and another skein with 2 per cent of Auramine and 1 per cent of Magenta, and a third skein with 2 per cent of Auramine and $\frac{1}{10}$ per cent of Magenta. Notice the wide difference in the character of the colors obtained; for while the Magenta in the first case (3 per cent) exercises the function of a red dye, in the last case ($\frac{1}{10}$ per cent) it acts as a violet dyestuff; hence the effect is entirely different in kind. Next dye a skein with $\frac{1}{10}$ per cent of Auramine and $\frac{1}{10}$ per cent of Magenta, and another skein with 2 per cent of Auramine and 2 per cent of Magenta. Theoretically, the first color should be a reduced tint of the second; but practically it will be seen that the two colors are of entirely different orders. This is caused by the wide variation in the color of the Magenta with different concentrations. From this it will be seen that the dichroic property of a dyestuff has an important bearing on its mixing qualities with other dyes in the compounding of shades. A red and a blue dye when used together in heavy shades may give a very satisfactory violet; but if the attempt is made to obtain a reduced tint of this violet by using small percentages of the two colors in the same proportions, it will perhaps be found that a tint of an entirely different color is obtained. The same is true when dealing with green and orange colors. In order to become acquainted with the true mixing qualities of his dyestuffs, the dyer should be familiar with the colors they give with large, medium, and small percentages, and in the mixing of his shades he must make due allowance for the change in tone of color of the dyes with varying concentration.

CHAPTER XXXI

CHEMICAL REACTIONS OF DYESTUFFS

1. Identification of Dyes.—In order to identify any particular dyestuff it is necessary to test it with various chemical reagents, whereby a series of chemical reactions is obtained, usually based on color changes. Tabulated reactions have been prepared of the various dyestuffs, and by reference to these it is usually possible to identify any individual coloring matter. Difficulty, however, will be experienced with coloring matters containing mixtures of two or more dyestuffs, as the reaction of one of the dyes in the mixture may obscure the reaction of the other dye. In the case of many mixtures it is practically impossible to determine accurately the exact dyestuffs present unless some method is available for the separation of the dyes.

Considerable evidence as to the identity of a dyestuff is furnished by its dyeing properties toward cotton and wool. In this manner it will be possible to determine if the dyestuff in question is acid or basic, etc., and this method of classification will eliminate many uncertain possibilities.

In the following experiments, to illustrate the results of the reactions given, the dyestuff Auramine is taken as an example.

2. Solubility Tests.—(a) *With Water.*—Take about 0.1 gram of the dyestuff and add to 20 cc. of distilled water in a test-tube; shake well, and then boil; observe the relative solubility. Auramine is **very soluble**. (b) *With Alcohol.*—Repeat the test, using alcohol in place of water; note the relative solubility and the color of the solution. Auramine is **very soluble** with a yellow color. (c) *With Ether.*—Repeat the test, using ether; Auramine is **insoluble**. (d) *With Benzene.*—Repeat the test, using benzene; Auramine is **insoluble**.

3. Reaction with Sulphuric Acid.—(a) *With Concentrated Acid.*—A small quantity (on the tip of a penknife blade) of the dyestuff is added to about 5 cc. of pure concentrated sulphuric acid in a test-tube; shake well and note the color of the solution obtained. Auramine dissolves with **effervescence** (due to evolution of hydrochloric acid gas), and gives a **colorless solution**. (b) *Dilution with Water.*—Add a drop or two of the strong acid solution as obtained above to about 10 cc. of water in a test-tube, and note the reaction which occurs. Auramine on dilution gives a

yellow color. (c) *On Heating.*—The remainder of the strong acid solution is gradually heated to the boiling point. Auramine furnishes a **pale brownish yellow** solution.

4. Reaction with Hydrochloric Acid.—Use an aqueous solution of the dyestuff containing 1 gram of dye per liter. To 5 cc. of this solution add 5 cc. of a solution of hydrochloric acid (containing 100 cc. of the strong acid per liter); allow to stand for ten minutes, and note what reaction, if any, occurs. Auramine remains **unchanged**. Now heat the solution to boiling and note any change that occurs; Auramine becomes **decolorized**.

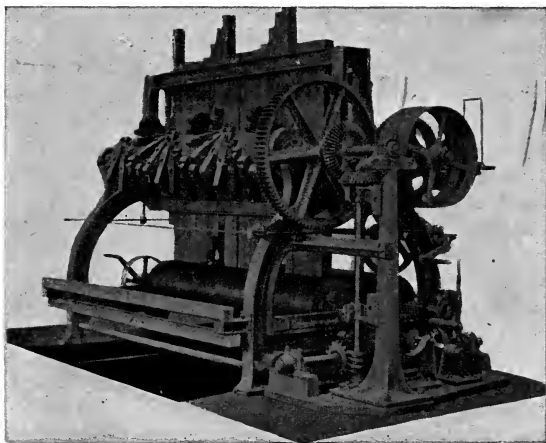

FIG. 298.—Beetling Machine for Heavy Linens and Cottons.

5. Reaction with Nitric Acid.—To 5 cc. of the aqueous solution of the dyestuff add 5 cc. of a solution of nitric acid (containing 50 cc. of the strong acid per liter), and carry out the test as above. Auramine remains **unchanged** cold; boiling it gives a **pale yellow** solution.

6. Reaction with Sodium Hydrate.—Carry out the test as above described, using 5 cc. of a solution of sodium hydrate (containing 100 cc. of sodium hydrate of sp. gr. 1.3 to 1 liter). If a precipitate is formed, add about 2 cc. of ether, and shake; observe if the ether extracts the precipitated color from the caustic soda; then add a drop or two of acetic acid to the ethereal layer, and note any change. Auramine gives a **white precipitate**, extracted with ether, **becoming yellowish** on addition of acetic acid.

7. Reaction with Ammonia.—Repeat the test as above given, using 5 cc. of commercial ammonia water. Auramine undergoes the same reactions as with sodium hydrate.

8. Reaction with Sodium Carbonate.—Repeat the test as given above, using 5 cc. of a solution of sodium carbonate (100 grams per liter). If a precipitate is formed with the cold solution, heat to boiling and observe if this causes the precipitate to redissolve. Auramine gives a **milky yellow precipitate** which remains **insoluble on heating**.

9. Reaction with Tannin Reagent.—Carry out the test, using 5 cc. of a solution containing 100 grams of tannic acid dissolved in 500 cc. of water and mixed with a solution of 100 grams of sodium acetate in 500 cc. of water. If a precipitate is formed heat to boiling and note any change in its character. Auramine gives a **yellow precipitate**, which, on boiling, becomes **brown, resinous, and partially soluble**. This reagent is useful for distinguishing between acid and basic dyes, as the latter alone give a precipitate.

10. Reaction with Alum.—Add to the aqueous solution of the dyestuff 5 cc. of a solution of alum (containing 50 grams per liter). If a precipitate is formed, heat to boiling, and note any change that may occur. Auramine remains **unchanged** with the alum solution. Many of the acid dyes and nearly all of the mordant dyes give characteristic precipitates with alum.

11. Reaction with Potassium Bichromate.—Add to the aqueous solution of the dyestuff 5 cc. of a solution containing 50 grams of potassium bichromate per liter. If a precipitate is formed, heat to boiling, and note any change that may occur. Auramine gives a **yellow precipitate**, which on heating becomes **resinous** and for the most part **dissolves**. The majority of the basic dyes are precipitated by this reagent, as is also the case with most of the mordant dyes; only a few of the acid dyes are thus precipitated.

12. Reaction with Ferric Chloride.—Add to the aqueous solution of the dyestuff 5 cc. of a solution containing 100 grams of ferric chloride per liter; note the reaction and then heat to boiling and observe any further change. Auramine remains **unchanged** in the cold solution; on heating the solution becomes **turbid** and of a **brownish yellow color**.

13. Reaction with Stannous Chloride.—Add to the aqueous solution of the dyestuff 5 cc. of a solution containing 100 grams of stannous chloride per liter (with sufficient hydrochloric acid to yield a clear solution). After standing ten minutes, heat to boiling, and note the reactions which occur. Auramine remains **unchanged**. A large number of dyestuffs either give characteristic precipitates, or become decolorized.

14. Reaction with Bleaching Powder.—Add to the aqueous solution of the dyestuff 5 cc. of a solution of bleaching powder of 1.5° Tw. strength. After standing for ten minutes, heat to boiling, and note any changes which occur. Auramine gives a **dirty, pale yellow precipitate**, which, on heating turns to a **dirty red color**.

15. Reaction with Zinc Dust.—Add to the aqueous solution of the dye-stuff about 1 gram of zinc dust and 5 cc. of ammonia water; shake well and then heat to boiling; filter at once, and note if the filtrate if decolorized becomes colored again on exposure to the air. Auramine gives a **colorless** filtrate, and the color does **not reappear** on exposure to the air; but the precipitate left on the filter gradually becomes yellowish on standing. The solutions of nearly all dyes are decolorized by this reagent, and many dyes give a characteristic reappearance of color on exposure to the air. The loss of color is caused by the reduction of the coloring matter, which may be converted either into a leuco (colorless) derivative (which allows of the

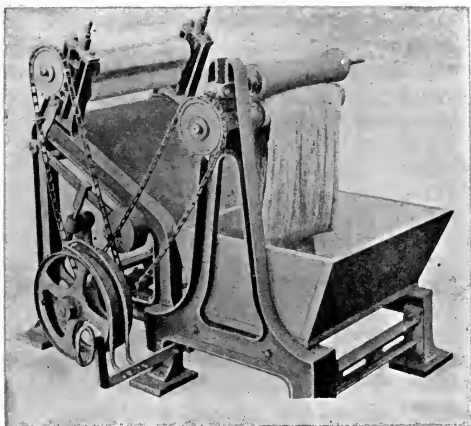

FIG. 299.—Sizing Machine for Skein Yarn.

original dyestuff being again formed on oxidation in the air), or be entirely destroyed. In the latter case no reappearance of color will be shown on oxidation.

16. Reaction with Zinc Dust and Acetic Acid.—Repeat the above test as given, using, however, 5 cc. of acetic acid in place of the ammonia. Auramine becomes **blue** on acid reduction. Many dyestuffs give characteristic colors with this test, while some are decolorized completely. In many cases the original colors reappear on exposure.

Test the following dyestuffs in the same manner as outlined for Auramine:

Magenta
Acid Violet 4R

Benzopurpurine
Alkali Blue

Naphthol Yellow S
Alizarine Brown SO

TABULATION OF RESULTS WITH CHEMICAL REAGENTS.

Test.		1. Auramine.	2. Acid Violet 4R.	3. Alkali Blue R.
Solubility in	Water.	Very sol.	Quite sol.	Quite sol.
	Alcohol.	Very sol.	Quite sol.	Quite sol.
	Ether.	Insoluble.	Insoluble.	Slightly soluble.
	Benzene.	Insoluble.	Insoluble.	Insoluble.
Concentrated sulphuric acid.	Solution.	Colorless.	Dark brown.	Red brown.
	Dilution.	Yellow.	Violet.	Blue ppt.
	Heating.	Brown-yellow.	Dark yellow-brown.	Dark brown.
Dilute hydrochloric acid.	Cold.	No change.	No change.	Blue ppt.
	Heating.	Decolorized.	No change.	Blue ppt.
Dilute nitric acid.	Cold.	No change.	No change.	Blue ppt.
	Heating.	Pale yellow.	No change.	Turns green.
Sodium hydrate.	Cold.	White ppt.	Colorless.	No change.
	Extraction with ether.	Color extracted.
Ammonia.	Cold.	As above.	Colorless.
Sodium carbonate.	Cold.	Yellow milky ppt.
	Heating.	No change.
Tannin reagent	Cold.	Yellow ppt.	No change.	No change.
	Heating.	Brown, resinous; partly sol.	No change.
Alum.	Cold.	No change.	Darker.	Blue ppt.
	Heating.	No change.	Same.	Blue ppt.
Potassium bichromate.	Cold.	Yellow ppt.	No change.	No change.
	Heating.	Resinous; mostly dissolved.	No change.
Ferric chloride	Cold.	No change.
	Heating.	Brown-yellow.
Stannous chloride.	Cold.	No change.	No change.
	Heating.	No change.	No change.	Blue ppt.
Calcium hypochlorite.	Cold.	Dirty yellow ppt.
	Heating.	Dirty red color.
Zinc dust and ammonia.	Cold.	Colorless.	Colorless.	Colorless.
	Exposed.	Colorless.	Same.	Blue.
	Precipitate.	Yellowish.
Zinc dust and acetic acid.	Cold.	Blue.	Bluish pink.	Colorless.
	Exposed.	No change.	Same.	Blue.
	Precipitate.

CHAPTER XXXII

ANALYSIS OF TEXTILE FABRICS

1. To Determine the Amount of Wool and Cotton in a Fabric.—A weighed portion of the air-dry sample is boiled for ten minutes in a 5 per cent solution of caustic potash, then washed well first with fresh water and afterwards with water slightly acidulated with acetic acid to remove all trace of alkali.* The residue is air-dried and weighed. As the wool is dissolved by the alkali, the loss in weight corresponds to the amount of wool, while the residue represents the cotton. Record the results as in the following example:

Weight of sample.....	5.25 grams
After boiling in caustic potash.....	1.06 grams
Loss equals wool.....	4.19 grams
Residue equals cotton.....	1.06 grams

Hence:

Wool = 79.8 per cent
Cotton = 20.2 per cent

As the cotton present will suffer a slight loss in the process, it is customary to add 5 per cent of its weight to the cotton, and to subtract this amount from that of the wool. With this correction the above figures become:

Wool = 78.79 per cent
Cotton = 21.21 per cent

2. Analysis of Fabric Containing Silk and Cotton.—(a) *Nickel Hydrate Method.* A weighed portion of the fabric (about 5 grams) is steeped for five minutes in a cold solution of nickel hydrate in ammonia; then heated almost to boiling for five minutes. This treatment should dissolve the silk completely. The residue of cotton is thoroughly washed, dried, and weighed. The nickel hydrate solution for this test is prepared as follows: 25 grams of crystallized nickel sulphate are dissolved in 500 cc. of water, then sufficient caustic soda solution is added to precipitate completely

* Another method for the estimation of wool in a union fabric is to determine the amount of nitrogen present by the Kjeldahl method. The average amount of nitrogen in the wool is taken as 14 per cent. Before determining the nitrogen, the material, of course, must first be freed from grease and finishing materials.

the nickel as hydrate. This precipitate is well washed with water by settling and decantation, and finally rinsed into a 250-cc. flask with 125 cc. of water. The flask is next filled with ammonia water and well shaken, and the nickel hydrate should finally completely dissolve.

(b) *Zinc Chloride Method.*—A weighed portion of the sample is boiled for two minutes in a solution of basic zinc chloride of 1.72 sp. gr. The residue of cotton is thoroughly washed first with dilute hydrochloric acid, and then with water, and then dried and weighed. This treatment dissolves the silk without materially affecting the cotton. The basic zinc chloride solution is prepared as follows: 100 grams of zinc chloride and 4 grams of zinc oxide are dissolved in 85 cc. of hot water; after complete solution the liquid should have a density of 1.72. This method of analysis is well adapted for plushes and other heavy silk fabrics.

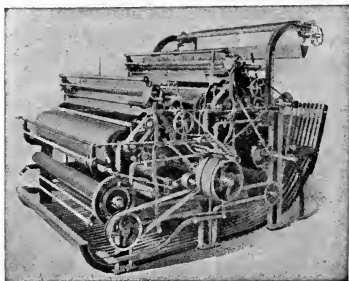

FIG. 300.—New Style Double-cutter Woolen Shear with Plain or List Saving Rests. (Curtis & Marble.)

3. Analysis of Fabric Containing Wool and Silk.—A weighed portion of the sample is steeped for two minutes in concentrated hydrochloric acid at 120° F. This will dissolve the silk without materially affecting the wool. Wash the residue of wool, dry, and reweigh.

4. Analysis of Fabric Containing Wool, Silk, and Cotton.—A weighed portion of the sample is treated for ten minutes with a cold solution of nickel hydrate in ammonia (see above). This will dissolve any silk present. Wash well, dry, and reweigh. The loss in weight represents *silk*. The residue is next boiled for ten minutes in a 5 per cent solution of caustic potash. This will dissolve any wool present. Wash well, dry, and reweigh. The loss in weight represents *wool*, while the residue consists of *cotton* (see above for correction to apply to weight of cotton).

5. Distinction between True Silk and Artificial Silk.—Artificial silk (or *lustra-cellulose*) is a fiber prepared from a solution of collodion or other

cellulose solution. It consists of cellulose, whereas true silk is a nitrogenous animal substance. Artificial silk burns readily in the air like cotton, without evolving a strong odor; while silk burns slowly, and emits a characteristic odor. To estimate the amount of artificial silk present in a mixed fabric, a weighed portion of the sample is treated at the ordinary temperature for twenty minutes with an alkaline solution of copper sulphate. This will completely dissolve the natural silk, leaving the artificial fiber as a residue. The latter is thoroughly washed, dried and reweighed. The alkaline solution of copper sulphate is prepared by dissolving 10 grams of copper sulphate in 100 cc. of water and 5 cc. of glycerin; a strong solution of caustic soda is then added until the precipitate at first formed just redissolves.

6. To Distinguish between Cotton and Linen.—(a) Steep the sample containing these two fibers for two minutes in concentrated sulphuric acid; wash well with water, gently rub with the fingers, and finally steep in dilute ammonia; then squeeze and dry. The cotton fibers will be converted into a jelly-like mass by the action of the acid, and is more or less completely removed by the rubbing and washing. The linen remains but little altered. By weighing the sample before and after the treatment an approximate idea of the amounts of cotton and linen present may be obtained. (b) Steep the sample to be tested in olive oil; then press between filter paper to remove the excess of oil. The linen fibers will become gelatinous in appearance and translucent, whereas the cotton remains unaltered. When placed on a dark background the linen fibers will now appear dark and the cotton fibers light. (c) Steep the sample to be tested in an alcoholic solution of rosolic acid, and then in a strong solution of caustic soda; finally rinse in water. The linen fibers will become rose-colored while the cotton is colored much lighter and most of the color is removed by the rinsing. None of these tests is very satisfactory when the linen has been bleached for then its cellulose is practically identical with that of cotton. The most satisfactory means of qualitatively distinguishing linen from cotton is by a microscopic examination, as these fibers exhibit very different microscopic properties (see the author's *Textile Fibers*).

7. To Distinguish between True Silk and Tussah Silk.—Tussah silk (and the wild silks in general) may be distinguished from true silk by the following reactions:

(a) Tussah silk is only partially dissolved by cold concentrated hydrochloric acid (sp. gr. 1.16), even on standing for forty-eight hours; whereas true silk dissolves almost instantly.

(b) Tussah silk requires a comparatively long time to dissolve in the solution of basic zinc chloride, mentioned on page 688, whereas true silk dissolves quite readily.

(c) True silk dissolves completely in a semi-saturated solution of

chromic acid when boiled for one minute; whereas tussah silk remains unaltered after boiling for two to three minutes in this solution.

(d) To estimate the amount of tussah silk in a fabric, weigh off a portion of the sample and steep for ten minutes in cold concentrated hydrochloric acid; wash the residue thoroughly, dry, and reweigh. The loss in weight represents the true silk while the residue consists of tussah silk.

8. To Test if Cotton Has Been Mercerized.—By the use of Lange's iodine and zinc chloride test it is possible to tell if cotton has been mercerized or not. The test is carried out as follows: two solutions are prepared (1) 5 grams of potassium iodide, 20 cc. of water and 2 grams of iodine; (2) 25 grams of zinc chloride and 12 cc. of water. Take a piece of mercerized cotton cloth or yarn and also a piece of unmercerized for comparison; scour with soap in order to remove any finishing materials, then wash.

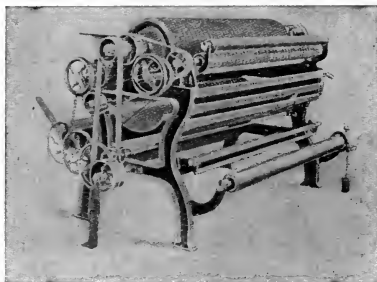

FIG. 301.—Knitgoods Napper for Eiderdowns, Fleeings, Robes, etc. (Curtis & Marble.)

Solution (2) is stirred into solution (1) until iodine begins to separate; allow to settle and decant the dark clear brown solution. Steep the two samples of cotton in this liquid for three minutes, and then wash. The unmercerized cotton will very quickly lose its color, while the mercerized cotton will remain blue for some time. The test may even be used with cotton dyed in pale or medium shades; cotton that is dyed in dark shades should first be bleached. (See H. Lange, *Färber-Zeit.*, 1903, page 365.)

9. To Test if Silk Has Been Weighted with Tin Salts.—A simple test for this purpose is to boil a sample of the silk with a dilute solution of Alizarine Orange paste; if the silk is tin weighted the fiber will become colored a bright orange, whereas unweighted silk will only be stained a dull bluish pink. Another test is to boil the silk sample with a dilute solution of Logwood extract and acetic acid. If the silk is tin weighted the fiber will become dyed a violet color, whereas unweighted silk will be stained red. Of course these tests can only be applied to white or light-

colored silks where the original color of the fiber will not overcome the color obtained in the test.

10. Estimation of Sizing and Dressing Materials in a Fabric.—These materials include *sizing*, such as **starch, clay**, etc., used for stiffening a warp or fabric; *finishing materials*, such as **glue, magnesium chloride**, etc., which may be added to give a certain finish to the cloth; **mordants** and **dyestuffs**, as well as **grease**, etc., which may be present in the fabric. A weighed sample of the fabric is boiled for fifteen minutes in a 3 per cent solution of hydrochloric acid; wash well, and boil for ten minutes in a 1 per cent solution of soda ash; wash well again, and dry. Reweigh, and the loss will represent the amount of size and dressing materials.

11. Conditioning of Textile Materials.—By “conditioning” is meant the estimation of the amount of moisture present in a yarn or fabric and the subsequent calculation of the amount of normally dry fiber present in the sample. The test is usually carried out by means of a specially constructed conditioning oven wherein the weighed sample is heated at about 220° F. until the moisture is completely driven out. The residue consists of “bone-dry” fiber, and the loss is moisture. To the weight of the dry residue is then added the amount of moisture corresponding to that normally present in the fiber under examination. This amount is termed the “regain,” and though the standard varies in different localities, for America it may be taken as follows:

For materials of wool.....	18 per cent
For materials of cotton.....	8½ per cent
For silk.....	11 per cent

Where a special conditioning oven is not available the moisture test may be made on a small sample contained in a weighing bottle by heating in an ordinary drying oven. The test is much more accurate, however, when a relatively large amount of material is used.

Place 100 grams of woolen yarn in the conditioning oven and heat at 220° F. until no further loss in weight occurs. This will usually require three to four hours. Note the loss in weight. For example, suppose this loss to be 19.6 grams; then

Original weight.....	100.	grams
Loss as moisture.....	19.6	grams
<hr/>		
Residue as bone-dry fiber.....	80.4	grams
Add regain, 18 per cent of this.....	14.47	grams
<hr/>		
Normal weight.....	94.87	grams

Hence the sample contained 94.87 per cent of “conditioned” or normal wool.

Repeat the test, using samples of loose wool, worsted tops, raw cotton, cotton yarn, raw silk, etc., and calculate the amounts of conditioned fiber in each case.

12. Estimation of Oil and Grease in Fabrics.—For analytical purposes, these substances are best extracted by means of petroleum ether (ligroin) in a Soxhlet extraction apparatus. A weighed quantity (about 1 gram) of the fabric to be tested is placed in the capsule of the extractor; pour 60 cc. of petroleum ether in the tared flask of the apparatus. Connect the extractor with its condenser and heat on a water-bath, regulating the temperature so that the solvent siphons over about every five minutes. Continue the extraction for one hour; then disconnect the extractor, distill off the solvent, dry the flask in a water oven, cool, and finally reweigh. The increase in weight of the flask will represent the amount of grease and oil in the fabric.

13. Detection of Mineral Oil in Textile Fabrics.—This oil is sometimes employed for the oiling of stock, and is sometimes difficult to remove by simple scouring, if such oil is of improper quality. Extract about 10 grams of the sample with 50 cc. of carbon tetrachloride in a Soxhlet extractor. Distill off the solvent; mix the residue of grease and oil with water. If mineral oil is present a fluorescence will be noticed on the surface of the water.

14. Detection of Resin Oil in Textile Fabrics.—A weighed portion (about 5 grams) of the sample is extracted with 50 cc. of ligroin (as above). To the residue of grease, after evaporation of the solvent, add 5 cc. of acetic anhydride; shake well at a gentle heat, then allow to cool, draw off the layer of acetic anhydride with a pipette, and add to it a drop of concentrated sulphuric acid. The production of a violet color (which, however, is not permanent) will indicate the presence of resin oils. If the presence of rosin (colophony) in a textile fabric is suspected, the former may be first converted into resin oils by boiling with dilute hydrochloric acid; after which the test is to be carried out as given.

15. Estimation of Mineral Matter in a Fabric.—A weighed portion (1 to 2 grams) of the sample is clipped up and ignited in a tared porcelain crucible to a complete ash. The weight of the latter represents the amount of mineral matter in the sample.

16. Determination of the Nature of Sizing on a Fabric.—The principal ingredients liable to be present in the sizing on a fabric are starch, dextrin, gums, gelatin, Irish moss, sugar, rosin, fatty matters, and various inorganic substances such as China clay, gypsum, talc, magnesia, magnesium chloride, calcium chloride, zinc chloride, alumina, etc.

To test for these substances take a sample of the fabric measuring about 30 to 40 sq. in., and boil for several hours in about 250 cc. of water. This will dissolve all soluble materials; including starch, dextrin, gums,

gelatin, Irish moss, sugar, and the chlorides of magnesium, calcium, and zinc. Test this aqueous extract in the following manner:

(1) *Starch*.—Add to a portion of the solution a few drops of iodine solution (in potassium iodide); the formation of a blue color indicates the presence of starch.

(2) *Dextrin and gums*.—If no starch is present, concentrate a portion of the extract by boiling; cool, and add three times its volume of alcohol. Dextrin or gums, if present, will be precipitated. These may be filtered off and identified by burning.

(3) *Gelatin*.—To a portion of the extract add some tannic acid solution, which will give a precipitate in the presence of gelatin.

(4) *Sugar and glucose*.—These may be detected by boiling a portion of the extract with a little dilute hydrochloric acid, and adding a few drops

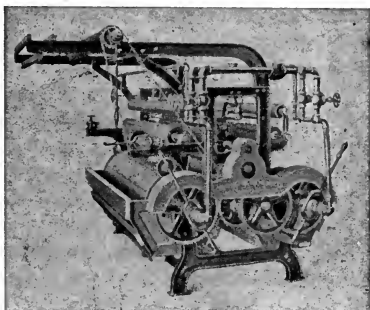

FIG. 302.—Steam Finishing Machine. (Curtis & Marble.)

of Fehling's solution, when a red precipitate of cuprous oxide will be formed in the presence of a sugar.

(5) *Irish moss* (or other lichen jelly) may be considered to be present if an organic substance is known to exist in the extract, and yet no evidence of the foregoing compounds is found.

(6) *Chlorides* may be detected by adding a few drops of nitric acid to the extract, followed by a few drops of a solution of silver nitrate; the formation of a white precipitate of silver chloride will show the presence of chlorides.

(7) *Zinc* may be detected by adding ammonium sulphide to the extract; a white precipitate of zinc sulphide will indicate the presence of this metal.

(8) *Calcium* may be detected by adding ammonium oxalate solution to a portion of the extract, when a white precipitate of calcium oxalate will be formed in the presence of calcium compounds.

(9) *Magnesium* may be detected by adding a few drops of ammonia water and ammonium chloride solution to a portion of the extract, followed by the addition of sodium phosphate solution. The formation of a white, crystalline precipitate of magnesium ammonium phosphate will indicate the presence of magnesium salts.

(10) *Sulphates*, which may at times be present as magnesium sulphate (Epsom's salts), may be detected by adding a few drops of hydrochloric acid to a portion of the extract, followed by the addition of a few drops of a solution of barium chloride. The formation of a white precipitate of barium sulphate will indicate the presence of sulphates.

(11) *Resins, fats, and oils* may be tested for by the methods already given in the preceding experiments.

(12) *China clay* (aluminium silicate), *gypsum* (calcium sulphate), and *talc* (magnesium silicate) are insoluble, even in strong acids, and may be found in the ash left from the ignition of a portion of the fabric, after first boiling in water to remove all soluble matters. It will hardly be necessary here to discriminate between these three substances themselves, as such an analysis would be both tedious and complicated.

17. Determination of the Nature of Mordants on Woolen Fabrics.—To determine the character of the mordant which may be present in a yarn or fabric, a qualitative analysis of the ash must be made. For this purpose, take about 10 grams of the clippings of the sample and ignite, in small portions at a time, thoroughly in a porcelain crucible until all the carbon and volatile matters have been burned away. The different mordants are then tested for in the following manner:

(1) *Aluminium compounds.*—The ash should be white, or grayish. Dissolve a portion in warm hydrochloric acid, and neutralize the solution with a slight excess of ammonia. A white precipitate of aluminium hydrate will indicate the presence of aluminium. This should be confirmed by heating a portion of the ash on charcoal, moistening with a drop of cobalt nitrate solution; a blue color will be obtained if aluminium is present.

(2) *Tin compounds.*—The ash is also white or grayish. Dissolve in boiling hydrochloric acid, and test a portion of the solution with sulphureted hydrogen gas. The formation of a brownish yellow precipitate will indicate the presence of tin.

(3) *Iron compounds.*—The ash is reddish brown in color. Dissolve in warm hydrochloric acid. To a portion of the solution add a drop of nitric acid and a few drops of a solution of potassium ferrocyanide (yellow prussiate). The formation of a blue precipitate will indicate the presence of iron. This may be further confirmed by taking another portion of the solution, adding a drop of nitric acid, and a few drops of a solution of potassium sulphocyanide. The formation of a red color indicates the presence of iron.

(4) *Chromium compounds*.—The ash is yellowish or brownish green. Add a few crystals of potassium chlorate and fuse. The resulting yellowish mass is dissolved in water; a few drops of acetic acid are added, and also a solution of lead acetate. A yellow precipitate of lead chromate will indicate the presence of chromium.

(5) *Copper compounds*.—The ash may be brownish or black. Dissolve in warm hydrochloric acid, neutralize with an excess of ammonia water, when the formation of a blue color will indicate the presence of copper.

In some cases, several of these metals may occur together in the ash of the fabric. In order to conduct a systematic test for all of them proceed in the following manner:

Boil up the ash with a little concentrated hydrochloric acid, and filter from any insoluble residue. To the diluted filtrate add hydrogen sulphide until no further precipitation occurs. A precipitate will indicate the presence of copper or tin (consisting of black copper sulphide or brown tin sulphide). Filter, wash the precipitate, and treat with warm ammonium sulphide solution. This will dissolve any tin sulphide and leave the copper sulphide as a residue. Filter the latter, if present; dissolve the residue in a small quantity of strong nitric acid; dilute with water and add slight excess of ammonia, when the formation of a blue color will indicate the presence of **copper**. Tin, if present in the last filtrate, may be identified by adding slight excess of hydrochloric acid and boiling till all odor of hydrogen sulphide is gone. The solution would now contain stannous chloride; filter, and pour into a hot solution of mercuric chloride; a white precipitate of mercurous chloride will indicate the presence of **tin**. The filtrate from the precipitated sulphides of copper and tin is boiled until all odor of hydrogen sulphide is removed. Add a few drops of concentrated nitric acid and boil for a few minutes longer. Add a slight excess of ammonia water and boil again; this will cause the precipitation of any iron, chromium, or aluminium as hydrates. Filter, and wash the residue. Then boil up with a solution of potassium hydrate which will dissolve out any aluminium hydrate. Filter from the residue of iron and chromium hydrates; acidify the filtrate with hydrochloric acid, and then add ammonia in slight excess. The formation of a colorless, gelatinous precipitate of aluminium hydrate will indicate the presence of **aluminium**. The above residue of iron and chromium hydrates is now fused on a piece of platinum foil with a small quantity of sodium peroxide. This will result in the formation of sodium chromate, and the fused mass will be yellow if chromium is present. Dissolve the fusion in water; filter off any residue of iron oxide, acidify the filtrate with acetic acid, and add a few drops of lead acetate solution. The formation of a yellow precipitate of lead chromate will indicate the presence of **chromium**. The residue of iron oxide, if present, is dissolved in a little hot concentrated hydrochloric acid; dilute

with water and add a few drops of potassium ferrocyanide solution. The formation of a blue precipitate indicates the presence of iron.

18. Determination of the Nature of Mordants on Cotton Fabrics.—The mordants which are liable to be present on cotton fabrics fall under three classes:

(a) Those for basic dyes, including tannin, antimony, iron and copper.

(b) Those for alizarine dyes, including tannin, aluminium, iron, chromium, and fatty acids.

(c) Those for acid dyes, including tannin, aluminium, fatty acids, tin, and lead.

The first class is the principal one, whereas the last two classes rarely come into observation, and then only for a few specific colors. The various mordants may be detected as follows:

(1) *Tannin*.—A sample of the fabric is boiled in a dilute solution of soda ash for twenty minutes; the solution is then poured off and almost neutralized with hydrochloric acid. A few drops of ferric chloride solution are next added, when the formation of a black color (due to tannate of iron) will indicate the presence of tannin.

(2) *Antimony*.—A sample of the fabric is boiled for fifteen minutes with concentrated hydrochloric acid. The solution is filtered and diluted with water. A portion of the filtrate is then treated with hydrogen sulphide, when the formation of a yellow (or orange) precipitate (of antimony sulphide) will indicate the presence of antimony. To confirm this, however, the antimony sulphide is filtered off and dissolved in a little hot concentrated hydrochloric acid. Dilute with water, and add to the solution a piece of zinc on platinum foil. If a black stain forms on the platinum, the presence of antimony is confirmed.

(3) *Iron*.—A portion of the hydrochloric acid extract obtained above is tested with a few drops of potassium ferrocyanide solution. The formation of a blue color will indicate the presence of iron.

(4) *Copper*.—Another portion of the same acid solution as above is neutralized with an excess of ammonia water. The formation of a blue color in the liquid will indicate the presence of copper.

In case the fabric is suspected to have been dyed with alizarine colors (Turkey Red, etc.), *tannin* may be tested for in the manner given above. *Aluminium*, *iron*, *chromium*, and *tin* mordants may be looked for according to the methods given above. *Fatty acids* may be tested for by first boiling the sample with dilute hydrochloric acid (to decompose the fatty acid compounds of the metallic mordants) and then extracting with petroleum ether and testing as given above.

When it is suspected that the sample is dyed with acid colors (which may usually be told by the color not being at all fast to soap and water),

and it is desired to identify the mordants used, those of *aluminium*, *tannin*, *fatty acid*, and *tin* may be detected as given above.

(5) *Lead*.—The sample is boiled for twenty minutes in concentrated nitric acid. Dilute the solution, and filter. To a portion of the filtrate add a few drops of a solution of potassium chromate, when the formation of a yellow precipitate of lead chromate will indicate the presence of lead.

19. Analysis of Black Dyed Cotton.—As black is one of the principal colors dyed on cotton, and as there are such a number of diverse black dyes used for this purpose, the analysis of such colors is a test frequently required of the mill chemist and dyer.

In the first place, it is well to consider the different kinds of black which may be met with in practice as dyed on cotton. The following summary includes about all of those appearing at the present time:

- (1) Logwood Black.
- (2) Direct Blue topped with Logwood.
- (3) Direct Black topped with Logwood.
- (4) Aniline Black.
- (5) Sulphur Black topped with Aniline Black.
- (6) Direct Black topped with Aniline Black.
- (7) Sulphur Black.
- (8) Coupled Black.
- (9) Direct Black.
- (10) Developed Black.
- (11) Developed Black treated with metallic salts.

This list does not follow the order of the importance of the colors, but is thus arbitrarily arranged to suit the convenience of the method of analysis. Logwood Black has not nearly the same importance with reference to cotton dyeing that it formerly had. The make-up of the cotton will also determine in some measure the kind of dyestuff probably employed.

For the dyeing of loose cotton, Sulphur Black and Direct Black are mostly used; for skein and warp yarns Sulphur Black, Developed Black, and Direct Black are chiefly employed; for manufactured cotton materials, Aniline Black, Sulphur Black, and Direct Black are mostly to be looked for. In order to make the analysis general in character, however, we will include in the examination cotton in any of its forms, and also include all of the different blacks mentioned in the above given list.

The analysis may be carried out in the following general manner:

1. A sample of the dyed cotton is boiled for five minutes in a 1 per cent solution of sulphuric acid, and then washed.

A. If the fiber by this treatment changes in color to brown and the liquid acquires an orange-yellow color, the dyestuff employed was Logwood.

B. If the color of the fiber becomes a dull blue while the liquid acquires an orange-yellow color, the test shows that a Direct Blue dyestuff has been used topped with logwood.

C. If the fiber remains black in color, but the solution acquires a

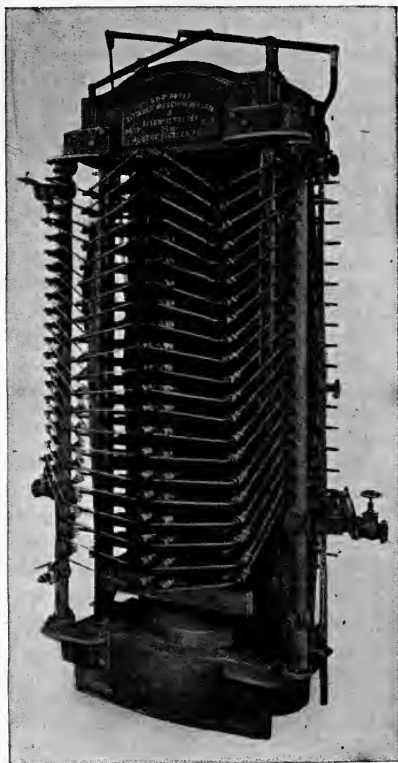

FIG. 303.—Hydraulic Press with Steam-heated Plates for Finishing Satins, Orleans, etc

reddish brown color, there may be one of four possibilities in the dyeing, and a further examination is necessary.

A fresh sample is boiled for five minutes in a 10 per cent solution of stannous chloride (tin crystals), and the following observations are noted.

(1) If the color of the fiber changes to a bluish black while that of the liquid becomes violet, the test indicates that a Direct Black dyestuff has been employed, topped with Logwood and an iron mordant.

(2) If the fiber remains black and the liquid is not appreciably colored, the test indicates the use of Aniline Black, either alone or in conjunction with Sulphur Black, or Direct Black.

To determine which of these three possibilities is the true one, a further examination is again required. A fresh sample of the cotton material is boiled for five minutes in a 20 per cent solution of sodium sulphide, washed well, and dried:

(a) If the fiber remains black while the liquid acquires a pale brownish yellow color, the test indicates that Aniline Black alone has been the dyestuff employed.

(b) If the fiber remains black, but the liquid acquires a deep olive-green color, the test indicates that the material has been dyed with Sulphur Black and topped with Aniline Black.

(c) If the fiber becomes grayish in color while the liquid acquires a reddish brown color, the test indicates that a Direct Black has been used and topped with Aniline Black.

Returning now to the more extended consideration of the first test in which the sample had been treated with the solution of sulphuric acid, we have the further possibility:

D. If the fiber remains black in color while the liquid also remains colorless, or practically so, it will be necessary to make a further test to determine the dyestuff. For this purpose a fresh sample of the cotton material is boiled for five minutes in a 20 per cent solution of sodium sulphide, then washed well, and dried.

(1) If the fiber remains black while the liquid becomes clear green or olive in color, the test indicates the use of Sulphur Black in the dyeing.

(2) If the fiber remains black, but the liquid acquires a dull brown color, the test indicates the use of a coupled black; that is to say, the use of a direct dye applied after the manner of the coupling process.

(3) If the fiber changes to a grayish color while the liquid acquires a dark reddish brown color, the test indicates the use of either a direct black, or a developed black.

To discriminate further between these two possibilities, a fresh sample of the material is boiled for five minutes in a 10 per cent solution of sodium carbonate, and the following observations are noted:

(a) If the fiber remains black while the liquid acquires a violet or reddish brown color, the use of a direct black is indicated.

(b) If the fiber remains black and the liquid colorless or only slightly colored, the use of a developed black is indicated. To ascertain if this color has been after-treated with metallic salts, a sample of the dyed

cotton should be burned to a complete ash, and this ash must then be subjected to the ordinary methods of chemical analysis to determine the presence or absence of chromium or copper. If either or both of these metals are found to be present in the ash, the dyeing has been after-treated with the corresponding salt, which would be chrome or bluestone, or both.

CHAPTER XXXIII

USEFUL DATA FOR DYERS AND TEXTILE CHEMISTS

1. Hydrometers.—The strength of many solutions is most conveniently measured by a determination of the density. The instrument used for this purpose is known as a hydrometer.

The Twaddell Hydrometer.—This is an instrument for measuring the density of solutions and liquids. Each Twaddell degree (abbreviated to Tw.) represents 0.005 unit of specific gravity, and the starting-point for liquids heavier than water is the density of water, which is 1 sp. gr. and is made equal to 0° Tw. Hence 1° Tw. would be 1.005 sp. gr.; 2° Tw. would be 1.010 sp. gr.; 10° Tw. would be 1.050 sp. gr., etc. To convert specific gravity readings into degrees Twaddell, and *vice versa*, the following formulas may be employed:

$$\text{Twaddell degrees} = (\text{specific gravity} - 1) \times 200;$$

$$= \frac{\text{specific gravity} - 1}{0.005}$$

$$\text{Specific gravity} = (\text{Tw.}^\circ \times 0.005) + 1.$$

The Baumé Hydrometer.—This is an instrument very similar to that of Twaddell, but its method of graduation is different. The degrees Baumé (abbreviated to Bé.) bear no direct relation to actual specific gravity, but this hydrometer is largely used for technical work both in Europe and America. The graduation for liquids heavier than water is made in the following manner. The zero mark (as with the Twaddell instrument) is obtained by immersion in distilled water; the instrument is then placed in a solution containing 15 parts by weight of common salt and 85 parts by weight of water, and the point to which the hydrometer sinks is called 15. The interval between this point and the zero is then divided into 15 equal parts, and the graduation continued as far as desirable. The degrees Baumé represent greater density than corresponding degrees Twaddell. The table on the next page shows the equivalence between specific gravity, degrees Twaddell, and degrees Baumé.

A solution of a certain density may be diluted with water (density

1.000) to a solution of another specified density in accordance with the following formula:

Let V = volume of strong solution;

v = volume of water to be added;

D = density of strong solution (in specific gravity);

d = density of diluted solution (in specific gravity).

Then
$$v = V \times \frac{D-d}{d-1}.$$

If the densities are expressed in degrees Twaddell, the formula becomes:

$$v = V \times \frac{T-t}{t},$$

where T = density of strong solution in degrees Twaddell;

t = density of diluted solution in degrees Twaddell.

This formula, however, can be used only in cases where there is no contraction in volume of the mixed liquids; that is to say, where the volume of the mixture is equal to the sum of the volumes of the solutions used. In the case of sulphuric acid and other material where there is a reaction between the chemical and the water added, there is a change in volume which must be allowed for in order to obtain the proper density.

COMPARISON BETWEEN THE SPECIFIC GRAVITY OF BAUMÉ AND TWADDELL

Tw.	Bé.	Sp. Gr.	Tw.	Bé.	Sp. Gr.	Tw.	Bé.	Sp. Gr.
0	0	1.000	14	9.4	1.070	28	17.7	1.110
1	0.7	1.005	15	10.0	1.075	29	18.3	1.115
2	1.4	1.010	16	10.6	1.080	30	18.8	1.150
3	2.1	1.015	17	11.2	1.085	31	19.3	1.155
4	2.7	1.020	18	11.9	1.090	32	19.8	1.160
5	3.4	1.025	19	12.4	1.095	33	20.3	1.165
6	4.1	1.030	20	13.0	1.100	34	20.9	1.170
7	4.7	1.035	21	13.6	1.105	35	21.4	1.175
8	5.4	1.040	22	14.2	1.110	36	22.0	1.180
9	6.0	1.045	23	14.9	1.115	37	22.5	1.185
10	6.7	1.050	24	15.4	1.120	38	23.0	1.190
11	7.4	1.055	25	16.0	1.125	39	23.5	1.195
12	8.0	1.060	26	16.5	1.130	40	24.0	1.200
13	8.7	1.065	27	17.1	1.135	41	24.5	1.205

COMPARISON BETWEEN THE SPECIFIC GRAVITY OF BAUMÉ AND
TWADDELL—*Continued*

Tw.	Bé.	Sp. Gr.	Tw.	Bé.	Sp. Gr.	Tw.	Bé.	Sp. Gr.
42	25.0	1.210	86	43.4	1.430	130	56.9	1.650
43	25.5	1.215	87	43.8	1.435	131	57.1	1.655
44	26.0	1.220	88	44.1	1.440	132	57.4	1.660
45	26.4	1.255	89	44.4	1.445	133	57.7	1.665
46	26.9	1.230	90	44.8	1.450	134	57.9	1.670
47	27.4	1.235	91	45.1	1.455	135	58.2	1.675
48	27.9	1.240	92	45.4	1.460	136	58.4	1.680
49	28.4	1.245	93	45.8	1.465	137	58.7	1.685
50	28.8	1.250	94	46.1	1.470	138	58.9	1.690
51	29.3	1.255	95	46.4	1.475	139	59.2	1.605
52	29.7	1.260	96	46.7	1.480	140	59.5	1.700
53	30.2	1.265	97	47.1	1.485	141	59.7	1.705
54	30.6	1.270	98	47.4	1.490	142	60.0	1.710
55	31.1	1.275	99	47.8	1.495	143	60.2	1.715
56	31.5	1.280	100	48.1	1.500	144	60.4	1.720
57	32.0	1.285	101	48.4	1.505	145	60.6	1.725
58	32.4	1.290	102	48.7	1.510	146	60.9	1.730
59	32.8	1.295	103	49.0	1.515	147	61.1	1.755
60	33.3	1.300	104	49.4	1.520	148	61.4	1.740
61	33.7	1.305	105	49.7	1.525	149	61.6	1.745
62	34.2	1.310	106	50.0	1.530	150	61.8	1.750
63	34.6	1.315	107	50.3	1.535	151	62.3	1.755
64	35.0	1.320	108	50.6	1.540	152	62.5	1.760
65	35.4	1.325	109	50.9	1.545	153	62.5	1.765
66	35.8	1.330	110	51.2	1.550	154	62.8	1.770
67	36.2	1.335	111	51.5	1.555	155	63.0	1.775
68	36.6	1.340	112	51.8	1.560	156	63.2	1.780
69	37.0	1.345	113	52.1	1.565	157	63.5	1.785
70	37.4	1.350	114	52.4	1.570	158	63.7	1.790
71	37.8	1.355	115	52.7	1.575	159	64.0	1.795
72	38.2	1.360	116	53.0	1.580	160	64.2	1.800
73	38.6	1.365	117	53.3	1.585	161	64.4	1.805
74	39.0	1.370	118	53.6	1.590	162	64.6	1.810
75	39.4	1.375	119	53.9	1.595	163	64.8	1.815
76	39.8	1.380	120	54.1	1.600	164	65.0	1.820
77	40.1	1.385	121	54.4	1.605	165	65.2	1.825
78	40.5	1.390	122	54.7	1.610	166	65.5	1.830
79	40.8	1.395	123	55.0	1.615	167	65.7	1.835
80	41.2	1.400	124	55.2	1.620	168	65.9	1.840
81	41.6	1.405	125	55.5	1.625	169	66.1	1.845
82	42.0	1.410	126	55.8	1.630	170	66.3	1.850
83	42.3	1.415	127	56.0	1.635	171	66.5	1.855
84	42.7	1.420	128	56.3	1.640	172	66.7	1.860
85	43.1	1.425	129	56.6	1.645	173	67.0	1.865

2. **Equivalents of Common Use in Measuring.**—In all scientific and accurate work the metric system of weights and measures is universally

employed. It is presumed that the reader is familiar in a general way with the method and values of the metric system, but his attention is called at this point to following equivalents, both of the metric system and the common English system, which will be found useful and practical for reference.

- 1 liter (*l.*) = 1000 cubic centimeters (*cc.*).
- 1 liter of water weighs 1 kilogram (*kilo.*).
- 1 cc. of water weighs 1 gram (*gm.*).
- 1 cubic foot of water weighs 62.5 pounds.
- 1 gram = 1000 milligrams (*mgm.*).
- 1 kilogram = 1000 grams = 2.2 pounds.
- 1 pound (*Avoir.*) = 453.9 grams.
- 1 gallon (U. S.) = 231 cubic inches.
- 1 gallon water = 8.3 pounds.
- 1 pint water = 1 pound (approximately).
- 1 liter = 1 quart (approximately).

To convert feet to meters multiply by 0.3.

Meters to feet multiply by 3.3.

Cubic feet to gallons multiply by 7.5.

Gallons to cubic feet multiply by 0.13.

Cubic feet to liters multiply by 28.33.

Liters to cubic feet multiply by 0.035.

Inches to centimeters multiply by 2.5.

Centimeters to inches multiply by 0.4.

Ounces to grams multiply by 28.35.

Grams to ounces multiply by 0.04.

Grains to grams multiply by 0.065.

Grams to grains multiply by 15.43.

Yards to meters multiply by 0.9.

Meters to yards multiply by 1.1.

Quarts to liters multiply by 0.95.

Liters to quarts multiply by 1.06.

Gallons to liters multiply by 3.78.

Liters to gallons multiply by 0.26.

An English (Imperial) gallon is larger than the United States gallon; it contains 277½ cubic inches = 4.54 liters; it contains 10 pounds of water.

3. CONVERSION TABLES.

CONVERSION OF KILOGRAMS INTO POUNDS.

Kilos.	Lbs.	Kilos.	Lbs.	Kilos.	Lbs.	Kilos.	Lbs.
1	2½	7	15½	40	88	100	220½
2	4½	8	17½	50	110½	200	441
3	6½	9	19½	60	132	300	661
4	8½	10	22½	70	154	400	882
5	11	20	44½	80	176	500	1102½
6	13½	30	66½	90	198	600	1323

CONVERSION OF POUNDS INTO KILOGRAMS

Lbs.	Kilos.	Lbs.	Kilos.	Lbs.	Kilos.	Lbs.	Kilos.
1	0.453	11	4.984	21	9.515	40	18.125
2	0.906	12	5.437	22	9.968	50	22.656
3	1.359	13	5.890	23	10.421	60	27.187
4	1.812	14	6.343	24	10.874	70	31.719
5	2.265	15	6.796	25	11.327	80	36.250
6	2.719	16	7.249	26	11.780	90	40.781
7	3.172	17	7.702	27	12.233	100	45.302
8	3.625	18	8.155	28	12.686	200	90.625
9	4.078	19	8.608	29	13.139	300	135.937
10	4.531	20	9.062	30	13.594	400	181.250

CONVERSION OF OUNCES INTO GRAMS

Ounces.	Grams.	Ounces.	Grams.	Ounces.	Grams.	Ounces.	Grams.
1	28.35	5	141.75	9	255.15	13	368.54
2	56.70	6	170.10	10	283.50	14	396.89
3	85.05	7	198.45	11	311.84	15	425.24
4	113.40	8	226.80	12	340.19	16	453.59

CONVERSION OF GRAMS INTO OUNCES AND GRAINS

Grams.	Ounces.	Grains.	Grams.	Ounces.	Grains.	Grams.	Ounces.	Grains.
1	15.43	23	355	44	1	241
2	30.9	24	370	45	1	257
3	46.3	25	386	46	1	272
4	61.7	26	401	47	1	288
5	77.2	27	417	48	1	303
6	92.6	28	432	49	1	319
7	108	29	1	10	50	1	334
8	123	30	1	25	51	1	350
9	139	31	1	41	52	1	365
10	154	32	1	56	53	1	380
11	170	33	1	72	54	1	395
12	185	34	1	87	55	1	411
13	201	35	1	102	56	1	427
14	216	36	1	118	57	2	5
15	231	37	1	133	58	2	20
16	247	38	1	149	59	2	36
17	262	39	1	164	60	2	51
18	278	40	1	180	70	2	205
19	293	41	1	195	80	2	360
20	309	42	1	210	90	3	76
21	324	43	1	226	100	3	230
22	340						

4. Thermometry. Comparison of Centigrade Thermometer with Fahrenheit.

Degrees Centigrade.	Degrees Fahrenheit	Degrees Centigrade.	Degrees Fahrenheit.	Degrees Centigrade.	Degrees Fahrenheit.	Degrees Centigrade.	Degrees Fahrenheit.
110	230	80	176	50	122	20	68
109	228.2	79	174.2	49	120.2	19	66.2
108	226.4	78	172.4	48	118.4	18	64.4
107	224.6	77	170.6	47	116.6	17	62.6
106	222.8	76	168.8	46	114.8	16	60.8
105	221	75	167	45	113	15	59
104	219.2	74	165.2	44	111.2	14	57.2
103	217.4	73	163.4	43	109.4	13	55.4
102	215.6	72	161.6	42	107.6	12	53.6
101	213.8	71	159.8	41	105.8	11	51.8
100	212	70	158	40	104	10	50
99	210.2	69	156.2	39	102.2	9	48.2
98	208.4	68	154.4	38	100.4	8	46.4
97	206.6	67	152.6	37	98.6	7	44.6
96	204.8	66	150.8	36	96.8	6	42.8
95	203	65	149	35	95	5	41
94	201.2	64	147.2	34	93.2	4	39.2
93	199.4	63	145.4	33	91.4	3	37.4
92	197.6	62	143.6	32	89.6	2	35.6
91	195.8	61	141.8	31	87.8	1	33.8
90	194	60	140	30	86	0	32
89	192.2	59	138.2	29	84.2	-1	30.2
88	190.4	58	136.4	28	82.4	2	28.4
87	188.6	57	134.6	27	80.6	3	26.6
86	186.8	56	132.8	26	78.8	4	24.8
85	185	55	131	25	77	5	23
84	183.2	54	129.2	24	75.2	6	21.2
83	181.4	53	127.4	23	73.4	7	19.4
82	179.6	52	125.6	22	71.6	8	17.6
81	177.8	51	123.8	21	69.8	9	15.8

To convert degrees Centigrade to degrees Fahrenheit:

$$(C^{\circ} \times 9) \div 5 \text{ and add } 32 = F^{\circ}.$$

To convert degrees Fahrenheit to degrees Centigrade:

$$(F^{\circ} - 32) \times 5 \div 9 = C^{\circ}.$$

5. Comparison of Relative Strengths of Chemicals

100 parts by weight of *sal soda* are equivalent to 37 parts of *soda ash*.

100 parts of *soda ash* are equivalent to 270 parts of *sal soda*.

100 parts of *crystallized glaubersalt* are equivalent to 44 parts of *calcined glaubersalt*.

100 parts of *calcined glaubersalt* are equivalent to 227 parts of *crystallized glaubersalt*.

100 parts of *alum* are equivalent in dyeing value to 60 parts of *aluminium sulphate*.

100 parts of *aluminium sulphate* are equivalent to 170 parts of *alum*.

100 parts of *sulphuric acid* 168° Tw. correspond to 220 parts *hydrochloric acid* 32° Tw., and to 400 parts *acetic acid* 9° Tw.

100 parts of *hydrochloric acid* 32° Tw. correspond to 45 parts of *sulphuric acid* 168° Tw., and to 175 parts of *acetic acid* 9° Tw.

100 parts of *acetic acid* 9° Tw. correspond to 26 parts of *sulphuric acid* 168° Tw., and to 57 parts of *hydrochloric acid* 32° Tw.

100 parts of *crystallized sodium sulphide* are equivalent to 50 parts of *concentrated sodium sulphide*.

100 parts of *concentrated sodium sulphide* are equivalent to 200 parts of the *crystallized*.

6. Tables of the Strengths and Densities of Various Solutions

SULPHURIC ACID

At 60° F. (15° C.)

Deg. Tw.	Per Cent Sulphuric Acid.	Deg. Tw.	Per Cent Sulphuric Acid.	Deg. Tw.	Per Cent Sulphuric Acid.	Deg. Tw.	Per Cent Sulphuric Acid.
2	1.57	48	32.28	94	56.90	140	77.17
4	3.03	50	33.43	96	57.83	142	78.04
6	4.49	52	34.57	98	58.74	144	78.92
8	5.96	54	35.71	100	59.70	146	79.80
10	7.37	56	36.87	102	60.65	148	80.68
12	8.77	58	38.03	104	61.59	150	81.56
14	10.19	60	39.19	106	62.53	152	82.44
16	10.90	62	40.35	108	63.43	154	83.32
18	12.99	64	41.50	110	64.26	156	84.50
20	14.35	66	42.66	112	65.08	158	85.70
22	15.71	68	43.74	114	65.90	160	86.90
24	17.01	70	44.82	116	66.71	162	88.30
26	18.31	72	45.88	118	67.59	164	90.05
28	19.61	74	46.94	120	68.51	165	91.00
30	20.91	76	48.50	122	69.43	166	92.10
32	22.19	78	49.06	124	70.32	167	93.43
34	23.47	80	50.11	126	71.16	168	95.60
36	24.76	82	51.15	128	71.99	168.3*	97.70
38	26.04	84	52.15	130	72.82	168.1	98.70
40	27.32	86	53.11	132	73.64	168	99.20
42	28.58	88	54.07	134	74.51	167.7	99.95
44	29.84	90	55.03	136	75.42
46	31.11	92	55.97	138	76.30

* Sulphuric acid of 97.70 per cent has the highest density, while that of the stronger acid is slightly lower.

HYDROCHLORIC ACID

At 60° F.

Deg. Tw.	Per Cent Hydrochloric Acid.	Deg. Tw.	Per Cent Hydrochloric Acid.	Deg. Tw.	Per Cent Hydrochloric Acid.	Deg. Tw.	Per Cent Hydrochloric Acid.
1	1.15	11	11.18	21	20.97	31	30.55
2	2.14	12	12.19	22	21.92	32	31.52
3	3.12	13	13.19	23	22.86	33	32.49
4	4.13	14	14.17	24	23.82	34	33.46
5	5.15	15	15.16	25	24.78	35	34.42
6	6.15	16	16.15	26	25.75	36	35.39
7	7.15	17	17.13	27	26.70	37	36.31
8	8.16	18	18.11	28	27.66	38	37.23
9	9.16	19	19.06	29	28.61	39	38.16
10	10.17	20	20.01	30	29.57	40	39.11

From this table it will be seen that the degree Twaddell indicates approximately the percentage of hydrochloric acid in the solution.

ACETIC ACID

At 60° F.

Per Cent Acetic Acid.	Deg. Tw.	Per Cent Acetic Acid.	Deg. Tw.	Per Cent Acetic Acid.	Deg. Tw.	Per Cent Acetic Acid.	Deg. Tw.
5	1.3	30	8.2	55	13.1	80	15.0
10	2.8	35	9.4	60	13.7	85	14.8
15	4.3	40	10.5	65	14.3	90	14.3
20	5.7	45	11.4	70	14.7	95	13.2
25	7.0	50	12.3	75	14.9	100	11.1

The densities above 11° Tw. correspond to two liquids of different strengths. To determine if the solution corresponds to the stronger or the weaker acid, a small quantity of water is added, and the density is again measured. If the density increases on addition of water the acid is the stronger; whereas if it diminishes the acid is the weaker.

CAUSTIC SODA

At 60° F.

Per Cent Caustic Soda.	Deg. Tw.	Per Cent Caustic Soda.	Deg. Tw.	Per Cent Caustic Soda.	Deg. Tw.	Per Cent Caustic Soda.	Deg. Tw.
1	2.4	16	36.2	31	68.6	46	99.8
2	4.6	17	38.4	32	70.2	47	101.6
3	7.0	18	40.4	33	72.6	48	103.8
4	9.2	19	42.6	34	74.8	49	105.8
5	11.8	20	45.0	35	76.8	50	108.0
6	14.0	21	47.2	36	79.0	51	110.0
7	16.2	22	49.4	37	81.0	52	112.0
8	18.4	23	51.6	38	83.0	53	114.0
9	20.6	24	53.8	39	85.2	54	116.0
10	23.0	25	55.8	40	87.4	55	118.2
11	25.2	26	58.0	41	89.4	56	120.2
12	27.4	27	60.0	42	91.5	57	122.2
13	29.6	28	62.0	43	93.6	58	124.4
14	31.8	29	64.2	44	95.6	59	126.6
15	34.0	30	66.4	45	97.6	60	128.6

SODA ASH

At 60° F.

Deg. Tw.	Per Cent Sodium Carbonate.	Deg. Tw.	Per Cent Sodium Carbonate.	Deg. Tw.	Per Cent Sodium Carbonate.	Deg. Tw.	Per Cent Sodium Carbonate.
1	0.47	9	4.28	17	8.04	25	11.76
2	0.95	10	4.76	18	8.51	26	12.23
3	1.42	11	5.23	19	8.97	27	12.70
4	1.90	12	5.71	20	9.43	28	13.16
5	2.38	13	6.17	21	9.90	29	13.63
6	2.85	14	6.64	22	10.37	30	14.09
7	3.33	15	7.10	23	10.83
8	3.80	16	7.57	24	11.30

GLAUBERSALT

At 66° F.

Per Cent Glauber-salt.	Sp. Gr.	Per Cent Glauber-salt.	Sp. Gr.	Per Cent Glauber-salt.	Sp. Gr.	Per Cent Glauber-salt.	Sp. Gr.
1	1.0040	9	1.0358	17	1.0683	25	1.1015
2	1.0079	10	1.0398	18	1.0725	26	1.1057
3	1.0118	11	1.0439	19	1.0766	27	1.1100
4	1.0158	12	1.0479	20	1.0807	28	1.1142
5	1.0198	13	1.0520	21	1.0849	29	1.1184
6	1.0238	14	1.0560	22	1.0890	30	1.1226
7	1.0278	15	1.0601	23	1.0931
8	1.0318	16	1.0642	24	1.0973

The percentage of desiccated (or calcined) glaubersalt, Na_2SO_4 , may be obtained by multiplying the above percentages of crystallized glaubersalt by the factor 0.441.

COMMON SALT (SODIUM CHLORIDE)

At 60° F.

Per Cent Sodium Chloride.	Sp. Gr.	Per Cent Sodium Chloride.	Sp. Gr.	Per Cent Sodium Chloride.	Sp. Gr.	Per Cent Sodium Chloride.	Sp. Gr.
1	1.00725	8	1.05851	15	1.11146	22	1.16755
2	1.01450	9	1.06593	16	1.11938	23	1.17580
3	1.02174	10	1.07335	17	1.12730	24	1.18404
4	1.02899	11	1.08097	18	1.13523	25	1.19228
5	1.03624	12	1.08859	19	1.14315	26	1.20098
6	1.04366	13	1.09622	20	1.15107	26.4	1.20433
7	1.05108	14	1.10384	21	1.15931

TANNIC ACID

At 60° F.

Per Cent Tannic Acid.	Sp. Gr.	Per Cent Tannic Acid.	Sp. Gr.	Per Cent Tannic Acid.	Sp. Gr.	Per Cent Tannic Acid.	Sp. Gr.
1.0	1.0040	2.1	1.0084	3.2	1.0128	4.3	1.0172
1.1	1.0044	2.2	1.0088	3.3	1.0132	4.4	1.0176
1.2	1.0048	2.3	1.0092	3.4	1.0136	4.5	1.0180
1.3	1.0052	2.4	1.0096	3.5	1.0140	4.6	1.0184
1.4	1.0056	2.5	1.0100	3.6	1.0144	4.7	1.0188
1.5	1.0060	2.6	1.0104	3.7	1.0148	4.8	1.0192
1.6	1.0064	2.7	1.0108	3.8	1.0152	4.9	1.0196
1.7	1.0068	2.8	1.0112	3.9	1.0156	5.0	1.0200
1.8	1.0072	2.9	1.0116	4.0	1.0160
1.9	1.0076	3.0	1.0120	4.1	1.0164
2.0	1.0080	3.1	1.0124	4.2	1.0168

BLEACHING POWDER (CHLORIDE OF LIME)

At 60° F.

Density.		Available Chlorine.		
Specific Gravity.	Tw. Degrees.	Per Liter.	Per Gallon.	
		Grains.	Ounces.	Grains.
1.1155	23.1	71.79	11	213
1.1150	23	71.50	11	193
1.1105	22.1	68.66	10	431
1.1100	22	68.00	10	385
1.1060	21.2	65.33	10	198
1.1050	21	64.50	10	140
1.1000	20	61.17	9	346
1.0950	19	58.33	9	146
1.0900	18	55.18	8	363
1.0850	17	52.27	8	159
1.0800	16	48.96	7	365
1.0750	15	45.70	7	137
1.0700	14	42.31	6	337
1.0650	13	48.71	6	85
1.0600	12	35.81	5	320
1.0550	11	32.68	5	101
1.0500	10	29.41	4	309
1.0450	9	26.62	4	113
1.0400	8	23.75	3	351
1.0350	7	20.44	3	119
1.0300	6	17.36	2	340
1.0250	5	14.47	2	137
1.0200	4	11.44	1	362
1.0150	3	8.48	1	157
1.0100	2	5.58	...	391
1.0050	1	2.71	...	190
1.0025	$\frac{1}{2}$	1.40	...	98

PROPORTIONS OF CHLORINE IN WEAK SOLUTIONS OF BLEACHING POWDER

Degrees Tw.	Effective Chlorine, Grams per Liter.
3	8.48
$1\frac{1}{2}$	2.05
1	2.71
$\frac{3}{4}$	4.15

7. Useful Data for Calculations in Dyeing.—*To find the capacity of a rectangular tank:* Multiply the length by the breadth by the depth (in feet), then multiply this product by 7.5 (the number of gallons in a cubic foot). The result will be the capacity of the tank in U. S. gallons. Or, multiply the length by the breadth by the depth in inches, and divide the result by 231 to obtain the capacity in gallons.

To find the capacity of a circular tank: Find the square of half the diameter (in feet), multiply by $\frac{3}{7}$ (an approximation to $\pi=3.1416$), then multiply by the depth (in feet), and finally multiply by 7.5. The result will be the capacity of the tank in gallons. A shorter approximation to the same result is as follows: Square the diameter, multiply by the height, and then by the factor 5.9. Or, multiply the diameter in inches by itself, then multiply by 0.7854, and then by the depth in inches. Divide the result by 231 to obtain the capacity in gallons.

To convert grams per liter into ounces per gallon: Since one gallon is equivalent to $3\frac{3}{4}$ liters, and 1 oz. is equal to 28.3 grams, multiply the number of grams per liter by $3\frac{3}{4}$ and divide by 28.3. A briefer formula is to multiply grams per liter by the factor 0.133.

Grams per Liter.	Grams per Gallon.	Per Gallon.			Grams per Liter.	Grams per Gallon.	Per Gallon.		
		Lbs.	Ozs.	Grns.			Lbs.	Ozs.	Grns.
1	3.785			58	17	64.35		2	112
2	7.570			116	18	68.14		2	170
3	11.355			174	19	71.92		2	228
4	15.140			232	20	75.70		2	286
5	18.92			290	30	113.55		3	429
6	22.71			348	40	151.4		5	165
7	26.50			406	50	189.2		6	278
8	30.28		1	27	60	227.1		7	421
9	34.07		1	85	70	265.0		9	127
10	37.85		1	143	80	302.8		10	270
11	41.63		1	201	90	340.7		11	413
12	45.42		1	259	100	378.5		13	119
13	49.21		1	317	200	757.0	1	10	238
14	53.00		1	375	300	1135.5	2	7	357
15	56.76		1	433	400	1514.0	3	5	39
16	60.56		2	54	500	1892.0	4	2	158

Example.—A solution of sulphuric acid of 1° Tw. density contains 8 grams of the acid per liter. Reference to the above table shows that this amount is equivalent to 1 oz. 27 grains per gallon.

To convert grams per kilogram into ounces per 100 pounds: Multiply by the factor 1.6.

U. S. GALLONS IN ROUND TANKS

For One Foot in Depth

Diameter of Tanks.		No. U. S. Gallons.	Cubic Feet and Area in Square Feet.	Diameter of Tanks.		No. U. S. Gallons.	Cubic Feet and Area in Square Feet.	Diameter of Tanks.		No. U. S. Gallons.	Cubic Feet and Area in Square Feet.
Ft.	In.			Ft.	In.			Ft.	In.		
1	..	5.87	.785	5	8	188.66	25.22	19	..	2120.90	283.53
1	1	6.89	.922	5	9	194.25	25.97	19	3	2177.10	291.04
1	2	8.	1.069	5	10	199.92	26.73	19	6	2234.	298.65
1	3	9.18	1.227	5	11	205.67	27.49	19	9	2291.70	306.35
1	4	10.44	1.396	6	..	211.51	28.27	20	..	2350.10	314.16
1	5	11.79	1.576	6	3	229.50	30.68	20	3	2409.20	322.06
1	6	13.22	1.767	6	6	248.23	33.18	20	6	2469.10	330.06
1	7	14.73	1.969	6	9	267.69	35.78	20	9	2529.60	338.16
1	8	16.32	2.182	7	..	287.88	38.48	21	..	2591.	346.36
1	9	17.99	2.405	7	3	308.81	41.28	21	3	2653.	354.66
1	10	19.75	2.640	7	6	330.48	44.18	21	6	2715.80	363.05
1	11	21.58	2.885	7	9	352.88	47.17	21	9	2779.30	371.54
2	..	23.50	3.142	8	..	376.01	50.27	22	..	2843.60	380.13
2	1	25.50	3.409	8	3	399.88	53.46	22	3	2908.60	388.82
2	2	27.58	3.687	8	6	424.48	56.75	22	6	2974.30	397.61
2	3	29.74	3.976	8	9	449.82	60.13	22	9	3040.80	406.49
2	4	31.99	4.276	9	..	475.89	63.62	23	..	3108.	415.48
2	5	34.31	4.587	9	3	502.70	67.20	23	3	3175.90	424.56
2	6	36.72	4.909	9	6	530.24	70.88	23	6	3244.60	433.74
2	7	39.21	5.241	9	9	558.51	74.66	23	9	3314.	443.01
2	8	41.78	5.585	10	..	587.52	78.54	24	..	3384.10	452.39
2	9	44.43	5.940	10	3	617.26	82.52	24	3	3455.	461.86
2	10	47.16	6.305	10	6	640.74	86.59	24	6	3526.60	471.44
2	11	49.98	6.681	10	9	678.95	90.76	24	9	3598.90	481.11
3	..	52.88	7.069	11	..	710.90	95.03	25	..	3672.	490.87
3	1	55.86	7.467	11	3	743.58	99.40	25	3	3745.80	500.74
3	2	58.92	7.876	11	6	776.99	103.87	25	6	3820.30	510.71
3	3	62.06	8.296	11	9	811.14	108.43	25	9	3895.60	520.77
3	4	65.28	8.727	12	..	846.03	113.10	26	..	3971.60	530.93
3	5	68.58	9.168	12	3	881.65	117.86	26	3	4048.40	541.19
3	6	71.97	9.621	12	6	918.	122.72	26	6	4125.90	551.55
3	7	75.44	10.085	12	9	955.09	127.68	26	9	4204.10	562.
3	8	78.99	10.559	13	..	992.91	132.73	27	..	4283.	572.66
3	9	82.62	11.045	13	3	1031.50	137.89	27	3	4362.70	583.21
3	10	86.33	11.541	13	6	1070.80	143.14	27	6	4443.10	593.96
3	11	90.13	12.048	13	9	1110.80	148.49	27	9	4524.30	604.81
4	..	94.	12.566	14	..	1151.50	153.94	28	..	4606.20	615.75
4	1	97.96	13.095	14	3	1193.	159.48	28	3	4688.80	626.80
4	2	102.	13.635	14	6	1235.30	165.13	28	6	4772.10	637.94
4	3	106.12	14.186	14	9	1278.20	170.87	28	9	4856.20	649.18
4	4	110.32	14.748	15	..	1321.90	176.71	29	..	4941.	660.52
4	5	114.61	15.321	15	3	1366.40	182.65	29	3	5026.60	671.96
4	6	118.97	15.90	15	6	1411.50	188.69	29	6	5112.90	683.49
4	7	123.42	16.50	15	9	1457.40	194.83	29	9	5199.90	695.13
4	8	127.95	17.10	16	..	1504.10	201.06	30	..	5287.70	706.86
4	9	132.56	17.72	16	3	1551.40	207.39	30	3	5376.20	718.69
4	10	137.25	18.35	16	6	1599.50	213.82	30	6	5465.40	730.62
4	11	142.02	18.99	16	9	1648.40	220.35	30	9	5555.40	742.64
5	..	146.88	19.63	17	..	1697.90	226.98	31	..	5646.10	754.77
5	1	151.82	20.29	17	3	1748.20	233.71	31	3	5737.50	766.99
5	2	156.83	20.97	17	6	1799.30	240.53	31	6	5829.70	779.31
5	3	161.93	21.65	17	9	1851.10	247.45	31	9	5922.60	791.73
5	4	167.12	22.34	18	..	1903.60	254.47	32	..	6016.20	804.25
5	5	172.38	23.04	18	3	1956.80	261.59	32	3	6110.60	816.86
5	6	177.72	23.76	18	6	2010.80	268.80	32	6	6205.70	829.58
5	7	183.15	24.48	18	9	2065.50	276.12	32	9	6301.50	842.39

31½ Gallons equals 1 Barrel.

To find the capacity of tanks greater than the largest given in the table, look in the table for a tank of one-half of the given size and multiply its capacity by 4, or one of one-third its size and multiply its capacity by 3, etc.

8.—Tables for Calculations in Dyeing.

PERCENTAGE OF DYESTUFF CORRESPONDING TO GRAMS PER 100 KILOS, AND POUNDS PER 100 LBS. OF GOODS

Per Cent.	Per 100 Kilo.	Per 100 Lbs.			Per Cent.	Per 100 Kilo.	Per 100 Lbs.			Per Cent.	Per 100 Kilo.	Per 100 Lbs.		
	gms.	lb.	ozs.	grs.		gms.	lb.	ozs.	grs.		gms.	lb.	ozs.	grs.
0.001	1			7	0.29	290	4	280	0.65	650	10	175		
0.002	2			14	0.30	300	4	350	0.66	660	10	245		
0.003	3			21	0.31	310	4	420	0.67	670	10	315		
0.004	4			28	0.32	320	5	53	0.68	680	10	385		
0.005	5			35	0.33	330	5	123	0.69	690	11	18		
0.006	6			42	0.34	340	5	193	0.70	700	11	88		
0.007	7			49	0.35	350	5	263	0.71	710	11	158		
0.008	8			56	0.36	360	5	333	0.72	720	11	228		
0.009	9			63	0.37	370	5	403	0.73	730	11	298		
0.01	10			70	0.38	380	6	35	0.74	740	11	368		
0.02	20			140	0.39	390	6	105	0.75	750	12	...		
0.03	30			210	0.40	400	6	175	0.76	760	12	70		
0.04	40			280	0.41	410	6	245	0.77	770	12	140		
0.05	50			350	0.42	420	6	315	0.78	780	12	210		
0.06	60			420	0.43	430	6	385	0.79	790	12	280		
0.07	70	1		53	0.44	440	7	18	0.80	800	12	350		
0.08	80	1	123		0.45	450	7	88	0.81	810	12	420		
0.09	90	1	193		0.46	460	7	158	0.82	820	13	53		
0.10	100	1	263		0.47	470	7	228	0.83	830	13	123		
0.11	110	1	333		0.48	480	7	298	0.84	840	13	193		
0.12	120	1	403		0.49	490	7	368	0.85	850	13	263		
0.13	130	2	35		0.50	500	8	...	0.86	860	13	333		
0.14	140	2	106		0.51	510	8	70	0.87	870	13	403		
0.15	150	2	176		0.52	520	8	140	0.88	880	14	35		
0.16	160	2	246		0.53	530	8	210	0.89	890	14	105		
0.17	170	2	316		0.54	540	8	280	0.90	900	14	175		
0.18	180	2	386		0.55	550	8	350	0.91	910	14	245		
0.19	190	3	18		0.56	560	8	420	0.92	920	14	315		
0.20	200	3	88		0.57	570	9	53	0.93	930	14	385		
0.21	210	3	158		0.58	580	9	123	0.94	940	15	18		
0.22	220	3	229		0.59	590	9	193	0.95	950	15	88		
0.23	230	3	299		0.60	600	9	263	0.96	960	15	158		
0.24	240	3	369		0.61	610	9	333	0.97	970	15	228		
0.25	250	4	...		0.62	620	9	403	0.98	980	15	298		
0.26	260	4	70		0.63	630	10	35	0.99	990	15	368		
0.27	270	4	140		0.64	640	10	105	1	1 Kilo	1			
0.28	280	4	210											

1 lb. = 16 oz. = 7000 grains = 454 grams.

1 oz. = 437½ grains = 28.349 grams

1 gram = 15.43 grains.

Example.—There is required 2.16 per cent of dyestuff for 100 lbs. of goods. Reference to the above table shows for 100 lbs. of goods.

2 per cent is 32 ozs.

0.16 per cent is 2 ozs. 246 grs.

Hence

2.16 per cent is 34 ozs. 246 grs.

COMPARISON OF DYE-TESTS WITH TEST SKEINS OF 5 GRAMS
(77 GRAINS) AND PRACTICAL DYEING OF 100 LBS. MATERIAL

The standard solutions for the dye-tests contain 1 gram of dyestuff dissolved in 1 liter of water.

For 5 Grams Samples.	Equivalent		Equivalent per			For 5 Grams Samples.	Equivalent		Equivalent per			
	Percentage.	Per Cent	100 Lbs.	lb.	ozs.		grs.	Percentage.	Per Cent.	100 Lbs.	lb.	ozs.
1	0.02					49	0.98					
2	0.04				140	50	1.00	1			15½	179
3	0.06			½	62	51	1.02	1				140
4	0.08			½	202	52	1.04	1		½		62
5	0.10			1½	44	53	1.06	1		½		202
6	0.12			1½	184	54	1.08	1	1			123
7	0.14			2	105	55	1.10	1	1½			44
8	0.16			2½	27	56	1.12	1	1½			184
9	0.18			2½	167	57	1.14	1	2			105
10	0.20			3	88	58	1.16	1	2½			27
11	0.22			3½	9	59	1.18	1	2½			167
12	0.24			3½	199	60	1.20	1	3			88
13	0.26			4	70	61	1.22	1	3½			9
14	0.28			4	210	62	1.24	1	3½			149
15	0.30			4½	132	63	1.26	1	4			70
16	0.32			5	53	64	1.28	1	4			210
17	0.34			5	193	65	1.30	1	4½			132
18	0.36			5½	114	66	1.32	1	5			53
19	0.38			6	35	67	1.34	1	5			193
20	0.40			6	175	68	1.36	1	5½			114
21	0.42			6½	97	69	1.38	1	6			35
22	0.44			7	18	70	1.40	1	6			175
23	0.46			7	158	71	1.42	1	6½			97
24	0.48			7½	79	72	1.44	1	7			13
25	0.50			8	00	73	1.46	1	7			158
26	0.52			8	140	74	1.48	1	7½			79
27	0.54			8½	62	75	1.50	1	8			
28	0.56			8½	202	76	1.52	1	8			140
29	0.58			9	123	77	1.54	1	8½			62
30	0.60			9½	44	78	1.56	1	8½			202
31	0.62			9½	184	79	1.58	1	9			123
32	0.64			10	105	80	1.60	1	9½			44
33	0.66			10½	27	81	1.62	1	9½			184
34	0.68			10½	167	82	1.64	1	10			105
35	0.70			11	88	83	1.66	1	10½			27
36	0.72			11½	9	84	1.68	1	10½			167
37	0.74			11½	149	85	1.70	1	11			88
38	0.76			12	70	86	1.72	1	11½			9
39	0.78			12	210	87	1.74	1	11½			149
40	0.80			12½	132	88	1.76	1	12			70
41	0.82			13	53	89	1.78	1	12			210
42	0.84			13	193	90	1.80	1	12½			132
43	0.86			13½	114	91	1.82	1	13			53
44	0.88			14	35	92	1.84	1	13			193
45	0.90			14	175	93	1.86	1	13½			114
46	0.92			14½	97	94	1.88	1	14			35
47	0.94			15	18	95	1.90	1	14			175
48	0.96			15	158	96	1.92	1	14½			97

COMPARISON OF DYE-TESTS—Continued

For 5 Grams Samples.	Equivalent Percentage.	Equivalent per 100 Lbs.			For 5 Grams	Equivalent Percentage.	Equivalent per 100 Lbs.		
		cc.	Per Cent.	lb. ozs. grs.			cc.	Per Cent.	lb. ozs. grs.
97	1.94	1	15	18	149	2.98	2	15½	179
98	1.96	1	15	158	150	3.00	3		
99	1.98	1	15½	79	151	3.02	3	0	140
100	2.00	2			152	3.04	3	½	62
101	2.02	2		140	153	3.06	3	½	202
102	2.04	2	½	62	154	3.08	3	1	123
103	2.06	2	½	202	155	3.10	3	1½	44
104	2.08	2	1	123	156	3.12	3	1½	184
105	2.10	2	1½	44	157	3.14	3	2	105
106	2.12	2	1½	184	158	3.16	3	2½	27
107	2.14	2	2	105	159	3.18	3	2½	167
108	2.16	2	2½	27	160	3.20	3	3	88
109	2.18	2	2½	167	161	3.22	3	3½	9
110	2.20	2	3	88	162	3.24	3	3½	149
111	2.22	2	3½	9	163	3.26	3	4	70
112	2.24	2	3½	149	164	3.28	3	4	210
113	2.26	2	4	70	165	3.30	3	4½	132
114	2.28	2	4	210	166	3.32	3	5	53
115	2.30	2	4½	132	167	3.34	3	5	193
116	2.32	2	5	53	168	3.36	3	5½	114
117	2.34	2	5	193	169	3.38	3	6	35
118	2.36	2	5½	114	170	3.40	3	6	175
119	2.38	2	6	35	171	3.42	3	6½	97
120	2.40	2	6	175	172	3.44	3	7	18
121	2.42	2	6½	97	173	3.46	3	7	158
122	2.44	2	7	185	174	3.48	3	7½	79
123	2.46	2	7	158	175	3.50	3	8	
124	2.48	2	7½	79	176	3.52	3	8	140
125	2.50	2	8		177	3.54	3	8½	62
126	2.52	2	8	140	178	3.56	3	8½	202
127	2.54	2	8½	62	179	3.58	3	9	123
128	2.56	2	8½	202	180	3.60	3	9½	44
129	2.58	2	9	123	181	3.62	3	9½	184
130	2.60	2	9½	44	182	3.64	3	10	105
131	2.62	2	9½	184	183	3.66	3	10½	27
132	2.64	2	10	105	184	3.68	3	10½	167
133	2.66	2	10½	27	185	3.70	3	11	88
134	2.68	2	10½	167	186	3.72	3	11½	9
135	2.70	2	11	88	187	3.74	3	11½	149
136	2.72	2	11½	9	188	3.76	3	12	70
137	2.74	2	11½	149	189	3.78	3	12	210
138	2.76	2	12	70	190	3.80	3	12½	132
139	2.78	2	12	210	191	3.82	3	13	53
140	2.80	2	12½	132	192	3.84	3	13	193
141	2.82	2	13	53	193	3.86	3	13½	114
142	2.84	2	13	193	194	3.88	3	14	35
143	2.86	2	13½	114	195	3.90	3	14	175
144	2.88	2	14	35	196	3.92	3	14½	97
145	2.90	2	14	175	197	3.94	3	15	18
146	2.92	2	14½	97	198	3.96	3	15	158
147	2.94	2	15	18	199	3.98	3	15½	79

TO CONVERT CUBIC CENTIMETERS OF TEST SOLUTIONS CONTAINING ONE GRAM OF DYESTUFF DISSOLVED IN ONE LITER INTO CORRESPONDING PERCENTAGES FOR 10-GRAM TEST SKEINS AND WEIGHTS OF DYESTUFF PER 100 POUNDS OF GOODS:

Cc. of Solution.	Per Cent. on 10 Grams.	Weight per 100 Lbs.			Cc. of Solution.	Per Cent. on 10 Grams.	Weight per 100 Lbs.			Cc. of Solution.	Per Cent. on 10 Grams.	Weight per 100 Lbs.		
		Lbs.	Ozs.	Grs.			Lbs.	Ozs.	Grs.			Lbs.	Ozs.	Grs.
1	0.01			70	42	0.42	6	315	83	0.83		13	122	
2	0.02			140	43	0.43	6	385	84	0.84		13	192	
3	0.03			210	44	0.44	7	17	85	0.85		13	262	
4	0.04			280	45	0.45	7	87	86	0.86		13	332	
5	0.05			350	46	0.46	7	157	87	0.87		13	402	
6	0.06			420	47	0.47	7	227	88	0.88		14	35	
7	0.07	1	52		48	0.48	7	297	89	0.89		14	105	
8	0.08	1	122		49	0.49	7	367	90	0.90		14	175	
9	0.09	1	192		50	0.50	8	0	91	0.91		14	245	
10	0.10	1	262		51	0.51	8	70	92	0.92		14	315	
11	0.11	1	332		52	0.52	8	140	93	0.93		14	385	
12	0.12	1	402		53	0.53	8	210	94	0.94		15	17	
13	0.13	2	35		54	0.54	8	280	95	0.95		15	87	
14	0.14	2	105		55	0.55	8	350	96	0.96		15	157	
15	0.15	2	175		56	0.56	8	420	97	0.97		15	227	
16	0.16	2	245		57	0.57	9	52	98	0.98		15	297	
17	0.17	2	315		58	0.58	9	122	99	0.99		15	367	
18	0.18	2	385		59	0.59	9	192	100	1.00	1	0	0	
19	0.19	3	17		60	0.60	9	262	101	1.01	1	0	70	
20	0.20	3	87		61	0.61	9	333	102	1.02	1	0	140	
21	0.21	3	157		62	0.62	9	402	103	1.03	1	0	210	
22	0.22	3	227		63	0.63	10	35	104	1.04	1	0	280	
23	0.23	3	297		64	0.64	10	105	105	1.05	1	0	350	
24	0.24	3	367		65	0.65	10	175	106	1.06	1	0	420	
25	0.25	4	0		66	0.66	10	245	107	1.07	1	1	52	
26	0.26	4	70		67	0.67	10	315	108	1.08	1	1	122	
27	0.27	4	140		68	0.68	10	385	109	1.09	1	1	192	
28	0.28	4	210		69	0.69	11	17	110	1.10	1	1	262	
29	0.29	4	280		70	0.70	11	87	111	1.11	1	1	332	
30	0.30	4	350		71	0.71	11	157	112	1.12	1	1	402	
31	0.31	4	420		72	0.72	11	227	113	1.13	1	2	35	
32	0.32	5	52		73	0.73	11	297	114	1.14	1	2	105	
33	0.33	5	122		74	0.74	11	367	115	1.15	1	2	175	
34	0.34	5	192		75	0.75	12	0	116	1.16	1	2	245	
35	0.35	5	262		76	0.76	12	70	117	1.17	1	2	315	
36	0.36	5	332		77	0.77	12	140	118	1.18	1	2	385	
37	0.37	5	402		78	0.78	12	210	119	1.19	1	3	17	
38	0.38	6	35		79	0.79	12	280	120	1.20	1	3	87	
39	0.39	6	105		80	0.80	12	350	121	1.21	1	3	157	
40	0.40	6	175		81	0.81	12	420	122	1.22	1	3	227	
41	0.41	6	245		82	0.82	13	52	123	1.23	1	3	297	

TO CONVERT CUBIC CENTIMETERS OF TEST SOLUTIONS—*Continued*

Cc. of Solution.	Per Cent. on 10 Grams.	Weight per 100 Lbs.			Cc. of Solution.	Per Cent. on 10 Grams.	Weight per 100 Lbs.			Cc. of Solution.	Per Cent. on 10 Grams.	Weight per 100 Lbs.		
		Lbs.	Ozs.	Grs.			Lbs.	Ozs.	Grs.			Lbs.	Ozs.	Grs.
124	1.24	1	3	367	150	1.50	1	8	0	176	1.76	1	12	70
125	1.25	1	4	0	151	1.51	1	8	70	177	1.77	1	12	140
126	1.26	1	4	70	152	1.52	1	8	140	178	1.78	1	12	210
127	1.27	1	4	140	153	1.53	1	8	210	179	1.79	1	12	280
128	1.28	1	4	210	154	1.54	1	8	280	180	1.80	1	12	350
129	1.29	1	4	280	155	1.55	1	8	350	181	1.81	1	12	420
130	1.30	1	4	350	156	1.56	1	8	420	182	1.82	1	13	52
131	1.31	1	4	420	157	1.57	1	9	52	183	1.83	1	13	122
132	1.32	1	5	52	158	1.58	1	9	122	184	1.84	1	13	192
133	1.33	1	5	122	159	1.59	1	9	192	185	1.85	1	13	262
134	1.34	1	5	192	160	1.60	1	9	262	186	1.86	1	13	332
135	1.35	1	5	262	161	1.61	1	9	332	187	1.87	1	13	402
136	1.36	1	5	332	162	1.62	1	9	402	188	1.88	1	14	35
137	1.37	1	5	402	163	1.63	1	10	35	189	1.89	1	14	105
138	1.38	1	6	35	164	1.64	1	10	105	190	1.90	1	14	175
139	1.39	1	6	105	165	1.65	1	10	175	191	1.91	1	14	245
140	1.40	1	6	175	166	1.66	1	10	245	192	1.92	1	14	315
141	1.41	1	6	245	167	1.67	1	10	315	193	1.93	1	14	385
142	1.42	1	6	315	168	1.68	1	10	385	194	1.94	1	15	17
143	1.43	1	6	385	169	1.69	1	11	17	195	1.95	1	15	87
144	1.44	1	7	17	170	1.70	1	11	87	196	1.96	1	15	157
145	1.45	1	7	87	171	1.71	1	11	157	197	1.97	1	15	227
146	1.46	1	7	157	172	1.72	1	11	227	198	1.98	1	15	297
147	1.47	1	7	227	173	1.73	1	11	297	199	1.99	1	15	367
148	1.48	1	7	297	174	1.74	1	11	367	200	2.00	2	0	0
149	1.49	1	7	367	175	1.75	1	12	0	300	3.00	3	0	0

Example.—To obtain 0.67 per cent of dyestuff on a 10-gram test skein of wool or cotton, when the solution contains 1 gram of dyestuff per liter, it would be necessary to take 67 cc. of the solution; and for the dyeing of 100 lbs. of goods this would be equivalent to 10 oz. 315 grs. of dyestuff.

In case a 5-gram test skein is used, the above figures in the percentage and weight columns are to be multiplied by 2. For instance, 1.34 per cent of dyestuff would be equivalent to 67 cc. of the solution, or to 1 lb. 5 ozs. 193 grs. on 100 lbs. of material.

In case the dyestuff solution contains more than 1 gram per liter, it will be necessary to multiply the figures in the percentage and weight columns by the number of grams per liter of the solution. For instance, if the solution contains 5 grams per liter 67 cc. would be equivalent to 3.35 per cent, or to 3 lbs. 5 ozs. 262 grs. on 100 lbs., if a 10-gram test skein is used. If a 5-gram test skein be used, 67 cc. of such a solution would be equivalent to 6.70 per cent, or to 6 lbs. 11 ozs. 87 grs. on 100 lbs. of goods.

TO CONVERT PERCENTAGE OF COLOR (ON 100 LBS. OF GOODS)
INTO QUANTITY OF STANDARD SOLUTION OF 4 OZS. OF DRY
COLOR PER GALLON

Weight. Lbs.	Per Cent.	Solution of 4 Ounces per Gallon.			
		Quarts.	Pints.	Gills.	Noggins.
100	$\frac{1}{10}$	1	1	$1\frac{6}{10}$
100	$\frac{1}{8}$	2
100	$\frac{1}{6}$	3	1	$1\frac{1}{3}$
100	$\frac{1}{4}$	4
100	$\frac{1}{2}$	8
100	1	16

2 noggins = 1 gill

2 pints = 1 quart

4 gills = 1 pint

4 quarts = 1 gallon

Convenient data regarding quantities of water based on U. S. gallon:

1 gallon = 231 cubic inches = 8.3 lb.

$\frac{1}{4}$ quart = 57.75 cubic inches = 2.1 lb.

1 pint = 28.88 cubic inches = 1.0 lb.

1 gill = 7.22 cubic inches = .25 lb.

1 cubic foot = 17.28 cubic inches = 62.5 lb. = 7.5 gallons

1 cubic inch = .036 lb.

REDUCTION OF GRAMS TO OUNCES PER 100 LBS. GOODS

Grams.	Ounces for Solution.	Grams.	Ounces for Solution.	Grams.	Ounces for Solution.
1	.35	11	3.88	21	7.41
2	.71	12	4.24	22	7.76
3	1.06	13	4.58	23	8.12
4	1.41	14	4.93	24	8.47
5	1.77	15	5.29	25	8.82
6	2.12	16	5.64	26	9.17
7	2.47	17	5.99	27	9.53
8	2.83	18	6.34	28	9.88
9	3.18	19	6.60	29	10.22
10	3.53	20	7.06	30	10.59

To use any number of grams per 100 lbs. of goods, dissolve the corresponding number of ounces in above table in 10 gallons of water, and use 1 gallon of this solution per 100 lbs. goods.

For Example.—To use 42 grams of dyestuff per 100 lbs. goods:

30 grams = 10.59 ozs.

10 grams = 3.53 ozs.

2 grams = .71 oz.

42 grams = 14.83 ozs.

Therefore, dissolve 14.83 ozs. of dyestuff in 10 gallons of water and use 1 gallon of the solution.

REDUCTION OF GRAMS PER KILOGRAM OF GOODS TO OUNCES PER 100 LBS. OF GOODS

Grams per Kilo.	Ounces per 100 Lbs.	Grams per Kilo.	Ounces per 100 Lbs.	Grams per Kilo.	Ounces per 100 Lbs.
1	1.6	18	28.8	35	56.0
2	3.2	19	30.4	36	57.6
3	4.8	20	32.0	37	59.2
4	6.4	21	33.6	38	60.8
5	8.0	22	35.2	39	62.4
6	9.6	23	36.8	40	64.0
7	11.2	24	38.4	41	65.6
8	12.8	25	40.0	42	67.2
9	14.4	26	41.6	43	68.8
10	16.0	27	43.2	44	70.4
11	17.6	28	44.8	45	72.0
12	19.2	29	46.4	46	73.6
13	20.8	30	38.0	47	75.2
14	22.4	31	49.6	48	76.8
15	24.0	32	51.2	49	78.4
16	25.6	33	52.8	50	80.0
17	27.2	34	54.4		

To convert grams per kilo into ounces per 100 lbs. multiply by the factor 1.6.

REDUCTION OF FRACTIONAL PERCENTAGES TO OUNCES PER 100 LBS. OF GOODS

Per Cent.	Ounces per 100 Lbs. Goods.	Per Cent.	Ounces per 100 Lbs. Goods.	Per Cent.	Ounces per 100 Lbs. Goods.	Per Cent.	Ounces per 100 Lbs. Goods.
$\frac{1}{2}$	8.00	$\frac{1}{8}$	2.00	$\frac{5}{11}$	7.28	$\frac{9}{13}$	11.11
		$\frac{3}{8}$	6.00	$\frac{6}{11}$	8.73	$\frac{10}{13}$	12.31
$\frac{1}{3}$	5.33	$\frac{5}{8}$	10.00	$\frac{7}{11}$	10.19	$\frac{11}{13}$	13.54
$\frac{2}{3}$	10.66	$\frac{7}{8}$	14.00	$\frac{8}{11}$	11.64	$\frac{12}{13}$	14.77
				$\frac{9}{11}$	13.09		
$\frac{1}{4}$	4.00		1.77	$\frac{10}{11}$	14.55	$\frac{1}{14}$	1.14
$\frac{3}{4}$	12.00	$\frac{1}{9}$	3.55			$\frac{3}{14}$	3.44
		$\frac{2}{9}$	7.11			$\frac{5}{14}$	5.72
$\frac{1}{5}$	3.20	$\frac{4}{9}$	8.88	$\frac{1}{12}$	1.34	$\frac{9}{14}$	10.29
$\frac{2}{5}$	6.40	$\frac{5}{9}$	12.44	$\frac{5}{12}$	6.66	$\frac{11}{14}$	10.57
$\frac{3}{5}$	9.60	$\frac{7}{9}$	14.22	$\frac{7}{12}$	9.33	$\frac{11}{14}$	14.86
$\frac{4}{5}$	12.80	$\frac{8}{9}$		$\frac{11}{12}$	14.66	$\frac{13}{14}$	
$\frac{1}{6}$	2.66	$\frac{1}{10}$	1.60			$\frac{1}{15}$	1.07
$\frac{5}{6}$	13.30	$\frac{3}{10}$	4.80	$\frac{1}{13}$	1.23	$\frac{2}{15}$	2.13
		$\frac{7}{10}$	11.20	$\frac{2}{13}$	2.46	$\frac{4}{15}$	4.27
$\frac{1}{7}$	2.29	$\frac{9}{10}$	14.40	$\frac{3}{13}$	3.69	$\frac{6}{15}$	6.40
$\frac{2}{7}$	4.58			$\frac{4}{13}$	4.92	$\frac{7}{15}$	7.47
$\frac{3}{7}$	6.86	$\frac{1}{11}$	1.45	$\frac{5}{13}$	6.16	$\frac{8}{15}$	8.53
$\frac{4}{7}$	9.15	$\frac{2}{11}$	2.91	$\frac{6}{13}$	7.39	$\frac{11}{15}$	11.73
$\frac{5}{7}$	11.43	$\frac{3}{11}$	4.37	$\frac{7}{13}$	8.61	$\frac{13}{15}$	13.87
$\frac{6}{7}$	13.80	$\frac{4}{11}$	5.82	$\frac{8}{13}$	9.85	$\frac{14}{15}$	14.96

REDUCTION OF DECIMAL PERCENTAGES TO OUNCES PER 100 LBS. OF GOODS

Per Cent.	Ounces per 100 Lbs. Goods.	Per Cent.	Ounces per 100 Lbs. Goods.	Per Cent.	Ounces per 100 Lbs. Goods.	Per Cent.	Ounces per 100 Lbs. Goods.
.10	1.60	.35	5.60	.60	9.60	.85	13.60
.15	2.40	.40	6.40	.65	10.40	.90	14.40
.20	3.20	.45	7.20	.70	11.20	.95	15.20
.25	4.00	.50	8.00	.75	12.00	1.00	16.00
.30	4.80	.55	8.80	.80	12.80

REDUCTION OF DECIMAL PARTS OF POUNDS TO OUNCES

Lbs.	Ozs.	Lbs.	Ozs.	Lbs.	Ozs.	Lbs.	Ozs.
.01	.16	.14	2.24	.27	4.32	.40	6.40
.02	.32	.15	2.40	.28	4.48	.41	6.56
.03	.48	.16	2.56	.29	4.64	.42	6.72
.04	.64	.17	2.72	.30	4.80	.43	6.88
.05	.80	.18	2.88	.31	4.96	.44	7.04
.06	.96	.19	3.04	.32	5.12	.45	7.20
.07	1.12	.20	3.20	.33	5.28	.46	7.36
.08	1.28	.21	3.36	.34	5.44	.47	7.52
.09	1.44	.22	3.52	.35	5.60	.48	7.68
.10	1.60	.23	3.68	.36	5.76	.49	7.84
.11	1.76	.24	3.84	.37	5.92	.50	8.00
.12	1.92	.25	4.00	.38	6.08
.13	2.08	.26	4.16	.39	6.24

REDUCTION OF DECIMAL PERCENTAGES OF GALLONS TO QUARTS AND PINTS

Gals.	Qts.	Pts.	Gals.	Qts.	Pts.	Gals.	Qts.	Pts.
.05	$\frac{2}{8}$.40	1	$1\frac{1}{2}$.75	3
.10	$\frac{4}{8}$.45	1	$1\frac{3}{8}$.80	3	$\frac{2}{8}$
.15	$1\frac{1}{8}$.50	285	3	$\frac{4}{8}$
.20	$1\frac{2}{8}$.55	2	$\frac{3}{8}$.90	3	$1\frac{1}{8}$
.25	160	2	$\frac{4}{8}$.95	3	$1\frac{2}{8}$
.30	1	$\frac{2}{8}$.65	2	$1\frac{1}{8}$	1.00	4
.35	1	$\frac{4}{8}$.70	2	$1\frac{3}{8}$

REDUCTION OF LITERS PER KILOGRAM OF GOODS TO GALLONS PER 100 LBS. OF GOODS

Liters per Kilo.	Gallons per 100 Lbs.	Liters per Kilo.	Gallons per 100 Lbs.	Liters per Kilo.	Gallons per 100 Lbs.	Liters per Kilo.	Gallons per 100 Lbs.
1	11.99	14	167.88	27	323.78	40	479.68
2	23.98	15	179.88	28	335.77	41	491.67
3	35.97	16	191.87	29	347.76	42	503.66
4	47.96	17	203.86	30	359.76	43	515.65
5	59.96	18	215.85	31	371.75	44	527.64
6	71.95	19	227.84	32	383.74	45	539.64
7	83.94	20	239.84	33	395.73	46	551.63
8	95.93	21	251.83	34	407.72	47	563.62
9	107.92	22	263.82	35	419.72	48	575.61
10	119.92	23	275.81	36	431.71	49	587.60
11	131.91	24	287.80	37	443.70	50	599.60
12	143.90	25	299.80	38	455.69
13	155.89	26	311.79	39	467.68

REDUCTION OF GRAMS PER LITER TO OUNCES PER GALLON

Grams per Liter.	Ounces per Gallon.	Grams per Liter.	Ounces Per Gallon.	Grams per Liter.	Ounces per Gallon.	Grams per Liter.	Ounces per Gallon.
1	.13	9	1.20	17	2.26	25	3.33
2	.26	10	1.33	18	2.40	26	3.46
3	.40	11	1.46	19	2.53	27	3.60
4	.53	12	1.60	20	2.66	28	3.73
5	.66	13	1.73	21	2.80	29	3.86
6	.80	14	1.86	22	2.93	30	4.00
7	.93	15	2.00	23	3.06
8	1.06	16	2.13	24	3.20

To convert grams per liter into ounces per gallon, multiply by the factor 0.133.

PERCENTAGE TABLES

Per Cent.	For 10 Lbs.	For 50 Lbs.	For 100 Lbs.
10.0	1 lb.	5 lbs.	10 lbs.
9.0	14 oz. 175 grains	4½ lbs.	9 lbs.
8.0	12 oz. 350 grains	4 lbs.	8 lbs.
7.0	11 oz. 87 grains	3½ lbs.	7 lbs.
6.0	9 oz. 263 grains	3 lbs.	6 lbs.
5.0	8 oz.	2½ lbs.	5 lbs.
4.0	6 oz. 175 grains	2 lbs.	4 lbs.
3.0	4 oz. 350 grains	1½ lbs.	3 lbs.
2.0	3 oz. 88 grains	1 lb.	2 lbs.
1.0	1 oz. 263 grains	8 oz.	1 lb.
0.99	1 oz. 256 grains	7 oz. 403 grains	15 oz. 368 grains
0.98	1 oz. 249 grains	7 oz. 368 grains	15 oz. 298 grains
0.97	1 oz. 242 grains	7 oz. 333 grains	15 oz. 228 grains
0.96	1 oz. 235 grains	7 oz. 298 grains	15 oz. 158 grains
0.95	1 oz. 228 grains	7 oz. 233 grains	15 oz. 88 grains
0.94	1 oz. 221 grains	7 oz. 228 grains	15 oz. 18 grains
0.93	1 oz. 214 grains	7 oz. 193 grains	14 oz. 385 grains
0.92	1 oz. 207 grains	7 oz. 158 grains	14 oz. 315 grains
0.91	1 oz. 200 grains	7 oz. 123 grains	14 oz. 245 grains
0.90	1 oz. 193 grains	7 oz. 88 grains	14 oz. 175 grains
0.89	1 oz. 186 grains	7 oz. 53 grains	14 oz. 105 grains
0.88	1 oz. 179 grains	7 oz. 18 grains	14 oz. 35 grains
0.87	1 oz. 172 grains	6 oz. 420 grains	13 oz. 403 grains
0.86	1 oz. 165 grains	6 oz. 385 grains	13 oz. 333 grains
0.85	1 oz. 158 grains	6 oz. 350 grains	13 oz. 263 grains
0.84	1 oz. 151 grains	6 oz. 315 grains	13 oz. 193 grains
0.83	1 oz. 144 grains	6 oz. 280 grains	13 oz. 123 grains
0.82	1 oz. 137 grains	6 oz. 245 grains	13 oz. 53 grains
0.81	1 oz. 130 grains	6 oz. 210 grains	12 oz. 420 grains
0.80	1 oz. 123 grains	6 oz. 175 grains	12 oz. 350 grains
0.79	1 oz. 116 grains	6 oz. 140 grains	12 oz. 280 grains
0.78	1 oz. 109 grains	6 oz. 105 grains	12 oz. 210 grains
0.77	1 oz. 102 grains	6 oz. 70 grains	12 oz. 140 grains
0.76	1 oz. 95 grains	6 oz. 35 grains	12 oz. 70 grains

PERCENTAGE TABLES—Continued

Per Cent.	For 10 Lbs.	For 50 Lbs.	For 100 Lbs.
0.75	1 oz. 88 grains	6 oz.	12 oz.
0.74	1 oz. 81 grains	5 oz. 403 grains	11 oz. 368 grains
0.73	1 oz. 74 grains	5 oz. 368 grains	11 oz. 298 grains
0.72	1 oz. 67 grains	5 oz. 333 grains	11 oz. 228 grains
0.71	1 oz. 60 grains	5 oz. 298 grains	11 oz. 158 grains
0.70	1 oz. 53 grains	5 oz. 263 grains	11 oz. 88 grains
0.69	1 oz. 46 grains	5 oz. 228 grains	11 oz. 18 grains
0.68	1 oz. 39 grains	5 oz. 193 grains	10 oz. 385 grains
0.67	1 oz. 32 grains	5 oz. 158 grains	10 oz. 315 grains
0.66	1 oz. 25 grains	5 oz. 123 grains	10 oz. 245 grains
0.65	1 oz. 18 grains	5 oz. 88 grains	10 oz. 175 grains
0.64	1 oz. 11 grains	5 oz. 53 grains	10 oz. 105 grains
0.63	1 oz. 4 grains	5 oz. 18 grains	10 oz. 135 grains
0.62	434 grains	4 oz. 420 grains	9 oz. 403 grains
0.61	427 grains	4 oz. 385 grains	9 oz. 333 grains
0.60	420 grains	4 oz. 350 grains	9 oz. 263 grains
0.59	413 grains	4 oz. 315 grains	9 oz. 193 grains
0.58	406 grains	4 oz. 280 grains	9 oz. 123 grains
0.57	399 grains	4 oz. 245 grains	9 oz. 53 grains
0.56	392 grains	4 oz. 210 grains	8 oz. 420 grains
0.55	385 grains	4 oz. 175 grains	8 oz. 350 grains
0.54	378 grains	4 oz. 140 grains	8 oz. 280 grains
0.53	371 grains	4 oz. 105 grains	8 oz. 210 grains
0.52	364 grains	4 oz. 70 grains	8 oz. 140 grains
0.51	357 grains	4 oz. 35 grains	8 oz. 70 grains
0.50	350 grains	4 oz.	8 oz.
0.49	343 grains	3 oz. 403 grains	7 oz. 368 grains
0.48	336 grains	3 oz. 368 grains	7 oz. 298 grains
0.47	329 grains	3 oz. 333 grains	7 oz. 228 grains
0.46	322 grains	3 oz. 298 grains	7 oz. 158 grains
0.45	315 grains	3 oz. 263 grains	7 oz. 88 grains
0.44	308 grains	3 oz. 228 grains	7 oz. 18 grains
0.43	301 grains	3 oz. 193 grains	6 oz. 385 grains
0.42	294 grains	3 oz. 158 grains	6 oz. 315 grains
0.41	287 grains	3 oz. 123 grains	6 oz. 245 grains

PERCENTAGE TABLES—Continued

Per Cent.	For 10 Lbs.	For 50 Lbs.	For 100 Lbs.
0.40	280 grains	3 oz. 88 grains	6 oz. 175 grains
0.39	273 grains	3 oz. 53 grains	6 oz. 105 grains
0.38	266 grains	3 oz. 18 grains	6 oz. 35 grains
0.37	259 grains	2 oz. 420 grains	5 oz. 403 grains
0.36	252 grains	2 oz. 385 grains	5 oz. 333 grains
0.35	245 grains	2 oz. 350 grains	5 oz. 263 grains
0.34	238 grains	2 oz. 315 grains	5 oz. 193 grains
0.33	231 grains	2 oz. 280 grains	5 oz. 123 grains
0.32	224 grains	2 oz. 245 grains	5 oz. 53 grains
0.31	217 grains	2 oz. 210 grains	4 oz. 420 grains
0.30	210 grains	2 oz. 175 grains	4 oz. 350 grains
0.29	203 grains	2 oz. 140 grains	4 oz. 280 grains
0.28	196 grains	2 oz. 105 grains	4 oz. 210 grains
0.27	189 grains	2 oz. 70 grains	4 oz. 140 grains
0.26	182 grains	2 oz. 35 grains	4 oz. 70 grains
0.25	175 grains	2 oz.	4 oz.
0.24	168 grains	1 oz. 403 grains	3 oz. 368 grains
0.23	161 grains	1 oz. 358 grains	3 oz. 298 grains
0.22	154 grains	1 oz. 333 grains	3 oz. 228 grains
0.21	147 grains	1 oz. 298 grains	3 oz. 158 grains
0.20	140 grains	1 oz. 263 grains	3 oz. 88 grains
0.19	133 grains	1 oz. 228 grains	3 oz. 18 grains
0.18	126 grains	1 oz. 193 grains	2 oz. 385 grains
0.17	119 grains	1 oz. 158 grains	2 oz. 315 grains
0.16	112 grains	1 oz. 123 grains	2 oz. 245 grains
0.15	105 grains	1 oz. 88 grains	2 oz. 175 grains
0.14	98 grains	1 oz. 53 grains	2 oz. 105 grains
0.13	91 grains	1 oz. 18 grains	2 oz. 35 grains
0.12	84 grains	420 grains	1 oz. 403 grains
0.11	77 grains	385 grains	1 oz. 333 grains
0.10	70 grains	350 grains	1 oz. 263 grains
0.09	63 grains	315 grains	1 oz. 193 grains
0.08	56 grains	280 grains	1 oz. 123 grains
0.07	49 grains	245 grains	1 oz. 53 grains
0.06	42 grains	210 grains	420 grains

PERCENTAGE TABLES—Continued

Per Cent.	For 10 Lbs.	For 50 Lbs.	For 100 Lbs.
0.05	35 grains	175 grains	350 grains
0.04	28 grains	140 grains	280 grains
0.03	21 grains	105 grains	210 grains
0.02	14 grains	70 grains	140 grains
0.01	7 grains	35 grains	70 grains

The following example will illustrate the use of this table: How much dyestuff would be required for 2.23 per cent on 70 lbs. of material?

{	For 50 lbs.	2% equals 1 lb.	
	For 20 lbs.	2% equals	6 oz. 176 grains
{	For 50 lbs.	0.23% equals	1 oz. 368 grains
	For 20 lbs.	0.23% equals	322 grains

For 70 lbs. 2.23% equals 1 lb. 8 oz. 429 grains

TABLE SHOWING THE AMOUNTS OF SODIUM NITRITE, ACID, AND DEVELOPER REQUIRED FOR DIAZOTIZING

Dyestuff. Per Cent.	Sodium Nitrite. Per Cent.	Sulphuric Acid 168° Tw. Per Cent.	Or Hydrochloric Acid in Place of Sulphuric. Per Cent.	Developer. Per Cent.
$\frac{1}{2}$	1	2	3	0.5
1	1 $\frac{1}{2}$	2 $\frac{1}{2}$	3 $\frac{1}{2}$	0.6
1 $\frac{1}{2}$	1 $\frac{1}{2}$	3	4 $\frac{1}{2}$	0.7
2	1 $\frac{3}{4}$	3 $\frac{1}{2}$	5 $\frac{1}{4}$	0.8
2 $\frac{1}{2}$	2	4	6	0.9
3	2	4	6	1.
3 $\frac{1}{2}$	2 $\frac{1}{2}$	5	7 $\frac{1}{2}$	1.
4	2 $\frac{1}{2}$	5	7 $\frac{1}{2}$	1.
4 $\frac{1}{2}$	2 $\frac{1}{2}$	5	7 $\frac{1}{2}$	1.
5	2 $\frac{1}{2}$	5	7 $\frac{1}{2}$	1.

These figures are not supposed to be in exact chemical proportion, but for practical reasons a sufficient excess of developer is prescribed. Good results are to be obtained from these quantities only when the proportion of dyed material to water is 1 : 15.

TABLE OF ATOMIC WEIGHTS OF PRINCIPAL ELEMENTS

O = 16

Element.	Symbol.	At. Wt.	Element.	Symbol.	At. Wt.
Aluminium.....	Al	27.1	Magnesium.....	Mg	24.36
Antimony.....	Sb	120.	Manganese.....	Mn	55.
Arsenic.....	As	75.	Mercury.....	Hg	203.
Barium.....	Ba	137.4	Molybdenum.....	Mo	96.
Bismuth.....	Bi	208.5	Nickel.....	Ni	58.7
Boron.....	B	11.	Nitrogen.....	N	14.04
Bromine.....	Br	79.96	Oxygen.....	O	16.
Cadmium.....	Cd	112.4	Phosphorus.....	P	31.
Calcium.....	Ca	40.	Platinum.....	Pt	194.8
Carbon.....	C	12.	Potassium.....	K	39.15
Cerium.....	Ce	140.	Silicon.....	Si	28.4
Chlorine.....	Cl	35.5	Silver.....	Ag	107.93
Chromium.....	Cr	52.1	Sodium.....	Na	23.05
Cobalt.....	Co	59.	Strontium.....	Sr	87.6
Copper.....	Cu	63.6	Sulphur.....	S	32.06
Fluorine.....	Fl	19.	Tin.....	Sn	118.5
Gold.....	Au	197.2	Titanium.....	Ti	48.
Hydrogen.....	H	1.01	Tungsten.....	W	184.
Iodine.....	I	126.85	Uranium.....	U	239.5
Iron.....	Fe	56.	Vanadium.....	V	51.2
Lead.....	Pb	206.9	Zinc.....	Zn	65.4

TABLE OF FORMULA AND MOLECULAR WEIGHTS OF PRINCIPAL CHEMICALS USED IN DYEING

Name.	Formula.	Mol. Wt.
Acetate of alumina.....	$Al_2(C_2H_3O_2)_2$	408
Acetate of ammonia.....	$NH_4C_2H_3O_2$	77
Acetate of chrome (basic).....	$Cr_2(C_2H_3O_2)_4 \cdot (OH)_2$	374
Acetate of chrome (normal).....	$Cr_2(C_2H_3O_2)_6$	458
Acetate of lime.....	$Ca(C_2H_3O_2)_2$	158
Acetate of nickel.....	$Ni(C_2H_3O_2)_2$	177
Acetate of soda.....	$NaC_2H_3O_2 \cdot 3H_2O$	136
Acetate of tin.....	$Sn(C_2H_3O_2)_2$	237
Acetic acid.....	$CH_3 \cdot COOH$	60
Acetine.....	$C_3H_5(C_2H_3O_2)_3$	218
Acid sodium sulphate.....	$NaHSO_4$	120
Acid sodium sulphite.....	$NaHSO_3$	104
Alcohol.....	C_2H_5OH	46
Alpha-naphthylamine.....	$C_{10}H_7NH_2$	143
Alum (potash).....	$Al_2(SO_4)_3K_2SO_4 \cdot 24H_2O$	949
Aluminium chloride.....	Al_2Cl_6	267
Aluminium sulpho-acetate.....	$Al_2SO_4(C_2H_3O_2)_4$	386
Ammonia.....	NH_3	17

TABLE OF FORMULA AND MOLECULAR WEIGHTS OF PRINCIPAL CHEMICALS USED IN DYEING—*Continued*

Name.	Formula.	Mol. Wt.
Ammonium chloride	NH_4Cl	54
Ammonium tin chloride	$\text{SnCl}_4 \cdot 2\text{NH}_4\text{Cl}$	367
Ammonium vanadate	$(\text{NH}_4)_3\text{VO}_4$	169
Aniline	$\text{C}_6\text{H}_5\text{NH}_2$	93
Aniline salt	$\text{C}_6\text{H}_5\text{NH}_2 \cdot \text{HCl}$	130
Antimony fluoride	SbF_3	177
Antimony oxide	Sb_2O_3	288
Antimony salt	$\text{SbF}_3(\text{NH}_4)_2\text{SO}_4$	309
Antimony sodium fluoride	SbF_3NaF	219
Barium chloride	$\text{BaCl}_2 \cdot 2\text{H}_2\text{O}$	244
Benzene	C_6H_6	78
Beta-naphthol	$\text{C}_{10}\text{H}_7 \cdot \text{OH}$	144
Bichromate of soda	$\text{Na}_2\text{Cr}_2\text{O}_7 \cdot 2\text{H}_2\text{O}$	298
Bichromate of potash	$\text{K}_2\text{Cr}_2\text{O}_7$	295
Bisulphite of chrome	$\text{Cr}_2(\text{HSO}_3)_6$	591
Borax	$\text{Na}_2\text{B}_4\text{O}_7 \cdot 10\text{H}_2\text{O}$	382
Calcium chloride	CaCl_2	111
Caustic lime	CaO	56
Caustic soda	NaOH	40
Caustic potash	KOH	56
Cerium chloride	CeCl_3	246
Chalk	CaCO_3	100
Chlorate of alumina	$\text{Al}_2(\text{ClO}_3)_6$	555
Chloride of chrome (basic)	$\text{Cr}_2\text{Cl}_2(\text{OH})_4$	243
Chlorate of potash	KClO_3	123
Chlorate of sodium	NaClO_3	107
Chromate of chrome	$\text{Cr}_2(\text{CrO}_4)_3$	453
Chromate of lead	PbCrO_4	323
Chrome alum	$\text{Cr}_2(\text{SO}_4)_3 \cdot \text{K}_2\text{SO}_4 \cdot 24\text{H}_2\text{O}$	999
Chrome oxide	Cr_2O_3	152
Chromium nitro-acetate	$\text{Cr}_2(\text{NO}_3)_3(\text{C}_2\text{H}_3\text{O}_2)_3$	467
Common salt	NaCl	59
Cupric chloride	$\text{CuCl}_2 \cdot 2\text{H}_2\text{O}$	171
Double chloride of tin	$\text{SnCl}_4 \cdot 3\text{H}_2\text{O}$	314
Ferric acetate	$\text{Fe}_2(\text{C}_2\text{H}_3\text{O}_2)_6$	466
Ferric chloride	Fe_2Cl_6	325
Ferrous acetate	$\text{Fe}(\text{C}_2\text{H}_3\text{O}_2)_2$	174
Ferrous chloride	FeCl_2	127
Ferrous sulphate	$\text{FeSO}_4 \cdot 7\text{H}_2\text{O}$	278
Fluoride of chrome	$\text{Cr}_2\text{F}_6 \cdot 8\text{H}_2\text{O}$	362
Glaubersalt	$\text{Na}_2\text{SO}_4 \cdot 10\text{H}_2\text{O}$	322
Glycerin	$\text{C}_3\text{H}_5(\text{OH})_3$	92
Hydrate of alumina	$\text{Al}_2(\text{OH})_6$	541
Hydrochloric acid	HCl	36
Hydrofluoric acid	HF	20
Hyposulphite of soda	$\text{Na}_2\text{S}_2\text{O}_3 \cdot 5\text{H}_2\text{O}$	248

TABLE OF FORMULA AND MOLECULAR WEIGHTS OF PRINCIPAL CHEMICALS USED IN DYEING—*Continued*

Name.	Formula.	Mol. Wt.
Lactic acid	$C_3H_5O_3$	90
Magnesium chloride	$MgCl_2 \cdot 6H_2O$	203
Manganese chloride	$MnCl_2 \cdot 4H_2O$	198
Nitrate of chrome	$Cr_2(NO_3)_6$	476
Nitrate of lead	$Pb(NO_3)_2$	331
Nitric acid	HNO_3	63
Oxalate of ammonia	$(NH_4)_2C_2O_4 \cdot H_2O$	142
Oxalate of antimony	$Sb(C_2O_4K)_3 \cdot 6H_2O$	610
Oxalic acid	$C_2O_4H_2 \cdot 2H_2O$	126
Oxide of lead	PbO	223
Paranitraniline	$C_6H_4(NO_2)NH_2$	138
Permanganate of potash	$KMnO_4$	158
Peroxide of hydrogen	H_2O_2	34
Phenol	C_6H_5OH	94
Phosphate of soda	$Na_2HPO_4 \cdot 12H_2O$	354
Potash	$K_2CO_3 \cdot 2H_2O$	174
Potassium oxalate	KHC_2O_4	128
Red prussiate	$K_6Fe_2(CN)_{12}$	659
Resorcine	$C_6H_4(OH)_2$	110
Silicate of soda	$Na_2Si_2O_7$	304
Sugar of lead	$Pb(C_2H_3O_2)_2 \cdot 3H_2O$	379
Sulphate of alumina	$Al_2(SO_4)_3 \cdot 18H_2O$	667
Sulphate of cadmium	$CdSO_4 \cdot 2H_2O$	244
Sulphate of copper	$CuSO_4 \cdot 5H_2O$	250
Sulphate of lead	$PbSO_4$	302
Sulphate of magnesium	$MgSO_4 \cdot 7H_2O$	247
Sulphate of nickel	$NiSO_4 \cdot 7H_2O$	281
Sulphate of zinc	$ZnSO_4 \cdot 7H_2O$	288
Sulphocyanide of ammonia	NH_4SCN	76
Sulphocyanide of copper	$Cu(SCN)_2$	180
Sulphocyanide of iron	$Fe(SCN)_2$	172
Sulphocyanide of potash	$KSCN$	97
Sulphuric acid (Oil of vitriol)	H_2SO_4	98
Sulphurous acid	SO_2	64
Soda calcined (soda ash)	Na_2CO_3	106
Soda crystallized	$Na_2CO_3 \cdot 10H_2O$	286
Sodium aluminate	$Na_6Al_2O_6$	289
Sodium bisulphite	$NaHSO_3$	104
Sodium hydrosulphite crystallized	$Na_2S_2O_4 \cdot 2H_2O$	194
Sodium nitrite	$NaNO_2$	69
Sodium peroxide	Na_2O_2	78
Sodium sulphide crystallized	$Na_2S \cdot 9H_2O$	240
Stannate of soda	Na_2SnO_3	213
Stannic hydrate	$SnO(OH)_2$	169
Stannous hydrate	$Sn(OH)_2$	153
Tannin	$C_{14}H_{10}O_9$	322

TABLE OF FORMULA AND MOLECULAR WEIGHTS OF PRINCIPAL CHEMICALS USED IN DYEING—*Continued*

Name.	Formula.	Mol. Wt.
Tartar.....	$\text{KH}(\text{C}_4\text{H}_4\text{O}_6)$	188
Tartar emetic.....	$\text{K}(\text{SbO})\text{C}_4\text{H}_4\text{O}_6 \cdot \frac{1}{2}\text{H}_2\text{O}$	332
Tartar substitute.....	NaHSO_4	120
Tartaric acid.....	$\text{C}_4\text{H}_6\text{O}_6$	150
Thiosulphate of soda.....	$\text{Na}_2\text{S}_2\text{O}_3 \cdot 5\text{H}_2\text{O}$	248
Tin chloride.....	SnCl_4	260
Tin salt.....	$\text{SnCl}_2 \cdot 2\text{H}_2\text{O}$	225
Tungstate of soda.....	$\text{Na}_2\text{WO}_4 \cdot 2\text{H}_2\text{O}$	330
Water.....	H_2O	18
Yellow prussiate.....	$\text{K}_4\text{Fe}(\text{CN})_6 \cdot 3\text{H}_2\text{O}$	423
Zinc chloride.....	ZnCl_2	136

BIBLIOGRAPHY

- Able, E. Hypochlorite und elektrische Bleiche. Theoretischer Teil. H. a. S., 1905.
- Actien-Gesellschaft für Anilin-Fabrikation. The coloring matters of the A. G. A. F., their properties and application in textile dyeing. Berlin, 1904.
- Aix, F. Die gesammte moderne Hutfärberei mit besond. Berücksicht. der Fabrikationswege. Berlin, 1909.
- Ambourney, L. A. d'. Recueil de procédés et d'expériences sur les teintures solides que nos végétaux indigènes communiquent aux laines et aux lainages. Paris, 1793.
- Andés, L. E. Wasch-, Bleich-, Blau-, Stärke- und Glanzmittel. Wien, 1909.
- Angaryd, E. H. Fortschritte, etc., der Wollen-Stückfärberei seit 1877. Leipzig, 1886.
- Anthracene: its constitution, etc., including artificial alizarine, anthrapurpurin, etc., with their applications in dyeing and printing. From the German by W. Crookes. London, 1877.
- Assam Gov't. Monograph on dyes and dyeing in Assam. By W. A. M. Duncan. Shillong, 1896.
- Auerbach, G. Das Anthracen und seine Derivate. Berlin, 1880.
- Axmacher, A. Prakt. Führer durch den Zeugdruck. Hannover, 1908. 2 vols.
- Badische Anilin- und Soda-Fabrik. The aniline colors . . . and their application on wool, cotton, silk, etc. Ludwigshafen-am-Rhein, 1901.
- Anilin- und Soda-Fabrik. The alizarine colors . . . and the irapplication on cotton, wool, silk, etc. Ludwigshafen-am-Rhein, 1901.
- Anilin- und Soda-Fabrik. Indigo pure B. A. S. F. Ludwigshafen-am-Rhein, 1911.
- Baechler, M. Ueber ein Oxydationsprodukt des Alizarins mit Ferricyankalium in alkalischer Lösung. Karlsruhe, 1907.
- Baillot. Nouveau manuel du teinturier . . . contenant diverses recettes pour faire toutes sortes de couleurs sur laine, soie, fil et coton. Paris, 1819.
- Nouveau manuel du teinturier . . . suivi du Manuel de l'art du teinturier-dégraisseur . . . par L. S. Le Normand. Paris.
- Bailly, A. L'industrie du blanchissage et les blanchisseries. Paris, 1896.
- Barnett, E. de B. Coal-tar dyes and intermediates. London, 1919.
- Bancroft, E. Experimental reserchues concerning the philosophy of permanent colors. 2 vols. London, 1813.
- Bayer, F. & Co. Application of dyestuffs in all branches of printing.

- Beacall, T., and others. Dyestuffs and coal-tar products (Reprinted with additions from "Industrial and Manufacturing Chemistry.") New York and London, 1918.
- Bean, P. The chemistry and practice of finishing. Manchester, 1905.
- Bean, P., and Scarisbrick, F. The chemistry and practice of sizing. Manchester, 1906.
- Beaumont, R. Finishing of textile fabrics. London, 1909.
- Becker, F. Die Kunstseide, Halle a. S., 1912.
- Beckers, A. Anilin-Färberei und Druckerei mit Kohlentee-Farbstoffen auf Wolle, Baumwolle und Seide. Neu bearbeitet, etc., von M. Reimann. Leipzig, 1874.
- Beech, F. (i.e., G. H. Hurst). The dyeing of cotton fabrics. London, 1917.
- Beech, F. The dyeing of woollen fabrics. London, 1902.
- Beltzer, F. J. G. La grande industrie tinctoriale. Paris, 1906.
- Industries des poils et fourrures, cheveux et plumes. Paris, 1912.
- Industries des poils et fourrures cheveux. Paris, 1912.
- Benedikt, R. The chemistry of the coal-tar colors. From the German by E. Knecht. London, 1889.
- Die künstlichen Farbstoffe (Teerfarben). Kassel, 1883.
- Berblinger, H. Untersuchungen über Indanthren. Karlsruhe, 1904.
- Berghof, A. Die organischen Farbstoffe theirischen und pflanzlichen Ursprunges und deren Anwendung und der Färberei und Zeugdruckerei. Wien, 1902.
- Berlin Aniline Works. Aktien-Gesellschaft für Anilin-Fabrikation. The dyeing of union fabrics with the coloring-matters of the A. G. A. F. Berlin, 1901. Specimens.
- Bersch, J. Die Fabrikation der Anilinfarbstoffe. . . . und deren Anwendung in der Industrie. Wien, 1878.
- Lexicon der Farben-Technik. Wien, 1902.
- Bersch, W. Die Teerfarbstoffe. Ihre Konstitution, Eigenschaften und Anwendung. 2te Aufl. des Buches "Die Fabrikation der Anilinfarbstoffe," von J. Bersch. Wien, 1912.
- Berthollet, C. L. New method of bleaching by means of oxygenated muriatic acid, etc. From the French by R. Kerr. Edinburgh, 1790.
- Elements of the art of dyeing. (From the French.) Edinburgh, 1792.
- Berthollet, C. L., and A. B. Elements of the art of dyeing and bleaching. From the French. London, 1841.
- The art of dyeing; with the art of bleaching by oxymuriatic acid. London, 1824, 2 vols. (From the French.)
- Bibliographie de la technologie chimique des fibres textiles. Propriétés blanchiment, teinture, matières colorantes, impression, apprêts. Paris, 1893.
- Billig, G. Untersuchung in der Anthrachinon-Reihe. Berlin, 1911.
- Binz, A. Die Küpenfärberei. Neuman, B., and others. Ergänzungswerk zu Muspratt's encykl. Handb. der Chemie.
- Bird, F. J. The American practical dyer's companion. Philadelphia, 1882.
- The dry cleaner and garment dyer. Philadelphia, 1891.
- The dyer's handbook. Recipes for bleaching, dyeing, and finishing. Manchester, 1875.

- Blachette, L. J. *Traité . . . du blanchiment des toiles de lin, de chanvre et de coton.* Paris, 1827.
- Bolley, A. P., and Kopp, E. *Die Teerfarbstoffe.* Braunschweig, 1867-97.
- *Traité des matières colorantes artificielles dérivées du goudron de houille.* Paris, 1874.
- Bortfeldt, C. *Das Steifen der Filzhüte.* Berlin, 1888.
- Bottler, M. *Modern bleaching agents and detergents.* From the German by C. Salter. London, 1910.
- *Färbemethoden der Neuzeit.* Halle a. S., 1910.
- *Die vegetabilischen Faserstoffe.* (Deren Vorkommen, Gewinnung Eigenschaften, technische Verwerthung sowie Bleichen und Färben pflanzliche Faserstoffe.) Wien, 1900.
- *Bleich und Detachiermittel der Neuzeit.* Wittenberg, 1908.
- *Neuerungen in Bleich, Reinigungs und Detachiermitteln.* Wittenberg, 1916.
- *Die anamalischen Faserstoffe.* Umfassend . . . Bleichen und Färben theirischer Faserstoffe. Wien, 1902.
- Boulton, S. B. *Alizarine; an industrial evolution.* London, 1885.
- Brannt, W. T. *The practical dry cleaner, scourer, and garment dyer.* Philadelphia, 1909.
- Brauner, A. *Die Färberei à Ressort, des Färben der Schmuckfedern und die Bearbeitung der Haare.* Wien, 1887.
- Bregha, L. *Handbuch des ges. Baumwoll-Zeugdruckes, sammt Bleicherei und Appretur.* (Text in German and French.) Leipzig, 1880.
- Brooke, Simpson, and Spiller. *Instructions for dyeing (with aniline colors).* London, 1892.
- Brunck, H. *The history of the development of the manufacture of indigo.* (From the German.) New York, 1901.
- Bucherer, H. T. *Die Mineral, Pflanzen und Teerfarben. Ihre Darstellung, Verwendung, Erkennung und Echtheitsprüfung.* Leipzig, 1911.
- Buchholz, W. *Wasser und Seife, oder allgemeines Wäschebuch.* Hamburg, 1866.
- Büchting, J. J. *Färbebuch, oder . . . Anleitung zum Färben der Wolle, Seide, Baumwolle und de Leinens.* Quedlinberg, 1834.
- Bülow, C. *Chemische Technologie der Azofarbstoffe.* Leipzig, 1897. 2 vols. in one.
- Buntrock, A. (Editor) *Zeitschrift für Farben und Textil-Chemie.* Braunschweig.
- Buratti, R. *Aperçus historiques sur l'art de la teinture à travers les siècles.* Turin, 1910.
- Butescu, D. *Einwirkung von Oxalylchlorid auf substituierte Anthracene.* Berlin, 1912.
- Cain, J. C. *The manufacture of intermediate products for dyes.* London, 1918.
- Cain, J. C., and Thorpe, J. F. *The synthetic dyestuffs and the intermediate products from which they are derived.* London, 1913.
- Calvert, F. C. *Paper on cotton, flax, etc., and their bleaching.* London, 1850.
- *On the action of organic acids on cotton and flax fibres.* (Reprint.) Edinburgh, 1855.
- *Dyeing and calico printing.* Manchester, 1876.
- *On the action of gallic and tannic acids in dyeing.* (Reprint.) Edinburgh, 1855.

- Camotier, P. *Traité . . . de tissage* (iv. Teinture et apprêts des tissus). Paris.
- Capron, F. *Manuel du fabricant de bleus et carmins d'indigo*. Paris, 1858.
- Carleton, P. W. *Prices of natural dyestuffs and tanning chemicals during the war*. (Pamphlet.) Washington, 1919.
- Caro, H. *Ueber die Entwicklung der Teer-Farben-Industrie*. Berlin, 1893.
- Carr, H. *Our domestic poisons: or, the poisonous effects of certain dyes and colors used in domestic fabrics*. London, 1879.
- Carter, H. C. *Bleaching, dyeing, and finishing of flax, hemp and jute yarns and fabrics*. London, 1911.
- Cassella, L. & Co. *The diamine colors on raised cotton cloth*. Frankfort-am-Main.
 — *The dyeing of cotton and other vegetable fibres*. Frankfort-am-Main, 1904
 — *The dyeing of wool, including wool printing*. Frankfort-am-Main, 1905
 — *The printing of cotton fabrics*. Frankfort-am-Main, 1905.
 — *Indigo M. L. B.* Frankfort-am-Main.
 — *The diamine colors . . . their properties and application in dyeing and printing*. Frankfort-am-Main, 1895-96.
- Cazeneuve, P. *Répertoire analytique des matières colorantes artificielles*. Lyon, 1893.
- Celnart, Mme. *Manuel du fleuriste artificiel; suivi de l'art du plumassier*. Paris.
- Centner, R. *Die Praxis der Bleicherei und Appretur*. Baumwolle, Leinen, Jute im Rohzustande sowie als Garn, Zwirn und Gewebe. Leipzig.
 — *Die Praxis der Bleicherei und Appretur*. Baumwolle, Leinen, Jute im Rohzustande, sowie als Garn, Zwirn und Gewebe. Leipzig, 1886.
- Chaplet, A. *Le: apprêts textiles*. Paris, 1914.
- Chaplet, A., and Rousset, H. *Le blanchiment*. Chimie et technologie des procédés industriels de blanchiment. Paris, 1910.
 — *Les succédanés de la soie*. Les soies artificielles. Paris, 1909.
 — *Les succédanés de la soie*. Le mercerisage et les machines à merceriser. Paris.
- Chaptal, J. A. *L'art de la teinture du coton en rouge*. Paris, 1807.
- Chateau, T. *Manuel des couleurs d'aniline, d'acide phénique, de naphthaline, etc.* Paris, 1868, 2 vols.
- Chemistry of the organic dyestuffs*. From the German with additions by A. Collin and W. Richardson. London, 1892.
- Chevreul, M. E. *Leçons de chimie appliquée à la teinture*. Paris, 1829-30. 2 vols.
- Crookes, Sir W. *Dyeing and tissue printing*. London, 1882.
 — *A practical handbook of dyeing and calico printing*. London, 1874.
- Dannerth, F. *The methods of textile chemistry*. New York, 1918.
- David, P. *Vollständiges Handbuch der Seidenfärberei*. Aarau, 1855.
- Davis, G. E., and others. *Sizing and mildew in cotton goods*. Manchester, 1880.
- Debruxelles, H. *Défendons les inventeurs Français*. La soie artificielle en cuivre et le accapareurs Allemands. Lille, 1904.
- Dedekind, A. *Ein Beitrag zur Pupurkunde*. Im Anhang: Neue Ausgaben Seltener älterer Schriften über Purpur. Berlin, 1898-1906.
- Delmart, A. *Die Echtfärberei der lösen Wolle*. Reichenburg, 1891. 3 vols.

- Delmart, A., pseud. (i.e. W. Ziernfuss). Die Stück und Kammgarn.-Färberei in ihrem ganzen Umfange. Reichenberg, 1893-1903.
- Dépière, J. Fixage des couleurs par la vapeur. Nouv. Ed. Paris, 1879.
- Impressions et teinture des tissus, blanchiment, blanchissage. Paris, 1889. Forms part of Vol. vi. "Nouvelle technologie des arts et métiers."
- L'impression des tissus, spécialement d'impression à la main à travers les âges et dans les divers pays. Mulhouse, 1910.
- 'Traité des apprêts des tissus de coton. -Paris, 1894.
Treatise on the finishing of cotton goods. (From the French.) Manchester, 1889.
- Traité de la teinture et de l'impression des matières colorantes artificielles. Paris, 1891-1903. 5 vols.
- Die Appretur der Baumwollgewebe. Wein, 1905.
- Depitre, E. La toile peinte en France au xvii et au xviii siècles. Paris, 1912.
- Desbrières, —. Nouveaux secrets des arts et métiers, etc. Paris.
- Diedtmann, J. A. Der Rothpapp und Dampfdruck, oder Anweisung, baumwollene Stoffe in allen Farben zu färben und zu drucken. Weimar, 1855.
- Dollfus-Ausset, D. Matériaux pour la coloration des étoffes. 2 vols. Paris, 1865.
- Dosne, P. Rapport sur les industries chimiques concernant le blanchiment, l'impression, la teinture de fibres textiles, les apprêts, la fabrication des matières colorantes, etc. Notes d'un voyage en Normandie, en Alsace, en Suisse, et à Lyon. Rouen, 1877.
- Dreaper, W. P. The chemistry and physics of dyeing. London, 1906.
- Dubuc, G. Traité sur les parements et encollages dont se servent les tisserands. Rouen, 1829.
- Duerr, G. Bleaching and calico printing. London, 1896.
- Dumas, J. B. A. Précis de l'art de la teinture. Paris, 1846. (Re-issue of "Traité de Chimie appliquée, etc.," with new title.)
- Dussauce, H. Treatise on the coloring matters derived from coal-tar; their practical application in dyeing cotton, wool, and silk. Philadelphia, 1863.
- Dyer and Calico Printer. Cotton finishing. By the Editors. London, 1907.
- A practical manual of cloth finishing. By the Editors. London, 1911.
- Mercerization. By the Editors. London, 1903.
- Dyer and color maker's companion (Receipts). Philadelphia, 1876.
- Eberle, F. Ueber Abkömmlinge des beta-Amido-Anthrachinons. Karlsruhe, 1906.
- Ebert, W., and J. Nussbaum. Hypochlorite und elektrische Bleiche. H. a. S., 1910.
- Edge, J. H. Notes on practical cotton finishing. London, 1911.
- Egner, M. Ueber Ortho-oxidervate des Triphenylcarbinols. Stuttgart, 1913.
- Engelhard, M. Les rouges d'aniline. L'azléine et la fuchsine. Mulhouse, 1861.
- Engelhardt, V. Hypochlorite und Elektrische Bleiche. Halle a. S. Technischer Teil. 1903.
- Eppendahl, F. Die Echtheitsbewegung und der Stand der heutigen Färberei. Berlin, 1912.
- Erban, F. Laboratoriumsbuch für Tinktorial Chemiker, Koloristen . . . in Färbereien, Farben, Lack und Papierfabriken. H. a. S., 1908.
- Theorie und Praxis der Garanfärberei mit den Azo-Entwickeln. Berlin, 1906.

- Erfurt, J. Dyeing of paper pulp. Translated by J. Hübner. London and New York, 1901.
- Ermen, W. F. A. The materials used in sizing, their chemical and physical properties. London, 1912.
- Esslinger, R. Die Fabrikation des Wachstuches . . . sowie die Darstellung der unverbrennlichen und gegerbten Gewebe. Wien.
- Farbwerke vormals Meister, Lucius und Brüning. Instructions for the application of the coal-tar colors. London, 1888.
- Insoluble azo colors produced direct on the cotton fibre. Hoechst-am-Main, 1898.
- The thiogene colors . . . according to the state of the industry in 1904. Hoechst-am-Main, 1915.
- Farrell, F. J. Dyeing and cleaning. 4th ed. London, 1917.
- Favier, B. Nouvelles recherches sur le perfectionnement de l'art de la teinture. Paris, 1806.
- Fay, I. W. The chemistry of the coal-tar dyes. London and New York, 1919.
- Felsen, F. Der Indigo und seine Konkurrenten. Berlin, 1909. Patterns in text.
- Türkischrot und seine Konkurrenten. Berlin, 1911.
- Fernandez, L. Tratado . . . sobre el arte de la tintura. Reglas . . . para tinter sedas, lanas, hilos y esparto en rama. Madrid, 1778.
- Findlay, A. The treasures of coal-tar. New York, 1917.
- Fodor, O. Studien in der Antrachinon-Reihe. Berlin, 1911.
- Fol, F. Guide du teinturier. Paris, 1873.
- Foltzer, J. La soie artificielle et sa fabrication. Cornimont (Vosges), 1909.
- Formánek, J. Spectralanalytischer Nachweis künstlicher organischer Farbstoffe. Berlin, 1900.
- Fort, M., and Lloyd, L. L. The chemistry of dyestuffs. Cambridge, 1917.
- Frankl, E. Die Anilin und Alizarin Färberei, bearbeitet für die Hutbranche. Berlin (1896?)
- Fraps, G. S. Principles of dyeing. (Textile fibres and fabrics.) New York, 1903.
- Ganswindt, A. Die Baumwolle und ihre Verarbeitung in der Mercerisation, Bleicherei und Färberei. Wien, 1917.
- Handb. der Färberei, etc., mit bes. Berücksicht. der Maschinenkunde. Weimar, 1889.
- Theorie und Praxis der modernen Färberei. Leipzig, 1903. 2 vols.
- Die Technologie der Appretur. Wien, 1907.
- Das Färben der Seide, Wollseide, Halbseide und Kunstseide. Wien, 1914.
- Die Gerb- und Farbextrakte. Wien, 1916.
- Einführung in die moderne Färberei, enthaltend die Spinnfasern, die Chemikalien, die gesammten Farbstoffe, etc. Leipzig, 1902.
- Garçon, J. La pratique du teinturier. Paris, 1893-97. 3 vols. in two.
- Encyclopédie universelle des industries tinctoriales et des industries annexes, teinture et impression, blanchiment et apprêts. Paris, 1900.
- Essai de bibliographie générale et raisonnée du blanchiment, de la teinture, etc. Paris, 1890.

- Gardner, J. Bleaching, dyeing and calico printing. London, 1884.
- Gardner, P. Die Mercerisation der Baumwolle. Berlin, 1898.
- Die Mercerisation der Baumwolle und die Appretur der mercerisierten Gewebe. Berlin, 1912.
- Gardner, W. M. The British coal-tar industry; its origin, development, and decline. London, 1915. (A collection, chronologically arranged, of 32 papers, 1868–1915, by various authors.)
- Wool dyeing. (Reprint.) Manchester, 1896.
- Geest, F. A. W. Handbuch der Kattunfabrikation und der Kunst Seide und seidene Zeuge zu färben. Weimar, 1848.
- Lehrb. des bleichens und der gesammten Färberei auf baumwollene Garne und Gewebe. Weimar, 1851.
- Gentele, J. G. Lehrb. der Farbenfabrikation. Braunschweig.
- Georgievics, G. von. The chemical technology of textile fibres. (From the German.) London, 1902.
- Der Indigo vom praktischen und theoretischen Standpunkt. Leipzig, 1892. Contains chapters on the chemistry and synthesis of Indigo.
- Chemistry of dyestuffs. From the 2d German ed. by C. Salter. London, 1905.
- Lehrb. der chemischen Technologie der Gespinnstfasern. Leipzig, 1902. 2 vols.
- Gibson, R. H. The American dyer; a practical treatise on the coloring of wool, cotton, yarn, and cloth. Boston, 1878.
- The art of dyeing (cotton and wool): the properties, etc., of the dyestuffs. Willimantic, Conn., 1861.
- Gilroy, C. J. Treatise on dyeing and calico printing. New York, 1859.
- Girard, C., and Laire, G. De Traité des dérivés de la houille applicables à la production des matières colorantes. Paris, 1873.
- Glücksberg, R. Ueber neue Bildungsweisen von Farbstoffen der Pýroningruppe aus alkylirten m-Amidophenolen. Braunschweig, 1911.
- Gonfreville, D. Art de la teinture des laines en toison, en fil et en tissu. Paris, 1848.
- Greau, —. De la destruction des tissus dans le blanchiment et la teinture, et des moyens d'en prévenir les causes. Troyes, 1835.
- Green, A. G. The analysis of dyestuffs and their identification in dyed and colored materials, lake-pigments, foodstuffs, etc. London, 1915.
- Greene, F. H. The art of finishing woolen and worsteds. Philadelphia, 1886.
- Grisson, T. Le teinturier au xix siècle. Paris, 1869.
- La teinture au dix-neuvième siècle en ce qui concerne la laine et les tissus où la laine est prédominante. Paris, 1884. 2 vols.
- Gros-Renaud, C. Des Mordants en teinture et en impression. Paris, 1898.
- Grothe, H. Technologie der Gespinnstfasern. Bd. 2, Die Appretur der Gewebe. Berlin.
- Katechismus der Wäscherei, Reinigung und Bleicherei. Leipzig, 1884.
- Guèdron, M. Manuel méthodique de l'art du teinturier-dégraisseur. Paris, 1892.
- Guggiari, P. B. Zur Kenntnis des Farblacke, welche die Hydroxylfarbstoffe mit oxydischen Beizen, speziell mit solchen von selteneren Metallen bilden. Berlin. 1912.

- Guignet, C. E., and others. *Industries textiles: blanchiment et apprêts, teinture et impression, matières colorantes.* Paris, 1895.
- Gülich, J. F. *Genaue Beschreibung und Vorschriften zur Manchester—Piquee—Mousslin—un Casimir—Druckerei.* Ulm, 1799.
- Haak, T. *Le teinturier parfait, ou instruction nouvelle et générale pour la teinture des laines et manufactures de laine.* Leide, 1708.
- *Le teinturier parfait, ou instruction . . . pour la teinture des laines . . . comme aussi pour les chapeaux, etc.* Leide, 1708.
- Hadi, S. M. *India: N. W. Provinces and Oudh. A monograph on dyes and dyeing in the N. W. P.* Allahabad, 1899.
- Haigh, J. *The dyer's assistant in the art of dyeing wool and woolen goods. (From the French, with additions.)* London, 1800.
- *A Hint to the dyers and cloth-makers. And well worth the notice of the merchant.* London, 1779.
- Hallerbach, W. *Die Chrombeizen. Ihre Eigenschaften und Verwendung.* Wein, 1904.
- Harmsen, W. *Die Fabrikation der Teerfarbstoffe und ihrer Rohmaterialien.* Berlin, 1889.
- Haserick, E. C. *The secrets of dyeing wool, cotton, and linen; including bleaching and coloring wool and cotton hosiery and random yarns.* Cambridge, Mass., 1869.
- Häussermann, C. *Die Industrie der Teer-Farbstoffe.* Stuttgart, 1881.
- Heermann, P. *Färberei-chemische Untersuchungen.* Berlin, 1907.
- *Koloristische und textil-chemische Untersuchungen.* Berlin, 1903.
- *Anlage, Ausbau und Einrichtungen von Färberei, Bleicherei und Appreturbetrieben.* Berlin, 1911.
- *Mechanisch- und Physikalisch-technische Textiluntersuchungen.* Berlin, 1912.
- Hellot, J. *L'art de la teinture des laines et des étoffes de laine.* Paris, 1750.
- Hellot, J., and others. *The art of dyeing wool, silk, and cotton. (From the French.)* London, 1789.
- Herzfeld, J. *The technical testing of yarns and textile fabrics. From the German by C. Salter.* London, 1898.
- *Das Farben und Bleichen von Baumwolle, Seide, Jute, Leinen, etc.* Berlin, 1900-16. 3 vols.
- *Das Färben und Bleichen von Baumwolle, Wolle, etc.* Berlin, 1889-93. 3 vols.
- Herzinger, E. *Die Walkecht-Färberei der ungesponnenen Baumwolle.* Wien, 1894.
- *Der Technik der Merzerisation.* Leipzig, 1911.
- *Appreturmittelkunde.* Leipzig, 1911.
- Herzog, A. *Die Unterscheidung der natürlichen und künstlichen Seiden.* Dresden, 1910.
- Hesse, B. C. *Coal-tar colors used in food products.* U. S. Dept. of Agriculture, 1912.
- Heumann, K. *Die Anilinfarbstoffe und ihre Fabrikation.* Braunschweig, 1888-1906. 4 vols.
- Heuser, E. J. *Die Apparatfärberei der Baumwolle und Wolle unter Berücksicht. der Wasserreinigung und der Apparableiche der Baumwolle.* Berlin, 1913.
- Higgins, W. *An essay on bleaching (with sulphuret of lime).* London, 1799.

- Hödl, E. J. Die praktische Anwendung der Teerfarben in der Industrie. Wien, 1885.
- Holliday, R., and Sons, Ltd. Our colors; their properties and application. (In English, French, and German.) Huddersfield, 1918.
- A collection of specimens of dyed fabrics, with descriptions of dyestuffs. Huddersfield, 1913. 10 parts.
- Hölterhoff, G. W. Geheimnisse für Fabrikanten und Färber, die Haupt und Modelfarben auf Casimir, Tücher, Biber und Nanquin, etc. . . . darzustellen. Erfurt, 1812.
- Homassel, —. Cours . . . sur l'art de la teinture en laine, soie, fil, coton, etc. Paris, 1818.
- Home, F. Experiments on bleaching. Dublin, 1771.
- Hübner, J. A contribution to the history of dyeing. (Reprint.) London, 1913.
- Bleaching and dyeing of vegetable fibrous materials. London, 1912.
- Hummel, J. J. Mordants, methods, and machinery used in dyeing. London, 1906.
- Die Färberei und Bleicherei der Gespinnstfasern. Deutsche Bearbeitung von E. Knecht. Berlin, 1891.
- The dyeing of textile fabrics. London, 1896.
- Hurst, G. H. A dictionary of the coal-tar colors. London, 1896.
- A handb. of garment dyeing and cleaning. London, 1895.
- Silk dyeing, printing, and finishing. London, 1892.
- Jansen, W. Die verschiedenen Appreturverfahren der Streichgarn, Kammgarn und Cheviotstoffe und der halb wollenen Waren. Leipzig, 1913.
- Jaubert, G. F. Historique de l'industrie suisse des matières colorantes artificielles. Geneve, 1896.
- L'industrie des matières colorantes azoïques. Paris, 1899.
- Jeudel, and others. Nouveau manuel du blanchiment des toiles et étoffes diverses. Paris, 1837.
- Joclét, V. Die Woll und Seiden-Druckerei. Wien, 1879.
- Die chemische bearbeitung der Schafwolle, oder das Ganze der Färberei von Wolle und wollenen Gespinnsten. Wien, 1901.
- Die Kunst- und Feinwäscherei, Enthaltend: die chemische Wäsche, die Fleckenreinigungskunst, Kunstwäscherei, die Strohhut Bleicherei und-Färberei, Handschuhwäscherei, etc. Wien, 1895.
- Handbuch der Bleich-Kunst. Wien, 1878.
- Julia de Fontenelle. Manuel du blanchiment, du blanchissage, nettoyage, et dégraissage des fils et étoffes. Paris, 1855. 2 vols.
- Julius, P. Die künstlichen organischen Farbstoffe. Berlin, 1887.
- Kaepelin, D. Die Bleicherei und Appretur der Wollen und Baumwollen-Stoffe. Berlin, 1870.
- Kaepelin, D. Fabrication des tissus imprimées. Paris, 1860.
- Kardos, M. Ueber einige anthrachinon und 1. 9-Anthracenederivate. Berlin, 1913.
- Kertesz, A. Die Anilinfarbs offe. Braunschweig, 1888.
- Kielmeyer, A. Die Entwicklung des Anilinschwarz in der Druckerei und Färberei. Leipzig, 1893.

- Klemm, H. Lehrb. der gesammten Kunstwäscherei und Kleinigkeits-färberei. Dresden, 1867?
- Klingenberg, K. L. Ueber den 2-Anthrachinonaldehyd. Berlin, 1912.
- Knecht, E., and Fothergill, J. B. The principles and practice of textile printing. London, 1912.
- Knecht, E. The chemistry of the coal-tar colors. (From the German.) London, 1886.
- Knecht, E., and others. A manual of dyeing. London, 3 vols.
- Knecht, E., and others. A manual of dyeing. London, 1916. 2 vols.
- Knepscher, W. Die Appretur der Sieden-, Halbseiden- und Samtgewebe. Leipzig, 1912.
- Kopp, E. Examen comparatif de rouge d'aniline de MM. Lauth et Depouilly et de la fuchsine de MM. Rénard frères et Franc. Paris, 1861.
- Kozlik, B. Technologie der Gewebeappretur. Berlin, 1908.
- Kretschmar, C. Yarn and Warp sizing in all its branches. Translation by C. Salter. London, 1911.
- Krieg, L. J. Theorie und praktische Anwendung von Anilin in der Färberei und Druckerei, nebst Bemerkungen über die Anilin-Surrogate. Berlin, 1862.
- Krieger, A. Ueber Abkömmlinge des 1-5-Diamido-Anthrachinons. Karlsruhe, 1903.
- Kurrer, J. W. H. Das Bleichen der Leinwand und der leinenen Stoffe in den europäischen Ländern, von dem Standpunkte der Wissenschaft und den prakt. Erfahrungen beleuchtet. Braunschweig, 1854.
- Kurrer, W. H. von, and Engels, R. Färberei und Druckerei. Leipzig.
- Kurrer, W. H. von. Das Neueste . . . in dem Gebiete der Druck und Färbekunst, etc. Berlin, 1862.
- Lamoitier, P. La decoration des tissus . . . par le tissage, l'impression, etc. Paris.
- Lange, O. Die Schwefelfarbstoffe, ihre Herstellung und Verwendung. Leipzig, 1912.
- Lau, L., and Hampe, A. Wollenfärberei, Wäscherei und Carbonisirung für löse Wolle, Garne und Stücke. Wien, 1892.
- Praktischer Unterricht in der heitigen Putzfedernfärberei, Lappen-färberei mit Küpfenführung . . . und Chemischer- und Nasswäscherei. Wien, 1890.
- Lauber, E. Handbuch des Zeugdrucks. Leipzig. 3 vols.
- Lauterbach, F. Gesichte der in Deustchland bei der Färberei angewandte Farbstoffe mit bes. Leipzig, 1905.
- Lefèvre, L. Traité des matières colorantes organiques artificielles: de leur préparation industrielle et de leurs applications. Paris, 1896. 2 vols.
- Lehne, A. Tabellarische Uebersicht über die kunstlichen organischen Farbstoffe und ihre Anwendung in Färberei und Zeugdruck. Berlin, 1893-1906. 3 vols.
- Lembecke, E. R. Die Vorbereitungs-Maschinen in der mechanischen Weberei. Leipzig.
- Lénard, A. Die Verfertigung künstlicher Blumen. Weimar.
- Le Normand, L. S. Manuel du fabricant d'étoffes imprimées, etc. Paris, 1854.
- Le Pileur d'Apligny. L'art de la teinture des fils et étoffes de coton . . . et suivi des cultures du pastel, de la gaude et de la garance. Paris, 1776.
- Leuchs, J. C. Dreihundert Entdeckungen und Beobachtungen in der Färberei, dem farbigen Druck und der Farben-Bereitung. Nürnberg, 1831.
- Sammlung neuerer Entdeckungen und Verbesserungen in der Färberei, örtlichen Druckerei und Farben-Bereitung. Nürnberg, 1828.

- Levinstein, Ltd. Four years' work. An account of the progress of the coal-tar dyes (especially indigo), chemical industry in England during the war. Manchester, 1919.
- Lidoff, A., and Tichomiroff, W. Le blanchiment électrique des fibres végétales. Moscou, 1883.
- Lightfoot, J. The chemical history and progress of aniline black. Burnley, 1871.
- Lindsay, W. L. Experiments on the dyeing properties of lichens. (Reprint.) Edinburgh, 1855.
- Liotard, L. Memorandum on dyes of Indian growth and production. Calcutta, 1881.
- Live, T. The art of cleaning, dyeing, scouring and finishing. 2d ed. London, 1855.
- Löbner, O. Die Karbonisation der Wolle, Gewebe, Lumpen, etc., und die Kunstwollfabrikation. Grünberg, 1891.
- Loewenthal, R. Die Färberei der Spinnfasern, nebst Bleicherei Zeugdruck, und Appretur der Gewebe. Leipzig, 1898.
- Lormois, de. L'Art de faire l'indienne à l'instar d'Angleterre, et de composer toutes les couleurs, bon teint, propres à l'indienne. Paris, 1770.
- McKernan, H. A treatise on printing and dyeing silks. London, 1829.
- Mairet, E. M. A book on vegetable dyes. Hammersmith, 1916.
- Manufacture Lyonnaise de Matières Colorantes (Concessionnaire des Brevets de L. Cassella & Cie.). Les couleurs diamines; leur emploi en teinture et en impression. Lyon, 1896-99. 2 vols.
- Martin, J. E. Art de la teinture de la soie, du coton, du lin et des toiles imprimées. Paris, 1828.
- Massot, W. Anleitung zur qualitative Appretur und Schlichte-Analyse. Berlin, 1911.
- Masur, T. Ueber die Bildung einiger neuer Akridin-farbstoffe aus Abkömmlingen des Diaminodiphenyl-methans. Hildesheim, 1908.
- Mather and Platt, Ltd. Process of bleaching textile fabrics by the Mather patent keir. Manchester, 1890.
- Laboratory manual of dyeing and textile chemistry. New York, 1909.
- Matthews, J. M. The textile fibres; their physical, microscopical and chemical properties. New York, 1913.
- Mayer, K. Die Farbenmischungslehre und ihre praktische Anwendung. Berlin, 1911.
- Meissner, G. Die Maschinen zur Appretur, Färberei und Bleicherei, deren Bau und Behandlung. Berlin, 1873. 2 vols. in one.
- Meister, Lucius and Brüning. Dyeings on vegetable ivory buttons.
- Melzer, R. Die Färberei als Kaufmannischer Eigenbetrieb. Elberfeld, 1910.
- Metz, H. A. Year book for colorists and dyers. New York.
- Mierzinski, S. Die Gerb- und Farbstoffextracte. Wien.
- Mijer, P. Batiks and how to make them. New York, 1919.
- Miller, P. Abhandlung von der Färberrothe. Aus dem englischen Uebersetzt. Nürnberg, 1776.
- Miller, P. Modern bleaching agents and detergents. From the German by C. Salter. London, 1910.

- Mögling, W. F. Neues prakt. Lehrb. der Seiden, Baumwollen, Leinen und Wollen Färberei . . . Nebst einer Abhandlung über die Wollen und Kattun-Druckerei, . . . mit Angabe zum Schnellbleichen mit Chlorkalk. Rottweil, 1847.
- Möhlau, R. Organische Farbstoffe. Dresden, 1890.
- Mollins, J. D. De la fabrication des bleus d'aniline et de diphenylamine. (Reprint.) Lille, 1885.
- Monie, H. Sizing, ingredients, size mixing, and sizing. Manchester, 1908.
- Moyret, M. Traité de teinture des soies, précédé de l'histoire chimique de la soie, et de l'histoire de la teinture de la soie. Lyon, 1877.
- Mühlhäuser, O. Die Technik der Rosanilin-Farbstoffe. Stuttgart, 1889.
- Mulder, E. De Indigo, uit een scheikundig oogpunt beschouwd. Scheikundige Verhandelingen, etc.
- Müller, A. Anleitung zur Ausführung textil-chemischer Untersuchungen. Wien, 1903.
- Muston, E. An analysis of the art of dyeing. London, 1830.
- Napier, J. A Manual of the art of dyeing. Glasgow, 1853.
- A manual of dyeing receipts for general use. London, 1875.
- Neovins, W. 1. Versuche zur Darstellung von Diphtaloylcarbazolen. 2. Ueber zwei neue Reduktionsprodukte des Flavanthrens. Helsingfors, 1908.
- Nietzki, R. Chemie der organischen Farbstoffe. Berlin, 1906.
- Die Entwicklungsgeschichte der künstlichen organischen Farbstoffe. Sammlung chem. und chem. techn. Vorträge. Vol. 7, pp. 159-188.
- Organische Farbstoffe. (Reprint.) Breslin, 1886.
- Nisbet, H. Theory of sizing. Manchester, 1912.
- Noelting, D. E., and Lehne, A. Anilinschwarz und seine Anwendung in Färberei und Zeugdruck. Berlin, 1904.
- Noelting, D. E. Aniline black and its applications in dyeing and printing. Translation A. Morris. London, 1909.
- Histoire scientifique et industrielle du noir d'aniline. Muhl., 1889.
- Norton, T. H. Artificial dyestuffs used in the United States—Imports—Statistics. Washington, 1916.
- Nowland, R. A treatise on indigo. (From the French.) Calcutta, 1794.
- O'Brien, C. The British manufacturers' companion and calico printers' assistant. London, 1795.
- The calico printers' assistant. London, 1789.
- Olney, L. A. Textile chemistry and dyeing. Chicago, 1909.
- O'Neill, C. Chemistry of calico printing, dyeing and bleaching. Manchester, 1860.
- A dictionary of calico printing and dyeing. London, 1862. 2d ed. Philadelphia, 1869.
- The practice and principles of calico printing, bleaching, dyeing, etc. Manchester, 1878. 2 vols.
- O'Reilly, R. Essai sur le blanchiment, avec . . . la nouvelle méthode de blanchir par la vapeur, d'après le procédé de Chaptrai; et son application aux arts. Paris, 1801.

- Osborn, W. Treatise on the process and manufacture of fine indigo. Indian Lithogr. Press. 1832.
- Owen, F. A. The dyeing and cleaning of textile fabrics. Based partly on notes of H. C. Standage. New York, 1909.
- Packer, T. The dyer's guide. London, 1830.
- Pajot des Charmes, E. The art of bleaching piece-goods, cottons, and threads, by means of oxygenated muriatic acid. (From the French.) London, 1799.
- Pascal, T. Tintura della seta. Milan, 1892.
- Paterson, D. The color printing of carpet yarns. London, 1900.
- Color matching on textiles for dyers calico printers, and textile color chemists. London, 1901.
- Textile color mixing. London, 1915.
- Paul, A. The practical ostrich feather dyer. Revised. Philadelphia, 1888.
- Pelet-Jolivet, L. Die Theorie des Färbeprozesses. Dresden, 1910
- Pellew, C. E. Dyes and dyeing, New York, 1918.
- Perkin, A. G., and Everset, A. E. The natural organic coloring matters. London, 1918.
- Perkin, W. H. Permanent fireproofing of cotton goods. (Lecture.) New York, 1912.
- Perkin Memorial Committee. Jubilee of the discovery of mauve and of the foundation of the coal-tar industry by Sir W. H. Perkin, Ed. R. Meldola, and others. London, 1906.
- Perrotet, G. S. Art de l'indigotier, ou traité des indigotères tinctoriaux et de la fabrication de l'indigo. Paris, 1842.
- Die Indigofabrication für die Zwecke der Färberei. Aus dem Französischen. Weimar, 1844.
- Perroz, J. Essai sur le conditionnement, le titrage et le décreusage de la soie, suivi de l'examen des autres textiles (Laine, cotton, lin, etc.) Paris.
- Handbuch des Zeugdrucks. Weimar, 1852. 2 vols.
- Traité de l'impression des tittus. Paris, 1846.
- Pfotenhauer, H. Studien in der Phtaleingruppe. Braunschweig, 1906.
- Piequet, O. Livres et procédés de teinture. Paris, 1900.
- L'art de la teinture et de l'impression des tissus. Paris, 1895.
- Polleyn, F. Die Appreturmittel und ihre Verwendung. Wien, 1909.
- Dressings and finishings for textile fabrics, and their applications. From the 3d German edition by C. Salter. London, 1911.
- Prüfer, H. Die Wollen und Halbwoollen-Stückfärberei. Leipzig, 1878.
- Pubetz, A. Handb. der Farberei und Druckerei. Berlin, 1871-72. 3 vols.
- Ramsey, A. R. J., and Weston, H. C. Artificial dyestuffs: their nature, manufacture, and uses. London, 1917.
- Rawson, Gardner, and Laycock. Dictionary of dyes, mordants, etc., used in dyeing and calico printing. London, 1901.
- Reimann, M. Die Färberei der Federn, etc. (In German and French.) Berlin.
- Leichtfassliche Chemie. Kurze Erklärung der chemischen Vorgänge in Färberei, Druckerei, Bleicherei, Appretur, etc. Berlin, 1891.

- Riemann, M. Die Färberei der Baumwolle und der anderen vegetabilischen Faserstoffe. (In German and French.) Berlin, 1897.
- Die Färberei der Steinnuss-knöpfe und deren Herstellung. (In German and French.) Berlin, 1880.
- Leichtfassliche Chemie . . . chemischen Vorgänge in Färberei, Druckerei, Bleicherei, und Appretur. 4te Aufl. von A. Ganswindt. Leipzig, 1913.
- On aniline and its derivatives. London, 1868.
- Reiser, N. Die Appretur der wollenen und halbwillenen Waren. Leipzig, 1899 and 1912.
- Reisig, F. W. The guide to piece dyeing. New York, 1889.
- Renard, G. A. Traité des matières colorantes, du blanchiment et de la teinture du coton, etc. Paris, 1883.
- Répertoire général, ou dictionnaire méthodique de bibliographie des industries tinctoriales, etc. Paris, 1900.
- Richter, E., and Braun, W. Die Wollengarn-Färberei. Leipzig, 1874.
- Ridgway, R. Color standards and nomenclature. Washington, 1912.
- Riffault des Hêtres, J. R. D., and others. Nouveau manuel du teinturier. Paris, 1837.
- Manuel du teinturier, apprêteur et dégraisseur. Nouv. éd. par A. Romain. Supplément par A. M. Villon. Paris, 1880-90. 3 vols.
- Roegner, C. G. Differentiae juris Romani et Germanici in re bafaria tinctorum den Farbereyen. 1725. Halae Venedorum, 1738.
- Romen, C. Bleicherei, Färberei und Appretur der Baumwolle und Leinen-Waaren. Berlin, 1879-1886. 2 vols.
- Die Colorie der Baumwolle auf Garne und Gewebe mit bes. Berücksicht. der Türkischroth Färberei. Wien, 1878.
- Rosetti, G. V. Pliotho de larte de tentori che insegna tenger pañi telle banbasi et sede si per larthe maggiore come per la comune. Venice, 1548.
- Rothwell, C. F. S. The printing of textile fabrics. London, 1897.
- Rouget de Lisle, A. Notice historique . . . sur le blanchissage du linge de toile, de la flanelle de santé et des divers vêtements. Paris, 1852. (Extrait.)
- Rudolf, E. Indigo-Küpenblau-Färberie, Reservageund Awtz-Druckerei (Blaudruck) auf Baumwolle und Leinen. Leipzig, 1885. Collected from the *Farberei-Muster Zeitung*, 1875-85.
- Runge, F. F. De pigmento Indico ejusque connubiis cum metallorum nonnullorum oxydis. Berlin, 1822.
- Farbenchemie. Berlin, 1834-42. 3 vols.
- Rupe, H. Die Chemie der natürlichen Färbstoffe. Bolley, A. P. Handb. der chemischen Technologie.
- Sachse, R. Die Wäscherei, Bleicherei und Färberei von Wollengarnen für Walkwaaren. Leipzig, 1881.
- Sachse, R., and others. Die Fortschritte der losen Wollen und Wollengarn-Färberei (unecht und walkecht) seit 1881. Leipzig, 1886.
- Sansone, A. Recent progress in dyeing and calico printing, being a supplement to "The printing of cotton fabrics," and "Dyeing." Manchester, 1895-97.
- Compendium der Färberie-Chemie, etc. (From the Italian.) Wien, 1912.

- Sansone, A. Dyeing: comprising the dyeing and bleaching of wool, silk, cotton, flax, hemp, china grass, etc. Manchester, 1888. 2 vols.
- The printing of cotton fabrics, comprising calico bleaching, printing, and dyeing. Manchester, 1901.
- Recent progress in the industries of dyeing and calico printing, being a supplement to "The printing of cotton fabrics, etc." Manchester, 3 vols.
- Schaeffer, J. C. Description d'une machine inventée en Angleterre et perfectionnée en Allemagne pour blanchir de linge. Strassburg, 1767.
- Schams, J. Handbuch der Schlichterei. Leipzig, 1908.
- Schatz, D. Einfluss der Appretur auf die physikalischen Eigenschaften eines halb-
wollenen Gewebes. Leipzig, 1902.
- Scheffer, H. T. Essai sur l'art de la teinture. Paris, 1803.
- Scherf, C. F. Belehrung über die Anstellung, etc., der Waidindigoküpe, so wie über die Krankheiten derselben. Weimar, 1848.
- Der Kleinigkeitsfärber. Weimar, 1860.
- Schlesinger, R. Examen des Fibres Textiles. Paris, 1875.
- Schmidt, C. H. Handb. der Färberei. Weimar, 1861.
- Die Farbwaarenkunde und Farbenchemie für Färberei und Zeugdruck. Weimar, 1856.
- Schmidt, O. Über Cumylindigo und Cumylisatin. München, 1912.
- Schneider, H. Ueber die technologische Veränderung der Leinengarne durch den Bleichprozess. Leipzig, 1908.
- Schoop. Electriche Bleiche. 1900.
- Schreiber, E. Die Fabrication der künstlichen Blumen nebst der Federschmuckerei. Weimar.
- Schultz, G., and Julius, P. Tabellarische Uebersicht der künstlichen organischen Farbstoffe. Berlin, 1888.
- Tabellarische Uebersicht der im Handel befindlichen künstlichen organischen Farbstoffe. Berlin, 1897 and 1902.
- Schultz, G. Farbstofftabellen. Berlin, 1911-14.
- Tavole delle materie coloranti organiche artificiali. Parma, 1892.
- Die Chemie des Steinkohlentheers. 2 vols. Braunschweig, 1886.
- Systematic survey of the organic coloring matters. Transl. with additions by A. G. Green. London, 1894.
- Schützenberger, P. Die Farbstoffe mit bes. Berücksicht. ihrer Anwendung in der Färberei und Druckerei. Bearbeitet von H. Schröder. Berlin, 1868. 2 vols.
- Traité des matières colorantes; comprenant leurs applications à la teinture et à l'impression, et des notices sur les fibres textiles, les épauissants et les mordants. Paris, 1867. 2 vols.
- Schwalbe, C. J. Neuere Färbetheorien. Sammlung chem. und chem.-techn. Scientific and industrial history of aniline black. (From the French.) New York, 1889.
- Seer, C. Versuche zur Einführung mehrerer Phtalsäurereste in aromatische Verbindungen und zur Darstellung neuer Küpenfarbstoffe der Anthracenreihe. Karlsruhe, 1908.
- Seltner, G. Die Indigoküpen. Leipzig, 1886.

- Serre, E. *La Teinture du Coton*. Paris, 1912.
- Seyewetz, A. *Sur les combinaisons des matières colorantes acides avec les matières colorantes basiques*. Lyon, 1900.
- Seyewetz, A., and Sisley, P. *Chimie des matières colorantes artificielles*. Paris, 1896.
- Shone, W. *The launderers', dyers' and cleaners' manual*. Norwich, 1909.
- Silbermann, H. *Fortschritte a. d. G. der chemischen Technologie der Gespinnstfasern. 1885-1900. Nebst den Patent-ansprüchen*. Dresden, 1902-3. 2 vols.
 — *Die Seide*. 2 vols. Dresden, 1897.
- Singer, M. *La teinture moderne*. Leipzig, 1875. 2 vols.
- Slater, J. W. *Manual of colors and dye wares*. London, 1870.
- Smith, D. *Die englische Färberei*. Uebersetzt von C. H. Schmidt. Weimar, 1854.
 — *The English dyer*. Manchester, 1882.
- Smith, W. *The valuation of dyers' and printers' drugs and chemicals, etc.* (Reprint.) Manchester, 1885.
- Smithsonian Institution. *Purple dyeing, ancient and modern*. From "Aus der Natur," etc. 1863.
- Society of Dyers and Colourists. *Discussion on the "alleged poisonous action of dyes (ailine, etc.) on the skin."* (Reprint.) Manchester, 1884.
- Soxhlet, D. H. *Die Praxis der Anilin-Färberei und Druckerei auf Baumwoll-Waaren*. Wien, 1890.
- Springer, E. A. *Der praktische Wool und Halbwoolfärber*. Leipzig, 1902.
- Springmühl, F. *Lexicon der Farbwaaren und Chemikalienkunde*, 2 vols. Leipzig, 1877-81.
- Stein, G. *Die Bleicherei, Druckerei, Färberei und Appretur der baumwollenen Gewebe*. Braunschweig, 1883.
- Steinbeck, C. H. *Bleichen und Färben der Seide und Halbseide in Strang und Stück*. Berlin, 1895.
- Steinkopf, W. *Ueber die Kuppenprodukte des Indanthrens*. Karlsruhe.
- Stilling, J. *Anilin-Farbstoffe als Antiseptica und ihre Anwendung in der Praxis*. Strassburg, 1890.
- Stirm, K. *Chemische Technologie der Gespinnstfasern*. Berlin, 1913.
- Süvern, K. *Die künstliche Seide. Ihre Herstellung, Eigenschaften und Verwendung. Mit bes. Berücksicht. des Patent-Literatur*. Berlin, 1912.
- Tailfer, L. *Practical treatise on the bleaching of linen and cotton yarns and fabrics, From the French by J. G. M'Intosh*. London, 1901.
- Tallieri, G. *Nuovo plico d'ogni sorte di tinture, arricchito di rari, e bellissimi secreti per colorire animali, vegetabili, e minerali*. Venezia, 1804.
- Tantin, V. *Leçons de blanchiment et de teinture professées . . . à l'Ecole Industrielle de Flers (Orne)*.
- Tassart, C. L. *L'industrie de la teinture*. Paris, 1890.
 — *Les matières colorantes et la chimie de la teinture*. Paris, 1890.
- Terres, E. *Synthesen von 1-2-Diamido-Anthrachinon, Anthrachinon-azinen und Indanthren*. Braunschweig, 1910.
- Theis, F. C. *Die Breitbleiche baumwollener Gewebe*. Berlin, 1902.
 — "Khaki" on cotton and other textile materials. (Translation.) Berlin, 1903.
 — *Die Strangbleiche baumwollener Gewebe*. Berlin, 1905.

- Thillaye, L. J. S. Manuel du fabricant d'indiennes renfermant les impressions des laines, de chalis et des soies. Suite au "Manuel du fabricant des étoffes imprimées." Paris, 1857.
- Thomas, V. Les matières colorantes naturelles. Paris, 1901.
— Guide pratique de teinture moderne, suivi de l'art du teinturier-degraisseur. Paris, 1900.
- Thomson, J. Notes on the present state of calico printing in Belgium, etc. London, 1841.
- Thomson, W. The sizing of cotton goods, and the causes and prevention of mildew. Manchester, 1877.
- Trey, J. Anlage, Konstruktion und Einrichtung von Bleicherei und Färberei-Lokalitäten. Berlin, 1889.
- Triapkine, W. Rongéage du rouge ture par la méthode alcaline. Paris, 1899.
- Trotman, S. R., and Thorp, E. L. The principles of bleaching and finishing of cotton. London, 1911.
- Tucker, W. The family dyer and scourer. London, 1817.
- Ullmann, G. Die Apparatefärberei. Berlin, 1905.
- Urmčnyi, D. Über Antherochinonxanthone. Berlin, 1912.
- U. S. Dept. of Commerce (Bureau of Foreign and Domestic Commerce) Dyestuffs for American textile and other industries. By T. H. Norton. Washington, 1915.
- U. S. Tariff Commission. Census of dyes and coal-tar chemicals for 1917, 1918, 1919. Washington.
- Vallhonesta, J. Colores derivados de la anilina. Madrid, 1874.
- Vallhonesta y Vendrell, J. El arte de tintorero. Barcelona, 1880.
- Vassart, L'Abbé. Couleurs et Colorants. Paris, 1912.
— Étude sur l'alizarine artificielle. Paris, 1887.
- Vergnaud, A. D. Manuel du teinturier. Paris, 1842.
- Villon, A. M. Traité des matières colorantes artificielles dérivées du goudron de houille. Paris, 1890.
- Vinant, M. De Traité de teinture et impression. Lyon, 1872.
- Vinçard, A. L'art du teinturier-coloriste, sur laine, soie, fil et coton. Paris, 1820.
- Vitalis, J. B. Cours élémentaire de teinture sur laine, soie, lin, chauvre et coton, et sur l'art d'imprimer les toiles. Rouen, 1827.
— Lehrb. der gesammten Färberei. Nebst Kattun-Druckerei. (From the French.) Weimar, 1854.
- Von Reuss, C. F. Kenntniss dererjenigen Pflanzen die Mahlern und Färbern zum Nutzen . . . gereichen können. Leipzig, 1776.
- Wagner, L. Die elektrische Bleicherei. Wien, 1907.
- Wall, A. L'industrie des matières colorantes organiques. Paris, 1912.
— The manufacture of organic dyestuffs. (From the French.) London, 1914.
- Walland, H. Wasch-, Bleich- und Appreturmittel. Berlin, 1913.
- Walter, J. Aus der Praxis der Anilinfarbenfabrikation. (Machinery and plant in general. The manufacture of Safranin, Clematin, and Indoin.) Leipzig, 1903.

- Wartensleben, H. *Prakt. Lehrgang der Türkischroth Garn-Färberei.* Leipzig, 1880.
- Webb, E. *Warp sizing.* Manchester.
- Westrumb, J. F. *Ueber das Bleichen mit Säuren nach französischen und englischen Vorschriften, nebst Beschreibung des besten Bleichverfahrens.* Berlin, 1819.
- Weyl, T. *Die Teerfarben mit bes. Rücksicht auf Schädlichkeit und Gesetzgebung hygienisch und forensisch-chemisch untersucht.* Berlin, 1889.
- Wharton, B. F., and Soxhlet, V. H. *Die Kattun-Druckerei.* Wien, 1892.
- Whittaker, C. M. *The application of the coal-tar dyestuffs.* London, 1918.
- Whole art of dyeing, The.* Part I. (From the German.) Part II. (From the French.) London, 1705. The same. Reprinted. Stratford-on-Avon, 1913
- Wichelhaus, K. H. *Organische Farbstoffe. Ergänzung der "Vorlesungen über chemische Technologie."*
- Wickardt, A. *Die Webereimaschinen, etc.* Leipzig, 1911.
- Willems, P. *La Soie Artificielle.* Paris.
- Winckler, F. *Recept-Taschenbuch der Anilinfarben-Technik und gesammten Anilin-Färberei und Druckerei.* Ratibor, 1871.
- Witt, O. N. *Chemische Technologie der Gespinnstfasern.* Bolley, A. P. *Handb. der chemischen Technologie.*
- Wolff, H. *Die Beizen, ihre Darstellung, Prüfung und Anwendung.* Wien, 1885.
- Wood, J. K. *The chemistry of dyeing.* London, 1913.
- Woodhouse, T. *The finishing of jute and linen fabrics.* Manchester, 1916.
- Woolman & McGowan. *Textiles.* New York, 1913.
- Wurtz, C. A. *Progrès de l'industrie des matières colorantes artificielles.* (Reprint.) Paris, 1876.
- Zacharias, P. *Die Theorie der Färbevogänge.* Berlin, 1908.
- Zellner, E. *Die prakt, Filzhut-Färberei nebst Walkfarben und Stoff-Färberei.* Berlin, 1887.
- Zerr, G., and Rübenkamp, R. *Handb. der Farben-Fabrikation.* Dresden.
- *Treatise on colour manufacture.* English edition by C. Mayer. London, 1908.
- Zerr, G. *Tests for coal-tar colors in aniline lakes.* English ed. London, 1910.
- Zipser, J. *Apparate, Geräte und Maschinen der Wäscherei, Bleicherei, Färberei, Garn und Zeug-Druckerei.* Leipzig, 1894. 2 vols. in one.
- *Textile Raw Materials.* Translated from the German by Charles Salter, London, 1901.
- Zolla, D. *Les fibres textiles d'origine animale (soie et laine).* Paris, 1910.

INDEX OF EXPERIMENTS

- Absorbent cotton, bleaching of, 150
Acid bath with substantive dyes, 302
Acid-chrome dyes, use, 362
Acid colors, use of acetic acid in dyeing of, 195
— dyes on cotton, representative, 236
— — — silk, representative, 236
— — — wool, representative, 236
— —, action of, 174
— —, after-treatment of with chrome, 220
— —, dyeing of silk with, 219
— —, in a neutral bath, 193
— —, on union goods, 547
— —, use of on cotton, 219
— in dyeing acid colors, influence of, 193
Acidified wool, dyeing of, 194
Acids, action of on wool and cotton, 66
After-chromed dyes, general properties of, 157
After-mordanting with chrome, 361
After-treating basic dyes on silk, 253
After-treatment with bluestone, 288
— — chrome, 288
— — iron salts, 290
Alkali, blue, dyeing of, 194
Alkalies, action of on fibers, 67
Ammonium acetate in dyebath, 302
Aniline black, after chrome method for, 463
— —, ageing process for, 466
— —, one bath process, 464
— —, use of bluestone, 466
— —, use of manganese chloride in, 469
— —, use of vanadium salts in, 469
Anti-chlor in bleaching, 150
Archil, method of dyeing, 511
Basic colors, dyeing cotton in one bath with, 269
— —, general method of dyeing cotton with, 267
— dyes, action of, 175
— —, compared with acid dyes, 254
— —, dyeing in neutral bath, 254
— —, dyeing silk with, 252
— —, effect of hard water in dyeing with, 254
— —, general method of dyeing on wool, 254
— — on cotton, 274
— — — silk, 274
— — — union goods, 548
Bistre on cotton, 520
Bleaching powder, action of on fibers, 69
— wool, by sulphur process, 114^r
— —, by tinting, 114
— — with permanganate, 115
— — — sodium busulphite, 114
— — — sodium peroxide, 115
Blue mordant, use of in cotton dyeing, 220
Boiled-off liquor, use of in dyeing silk, 219
Carbonizing process, illustrating the, 67
Chrome black, dyeing with, 363
— green on cotton, 521
— orange on cotton, 517
— yellow on cotton, 516
Chromotrop dyes, use of, 221
Ciba-blue, use of, 450
Cochineal, method of dyeing, 511
Copperas vat for indigo, 447
Cotton bleaching, acid treatments in, 152

- Cotton bleaching, softening and tinting in, 151
 —, tinting process, 150
 —, use of acetic acid in, 151
 —, use of lime boil in, 152
 —, — — sodium hypochlorite in, 152
 — with chloride of lime, 150
 —, — permanganates, 153
 —, — peroxides, 152
 —, dyeing of acid dyes on, 19
 Coupled dyes, general properties of, 157
 Coupling process of dyeing, 338
 Cuprammonium solution, action of on cotton, 69
 Cutch, method of dyeing, 511
- Developed black, 337
 — on silk, 339
 — blue, 337
 — brown, 337
 — dyes, after-treatment of, 337
 —, general method for, 335
 —, properties of, 157
 —, shading of, 337
 Diazotized colors, 335
 Direct cotton colors, 286
 Dyeing in cold bath, 289
 — mordanting colors, 360
 — process, study of factors in, 604
 Dyestuffs, action of on fibers, 158
 —, — — wool, 159
- Eceru silk, dyeing of, 252
 Exhaustion of dyebath, 193, 605
 Equilibrium of dyebath, conditions of, 604
- Fastness, methods of tabulating tests for, 243
 — of dyes to carbonizing, testing of, 241
 — — — — chloring, testing of, 242
 — — — — crocking, 243
 — — — — cross-dyeing, testing of, 242
 — — — — fulling, testing of, 240
 — — — — light, testing of, 240
 — — — — perspiration, testing of, 241
 — — — — stoving, testing of, 242
 — — — — washing, testing of, 240
 — — — — water, testing of, 241
- Formaldehyde, use of in dyeing, 288
 Fustic method of dyeing, 510
- Glaubersalt, use of in dyebath, 193
- Heat, action of on fibers, 70
 Hydrosulphite vat for indigo, 446
 Hematine, dyeing with, 484
 Hydrochloric acid, action of on silk, 67
- Ice colors, 336
 Indanthrene blue, use of, 450
 — colors, pink with, 450
 — yellow, use of, 450
 Indigo extract, 449
 —, reactions of, 448
 — solution, preparation of, 445
 Iron buff on cotton 518
 — gray on cotton, 519
 — salts, effect of in dyeing, 360
- Janus dyes, use of, 269
- Keratine in wool, 159
 Khaki on cotton, 522
- Logwood black, on cotton, 487
 — — — silk, 490
 — blue on cotton, 490
 — chrome black on cotton, 488
 — direct black, 486
 — dyeing in one bath, 364
 —, — on wool, 484
 —, effect of over chroming, 484
 — extract, valuation of, 490
 —, shading of with alizarine yellow, 485
 —, — — — fustic, 485
 —, use of iron mordant with, 485
 — with aluminium mordant, 487
 — with copper mordant, 489
 — with tin mordant, 487
- Madder, method of dyeing, 510
 Manganese brown on cotton, 520
 Mercerization of cotton, 68
 Meta-chrome dyeing, 363
 Metallic salts, action of on cotton, 68
 — —, — — — fibers, 68
 Mixed colors, dyeing of, 605
 Mordant dyes, action of, 175
 Mordants, action of on fibers, 68

Mordants on wool, comparison, of 361
Moisture, effect of in textile fibers, 70

Naphthol dyes, general properties of, 157

Organic acids, action of on cotton, 667
Oxidized dyes, general properties of, 158
Oxidizing agents, action of on cotton, 70

Padder, dyeing with, 364
Peroxide bleaching, effect of iron in, 153
Phthalein dyes, use of, 195
Pigment dyes, action of, 176
—, general properties of, 158
Primuline, 335
— on silk, 338
Prussia blue on cotton, 522
— — — wool, 522
Pyrolignite of iron, after-treating with, 290

Quercitron, method of dyeing, 511

Salt colors, 286
—, influence of amount of in bath, 287
Sandal-wood, dyeing with, 364
Scouring cotton with caustic soda, 105
— — — soap, 106
— — — soda ash, 105
— — — soluble oil, 106
Scouring of raw silk, 106
— wool by emulsion process, 105
—, effect of alkalis in, 105
—, use of potash in, 105
— woolen yarn, 105
— — — containing iron, 105
Scrooping effect on silk, 67
Shading substantive dyes, 289
Silk, dyeing of with acid dyes, 219
— — in neutral soap bath, 252
—, use of acetic acid in, 219
—, — — of boiled-off liquor in, 219
—, — with basic colors, 252
Silk-cotton goods, two color effects on, 568
—, various methods of dyeing, 567
Soap, use of, in dyeing, 288
Soda ash, use of, in dyeing, 287
Sodium stannate, use of after mordanting, 220
Solid solution in dyeing process, 159
Souple silk, dyeing of, 252

Substantive colors, stripping of with chloride of lime, 238
— —, — — — hydrosulphite, 239
— —, — — — titanous salts, 239
—dyes, action of, 175
— —, after-treatment with chrome, 304
— —, — — chromium fluoride, 304
— —, dyeing wool with, 302
— —, general properties of, 157
— — not dyeing wool, 304
— — on cotton, dyeing of, 286
— — — silk, general method for, 305
— — — union goods, 548
— — with logwood, 289
Sulphur blue, method of dyeing, 404
— dyes, topping of, 404
— —, after treatment of with chrome, 403
— —, general method of applying, 403
— —, black dyeing with, 403
— —, dyeing khaki with, 404
— —, general properties of, 157
Sulphuric acid, action of on cotton, 67

Tannin, fixing with antimony salts, 269
—, — with copperas, 269
—, method of fixing with tartar emetic, 267

Temperature of dyebath, 287
Tests for fastness, methods of tabulating, 243

Thio-indigo red, dyeing with, 449

Tin mordant dyeing on, 363

Topping with aniline black, 290

— with cutch, 290

Turkey red, old process for, 366

—, short process for, 369

Two color, effects on union goods, 548

Union goods, substantive dyes on, 303

— dyeing, various methods of, 549

Vat dyes, general properties of, 157

Woaded black, 486

Wool, affinity of for dyes, 159

—, general method of dyeing, 193

Zinc, chloride, action of on cotton, 69

— lime vat for indigo, 448

SUBJECT INDEX

- Absorbent cotton, preparation of, 143
Acetic acid, use of in cotton bleaching, 133
— — — — in dyeing, 181
Acid and basic dyes, distinguishing between, 672
— colors, methods of stripping, 238
— dyes, action of on cotton, 165
— — — — with hard water, 179
— — — — chemical classification of, 177
— — — — chief defects of, 178
— — — — dissolving of, 209
— — — — fastness of, 178
— — — — general characteristics of, 177
— — — — properties of, 156
— — — — use of, 177
— — — — list of principal, 232
— — — — on jute, 576
— — — — precautions for use of, 179
— — — — use of in neutral bath, 183
— — — — — on cotton, 202
— — — — — silk, 163, 197
— — — — — wool, 160
— in fabrics, estimation of, 692
— indigo extract, 431
— potassium oxalate, use of, 279
Acids, action of on textiles, 36
Acridine dyes, 247
Adjective dyes, 162, 340
Adulteration in dyes, detection of, 672
After-chromed acid dyes, 206
— dyes, use of on wool, 162
After-treatment with bluestone, 282
— — chrome, 282
— — formaldehyde, 282
Ageing machine, 364, 370
— — for aniline black, 464
— — — cloth, 462
— — — warps, 463
Algol dyes, 441
Alizarine, 496
— — — — chemical reactions of, 496
Alkalies, action of on fibers, 40
Alkanna, 10
Alpha-naphthol, 313, 321
Alpha-naphthol-parasulphonic acid, 313
Alpha-naphthylamine, 332
— claret, 332
— salt S, 333
Aluminium acetate, 282
Aluminium-tannin mordant, 261
Amend's process of mordanting, 345
Amino-azo-benzene, 321, 331
— developers, 309
Amino-diphenylamine, 313
Amino-naphthol-sulphonic acid G, 313
Ammoniacal cochineal, 506
Ammonium acetate, method of making, 182
— — — — use of in dyeing, 182
— sulphate, use of in dyeing, 182
— sulphocyanide, use of in dyeing, 187
Analysis of textile fabrics, 687
Ancient dyestuffs, comparison with modern dyes, 14
— — — — limitations of, 13
— — — — methods of dyeing, 15
Angola yarns, fastness of colors for, 623
Aniline, 321
— black, 451
— — — — formulas for, 457
— — — — Green's process for, 457
— — — — on silk, 460
— — — — wool, 460
— — — — oxidizing process, 452
— — — — single bath process, 452
— — — — steam process, 452

- Aniline black ungreenable, 451
 — dyes, definition of, 248
 — inks, 660
 Animalized cotton, 165, 203
 Animalizing cotton, 36
 Anti-chlor, use of in bleaching, 131
 Antimonine, 266
 Antimony oxalate, 266
 — salts, 266
 Antimony-sodium fluoride, 266
 Antimony-tannin mordant, 259
 Anthraquinone dyes, 405
 — vat bues, 441
 Apparatus for dyeing union goods, 525
 — — decatizing, 65
 — — dyeing, 211
 Archil, 498, 499
 —, chemical, reactions of, 499
 — liquor, 499
 Artificial flowers, dyeing of, 641
 — horsehair, 579
 — silk, dyeing blacks on, 581
 — —, dyeing of, 578
 — —, general methods of dyeing, 174
 Artists' colors, 650
 Ash in fabrics, estimation of, 692
 Assistants used in dyeing, 168
 Aurantine, 495
 Auxochrome, 169
 Azine dyes, 247
 Azo basic dyes, 247
 — black base, 321
 — — base O, 332
 — — base ON, 332
 — garnet, 331
 — maroon, 332
 Azophor blue D, 332
 — red PN, 319
- Back chroming of logwood, 479
 — drying machine, 510
 Bakelite, dyeing of, 647
 Bark extract, 500
 Basic colors in dyeing linen, 574
 — —, practical dyeing of, 273
 — —, use of on cotton, 255
 — dyes, action of on cotton, 165
 — —, action of reducing agents on, 247
 — —, characteristics of, 247
 — —, dissolving of, 250
 — —, general properties of, 156
- Basic colors, list of principal, 270
 — —, topping substantive dyes with, 252
 — —, use of on silk, 163, 249
 — —, — — for wool, 160, 251
 — — on jute, 576
 Bast silk, 197
 Batik style of dyeing, 4
 Bed feathers, bleaching of, 635
 Beetling machine, 587
 — — for heavy cloth, 683
 Benzidine, 321
 — developer, 314
 Benzo nitrol, 319
 Berlin blue, 523
 Beta-naphthol, 311
 Beta-naphthylamine, 321
 Bibliography of dyeing, 733
 Bistramine brown, 462
 Bistre, 520
 Black cochineal, 505
 — dyed cotton, analysis of, 697
 Bleacher's assistants, composition of, 118
 Bleaching cotton with hypochlorites, 122
 — fine yarns, vacuum kier for, 145
 — machine for knitgoods, 146
 — — — raw stock, 151
 — powder, apparatus for dissolving, 125
 — —, disadvantages of, 141
 — —, properties of, 125
 — silk by stoving, 113
 — — with aqua regia, 113
 — — — peroxides, 113
 — with hypochlorites, chemical reactions
 in, 126
 — wool by tinting process, 107
 — —, comparative methods of, 113
 — —, gas process for, 108
 — — with permanganates, 112
 — — — peroxides, 110
 — — — sodium bisulphite, 108
 Blue developer AN, 313
 — spirits, 523
 Boiled-off compounds, effect of neutral
 salts in, 122
 — liquors, use of in dyeing, 97
 — yarns, change in count of, 119
 Boiling-off of silk, 96
 Boiling-out cotton, effect of different alka-
 lies in, 122
 —, discussion of, 119
 — of cotton, 89

- Boiling-out yarn, effect of on physical properties, 120
- Bonsor's fast direct black, 476
- Bookbinders' cloth, fastness of colors for, 623
- Bordeaux developer, 311
- Brightening of silk, 39, 199
- Bristles, dyeing of, 639
- Brown developer, 313
- Brushing machine for piece goods, 659
- Burl dyeing, 538
- Button material, dyeing of, 645
- Calcined Glaubersalt, 186
- Calcium acetate, use of in dyeing, 353
- Calculations in dyeing, 187, 712
- Calender for jute, 573
- — producing silk finish, 680
- with expander, 490
- Campeachy wood, 471
- Candles, dyeing of, 663
- Capacity of tanks, 713
- Capillary speed of dyestuffs, 676
- Carbazol dyes, 405
- vat dyes, 444
- Carbonized shoddy, method of dyeing, 181
- wool, after-treatment of, 75
- Carbonizing, 36, 188
- with aluminium chloride, 75
- — hydrochloric acid, 75
- — sulphuric acid, 74
- scoured wool, 74
- Carmine lake, 507
- Carminic acid, 505
- Carpet yarns, fastness of colors for, 621
- Carriers for lakes, 648
- Catechin, 501
- Catechu, 501
- Catechu-tannic acid, 501
- Catechuic Acid, 502
- Celuloid, dyeing of, 644
- Centrifugal machine for cloth, 310
- Cerasine dyes, 664
- Chardonnet silk, 578
- Cheese dyeing machine, 391
- Chemical in cotton bleaching, 125
- Chemical theory of dyeing, 582
- Chemicals used in dyeing, 728
- Chalybeate water, 216
- China grass, 575
- Chloranisidine, 321
- Chloranisidine scarlet, 333
- Chlored wool, 54
- Chloride of soda, 134
- Chlorinated wool, 55
- Chlorine compounds, action of on fibers, 54
- Cholesterol, 71
- Chromate process, 352
- Chrome, action of in dyeing, 207
- developed dyes, 374
- dyes, 340, 356
- green, 521
- orange, 517
- Chrome-tanned leather, dyeing of, 628
- Chrome yellow, 516
- Chromium fluoride, after-treatment with, 299
- Chromophor, 169
- Chromotrop, method of application, 207
- Chrysoidine, 314
- Ciba dyes, 437
- Cibanone dyes, 442
- Clarax bleaching compound, 152
- Classification of dyes, 154, 224
- Cloth doubling machine, 634
- spreading machine, 532
- trimmer, 646
- Coal-tar dyes, discovery of, 155
- —, introduction of, 12
- Cochineal, 505
- , reactions of, 505
- , with different mordants, 505
- carmine, 507
- Coir fiber, dyeing of, 577
- Cold bath, dyeing in, 280
- Collodion silk, 578
- Color and chemical constitution, relation between, 169
- Color-lakes, preparation of, 648
- Colors, on cotton testing fastness of, 616
- — wool, testing fastness of, 608
- — silk, testing fastness of, 618
- Condensite, dyeing of, 647
- Conditioning of textiles, 59, 691
- oven for textiles, 57
- Continuous dyeing machine, 398
- Conversion tables, 704
- Cop dyeing machine, 268, 272, 277, 391
- — —, for indigo, 425
- — —, — vat colors, 432
- Copperas black with logwood, 479
- , use of in fixing tannin mordant, 260

- Copperas vat for indigo, 413, 422
 Copying inks, 660
 Correction for hard water, 353
 Cotton, action of acids on, 36
 —, — — acid dyes on, 165
 —, — — after-chrome dyes on, 165
 —, — — alkalis on, 41
 —, — — basic dyes on, 165
 —, — — chlorine on, 56
 —, — — dyes on, 164
 —, — — metallic salts on, 54
 —, — — mordant dyes on, 165
 —, — — natural dyes on, 166
 —, — — nitric acid on, 36
 —, — — organic acids on, 37
 —, — — potassium permanganate on, 56
 —, — — substantive dyes on, 165
 —, — — sulphur dyes on, 165
 —, — — tannic acid on, 39
 —, — — vat dyes on, 165
 — and linen, distinction between, 689
 — — wool, estimation of in fabrics, 528
 — bleaching, acid treatment in, 128
 — —, action of chlorine in, 117
 — —, boiling-out for, 117
 — —, cause of tendering, 130
 — —, chemical agents used in, 116
 — —, continuous system, 138
 — —, different forms of, 116
 — —, loss in strength in, 130
 — —, — — weight in, 130
 — —, machinery for, 127
 — —, method of chemicing, 124
 — —, methods of washing, 000
 — —, oxidization of fiber, 130
 — —, soaping and tinting in, 129
 — —, use of hypochlorites in, 122
 — —, various operations in, 117
 —, boiling-out of, 89
 —, dyeing of with acid colors, 202
 —, effect of bleaching on, 130
 —, — — heat on, 62
 — fiber under microscope, 527
 —, general methods of dyeing, 172
 — goods, fastness of colors for, 622
 —, impurities in raw, 89
 — linings, fastness of colors, for 623
 —, methods of mordanting, 255
 —, use of in woolen goods, 526
 —, wetting-out of, 91
 — piece goods, fastness of colors for, 623
 Cotton raw stock, dyeing with sulphur colors, 398
 — skein yarn, bleaching of, 144
 — warps, bleaching of, 144
 — —, dyeing of in size, 285
 — —, fastness of colors for, 522
 — wash fabrics, dyes for, 407
 — yarn, apparatus for dyeing, 212
 Coupled dyes, 317, 334
 Cow-hair, dyeing of, 639
 Crabbing machine, open-width, 346
 —, machinery for, 88
 — process, 63
 — union goods, 534
 Craft dyeing, 3
 Cream of tartar, 345
 Crimson developer, 313
 Crop madder, 497
 Cudbear, 500
 Cuit silk, 96
 Cuprammonium silk, 578
 Curcumine, 508
 Cutch, 501
 —, detection of on fibers, 503
 —, use of in dyeing, 503
 Cylinder brushing machine, 621
 Data for dyers, 701
 Decatizing, apparatus for, 65
 —, effect on wool fiber in, 66
 — process, 65
 — union goods, 534
 Definition of dye terms, 1
 Degumming of silk, 96
 Delahunty dyeing machine, 170
 Denims, dyeing of, 392
 Density of dyebath, 277
 — — solutions, 707
 Desiccated glauber salt, 186
 Developed dyes on silk-cotton goods, 566
 — colors, fastness of, 308
 — — on cotton, 308
 — —, properties of, 308, 329
 — dyes, list of, 333
 — —, shading of, 314
 — —, use of on silk, 316
 Developer A, 313
 — B, 313
 — C, 313
 — D, 314
 — E, 313

- Developer F, 313
 — G, 313
 — H, 313
 — J, 313
 Developers, list of, 311
 Developing process, 308
 Dextrin, testing for, 676
 Diamalt, use of on cotton 93
 Diamino-azobenzene hydrochloride, 314
 Dianisidine, 321
 — blue, 332
 — developer, 314
 Diastafor, use of on cotton, 93
 Diastase, use of on cotton, 93
 Diazo-paranitraniline, 318
 Diazotizing bath, preparing of, 310
 — process, 309
 Dichroic property of dye, 680
 Dioxy-naphthalene, 314
 Diphenyl black, 461
 Dissociation, theory of dyeing, 588
 Dissolving dyes, machinery for, 156
 — dyestuffs, 208
 Divi-divi, 265
 Double-acting gig, 605
 Double antimony fluoride, 266
 Double-cylinder gig, 611
 Double-jigger for sulphur colors, 396
 Doubling machine for warps, 226
 Dressgoods, fastness of colors for, 622
 Dréze-Michaelis dyeing machine, 189
 Drum machine for leather dyeing, 625
 Dryer for raw stock, 191
 Drying cans, horizontal, 357
 — dyed material, 34
 —, effect of on textiles, 60
 — machine for cones and tubes, 521
 — machines, 135
 Dye salt I, 313
 — — II, 313
 — — IV, 314
 — — V, 313
 — — VI, 313
 — — VII, 313
 — sticks, material used for, 211
 Dyebath, general preparation of, 180
 —, temperature of, 180
 Dyed material, after-treatment of, 34
 Dyeing machine for para red, 328
 — — — raw stock, 163, 164
 — —, open width, 288, 315, 343, 474
 Dyeing, mechanical apparatus for, 22
 — mixed fibers, 524
 —, practical processes of, 20
 —, relation of to chemistry, 2
 — two color effects on union goods, 541
 — union goods, 534
 — with mordant colors, 352
 Dyepots for experimental tests, 19
 Dyes for food products, 664
 — — silk cottongoods, 564
 — — typewriter ribbons, 663
 — — for union goods, 542
 — — wool-silk fibers, 556
 —, normal qualities of fastness for, 239
 — not affected by chrome, 374
 —, suitable for coloring soap, 660
 —, — — inks, 660, 662
 —, — — spirit lakes, 659
 — used in medicine, 665
 Dyestuff, definition of, 2
 — and pigment, difference between, 1
 — brands, method of labeling, 223
 — extracts, autoclave for preparing, 161
 — manufacturers in various countries, 230
 — tables of Schultz, 224
 Dyestuffs, action of metals on, 210
 —, — — on silk, 163
 — as indicators, 665
 — for leather, 627
 — — tinting bleached wool, 109
 — general properties of, 156
 —, identification of, 669
 —, manufacturers, names of, 230
 —, methods of classifying, 154
 —, — — dissolving, 209
 —, suitable for lakes, 657
 —, testing value of, 666
 — used by ancients, 8
 Dye-testing, equipment for, 16
 Dye-tests, method of making, 18, 180
 Dyevats for silk, 211
 Dye winch for cloth, 393
 Dynamite liquor, 54, 201
 Ecru silk, 97
 Effect of light on colors, 609
 Electrical condition of fibers, 61
 Electrolytic bleach liquors, 139
 — — —, method of preparing, 141
 — —, plant for, 140
 Electrolyzer cell for bleaching liquor, 139

- Emeraldine, 451
 Emulsion process of scouring wool, 72
 Eosin dyes, 156
 — —, use of on cotton, 206
 — lakes, 652
 Epsom salts in dyes, testing for, 676
 Erythrin, 499
 Esser raw stock machine, 172
 Ethyl-beta-naphthylamine, 313
 Evernic acid, 499
 Exhaustion of dyebath, 186, 278, 590, 678
 Expanding machine for cloth, 597
 Experimental dyebaths, 17
 Extract wool, 526
 — —, method of dyeing, 181
- F-acid, 313**
 Factors in theory of dyeing, 600
 Fancy yarns, dyeing of, 190
 — —, fastness of colors for, 621
 Fast blue developer AD, 311, 313
 — — — AN, 311
 Fastness of colors on cotton, testing of, 616
 — — dyes, 239, 607
 — — substantive dyes, 280
 — required on various materials, 243, 619
 — to acids, 614
 — — alkali, 615
 — — bleaching, 617
 — — carbonizing, 614
 — — chlorine, 617
 — — crocking, 612
 — — cross-dyeing, 617
 — — decatizing, 616
 — — fulling, 611
 — — hot pressing, 616
 — — ironing, 616
 — — laundering, 617
 — — light, 608
 — — lime, 615
 — — mercerizing, 617
 — — perspiration, 614
 — — potting, 616
 — — rubbing, 612
 — — steaming, 616
 — — stoving, 615
 — — street dust, 615
 — — sulphuring, 615
 — — washing, 610
 — — water, 613
 — — weather, 613
- Fat dyes, 664
 Feathers, bleaching of, 635
 —, dyeing of, 635
 Fermentation vat for indigo, 413, 417
 Fibroin, 95
 Filters for hard water, 101
 Finishing blue spirits, 523
 — machine for half-silk goods, 555
 Flannels, fastness of colors for, 622
 Flavine, 500
 Flowers of madder, 497
 Foam dyeing for sulphur colors, 398
 Food products, dyestuffs for, 664
 Formaldehyde, after-treatment with, 282
 Formic acid, use of in dyeing, 182
 Foulard machine, 359
 Franklin dyeing machine, 262
 French purple, 499
 Fricton calender, 563
 — mangle, 488
 Full shade, amount of dye necessary for, 678
 Fulling machines, 85
 —, process of, 86
 — washer for flannels, 592
 Fur dyeing, 632
 Furrol dyes, 633
 Fuscamine, 462
 Fustic, 492
 —, detecting of on fiber, 494
 — reactions of mordants with, 494
 — extract, reactions of, 492
 Fustin, 494
- Gallalith, dyeing of, 647
 Gallo-tannic acid, 264
 Gall-nut tannin, 265
 Gambier, 501
 Garanceux, 497
 Garancin, 497
 Genista, use of as dyestuff, 10
 Glaubersalt, effect of in dyeing, 185, 595
 Gloria, 524
 Grain colors, 509
 Gray sour in cotton bleaching, 121
 Group names of dyestuffs, 224
- Half-wool, dyeing of, 524
 Hard water, action of in bleaching, 217
 — —, — — dyeing, 216
 — —, — — on substantive dyes, 278

- Hard water, correction of, 100
 — —, definition of, 216
 — —, effect of in bleaching and dyeing, 104
 — —, meaning of, 100
 — —, methods of filtering, 101
 Hat braid, dyeing of, 638
 — material, 622
 Heat, action of on fibers, 61
 Heating dyevats, methods for, 28
 Hectograph inks, 660
 Helidone dyes, 437
 Hematine, 471
 — crystals, 474
 — extract, 474
 Hematoxylin, 471
 Hemp, dyeing of, 578
 — twine, dyeing of, 578
 History of dyeing, 7
 Horizontal cylinder drying machine, 512
 Horn buttons, dyeing of, 646
 Horsehair, dyeing of, 639
 Hosiery dyeing machine, 303
 — yarns, fastness of colors for, 621
 Hot water, effect of on fibers, 63
 Human hair, dyeing of, 639
 Humidity, effect of in manufacturing textiles, 59
 Hydrated cellulose, 36
 Hydraulic calender, 502
 — mangle, 486
 — press for finishing piece goods, 698
 Hydro-extracting dyed material, 33
 Hydro-extractor for cloth, 326
 Hydrogen peroxide, 110
 Hydron blue, 375, 444
 Hydrometry, 701
 Hydrosulphite ammonia vat, 428
 — liquor, preparation of, 427
 —, use of in stripping, 238
 — vat, 408, 413, 427
 Hygroscopic properties of fibers, 57

 Identification of dyes, 682
 Imitation seal-skin, dyeing of, 505
 Indanthrene dyes, 441
 Indican, 411
 Indicators, dyes used for, 665
 Indigo, 410
 —, action of, on fabrics, 413
 Indigo-brown, 410
 Indigo carmine, 413
 — derivatives, 436
 — dye vat, 421
 — dyeing, continuous methods of, 417
 — — on piece goods, 416
 — — range, 420
 — dyeings, after-treatment of, 415
 — extract, 431
 —, extracting from plant, 411
 Indigo-gluten, 410
 Indigo, methods of dyeing, 413
 — mill, 407
 — salt, 434
 — solution, 433
 —, syntheses of, 434
 —, testing of, on fiber, 435
 — vats, 433
 — —, comparison of, 429
 — —, dipping apparatus for, 429
 — white, 412, 433
 Indigoids, 405
 Indigotine, 410
 Indirubin, 410
 Indophenol, 433
 Indophor, 434
 Ingrain colors, 308, 509
 Ink powder, 661
 Inks, preparation of, 660
 Iron buff, 518
 — gray, 519
 — mordants, 349
 Iron-tannin mordant, 260
 Ivory, dyeing of, 647

 Japonic acid, 503
 Jigger dyeing machine, 303
 — — dyeing, 352
 — — for mordanting and dyeing, 354
 — — sample dyeing, 394
 — — sulphur colors, 394-5
 Jute, action of dyestuffs on, 156
 —, bleaching of, 575
 —, dyeing of, 575
 —, general methods of dyeing, 174

 Kermes, 8, 509
 Khaki brown, production of, 392
 Kier boiling in cotton bleaching, 118
 Kiers for boiling-out cotton, 90
 Klauder-Weldon raw stock machine, 164
 Klug raw stock machine, 175

- Knitgoods, bleaching of, 146
 —, drying machinery for, 149
 —, fastness of colors for, 622
 —, machinery for bleaching, 149
 Knitting yarns, fastness of colors for, 621
- Lac dye, 509
 Laccainic acid, 509
 Lactic acid, 345
 Lactoline, 345
 Lake colors, preparation of, 649
 Lakes, dyes for, 648
 Laws concerning dyestuffs, 12
 Leather dyeing of, 624
 —, preparation of for dyeing, 625
 Lecanoric acid, 499
 Leveling properties of dyes, 186
 Lighting of dyehouse, 30
 Lignorosin, 345
 Lime boil for cotton, 121
 Linen dyeing, 571
 —, general methods of dyeing, 174
 — yarn, boiling out of, 572
 Liquid chlorine, installation for bleaching with, 137
 — —, use of in cotton bleaching, 136
 Lists in dyed goods, 218
 — — piece-goods, 192
 Lithographic inks, 648
 — lakes, 654
 Logwood, 470
 — black, fastness of, 473
 — —, on loose cotton, 480
 — —, one bath process, 476
 — chips in dyeing, 471
 —, detection of on fiber, 482
 — dyeing on wool, 476
 — — — silk, 481
 — extract, 472
 — —, valuation of, 475
 —, methods of extracting, 473
 — on cotton 479
 —, reactions of, 482
 Loose cotton, bleaching of, 143
 — stock, dyeing of, 24
 — — machine for indigo dyeing, 415
 — wool, fastness of colors for, 619
 Ludigol, 406
 Lustering machine for wool, 498
 Luteolin, 508
- Maclurin, 492
 Madder, 496
 — in different mordants, 497
 — mangle, 535
 Magnesium chloride, use of in carbonizing, 191
 — sulphate, after-treatment with, 283
 Malachite green, method of dyeing on wool, 251
 Malting of cotton, 93
 Manganese brown, 520
 Mangle for cotton pieces, 478
 Marking inks, 662
 Maroon developer, 313
 Mechanical theory of dyeing, 583
 Medieval colors, dyestuffs used in, 14
 Melanogen dyes, 387
 Mercerized cotton, action of basic dyes on, 165
 — —, dyeing of, 278
 — —, test for, 690
 Mercerizing, boiling-out of cloth for, 51
 — by Schreiner process, 53
 —, description of operations in, 44
 — of cloth, 48
 — — cotton, 41
 —, skein method for, 42
 —, warp method for, 43
 Merino yarns, 525
 — —, fastness of colors for, 623
 Meta-chrome process, 352
 Metallic mordants, 168
 — salts, action of on fibers, 53
 Metals, action of on dye solutions, 210
 Meta-nitraniline, 321, 332
 Meta-phenylene-diamine base, 313
 Meta-phenylene-diamine hydrochloride, 313
 Meta-phenylene-diamine, method of using, 330
 Meta-toluylene-diamine base, 313
 Methods of mordanting, 349
 Microscopic stains, dyes for, 665
 Micuit silk, 96
 Milling and fulling, 86
 Mimosannic acid, 502
 Mineral dyes, 155, 513
 — khaki on cotton, 515
 Mixed dyes, detection of, 668
 — fibers in fabrics, estimation of, 688
 Mixes, dyeing of, 189

- Moistening machine for finishing cottons, 670
- Moisture in textile fibers, effect of, 57
- Money value of dye samples, 666
- Mono-chrome process, 352
- — of dyeing, 356
- Mono-genetic dyes, 340
- Mono-sulphonic acid, 313
- Mordant assistants, 344
- colors, methods of stripping, 238
- dyes, 340
- —, classification of, 340
- —, general properties, 157
- —, list of principal, 373
- — suitable for after-mordanting, 373
- —, use of on silk, 164
- —, — — on wool, 162
- Mordanting, chemistry of, 166
- dyes, use of on silk, 365
- of wool, 341
- process, chemistry, of 343
- —, theory of, 601
- salts, chemical action of, 342
- with alum, 347
- — chrome, 344
- — chrome, theory of, 603
- Mordants, action of on fibers, 166
- , classification of, 168
- dyes on various, 358
- elective affinity of for dyestuffs, 167
- , metallic salts useful for, 166
- for acid dyes on cotton, 205
- in fabrics, detection of, 694
- Morin, 492
- Moritanic, 492
- Mother-of-pearl, dyeing of, 647
- Mulle madder, 497
- Mungo, 526
- Myrobolans, 265
- Nanking cotton, 519
- Naphthol AS, 314, 322
- colors, 320
- —, apparatus for dyeing, 318
- —, fastness of, 322
- Naphthol D, 321
- LC, 325
- R, 313
- Naphthylamine black, method of dyeing, 206
- ether, 311
- Napping machine for knitgoods, 690
- Natural dyes, 470
- —, action of on cotton, 166
- flowers, dyeing of, 642
- Nerogenc D, 314, 330, 339
- Nettle fiber, 575
- Neutral dyes, 156
- Nigraniline, 451
- Nitrazol C, 319
- Nitro-ortho-toluidine, 321, 332
- Nitro-para-toluidine, 321
- Nitro-phenetidine, 321, 333
- Nitrosamine red, 319
- Nomenclature of dyestuffs, 222
- NW salt developer, 314
- Obermaier dyeing machine, 184
- Oil mordants, 169
- Oils, dyeing of, 663
- Old fustic, 495
- Olive drab color, production of, 392
- oil, after-treatment with, 283
- One-bath mordanting process, 358
- Orange developer, 313
- Orcein, 499
- Orchil, 499
- Organic acids, action of on cotton, 37
- Ortamine-brown, 462
- Ortho-amino-azo-toluene, 321
- Osage orange, 495
- Overalls, dyeing of, 392
- Overhead folder for piece goods, 492
- Oxford mixes, 533
- Oxidizing agents, action of on fibers, 54
- machine for aniline black, 466
- — for hosiery, 460
- mordant for logwood, 477
- Ozonite bleaching compound, 152
- Oxycellulose, 131
- Padding dyeing machine, 305
- jigger for sulphur colors, 396
- machine, 323
- jigger for sulphur colors, 396
- machine, 323
- — for sulphur colors, 397
- — with hot flue, 367
- , steaming and washing machine, 362
- Painting, distinction of from dyeing, 1
- Paper, dyeing of, 630
- pulp, different kinds of, 630

- Paper pulp, dyeing of, 631
 — staining, 632
 Paramine-brown, 462
 Paranitrailine, 318
 — brown, 331
 —, process of diazotizing, 327
 — red, 322, 500
 — S, 319
 Para red, action of copper on, 324
 — lakes, 656
 — soap PN, 319
 Para-toluidine, 321
 Paste dyes, storage of, 208
 Pastel colors, 514
 Patent bark, 500
 — salt, 266
 Pectin matters in cotton, 89
 Perborin bleaching compounds, 152
 Perfumes, dyeing of, 663
 Permanganate bleach for wool, 112
 Permutit process for softening water, 102
 Peroxide bleach on wool, properties, 112
 — bleaching baths, preparation of, 111
 Persian berries, 508
 —, with various mordants, 508
 Persil bleaching compound, 152
 Persis, 500
 Phenol, 311
 — developers, 309
 Phenylene-diamine, 311
 Phthalein dyes, 156
 Picking and shearing machine on silk goods, 577
 Picture films, dyeing of, 645
 Piece dyeing kettle, 284
 Pigment dyes, 169
 Plush goods, dyeing of, 564
 Polishing and Sanding machine for worsteds, 580
 Poly-genetic dyes, 340
 Polyzime, use of on cotton, 93
 Poplin, dyeing of, 554
 Potting blacks, 356
 — process for woolens, 66
 Practical dyeing, operations in, 26
 Printing inks, 648
 —, relation of to dyeing, 2
 Prussian blue, 522
 Psarski raw stock machine, 178
 Pure dye black on silk, 482
 Purple indigo extract, 431
 Purpurin, 496
 Putting-out machine for leather dyeing, 626
 Pyrolignite of iron, after-treatment with, 283

 Quercetin, 500
 Quercitron, 500

 R salt developer, 314
 Rain water, use of in dyeing, 215
 Ramie, dyeing of, 575
 —, general methods of dyeing, 174
 Rapid fast dyes, 322
 Reaction of dyes with alum, 684
 — — — — ammonia, 683
 — — — — bleaching powder, 684
 — — — — chrome, 684
 — — — — ferric chloride, 684
 — — — — hydrochloric acid, 683
 — — — — nitric acid, 683
 — — — — soda ash, 684
 — — — — sodium-hydrate, 683
 — — — — stannous chloride, 684
 — — — — sulphuric acid, 682
 — — — — tannin reagent, 684
 — — — — zinc test, 685
 Recovered wool, 526
 Red developer, 313
 Redmonol, dyeing of, 647
 Reel dyeing machine, 300, 472
 Regain in conditioning, 59
 Resin soap for cotton bleaching, 122
 Resist dyeing, 40
 — — for cotton goods, 276
 Resorcine, 311
 Revolving tenter machine, 601
 Rhea fiber, 575
 Rhodamine, method of dyeing on wool, 251
 Rhodes dyeing machine, 183
 River water, use of in dyeing, 216
 Rolling machine for cotton pieces, 480
 — — — piece goods, 515
 Rosaniline lakes, 653
 Rosin soap, 653
 Rotary pressing machine, 483
 Royal blue spirits, 523
 Rubinic acid, 503
 Rug dyeing, 634
 — yarns, fastness of colors for, 621

- Saddening dyed colors, 35
 Safflower, 8
 Salt in dyes, testing for, 673
 Saxon vat for indigo, 417
 Saxony blue, 431
 Schappe silk, scouring of, 100
 Schreiner process of mercerizing, 53
 Scouring machines for silk, 98
 Scrooping silk, 35, 38, 219
 Sericin, 94
 Sewing cotton, fastness of colors for, 622
 Shading salt, 313
 Shearing machine, 629
 — — for woolen goods, 655
 Shrinkage of wool on scouring, 71
 Shrinking machine for cloth, 529
 Shoddy, 526
 —, fastness of colors for, 619
 — goods, stripping of, 527
 Short bath in dyeing, 276
 Silicate of soda in cotton bleaching, 122
 Silk, action of acids on, 38
 —, — — alkalies on, 41
 —, — — chlorine compounds on, 56
 —, — — metallic salts on, 54
 —, — — peroxides on, 56
 —, — — potassium permanganate on, 56
 —, — — tannic acid on, 39
 —, — — weighting agents on, 38
 —, bleaching of souple, 99
 —, boiling-off of, 96
 —, dyeing mordant colors on, 164
 —, — of with acid colors, 197
 —, — substantive colors on, 164
 —, effect of heat on, 62
 —, general methods of dyeing, 171
 —, impurities in raw, 94
 —, scouring of souple, 99
 —, test for weighing, 690
 —, use of basic dyes on, 249
 —, — — vat colors on, 164
 —, weighting of, 200
 — and artificial silk, distinction between,
 — — cotton, estimation of, 687
 — — tussah silk, distinction between, 689
 — cotton goods, aniline black on, 564
 — — —, dyeing of, 560
 — dyes, increasing fastness of, 251
 — finishing machine, 541
 Silk-glue, 94
 Silk noils, dyeing of, 365
 Silk scouring, proper soaps for, 97
 — yarns, apparatus for dyeing, 214
 Silver cochineal, 505
 Singeing machines, 123
 — — for cotton, 121
 — —, gas, 571
 Single-bath mordanting, 351
 Size for dyeing, 285
 Sized cotton goods, effect of heat on, 62
 Sizing machine for silk, 547
 — — — skein yarn, 685
 — materials, test for, 691
 Skein dyeing machine, 206, 241
 — — — for indigo, 412
 — — — — silk, 215
 — — —, revolving type, 211
 Skins, dyeing of, 634
 Silver bleaching machine, 201
 — dyeing machine, 192, 204
 Slubbing and printing machine, 194
 — dyeing machine, 442
 —, — — for, 198
 —, — of, 190
 —, fastness of colors for, 620
 Soap, action of hard water on, 217
 — mordant for cotton, 261
 Soaping machines, 132
 Soaps, characteristics of, 87
 — for scouring silk, 97
 — — — wool, 87
 Soda vat for indigo, 421
 Sodium acetate in dyeing, 326
 — bichromate, 344
 — hydrosulphite, 414
 — hypochlorite, preparation of, 135
 — —, — — by electrolysis, 139
 — —, use of in cotton bleaching, 134
 Sodium perborate as a bleaching agent, 152
 — peroxide, 110
 — stannate, after-treatment with, 283
 — —, use of in dyeing cotton, 205
 — sulphite, in dyes, testing for, 676
 Soft water, definition of, 216
 Softening of cotton, 130
 Solid solution, theory of dyeing, 585
 Soluble alizarin dyes, 354
 — indigo, 431
 — oil in cotton dyeing, 278
 — oils, use of in boiling-out cotton, 92
 Solubility of dyes, 682
 Souple silk, 96

- Souring operation in bleaching, 128
 Speck dyeing, 188, 538
 Spirit colors, 155
 — lakes, 658
 Spirits soluble colors, 644
 Split straw, dyeing of, 637
 Splitting machine for warps, 233
 Spray dyeing, 2
 Spun silk, dyeing of with acid colors, 199
 — —, scouring of, 100
 Standards for light fastness, 609
 Standing bath, use of, 187
 — kettle, 187
 Stannic chloride, use of in weighting silk,
 201
 — —, — — — dyeing cotton, 205
 — —, — — — with acid dyes, 183
 Starch in dyes, testing for, 676
 Steam black with aniline, 459
 — finishing machine, 693
 — in dyeing, 29
 Steamer for mordanted cotton, 363
 — — sulphur colors, 379
 Steaming cottage for yarns, 468
 Stencil dyeing, 5
 Stock dyed colors, characteristics of, 189
 — dyeing, comparison of with skein dye-
 ing, 31
 Storage of dyestuffs, 207
 Stoving of wool, 108
 Straw, bleaching of, 636
 —, dyeing of, 636
 Stripping of dyed colors, 237
 — — silk, 96
 — shoddy, methods of, 237
 Substantive colors, methods of stripping,
 238
 — dyes, action of on cotton, 165
 — —, after-treatment of, 281
 — —, bleeding of, 276
 — —, classes of, 275
 — —, list of principal, 290
 — —, methods of application, 281
 — —, preparing dyebath for, 276
 — —, solution of, 275
 — —, topped with basic dyes, 278-284
 — —, use of, for silk, 164
 — —, — —, on wool, 160
 — — on cotton, use of, 276
 — — — jute, 577
 — — — silk, 300
- Substantive colors on silk, list of, 306
 — — — wool, 298
 — — — —, list of, 306
 — dyestuffs, 275
 Sudan dyes, 664
 Sugar in dyes, testing for, 676
 Suint in wool, 71
 Sulphur black, correction of bronzi-
 ness,
 380
 — — dyeing of, 378
 — — notes on dyeing, 382
 — — standing baths of, 382
 — bleach, defects in, 109
 — colors, after-treatment of, 380
 — —, apparatus for dyeing, 393
 — —, continuous dyeing of, 400
 — —, dyeing of in vat, 385
 — —, — on foulard, 399
 — —, fastness of, 389
 — —, foam dyeing of, 400
 — —, machine for dyeing, 384
 — —, method for dyeing, 384
 — —, methods of stripping, 238
 — —, softening of, 386
 — —, steaming of, 384
 — —, topping of, 388
 — —, in dyeing linen, 574
 — dyes, action of on cotton, 165
 — —, after-treatment of, 386
 — —, characteristics of, 375
 — —, dissolving of, 376
 — —, exhaustion of, 381
 — —, history of, 375
 — —, list of principal, 401
 — —, method of dyeing, 377
 — — on jute, 577
 — —, tendering of cloth by, 379
 Sulphuric acid, use of in dyeing, 184
 Sumac tannin, 264
 Sweet indigo extract, 431
 Synthetic indigo, 431
- Tabulation of fastness test, 619
 Tannate of tin, 276
 Tannic acid, 264
 — —, action of on fibers, 39
 Tannin, methods of mordanting cotton
 with, 257
 — mordant, application of, 255
 — mordants, 169
 Tanning leather, different methods of, 624

- Tannins, 263**
 Tapestry yarns, fastness of colors for, 621
 Tartar emetic, 265
 — —, use of in fixing tannin mordant, 260
 — substitute, 347
 Teasel gig, 643
 Temperature of dyebath, 279
 Tenter, with automatic clip, 518
 Tentering and drying machine, 371
 — machines, 133, 506
 Test skeins, preparation of, 18
 Testing of dyestuffs, 666
 Tests employed in dyeing, 678
 Textile fibers, action of acids on, 36
 Textiles, forms of dyeing, 31
 Theory of dyeing, 582
 — — — compound shades, 598
 — — — mixed fibers, 599
 — — — pigment colors, 596
 Thermometry, 706
 Thiazine dyes, 247
 Thiazol dyes, 247
 Thio indigo Red, 375
 Tie-dyeing style, 4
 Tinting of bleached cotton, 130
 — — — wool, 109
 Tints, dyeing of on cotton, 280
 Tin-weighted silk, dyeing of, 250
 Tin mordants, 349
 Tissue paper, dyeing of, 632
 Titanous chloride, 238
 Tolidine, 321
 Toluylene-diamine, 314
 Tom-tom machine, 459
 Top-chrome method of dyeing, 354
 Tops, dyeing of, 190
 —, fastness of colors for, 620
 —, scouring of, 80
 Tri-phenylemethane dyes, 247
 Turkey red, dyeing of, 365
 — — oil mordant, 262
 Turmeric, 508
 Tussah silk, dyeing of with acid colors,
 198
 — —, scouring of, 100
 Typewriting inks, 663
 Tyrian purple, 8, 439

 Ultra-violet lamp, 608
 Umbrella cloth, 553
 Union dyes, 300
 Union goods, action of dyes on, 531
 — —, bleaching of, 530
 — —, dyeing of, 300, 524
 — —, fastness of colors for, 623
 — —, method of dyeing, 183
 — —, properties of, 530
 Unshrinkable wool, 55

 Vacanceine red, 320
 Vanadium, in dyeing aniline black, 452
 Vapors in dyehouse, removal of, 29
 Vat dyes, action of on cotton, 165
 — —, classes of, 405
 — —, effect of kier boiling of, 406
 — —, method of application, 443
 — —, — — dyeing, 408
 — —, use of on silk, 164
 — —, — — — wool, 162
 — for dyeing sulphur colors, 376
 Vats for dyeing yarn, 21
 Vegetable dyes, 155
 — ivory, 645
 Velvets, fastness of colors for, 622
 Vigoureux system of printing slubbing,
 194
 Viscolline yarn, 579
 Viscose silk, 578

 Wall paper lakes, 648, 650
 Warp dyed union goods, 532
 — dyeing machine, 218, 223, 235, 242,
 248, 249, 253, 387, 388, 390
 — — — for aniline black, 463
 — yarn, sizing of, 85
 Washing machine for hosiery, 147
 — — — yarn, 336
 — —, open width, 315, 341
 — machinery in cotton bleaching, 129
 — machines, 132
 Water, amount required in dyeing, 27
 —, effect of iron in, 101
 —, treatment of, for bleaching and dyeing,
 102
 —, in dyeing, 26
 —, influence of in dyeing, 215
 —, permanent hardness in, 100
 —, relation of to wool scouring, 100
 —, softening with zeolites, 103
 —, temporary hardness in, 100
 Waxes, dyeing of, 663
 Weaving yarns, fastness of colors for, 620

- Weight of cotton, increase of in dyeing, 282
 Weighted silk, dyeing of, 250
 — —, effect of heat on, 62
 Weighting of cotton goods, 283
 — silk, 200
 Weld, 507
 Woad, 410
 — vat for indigo, 418
 Woaded black, 476
 — chip, dyeing, 638
 Wood chip, dyeing, 638
 —, dyeing of, 643
 Wool, action of acid on, 36
 —, — — alkalis on, 40
 —, — — chlorine on, 55
 —, — — hot water on, 63
 —, — — metallic salts on, 54
 —, — — oxidizing agents on, 56
 —, — — peroxides on, 56
 —, — — potassium permanganate on, 56
 —, — — steam on, 63
 —, — — tannic acid on, 40
 —, bleaching of, 107
 —, carbonizing of, 74
 —, effect of heat on, 62
 —, general methods of dyeing, 170
 —, impurities in raw, 71
 —, relation of various dyes to, 160
 — and cotton, estimation of, 687
 — — silk, estimation of, 688
 — — — dyeing, properties of, 160
 Wool-cotton fabrics, 524
 Wool dyeing, in loose stock, 188
 — —, proper temperature for, 160
 Wool-fat, 71
 Wool fiber under microscope, 528
 — oils, composition of, 77
 — plush, dyeing of, 547
 — scouring, chemicals employed in, 72
 — —, effect of water in, 100
 Wool scouring, effect of temperature on, 72
 — —, machinery for, 73
 — —, use of alkali in, 74
 — —, with soaps, 72
 Wool-silk goods, dyeing of, 553
 Woolen cloth, methods of scouring, 82
 — —, fastness of colors for, 621
 — —, scouring machines for, 81
 — —, washing machines for, 80
 — piece-goods, carbonizing of, 191
 — —, dyeing of, 191
 — shearing machine, 688
 — yarn, apparatus for dyeing, 213
 — —, containing iron, scouring of, 80
 — —, dyeing of, 190
 — —, impurities in, 75
 — —, machines for scouring, 77
 — —, oil in, 76
 — —, scouring of, 75
 Worsted yarns, dyeing of, 190
 — —, scouring of, 77
 Wringer for preparing yarn, 320
 Xanthin, 496
 Xanthorhammin, 508
 Yarn dyeing machine, 257
 — —, vats for, 21
 — dryer, 360
 — drying machine, 457
 — impregnating machine, 457
 — mordanting machine, 348, 350
 — reel for test skeins, 19
 — squeezer, 377
 — wringing machine, 468
 Yellow developer, 313
 Young fustic, 495
 Zinc-bisulphite vat, 430
 Zinc vat for indigo, 413, 426

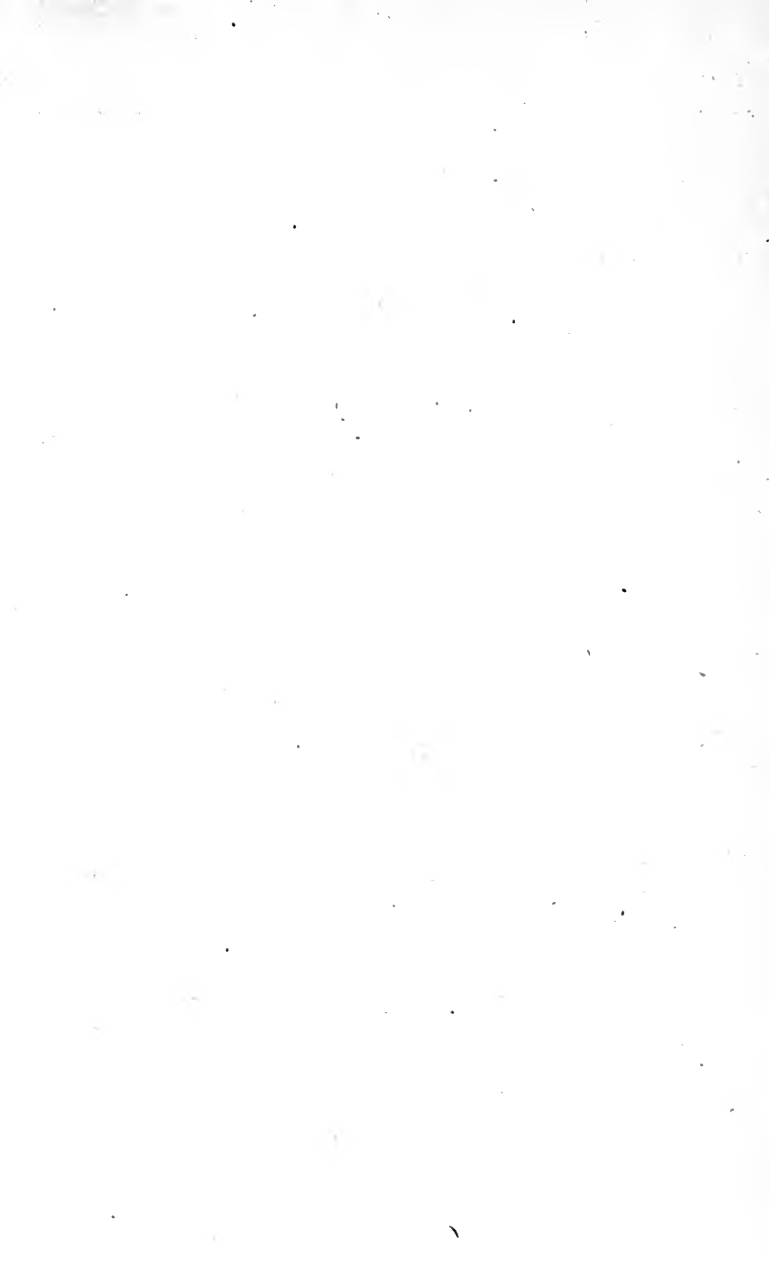

22174

UC SOUTHERN REGIONAL LIBRARY FACILITY



A 000 711 701 3

